

FCC PART 15C TEST REPORT FOR CERTIFICATION
On Behalf of

Guoguang Electric Co.,Ltd

Portable Wireless Speaker

Model Number: VIFA110

FCC ID: 2AAP8-VIFANORDIC4



Prepared for:	Guoguang Electric Co.,Ltd
	No.8 Jinghu Road, Xinhua Street, Huadu Reg, Guangzhou, China
Prepared By:	EST Technology Co., Ltd.
	Chilingxiang, Qishantou, Santun, Houjie, Dongguan, Guangdong, China
	Tel: 86-769-83081888-808

Report Number:	ESTE-R1906003
Date of Test:	Apr. 22~Jun. 02, 2019
Date of Report:	Jun. 05, 2019

TABLE OF CONTENTS

Description	Page
TEST REPORT VERIFICATION.....	3
1. GENERAL INFORMATION.....	4
1.1. Description of Device (EUT).....	4
2. SUMMARY OF TEST.....	5
2.1. Summary of test result.....	5
2.2. Test Facilities.....	6
2.3. Measurement uncertainty.....	7
2.4. Assistant equipment used for test.....	7
2.5. Block Diagram.....	7
2.6. Test mode.....	8
2.7. Channel List.....	8
2.8. Test Equipment.....	9
3. CONDUCTED EMISSIONS.....	10
3.1. Limit.....	10
3.2. Test Setup.....	10
3.3. Spectrum Analyzer Setting.....	10
3.4. Test Procedure.....	10
3.5. Test Result.....	11
4. RADIATED EMISSION.....	15
4.1. Limit.....	15
4.2. Test Setup.....	16
4.3. Spectrum Analyzer Setting.....	17
4.4. Test Procedure.....	17
4.5. Test Result.....	18
5. FREQUENCY TOLERANCE.....	25
5.1. Limit.....	25
5.2. Test Setup.....	25
5.3. Test Procedure.....	25
5.4. Test Result.....	26
6. 20DB BANDWIDTH.....	27
6.1. Limit.....	27
6.2. Test Setup.....	27
6.3. Spectrum Analyzer Setting.....	27
6.4. Test Procedure.....	27
6.5. Test Result.....	28
7. ANTENNA REQUIREMENTS.....	29
7.1. Limit.....	29
7.2. Test Result.....	29
8. TEST SETUP PHOTO.....	30
9. EUT PHOTO.....	32

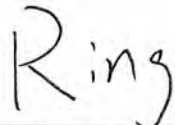
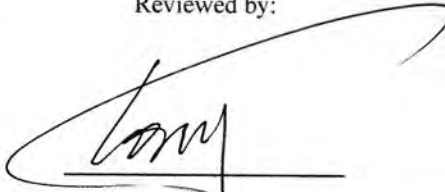
EST Technology Co., Ltd.

Applicant:	Guoguang Electric Co.,Ltd		
Address:	No.8 Jinghu Road, Xinhua Street, Huadu Reg, Guangzhou, China		
Manufacturer:	Vifa Denmark A/S		
Address:	Mariendalsvej 2A, 8800 Viborg, Denmark		
E.U.T:	Portable Wireless Speaker		
Model Number:	VIFA110		
Power Supply:	DC 5V From Adapter Input AC 100-240V, 50/60Hz DC 3.7V From Battery		
Trade Name:	Vifa	Serial No.:	-----
Date of Receipt:	Apr. 22, 2019	Date of Test:	Apr. 22~Jun. 02, 2019
Test Specification:	FCC Part 15 Subpart C (15.225) ANSI C63.10:2013		
Test Result:	<p>The device described above is tested by EST Technology Co., Ltd. The measurement results were contained in this test report and EST Technology Co., Ltd. was assumed full responsibility for the accuracy and completeness of these measurements. Also, this report shows that the EUT to be technically compliance with the FCC Rules and Regulations Part 15 Subpart C requirements.</p> <p style="text-align: center;">This report applies to above tested sample only and shall not be reproduced in part without written approval of EST Technology Co., Ltd.</p>		
		Date: Jun. 05, 2019	
Prepared by:	Reviewed by:	Approved by:	
 _____ Ring / Assistant	 _____ Tony / Engineer	 _____ Ice-man Hu / Manager	
Other Aspects:	None.		
Abbreviations: OK/P=passed fail/F=failed n.a/N=not applicable E.U.T=equipment under tested			
This test report is based on a single evaluation of one sample of above mentioned products ,It is not permitted to be duplicated in extracts without written approval of EST Technology Co., Ltd.			

1. GENERAL INFORMATION

1.1. Description of Device (EUT)

Product Name	:	Portable Wireless Speaker
Model Number	:	VIFA110
Software Version	:	V3.0
Hardware Version	:	DV2
Operation frequency	:	13.56MHz
Number of channel	:	1
Modulation Type	:	ASK
Sample Type	:	Prototype production

Note:

1. The antenna information for EUT.

Ant No.	Brand	Model Name	Antenna Type	Connector	Gain (dBi)
1	N/A	N/A	PCB	N/A	0

2. For a more detailed features description, please refer to the manufacturer's specifications or the user's manual.

2. SUMMARY OF TEST

2.1. Summary of test result

Report Section	Description of Test Item	FCC Standard Section	Results
3	Conducted Emissions	15.207	PASS
4	Radiated Emission	15.225(a)(b)(c)(d)	PASS
5	Frequency Tolerance	15.225(e)	PASS
6	20dB Bandwidth	15.215	PASS
7	Antenna Requirement	15.203	PASS

Note:

(1) "N/A" denotes test is not applicable in this test report

2.2. Test Facilities

- EMC Lab : Certificated by CNAS, CHINA
Registration No.: L5288
Date of registration: November 13, 2017
- Certificated by FCC, USA
Designation Number: CN1215
Test Firm Registration Number: 722932
Date of registration: November 21, 2017
- Certificated by A2LA, USA
Registration No.: 4366.01
Date of registration: November 07, 2017
- Certificated by Industry Canada
CAB identifier No.: CN0035
Date of registration: January 04, 2019
- Certificated by VCCI, Japan
Registration No.: R-13663; C-14103
Date of registration: July 25, 2017
This Certificate is valid until: July 24, 2020
- Certificated by TUV Rheinland, Germany
Registration No.: UA 50413872 0001
Date of registration: July 31, 2018
- Certificated by TUV/PS, Shenzhen
Registration No.: SCN1017
Date of registration: January 27, 2011
- Certificated by Intertek ETL SEMKO
Registration No.: 2011-RTL-L2-64
Date of registration: April 28, 2011
- Certificated by Nemko, Hong Kong
Registration No.: 175193
Date of registration: May 4, 2011
- Name of Firm : EST Technology Co., Ltd.
- Site Location : Chilingxiang, Qishantou, Santun, Houjie, Dongguan, Guangdong, China

2.3. Measurement uncertainty

Test Item	Uncertainty
Uncertainty for Conduction emission test	±3.48dB
Uncertainty for spurious emissions test (30MHz-1GHz)	±4.60 dB(Polarize: H)
	±4.68 dB(Polarize: V)
Uncertainty for spurious emissions test (1GHz to 18GHz)	±4.96dB
Uncertainty for radio frequency	7×10^{-8}
Uncertainty for conducted RF Power	0.20dB
Uncertainty for Power density test	0.26dB

Note: This uncertainty represents an expanded uncertainty expressed at approximately the 95% confidence level using a coverage factor of k=2.

2.4. Assistant equipment used for test

Item	Equipment	Brand	Model Name/Type No.	FCC ID	Series No.
-	Adapter	-	A1443	-	-

Item	Shielded Type	Ferrite Core	Length	Note
1	NO	NO	1.2m	DC Cable

2.5. Block Diagram

For radiated emissions test: EUT was placed on a turn table, which is 0.8 meter high above ground. EUT was beset into NFC test mode by software before test.

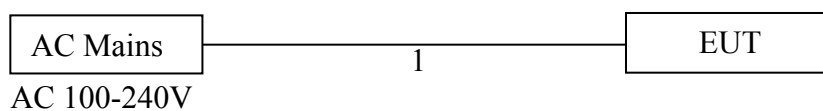

(EUT: Portable Wireless Speaker)

2.6. Test mode

Combining all the rates, modulations, and packet types, the Pre-scans had been carried out. The worst case test mode was selected for the final test as listed below.

Test Item	Modulation Type	Operating Mode
Conducted Emission	ASK	TX Mode
Radiated Emission	ASK	TX Mode
Frequency Tolerance	ASK	TX Mode
20dB Bandwidth	ASK	TX Mode

Note:

1. In radiated measurement, the EUT had been pre-scan on the positioned of each 3 axis(X, Y, Z), the worst case was found when positioned on **Y-plane**.

2.7. Channel List

Channel No.	Frequency (MHz)
1	13.56

2.8. Test Equipment

2.8.1. For conducted emission test

Equipment	Manufacturer	Model No.	Serial No.	Calibration Body	Last Cal.	Next Cal.
EMI Test Receiver	Rohde & Schwarz	ESHS30	832354	CEPREI	June 15,18	1 Year
Artificial Mains Network	Rohde & Schwarz	ENV216	101260	CEPREI	June 15,18	1 Year
Pulse Limiter	Rohde & Schwarz	ESH3-Z2	101100	CEPREI	June 15,18	1 Year
Test Software	Audix	e3-6.111221a	N/A	N/A	N/A	N/A

2.8.2. For radiated emission test(9 kHz-30MHz)

Equipment	Manufacturer	Model No.	Serial No.	Calibration Body	Last Cal.	Next Cal.
EMI Test Receiver	Rohde & Schwarz	ESR7	101780	CEPREI	June 15,18	1 Year
Active Loop Antenna	SCHWABE ECK	FMZB 1519B	1519B-088	N/A	Aug. 01,18	1 Year
Test Software	Audix	e3-6.111221a	N/A	N/A	N/A	N/A

2.8.3. For radiated emissions test (30-1000MHz)

Equipment	Manufacturer	Model No.	Serial No.	Calibration Body	Last Cal.	Next Cal.
EMI Test Receiver	Rohde & Schwarz	ESR7	101780	CEPREI	June 15,18	1 Year
Bilog Antenna	Teseq	CBL 6111D	27090	CEPREI	June 15,18	1 Year
Test Software	Audix	e3-6.111221a	N/A	N/A	N/A	N/A

2.8.4. For connect EUT antenna terminal test

Equipment	Manufacturer	Model No.	Serial No.	Calibration Body	Last Cal.	Next Cal.
Spectrum Analyzer	Rohde & Schwarz	FSV	103173	CEPREI	June 15,18	1 Year
Temperature controller	DK	DK70A	006562	Tiansu	June 15,18	1 Year
DC Source	ZHAOXIN	RXN-305D	EST002-001	Tiansu	June 15, 18	2018

3. CONDUCTED EMISSIONS

3.1. Limit

Frequency	Maximum RF Line Voltage	
	Quasi-Peak Level dB(μV)	Average Level dB(μV)
150kHz ~ 500kHz	66 ~ 56*	56 ~ 46*
500kHz ~ 5MHz	56	46
5MHz ~ 30MHz	60	50

Note:

1. * Decreasing linearly with logarithm of frequency.
2. The lower limit shall apply at the transition frequencies.

3.2. Test Setup

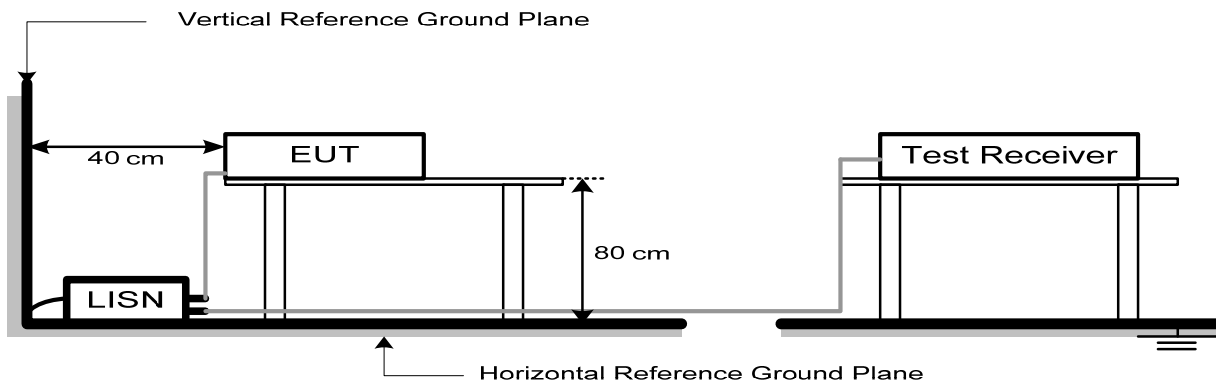

3.3. Spectrum Analyzer Setting

Spectrum Parameters	Setting
RBW	9KHz
VBW	9KHz
Start frequency	150KHz
Stop frequency	30MHz
Sweep Time	Auto
Detector	QP/AVG
Trace Mode	Max Hold

3.4. Test Procedure

- a. The EUT was placed on a non-metallic table, 80cm above the ground plane.
- b. The EUT Power connected to the power mains through a line impedance stabilization network.
- c. This provides a 50 ohm coupling impedance for the EUT (Please refer the block diagram of the test setup and photographs).
- d. Set the EUT transmit continuously with maximum output power.
- e. Spectrum analyzer setting parameters in accordance with section 11.3.
- f. The AC line are checked to find out the maximum conducted emission. In order to find the maximum emission levels, the relative positions of equipment and all of the interface cables shall be changed according to ANSI C63.10: 2013 on Conducted Emission Test.
- g. Record the results in the test report.

3.5. Test Result

EST Technology

Chilingxiang, Qishantou, Santun,
Houjie, Dongguan, Guangdong, China
Tel: +86-769-83081888
Fax: +86-769-83081878

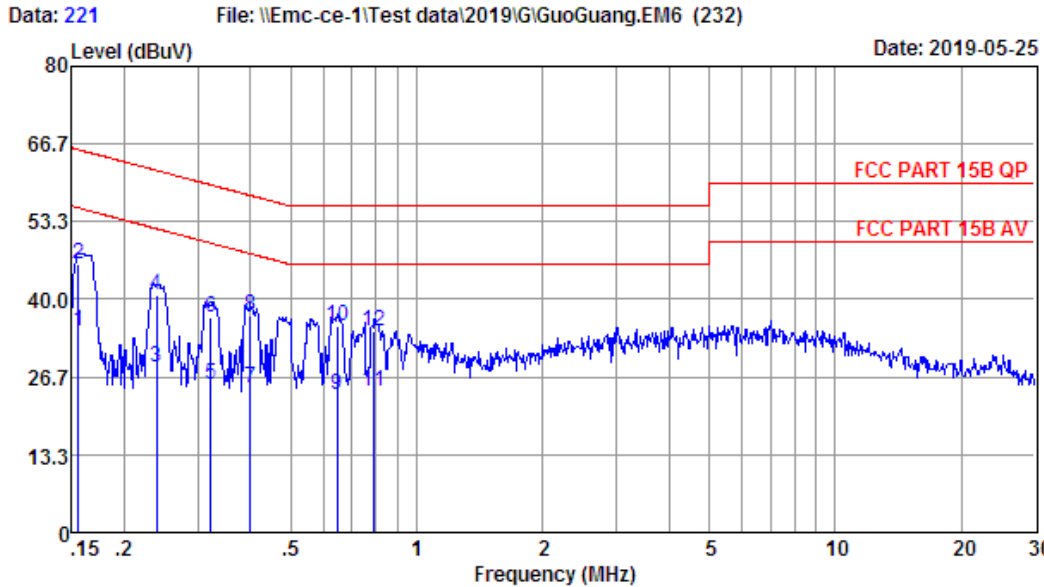

Site no : 844 Shield Room Data no. : 221
 Env. / Ins. : Temp:24.1'C Humi:52% Press:101.50kPa LINE Phase : LINE
 Limit : FCC PART 15B QP
 Engineer : Viking
 EUT : Portable Wireless Speaker
 Power : DC 5V From Adapter Input AC 120V/60Hz
 M/N : VIFA110
 Test Mode : TX Mode

	Freq. (MHz)	LISN Factor (dB)	Cable Loss (dB)	Reading (dBuV)	Emission Level (dBuV)	Limits (dBuV)	Margin (dB)	Remark
1	0.16	9.59	9.69	15.20	34.48	55.69	21.21	Average
2	0.16	9.59	9.69	26.69	45.97	65.69	19.72	QP
3	0.24	9.61	9.92	8.90	28.43	52.13	23.70	Average
4	0.24	9.61	9.92	21.12	40.65	62.13	21.48	QP
5	0.32	9.62	9.92	5.93	25.47	49.66	24.19	Average
6	0.32	9.62	9.92	17.39	36.93	59.66	22.73	QP
7	0.40	9.63	9.92	5.13	24.68	47.86	23.18	Average
8	0.40	9.63	9.92	17.73	37.28	57.86	20.58	QP
9	0.64	9.63	9.92	3.95	23.50	46.00	22.50	Average
10	0.64	9.63	9.92	16.02	35.57	56.00	20.43	QP
11	0.79	9.63	9.93	4.64	24.20	46.00	21.80	Average
12	0.79	9.63	9.93	14.91	34.47	56.00	21.53	QP

Remarks: 1. Emission Level= LISN Factor + Cable Loss + Reading.
 2. Margin= Limit - Emission Level.
 3. If the average limit is met when using a quasi-peak detector,
 the EUT shall be deemed to meet both limits and measurement
 with average detector is unnecessary.

Data: 223 File: \\Emc-ce-1\Test data\2019\G\GuoGuang.EM6 (232) Date: 2019-05-25

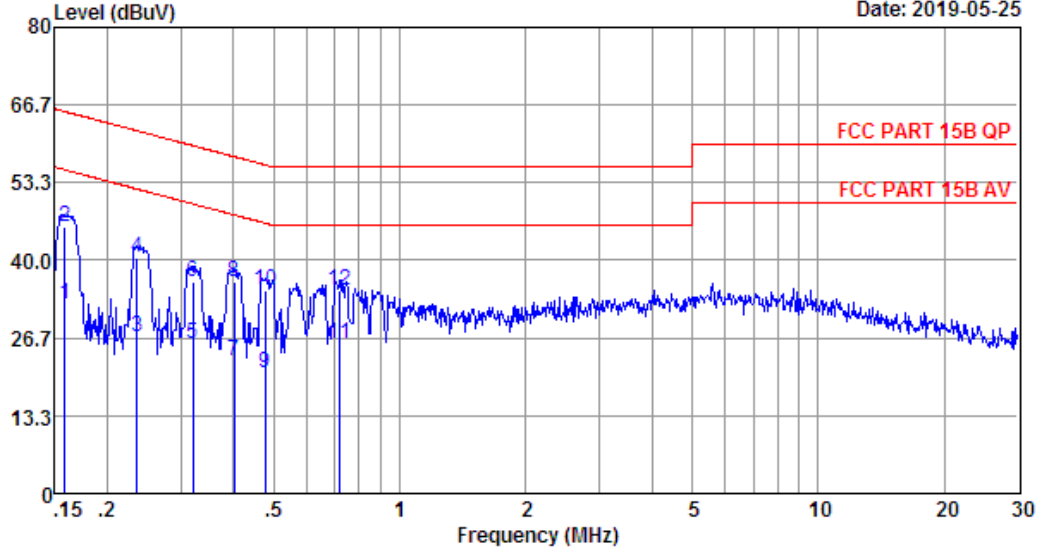

Site no : 844 Shield Room Data no. : 223
 Env. / Ins. : Temp:24.1'C Humi:52% Press:101.50kPa LINE Phase : NEUTRAL
 Limit : FCC PART 15B QP
 Engineer : Viking
 EUT : Portable Wireless Speaker
 Power : DC 5V From Adapter Input AC 120V/60Hz
 M/N : VIFA110
 Test Mode : TX Mode

	Freq. (MHz)	LISN Factor (dB)	Cable Loss (dB)	Reading (dBuV)	Emission Level (dBuV)	Limits (dBuV)	Margin (dB)	Remark
1	0.16	9.50	9.69	13.20	32.39	55.56	23.17	Average
2	0.16	9.50	9.69	26.52	45.71	65.56	19.85	QP
3	0.24	9.53	9.92	7.41	26.86	52.26	25.40	Average
4	0.24	9.53	9.92	21.12	40.57	62.26	21.69	QP
5	0.32	9.54	9.92	6.30	25.76	49.71	23.95	Average
6	0.32	9.54	9.92	16.71	36.17	59.71	23.54	QP
7	0.40	9.56	9.92	3.33	22.81	47.81	25.00	Average
8	0.40	9.56	9.92	16.82	36.30	57.81	21.51	QP
9	0.48	9.55	9.92	1.07	20.54	46.41	25.87	Average
10	0.48	9.55	9.92	15.23	34.70	56.41	21.71	QP
11	0.72	9.56	9.93	6.07	25.56	46.00	20.44	Average
12	0.72	9.56	9.93	15.22	34.71	56.00	21.29	QP

Remarks: 1. Emission Level= LISN Factor + Cable Loss + Reading.
 2. Margin= Limit - Emission Level.
 3. If the average limit is met when using a quasi-peak detector,
 the EUT shall be deemed to meet both limits and measurement
 with average detector is unnecessary.

Data: 229 File: \\Emc-ce-1\Test data\2019\G\GuoGuang.EM6 (232) Date: 2019-05-25

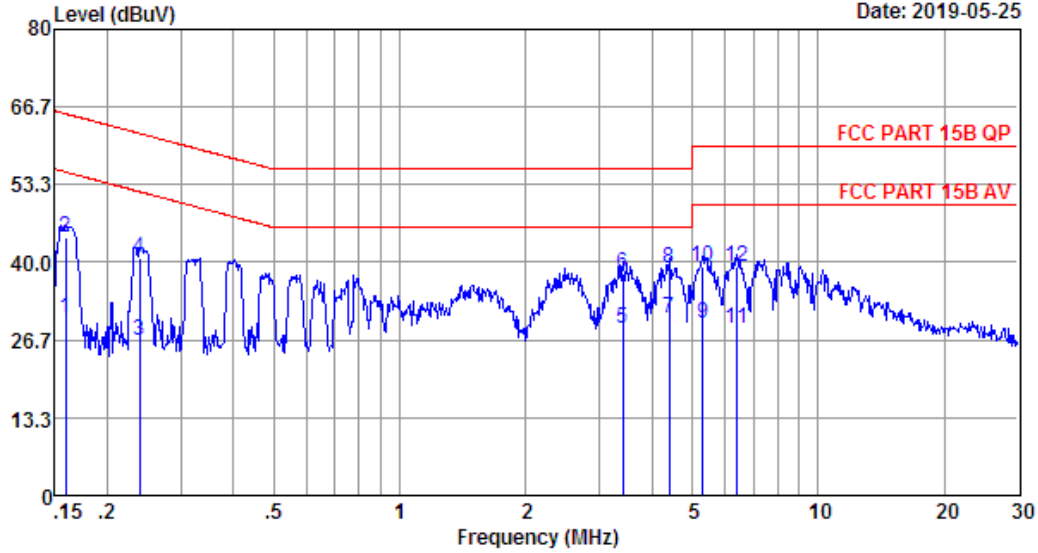

Site no : 844 Shield Room Data no. : 229
 Env. / Ins. : Temp:24.1'C Humi:52% Press:101.50kPa LINE Phase : LINE
 Limit : FCC PART 15B QP
 Engineer : Viking
 EUT : Portable Wireless Speaker
 Power : DC 5V From Adapter Input AC 240V/60Hz
 M/N : VIFA110
 Test Mode : TX Mode

	Freq. (MHz)	LISN Factor (dB)	Cable Loss (dB)	Reading (dBuV)	Emission Level (dBuV)	Limits (dBuV)	Margin (dB)	Remark
1	0.16	9.59	9.69	11.20	30.48	55.52	25.04	Average
2	0.16	9.59	9.69	24.93	44.21	65.52	21.31	QP
3	0.24	9.61	9.92	6.90	26.43	52.13	25.70	Average
4	0.24	9.61	9.92	21.08	40.61	62.13	21.52	QP
5	3.42	9.67	9.98	9.09	28.74	46.00	17.26	Average
6	3.42	9.67	9.98	18.51	38.16	56.00	17.84	QP
7	4.41	9.68	10.00	10.61	30.29	46.00	15.71	Average
8	4.41	9.68	10.00	19.20	38.88	56.00	17.12	QP
9	5.30	9.69	10.01	9.78	29.48	50.00	20.52	Average
10	5.30	9.69	10.01	19.46	39.16	60.00	20.84	QP
11	6.39	9.71	10.03	8.83	28.57	50.00	21.43	Average
12	6.39	9.71	10.03	19.54	39.28	60.00	20.72	QP

Remarks: 1. Emission Level= LISN Factor + Cable Loss + Reading.
 2. Margin= Limit - Emission Level.
 3. If the average limit is met when using a quasi-peak detector,
 the EUT shall be deemed to meet both limits and measurement
 with average detector is unnecessary.

Data: 231 File: \\Emc-ce-1\Test data\2019\G\GuoGuang.EM6 (232) Date: 2019-05-25

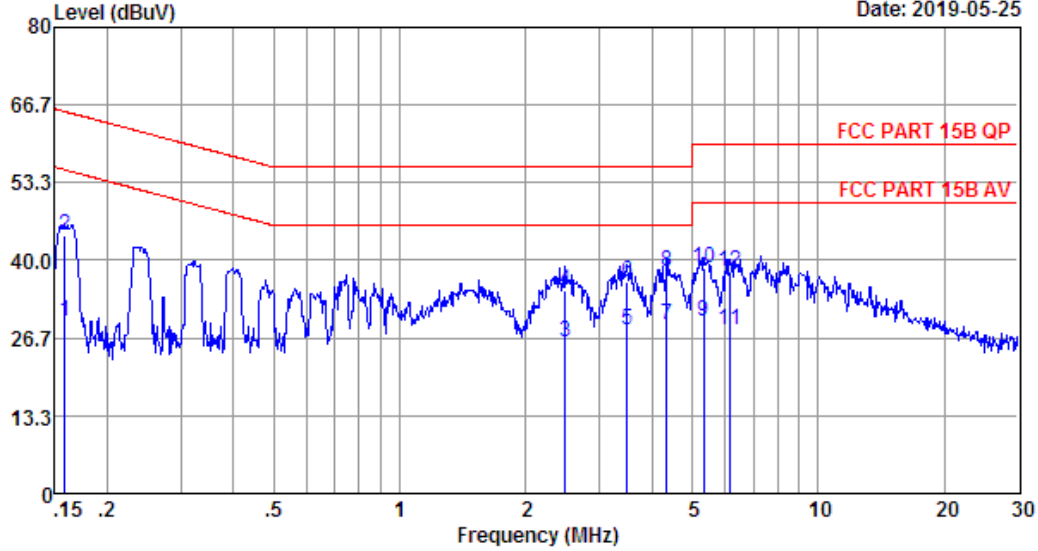

Site no : 844 Shield Room Data no. : 231
 Env. / Ins. : Temp:24.1'C Humi:52% Press:101.50kPa LINE Phase : NEUTRAL
 Limit : FCC PART 15B QP
 Engineer : Viking
 EUT : Portable Wireless Speaker
 Power : DC 5V From Adapter Input AC 240V/60Hz
 M/N : VIFA110
 Test Mode : TX Mode

	Freq. (MHz)	LISN Factor (dB)	Cable Loss (dB)	Reading (dBuV)	Emission Level (dBuV)	Limits (dBuV)	Margin (dB)	Remark
1	0.16	9.50	9.69	10.20	29.39	55.56	26.17	Average
2	0.16	9.50	9.69	24.98	44.17	65.56	21.39	QP
3	2.49	9.57	9.96	6.57	26.10	46.00	19.90	Average
4	2.49	9.57	9.96	15.32	34.85	56.00	21.15	QP
5	3.49	9.59	9.98	8.36	27.93	46.00	18.07	Average
6	3.49	9.59	9.98	16.63	36.20	56.00	19.80	QP
7	4.34	9.60	9.99	9.24	28.83	46.00	17.17	Average
8	4.34	9.60	9.99	18.43	38.02	56.00	17.98	QP
9	5.33	9.61	10.01	9.84	29.46	50.00	20.54	Average
10	5.33	9.61	10.01	18.94	38.56	60.00	21.44	QP
11	6.15	9.62	10.03	8.36	28.01	50.00	21.99	Average
12	6.15	9.62	10.03	18.51	38.16	60.00	21.84	QP

Remarks: 1. Emission Level= LISN Factor + Cable Loss + Reading.
 2. Margin= Limit - Emission Level.
 3. If the average limit is met when using a quasi-peak detector,
 the EUT shall be deemed to meet both limits and measurement
 with average detector is unnecessary.

4. RADIATED EMISSION

4.1. Limit

- (a) The field strength of any emissions within the band 13.553-13.567 MHz shall not exceed 15,848 microvolts/meter at 30 meters.
- (b) Within the bands 13.410-13.553 MHz and 13.567-13.710 MHz, the field strength of any emissions shall not exceed 334 microvolts/meter at 30 meters.
- (c) Within the bands 13.110-13.410 MHz and 13.710-14.010 MHz the field strength of any emissions shall not exceed 106 microvolts/meter at 30 meters.
- (d) The field strength of any emissions appearing outside of the 13.110-14.010 MHz band shall not exceed the general radiated emission limits in §15.209.

(Radiated Emission <30MHz (9KHz-30MHz, H-field)

According to FCC section 15.225 for <30MHz, Radiated emissions were measured according to ANSIC63.4. The EUT was set to transmit at the highest output power. The EUT was set 30 meter away from the measuring antenna. The loop antenna was positioned 1 meter above the ground from the center of the loop. The measuring bandwidth was set to 10KHz. (Note: During testing the receive antenna was rotated about its axis to maximize the emission from the EUT)

There was no detected Restricted bands and Radiated suprious emission below 30MHz. The 30m limit was converted to 3m Limit using square factor(x) as it was found by measurements as follows;

$$3\text{ m Limit(dBuV/m)} = 20\log(X)+40\log(30/3) = 20\log(15,848)+40\log(30/3) = 124\text{dBuV}$$

$$3\text{ m Limit(dBuV/m)} = 20\log(X)+40\log(30/3) = 20\log(334)+40\log(30/3) = 90.47\text{dBuV}$$

$$3\text{ m Limit(dBuV/m)} = 20\log(X)+40\log(30/3) = 20\log(106)+40\log(30/3) = 80.506\text{dBuV}$$

$$3\text{ m Limit(dBuV/m)} = 20\log(X)+40\log(30/3) = 20\log(30)+40\log(30/3) = 69.54\text{dBuV}$$

Except as provided elsewhere in this Subpart, the emissions from an intentional radiator shall not exceed the field strength levels specified in the following table:

Frequency range (MHz)	Field Strength@30m		Field Strength@3m
	μV/m	dBμV/m	dBμV/m
Below 13.110	30	29.5	69.5
13.110 ~ 13.410	106	40.5	80.5
13.410 ~ 13.553	334	50.5	90.5
13.553 ~13.567	15.848	84	124.0
13.567 ~ 13.710	334	50.5	90.5
13.710 ~14.010	106	40.5	80.5
Above 14.010	30	29.5	59.5

Note:

a) Field Strength (dBμV/m) = 20*log[Field Strength (μV/m)].

b) In the emission tables above, the tighter limit applies at the Band edge.

Radiated Emission >30MHz (30MHz-1GHz, E-field)

According to FCC section 15.205, the field strength of radiated emissions rom intentiona radiators at a distance of 3 meters shall not exceed the following values:

Frequency (MHz)	Field Strength(μV/m)	Distance(m)
30-88	100	3
88-216	150	3
216-960	200	3
Above 960	500	3

4.2. Test Setup

9kHz~30MHz

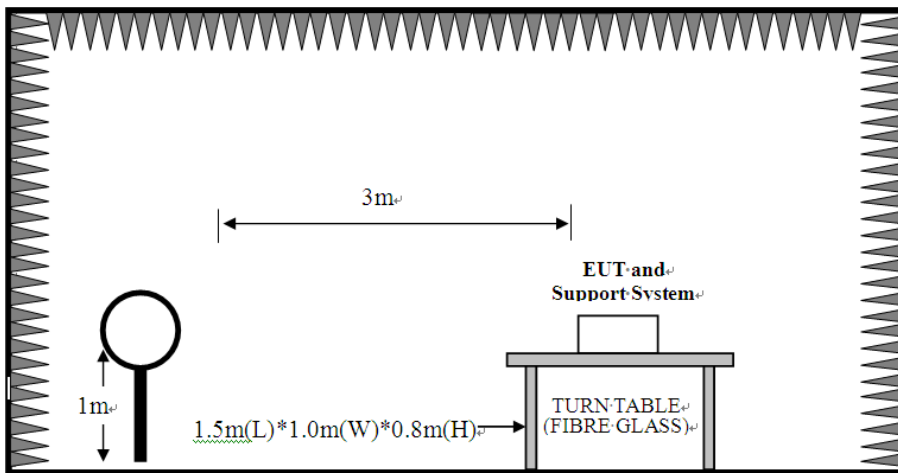

30~1000MHz

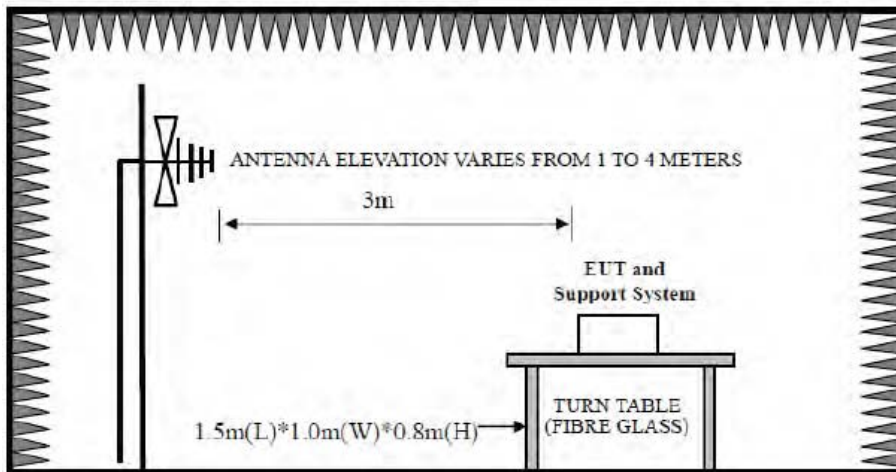

Above 1GHz

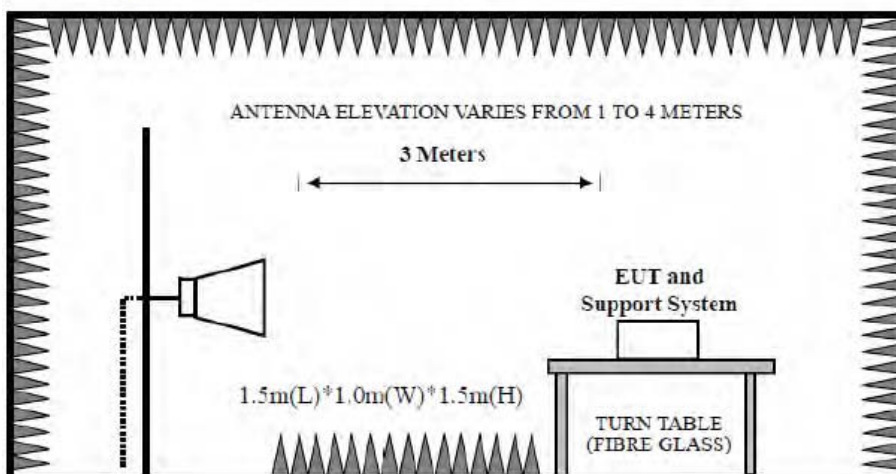

4.3. Spectrum Analyzer Setting

For 9KHz-150KHz

Spectrum Parameters	Setting
RBW	300Hz(for Peak&AVG)/CISPR 200Hz(for QP)
VBW	300Hz(for Peak&AVG)/CISPR 200Hz(for QP)
Start frequency	9KHz
Stop frequency	150KHz
Sweep Time	Auto
Detector	PEAK/QP/AVG
Trace Mode	Max Hold

For 150KHz-30MHz

Spectrum Parameters	Setting
RBW	9KHz
VBW	9KHz
Start frequency	150KHz
Stop frequency	30MHz
Sweep Time	Auto
Detector	QP
Trace Mode	Max Hold

For 30MHz-1GHz

Spectrum Parameters	Setting
RBW	120KHz
VBW	300KHz
Start frequency	30MHz
Stop frequency	1GHz
Sweep Time	Auto
Detector	QP
Trace Mode	Max Hold

4.4. Test Procedure

- a. The test is performed in a 3m Semi-Anechoic Chamber; the antenna factor, cable loss and so on of the site (factors) is calculated to correct the reading. The EUT is placed on a 0.8m high insulating Turn Table, and keeps 3m away from the Test Antenna, which is mounted on a variable-height antenna master tower. For the test Antenna.
- b. In the frequency range of 9KHz to 30MHz, magnetic field is measured with Loop Test Antenna. The Test Antenna is positioned with its plane vertical at 1m distance from the EUT. The center of the Loop Test Antenna is 1m above the ground. During the measurement the Loop Test Antenna rotates about its vertical axis for maximum response at each azimuth about the EUT.
- c. In the frequency range above 30MHz, Bi-Log Test Antenna (30MHz to 1GHz) used. Test Antenna is 3m away from the EUT. Test Antenna height is varied from 1m to 4m above the ground to determine the maximum value of the field strength. The emission levels at both horizontal and vertical polarizations should be tested.
- d. The initial step in collecting conducted emission data is a spectrum analyzer peak detector mode pre-scanning the measurement frequency range. Significant peaks are then marked and then Quasi Peak detector mode re-measured.
- e. If the Peak Mode measured value compliance with and lower than Quasi Peak Mode Limit, the EUT shall be deemed to meet QP Limits and then no additional QP Mode measurement performed.
- f. For the actual test configuration, please refer to the related Item –EUT Test Photos.

4.5. Test Result

Field Strength (only the worst case was reported)

EST Technology

Chilingxiang, Qishantou, Santun,
Houjie, Dongguan, Guangdong, China
Tel: +86-769-83081888
Fax: +86-769-83081878

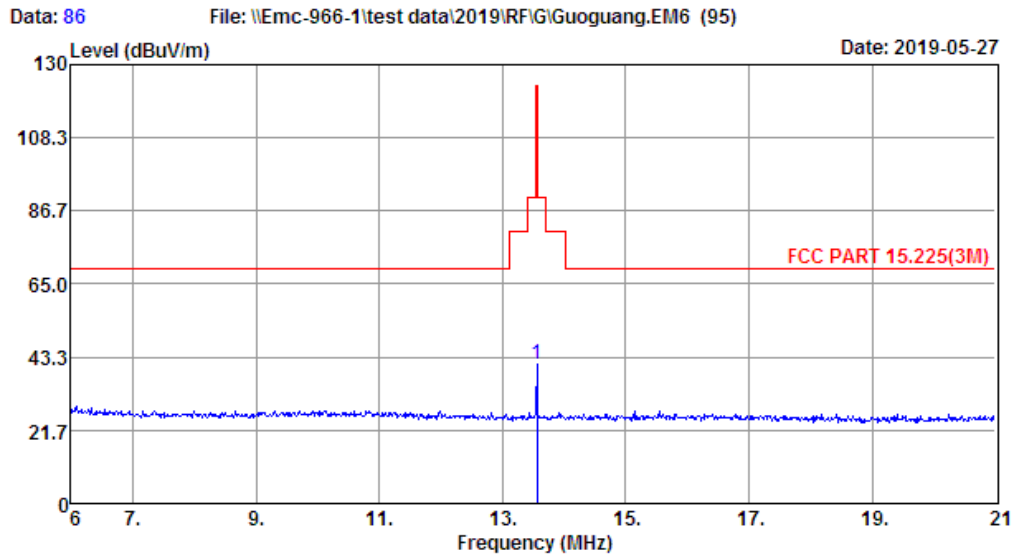

```

Site no.      : 1# 966 Chamber           Data no.   : 86
Dis. / Ant.  : 3m FMZB 1519B           Ant. pol.  : VERTICAL
Limit        : FCC PART 15.225(3M)
Env. / Ins.  : Temp:24.9%;Humi:52%;Press:101.52kPa
Engineer     : Viking
EUT         : Portable Wireless Speaker
Power       : DC 3.7V
M/N         : VIFA110
Test Mode    : TX Mode
    
```

	Freq. (MHz)	ANT Factor (dB/m)	Cable Loss (dB)	Reading (dBuV)	Emission Level (dBuV/m)	Limit (dBuV/m)	Margin (dB)	Remark
1	13.56	19.98	0.15	20.92	41.05	124.00	82.95	Peak

Remarks: 1. Emission Level= Antenna Factor + Cable Loss + Reading.
 2. Margin= Limit - Emission Level.
 3. The emission levels that are 20dB below the official limit are not reported.

9kHz-30MHz

EST Technology

Chilingxiang, Qishantou, Santun,
Houjie, Dongguan, Guangdong, China
Tel: +86-769-83081888
Fax: +86-769-83081878

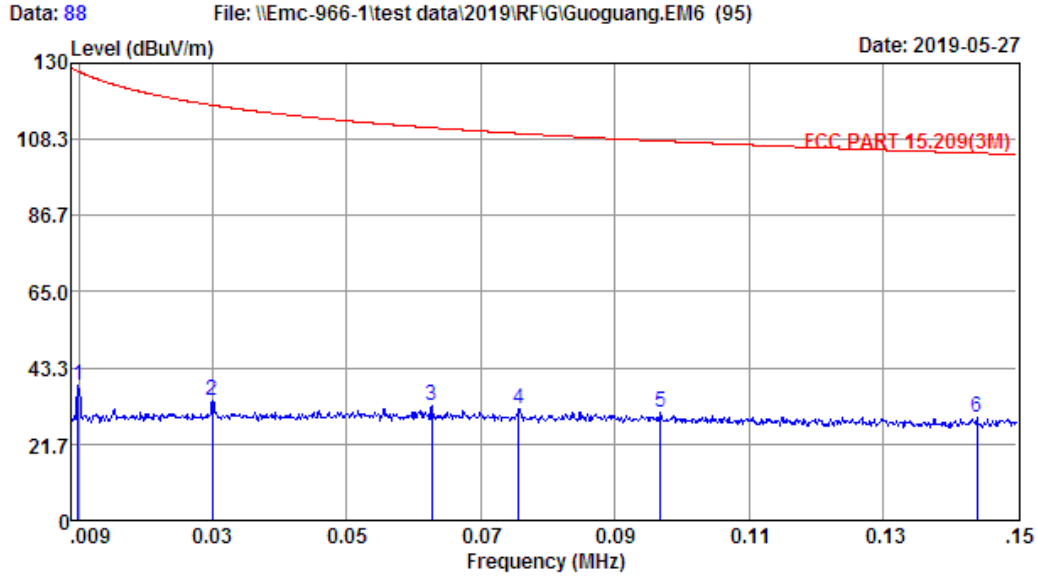

Site no. : 1# 966 Chamber Data no. : 88
 Dis. / Ant. : 3m FMZB 1519B Ant. pol. : VERTICAL
 Limit : FCC PART 15.209(3M)
 Env. / Ins. : Temp:24.9';Humi:52%;Press:101.52kPa
 Engineer : Viking
 EUT : Portable Wireless Speaker
 Power : DC 3.7V
 M/N : VIFA110
 Test Mode : TX Mode

	Freq. (MHz)	ANT Factor (dB/m)	Cable Loss (dB)	Reading (dBuV)	Emission Level (dBuV/m)	Limit (dBuV/m)	Margin (dB)	Remark
1	0.01	20.65	0.10	17.59	38.34	127.62	89.28	Peak
2	0.03	20.42	0.10	13.46	33.98	118.06	84.08	Peak
3	0.06	20.29	0.10	12.46	32.85	111.66	78.81	Peak
4	0.08	20.29	0.10	11.26	31.65	110.02	78.37	Peak
5	0.10	20.24	0.10	10.35	30.69	107.88	77.19	Peak
6	0.14	20.26	0.10	9.09	29.45	104.43	74.98	Peak

Remarks: 1. Emission Level= Antenna Factor + Cable Loss + Reading.
 2. Margin= Limit - Emission Level.
 3. The emission levels that are 20dB below the official limit are not reported.



EST Technology

Chilingxiang, Qishantou, Santun,
Houjie, Dongguan, Guangdong, China
Tel: +86-769-83081888
Fax: +86-769-83081878

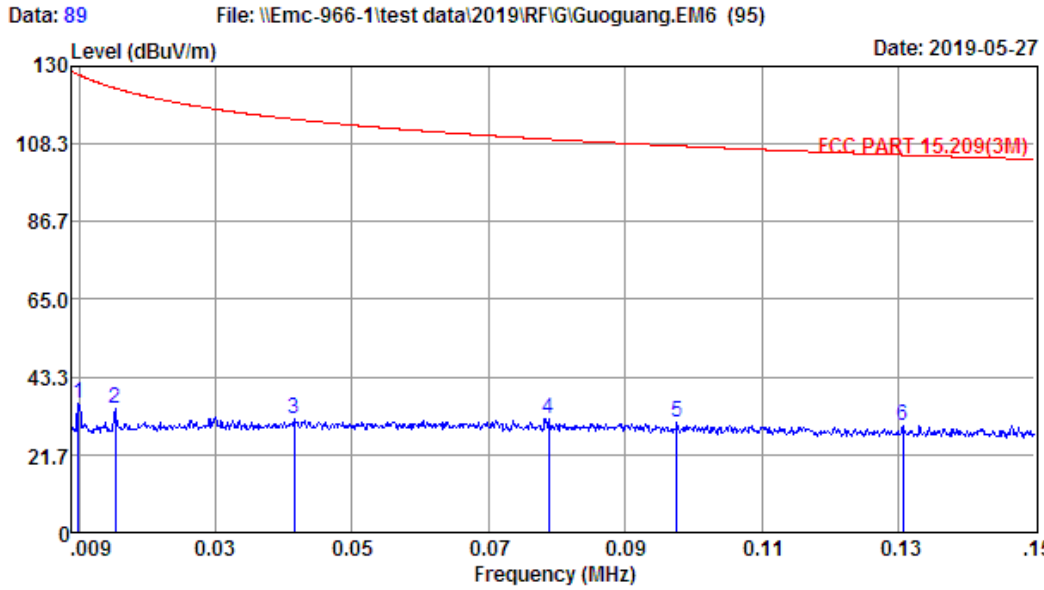

Site no. : 1# 966 Chamber Data no. : 89
 Dis. / Ant. : 3m FMZB 1519B Ant. pol. : HORIZONTAL
 Limit : FCC PART 15.209(3M)
 Env. / Ins. : Temp:24.9';Humi:52%;Press:101.52kPa
 Engineer : Viking
 EUT : Portable Wireless Speaker
 Power : DC 3.7V
 M/N : VIFA110
 Test Mode : TX Mode

	Freq. (MHz)	ANT Factor (dB/m)	Cable Loss (dB)	Reading (dBuV)	Emission Level (dBuV/m)	Limit (dBuV/m)	Margin (dB)	Remark
1	0.01	20.65	0.10	15.31	36.06	127.62	91.56	Peak
2	0.02	20.65	0.10	13.56	34.31	123.89	89.58	Peak
3	0.04	20.42	0.10	11.11	31.63	115.23	83.60	Peak
4	0.08	20.29	0.10	11.24	31.63	109.67	78.04	Peak
5	0.10	20.24	0.10	10.29	30.63	107.82	77.19	Peak
6	0.13	20.25	0.10	9.59	29.94	105.28	75.34	Peak

Remarks: 1. Emission Level= Antenna Factor + Cable Loss + Reading.
 2. Margin= Limit - Emission Level.
 3. The emission levels that are 20dB below the official limit are not reported.

EST Technology

Chilingxiang, Qishantou, Santun,
Houjie, Dongguan, Guangdong, China
Tel: +86-769-83081888
Fax: +86-769-83081878

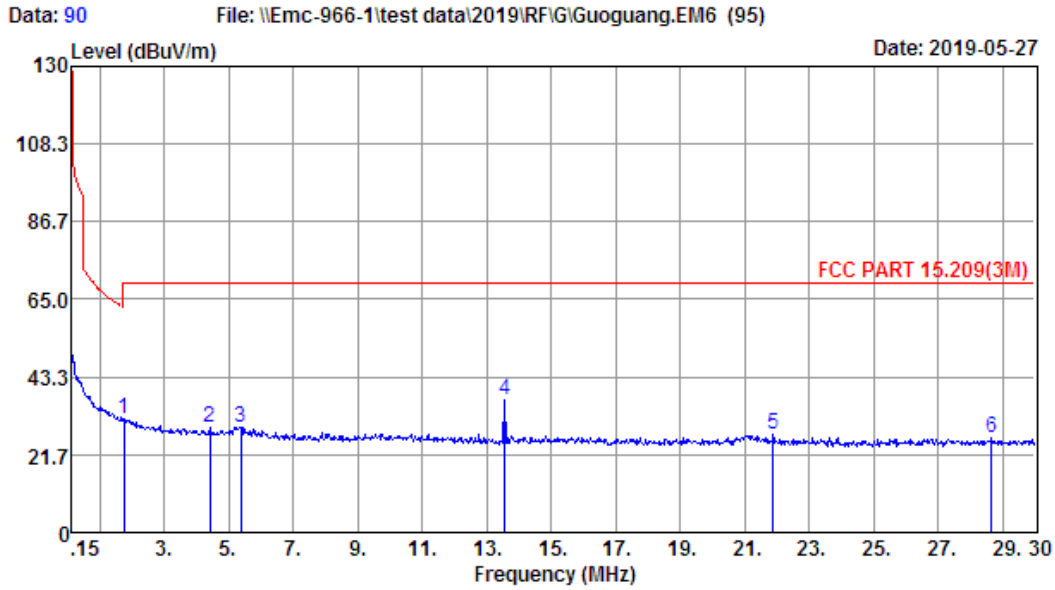

Site no. : 1# 966 Chamber Data no. : 90
 Dis. / Ant. : 3m FMZB 1519B Ant. pol. : HORIZONTAL
 Limit : FCC PART 15.209(3M)
 Env. / Ins. : Temp:24.9';Humi:52%;Press:101.52kPa
 Engineer : Viking
 EUT : Portable Wireless Speaker
 Power : DC 3.7V
 M/N : VIFA110
 Test Mode : TX Mode

	Freq. (MHz)	ANT Factor (dB/m)	Cable Loss (dB)	Reading (dBuV)	Emission Level (dBuV/m)	Limit (dBuV/m)	Margin (dB)	Remark
1	1.76	19.99	0.11	11.49	31.59	69.54	37.95	Peak
2	4.42	20.02	0.11	9.37	29.50	69.54	40.04	Peak
3	5.37	20.02	0.12	9.20	29.34	69.54	40.20	Peak
4	13.56	19.98	0.15	17.04	37.17	69.54	32.37	Freq.
5	21.88	20.15	0.17	6.98	27.30	69.54	42.24	Peak
6	28.66	20.53	0.20	5.64	26.37	69.54	43.17	Peak

Remarks: 1. Emission Level= Antenna Factor + Cable Loss + Reading.
 2. Margin= Limit - Emission Level.
 3. The emission levels that are 20dB below the official limit are not reported.

EST Technology

Chilingxiang, Qishantou, Santun,
Houjie, Dongguan, Guangdong, China
Tel: +86-769-83081888
Fax: +86-769-83081878

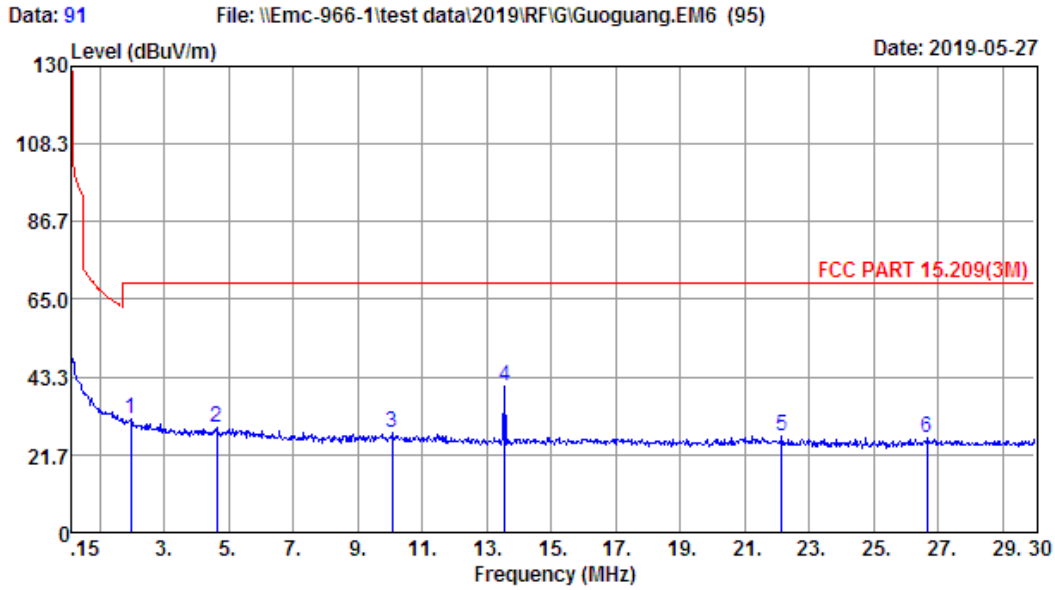

Site no. : 1# 966 Chamber Data no. : 91
 Dis. / Ant. : 3m FMZB 1519B Ant. pol. : VERTICAL
 Limit : FCC PART 15.209(3M)
 Env. / Ins. : Temp:24.9';Humi:52%;Press:101.52kPa
 Engineer : Viking
 EUT : Portable Wireless Speaker
 Power : DC 3.7V
 M/N : VIFA110
 Test Mode : TX Mode

	Freq. (MHz)	ANT Factor (dB/m)	Cable Loss (dB)	Reading (dBuV)	Emission Level (dBuV/m)	Limit (dBuV/m)	Margin (dB)	Remark
1	1.97	19.99	0.11	11.43	31.53	69.54	38.01	Peak
2	4.63	20.03	0.12	9.12	29.27	69.54	40.27	Peak
3	10.09	19.99	0.13	7.71	27.83	69.54	41.71	Peak
4	13.56	19.98	0.15	20.82	40.95	69.54	28.59	Freq.
5	22.15	20.16	0.17	6.57	26.90	69.54	42.64	Peak
6	26.66	20.40	0.19	5.62	26.21	69.54	43.33	Peak

Remarks: 1. Emission Level= Antenna Factor + Cable Loss + Reading.
 2. Margin= Limit - Emission Level.
 3. The emission levels that are 20dB below the official limit are not reported.

EST Technology

Chilingxiang, Qishantou, Santun,
Houjie, Dongguan, Guangdong, China
Tel: +86-769-83081888
Fax: +86-769-83081878

Data: 61 File: \\Emc-966-1\test data\2019\RF\G\Guoguang.EM6 (84) Date: 2019-05-27

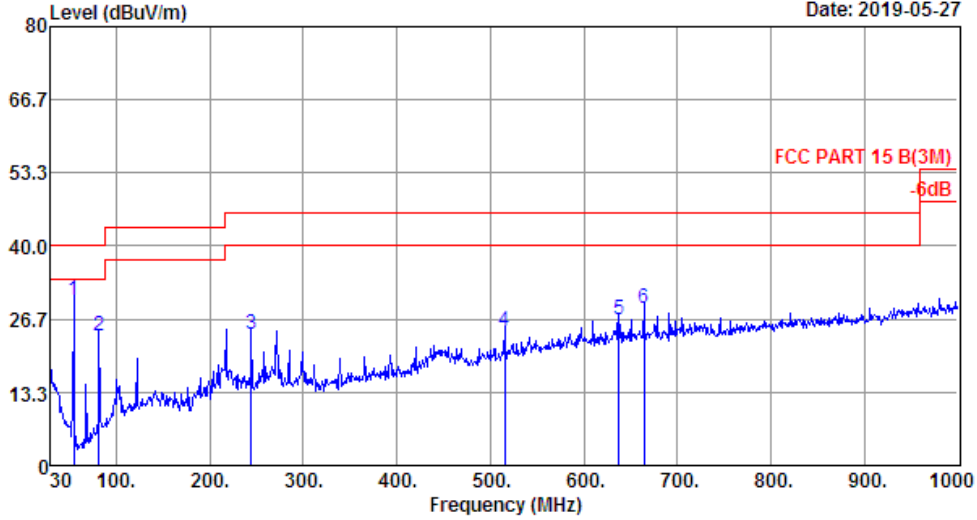

Site no. : 1# 966 Chamber Data no. : 61
 Dis. / Ant. : 3m 37062 Ant. pol. : VERTICAL
 Limit : FCC PART 15 B(3M)
 Env. / Ins. : Temp:24.9'; Humi:52%; Press:101.52kPa
 Engineer : Viking
 EUT : Portable Wireless Speaker
 Power : DC 3.7V
 M/N : VIFA110
 Test Mode : TX Mode

	Freq. (MHz)	ANT Factor (dB/m)	Cable Loss (dB)	Reading (dBuV)	Emission Level (dBuV/m)	Limit (dBuV/m)	Margin (dB)	Remark
1	54.25	6.40	0.34	23.34	30.08	40.00	9.92	QP
2	81.41	7.46	0.70	15.54	23.70	40.00	16.30	QP
3	244.37	11.62	1.60	10.61	23.83	46.00	22.17	QP
4	515.00	18.50	2.72	3.18	24.40	46.00	21.60	QP
5	637.22	20.77	3.15	2.65	26.57	46.00	19.43	QP
6	664.38	21.35	3.22	4.07	28.64	46.00	17.36	QP

Remarks: 1. Emission Level= Antenna Factor + Cable Loss + Reading.
 2. Margin= Limit - Emission Level.
 3. The emission levels that are 20dB below the official limit are not reported.

EST Technology

Chilingxiang, Qishantou, Santun,
Houjie, Dongguan, Guangdong, China
Tel: +86-769-83081888
Fax: +86-769-83081878

Data: 62 File: \\Emc-966-1\test data\2019\RF\IG\Guoguang.EM6 (84) Date: 2019-05-27

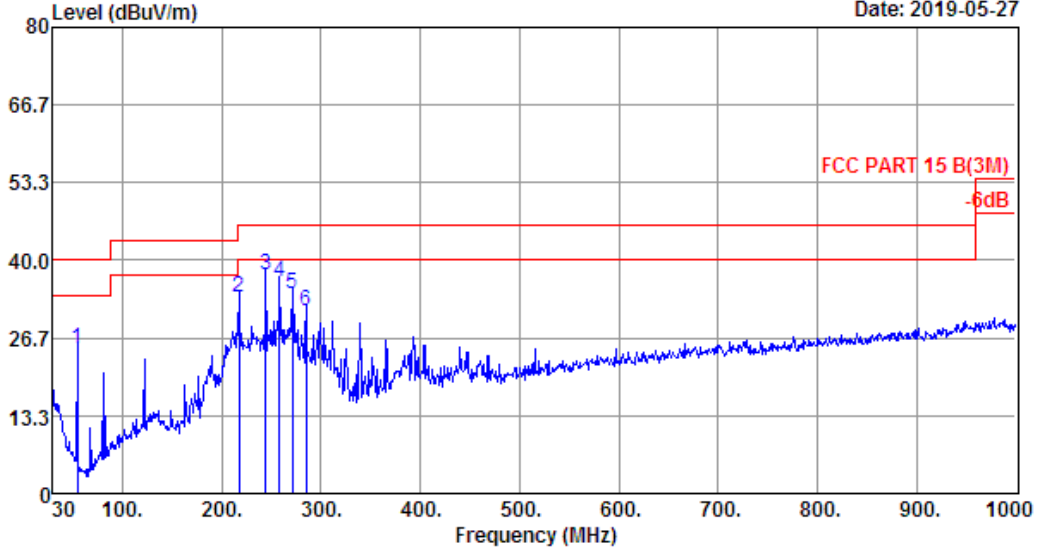

Site no. : 1# 966 Chamber Data no. : 62
 Dis. / Ant. : 3m 37062 Ant. pol. : HORIZONTAL
 Limit : FCC PART 15 B(3M)
 Env. / Ins. : Temp:24.9';Humi:52%;Press:101.52kPa
 Engineer : Viking
 EUT : Portable Wireless Speaker
 Power : DC 3.7V
 M/N : VIFA110
 Test Mode : TX Mode

	Freq. (MHz)	ANT Factor (dB/m)	Cable Loss (dB)	Reading (dBuV)	Emission Level (dBuV/m)	Limit (dBuV/m)	Margin (dB)	Remark
1	54.25	6.40	0.34	18.14	24.88	40.00	15.12	QP
2	217.21	9.40	1.42	22.90	33.72	46.00	12.28	QP
3	244.37	11.62	1.60	24.13	37.35	46.00	8.65	QP
4	257.95	13.50	1.68	21.10	36.28	46.00	9.72	QP
5	271.53	13.07	1.74	19.54	34.35	46.00	11.65	QP
6	285.11	13.20	1.80	16.21	31.21	46.00	14.79	QP

Remarks: 1. Emission Level= Antenna Factor + Cable Loss + Reading.
 2. Margin= Limit - Emission Level.
 3. The emission levels that are 20dB below the official limit are not reported.

5. FREQUENCY TOLERANCE

5.1. Limit

The devices operating in the 13.553-13.567 MHz shall maintain the carrier frequency within 0.01% of the operating frequency over the temperature variation of -20°C to +50°C using an environmental chamber. The primary supply voltage is varied from 85% to 115% of the voltage normally at the input to the device or at the power supply terminals if cables are not normally supplied.

5.2. Test Setup

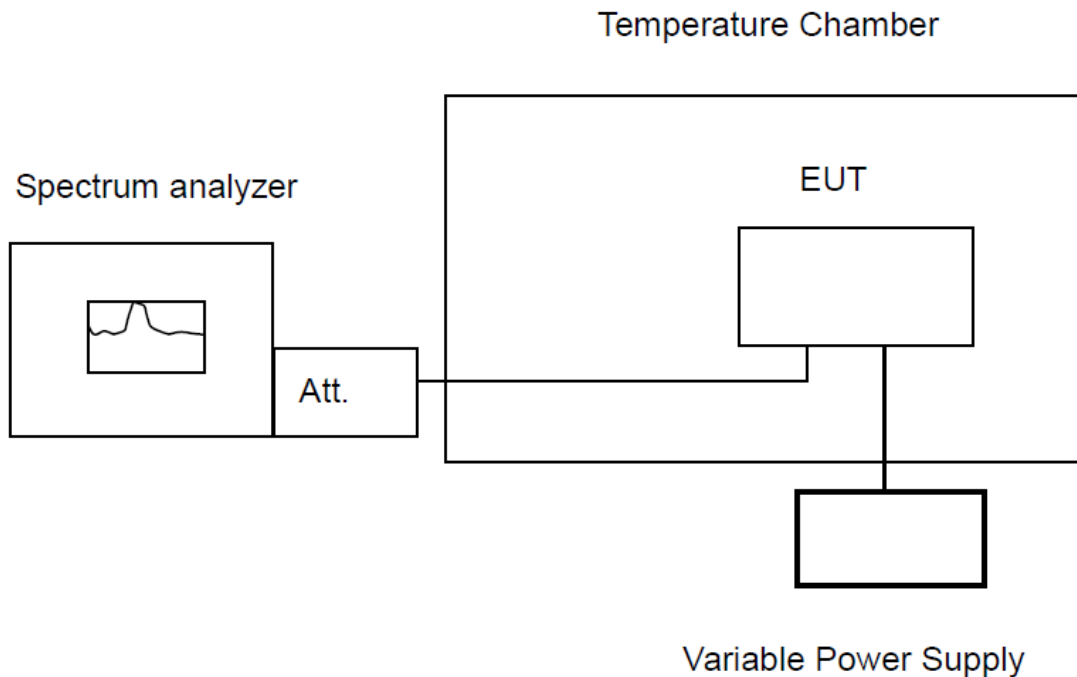

The EUT which is powered by the Battery, is coupled to the Spectrum Analyzer; the RF load attached to the EUT antenna terminal is 50Ohm; the path loss as the factor is calibrated to correct the reading.

5.3. Test Procedure

The frequency tolerance of the carrier signal shall be maintained within $\pm 0.01\%$ of the operating frequency over a temperature variation of -20 degrees to + 50 degrees C at normal supply voltage, and for a variation in the primary supply voltage from 85% to 115% of the rated supply voltage at a temperature of 20 degrees C. For battery operated equipment, the equipment tests shall be performed using a new battery.

5.4. Test Result

Frequency Stability Under Temperature Variation							
Frequency (MHz)	Voltage (V)	Temperature (°C)	Time (minutes)	Measurement Value (MHz)	Frequency Error (%)	Limit (%)	Test Result
13.56	3.7	50	0	13.5606749	0.0049771	±0.01	PASS
			2	13.5606748	0.0049764	±0.01	PASS
			5	13.5606749	0.0049771	±0.01	PASS
			10	13.5606750	0.0049779	±0.01	PASS
		40	0	13.5606745	0.0049742	±0.01	PASS
			2	13.5606748	0.0049764	±0.01	PASS
			5	13.5606751	0.0049786	±0.01	PASS
			10	13.5606750	0.0049779	±0.01	PASS
		30	0	13.5606748	0.0049764	±0.01	PASS
			2	13.5606749	0.0049771	±0.01	PASS
			5	13.5606749	0.0049771	±0.01	PASS
			10	13.5606746	0.0049749	±0.01	PASS
		20	0	13.5606747	0.0049757	±0.01	PASS
			2	13.5606748	0.0049764	±0.01	PASS
			5	13.5606749	0.0049771	±0.01	PASS
			10	13.5606749	0.0049771	±0.01	PASS
		10	0	13.5606751	0.0049786	±0.01	PASS
			2	13.5606750	0.0049779	±0.01	PASS
			5	13.5606749	0.0049771	±0.01	PASS
			10	13.5606749	0.0049771	±0.01	PASS
		0	0	13.5606751	0.0049786	±0.01	PASS
			2	13.5606748	0.0049764	±0.01	PASS
			5	13.5606749	0.0049771	±0.01	PASS
			10	13.5606748	0.0049764	±0.01	PASS
		-10	0	13.5606747	0.0049757	±0.01	PASS
			2	13.5606747	0.0049757	±0.01	PASS
			5	13.5606748	0.0049764	±0.01	PASS
			10	13.5606748	0.0049764	±0.01	PASS
		-20	0	13.5606747	0.0049757	±0.01	PASS
			2	13.5606746	0.0049749	±0.01	PASS
			5	13.5606748	0.0049764	±0.01	PASS
			10	13.5606748	0.0049764	±0.01	PASS

Frequency Stability Under Voltage Variation						
Frequency (MHz)	Temperature (°C)	Voltage	Measurement Value (MHz)	Frequency Error (%)	Limit (%)	Test Result
13.56	20	4.26	13.5606750	0.0049779	±0.01	PASS
		3.70	13.5606748	0.0049764	±0.01	PASS
		3.15	13.5606747	0.0049757	±0.01	PASS

6. 20dB BANDWIDTH

6.1. Limit

The Occupied Bandwidth should be contained within the frequency band designated in the rule section under which the EUT is operated, it was measured with a spectrum analyzer connected the EUT while the EUT is operating in transmission mode.

6.2. Test Setup

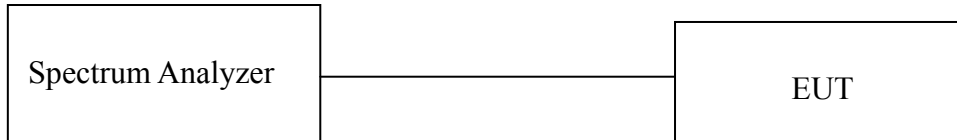

6.3. Spectrum Analyzer Setting

Spectrum Parameters	Setting
RBW	1KHz
VBW	3KHz
Sweep Time	Auto
Detector	Peak
Trace Mode	Max Hold

6.4. Test Procedure

Intentional radiators operating under the alternative provisions to the general emission limits, as contained in §13.553-13.567 MHz and in subpart E of this part, must be designed to ensure that the 20 dB bandwidth of the emission, or whatever bandwidth may otherwise be specified in the specific rule section under which the equipment operates, is contained within the frequency band designated in the rule section under which the equipment is operated. In the case of intentional radiators operating under the provisions of subpart E, the emission bandwidth may span across multiple contiguous frequency bands identified in that subpart. The requirement to contain the designated bandwidth of the emission within the specified frequency band includes the effects from frequency sweeping, frequency hopping and other modulation techniques that may be employed as well as the frequency stability of the transmitter over expected variations in temperature and supply voltage. If a frequency stability is not specified in the regulations, it is recommended that the fundamental emission be kept within at least the central 80% of the permitted band in order to minimize the possibility of out-of-band operation.

6.5. Test Result

Temperature	25°C	Relative Humidity	55%	Test Voltage	DC 3.7V
Mode	Freq (MHz)	20dB Bandwidth (Hz)	99% Occupied Bandwidth (Hz)	Frequency Range (MHz)	Result
TX Mode	13.56	25.9487	21.9589	13.553-13.567	PASS

20dB Bandwidth

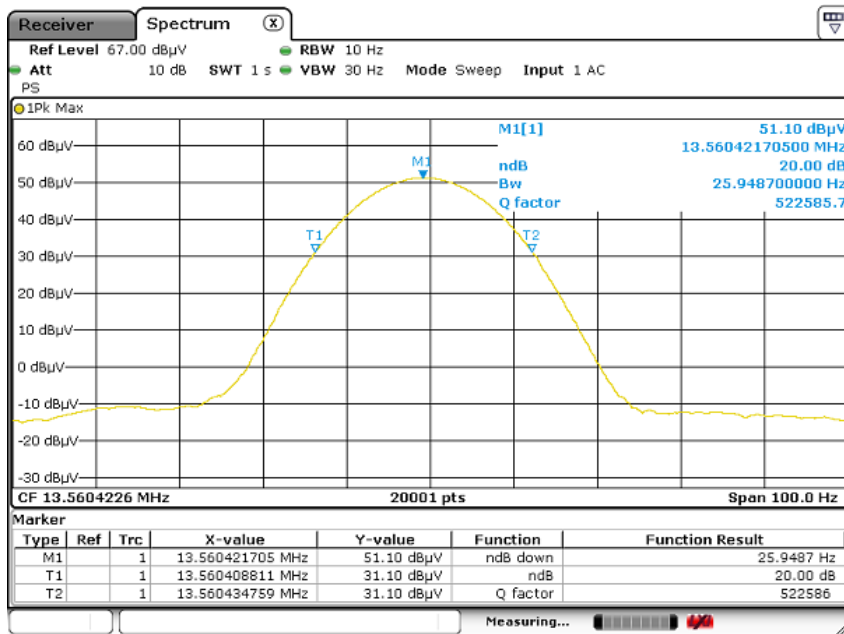

99% Occupied Bandwidth

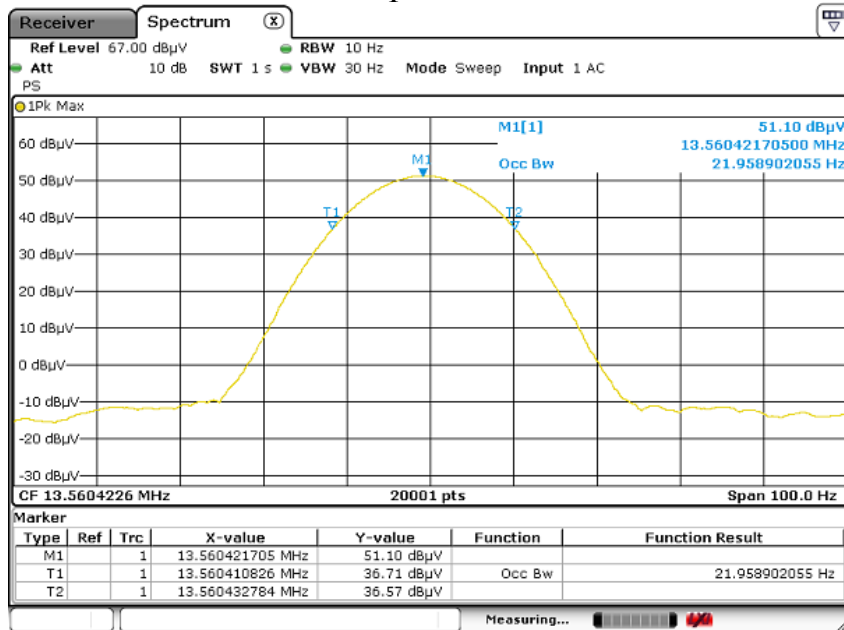

7. ANTENNA REQUIREMENTS

7.1. Limit

An intentional radiator shall be designed to ensure that no antenna other than that furnished by the responsible party shall be used with the device. The use of a permanently attached antenna or of an antenna that uses a unique coupling to the intentional radiator shall be considered sufficient to comply with the provisions of this section. The manufacturer may design the unit so that a broken antenna can be replaced by the user, but the use of a standard antenna jack or electrical connector is prohibited. This requirement does not apply to carrier current devices or to devices operated under the provisions of §§15.211, 15.213, 15.217, 15.219, 15.221, or §15.236. Further, this requirement does not apply to intentional radiators that must be professionally installed, such as perimeter protection systems and some field disturbance sensors, or to other intentional radiators which, in accordance with §15.31(d), must be measured at the installation site. However, the installer shall be responsible for ensuring that the proper antenna is employed so that the limits in this part are not exceeded.

7.2. Test Result

The antennas used for this product compliance with antenna requirements.

8. TEST SETUP PHOTO

Conducted Test

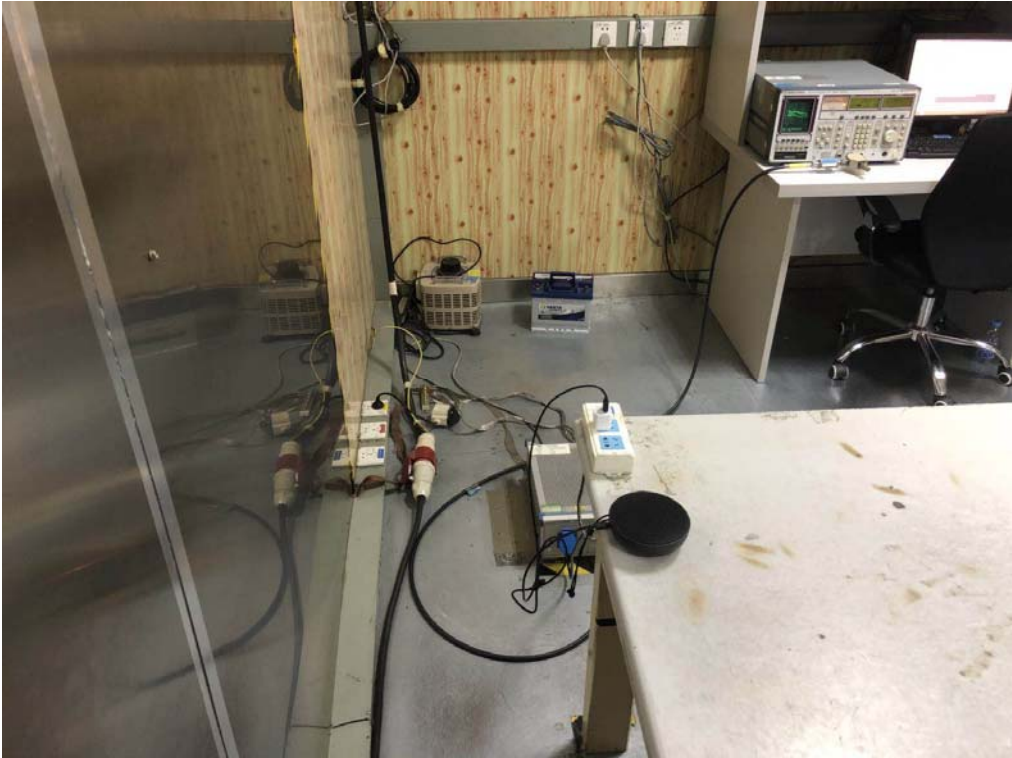
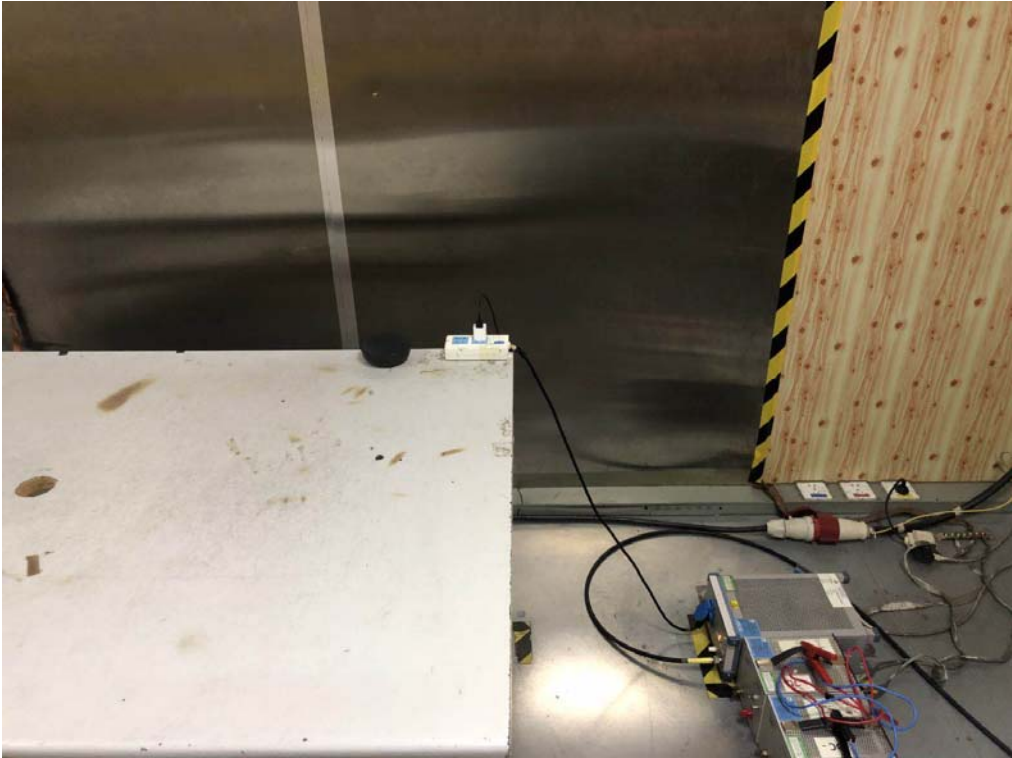

Radiated Test (Below 30MHz)



Radiated Test (Above 30MHz)

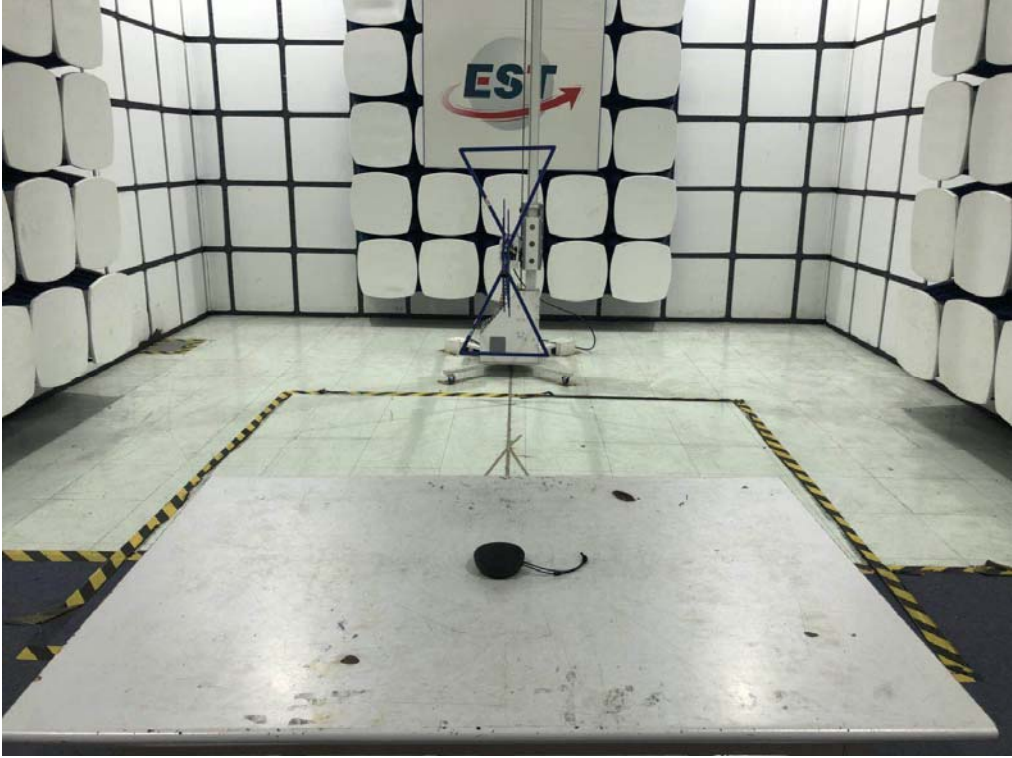

9. EUT PHOTO

External Photos

M/N: VIFA110



External Photos
M/N: VIFA110



External Photos
M/N: VIFA110



External Photos
M/N: VIFA110

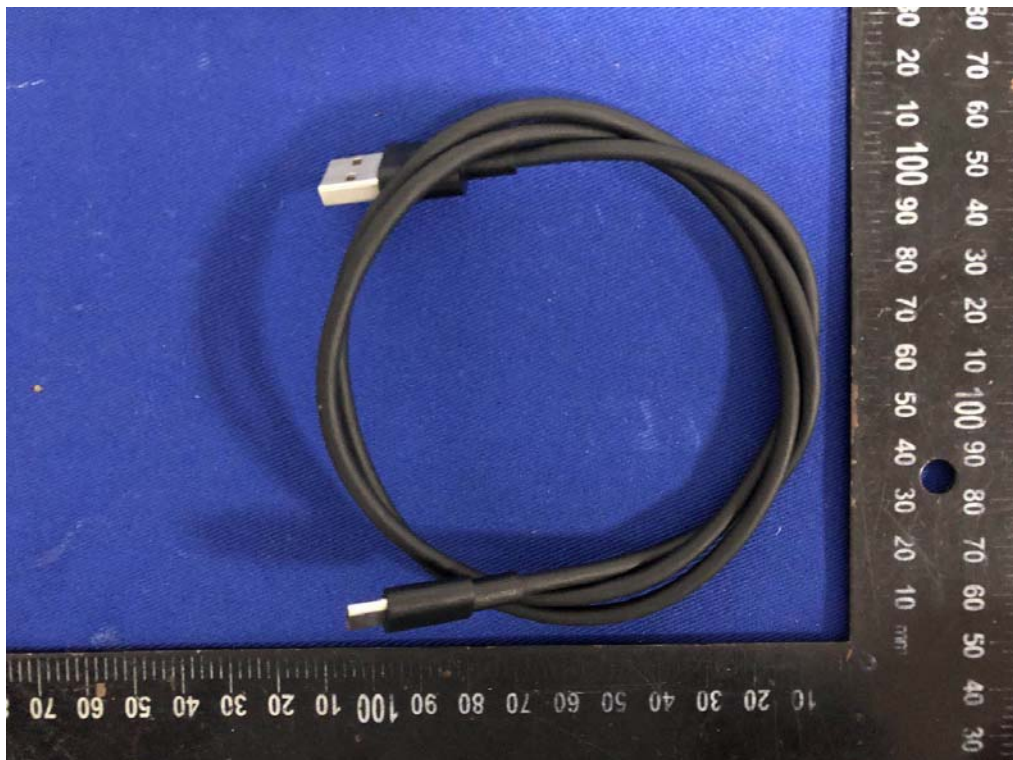
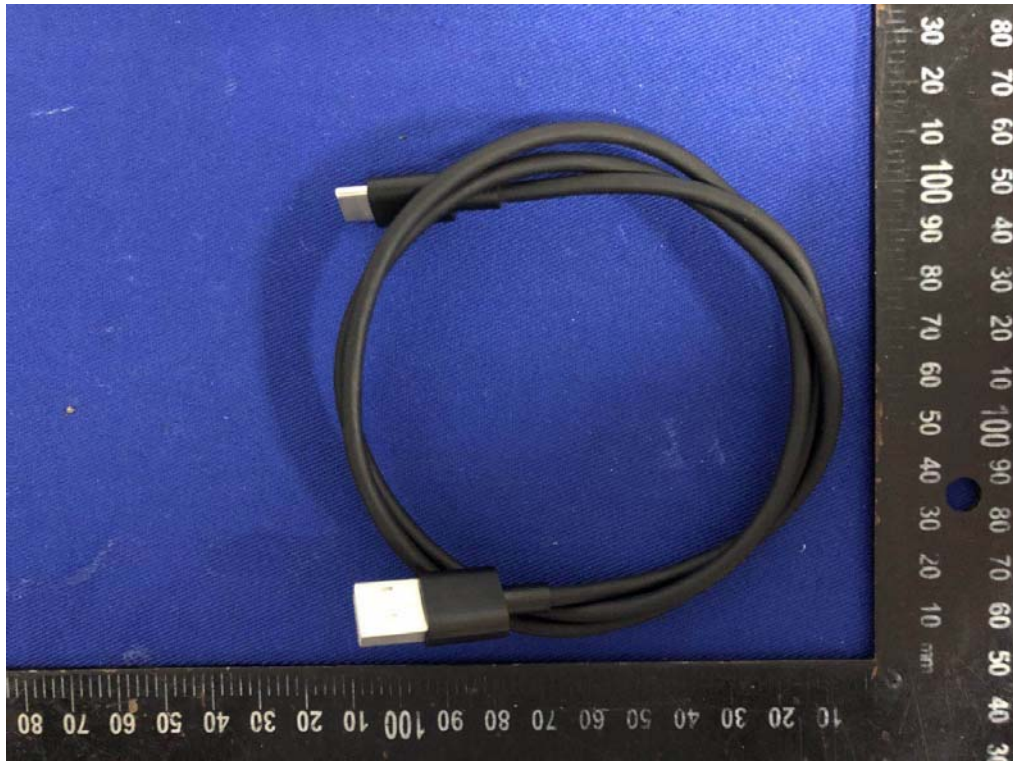

External Photos
M/N: VIFA110

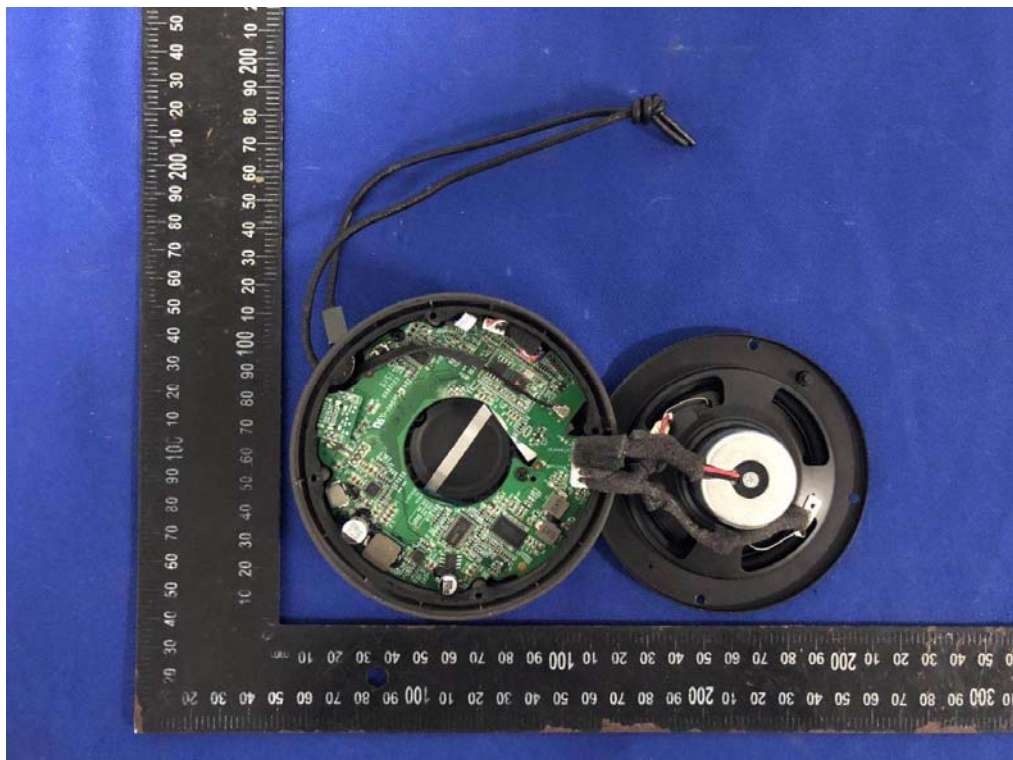
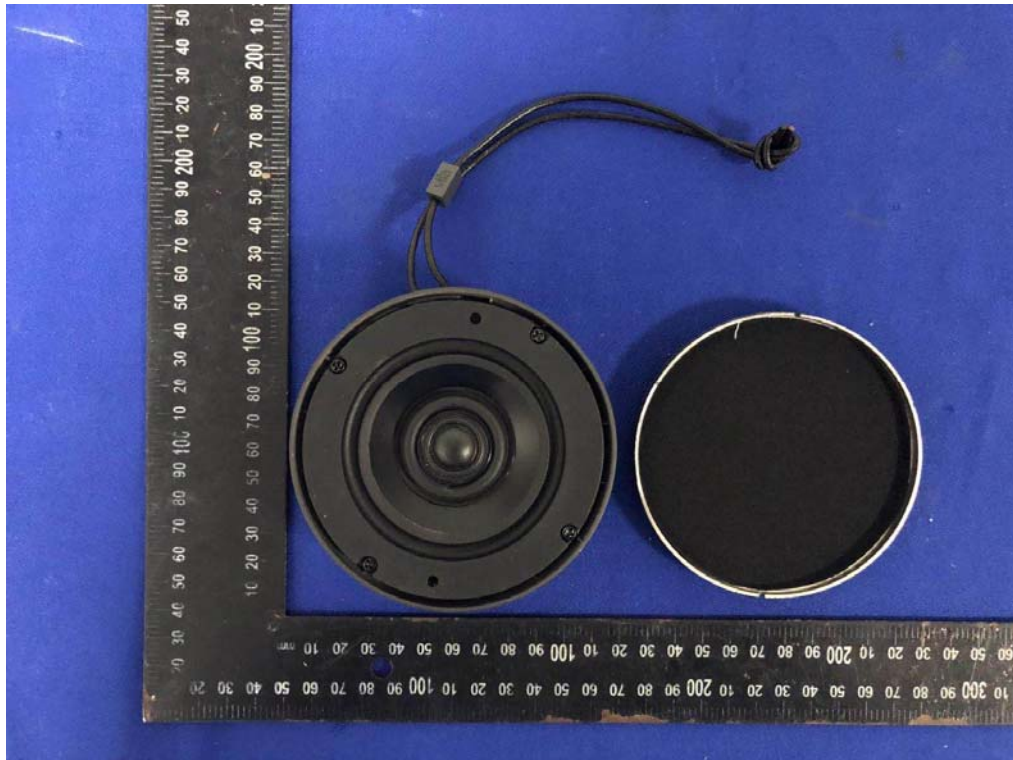

Internal Photos
M/N: VIFA110

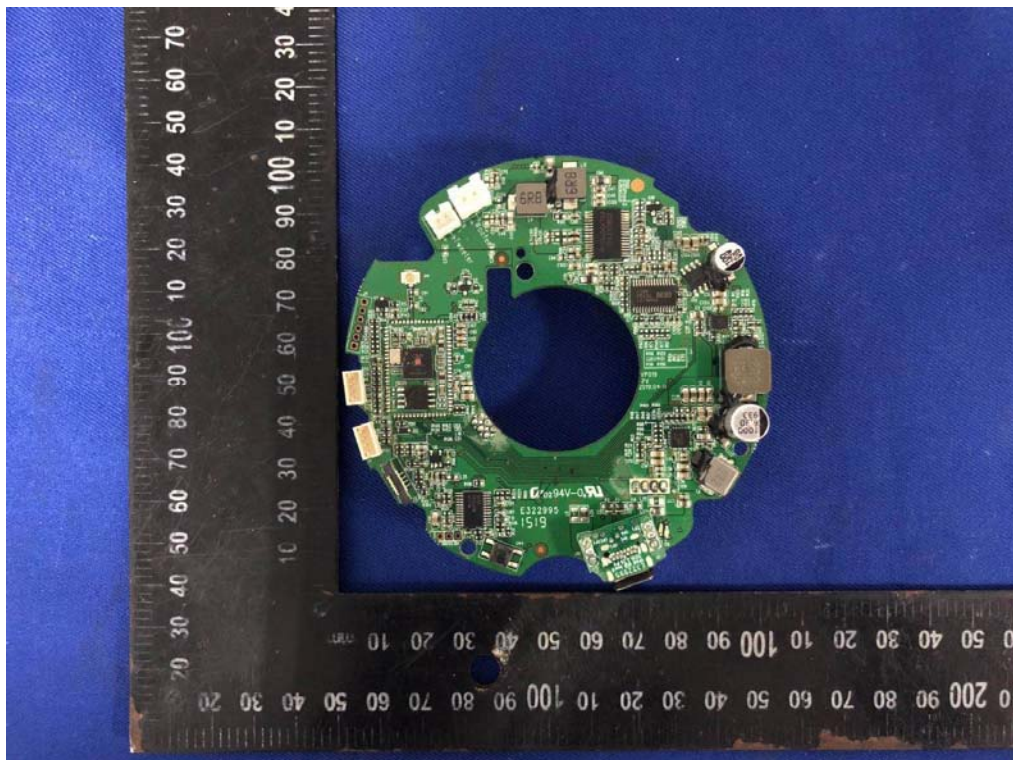
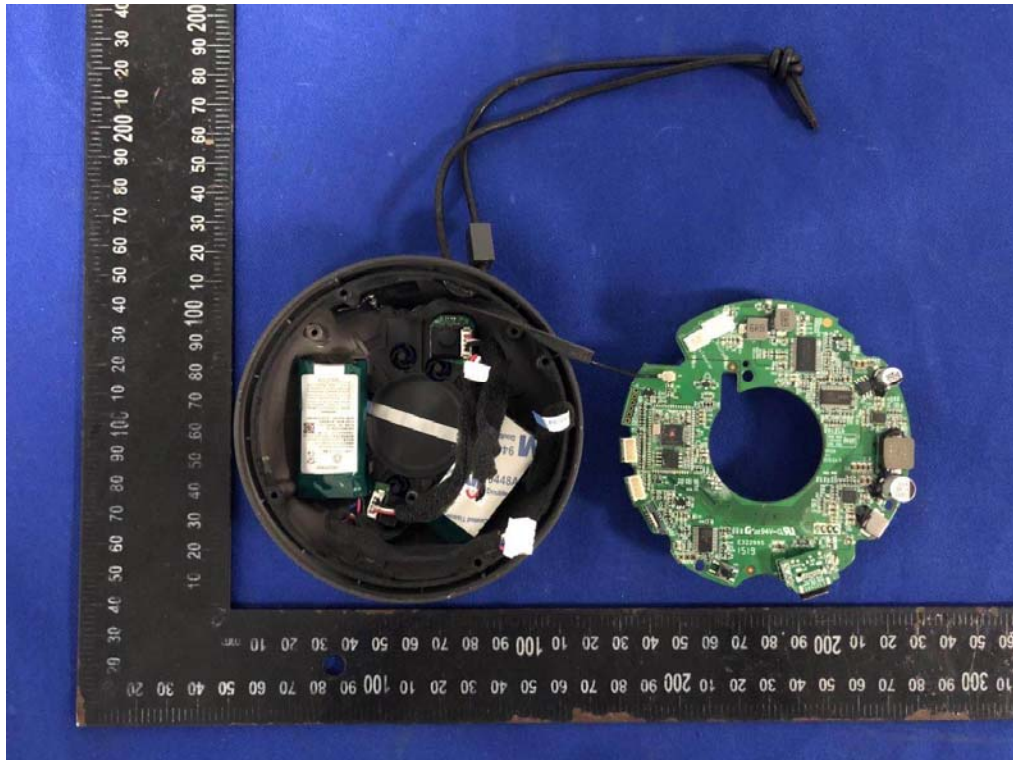

Internal Photos
M/N: VIFA110

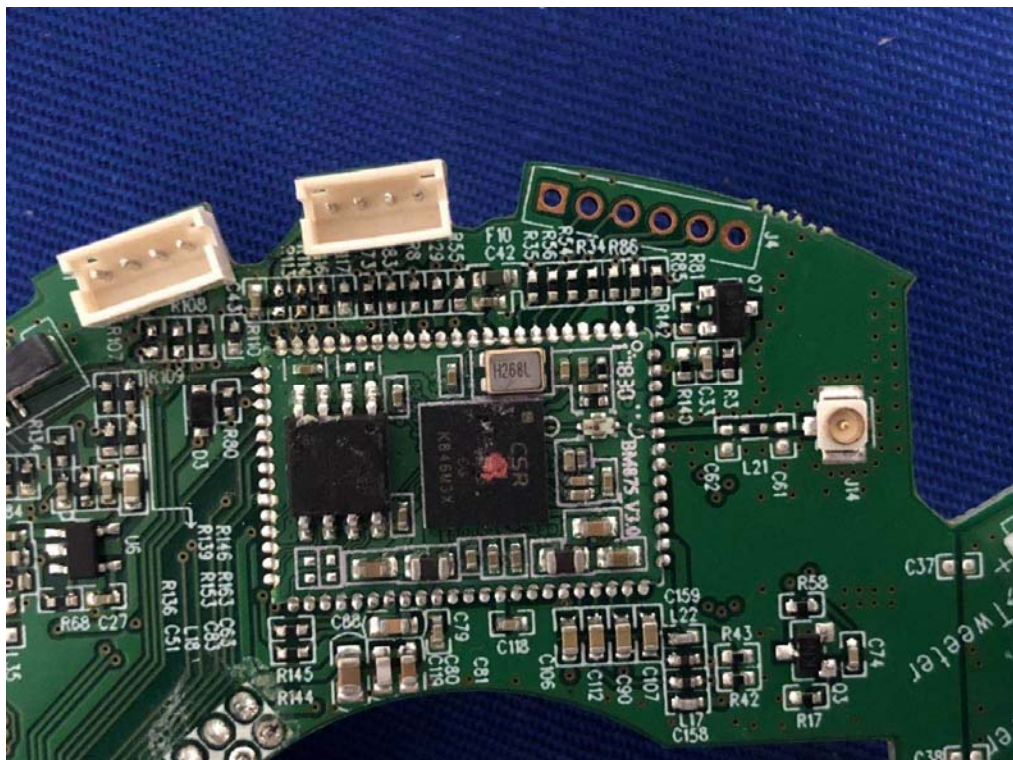
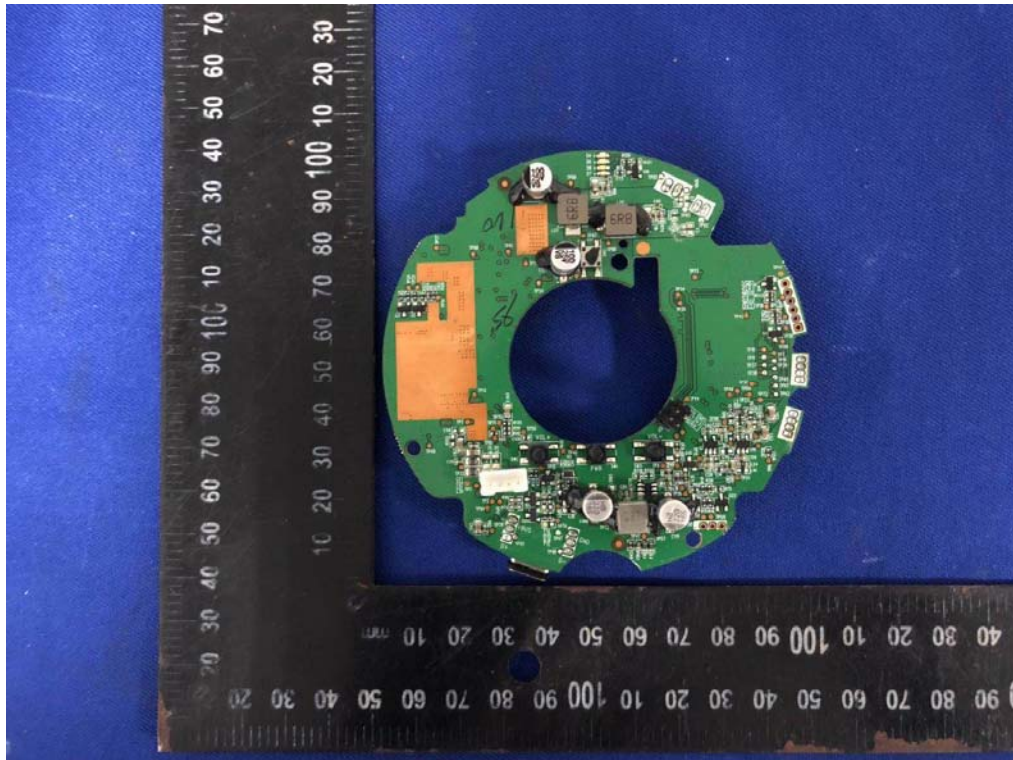

Internal Photos
M/N: VIFA110

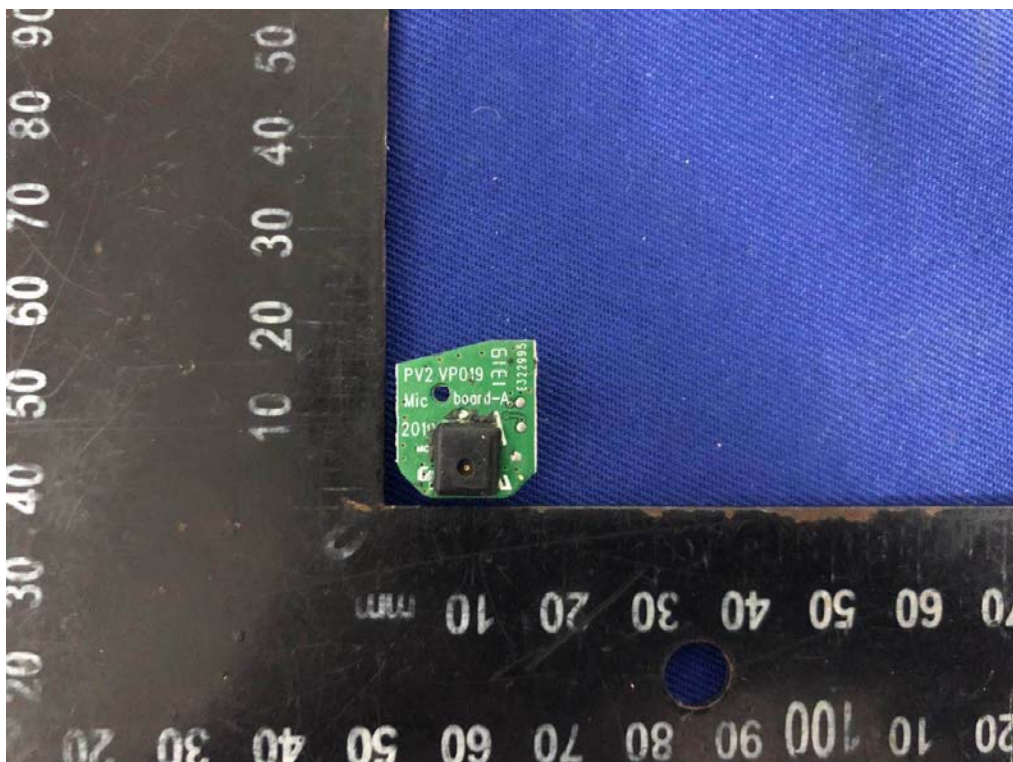
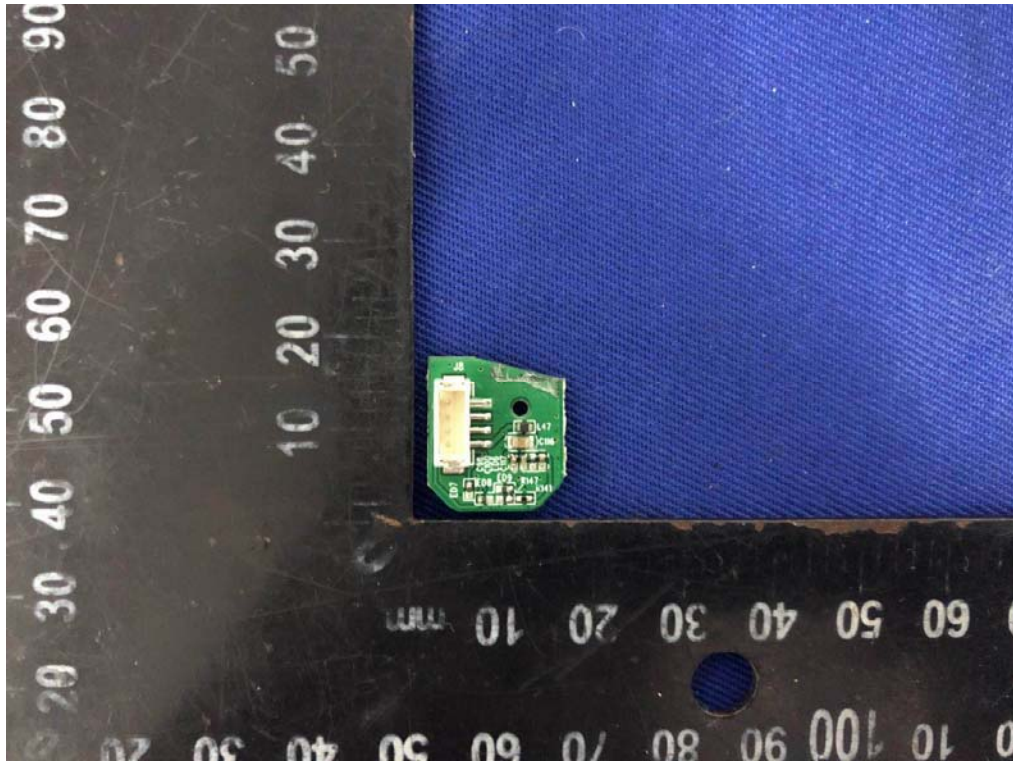

Internal Photos
M/N: VIFA110

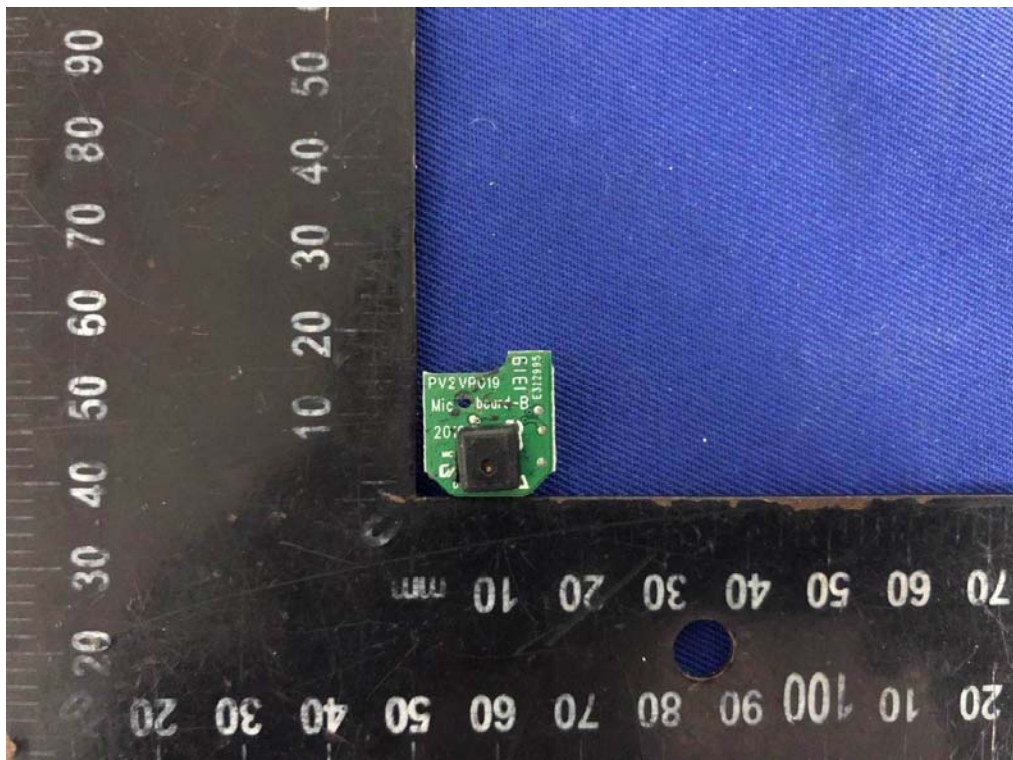
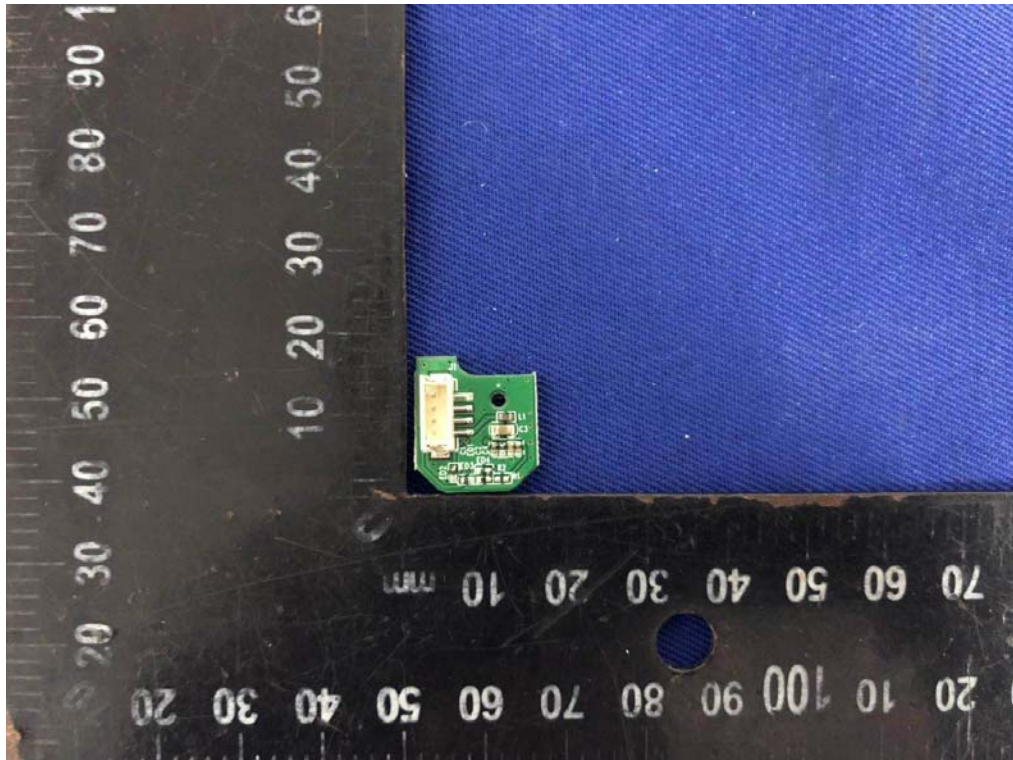

Internal Photos
M/N: VIFA110

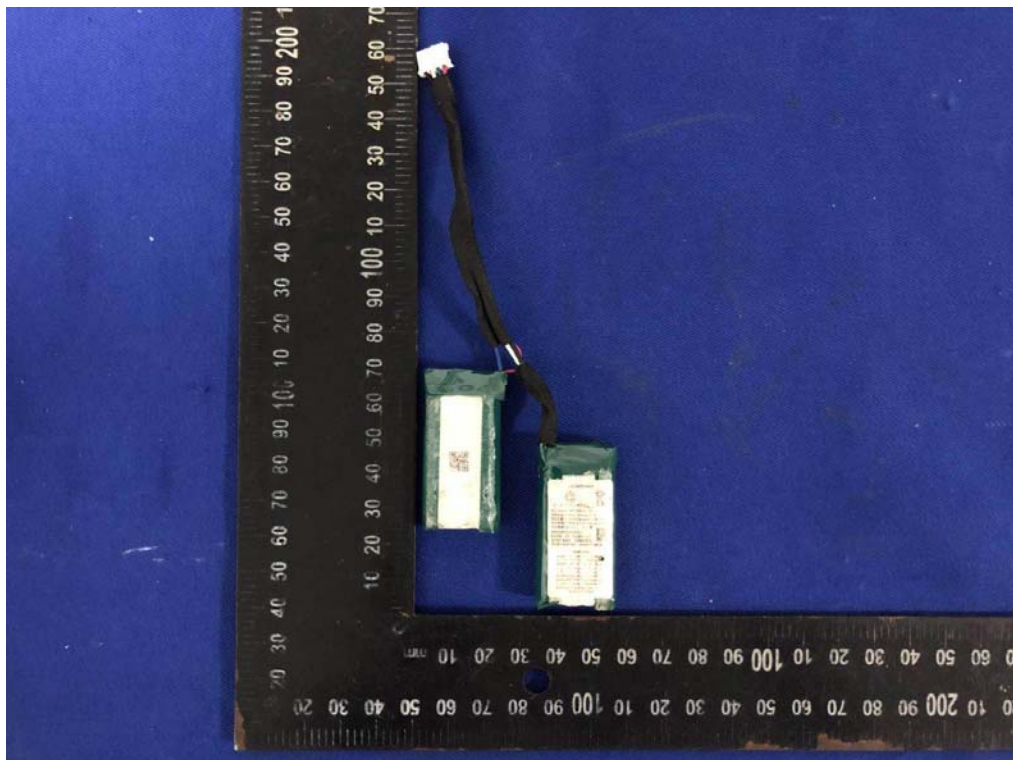
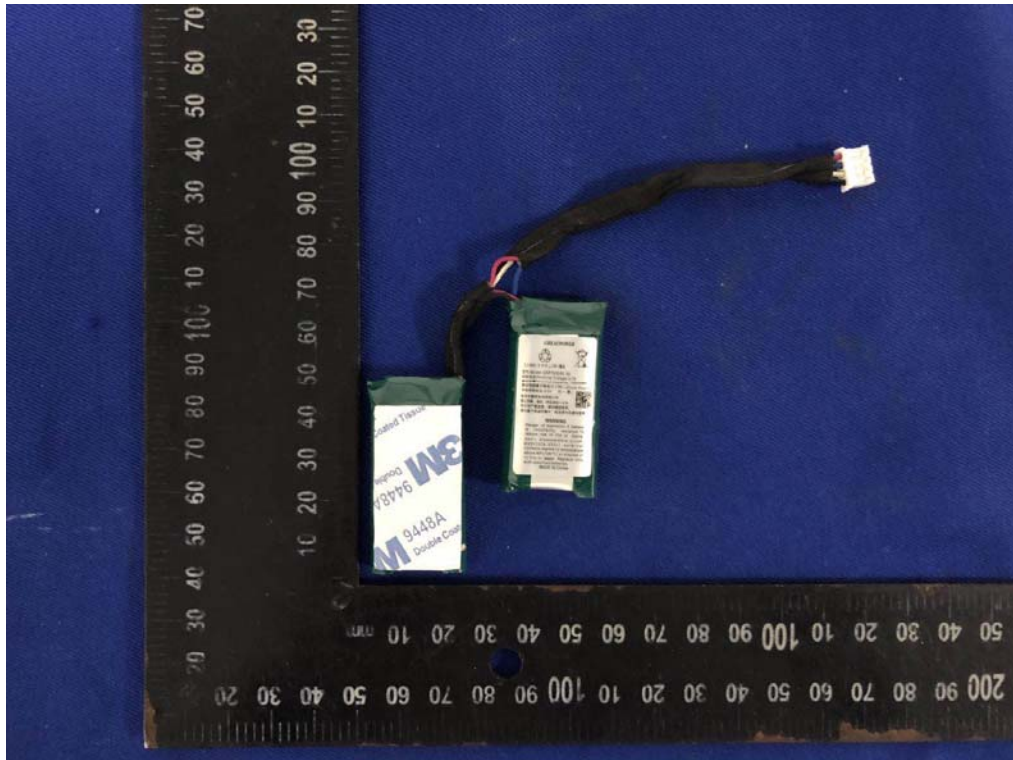

Internal Photos
M/N: VIFA110

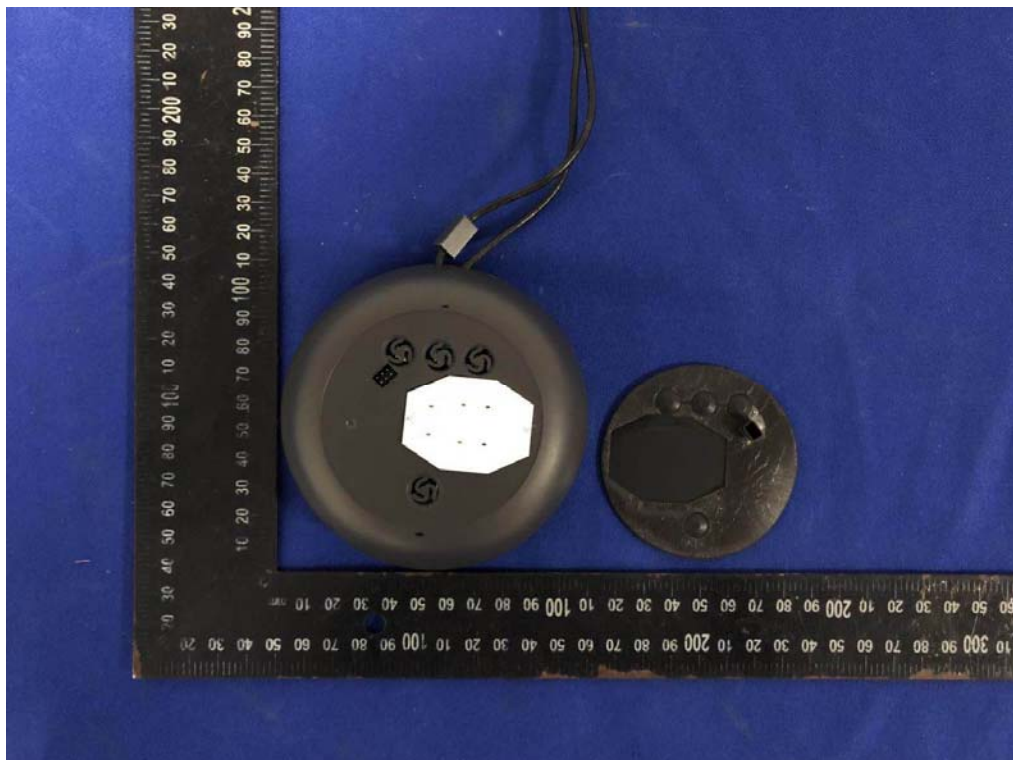

Internal Photos
M/N: VIFA110

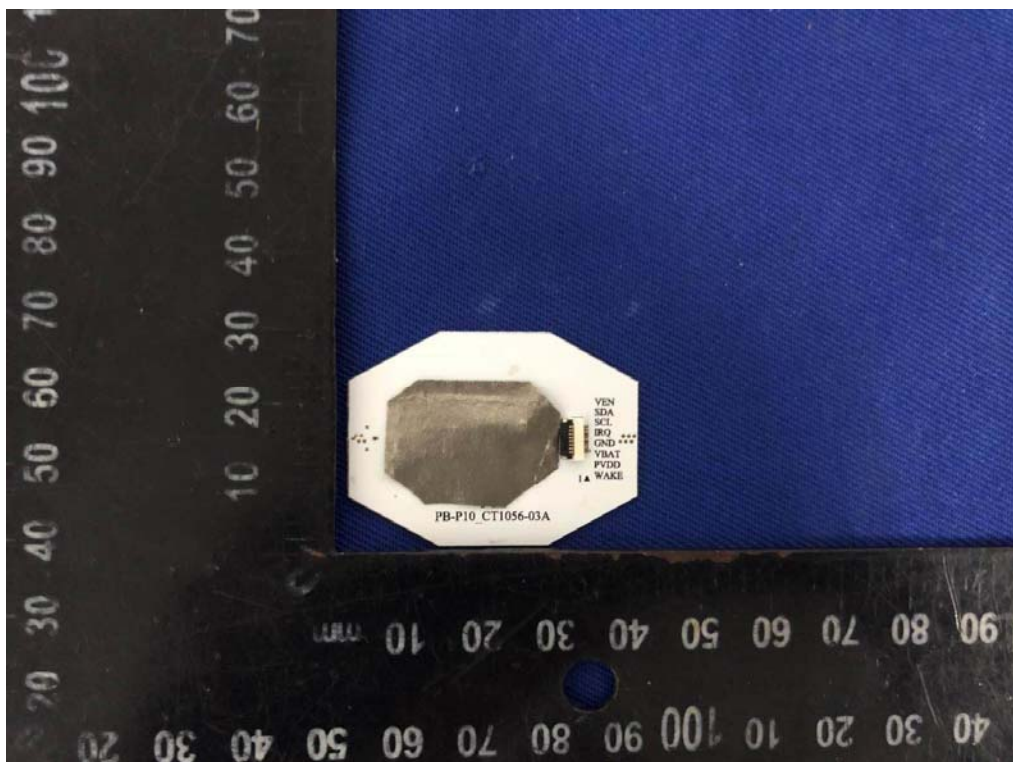
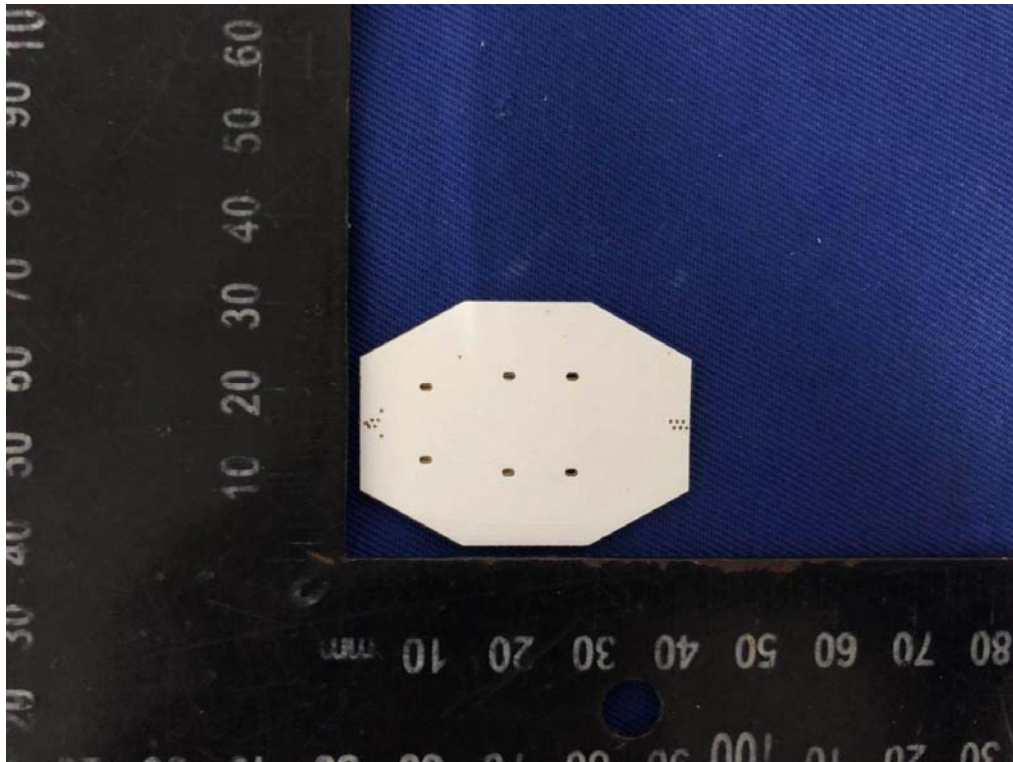

Internal Photos
M/N: VIFA110

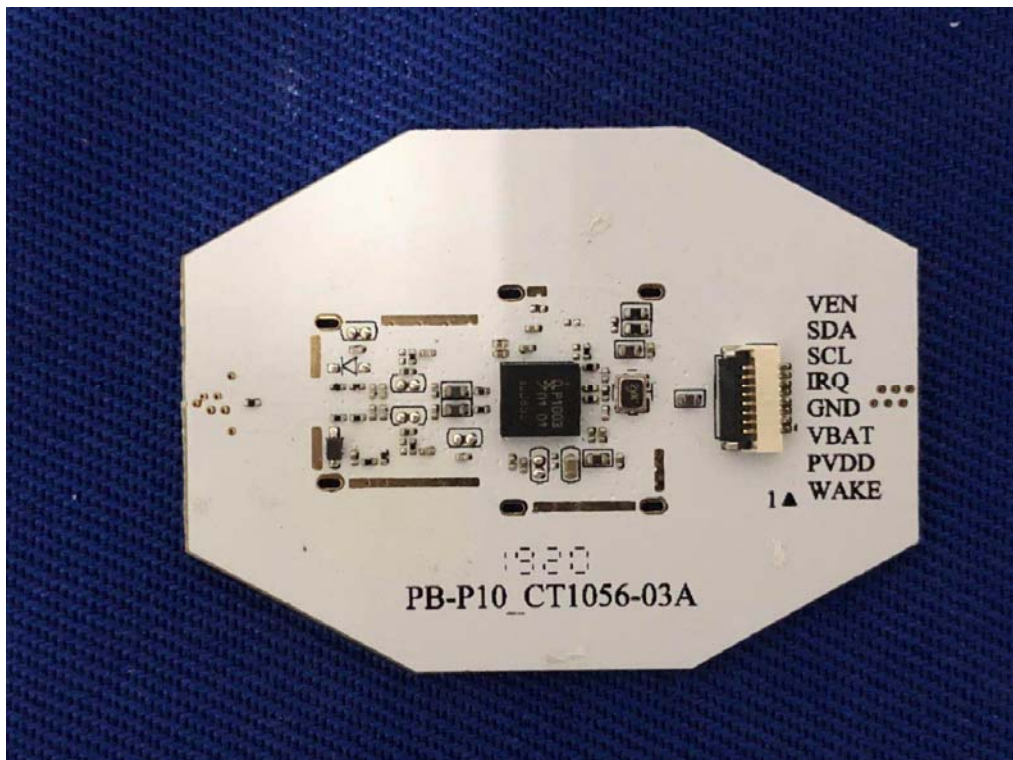
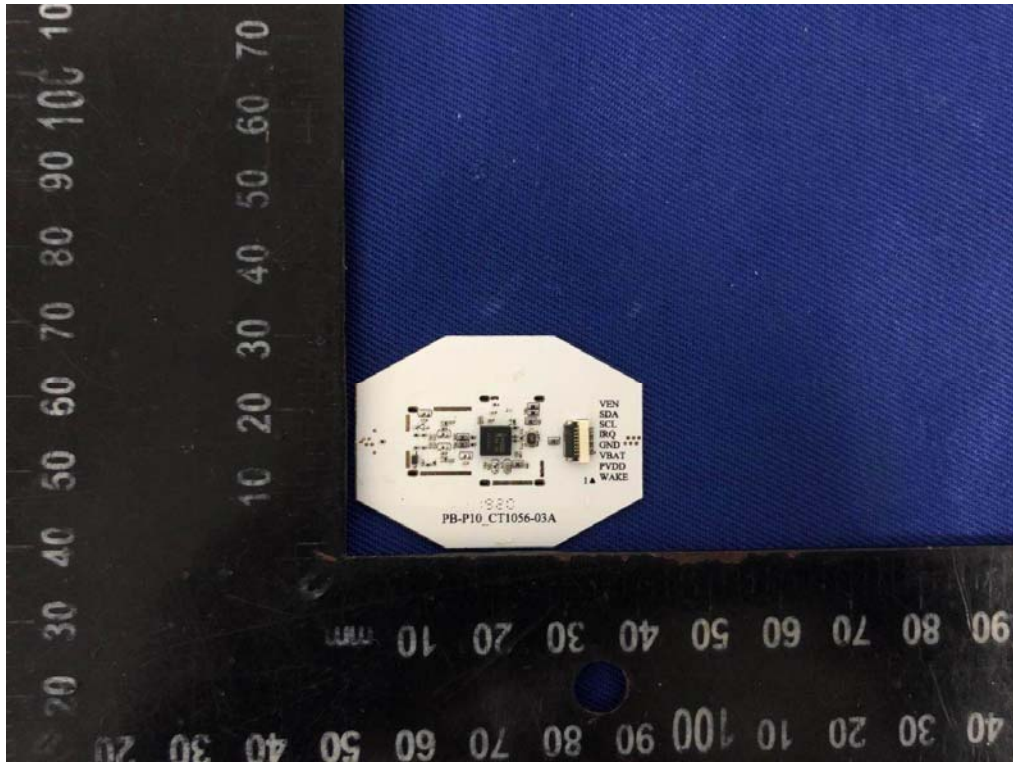

Internal Photos
M/N: VIFA110

NFC
Antenna

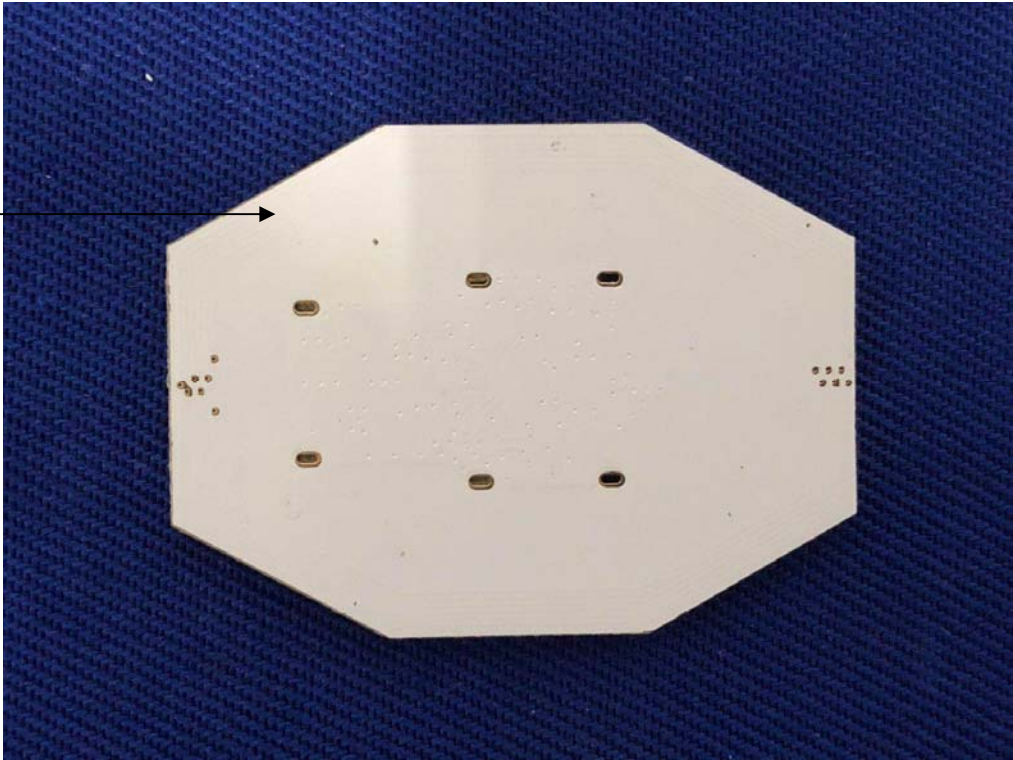

End of Test Report