

TEST REPORT

Applicant:	Guoguang Electric Co., Ltd.
Address of Applicant:	No.8 Jinghu Road, Xinya Street, Huadu Reg, Guangzhou, China
Manufacturer:	Guangzhou Vifa Audio Co., Ltd.
Address of Manufacturer:	Room 401, No.56 fenghuang South Road, Xinya Street, Huadu District, Guangzhou, China
Product name:	VIFA AI Speaker
Model:	VIFA150
Rating(s):	Input: 5V DC, 2A 3.7V DC, 2500mAh/9.25Wh Li-ion Battery
Trademark:	VIFA
Standards:	47 CFR PART 15 Subpart C section 15.247
FCC ID:	2AAP8-VIFA150
Data of Receipt:	2023-08-10
Date of Test:	2023-08-10~2023-08-23
Date of Issue:	2023-08-23
Test Result	Pass*

* In the configuration tested, the test item complied with the standards specified above.

Authorized for issue by:**Test by:**

Aug.23, 2023 Chivas Tsang

Project Engineer

Date

Name/Position

Signature

Reviewed by:

Aug.23, 2023

Victor Meng

Project Manager

Date

Name/Position

Signature



Possible test case verdicts:

test case does not apply to the test object ...: N/A
test object does meet the requirement: P (Pass)
test object does not meet the requirement ..: F (Fail)

Testing Laboratory information:

Testing Laboratory Name: ITL Co., Ltd
Address.....: No. 8, Jinqianling Street 5, Huangjiang Town, Dongguan,
Guangdong, China
Testing location : Same as above
Tel : 0086-769-39001678
Fax : 0086-20-62824387
E-mail : itl@i-testlab.com

General remarks:

The test results presented in this report relate only to the object tested.

The results contained in this report reflect the results for this particular model and serial number. It is the responsibility of the manufacturer to ensure that all production models meet the intent of the requirements detailed within this report.

This report would be invalid test report without all the signatures of testing technician and approver. This report shall not be reproduced, except in full, without the written approval of the Issuing testing laboratory.

General product information:

/

1 Test Summary

Test	Test Requirement	Test method	Result
Antenna Requirement	FCC PART 15 C section 15.247 (c) and Section 15.203	FCC PART 15 C section 15.247 (c) and Section 15.203	PASS
Occupied Bandwidth (-20dB)	FCC PART 15 C section 15.247 (a)(1);	ANSI C63.10:2013	PASS
Carrier Frequencies Separated	FCC PART 15 C section 15.247(a)(1);	ANSI C63.10:2013	PASS
Hopping Channel Number	FCC PART 15 C section 15.247(a)(1)(iii)	ANSI C63.10:2013	PASS
Dwell Time	FCC PART 15 C section 15.247(a)(1)(iii);	ANSI C63.10:2013	PASS
Maximum Peak Output Power	FCC PART 15 C section 15.247(b)(1);	ANSI C63.10:2013	PASS
Conducted Spurious Emission (30 MHz to 25 GHz)	FCC PART 15 C section 15.247(d);	ANSI C63.10:2013	PASS
Radiated Spurious Emission (9 kHz to 25 GHz)	FCC PART 15 C section 15.247(d);	ANSI C63.10:2013	PASS
Band Edges Measurement	FCC PART 15 C section 15.247 (d) &15.205	ANSI C63.10:2013	PASS
Conducted Emissions at Mains Terminals	FCC PART 15 C section 15.207;	ANSI C63.10:2013	PASS
Radiated Emissions which fall in the restricted bands	FCC PART 15 C section 15.209	ANSI C63.10:2013	PASS
Pseudorandom Frequency Hopping Sequence	47 CFR Part 15, Subpart C Section 5.247(b)(4)	ANSI C63.10:2013	PASS

Remark:

N/A: not applicable. Refer to the relative section for the details.
EUT: In this whole report EUT means Equipment Under Test.
Tx: In this whole report Tx (or tx) means Transmitter.
Rx: In this whole report Rx (or rx) means Receiver.
RF: In this whole report RF means Radio Frequency.
ANSI C63.10:2013 the detail version is ANSI C63.10:2013 in the whole report.

2 Contents

	Page
TEST REPORT	1
1 TEST SUMMARY	3
2 CONTENTS	4
3 GENERAL INFORMATION	5
3.1 CLIENT INFORMATION	5
3.2 GENERAL DESCRIPTION OF E.U.T.	5
3.3 DETAILS OF E.U.T.	5
3.4 DESCRIPTION OF SUPPORT UNITS	5
3.5 TEST LOCATION	6
3.6 DEVIATION FROM STANDARDS	6
3.7 ABNORMALITIES FROM STANDARD CONDITIONS	6
3.8 OTHER INFORMATION REQUESTED BY THE CUSTOMER	6
3.9 TEST FACILITY	6
3.10 MEASUREMENT UNCERTAINTY	6
4 INSTRUMENTS USED DURING TEST	7
5 TEST RESULTS	8
5.1 E.U.T. TEST CONDITIONS	8
5.2 ANTENNA REQUIREMENT	10
5.3 OCCUPIED BANDWIDTH	11
5.4 CARRIER FREQUENCIES SEPARATED	18
5.5 HOPPING CHANNEL NUMBER	26
5.6 DWELL TIME	29
5.7 MAXIMUM PEAK OUTPUT POWER	46
5.8 CONDUCTED SPURIOUS EMISSIONS	53
5.9 RADIATED SPURIOUS EMISSIONS	59
5.9.1 Harmonic and other spurious emissions	62
5.10 RADIATED EMISSIONS WHICH FALL IN THE RESTRICTED BANDS	70
5.11 BAND EDGES REQUIREMENT	72
5.12 CONDUCTED EMISSIONS AT MAINS TERMINALS 150 KHZ TO 30 MHZ	79
5.12.1 Measurement Data	81
5.13 OTHER REQUIREMENTS FREQUENCY HOPPING SPREAD SPECTRUM SYSTEM	83

3 General Information

3.1 Client Information

Applicant: Guoguang Electric Co., Ltd.
 Address of Applicant: No.8 Jinghu Road, Xinya Street, Huadu Reg, Guangzhou, China

3.2 General Description of E.U.T.

Name: VIFA AI Speaker
 Model No.: VIFA150
 Operating Frequency: 2402 MHz to 2480 MHz for Bluetooth.
 Channels: 79 channels with 1MHz step for Bluetooth
 Bluetooth Version: 4.2
 Bluetooth Version: This report is for classic mode.
 Modulation Technique: Frequency Hopping Spread Spectrum (FHSS)
 Type of Modulation: GFSK, ($\pi/4$) DQPSK, 8DPSK for Bluetooth
 Dwell time: Per channel is less than 0.4s.
 Antenna Type: PCB Antenna
 Antenna gain: 2.23 dBi

3.3 Details of E.U.T.

EUT Power Supply: AC 120V 60Hz (For Adapter)
 Test mode: The program used to control the EUT for staying in continuous transmitting and receiving mode is programmed. Channel lowest (2402MHz), middle (2441MHz) and highest (2480MHz) are chosen for Bluetooth full testing.
 Normal mode: the Bluetooth has been tested on the Modulation of GFSK;
 EDR mode: the Bluetooth has been tested on the Modulation of ($\pi/4$)DQPSK and 8DPSK, compliance test and record the worst case on ($\pi/4$)DQPSK and 8DPSK
 Power cord: /
 Note:
 Bluetooth LE, BDR/EDR and WiFi can transmit simultaneously and the report covers simultaneous transmission mode. Only the worst-case test results are provided in this test report.

3.4 Description of Support Units

The EUT has been tested as an independent unit for fixed frequency by testing lab.

Details of Support Equipment(s)

Description	Manufacturer	Model No.	Connection	Working state
Adapter	UGREEN	CD122	/	Normal

3.5 Test Location

All the tests were performed in ITL Co., Ltd. Which is located at No. 8, Jinqianling Street 5, Huangjiang Town, Dongguan, Guangdong, China.

Tel: 0086-769-39001678, Fax: 0086-20-62824387

No tests were sub-contracted.

3.6 Deviation from Standards

None.

3.7 Abnormalities from Standard Conditions

None.

3.8 Other Information Requested by the Customer

None.

3.9 Test Facility

The test facility is recognized, certified, or accredited by the following organizations:

- CNAS Lab code:L9342
- FCC Designation No.:CN5035
- IC Registration NO.: 12593A
- NVLAP LAB CODE: 600199-0

3.10 Measurement Uncertainty

The below measurement uncertainties given below are based on a 95% confidence level (base on a coverage factor (k=2).)

Parameter	Uncertainty
Radio frequency	2.25%
total RF power, conducted	±1.34 dB
RF power density , conducted	±1.49 dB
All emissions, radiated	±2.72 dB
Temperature	±5.02 dB
Humidity	±0.8°C
DC and low frequency voltages	±1.5 %

4 Instruments Used during Test

No.	Test Equipment	Manufacturer	Model	Serial No.	Last Cal.	Cal. Due
ITL-114	Spectrum Analyzer	Agilent	N9010A	MY51250936	2023/01/13	2024/01/14
ITL-154	EMI test receiver 9kHz to 26.5GHz	R&S	ESR26	101257	2023/01/07	2024/01/06
ITL-116	Pre Amplifier	HP	8447F	3113A05905	2023/01/07	2024/01/06
ITL-117	Wideband Amplifier Super Ultra	Mini-circuits	ZVA-183- S+	469101134	2022/10/14	2023/10/13
ITL-164	Trilog-Broadband Antenna	Schwarzbeck	VULB 9168	9168-0844	2022/11/20	2024/11/19
ITL-110	Horn Antenna	A-INFOMW	JXTXLB- 10180-N	J2031090612 133	2022/06/17	2024/06/16
ITL-103	Two-line v- network	R&S	ENV216	100120	2023/06/14	2024/06/13
ITL-115	50Ω Coaxial Cable	Mini-ci cu ts	CBL	C001	2022/06/24	2024/06/23
ITL-100	Semi-Anechoic chamber	ETS•Lindgren	FACT3 2.0	CT09015	2022/10/14	2025/10/13
ITL-145	Loop Antenna	ZHINAN	Z 30900 A	00 489	2022/06/16	2024/06/15
ITL-146	Horn Antenna	Schwarzb ck	BBHA 9170	B09806543	2022/06/17	2024/06/16
ITL-101	Shielded Room	ETS•Lindgren	8*4*3	CT09010	2021/01/22	2024/01/21
ITL-166	Power Sensor	Agilent	U2021XA	MY5365004	2023/01/14	2024/01/13

5 Test Results

5.1 E.U.T. test conditions

Test Voltage: Input: AC 120V 60HZ

Temperature: 20.0 -25.0 °C

Humidity: 38-50 % RH

Atmospheric Pressure: 1000 -1010 mbar

Test frequencies and frequency range: According to the 15.31(m) Measurements on intentional radiators or receivers, other than TV broadcast receivers, shall be performed and, if required, reported for each band in which the device can be operated with the device operating at the number of frequencies in each band specified in the following table:

According to the 15.33 (a) For an intentional radiator, the spectrum shall be investigated from the lowest radio frequency signal generated in the device, without going below 9 kHz, up to at least the frequency shown in the following table:

Number of fundamental frequencies to be tested in EUT transmit band

Frequency range in which	Number of frequencies	Location in frequency range of operation
1 MHz or less	1	Middle
1 MHz to 10 MHz	2	1 near top and 1 near bottom
More than 10 MHz	3	1 near top, 1 near middle and 1 near bottom

Frequency range of radiated emission measurements

Lowest frequency generated	Upper frequency range of measurement
9 kHz to below 10 GHz	10th harmonic of highest fundamental frequency or to 40 GHz,
At or above 10 GHz to below	5th harmonic of highest fundamental frequency or to 100 GHz,
At or above 30 GHz	5th harmonic of highest fundamental frequency or to 200 GHz,

EUT channels and frequencies list for Bluetooth:

Channel	Frequency (MHz)	Channel	Frequency (MHz)	Channel	Frequency (MHz)
0	2402	11	2413	22	2424
1	2403	12	2414	23	2425
2	2404	13	2415	24	2426
3	2405	14	2416	25	2427
4	2406	15	2417	26	2428
5	2407	16	2418	27	2429
6	2408	17	2419	28	2430
7	2409	18	2420	29	2431
8	2410	19	2421	30	2432
9	2411	20	2422	31	2433
10	2412	21	2423	32	2434
33	2435	49	2451	65	2467
34	2436	50	2452	66	2468
35	2437	51	2453	67	2469
36	2438	52	2454	68	2470
37	2439	53	2455	69	2471
38	2440	54	2456	70	2472
39	2441	55	2457	71	2473
40	2442	56	2458	72	2474
41	2443	57	2459	73	2475
42	2444	58	2460	74	2476
43	2445	59	2461	75	2477
44	2446	60	2462	76	2478
45	2447	61	2463	77	2479
46	2448	62	2464	78	2480
47	2449	63	2465		
48	2450	64	2466		

Test frequencies are the lowest Channel: 0 channel (2402 MHz), middle Channel: 39 channel (2441 MHz) and highest Channel: 78 channel (2480 MHz)

5.2 Antenna requirement

Standard requirement

15.203 requirement:

For intentional device. According to 15.203, an intentional radiator shall be designed to ensure that no antenna other than that furnished by the responsible party shall be used with the device.

15.247(c) (1)(i) requirement:

(i) Systems operating in the 2400-2483.5 MHz bands that are used exclusively for fixed. Point-to-point operations may employ transmitting antennas with directional gain greater than 6 dBi provided the maximum conducted output power of the intentional radiator is reduced by 1 dB for every 3 dB that the directional gain of the antenna exceeds 6 dBi.

EUT Antenna

The antenna is a PCB Antenna and no consideration of replacement. The best case gain of the antenna is 2.23 dBi.

Test result: The unit does meet the FCC requirements.

5.3 Occupied Bandwidth

Test Requirement: FCC Part 15 C section 15.247

(a)(1) Frequency hopping systems shall have hopping channel carrier frequencies separated by a minimum of 25 kHz or the 20 dB bandwidth of the hopping channel, whichever is greater. Alternatively, frequency hopping systems operating in the 2400-2483.5 MHz band may have hopping channel carrier frequencies that are separated by 25 kHz or two-thirds of the 20 dB bandwidth of the hopping channel, whichever is greater, provided the systems operate with an output power no greater than 125 mW.

Test Method: ANSI C63.10:2013

Test Status: Pre-test the EUT in continuous transmitting mode at the lowest, middle and highest channel with different data package. Compliance test in normal mode (DH5), EDR mode (2DH5) and EDR mode (3DH5) as the worst case was found.

Test Configuration:

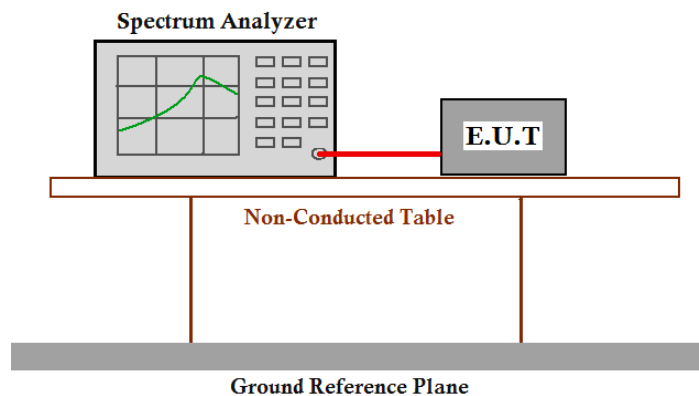

Test Procedure:

1. Remove the antenna from the EUT and then connect a low RF cable from the antenna port to the spectrum;
2. Set the spectrum analyzer: Span = approximately 2 to 3 times the 20dB bandwidth, centring on a hopping channel;
3. Set the spectrum analyzer: RBW \geq 1% of the 20dB bandwidth VBW \geq RBW. Sweep = auto; Detector Function = Peak. Trace = Max Hold.
4. Mark the peak frequency and -20dB points bandwidth.

Test result (-20dB bandwidth), For Bluetooth**Normal mode (DH5):**

Test Channel	Bandwidth(MHz)	2/3 bandwidth(MHz)
Lowest	0.954	0.636
Middle	0.939	0.626
Highest	0.940	0.627

EDR mode (2DH5):

Test Channel	Bandwidth(MHz)	2/3 bandwidth(MHz)
Lowest	1.275	0.850
Middle	1.287	0.858
Highest	1.344	0.896

EDR mode (3DH5):

Test Channel	Bandwidth(MHz)	2/3 bandwidth(MHz)
Lowest	1.294	0.863
Middle	1.285	0.857
Highest	1.289	0.859

For Bluetooth
Result plot as follows:

DH5:

Lowest Channel:

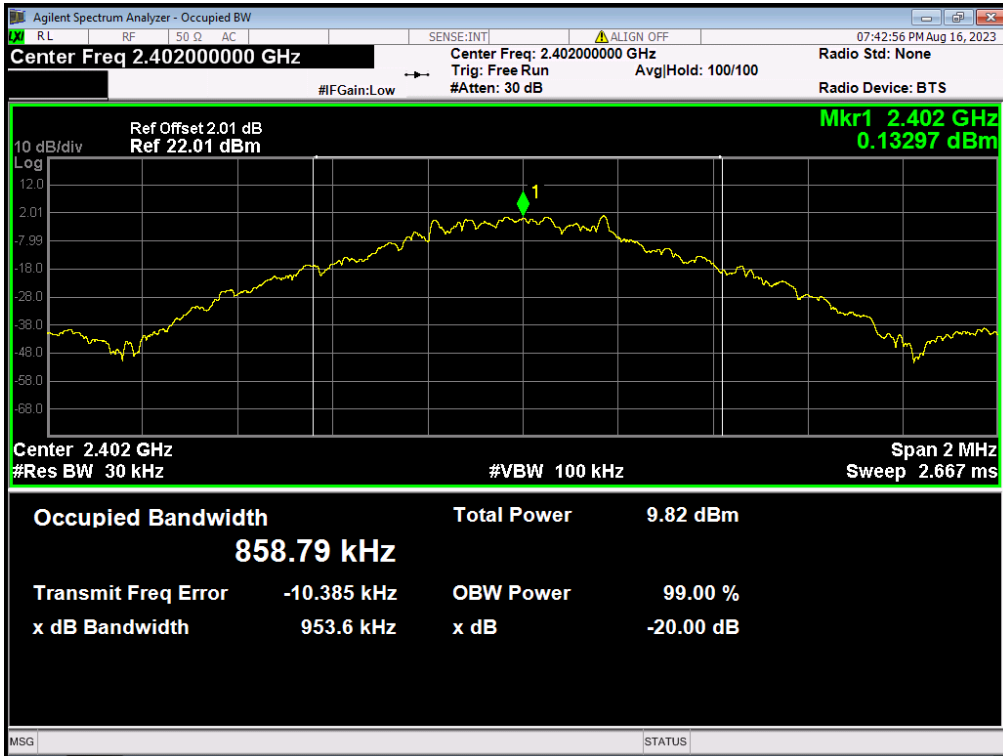

Middle Channel:

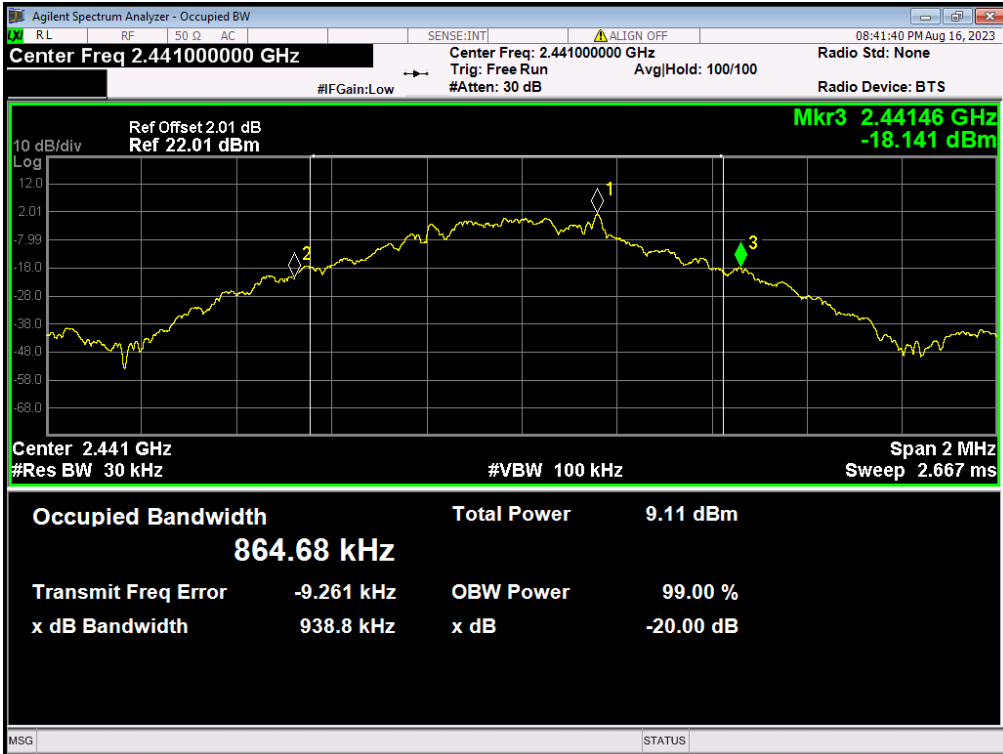

Highest Channel:

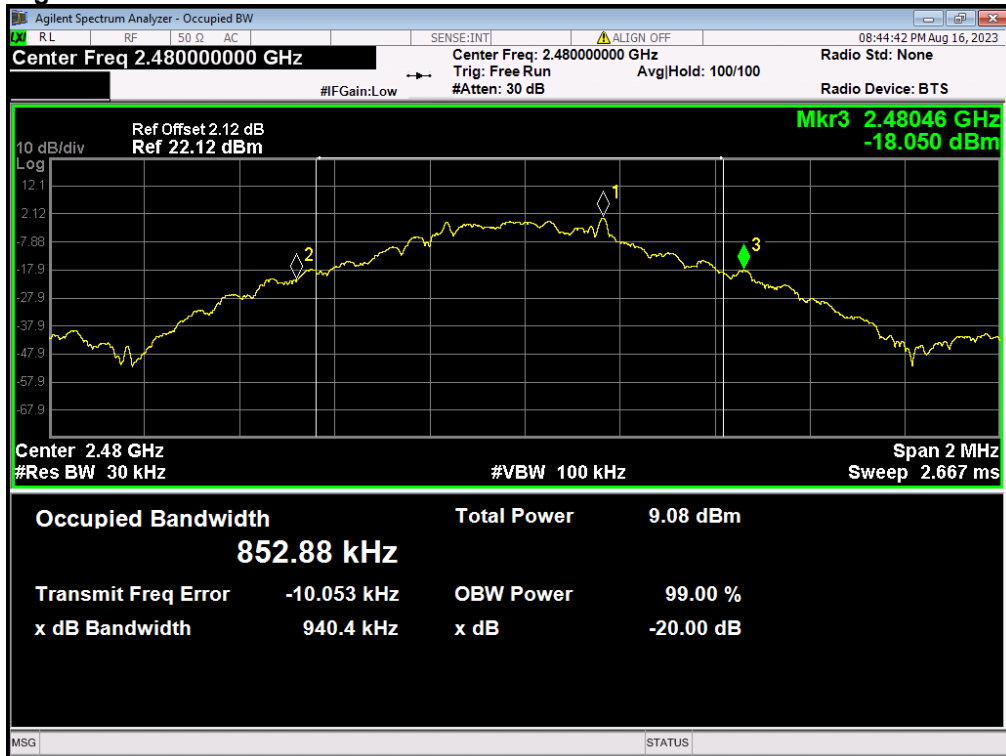

2DH5:

Lowest Channel:

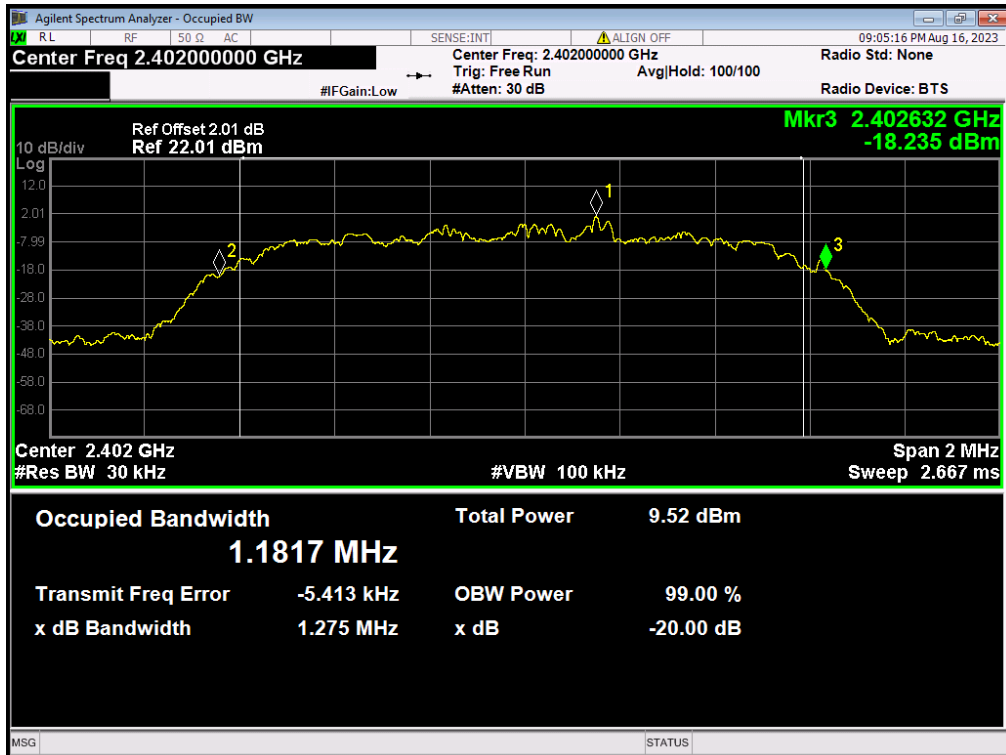

Middle Channel:

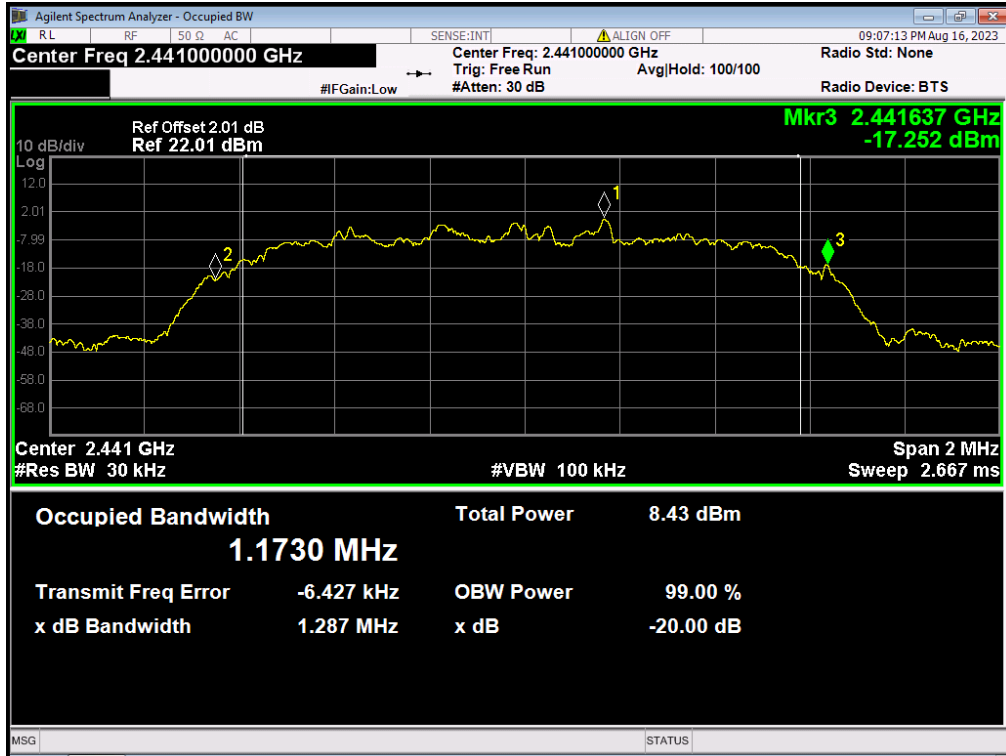

Highest Channel:

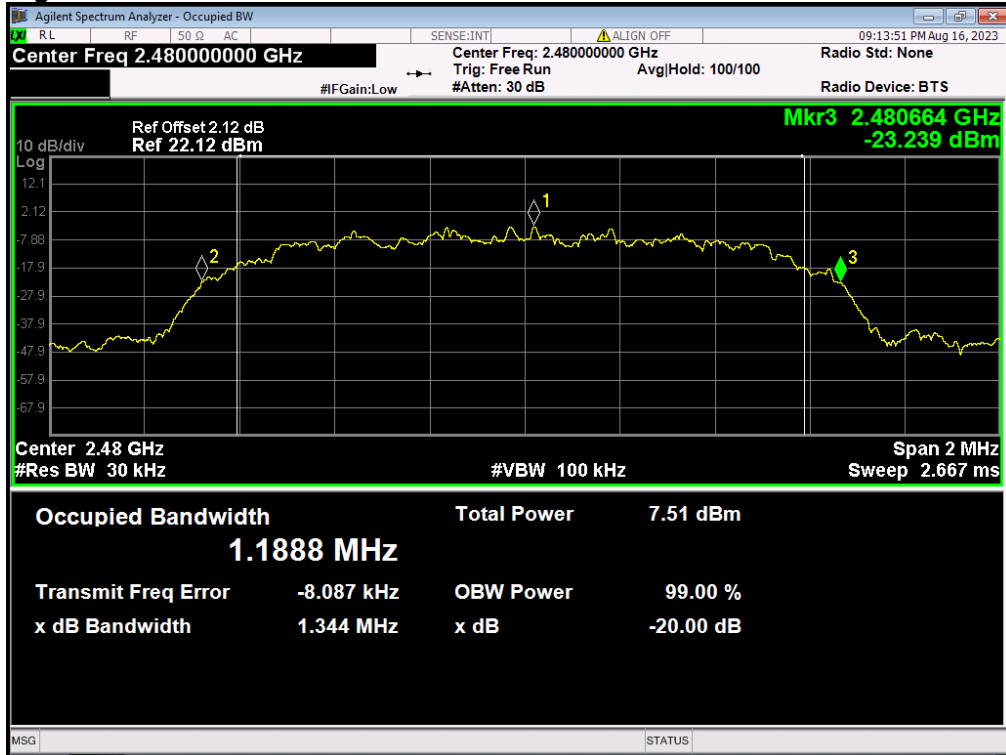

3DH5:

Lowest Channel:

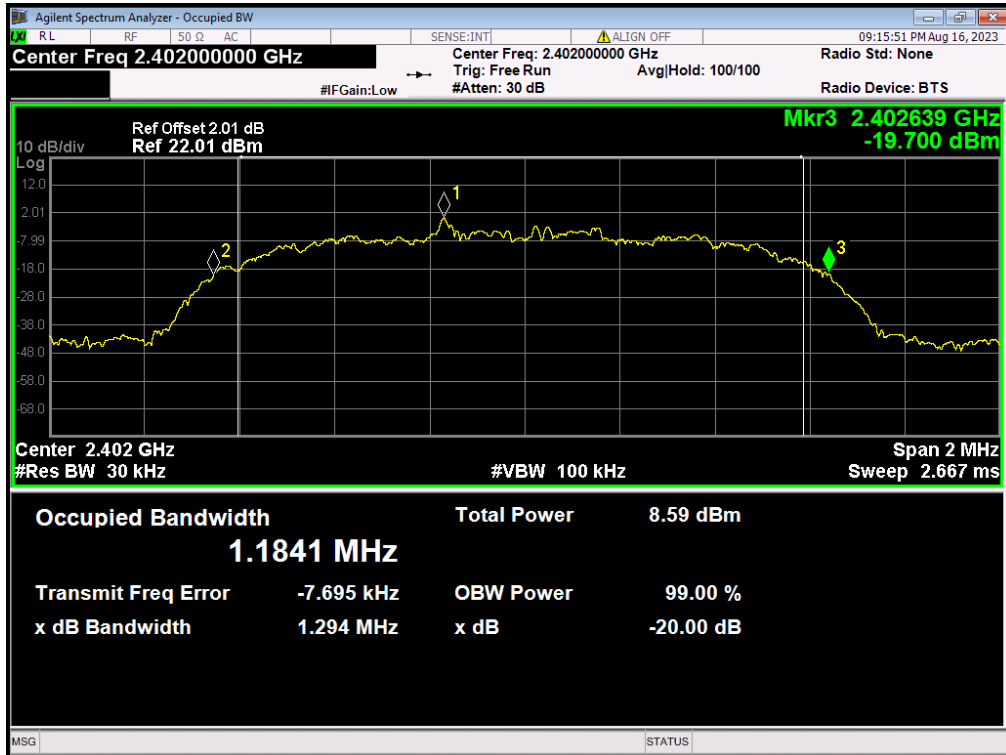

Middle Channel:

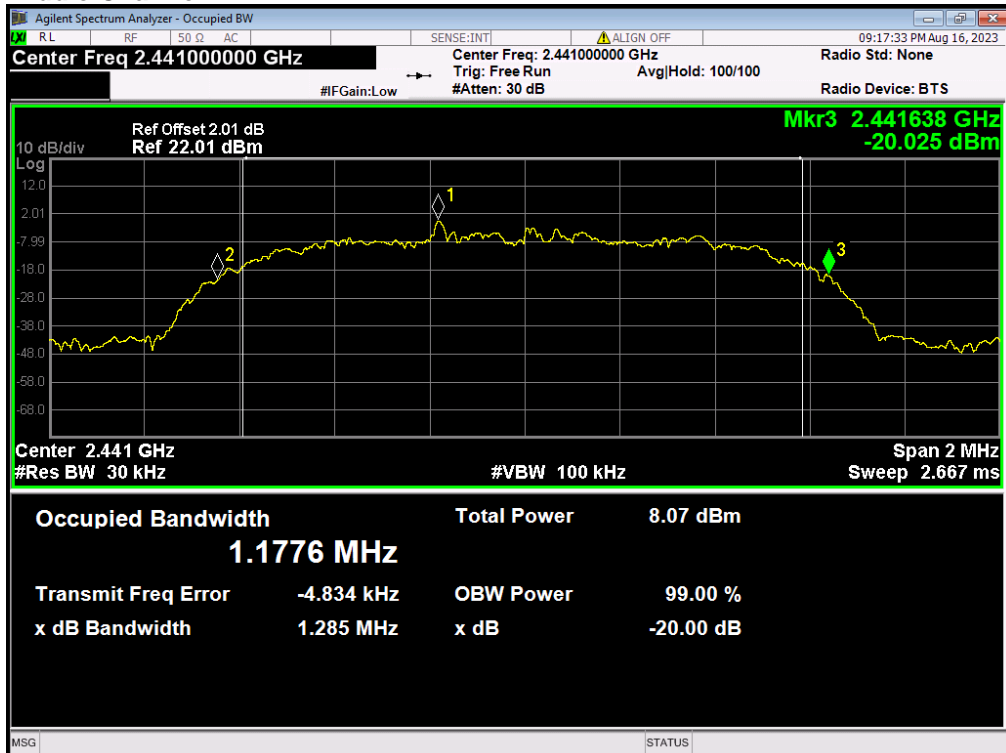

Highest Channel:

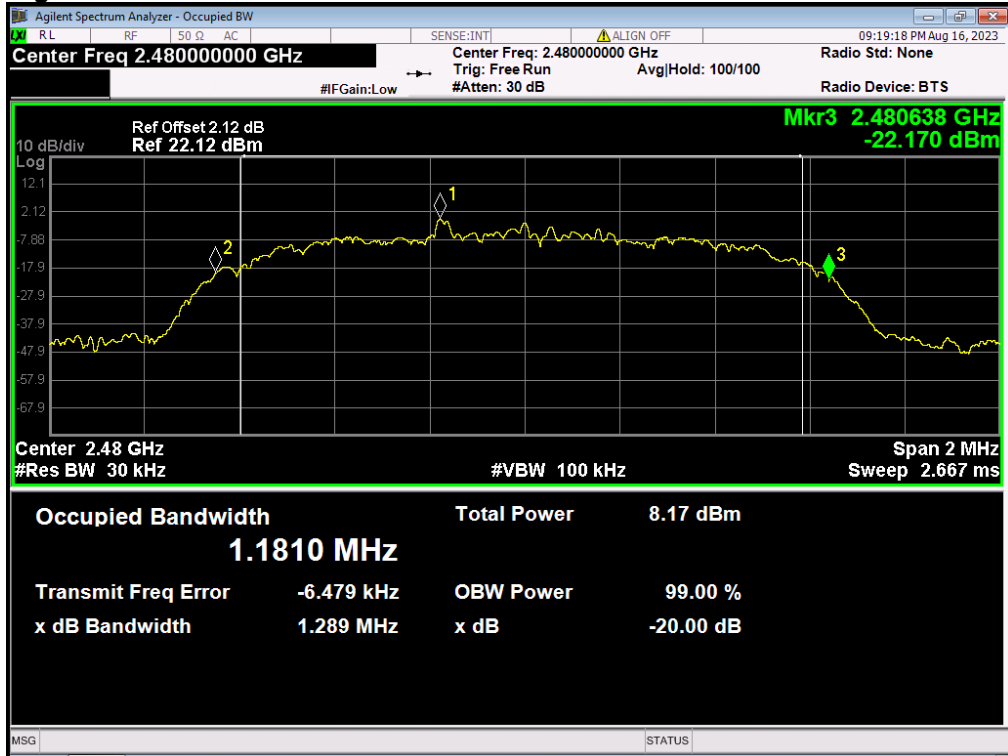

5.4 Carrier Frequencies Separated

Test Requirement: FCC Part 15 C section 15.247

(a),(1) Frequency hopping systems shall have hopping channel carrier frequencies separated by a minimum of 25 kHz or the 20 dB bandwidth of the hopping channel, whichever is greater. Alternatively, frequency hopping systems operating in the 2400-2483.5 MHz band may have hopping channel carrier frequencies that are separated by 25 kHz or two-thirds of the 20 dB bandwidth of the hopping channel, whichever is greater, provided the systems operate with an output power no greater than 125 mW.

Test Method: ANSI C63.10:2013

Test Status: Pre-test the EUT in continuous transmitting mode at the lowest, middle and highest channel with different data package. Compliance test in normal mode (DH5), EDR mode (2DH5) and EDR mode (3DH5) as the worst case was found.

Test Configuration:

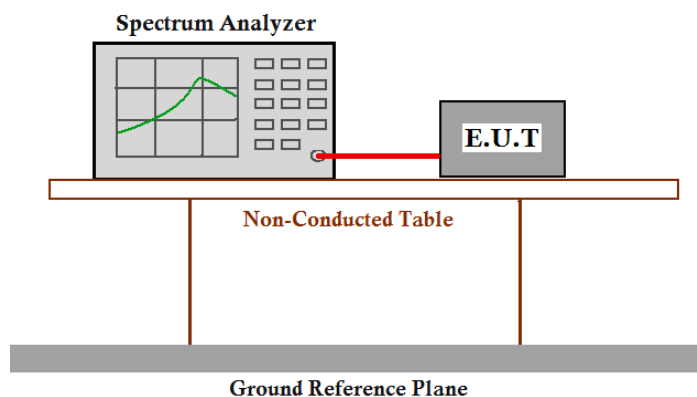

Test Procedure:

1. Remove the antenna from the EUT and then connect a low attenuation RF cable from the antenna port to the spectrum.
2. Set the spectrum analyzer: RBW \geq 1% of the span, VBW \geq RBW, Sweep = auto; Detector Function = Peak. Trace = Max, hold.
3. Allow the trace to stabilize. Use the marker-delta function to determine the separation between the peaks of the adjacent channels. The limit is specified in one of the subparagraphs of this Section. Submit this plot.

Test result:**For Bluetooth****DH5**

Test Channel	Carrier Frequencies Separated(MHz)	Pass/Fail
Lower Channels (channel 0 and channel 1)	1.002	Pass
Middle Channels (channel 39 and channel 40)	1.089	Pass
Upper Channels (channel 77 and channel 78)	1.029	Pass
Remark: The limit is maximum two-thirds of the 20 dB bandwidth: 0.636 MHz		

2DH5

Test Channel	Carrier Frequencies Separated(MHz)	Pass/Fail
Lower Channels (channel 0 and channel 1)	0.993	Pass
Middle Channels (channel 39 and channel 40)	0.912	Pass
Upper Channels (channel 77 and channel 78)	0.930	Pass
Remark: The limit is maximum two-thirds of the 20 dB bandwidth: 0.896 MHz		

3DH5

Test Channel	Carrier Frequencies Separated(MHz)	Pass/Fail
Lower Channels (channel 0 and channel 1)	1.134	Pass
Middle Channels (channel 39 and channel 40)	0.900	Pass
Upper Channels (channel 77 and channel 78)	1.005	Pass
<p>Remark:</p> <p>The limit is maximum two-thirds of the 20 dB bandwidth: 0.863 MHz</p>		

5.5 Hopping Channel Number

Test Requirement: FCC Part15 C section 15.247
(a)(1)(iii) Frequency hopping systems in the 2400-2483.5 MHz band shall use at least 15 channels.

Test Method: ANSI C63.10:2013

Test Status: Pre-test the EUT in hopping mode with different data packet. Compliance test in hopping with normal mode (DH5), EDR mode (2DH5) and EDR mode (3DH5) as the worst case was found.

Test Configuration:

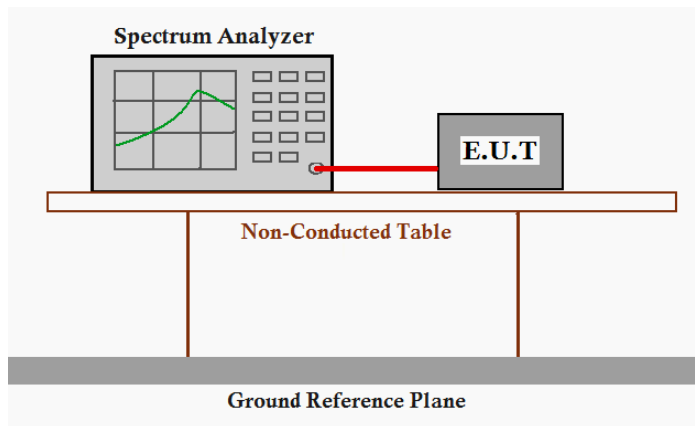

Test Procedure:

1. Remove the antenna from the EUT and then connect a low attenuation RF cable from the antenna port to the spectrum.
2. Set the spectrum analyzer: RBW = 100 kHz. VBW = 300 kHz. Sweep = auto; Detector Function = Peak. Trace = Max hold.
3. Allow the trace to stabilize. It may prove necessary to break the span up to sections. in order to clearly show all of the hopping frequencies. The limit is specified in one of the subparagraphs of this Section.
4. Set the spectrum analyzer: start frequency = 2400 MHz. stop frequency = 2483.5 MHz. Submit the test result graph.

For Bluetooth

Test result: Total channels are 79 Channels.

DH5:

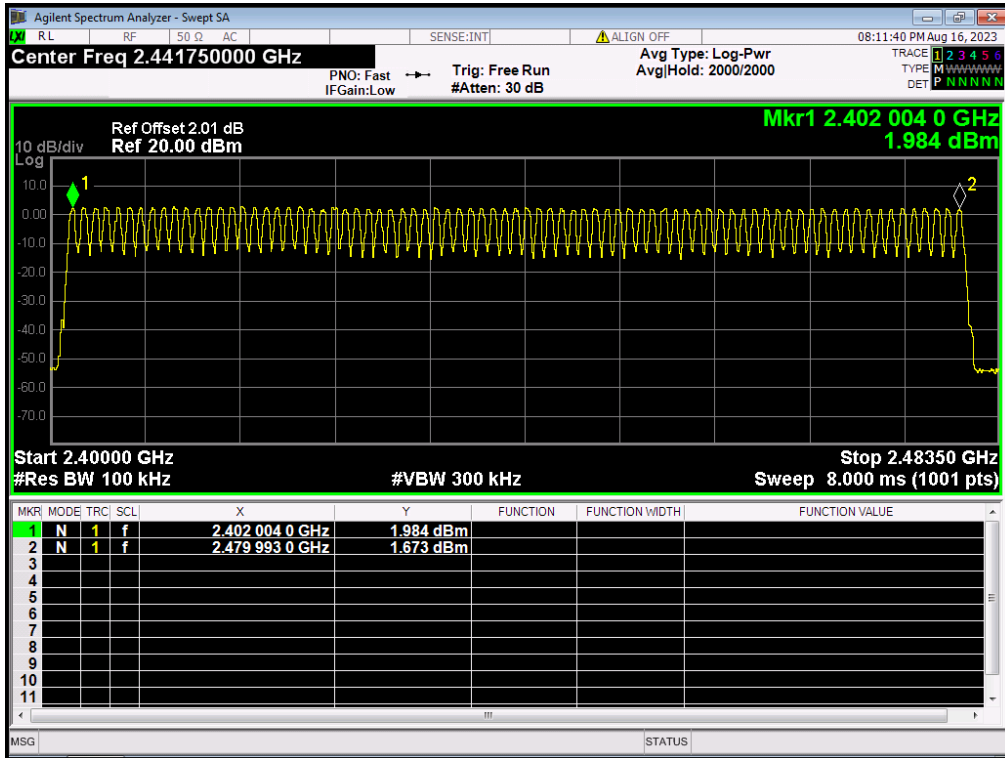

2DH5:

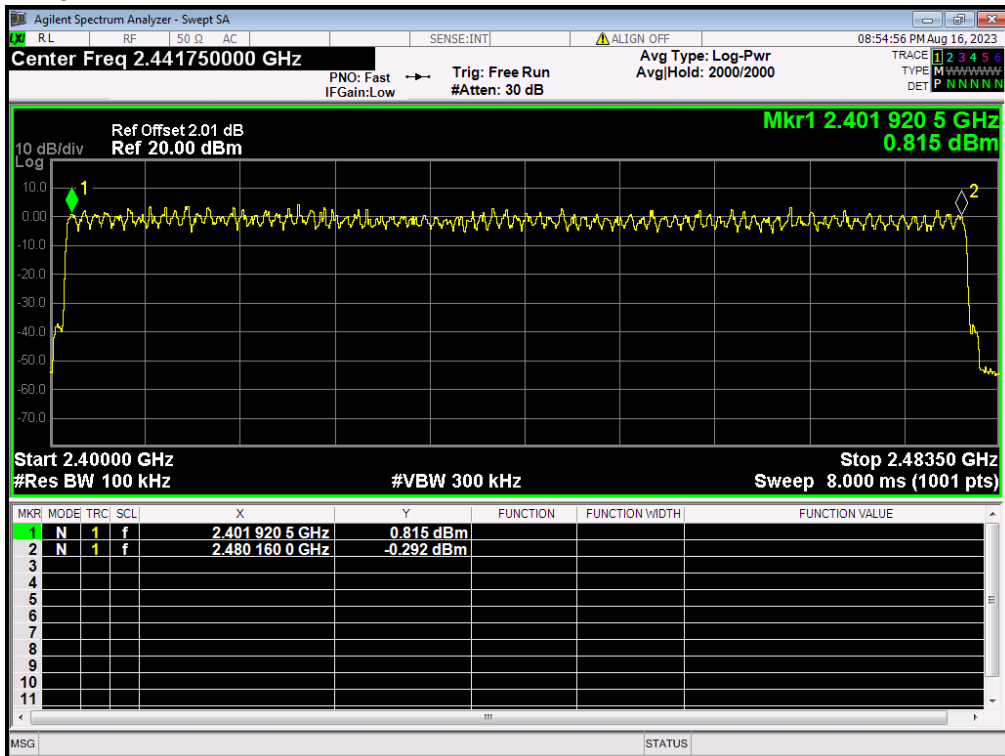

3DH5:

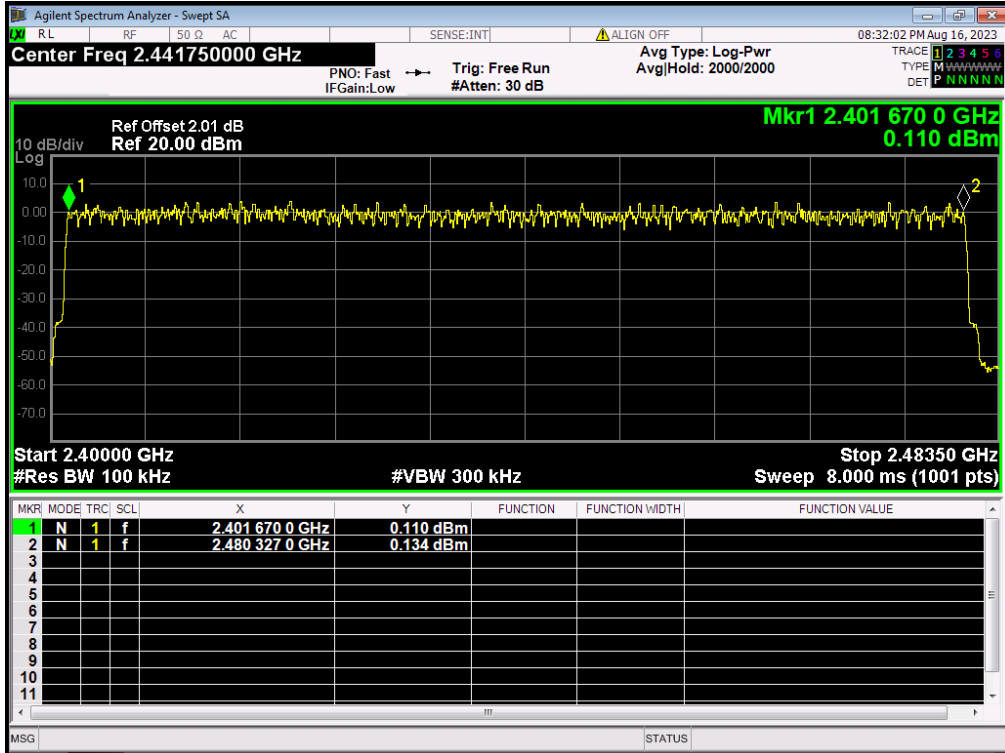

Test result: The unit does meet the FCC requirements.

5.6 Dwell Time

Test Requirement: FCC Part 15 C section 15.247

(a)(1)(iii) Frequency hopping systems in the 2400-2483.5 MHz band shall use at least 15 channels. The average time of occupancy on any channel shall not be greater than 0.4 seconds within a period of 0.4 seconds multiplied by the number of hopping channels employed. Frequency hopping systems may avoid or suppress transmissions on a particular hopping frequency provided that a minimum of 15 channels are used.

Test Method: ANSI C63.10:2013

Test Status: Pre-test the EUT in continuous transmitting mode at the lowest, middle and highest channel with different data packet. Compliance test in hopping with Normal mode (DH1, DH3 and DH5) and EDR mode (2DH1, 2DH3 and 2DH5; 3DH1, 3DH3 and 3DH5) as the worst case was found.

Test Configuration:

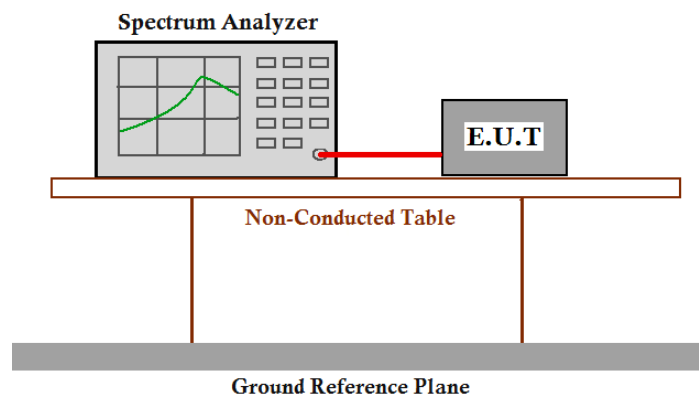

Test Procedure:

1. Remove the antenna from the EUT and then connect a low attenuation RF cable from the antenna port to the spectrum.
 2. Set spectrum analyzer span = 0. centered on a hopping channel;
 3. Set RBW = 1 MHz and VBW = 3 MHz. Sweep = as necessary to capture the entire dwell time per hopping channel. Detector Function = Peak. Trace = View;
 4. Use the marker-delta function to determine the dwell time. If this value varies with different modes of operation (e.g.. data rate. modulation format. etc.). Repeat this test for each variation.
- The limit is specified in one of the subparagraphs of this Section. Submit this plot(s). An oscilloscope may be used instead of a spectrum analyzer.

Test Result:

1-DH1: 2402

Mode	Frequency (MHz)	Pulse Time (ms)	Total Dwell Time (ms)	Period Time (ms)	Limit (ms)	Verdict
1-DH1	2402	0.382	122.24	31600	400	Pass

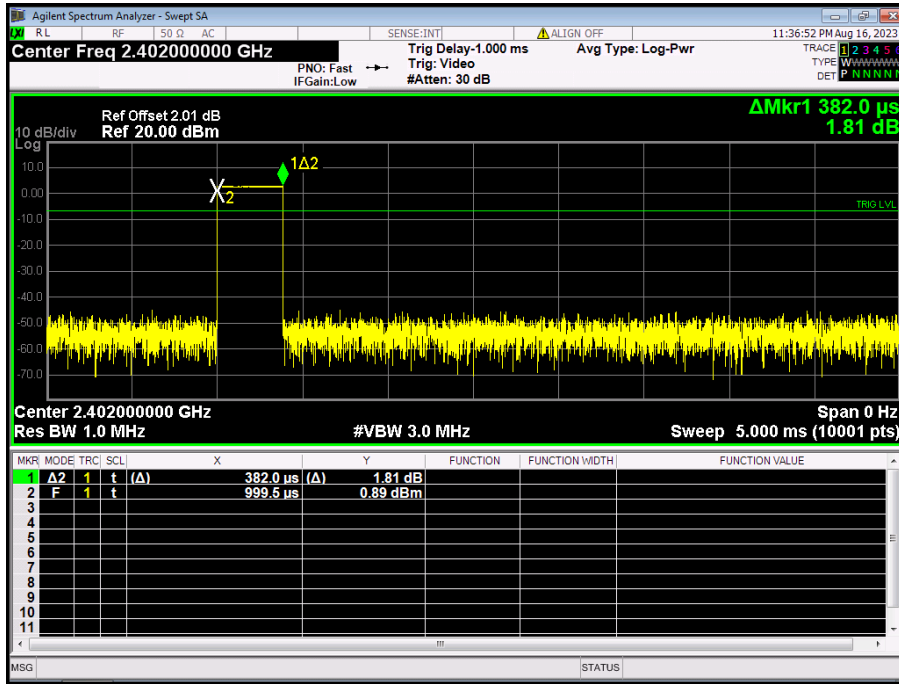

1-DH1 : 2441

Mode	Frequency (MHz)	Pulse Time (ms)	Total Dwell Time (ms)	Period Time (ms)	Limit (ms)	Verdict
1-DH1	2441	0.383	122.56	31600	400	Pass

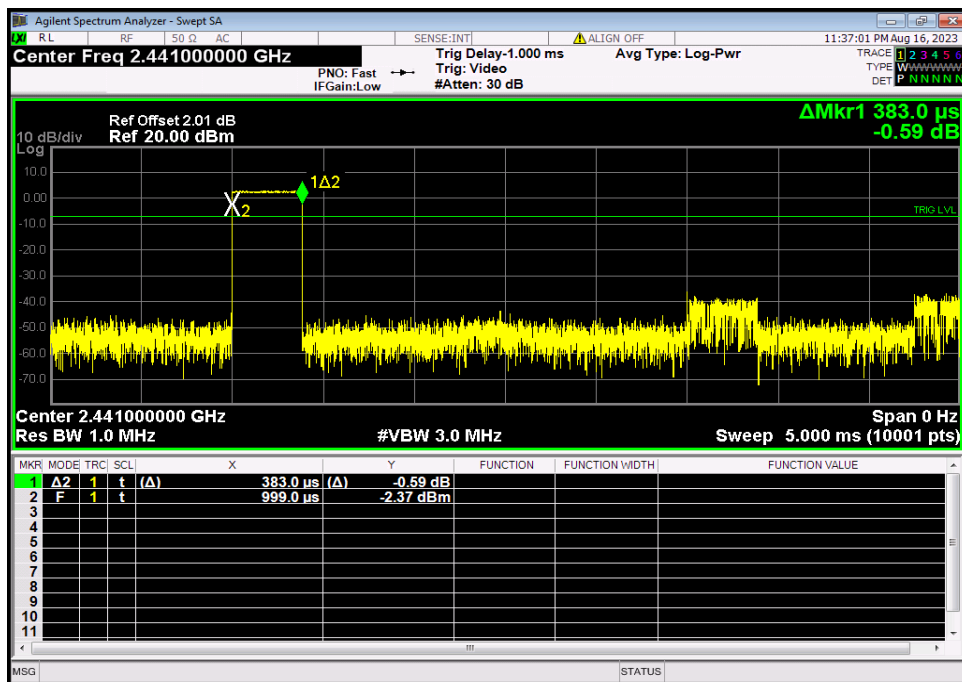

1-DH1 : 2480

Mode	Frequency (MHz)	Pulse Time (ms)	Total Dwell Time (ms)	Period Time (ms)	Limit (ms)	Verdict
1-DH1	2480	0.383	122.56	31600	400	Pass

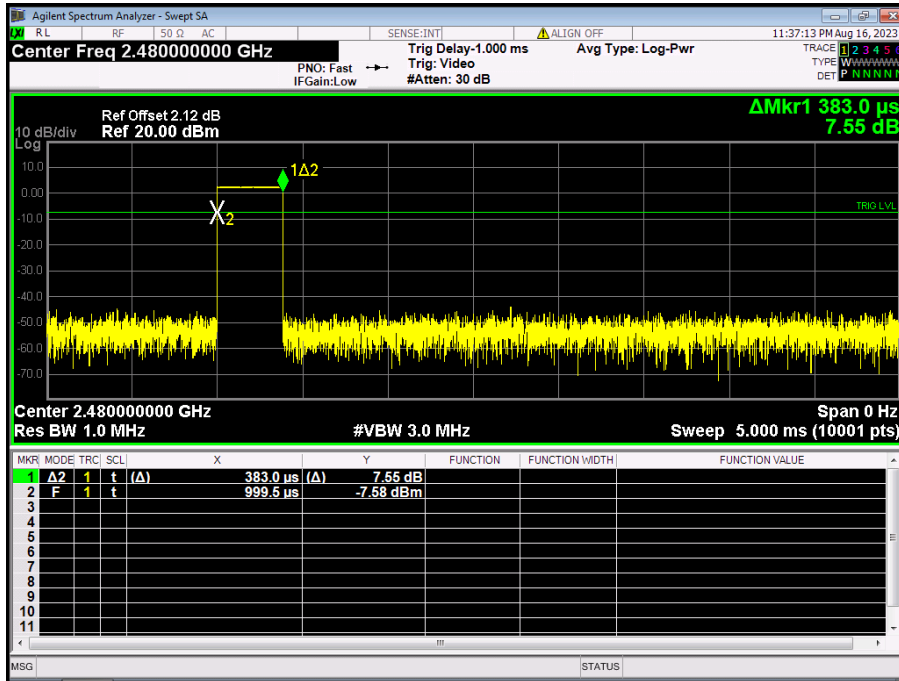

1-DH3 : 2402

Mode	Frequency (MHz)	Pulse Time (ms)	Total Dwell Time (ms)	Period Time (ms)	Limit (ms)	Verdict
1-DH3	2402	1.639	262.24	31600	400	Pass

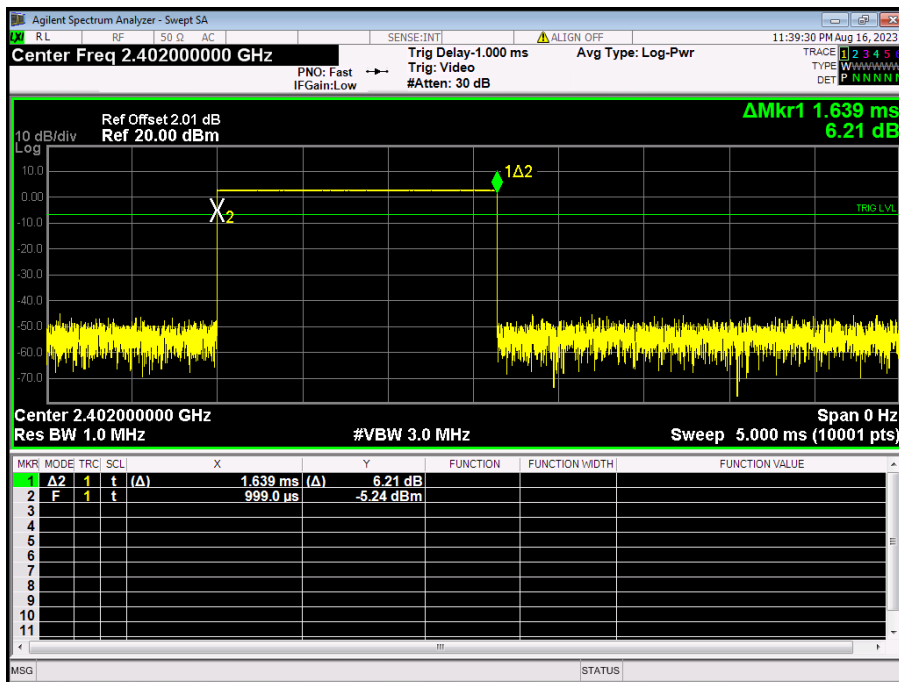

1-DH3 : 2441

Mode	Frequency (MHz)	Pulse Time (ms)	Total Dwell Time (ms)	Period Time (ms)	Limit (ms)	Verdict
1-DH3	2441	1.639	262.24	31600	400	Pass

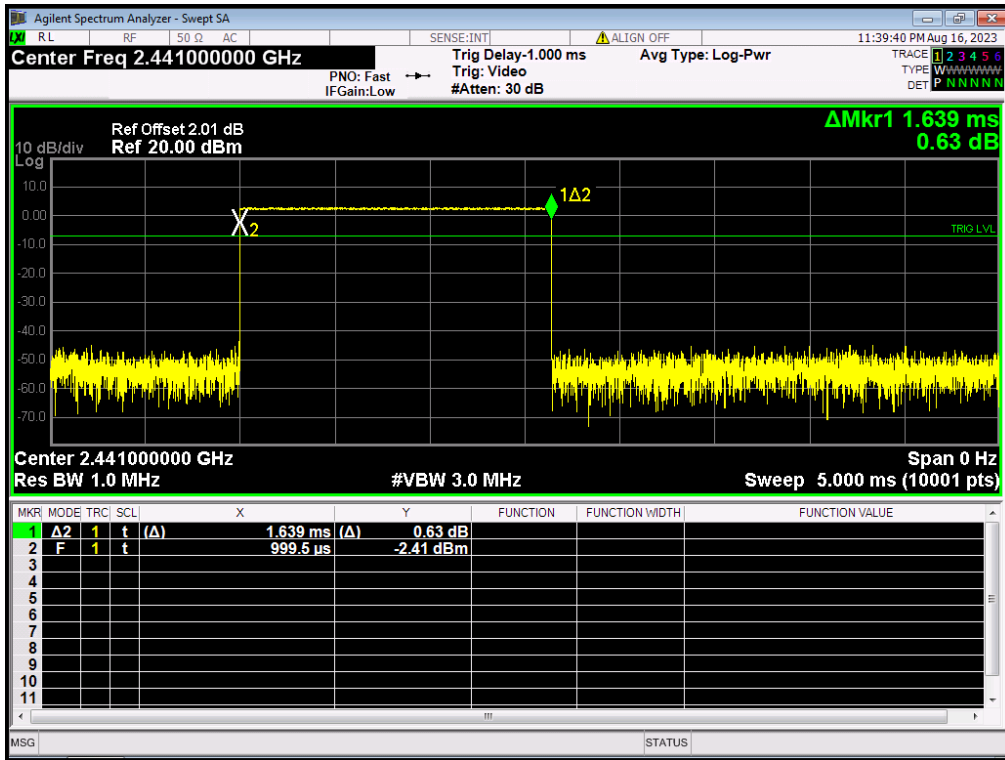

1-DH3 : 2480

Mode	Frequency (MHz)	Pulse Time (ms)	Total Dwell Time (ms)	Period Time (ms)	Limit (ms)	Verdict
1-DH3	2480	1.639	262.24	31600	400	Pass

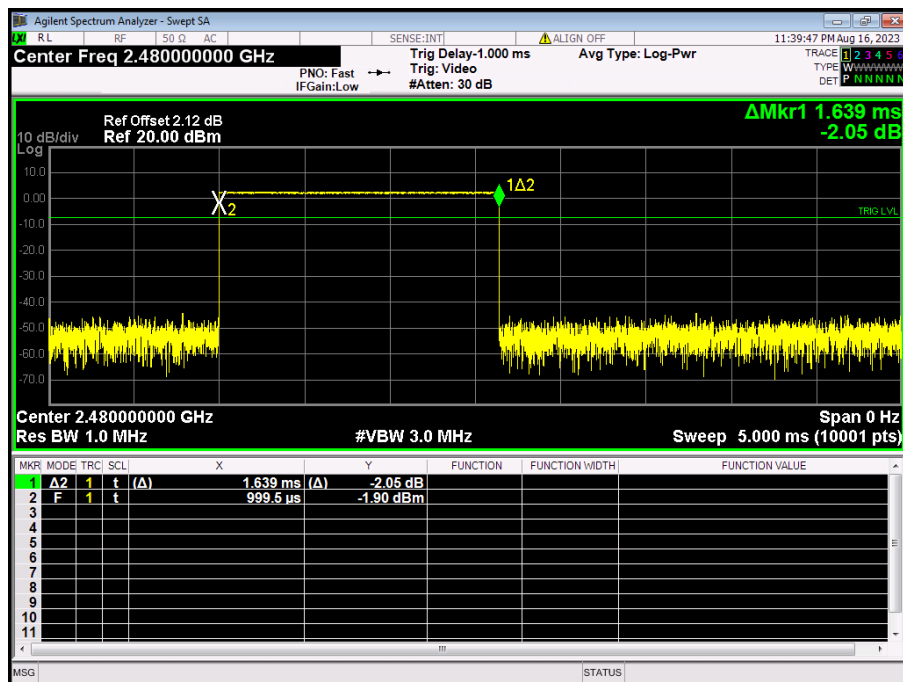

1-DH5 : 2402

Mode	Frequency (MHz)	Pulse Time (ms)	Total Dwell Time (ms)	Period Time (ms)	Limit (ms)	Verdict
1-DH5	2402	2.887	307.947	31600	400	Pass

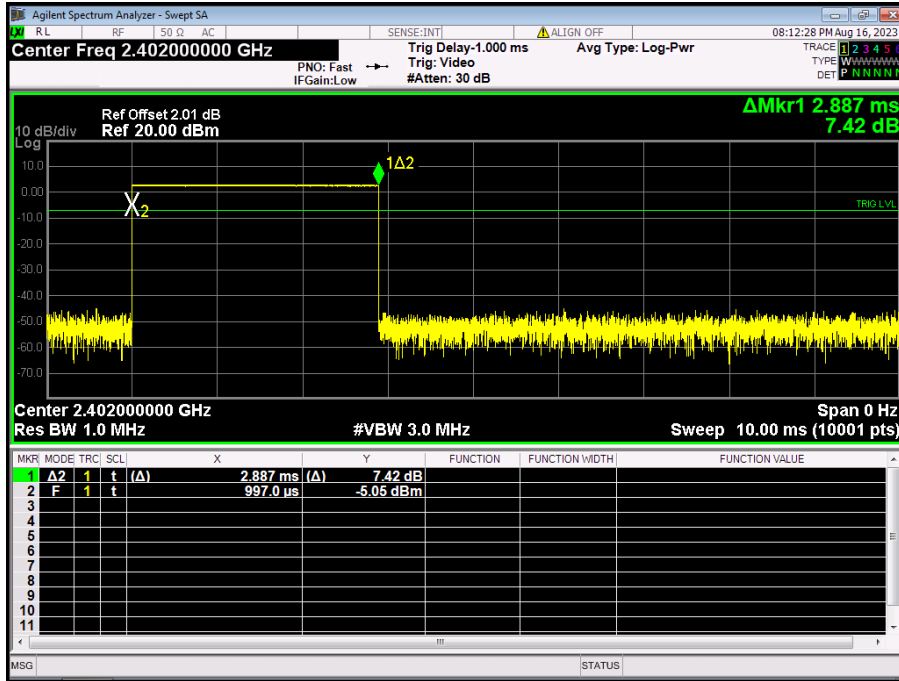

1-DH5 : 2441

Mode	Frequency (MHz)	Pulse Time (ms)	Total Dwell Time (ms)	Period Time (ms)	Limit (ms)	Verdict
1-DH5	2441	2.887	307.947	31600	400	Pass

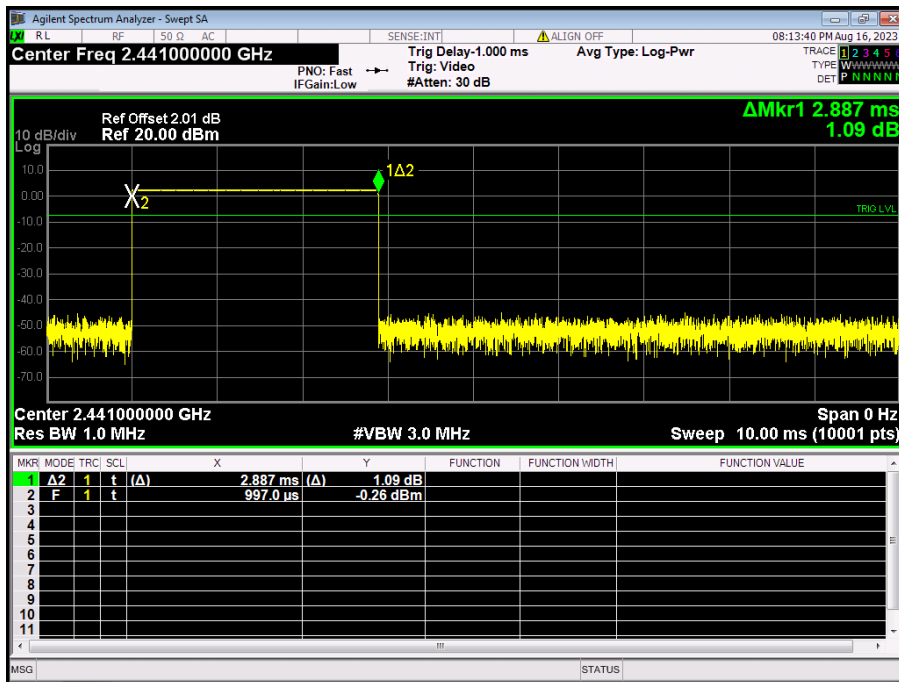

1-DH5 : 2480

Mode	Frequency (MHz)	Pulse Time (ms)	Total Dwell Time (ms)	Period Time (ms)	Limit (ms)	Verdict
1-DH5	2480	2.887	307.947	31600	400	Pass

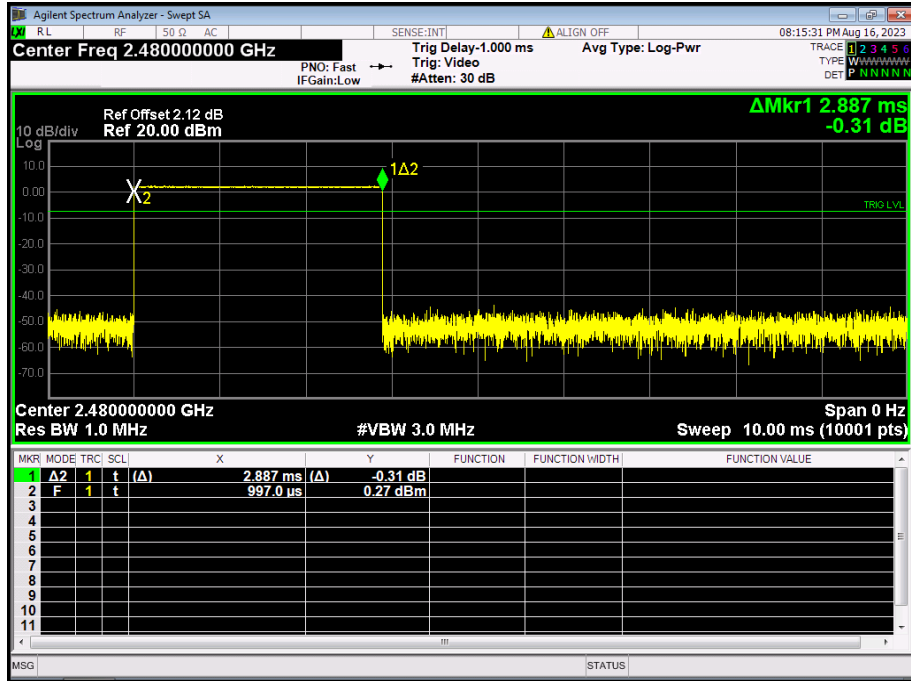

2-DH1 : 2402

Mode	Frequency (MHz)	Pulse Time (ms)	Total Dwell Time (ms)	Period Time (ms)	Limit (ms)	Verdict
2-DH1	2402	0.392	125.44	31600	400	Pass

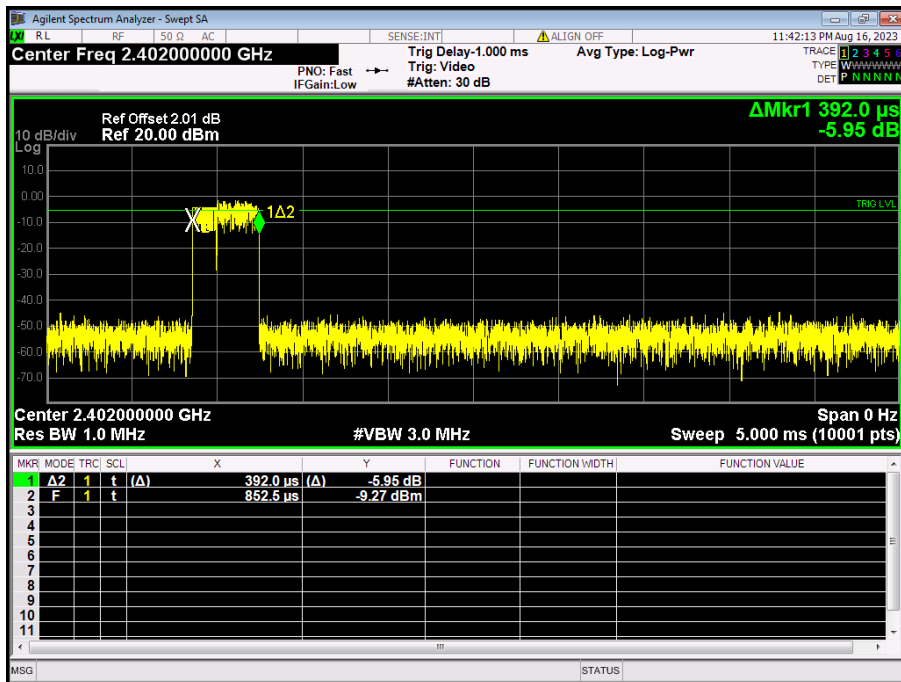

2-DH1 : 2441

Mode	Frequency (MHz)	Pulse Time (ms)	Total Dwell Time (ms)	Period Time (ms)	Limit (ms)	Verdict
2-DH1	2441	0.391	125.12	31600	400	Pass

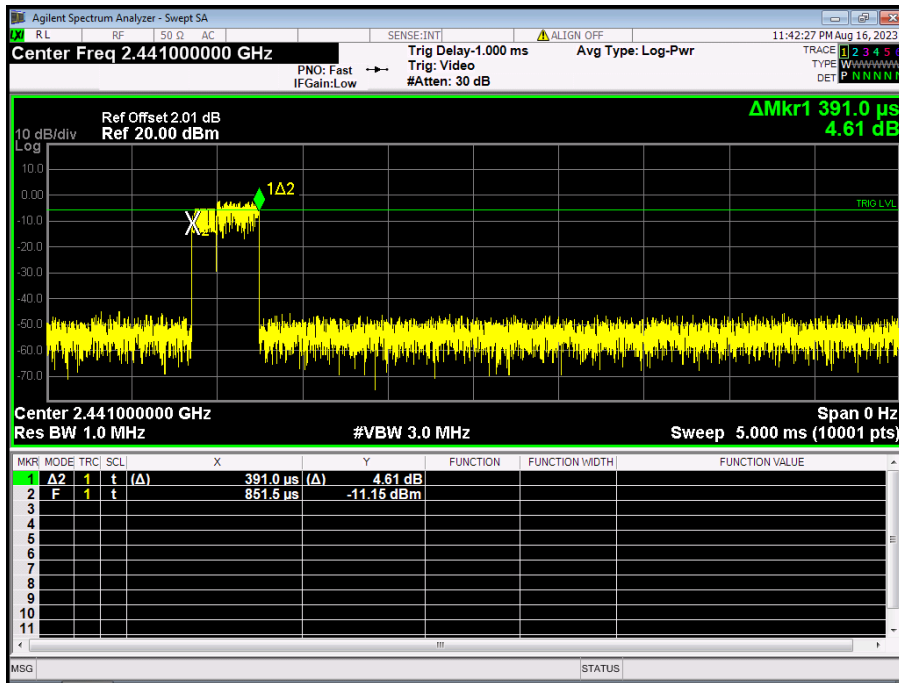

2-DH1 : 2480

Mode	Frequency (MHz)	Pulse Time (ms)	Total Dwell Time (ms)	Period Time (ms)	Limit (ms)	Verdict
2-DH1	2480	0.391	125.12	31600	400	Pass

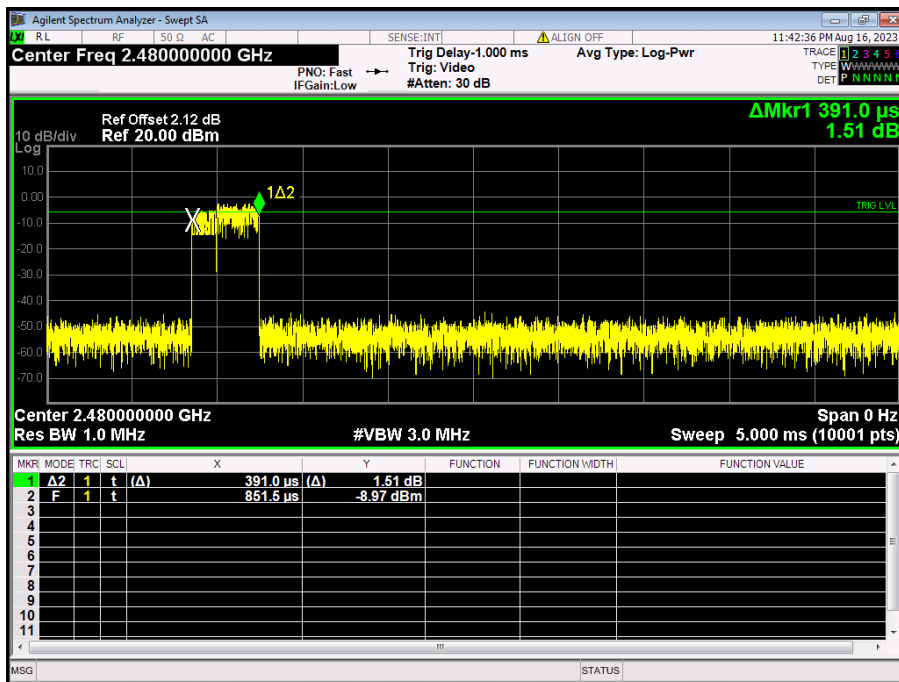

2-DH3 : 2402

Mode	Frequency (MHz)	Pulse Time (ms)	Total Dwell Time (ms)	Period Time (ms)	Limit (ms)	Verdict
2-DH3	2402	1.644	263.04	31600	400	Pass

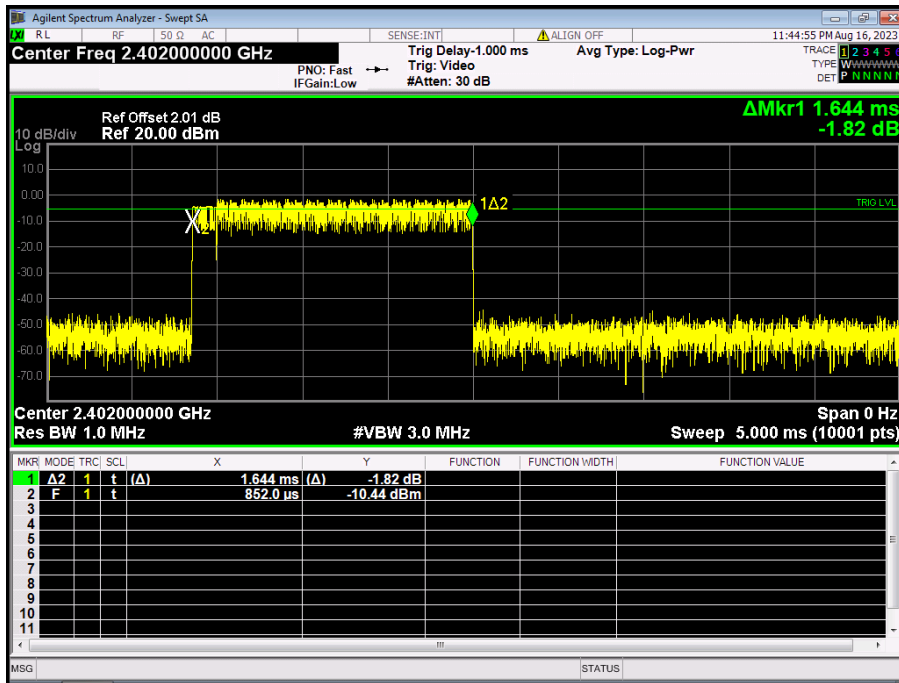

2-DH3 : 2441

Mode	Frequency (MHz)	Pulse Time (ms)	Total Dwell Time (ms)	Period Time (ms)	Limit (ms)	Verdict
2-DH3	2441	1.644	263.04	31600	400	Pass

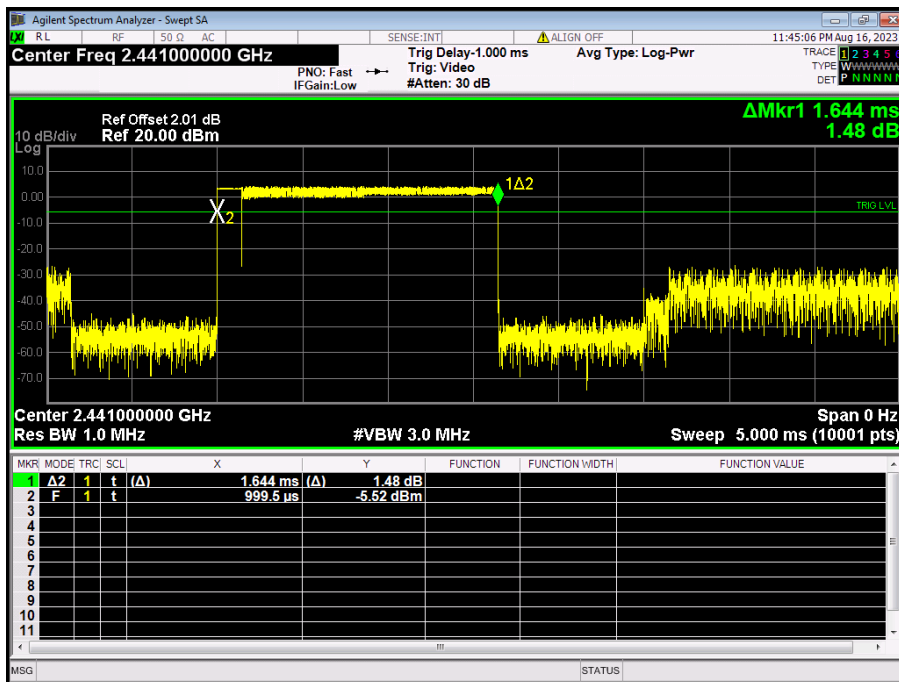

2-DH3 : 2480

Mode	Frequency (MHz)	Pulse Time (ms)	Total Dwell Time (ms)	Period Time (ms)	Limit (ms)	Verdict
2-DH3	2480	1.643	262.88	31600	400	Pass

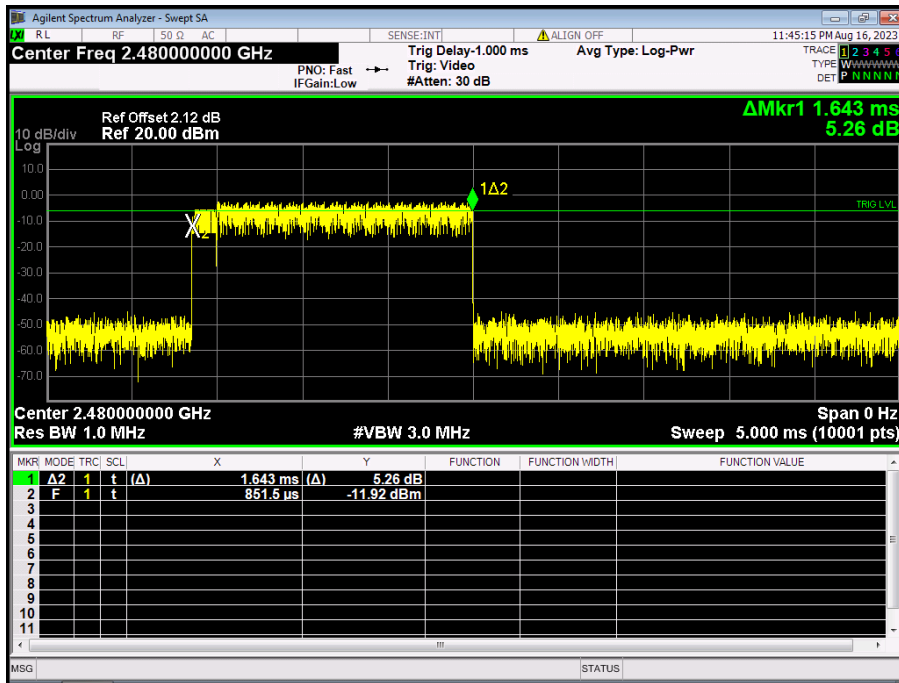

2-DH5 : 2402

Mode	Frequency (MHz)	Pulse Time (ms)	Total Dwell Time (ms)	Period Time (ms)	Limit (ms)	Verdict
2-DH5	2402	2.892	308.48	31600	400	Pass

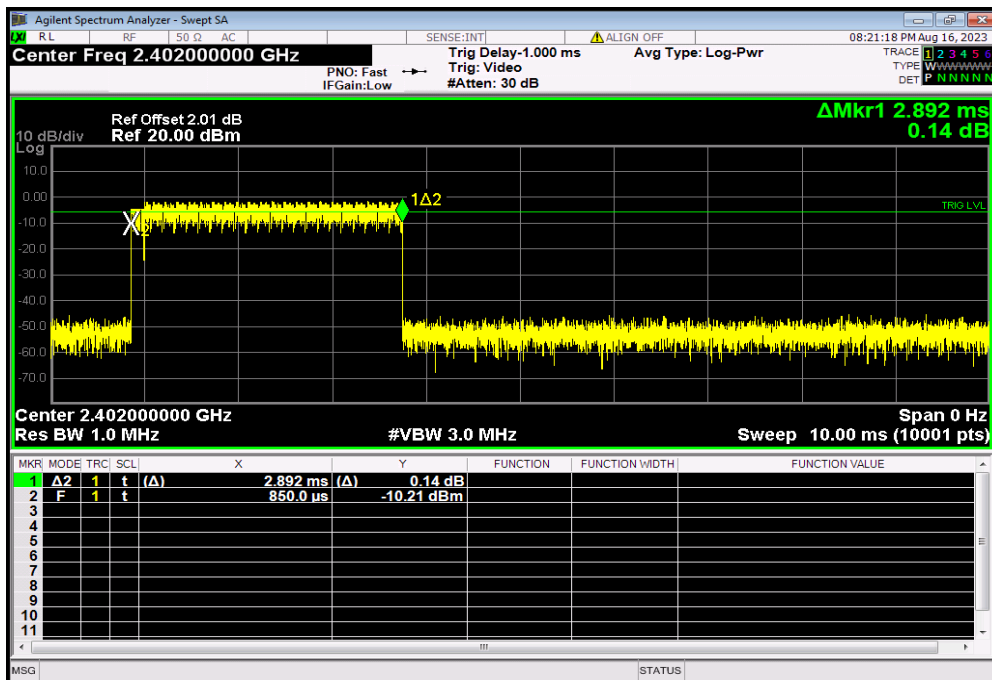

2-DH5 : 2441

Mode	Frequency (MHz)	Pulse Time (ms)	Total Dwell Time (ms)	Period Time (ms)	Limit (ms)	Verdict
2-DH5	2441	2.892	308.48	31600	400	Pass

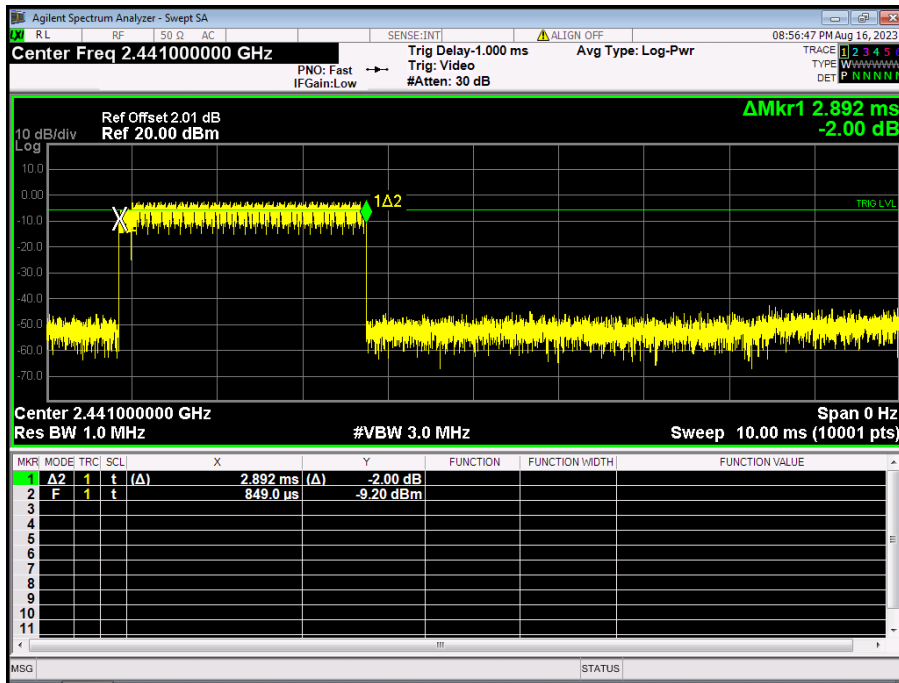

2-DH5 : 2480

Mode	Frequency (MHz)	Pulse Time (ms)	Total Dwell Time (ms)	Period Time (ms)	Limit (ms)	Verdict
2-DH5	2480	2.892	308.48	31600	400	Pass

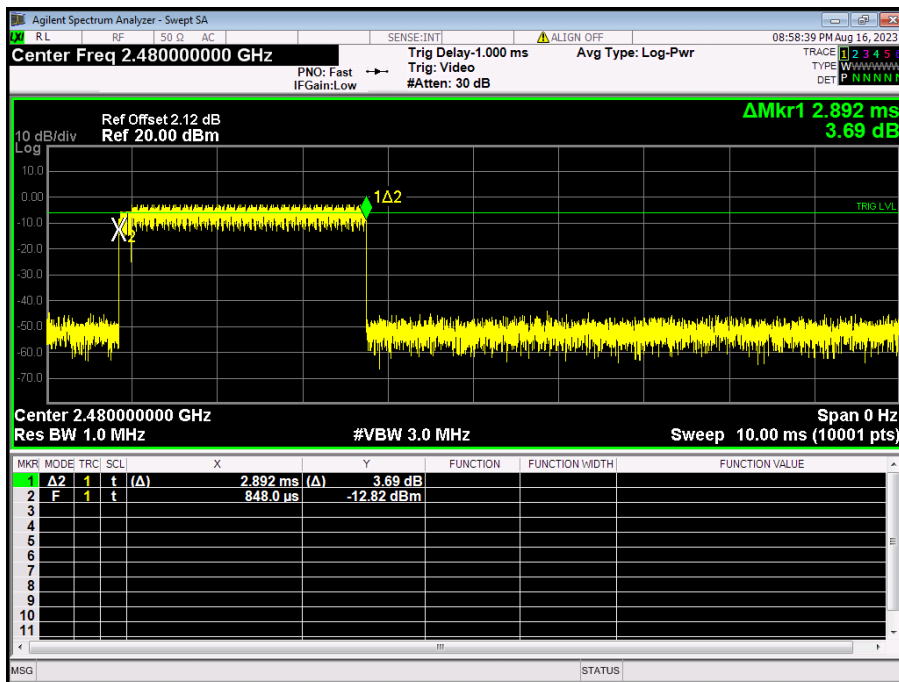

3-DH1 : 2402

Mode	Frequency (MHz)	Pulse Time (ms)	Total Dwell Time (ms)	Period Time (ms)	Limit (ms)	Verdict
3-DH1	2402	0.392	125.44	31600	400	Pass

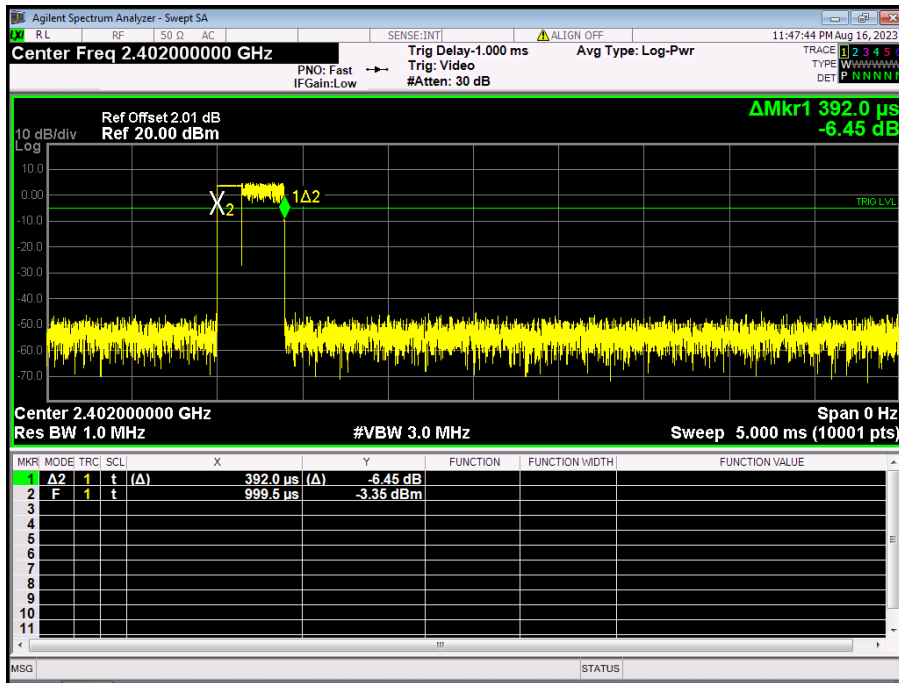

3-DH1 : 2441

Mode	Frequency (MHz)	Pulse Time (ms)	Total Dwell Time (ms)	Period Time (ms)	Limit (ms)	Verdict
3-DH1	2441	0.391	125.12	31600	400	Pass

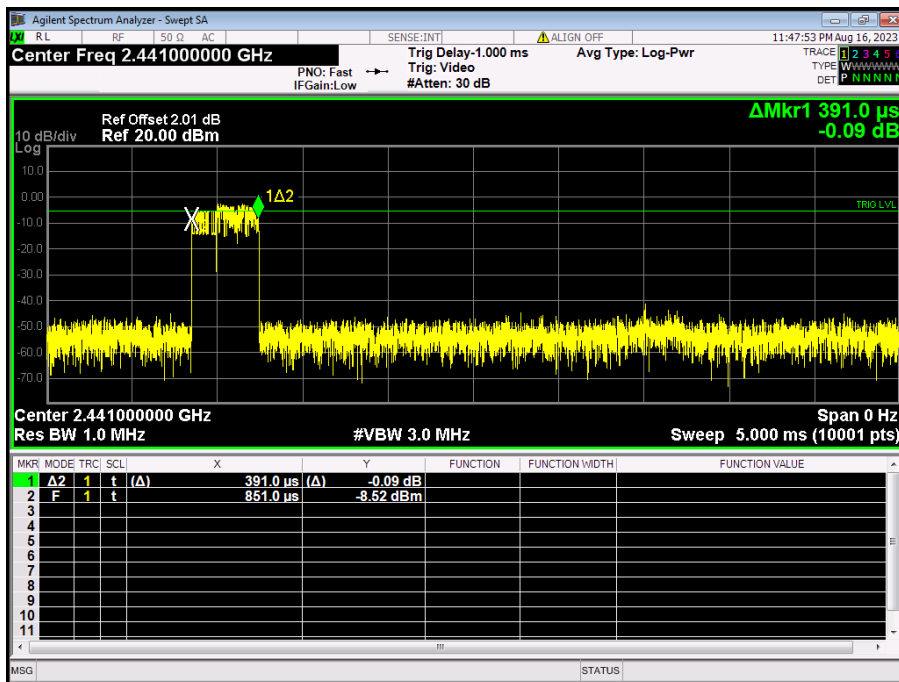

3-DH1 : 2480

Mode	Frequency (MHz)	Pulse Time (ms)	Total Dwell Time (ms)	Period Time (ms)	Limit (ms)	Verdict
3-DH1	2480	0.392	125.44	31600	400	Pass

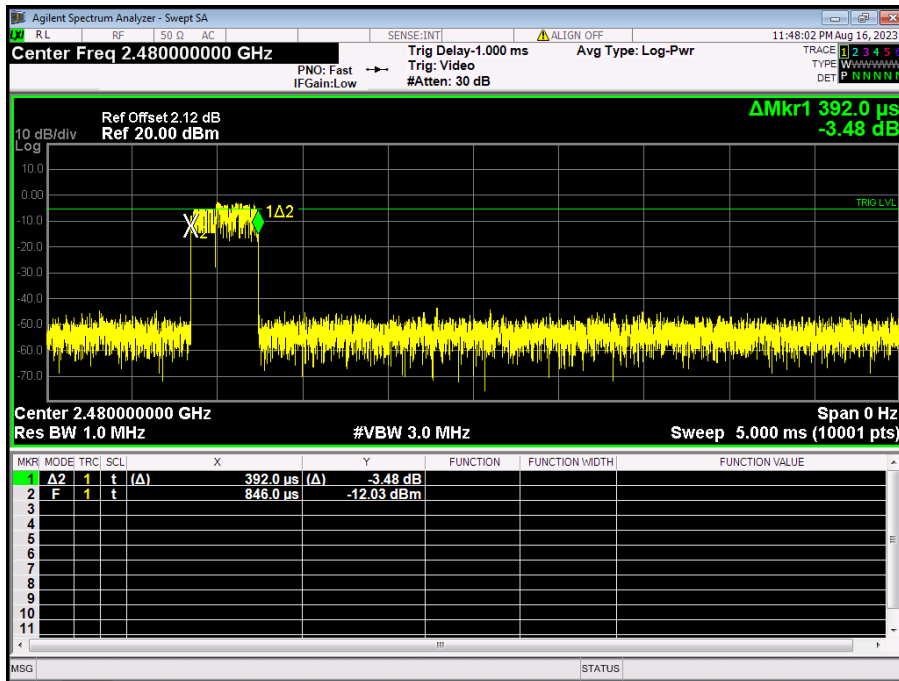

3-DH3 : 2402

Mode	Frequency (MHz)	Pulse Time (ms)	Total Dwell Time (ms)	Period Time (ms)	Limit (ms)	Verdict
3-DH3	2402	1.643	262.88	31600	400	Pass

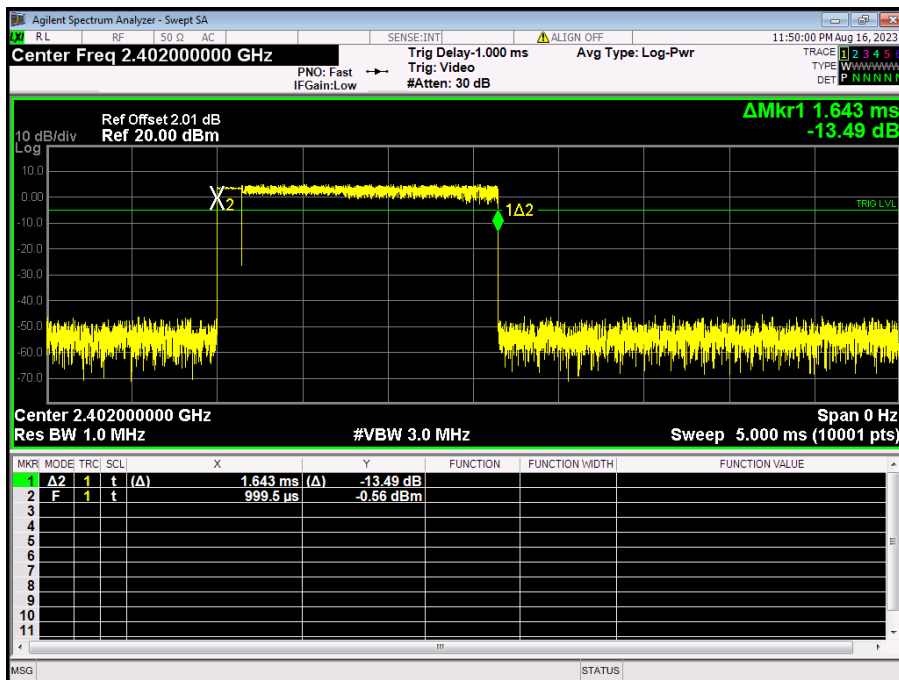

3-DH3 : 2441

Mode	Frequency (MHz)	Pulse Time (ms)	Total Dwell Time (ms)	Period Time (ms)	Limit (ms)	Verdict
3-DH3	2441	1.643	262.88	31600	400	Pass

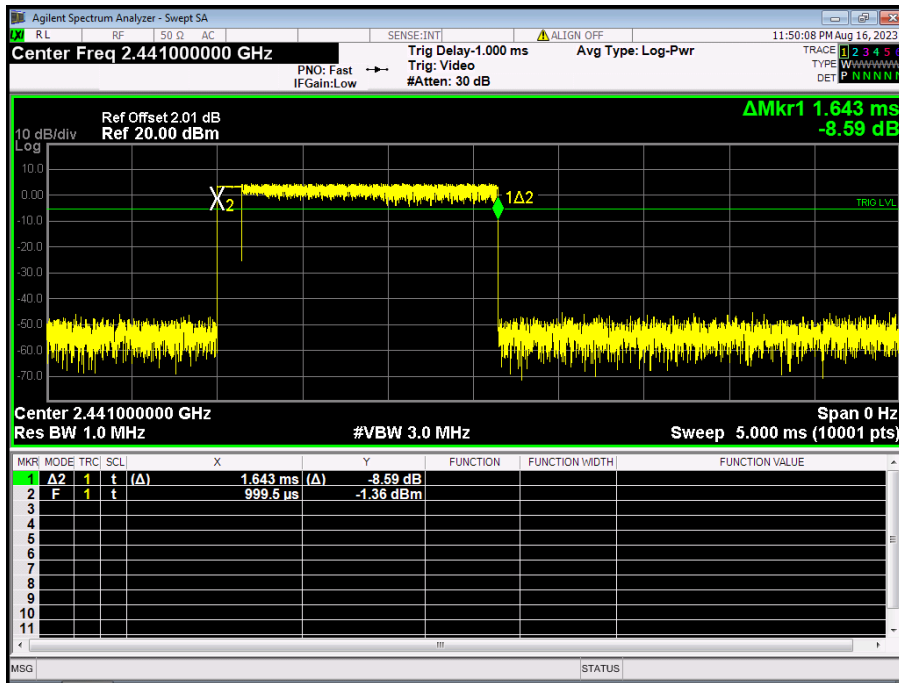

3-DH3 : 2480

Mode	Frequency (MHz)	Pulse Time (ms)	Total Dwell Time (ms)	Period Time (ms)	Limit (ms)	Verdict
3-DH3	2480	1.642	262.72	31600	400	Pass

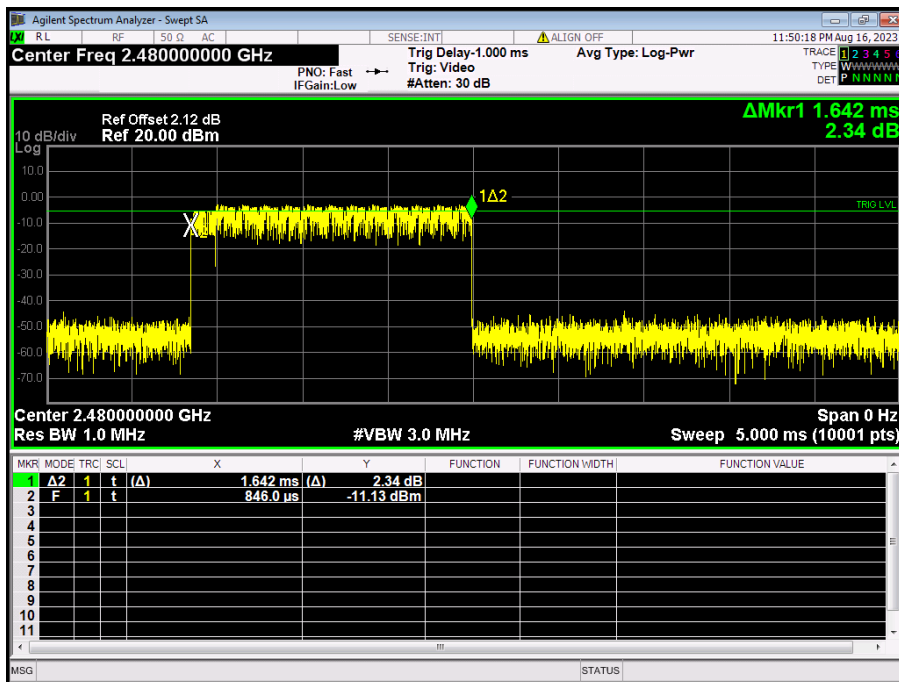

3-DH5 : 2402

Mode	Frequency (MHz)	Pulse Time (ms)	Total Dwell Time (ms)	Period Time (ms)	Limit (ms)	Verdict
3-DH5	2402	2.893	308.587	31600	400	Pass

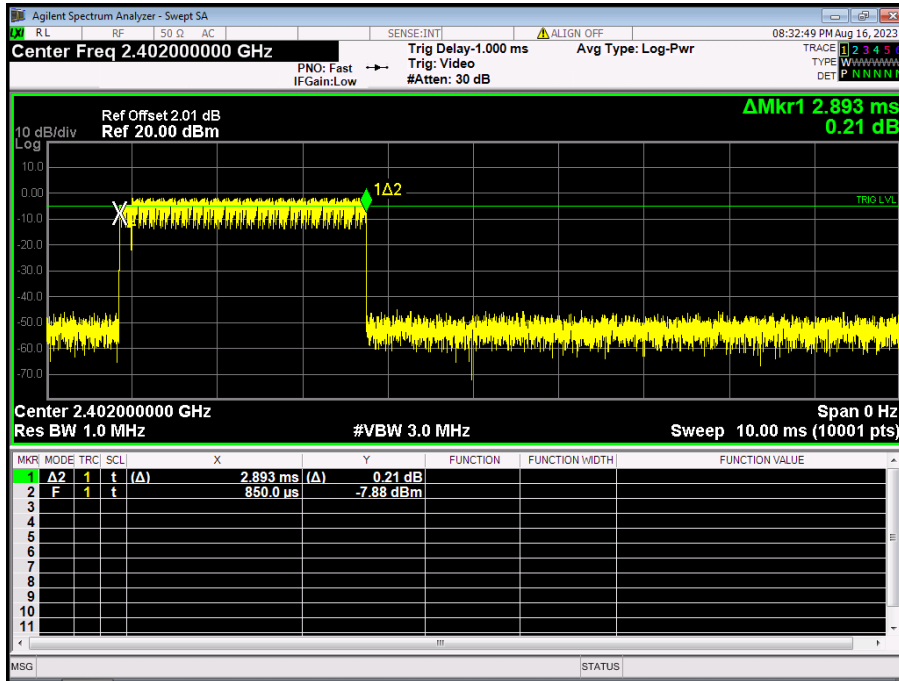

3-DH5 : 2441

Mode	Frequency (MHz)	Pulse Time (ms)	Total Dwell Time (ms)	Period Time (ms)	Limit (ms)	Verdict
3-DH5	2441	2.893	308.587	31600	400	Pass

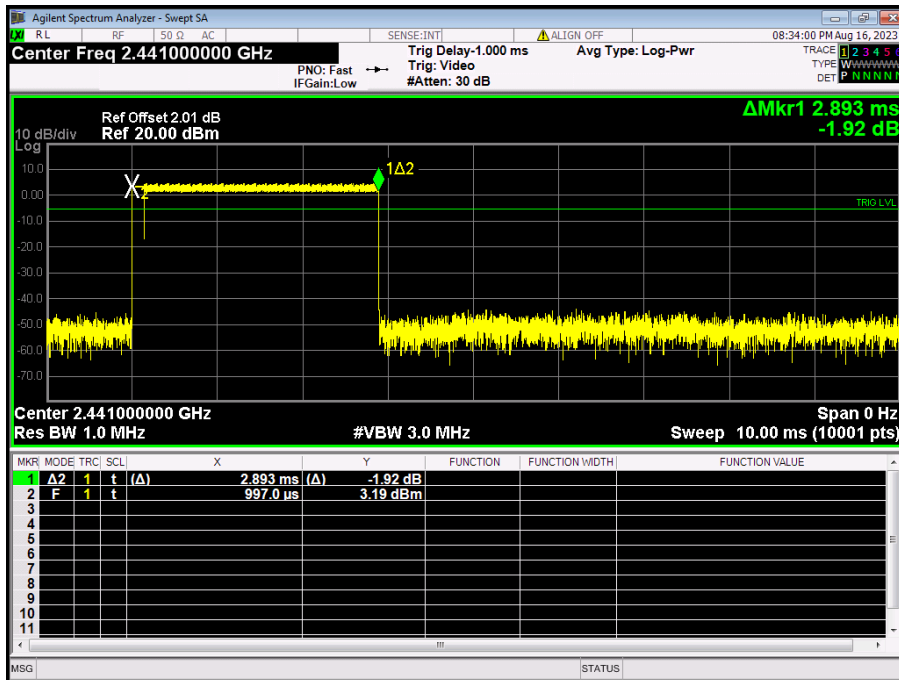

3-DH5 : 2480

Mode	Frequency (MHz)	Pulse Time (ms)	Total Dwell Time (ms)	Period Time (ms)	Limit (ms)	Verdict
3-DH5	2480	2.893	308.587	31600	400	Pass

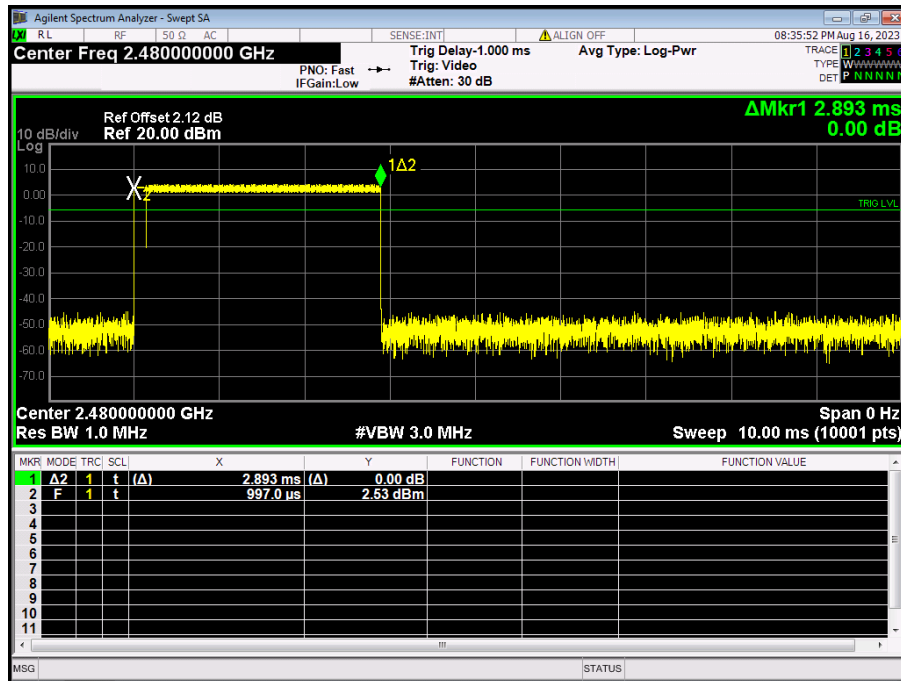

Remark:

In communication data link mode (expect inquiry or page mode) the hopping rate is 1600 per second, the 79 channels will be randomly selected for RF channel, and each channel have equal probability to be selected. The hop selection scheme is defined in Clause 2.6 of Part B of Volume 2 of core specification of Bluetooth.

The Dwell time must be calculated via following formula:

$$\text{Dwell time} = \text{Pulse wide} \times (\text{Hopping rate} / \text{Number of channels}) \times \text{Period}$$

$$\text{Period} = 0.4 \text{ (seconds/ channel)} \times 79 \text{ (channel)} = 31.6 \text{ seconds}$$

So

$$\text{Dwell time DH1} = \text{slot time} \times (1600/2/79) \times 31.6$$

$$\text{Dwell time DH3} = \text{slot time} \times (1600/4/79) \times 31.6$$

$$\text{Dwell time DH5} = \text{slot time} \times (1600/6/79) \times 31.6$$

The RF channel will remain fixed for duration of a packet, that means for DH3 packet the RF frequency will remain unchanged during 3 slots (1 slot=1/1600=625us), and for DH5 packet the RF frequency will remain unchanged during 5 slots, illustrated the principle as below:

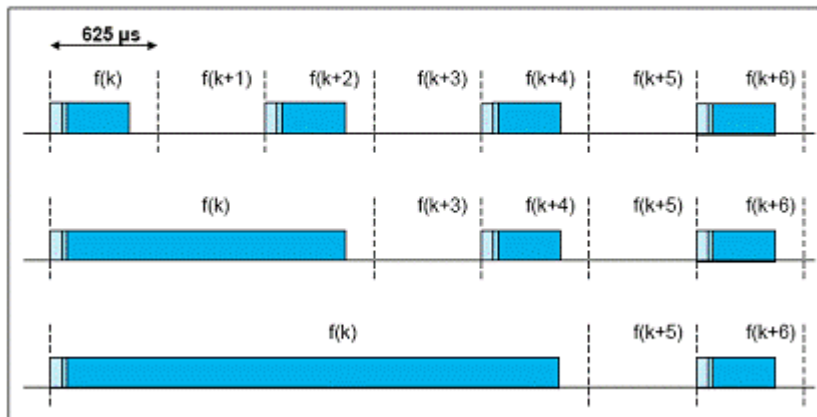

Figure 2.14: Single- and multi-slot packets.

Therefore, in a certain period for different packet types, the quantities of hops (not hopping rate 1600) are different, accurately, the quantity of hops for DH1 is double of DH3's and triple of DH5's. "for DH1 packet, 1 hop in 1 slot; for DH3 packet, 1/2 hop in 1 slot; for DH5 packet, 1/3 hop in 1 slot.", explained as below:

From the illustrated hopping scheme:

For DH1, in two slots, there are two hops, i.e. $f(k)$ in Slot(k), $f(k+1)$ in Slot(k+1), means DH1 1 hop in 1 slot;

For DH3, in four slots, there are two hops, i.e. $f(k)$ in Slot(k) & Slot(k+1) & Slot(k+2), $f(k+3)$ in Slot(k+3), means DH3 2 hops in four slots \rightarrow 1/2 hop in 1 slot;

For DH5, in six slots, there are two hops, i.e. $f(k)$ in Slot(k) & Slot(k+1) & Slot(k+2) & Slot(k+3) & Slot(k+4), $f(k+5)$ in Slot(k+5), means DH3 2 hops in six slots \rightarrow 1/3 hop in 1 slot.

The Hopping rate in the formula should not be fixed value, for DH1, it is $1600/2$; for DH3, it is $1600/4$; for DH5, it is $1600/6$.

To calculate Dwell time of data transmission of Bluetooth system, the worst case is for Bluetooth PICONET that contains two devices only (although Bluetooth PICONET can support up to eight devices), and for Bluetooth data transmission, after device A sending a packet to device B, device A must get response packet from device B to continue data transmission;

For DH1 packet: assume device A is EUT, the worst case is after device A sending a DH1 packet to device B, device A gets a DH1 response packet from device B, that means device A needs 1 time slot for transmitting and 1 time slot for receiving, therefore, the actual hopping rate of device A is half of 1600, i.e. 800 hops per second for EUT;

For DH3 packet: assume device A is EUT, the worst case is after device A sending a DH3 packet to device B, device A gets a DH1 response packet from device B, that means device A needs 3 time slots for transmitting and 1 time slot for receiving, therefore, the actual hopping rate of device A is quarter of 1600, i.e. 400 hops per second for EUT;

For DH5 packet: assume device A is EUT, the worst case is after device A sending a DH5 packet to device B, device A gets a DH1 response packet from device B, that means device A needs 5 time slots for transmitting and 1 time slot for receiving, therefore, the actual hopping rate of device A is sixth of 1600, i.e. $1600/6=266.7$ hops per second for EUT;

5.7 Maximum Peak Output Power

Test Requirement: FCC Part 15 C section 15.247

(b)(1) For frequency hopping systems operating in the 2400-2483.5 MHz band employing at least 75 non-overlapping hopping channels, and all frequency hopping systems in the 5725-5850 MHz band: 1 watt.
For all other frequency hopping systems in the 2400-2483.5 MHz band:
0.125W

Test Method: ANSI C63.10:2013

Test Limit:

Test mode: Pre-test the EUT in continuous transmitting mode at the lowest, middle and highest channel with different data packet. Compliance test in continuous transmitting mode with normal (DH5), EDR mode (2DH5) and EDR mode (3DH5) as the worst case was found.

Test Configuration:

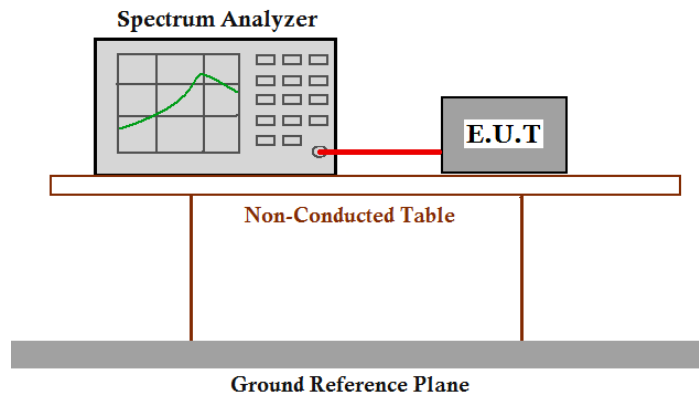

Test Procedure:

1. Remove the antenna from the EUT and then connect a low attenuation RF cable from the antenna port to the spectrum.
2. Set the spectrum analyzer: RBW >20 dB bandwidth. VBW \geq RBW. Sweep = auto; Detector Function = Peak.
3. Keep the EUT in transmitting at lowest, medium and highest channel individually. Record the max value.

Test Result: (For Bluetooth)				
Normal mode(DH5):				
Test Channel	Fundamental Frequency (MHz)	Output Power (dBm)	Limit (dBm)	Result
Lowest	2402	3.385	21.0	Pass
Middle	2441	2.402	21.0	Pass
Highest	2480	2.313	21.0	Pass
EDR mode(2DH5):				
Test Channel	Fundamental Frequency (MHz)	Output Power (dBm)	Limit (dBm)	Result
Lowest	2402	3.956	21.0	Pass
Middle	2441	3.579	21.0	Pass
Highest	2480	3.391	21.0	Pass
EDR mode(3DH5):				
Test Channel	Fundamental Frequency	Output Power (dBm)	Limit (dBm)	Result
Lowest	2402	4.430	21.0	Pass
Middle	2441	4.157	21.0	Pass
Highest	2480	3.864	21.0	Pass
Remark: cable lose=2.01db				
Test result: The unit does meet the FCC requirements.				
Test result plot as follows:				

For Bluetooth
Normal mode(DH5):
Lowest Channel:

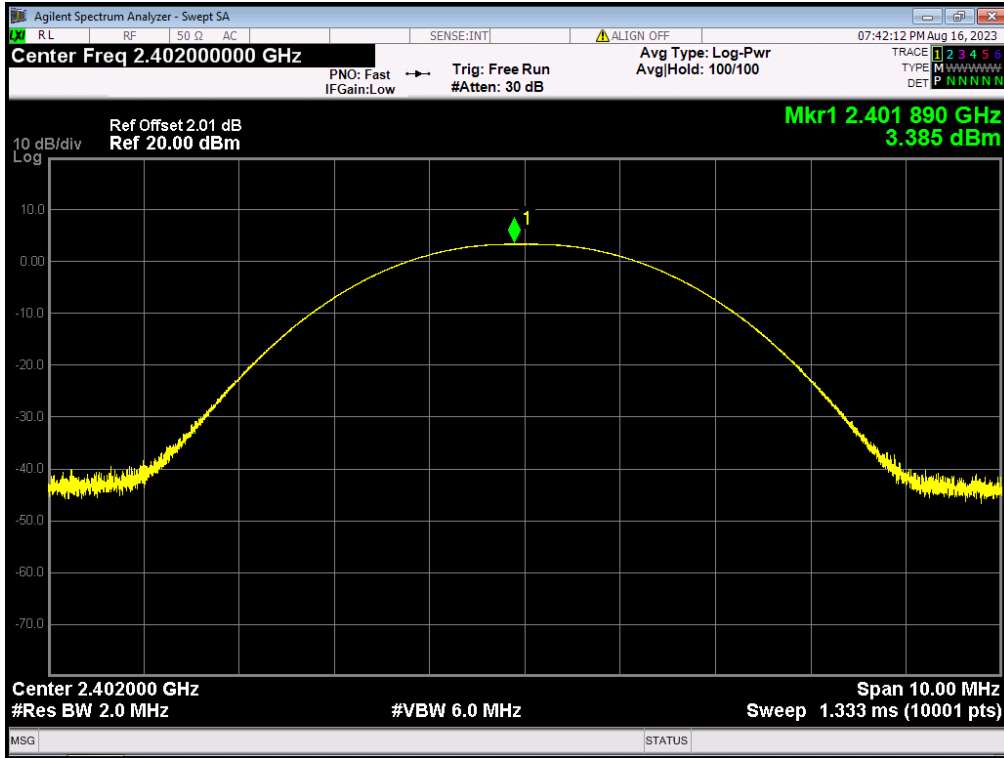

Middle Channel:

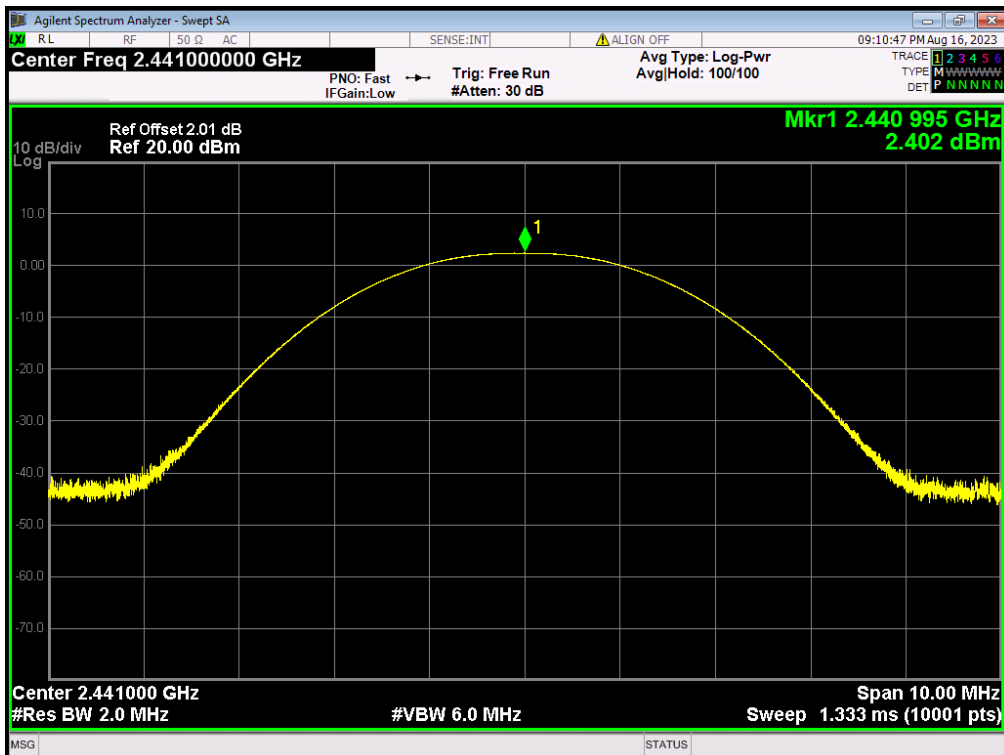

Highest Channel:

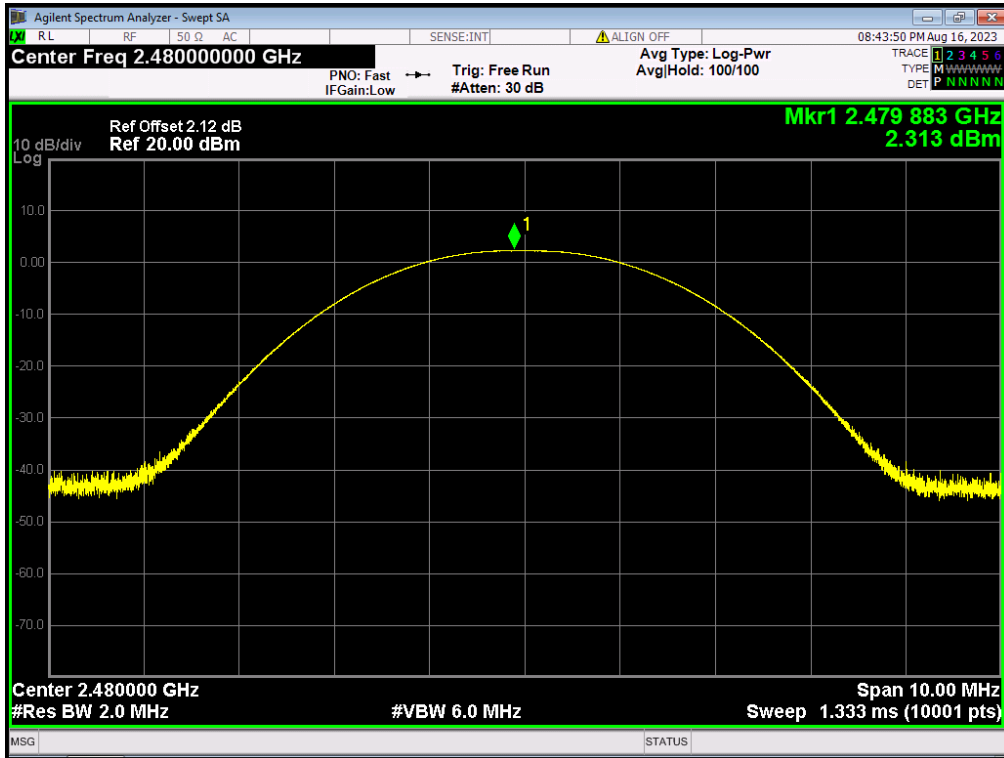

EDR mode (2DH5): Lowest Channel:

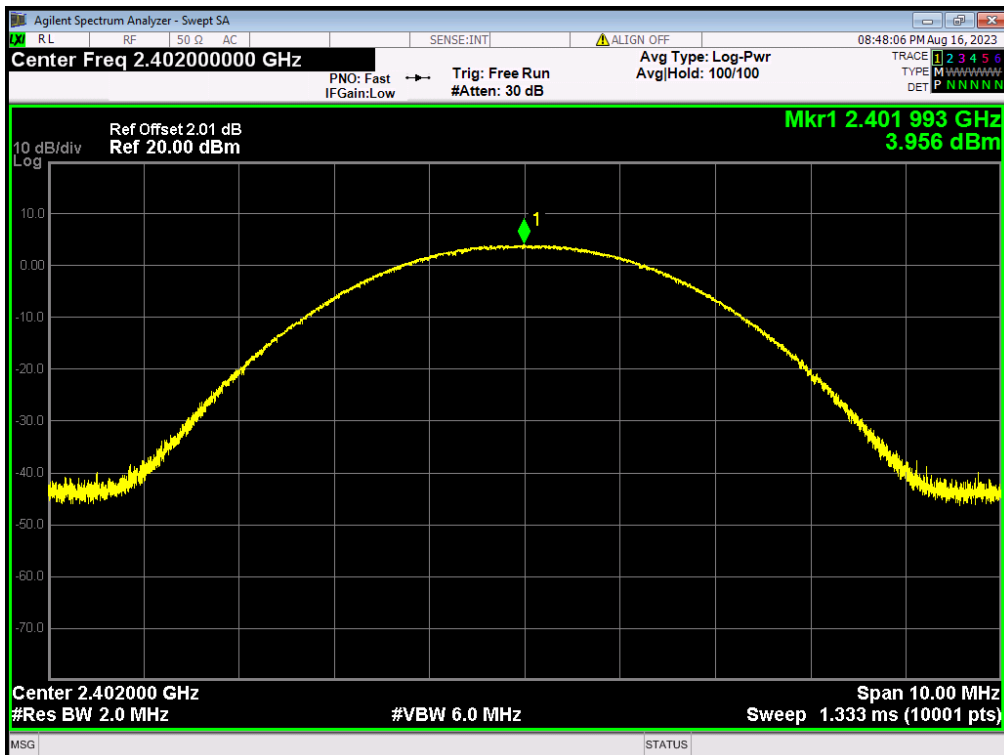

Middle Channel:

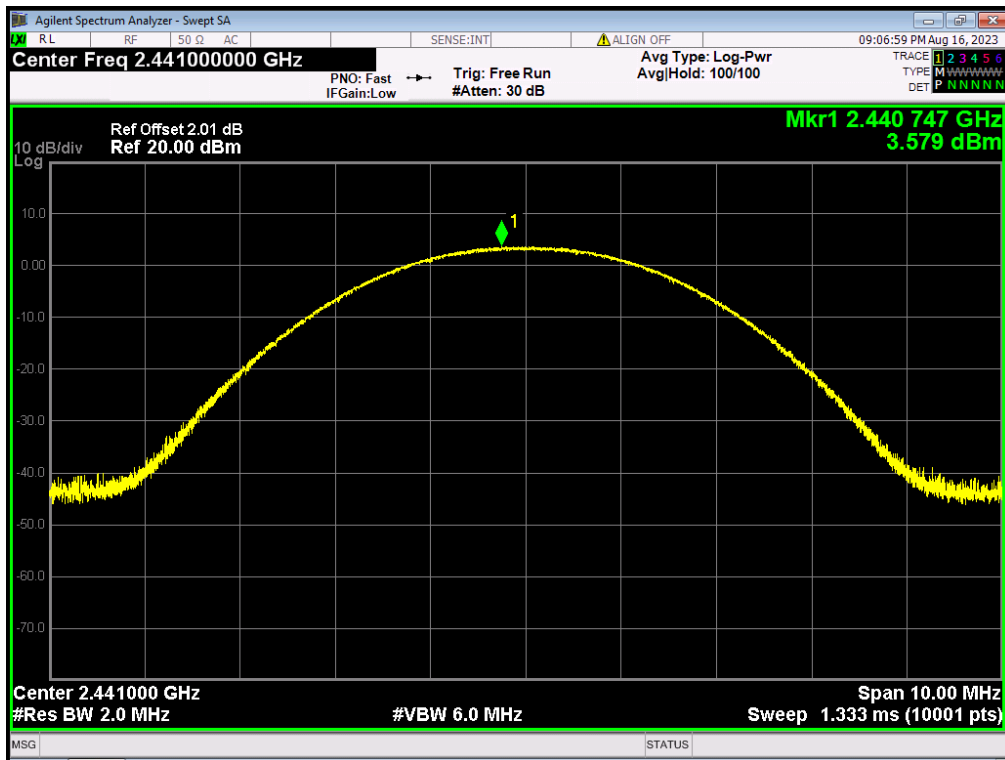

Highest Channel:

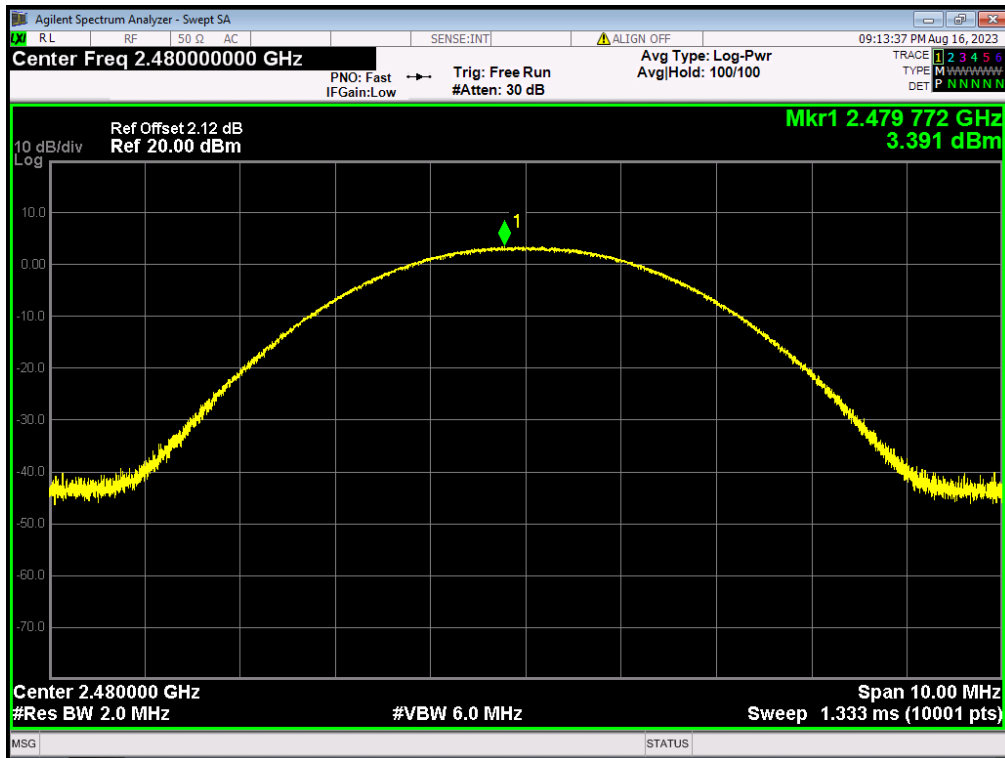

EDR mode (3DH5): Lowest Channel:

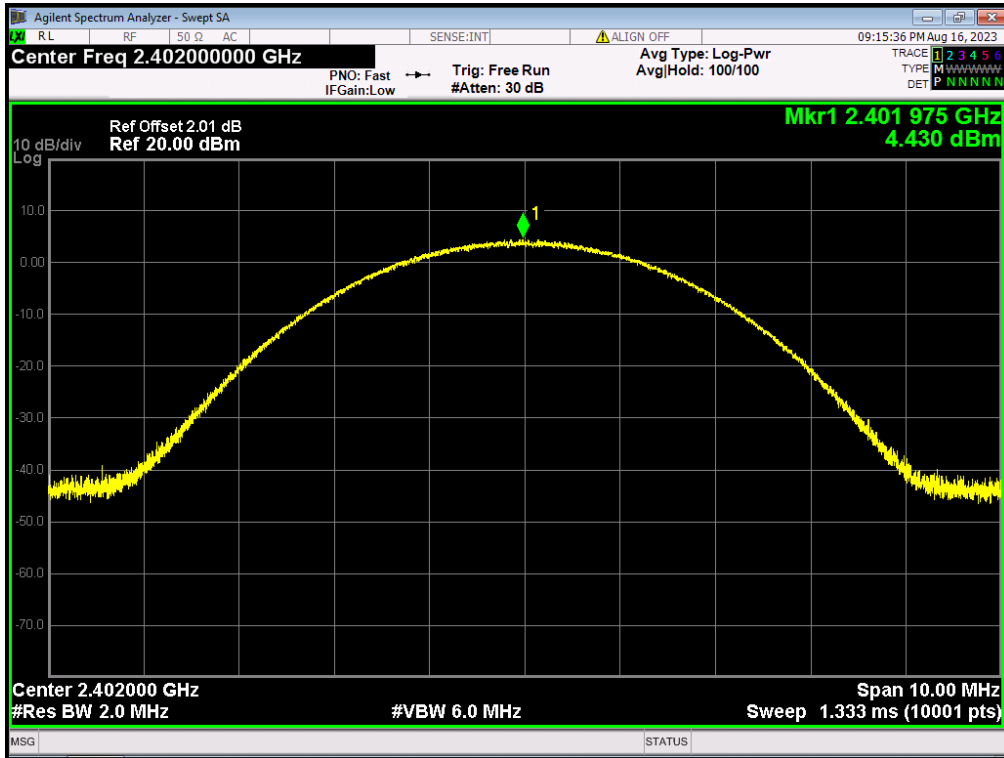

Middle Channel:

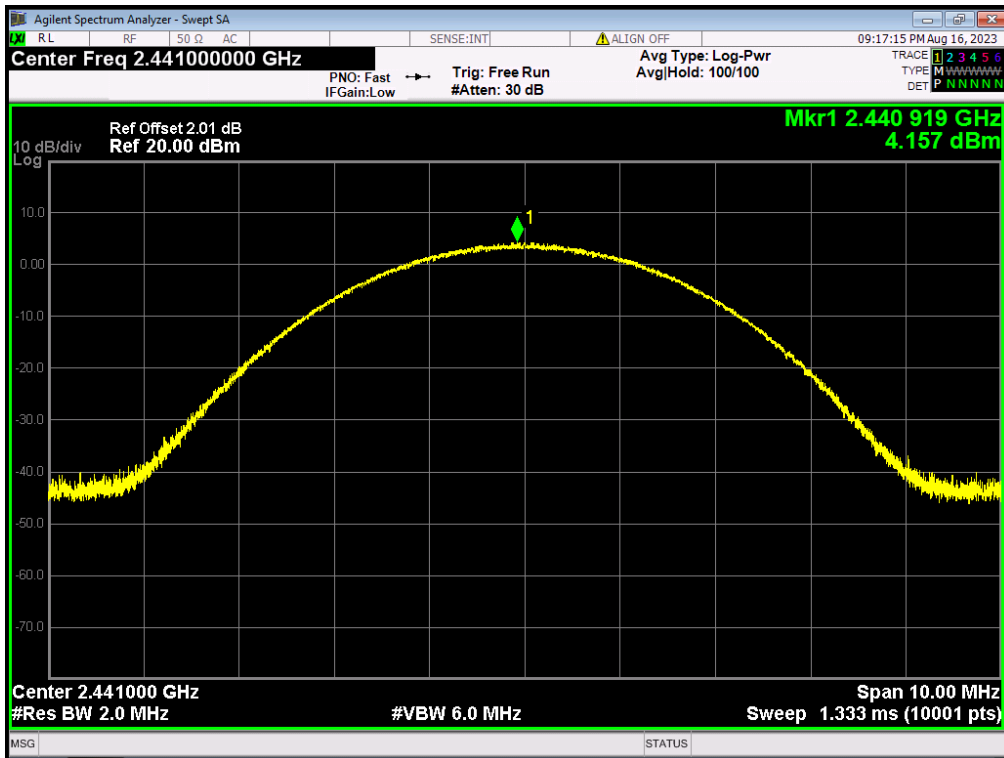

Highest Channel:

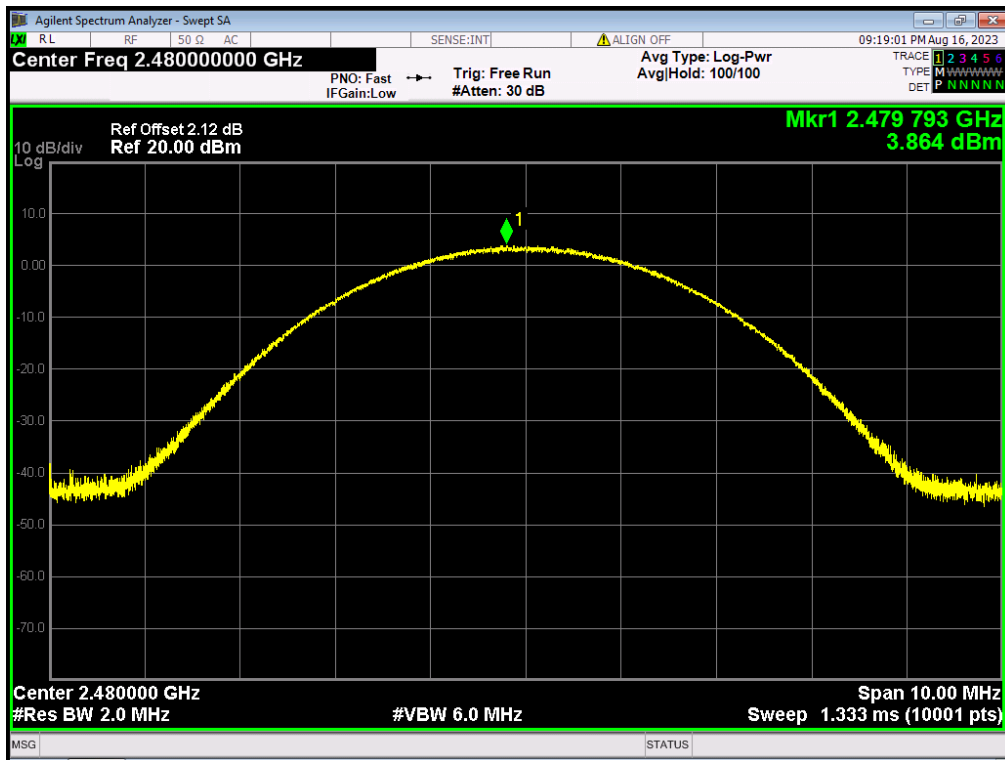

5.8 Conducted Spurious Emissions

Test Requirement: FCC Part15 C section 15.247

(d) In any 100 kHz bandwidth outside the frequency band in which the spread spectrum or digitally modulated intentional radiator is operating. The radio frequency power that is produced by the intentional radiator shall be at least 20 dB below that in the 100 kHz bandwidth within the band that contains the highest level of the desired power. Based on either an RF conducted or a radiated measurement. Provided the transmitter demonstrates compliance with the peak conducted power limits.

Test Method: ANSI C63.10:2013

Test Status: Pre-test the EUT in continuous transmitting mode at the lowest, middle and highest channel with different data packet. Compliance test in continuous transmitting mode with normal (DH5), EDR mode (2DH5) and EDR mode (3DH5) as the worst case was found.

Test Configuration:

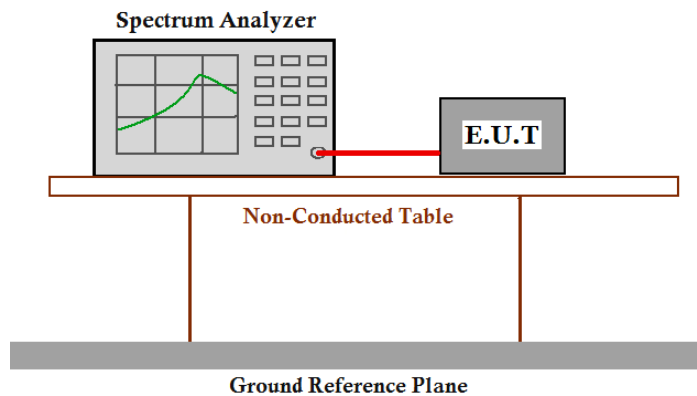

Test Procedure:

1. Remove the antenna from the EUT and then connect a low attenuation RF cable from the antenna port to the spectrum.
2. Set the spectrum analyzer: RBW = 100 kHz. VBW \geq RBW. Sweep = auto; Detector Function = Peak (Max. hold).

For Bluetooth

Test result plot as follows (Normal mode DH5):
Lowest Channel:

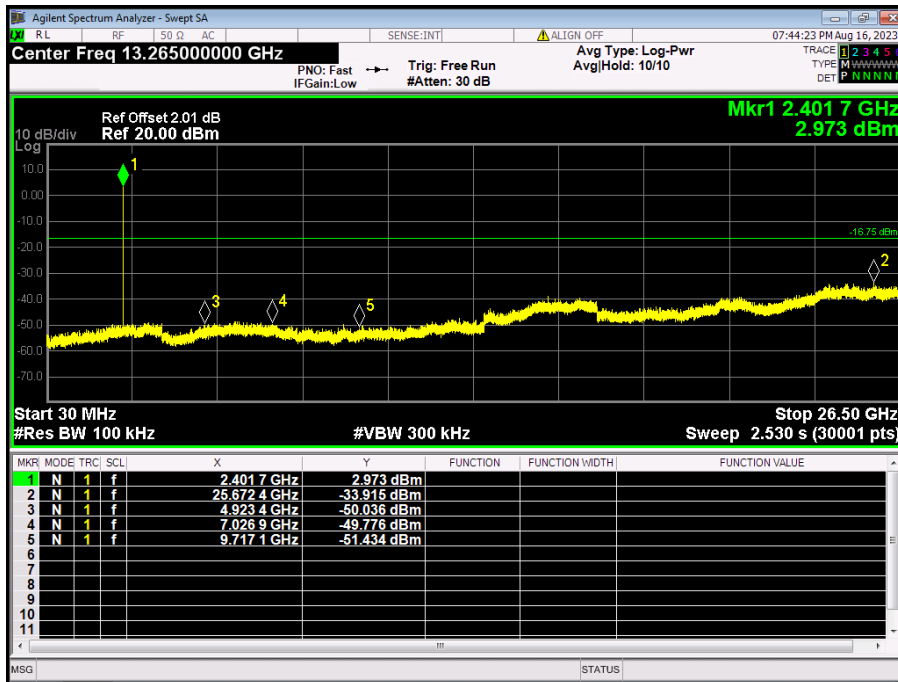

Middle Channel:

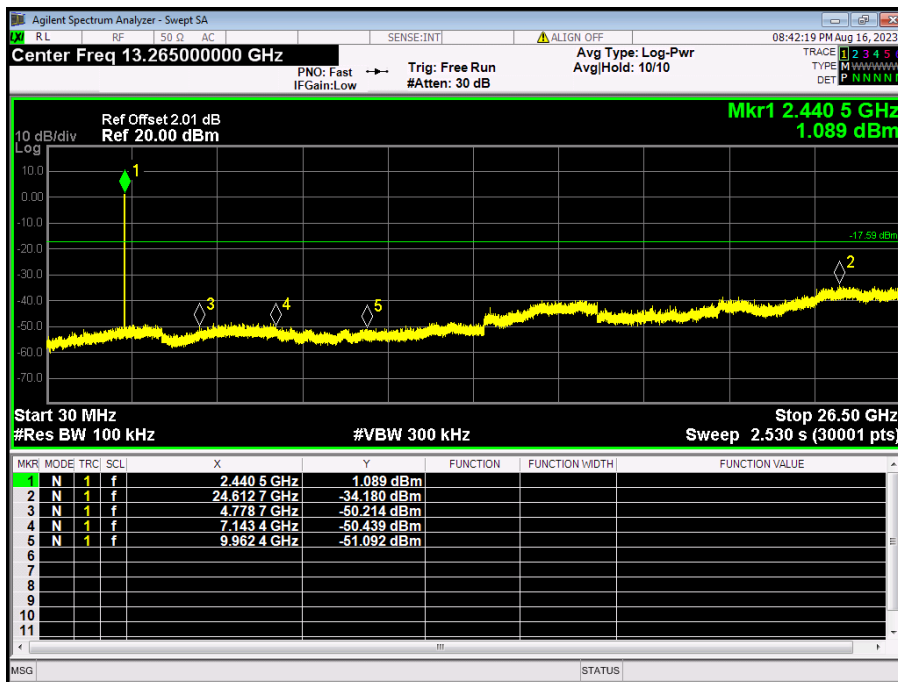

Note: This line in the plots is a reference line for the 20dB down limit, not the limit.

Highest Channel:

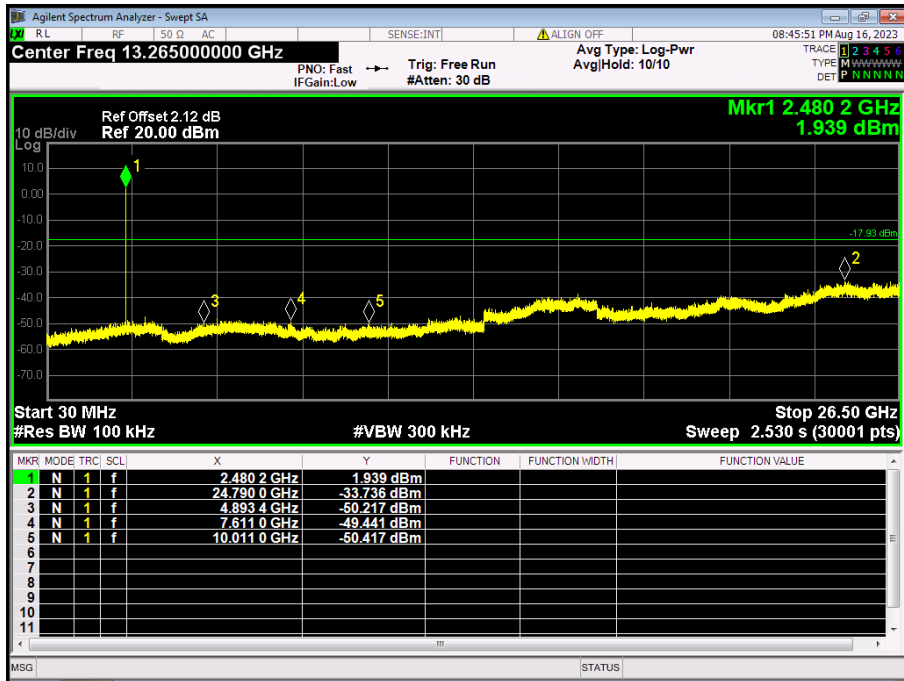

Test result plot as follows (EDR mode-2DH5):
Lowest Channel:

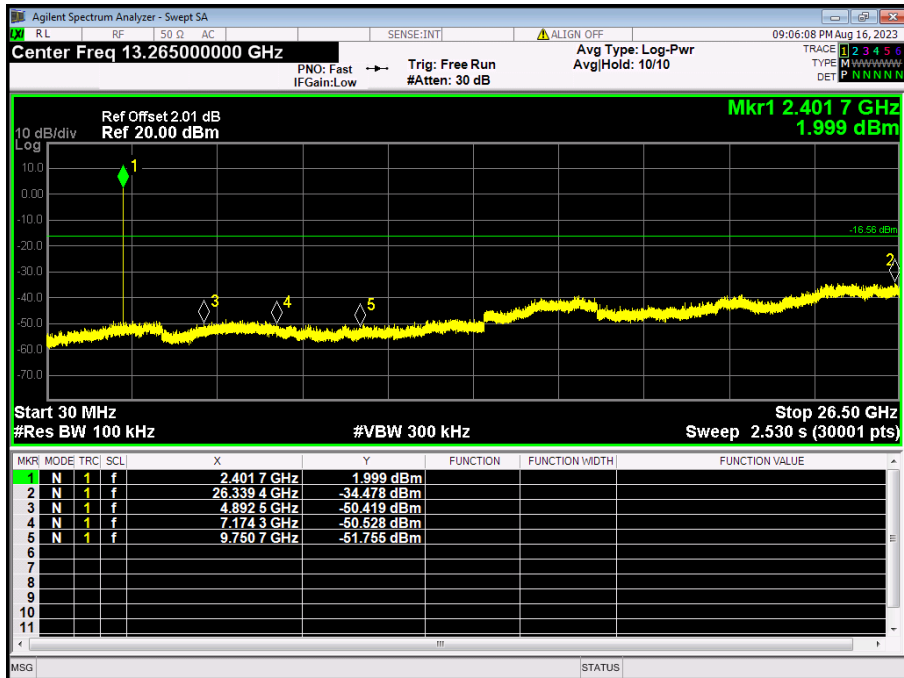

Note: This line in the plots is a reference line for the 20dB down limit, not the limit.

Middle Channel:

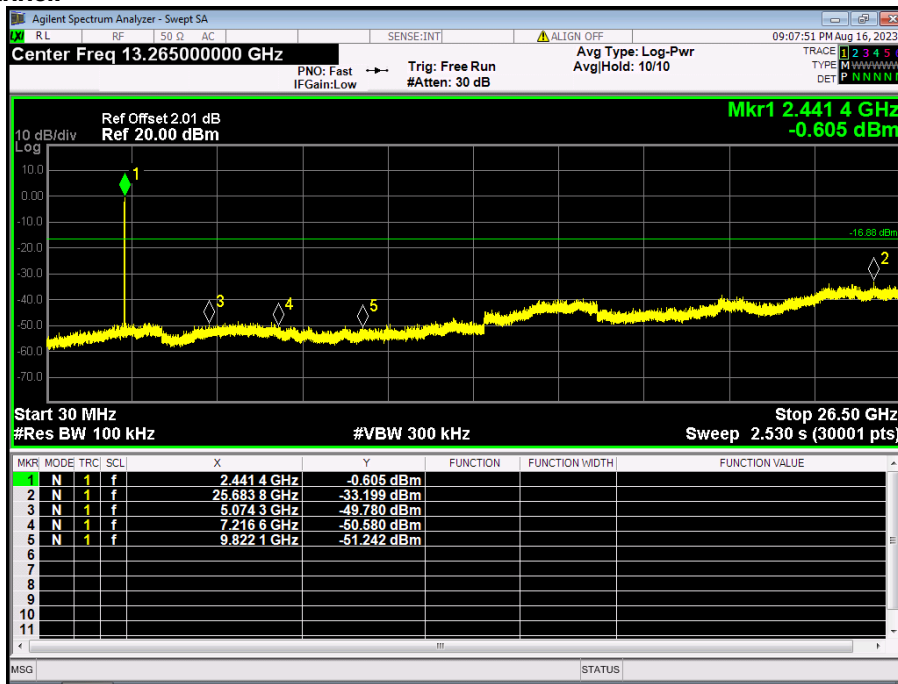

Highest Channel:

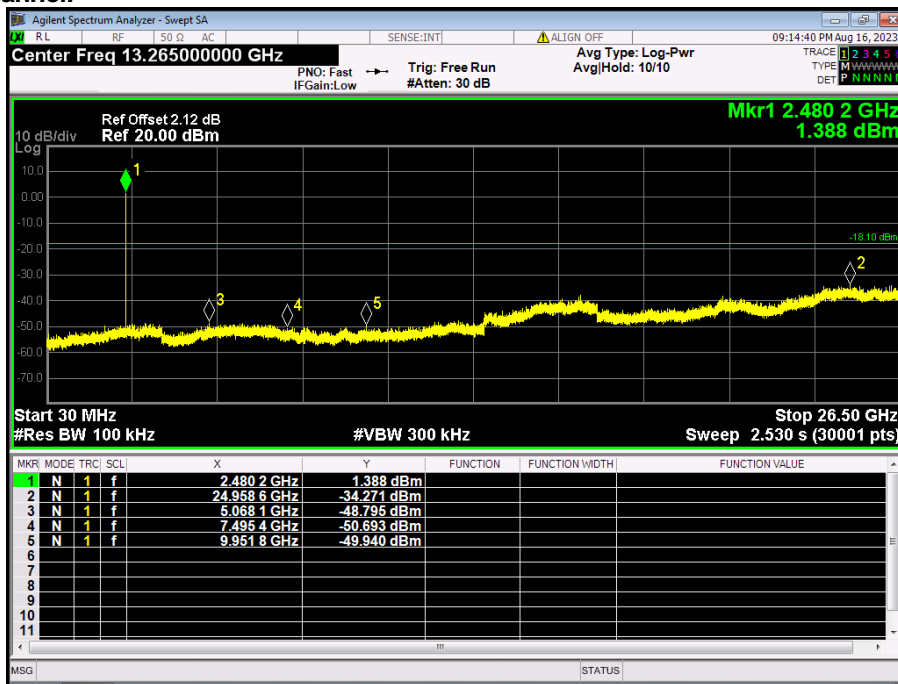

Note: This line in the plots is a reference line for the 20dB down limit, not the limit.

Test result plot as follows (EDR mode-3DH5):
 Lowest Channel:

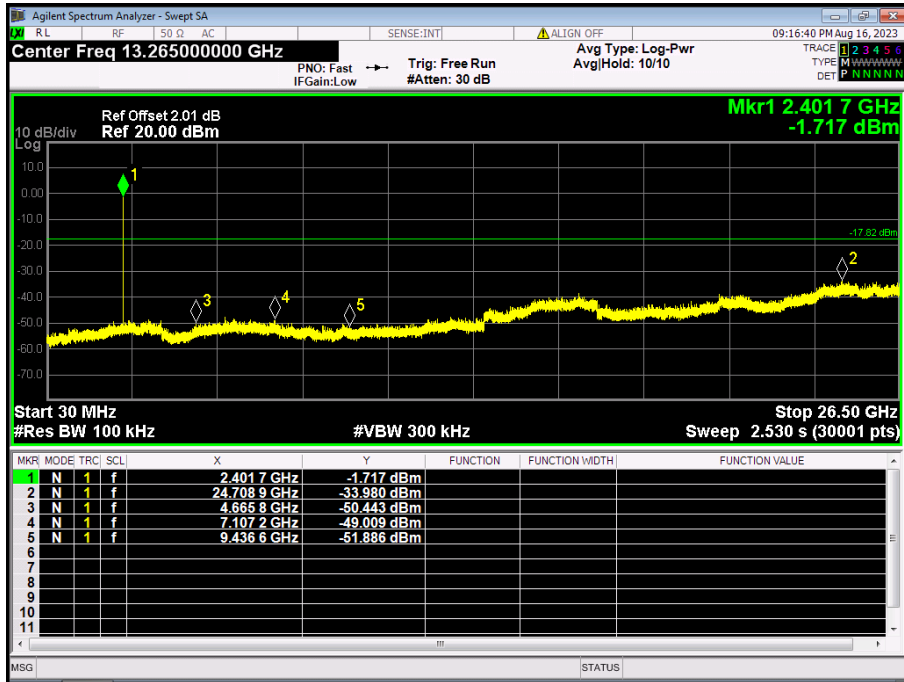

Middle Channel:

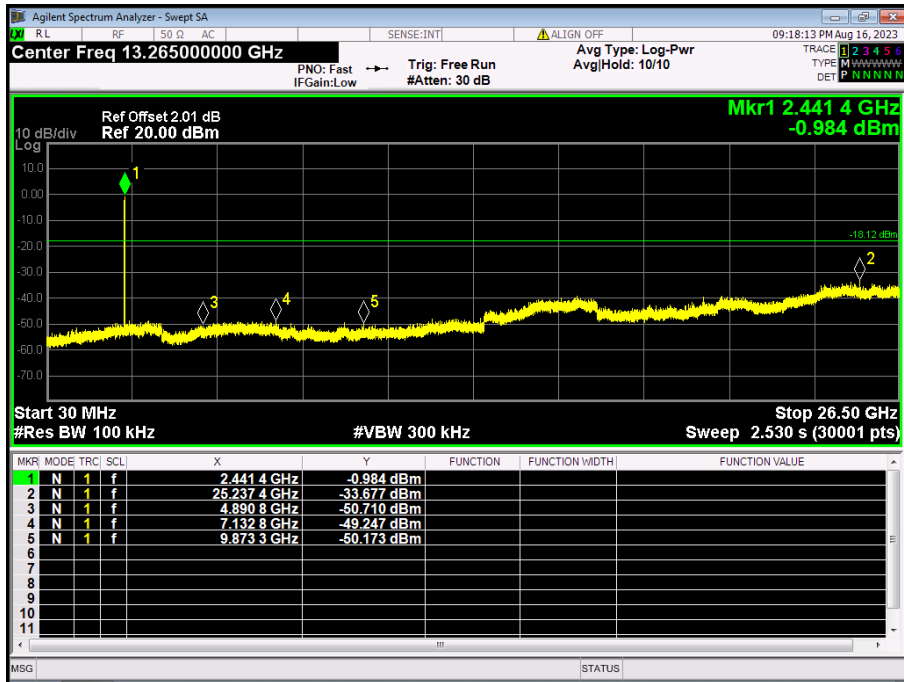

Note: This line in the plots is a reference line for the 20dB down limit, not the limit.

Highest Channel:

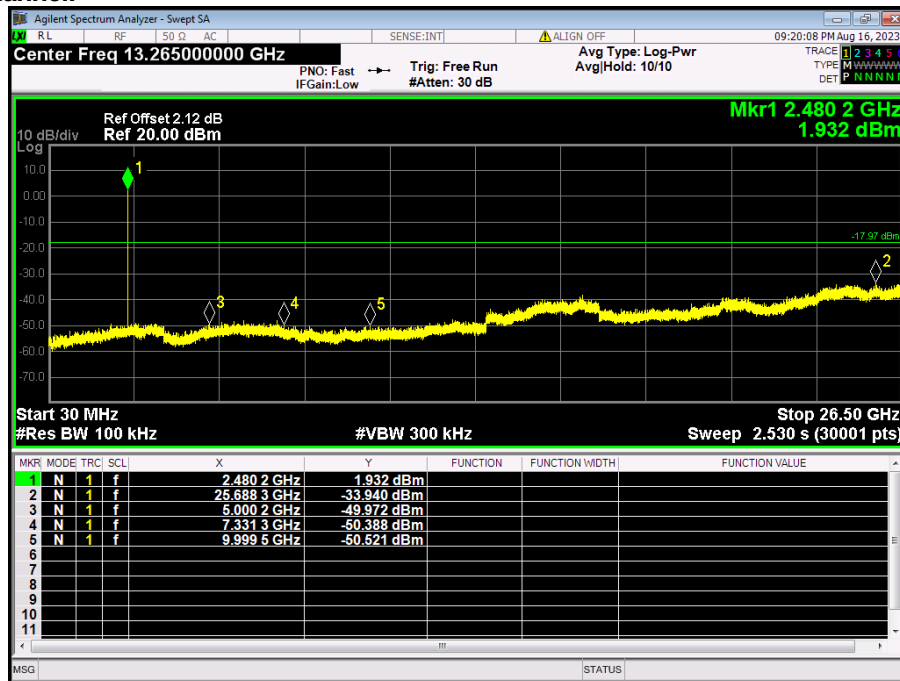

Note: This line in the plots is a reference line for the 20dB down limit, not the limit.

5.9 Radiated Spurious Emissions

Test Requirement: FCC Part15 C section 15.247

(d) In any 100 kHz bandwidth outside the frequency band in which the spread spectrum or digitally modulated intentional radiator is operating. The radio frequency power that is produced by the intentional radiator shall be at least 20 dB below that in the 100 kHz bandwidth within the band that contains the highest level of the desired power, based on either an RF conducted or a radiated measurement, and provided the transmitter demonstrates compliance with the peak conducted power limits.

Test Method: ANSI C63.10:2013

Test Status: Pre-test the EUT in continuous transmitting mode at the lowest, middle and highest channel with different data packet. Compliance test in continuous transmitting mode with normal mode (DH5) as the worst case was found.

Detector: For PK value:

RBW = 1 MHz for $f \geq 1$ GHz, 100 kHz for $f < 1$ GHz, 9kHz for <30 MHz

VBW \geq RBW Sweep = auto

Detector function = peak

Trace = max hold

For AV value:

RBW = 1 MHz for $f \geq 1$ GHz, 100 kHz for $f < 1$ GHz, 9kHz for <30 MHz

VBW =10 Hz

Sweep = auto

Detector function = peak

Trace = max hold

15.209 Limit:

Frequency (MHz)	Field Strength (microvolts/meter)	Measurement Distance (meters)
0.009 - 0.490	2400/F(kHz)	300
0.490 - 1.705	24000/F(kHz)	30
1.705 - 30.0	30	30
30 - 88	100	3
88 - 216	150	3
216 - 960	200	3
Above 960	500	3

Test Configuration:

- 1) 9kHz to 30MHz emissions:

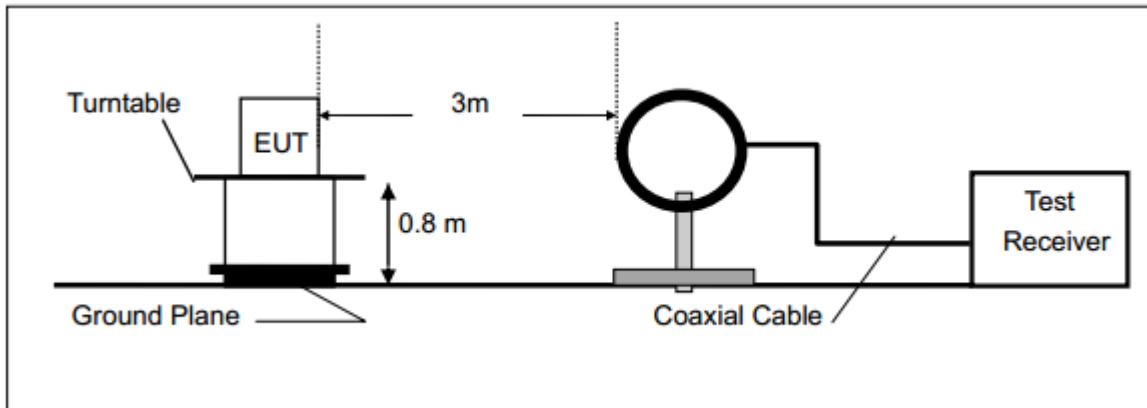

- 2) 30 MHz to 1 GHz emissions:

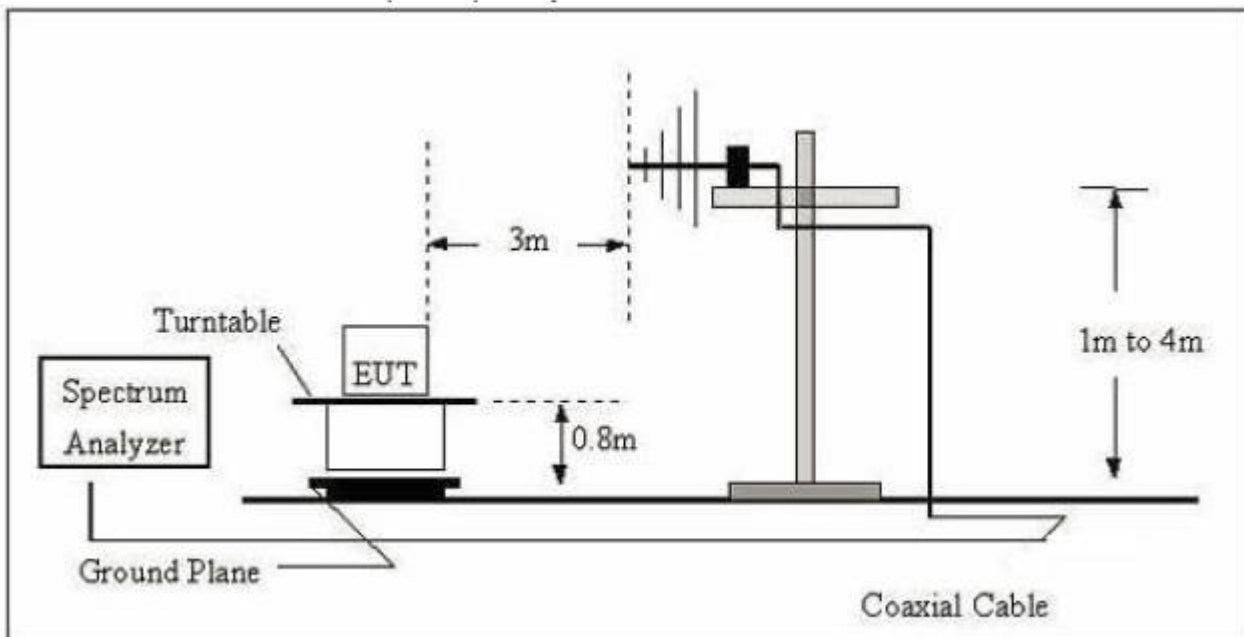

- 3) 1 GHz to 40 GHz emissions:

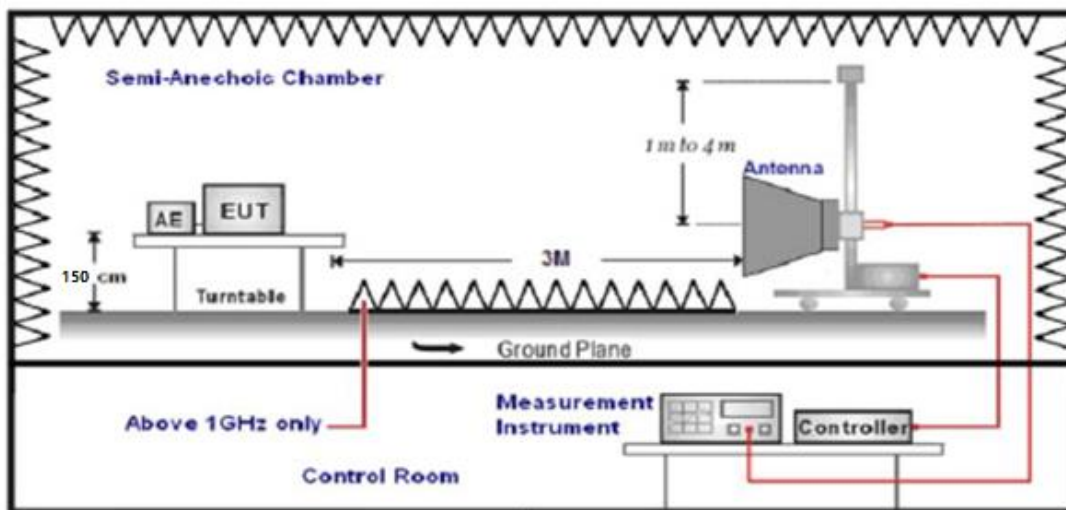

Test Procedure: The receiver was scanned from 9kHz to 25GHz. When an emission was found, the table was rotated to produce the maximum signal strength. An initial pre-scan was performed for in peak detection mode using the receiver. The EUT was measured for both the Horizontal and Vertical polarities and performed a pre-test three orthogonal planes. For intentional radiators, measurements of the variation of the input power or the radiated signal level of the fundamental frequency component of the emission, as appropriate, shall be performed with the supply voltage varied between 85% and 115% of the nominal rated supply voltage. After pre-test, it was found that the worse radiation emission was get at the X position. So the data shown was the X position only. The worst case emissions were reported.

Now set the VBW to 10 Hz, while maintaining all of the other instrument settings. This peak level, once corrected, must comply with the limit specified in Section 15.209. If the dwell time per channel of the hopping signal is less than 100 ms, then the reading obtained with the 10 Hz VBW may be further adjusted by a "duty cycle correction factor", derived from $20\log(\text{dwell time}/100 \text{ ms})$, in an effort to demonstrate compliance with the 15.209 limit. Submit this data.

For the radiated emission test above 1GHz:

Place the measurement antenna away from each area of the EUT determined to be a source of emissions at the specified measurement distance, while keeping the measurement antenna aimed at the source of emissions at each frequency of significant emissions, with polarization oriented for maximum response. The measurement antenna may have to be higher or lower than the EUT, depending on the radiation pattern of the emission and staying aimed at the emission source for receiving the maximum signal. The final measurement antenna elevation shall be that which maximizes the emissions. The measurement antenna elevation for maximum emissions shall be restricted to a range of heights of from 1 m to 4 m above the ground or reference ground plane.

5.9.1 Harmonic and other spurious emissions

Worst case mode DH5

9kHz~30MHz Test result

The Low frequency, which started from 9kHz to 30MHz, was pre-scanned and the result which was 20dB lower than the limit line per 15.31(o) was not report

30 MHz~1 GHz Spurious Emissions .Quasi-Peak Measurement

Horizontal:

Peak scan

Level (dBμV/m)

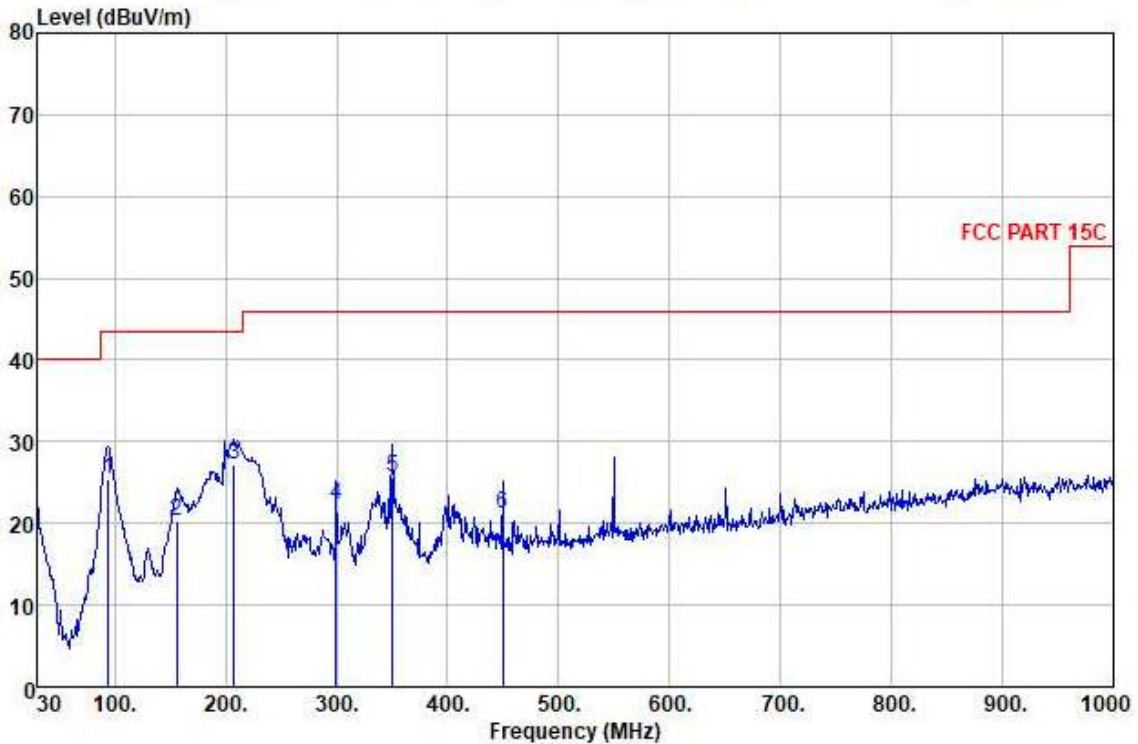

Quasi-peak measurement

No.	Freq MHz	Read Level dBuV	Antenna Factor dB	Cable Loss dB	Preamp Factor dB	Level dBuV/m	Limit Line dBuV/m	Over Limit dB	Pol/Phase	Remark
1	94.020	44.67	8.22	1.13	28.57	25.45	43.50	-18.05	HORIZONTAL	QP
2	156.100	39.23	7.88	1.49	28.29	20.31	43.50	-23.19	HORIZONTAL	QP
3	207.510	42.87	10.21	1.74	27.60	27.22	43.50	-16.28	HORIZONTAL	QP
4	299.660	34.38	13.30	2.12	27.60	22.20	46.00	-23.80	HORIZONTAL	QP
5	350.100	36.28	14.45	2.28	27.30	25.71	46.00	-20.29	HORIZONTAL	QP
6	450.010	30.82	16.30	2.62	28.60	21.14	46.00	-24.86	HORIZONTAL	QP

Level=Read Level + Antenna Factor + Cable Loss - Preamp Factor

30 MHz~1 GHz Spurious Emissions .Quasi-Peak Measurement

Vertical:

Peak scan

Level (dBμV/m)

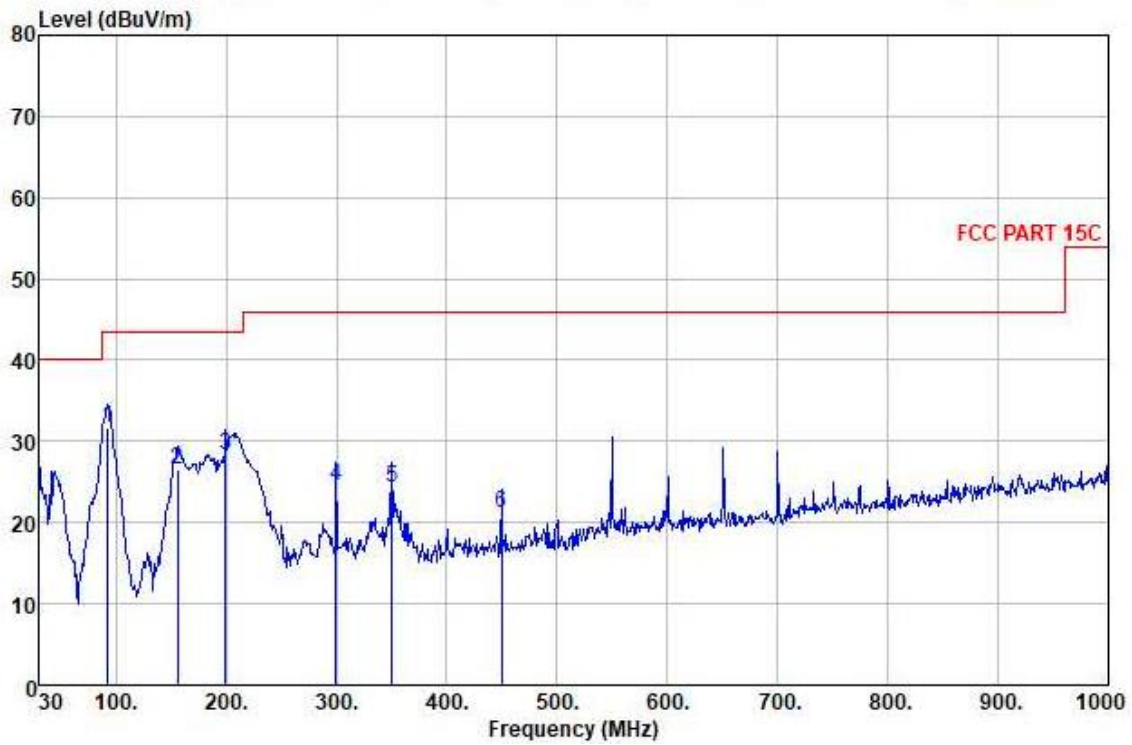

Quasi-peak measurement

No.	Freq MHz	Read Level dBuV	Antenna Factor dB	Cable Loss dB	Preamp Factor dB	Level dBuV/m	Limit Line dBuV/m	Over Limit dB	Pol/Phase	Remark
1	93.050	50.79	8.19	1.13	28.53	31.58	43.50	-11.92	VERTICAL	QP
2	156.100	45.44	7.88	1.49	28.29	26.52	43.50	-16.98	VERTICAL	QP
3	199.750	44.90	9.70	1.70	27.89	28.41	43.50	-15.09	VERTICAL	QP
4	299.660	36.67	13.30	2.12	27.60	24.49	46.00	-21.51	VERTICAL	QP
5	350.100	34.93	14.45	2.28	27.30	24.36	46.00	-21.64	VERTICAL	QP
6	450.010	30.74	16.30	2.62	28.60	21.06	46.00	-24.94	VERTICAL	QP

Level=Read Level + Antenna Factor + Cable Loss - Preamp Factor

Spurious emissions above 1GHz

Test at lowest Channel in transmitting status

Horizontal:

Peak scan

Level (dBµV/m)

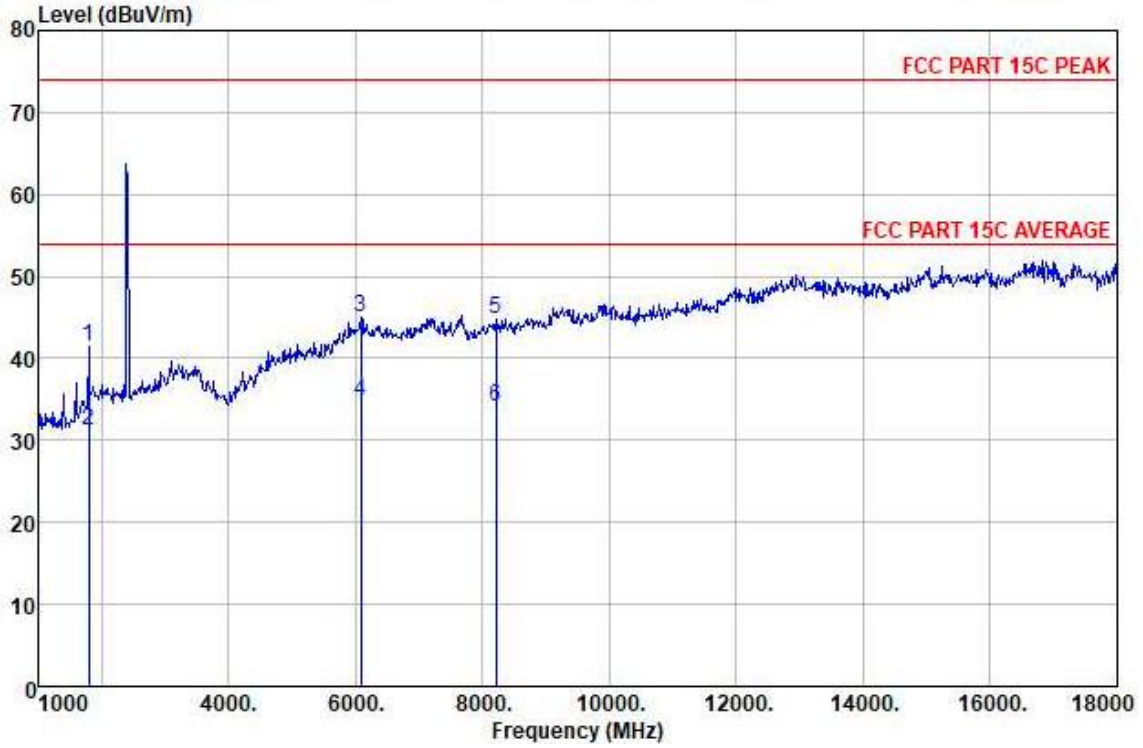

No.	Freq MHz	Read Level dBµV	Antenna Factor dB	Cable Loss dB	Preamp Factor dB	Level dBµV/m	Limit Line dBµV/m	Over Limit dB	Pol/Phase	Remark
1	1799.000	36.92	26.65	5.50	27.60	41.47	74.00	-32.53	HORIZONTAL	Peak
2	1799.000	26.65	26.65	5.50	27.60	31.20	54.00	-22.80	HORIZONTAL	Average
3	6083.000	25.40	35.92	10.99	27.41	44.90	74.00	-29.10	HORIZONTAL	Peak
4	6083.000	15.22	35.92	10.99	27.41	34.72	54.00	-19.28	HORIZONTAL	Average
5	8208.000	21.54	37.33	13.11	27.28	44.70	74.00	-29.30	HORIZONTAL	Peak
6	8208.000	11.01	37.33	13.11	27.28	34.17	54.00	-19.83	HORIZONTAL	Average

Level=Read Level + Antenna Factor + Cable Loss - Preamp Factor

Note: The emission above limit is fundamental emission, which is not subject to the limit.

Vertical:

Peak scan

Level (dBµV/m)

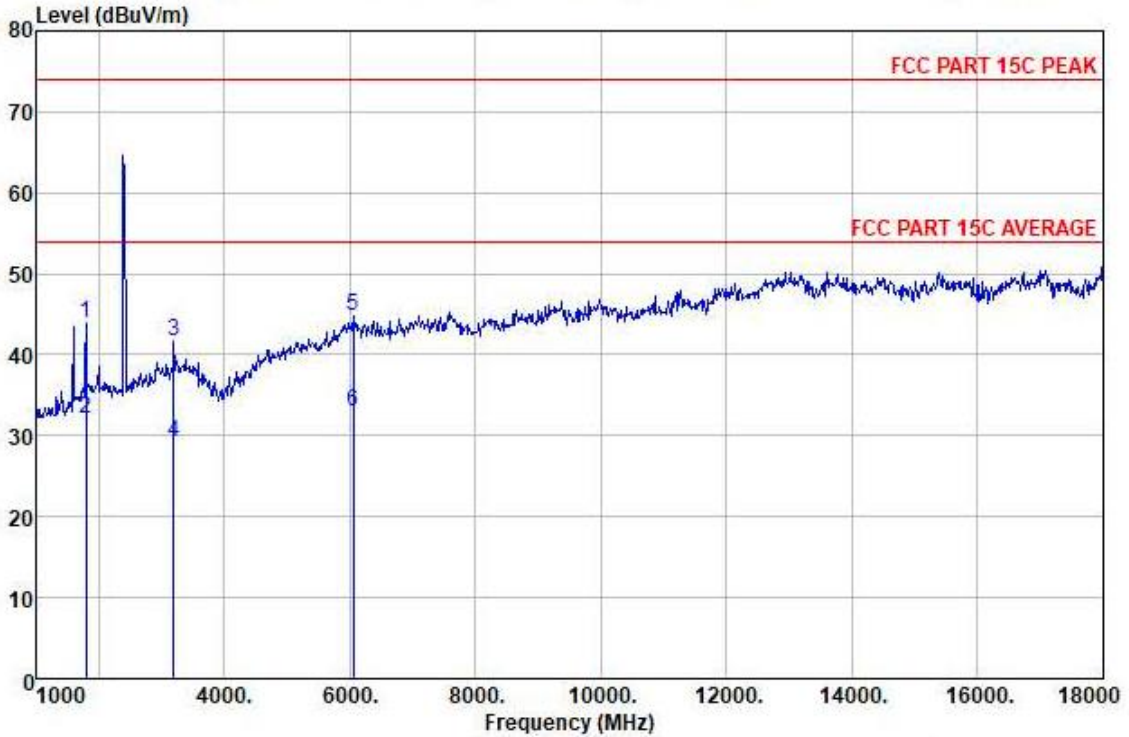

No.	Freq MHz	Read Level dBµV	Antenna Factor dB	Cable Loss dB	Preamp Factor dB	Level dBµV/m	Limit Line dBµV/m	Over Limit dB	Pol/Phase	Remark
1	1799.000	39.46	26.65	5.50	27.60	44.01	74.00	-29.99	VERTICAL	Peak
2	1799.000	27.46	26.65	5.50	27.60	32.01	54.00	-21.99	VERTICAL	Average
3	3193.000	31.59	30.36	7.58	27.84	41.69	74.00	-32.31	VERTICAL	Peak
4	3193.000	19.14	30.36	7.58	27.84	29.24	54.00	-24.76	VERTICAL	Average
5	6049.000	25.26	35.95	10.95	27.42	44.74	74.00	-29.26	VERTICAL	Peak
6	6049.000	13.52	35.95	10.95	27.42	33.00	54.00	-21.00	VERTICAL	Average

Level = Read Level + Antenna Factor + Cable Loss - Preamp Factor

Note: The emission above limit is fundamental emission, which is not subject to the limit.

Test at Middle Channel in transmitting status

Horizontal:

Peak scan

Level (dBµV/m)

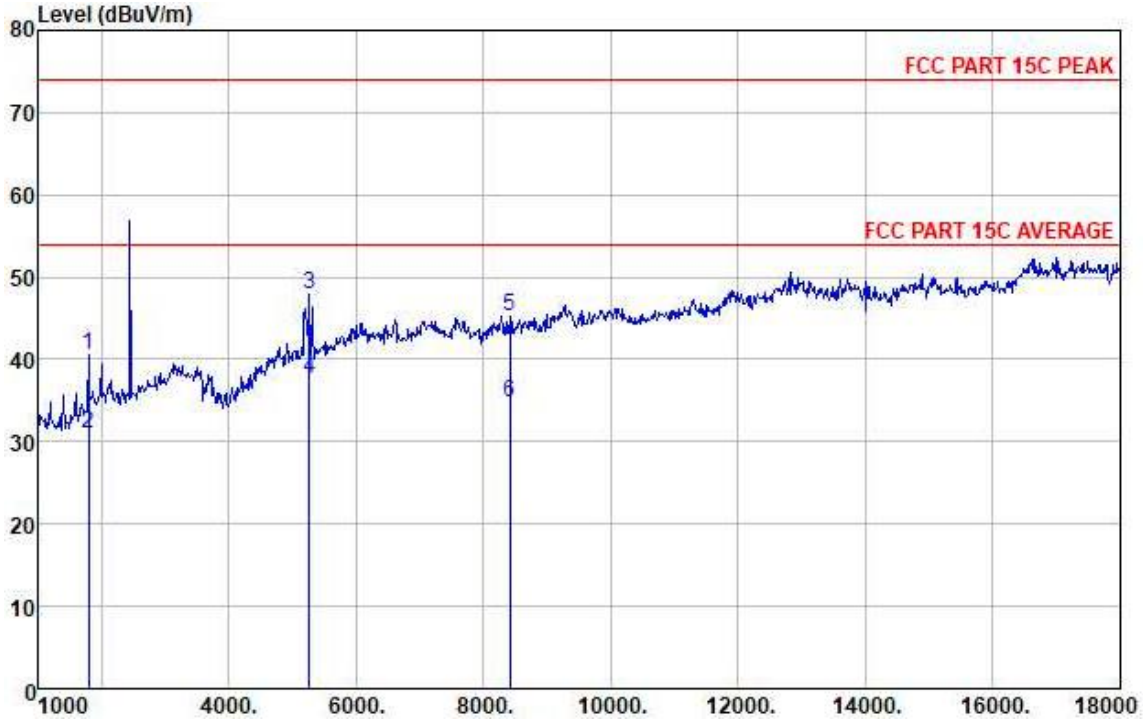

No.	Freq MHz	Read Level dBµV	Antenna Factor dB	Cable Loss dB	Preamp Factor dB	Level dBµV/m	Limit Line dBµV/m	Over Limit dB	Pol/Phase	Remark
1	1799.000	36.10	26.65	5.50	27.60	40.65	74.00	-33.35	HORIZONTAL	Peak
2	1799.000	26.40	26.65	5.50	27.60	30.95	54.00	-23.05	HORIZONTAL	Average
3	5267.000	31.59	33.71	10.10	27.54	47.86	74.00	-26.14	HORIZONTAL	Peak
4	5267.000	21.32	33.71	10.10	27.54	37.59	54.00	-16.41	HORIZONTAL	Average
5	8412.000	21.63	37.66	13.31	27.26	45.34	74.00	-28.66	HORIZONTAL	Peak
6	8412.000	11.14	37.66	13.31	27.26	34.85	54.00	-19.15	HORIZONTAL	Average

Level=Read Level + Antenna Factor + Cable Loss - Preamp Factor

Note: The emission above limit is fundamental emission, which is not subject to the limit.

Vertical:

Peak scan

Level (dBµV/m)

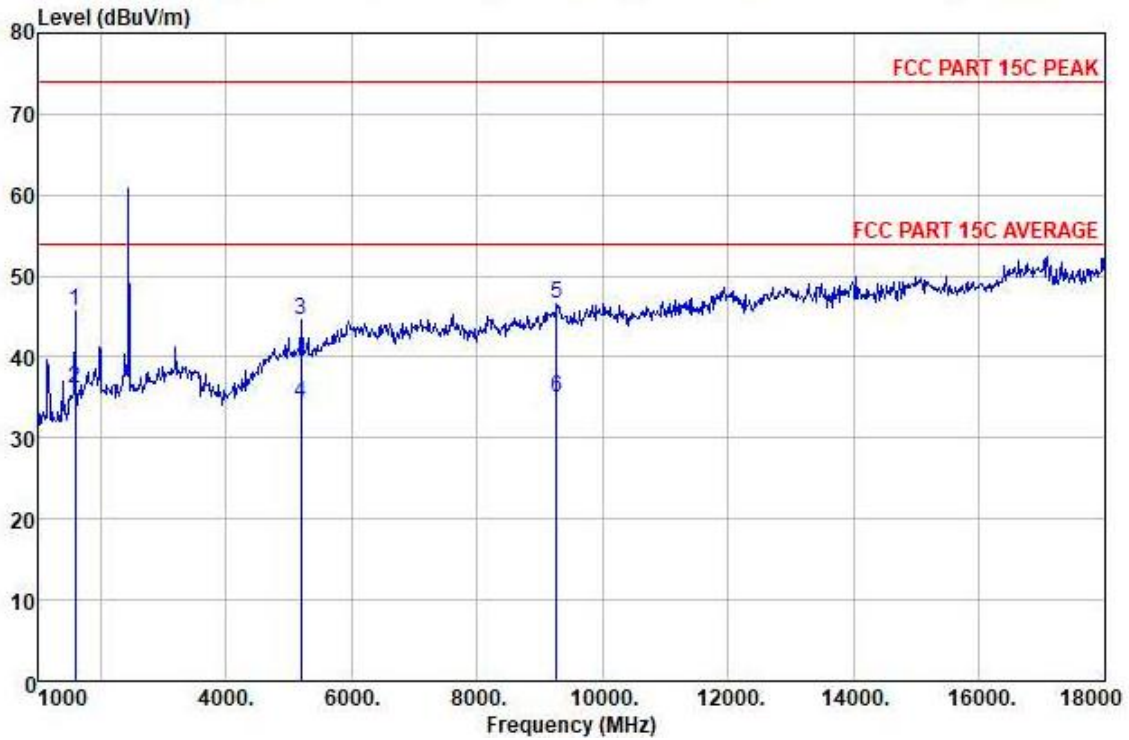

No.	Freq MHz	Read Level dBµV	Antenna Factor dB	Cable Loss dB	Preamp Factor dB	Level dBµV/m	Limit Line dBµV/m	Over Limit dB	Pol/Phase	Remark
1	1595.000	42.89	25.18	5.16	27.51	45.72	74.00	-28.28	VERTICAL	Peak
2	1595.000	33.20	25.18	5.16	27.51	36.03	54.00	-17.97	VERTICAL	Averag
3	5199.000	28.40	33.66	10.02	27.55	44.53	74.00	-29.47	VERTICAL	Peak
4	5199.000	18.10	33.66	10.02	27.55	34.23	54.00	-19.77	VERTICAL	Averag
5	9262.000	20.85	38.80	14.13	27.18	46.60	74.00	-27.40	VERTICAL	Peak
6	9262.000	9.15	38.80	14.13	27.18	34.90	54.00	-19.10	VERTICAL	Averag

Level=Read Level + Antenna Factor + Cable Loss - Preamp Factor

Note: The emission above limit is fundamental emission, which is not subject to the limit.

Test at high Channel in transmitting status

Horizontal:

Peak scan

Level (dBuV/m)

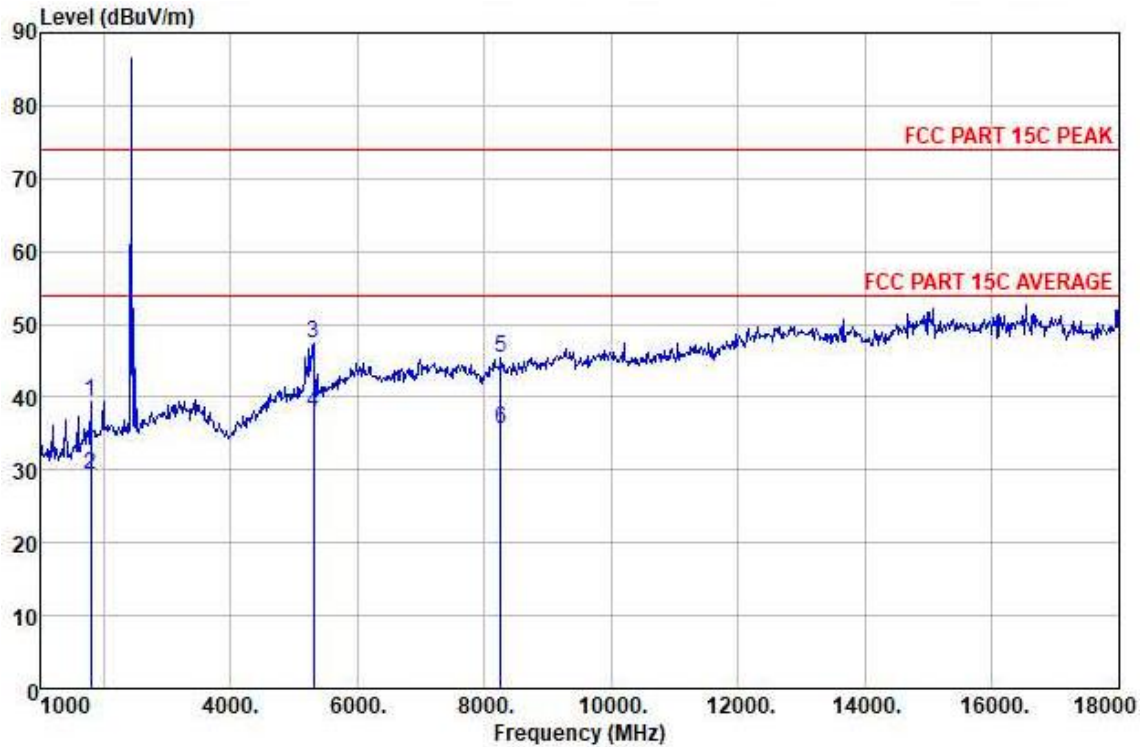

No.	Freq MHz	Read Level dBuV	Antenna Factor dB	Cable Loss dB	Preamp Factor dB	Level dBuV/m	Limit Line dBuV/m	Over Limit dB	Pol/Phase	Remark
1	1799.000	34.90	26.65	5.50	27.60	39.45	74.00	-34.55	HORIZONTAL	Peak
2	1799.000	24.71	26.65	5.50	27.60	29.26	54.00	-24.74	HORIZONTAL	Average
3	5301.000	30.97	33.74	10.14	27.53	47.32	74.00	-26.68	HORIZONTAL	Peak
4	5301.000	21.38	33.74	10.14	27.53	37.73	54.00	-16.27	HORIZONTAL	Average
5	8259.000	21.99	37.41	13.16	27.27	45.29	74.00	-28.71	HORIZONTAL	Peak
6	8259.000	12.42	37.41	13.16	27.27	35.72	54.00	-18.28	HORIZONTAL	Average

Level=Read Level + Antenna Factor + Cable Loss - Preamp Factor

Note: The emission above limit is fundamental emission, which is not subject to the limit.

Vertical:

Peak scan

Level (dBµV/m)

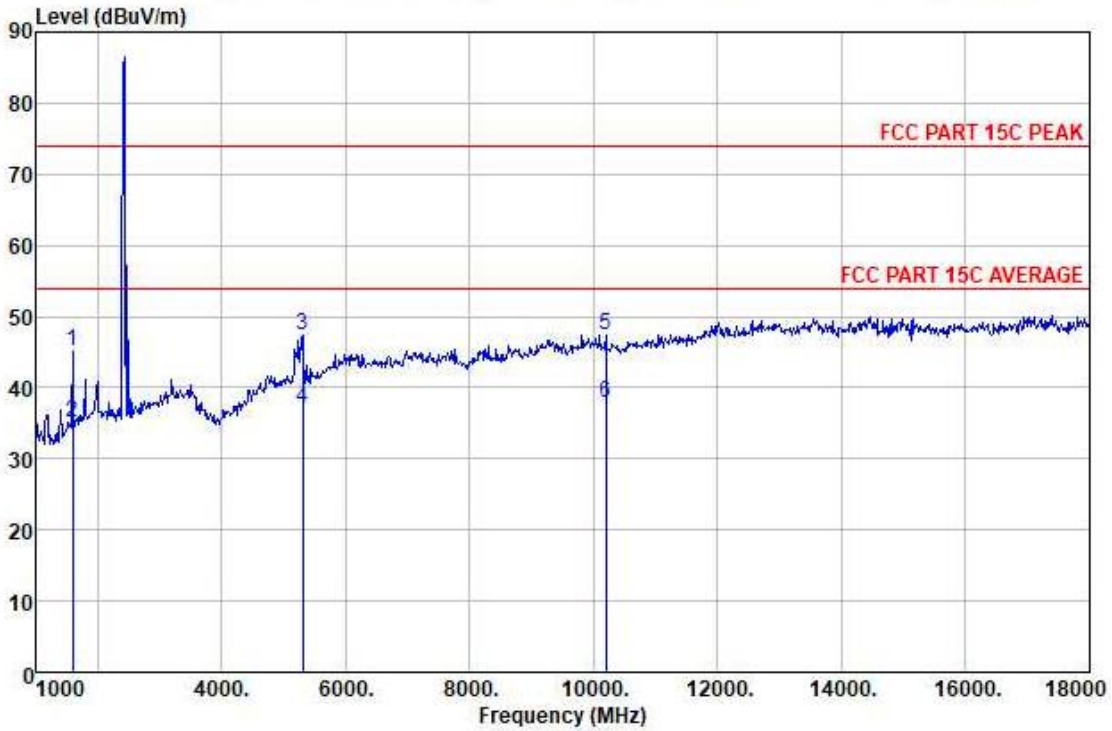

No.	Freq MHz	Read Level dBuV	Antenna Factor dB	Cable Loss dB	Preamp Factor dB	Level dBuV/m	Limit Line dBuV/m	Over Limit dB	Pol/Phase	Remark
1	1595.000	42.24	25.18	5.16	27.51	45.07	74.00	-28.93	HORIZONTAL	Peak
2	1595.000	32.29	25.18	5.16	27.51	35.12	54.00	-18.88	HORIZONTAL	Average
3	5301.000	30.97	33.74	10.14	27.53	47.32	74.00	-26.68	HORIZONTAL	Peak
4	5301.000	20.80	33.74	10.14	27.53	37.15	54.00	-16.85	HORIZONTAL	Average
5	510197.000	20.88	38.84	14.80	27.09	47.43	74.00	-26.57	HORIZONTAL	Peak
6	610197.000	11.40	38.84	14.80	27.09	37.95	54.00	-16.05	HORIZONTAL	Average

Level=Read Level + Antenna Factor + Cable Loss - Preamp Factor

Note: The emission above limit is fundamental emission, which is not subject to the limit.

Remark:

- 1). The field strength is calculated by adding the Antenna Factor. Cable Factor & Preamplifier. The basic equation with a sample calculation is as follows:
Final Test Level =Receiver Reading + Antenna Factor + Cable Loss –Preamplifier Factor.
- 2). As shown in Section, for frequencies above 1000 MHz. the above field strength limits are based on average limits. However, the peak field strength of any emission shall not exceed the maximum permitted average limits specified above by more than 20 dB under any condition of modulation.
- 3). The test only perform the EUT in transmitting status since the test frequencies were over 1GHz only required transmitting status.

Test result: The unit does meet the FCC requirements.

5.10 Radiated Emissions which fall in the restricted bands

Test Requirement: FCC Part15 C Section 15.247

(d) In addition, radiated emissions which fall in the restricted bands. as defined in Section 15.205(a), must also comply with the radiated emission limits specified in Section 15.209(a) (see Section 15.205(c)).

Test Method: ANSI C63.10:2013 Clause 6.4, 6.5 and 6.6

Test Status: Pre-test the EUT in continuous transmitting mode at the lowest (2402MHz), middle (2441 MHz) and highest (2480 MHz) channel with different data packet. Compliance test in continuous transmitting mode with normal mode (DH5) as the worst case was found.

Measurement Distance: 3m (Semi-Anechoic Chamber)

Limit: Section 15.209(a)

Frequency (MHz)	Field Strength (microvolts/meter)	Measurement Distance (meters)
0.009 - 0.490	2400/F(kHz)	300
0.490 - 1.705	24000/F(kHz)	30
1.705 - 30.0	30	30
30 - 88	100	3
88 - 216	150	3
216 - 960	200	3
Above 960	500	3

Detector:

For PK value:

RBW = 1 MHz for $f \geq 1$ GHz, 100 kHz for $f < 1$ GHz

VBW \geq RBW Sweep = auto

Detector function = peak

Trace = max hold

For AV value:

RBW = 1 MHz for $f \geq 1$ GHz, 100 kHz for $f < 1$ GHz

VBW =10 Hz

Sweep = auto

Detector function = peak

Trace = max hold

Test Result:**For Bluetooth**

Pre-test was performed in all modes to find the worst case; compliance test was conducted in DH5 mode as the worst case.

Test mode: DH5

Frequency (MHz)	Reading Level (dB μ V/m)	Correct (dB/m)	Emission Level (dB μ V/m)	Limit (dB μ V/m)	Margin (dB)	Antenna polarization	Detector
Low Channel							
2310.000	32.63	6.54	39.17	74.00	-34.83	H	PK
2310.000	18.74	6.54	25.28	54.00	-28.72	H	AV
2390.000	31.12	6.61	37.73	74.00	-36.27	V	PK
2390.000	19.54	6.61	26.15	54.00	-27.85	V	AV
High Channel							
2483.500	33.32	6.70	40.02	74.00	-33.98	H	PK
2483.500	19.64	6.70	26.34	54.00	-27.66	H	AV
2500.000	31.84	6.72	38.56	74.00	-35.44	V	PK
2500.000	18.35	6.72	25.07	54.00	-28.93	V	AV

Remark: No any other emission which falls in restricted bands can be detected and be reported.

Test result: The unit does meet the FCC requirements.

5.11 Band Edges Requirement

Test Requirement: FCC Part15 C section 15.247

(d) In any 100 kHz bandwidth outside the frequency band in which the spread spectrum or digitally modulated intentional radiator is operating, the radio frequency power that is produced by the intentional radiator shall be at least 20 dB below that in the 100 kHz bandwidth within the band that contains the highest level of the desired power, based on either an RF conducted or a radiated measurement, provided the transmitter demonstrates compliance with the peak conducted power limits. If the transmitter complies with the conducted power limits based on the use of RMS averaging over a time interval, as permitted under paragraph (b)(3) of this section, the attenuation required under this paragraph shall be 30 dB instead of 20 dB. Attenuation below the general limits specified in Section 15.209(a) is not required. In addition, radiated emissions which fall in the restricted bands, as defined in Section 15.205(a), must also comply with the radiated emission limits specified in Section 15.209(a) (see Section 15.205(c)).

Frequency Band: 2400 MHz to 2483.5 MHz

Test Method: ANSI C63.10:2013 Clause 6.9

Test Status: Pre-test the EUT in continuous transmitting mode at the lowest (2402 MHz), and highest (2480 MHz) channel and hopping mode with different data packet. Compliance test in continuous transmitting mode with normal (DH5) EDR mode (2DH5) and EDR mode (3DH5) as the worst case was found.

Test Configuration:

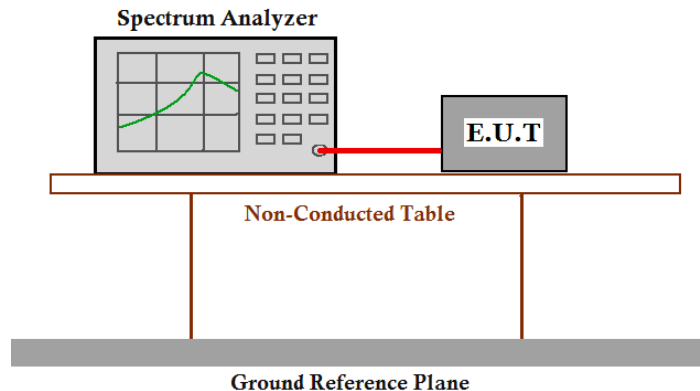

Test Procedure:

Set RBW of spectrum analyzer to 100 kHz and VBW of spectrum analyzer to 300 kHz with suitable frequency span including 10MHz bandwidth from band edge.

The band edges was measured and recorded Result:

The Lower Edges attenuated more than 20dB.

The Upper Edges attenuated more than 20dB.

The graph as below. Represents the emissions take for this device.

For Bluetooth

DH5:

Lowest Channel:

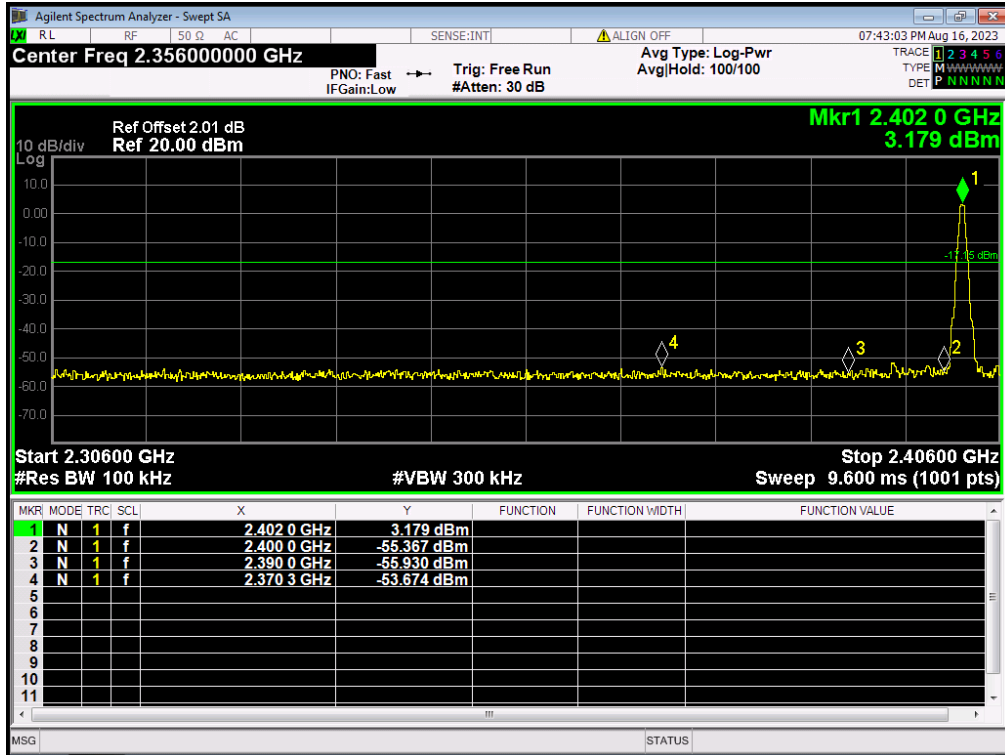

Highest Channel:

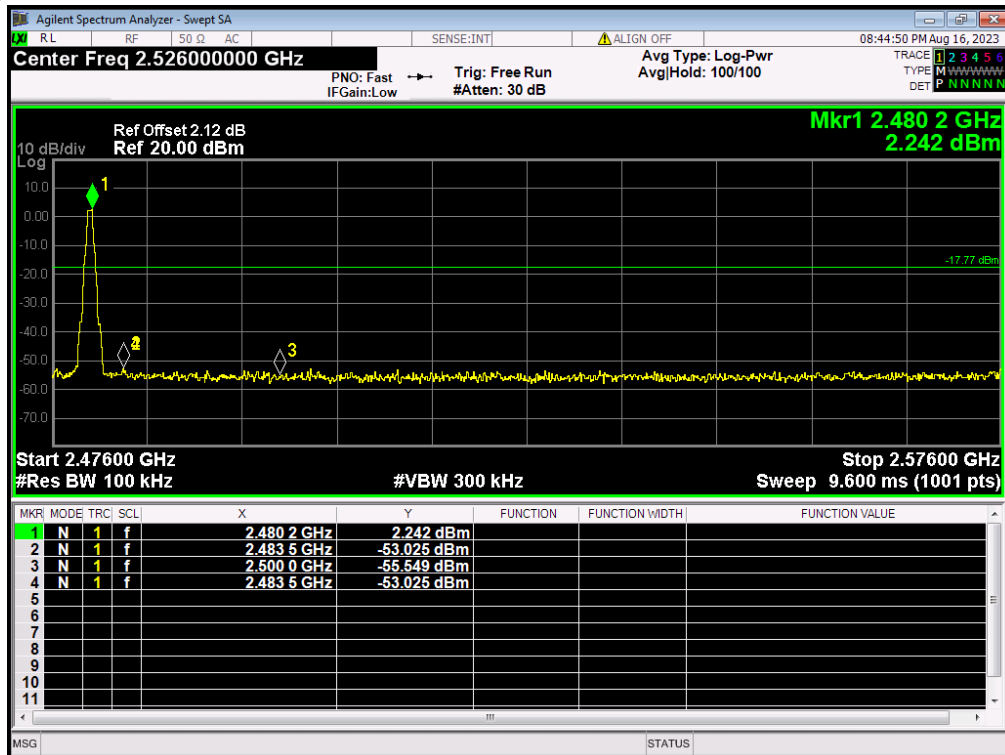

Note: This line in the plots is a reference line for the 20dB down limit, not the limit.

2DH5:
Lowest Channel:

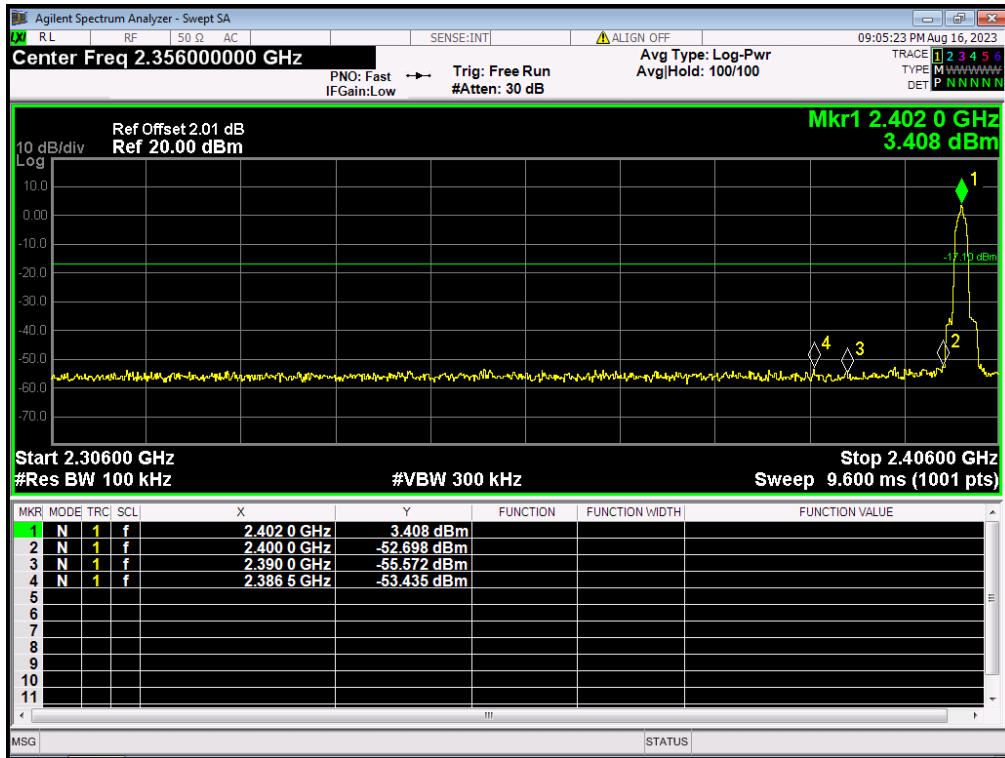

Highest Channel:

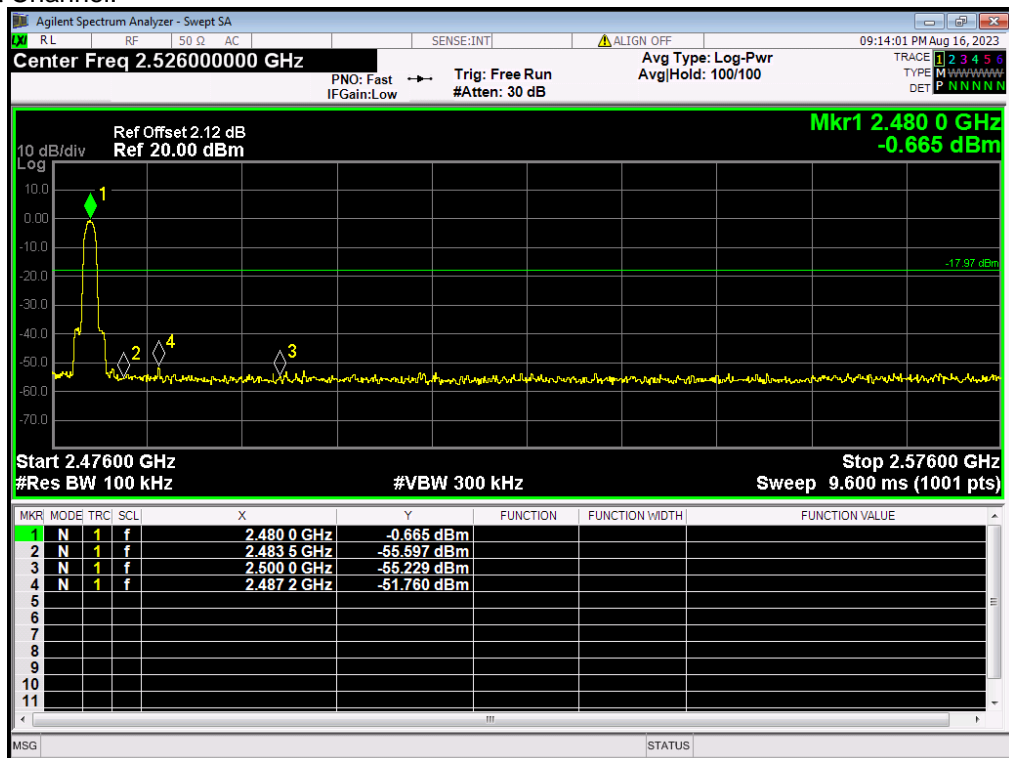

Note: This line in the plots is a reference line for the 20dB down limit, not the limit.

3DH5:
Lowest Channel:

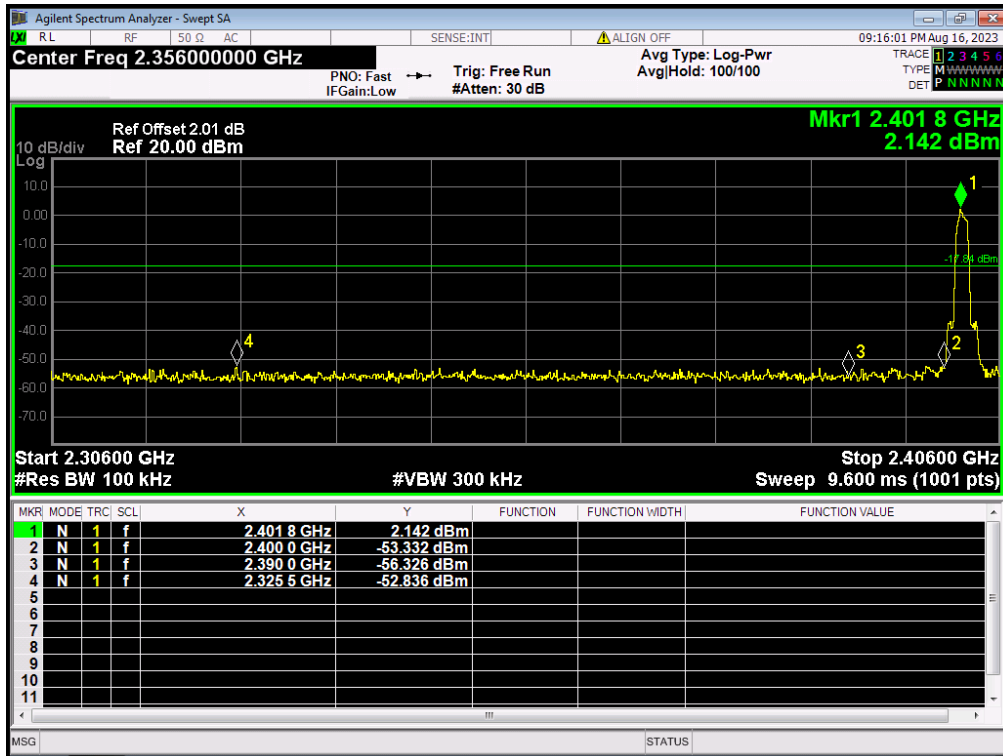

Highest Channel:

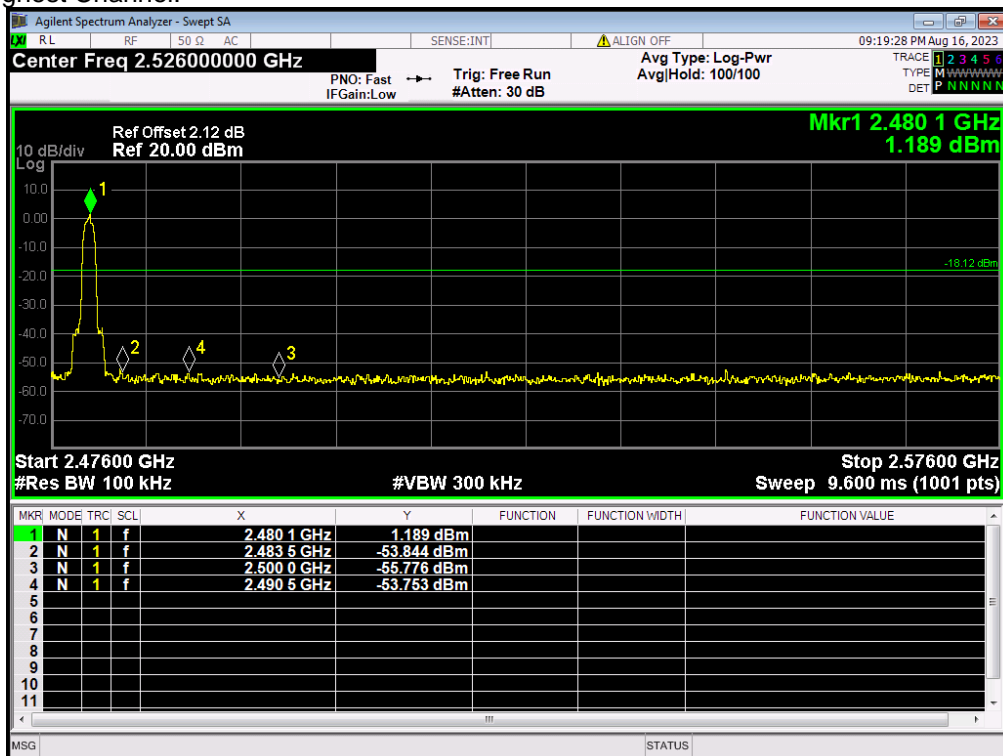

Note: This line in the plots is a reference line for the 20dB down limit, not the limit.

DH5:

Lowest Channel:

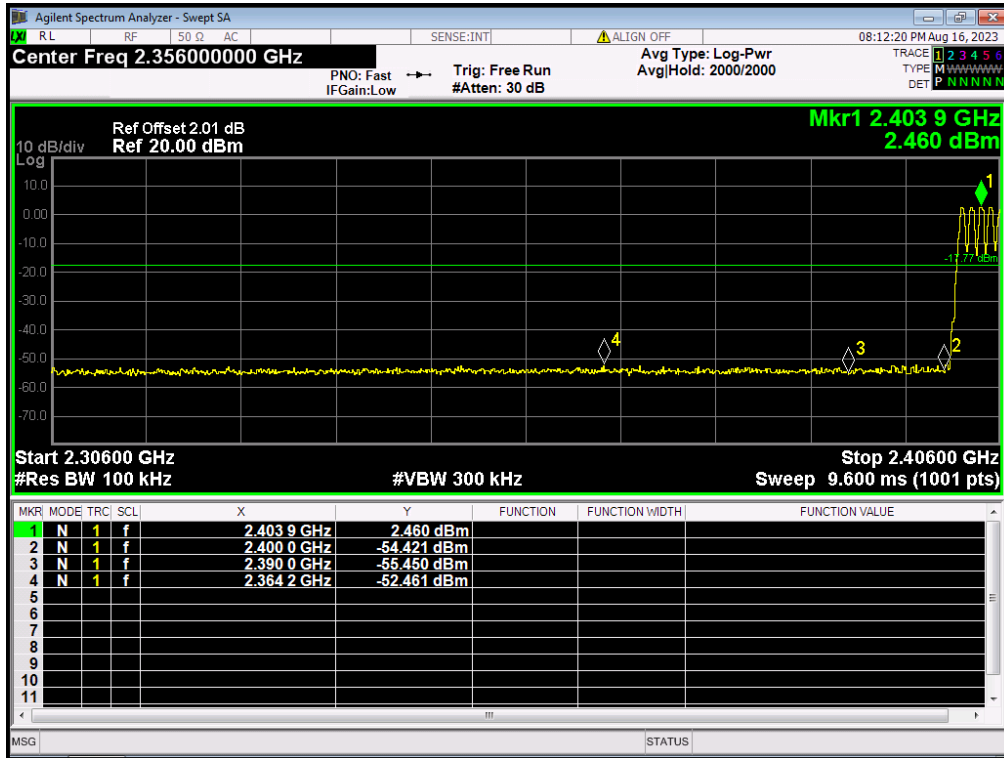

Highest Channel:

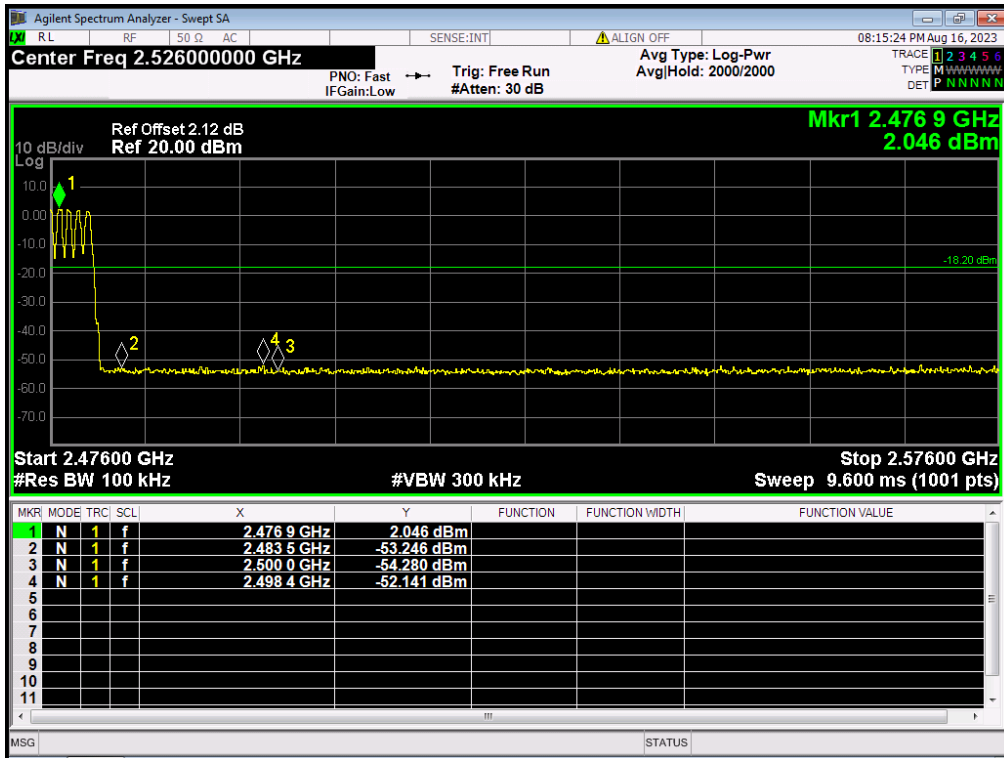

Note: This line in the plots is a reference line for the 20dB down limit, not the limit.

2DH5:

Lowest Channel:

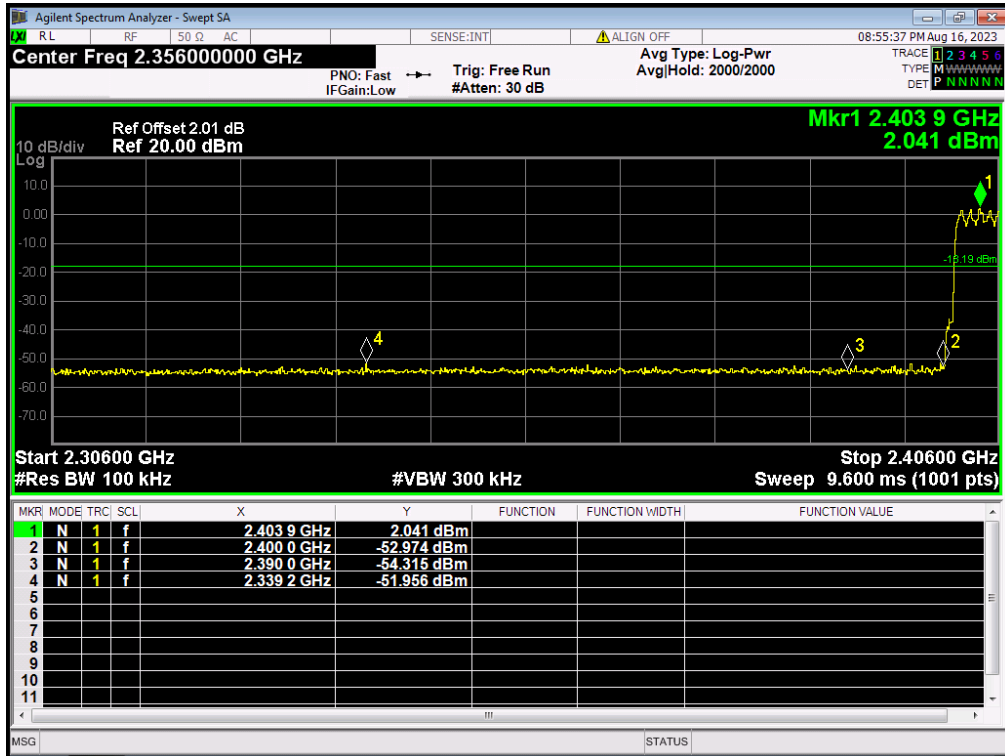

Highest Channel:

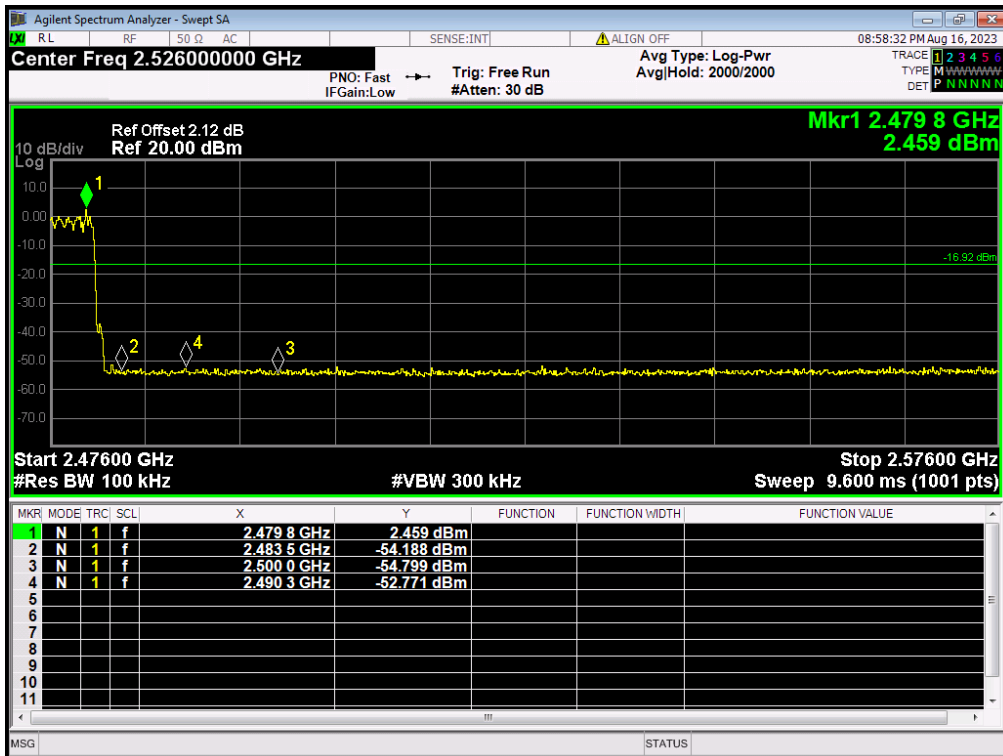

Note: This line in the plots is a reference line for the 20dB down limit, not the limit.

3DH5:

Lowest Channel:

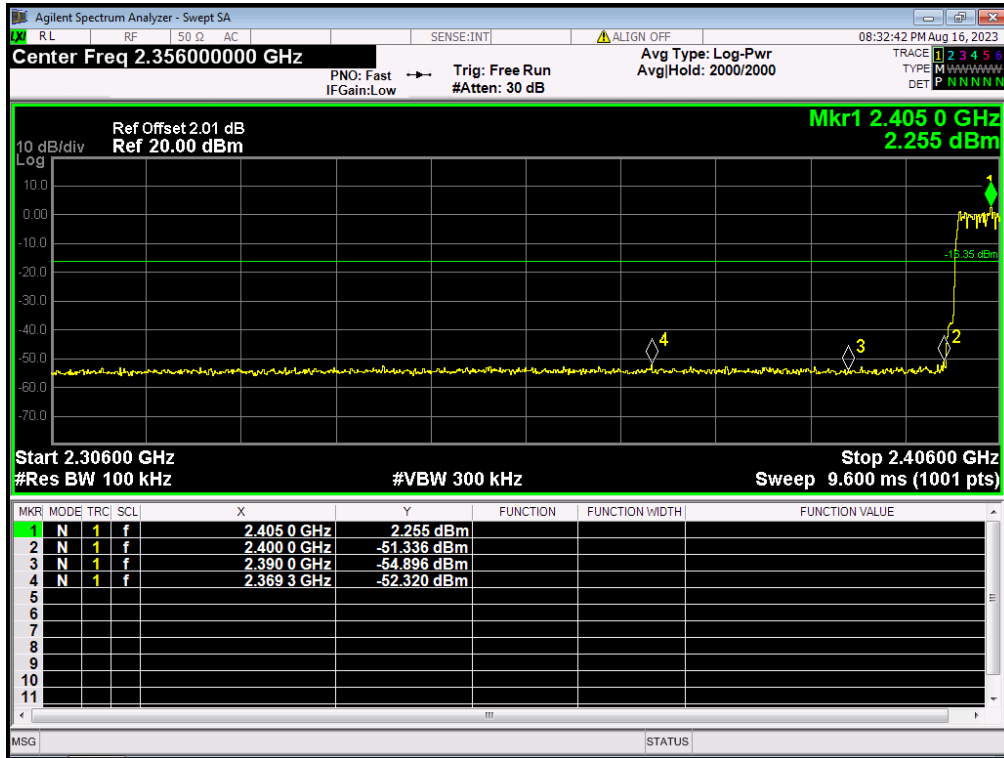

Highest Channel:

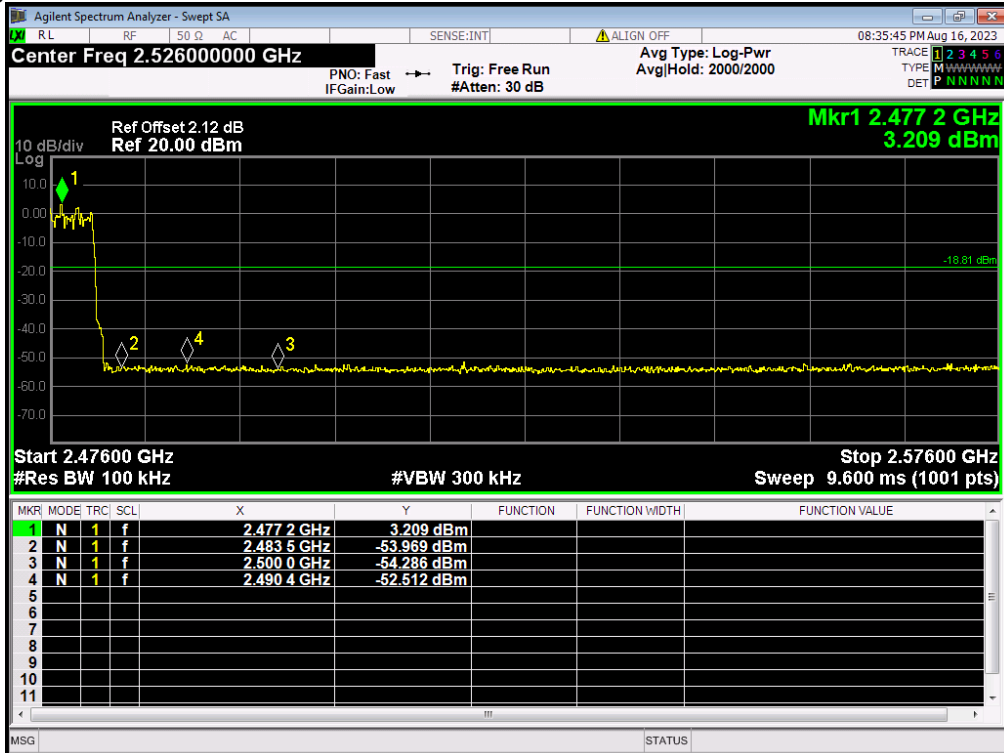

Note: This line in the plots is a reference line for the 20dB down limit, not the limit.

Test result: The unit does meet the FCC requirements.

5.12 Conducted Emissions at Mains Terminals 150 kHz to 30 MHz

Test Requirement: FCC Part 15 C section 15.207

Test Method: ANSI C63.10:2013 Clause 6.2

Test Voltage: 120V AC 60Hz

Frequency Range: 150 KHz to 30 MHz

Detector: Peak for pre-scan (9 KHz Resolution Bandwidth)

Test Limit

Limits for conducted disturbance at the mains ports of class B

Frequency Range	Class B Limit dB(μ V)	
	Quasi-peak	Average
0.15 to 0.50	66 to 56	56 to 46
0.50 to 5	56	46
5 to 30	60	50

NOTE 1 The limit decreases linearly with the logarithm of the frequency in the range 0,15 MHz to 0,50 MHz.

EUT Operation:

Test in normal operating mode. For intentional radiators, measurements of the variation of the input power or the radiated signal level of the fundamental frequency component of the emission, as appropriate, shall be performed with the supply voltage varied between 85% and 115% of the nominal rated supply voltage.

Pre-Scan has been conducted to determine the worst-case mode from all possible combinations between available modulations, data rates and antenna ports (if EUT with antenna diversity architecture).

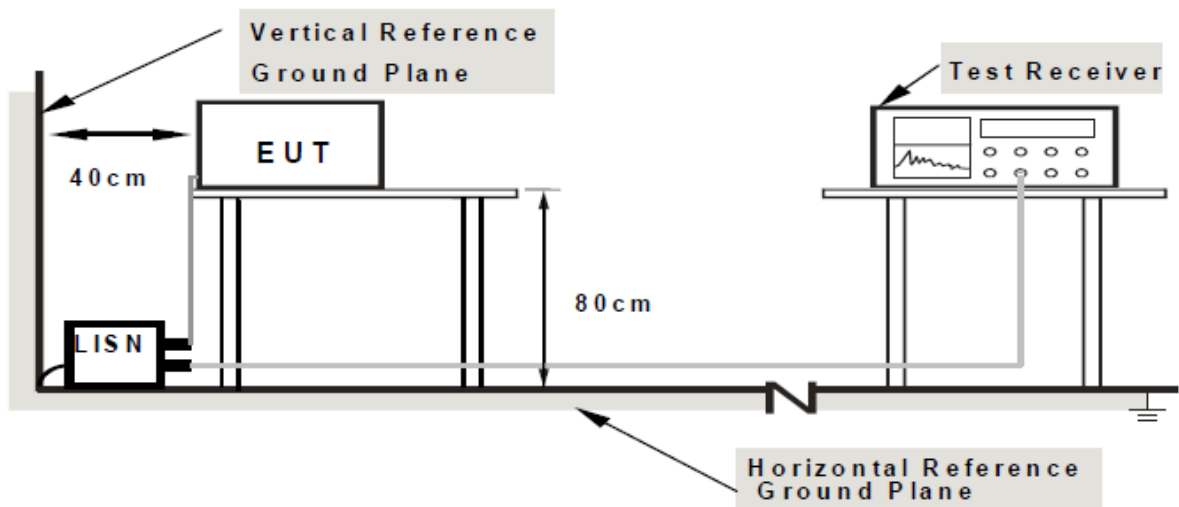
Test Configuration:

Note: 1. Support units were connected to second LISN.

2. Both of LISNs (AMN) are 80 cm from EUT and at least 80 cm from other units and other metal planes

Test procedure:

1. The mains terminal disturbance voltage test was conducted in a shielded room.
2. The tabletop EUT was placed upon a non-metallic table 0.8m above the ground reference plane. And for floor-standing arrangement, the EUT was placed on the horizontal ground reference plane, but separated from metallic contact with the ground reference plane by 0.1m of insulation.

5.12.1 Measurement Data

An initial pre-scan was performed on the live and neutral lines with peak detector.

Quasi-Peak and Average measurement were performed at the frequencies with maximized peak emission were detected. For EUT the communicating was worst case mode.

The following Quasi-Peak and Average measurements were performed on the EUT Live Line

Peak Scan:

Level (dB μ V)

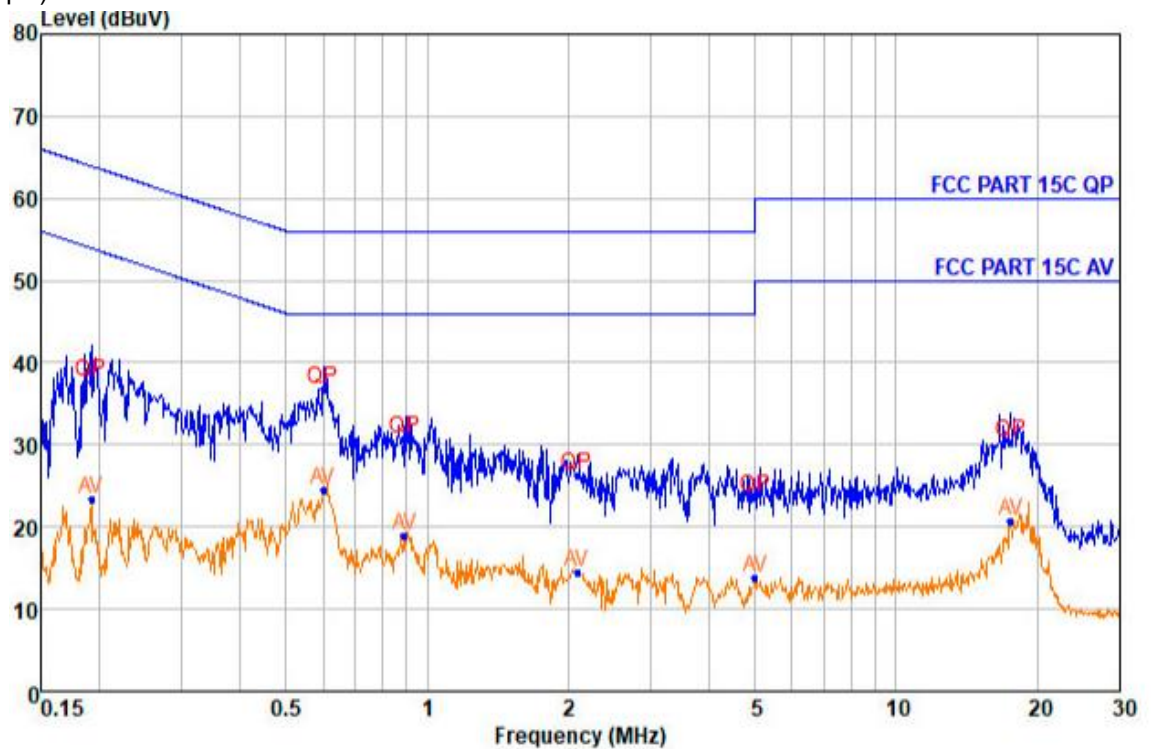

Quasi-peak and Average measurement

NO.	Freq MHz	Level dB μ V	Remark	LISN Factor dB	Cable Loss dB	Limit Line dB μ V	Over Limit dB
1	0.192	37.77	QP	10.06	0.21	63.95	-26.18
2	0.192	23.45	Average	10.06	0.21	53.93	-30.48
3	0.600	36.79	QP	10.01	0.28	56.00	-19.21
4	0.600	24.57	Average	10.01	0.28	46.00	-21.43
5	0.897	30.68	QP	10.01	0.30	56.00	-25.32
6	0.897	18.84	Average	10.01	0.30	46.00	-27.16
7	2.084	26.29	QP	9.99	0.35	56.00	-29.71
8	2.084	14.49	Average	9.99	0.35	46.00	-31.51
9	5.000	23.68	QP	9.88	0.40	56.00	-32.32
10	5.000	13.79	Average	9.88	0.40	46.00	-32.21
11	17.532	30.31	QP	9.44	0.47	60.00	-29.69
12	17.532	20.82	Average	9.44	0.47	50.00	-29.18

Neutral Line

Peak Scan:

Level (dB μ V)

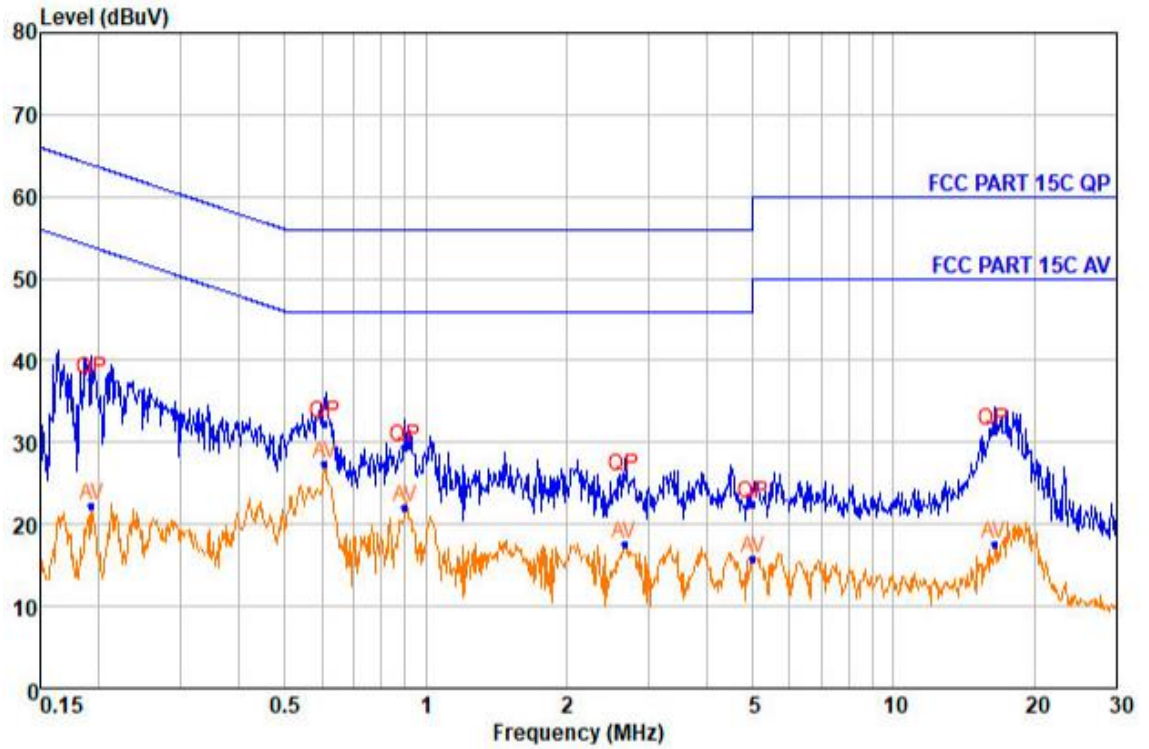

Quasi-peak and Average measurement

NO.	Freq MHz	Level dBuV	Remark	LISN Factor dB	Cable Loss dB	Limit Line dBuV	Over Limit dB
1	0.193	37.71	QP	9.95	0.21	63.90	-26.19
2	0.193	22.26	Average	9.95	0.21	53.89	-31.63
3	0.610	32.39	QP	9.92	0.28	56.00	-23.61
4	0.610	27.37	Average	9.92	0.28	46.00	-18.63
5	0.902	29.30	QP	9.93	0.30	56.00	-26.70
6	0.902	21.95	Average	9.93	0.30	46.00	-24.05
7	2.659	25.93	QP	9.90	0.36	56.00	-30.07
8	2.659	17.65	Average	9.90	0.36	46.00	-28.35
9	5.000	22.40	QP	9.81	0.40	56.00	-33.60
10	5.000	15.81	Average	9.81	0.40	46.00	-30.19
11	16.449	31.32	QP	9.62	0.47	60.00	-28.68
12	16.449	17.69	Average	9.62	0.47	50.00	-32.31

5.13 Other requirements Frequency Hopping Spread Spectrum System

Test Requirement: 47 CFR Part 15C Section 15.247 (a)(1), (h) requirement

The system shall hop to channel frequencies that are selected at the system hopping rate from a Pseudorandom ordered list of hopping frequencies. Each frequency must be used equally on the average by each transmitter. The system receivers shall have input bandwidths that match the hopping channel bandwidths of their corresponding transmitters and shall shift frequencies in synchronization with the transmitted signals.

Frequency hopping spread spectrum systems are not required to employ all available hopping channels during each transmission. However, the system, consisting of both the transmitter and the receiver, must be designed to comply with all of the regulations in this section should the transmitter be presented with a continuous data (or information) stream. In addition, a system employing short transmission bursts must comply with the definition of a frequency hopping system and must distribute its transmissions over the minimum number of hopping channels specified in this section.

The incorporation of intelligence within a frequency hopping spread spectrum system that permits the system to recognize other users within the spectrum band so that it individually and independently chooses and adapts its hopsets to avoid hopping on occupied channels is permitted. The coordination of frequency hopping systems in any other manner for the express purpose of avoiding the simultaneous occupancy of individual hopping frequencies by multiple transmitters is not permitted.

Compliance for section 15.247(a)(1)

According to Bluetooth Core Specification, the pseudorandom sequence may be generated in a nine stage shift register whose 5th and 9th stage outputs are added in a modulo-two addition stage. And the result is fed back to the input of the first stage. The sequence begins with the first ONE of 9 consecutive ONES; i.e. the shift register is initialized with nine ones.

- Number of shift register stages: 9
- Length of pseudo-random sequence: $2^9 - 1 = 511$ bits
- Longest sequence of zeros: 8 (non-inverted signal)

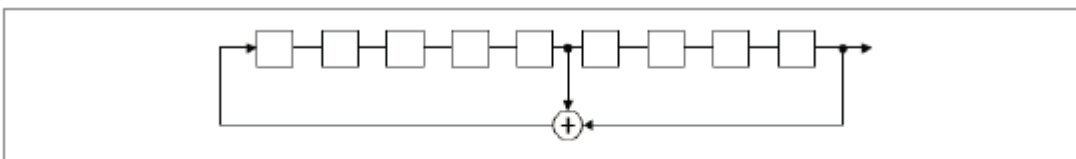

Linear Feedback Shift Register for Generation of the PRBS sequence

An example of Pseudorandom Frequency Hopping Sequence as follow:

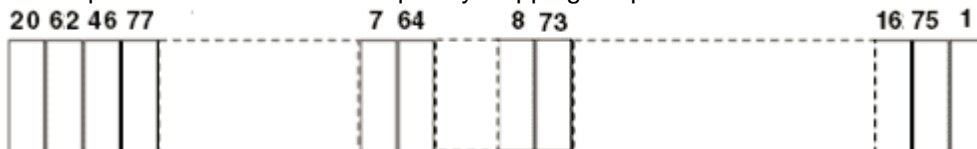

Each frequency used equally on the average by each transmitter.

According to Bluetooth Core Specification, Bluetooth receivers are designed to have input and IF bandwidths that match the hopping channel bandwidths of any Bluetooth transmitters and shift frequencies in synchronization with the transmitted signals.

Compliance for section 15.247(g)

According to Bluetooth Core Specification, the Bluetooth system transmits the packet with the pseudorandom hopping frequency with a continuous data and the short burst transmission from the Bluetooth system is also transmitted under the frequency hopping system with the pseudorandom

hopping frequency system.

Compliance for section 15.247(h)

According to Bluetooth Core specification, the Bluetooth system incorporates with an adaptive system to detect other user within the spectrum band so that it individually and independently to avoid hopping on the occupied channels.

According to the Bluetooth Core specification, the Bluetooth system is designed not have the ability to coordinated with other FHSS System in an effort to avoid the simultaneous occupancy of individual hopping frequencies by multiple transmitter.

--End of Report--