



FCC AND ISED SAR TEST REPORT

Applicant	:	Guoguang Electric Co.,Ltd
Address of Applicant	:	No.8 Jinghu Road, Xinya Street, Huadu Reg, Guangzhou, China
Manufacturer	:	Guoguang Electric Co.,Ltd
Address of Manufacturer	:	No.8 Jinghu Road, Xinya Street, Huadu Reg, Guangzhou, China
Equipment under Test	:	Portable Bluetooth Speaker
Model No.	:	VIFA122
FCC ID	:	2AAP8-VIFA122
Test Standard(s)	:	Test Standard Used: IEEE Std. 1528-2013; IEC/IEEE 62209-1528:2020 FCC Rules and Regulations: 47 CFR § 2.1093 ISED Rules and Regulations: RSS-102 Issue5, Mar. 2015 Test Procedure Used: KDB447498 D01 v06, KDB 865664 D01 v01r04, KDB 865664 D02 v01r02
Report No.	:	DDT-RE23121816-2E04
Issue Date	:	2024/01/18
Issue By	:	Guangdong Dongdian Testing Service Co., Ltd.
Address of Laboratory	:	Unit 2, Building 1, No. 17, Zongbu 2nd Road, Songshan Lake Park, Dongguan, Guangdong, China, 523808

REPORT

Table of Contents

1.	Summary of test results	6
1.1.	Report SAR results	6
1.2.	RF exposure limits	6
2.	General test information.....	7
2.1.	Description of EUT	7
2.2.	RF channel information.....	7
2.3.	Accessories of EUT	8
2.4.	Assistant equipment used for test.....	8
2.5.	Block diagram of EUT configuration for test.....	8
2.6.	Test environment conditions	9
2.7.	Test laboratory	9
3.	SAR measurements system configuration.....	10
3.1.	The SAR measurement system	10
3.2.	Isotropic E-field probe EX3DV4	11
3.3.	SAM twin phantom	11
3.4.	ELI phantom	12
3.5.	Data acquisition electronics (DAE)	12
3.6.	Device holder for transmitters	13
4.	Measurement procedure	14
4.1.	Scanning procedure	14
5.	Description of test position	16
5.1.	Body-worn accessory configurations	16
5.2.	Extremity exposure configurations.....	17
6.	RF exposure conditions	18
6.1.	EUT sides and antenna position	18
6.2.	Standalone SAR test exclusion considerations	18
6.3.	Test sides	20
7.	SAR system verification procedure.....	21
7.1.	Tissue simulate liquid.....	21
7.1.1.	Target dielectric properties of head tissue-equivalent material	21
7.1.2.	Measurement for tissue simulate liquid	21
7.2.	SAR system validation	23
7.2.1.	Justification for extended SAR dipole calibrations.....	24
7.2.2.	Validation test setup photograph	24
7.2.3.	Summary system validation results	25
7.2.4.	Detailed system validation results.....	25

8. Equipment list..... 26

9. Measurement uncertainty..... 27

10. Test results and measurement data 28

10.1. RF conducted power 28

10.2. Measurement of head SAR data..... 29

Appendix..... 30

Test Report Declare

Applicant	:	Guoguang Electric Co.,Ltd
Address of Applicant	:	No.8 Jinghu Road, Xinya Street, Huadu Reg, Guangzhou, China
Manufacturer	:	Guoguang Electric Co.,Ltd
Address of Manufacturer	:	No.8 Jinghu Road, Xinya Street, Huadu Reg, Guangzhou, China
Equipment under Test	:	Portable Bluetooth Speaker
Model No.	:	VIFA122

Test Standard Used:

IEEE Std. 1528-2013; IEC/IEEE 62209-1528:2020

FCC Rules and Regulations: 47 CFR § 2.1093

ISED Rules and Regulations: RSS-102 Issue5, Mar. 2015

Test Procedure Used:

KDB447498 D01 v06, KDB 865664 D01 v01r04, KDB 865664 D02 v01r02

We Declare:

The equipment described above is tested by Guangdong Dongdian Testing Service Co., Ltd and in the configuration tested the equipment complied with the standards specified above. The test results are contained in this test report and Guangdong Dongdian Testing Service Co., Ltd is assumed of full responsibility for the accuracy and completeness of these tests.

After test and evaluation, our opinion is that the equipment provided for test compliance with the requirement of the above FCC and ISED standards.

Report No.:	DDT-RE23121816-2E04		
Date of Receipt:	2023/12/20	Date of Test:	2023/12/20 ~ 2024/01/18

Prepared By:

Approved By:

Johnson Huang

Damon Hu

Johnson Huang/Engineer

Damon Hu/EMC Manager

Note: This report applies to above tested sample only. This report shall not be reproduced in parts without written approval of Guangdong Dongdian Testing Service Co., Ltd.

Revision History

Rev.	Revisions	Issue Date	Revised By
---	Initial issue	2024/01/18	

1. Summary of test results

1.1. Report SAR results

Band	Test Position	Max. Reported SAR (W/kg)	SAR limit (W/kg)	Verdict
Bluetooth	Head(1-g) 0mm	0.06	1.6	Pass

1.2. RF exposure limits

Human Exposure	Uncontrolled Environment General Population	Controlled Environment Occupational
Spatial Average SAR** (Whole Body)	0.08 W/kg	0.40 W/kg
Spatial Peak SAR* (Brain*Trunk)	1.60 W/kg	8.00 W/kg
Spatial Peak SAR*** (Hands/Feet/Ankle/Wrist)	4.00 W/kg	20.00 W/kg

Notes:

- 1) The Spatial Peak value of the SAR averaged over any 1 gram of tissue (defined as a tissue volume in the shape of a cube) and over the appropriate averaging time
- 2) The Spatial Average value of the SAR averaged over the whole body.
- 3) The Spatial Peak value of the SAR averaged over any 10 grams of tissue (defined as a tissue volume in the shape of a cube) and over the appropriate averaging time.
- 4) Uncontrolled Environments are defined as locations where there is the exposure of individuals who have no knowledge or control of their exposure.
- 5) Controlled Environments are defined as locations where there is exposure that may be incurred by persons who are aware of the potential for exposure, (i.e. as a result of employment or occupation.)

2. General test information

2.1. Description of EUT

EUT Name	: Portable Bluetooth Speaker
Model Number	: VIFA122
EUT Function Description	: Please reference user manual of this device
Power Supply	: DC 5V/2A by Type-C port or 3.7V from built-in battery
Radio Specification	: Bluetooth V5.0 (BR/EDR)
Operation Frequency	: Bluetooth (BR/EDR): 2402 MHz-2480 MHz
Modulation	: GFSK, $\pi/4$ -DQPSK, 8DPSK
Data Rate	: 1 Mbps, 2 Mbps, 3 Mbps
Antenna	: PCB antenna, maximum PK gain: 1.83 dBi

Note: EUT is the abbreviation of equipment under test.

2.2. RF channel information

Bluetooth BR/EDR Channel information					
Channel	Frequency (MHz)	Channel	Frequency (MHz)	Channel	Frequency (MHz)
0	2402	27	2429	54	2456
1	2403	28	2430	55	2457
2	2404	29	2431	56	2458
3	2405	30	2432	57	2459
4	2406	31	2433	58	2460
5	2407	32	2434	59	2461
6	2408	33	2435	60	2462
7	2409	34	2436	61	2463
8	2410	35	2437	62	2464
9	2411	36	2438	63	2465
10	2412	37	2439	64	2466
11	2413	38	2440	65	2467
12	2414	39	2441	66	2468
13	2415	40	2442	67	2469
14	2416	41	2443	68	2470
15	2417	42	2444	69	2471
16	2418	43	2445	70	2472
17	2419	44	2446	71	2473
18	2420	45	2447	72	2474
19	2421	46	2448	73	2475
20	2422	47	2449	74	2476

21	2423	48	2450	75	2477
22	2424	49	2451	76	2478
23	2425	50	2452	77	2479
24	2426	51	2453	78	2480
25	2427	52	2454		
26	2428	53	2455		

2.3. Accessories of EUT

Description of Accessories	Manufacturer	Model number	Description	Remark
USB cable	VIFA	N/A	Length: 0.5m, unshielded	N/A

2.4. Assistant equipment used for test

Assistant equipment	Manufacturer	Model number	EMC Compliance	SN
N/A	N/A	N/A	N/A	N/A

2.5. Block diagram of EUT configuration for test



Test software: BlueTest3_3.3.9.exe

The test software was used to control EUT work in Continuous Tx mode, and select test channel, wireless mode as below table.

The pathloss of external cable: 0.5 dB (According to the manufacturer's claims)

Tested mode, channel, information			
Mode	Setting Tx Power	Channel	Frequency (MHz)
GFSK hopping on Tx mode	Default	CH0 to CH78	2402 to 2480
$\pi/4$ -DQPSK hopping on Tx mode	Default	CH0 to CH78	2402 to 2480
8DPSK hopping on Tx mode	Default	CH0 to CH78	2402 to 2480
GFSK hopping off Tx mode	Default	CH0	2402
	Default	CH39	2441
	Default	CH78	2480
$\pi/4$ -DQPSK hopping off Tx mode	Default	CH0	2402
	Default	CH39	2441

	Default	CH78	2480
8DPSK hopping off Tx mode	Default	CH0	2402
	Default	CH39	2441
	Default	CH78	2480
	Worst-case data rates were: GFSK mode: DH5, $\pi/4$ -DQPSK mode: 2DH5, 8DPSK mode: 3DH5		

2.6. Test environment conditions

During the measurement the environmental conditions were within the listed ranges:

Condition	Normal Condition	Extreme Condition
Relative Humidity	20-75%	N/A
Temperature(°C)	18°C-25°C	N/A
Voltage(V)	3.7V	N/A

2.7. Test laboratory

Guangdong Dongdian Testing Service Co., Ltd.

Add: Unit 2, Building 1, No.17, Zongbu 2nd Road, Songshan Lake Park, Dongguan, Guangdong, China, 523808

Tel.: +86-0769-38826678, <http://www.dgddt.com>, Email: ddt@dgddt.com.

CNAS Accreditation No. L6451; A2LA Accreditation Number: 3870.01

FCC Designation Number: CN1182, Test Firm Registration Number: 540522

Innovation, Science and Economic Development Canada Site Registration Number: 10288A

Conformity Assessment Body identifier: CN0048

VCCI facility registration number: C-20087, T-20088, R-20123, R-20155, G-20118

3. SAR measurements system configuration

3.1. The SAR measurement system

This SAR Measurement System uses a computer-controlled 3-D stepper motor system (SPEAG DASY5 professional system). A E-field probe is used to determine the internal electric fields. The SAR can be obtained from the equation $SAR = \sigma (|E_i|^2) / \rho$ where σ and ρ are the conductivity and mass density of the tissue-Simulate.

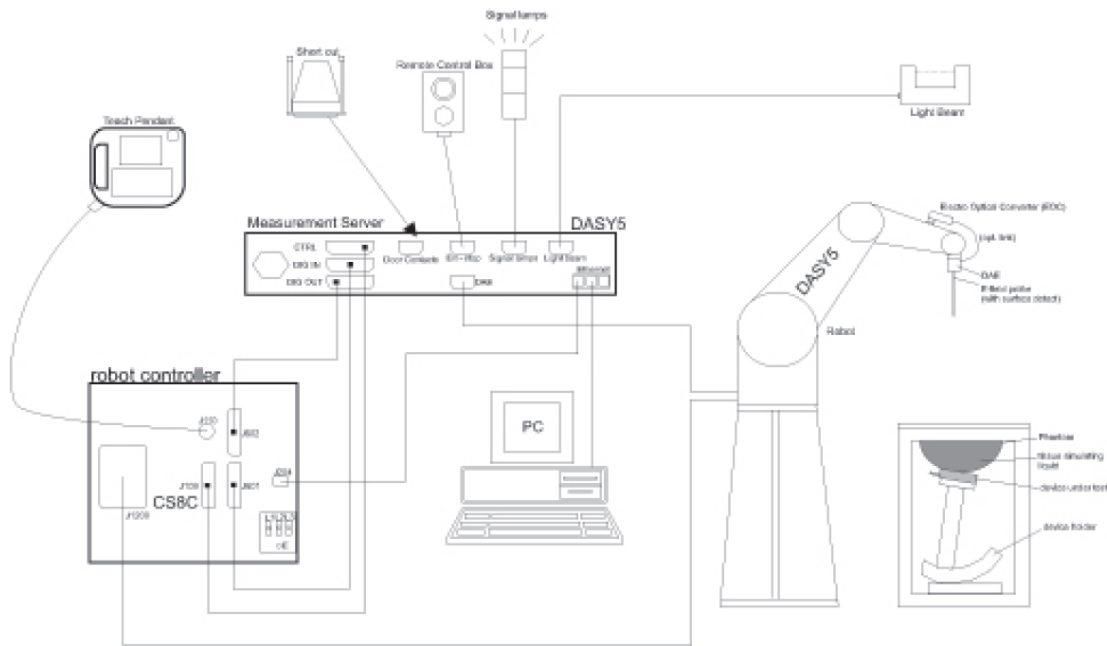

The DASY5 system for performing compliance tests consists of the following items:

- A standard high precision 6-axis robot (Stabile RX family) with controller, teach pendant and software. An arm extension for accommodation the data acquisition electronics (DAE).
- An isotropic E-field probe optimized and calibrated for usage in tissue simulating liquid. The probe is equipped with an optical surface detector system.
- A data acquisition electronics (DAE) which performs the signal amplification, signal multiplexing, AD-conversion, offset measurements, mechanical surface detection, collision detection, etc. The unit is battery powered with standard or rechargeable batteries. The signal is optically transmitted to the EOC.
- The Electro-optical converter (EOC) performs the conversion between optical and electrical of the signals for the digital communication to DAE and for the analog signal from the optical surface detection. The EOC is connected to the measurement server.
- The function of the measurement server is to perform the time critical tasks such as signal filtering, control of the robot operation and fast movement interrupts.
- A probe alignment unit which improves the (absolute) accuracy of the probe positioning.
- A computer operating Windows 7.
- DASY52 software.
- Remote control with teach pendant and additional circuitry for robot safety such as warning

lamps, etc.

- The SAM twin phantom enabling testing left-hand, right-hand and Body Worn usage.
- The device holder for handheld mobile phones.
- Tissue simulating liquid mixed according to the given recipes.
- Validation dipole kits allowing to validating the proper functioning of the system.

3.2. Isotropic E-field probe EX3DV4

	Symmetrical design with triangular core Built-in shielding against static charges PEEK enclosure material (resistant to organic solvents, e.g., DGBE)
Calibration	ISO/IEC 17025 calibration service available.
Frequency	10 MHz to > 6 GHz Linearity: ± 0.2 Db (30 MHz to 6 GHz)
Directivity	± 0.3 Db in TSL (rotation around probe axis) ± 0.5 Db in TSL (rotation normal to probe axis)
Dynamic Range	10 μ W/g to > 100 Mw/g Linearity: ± 0.2 Db (noise: typically < 1 μ W/g)
Dimensions	Overall length: 337 mm (Tip: 20 mm) Tip diameter: 2.5 mm (Body: 12 mm) Typical distance from probe tip to dipole centers: 1 mm
Application	High precision dosimetric measurements in any exposure scenario (e.g., very strong gradient fields); the only probe that enables compliance testing for frequencies up to 6 GHz with precision of better 30%.
Compatibility	DASY3, DASY4, DASY52 SAR and higher, EASY4/MRI

3.3. SAM twin phantom

Material	Vinylester, glass fiber reinforced (VE-GF)	
Liquid Compatibility	Compatible with all SPEAG tissue simulating liquids (incl. DGBE type)	
Shell Thickness	2 ± 0.2 mm (6 ± 0.2 mm at ear point)	
Dimensions (incl. Wooden Support)	Length: 1000 mm Width: 500 mm Height: adjustable feet	
Filling Volume	11esolut. 25 liters	
Wooden Support	SPEAG standard phantom table	
The shell corresponds to the specifications of the Specific Anthropomorphic Mannequin (SAM) phantom defined in IEEE 1528 and IEC 62209-1. It enables the dosimetric evaluation of left and right hand phone usage as well as		

body mounted usage at the flat phantom region. A cover prevents evaporation of the liquid. Reference markings on the phantom allow the complete setup of all predefined phantom positions and measurement grids by teaching three points with the robot.

Twin SAM V5.0 has the same shell geometry and is manufactured from the same material as Twin SAM V4.0, but has reinforced top structure.

3.4. ELI phantom

Material	Vinylester, glass fiber reinforced (VE-GF)	
Liquid Compatibility	Compatible with all SPEAG tissue simulating liquids (incl. DGBE type)	
Shell Thickness	2 ± 0.2 mm (bottom plate)	
Dimensions	Major axis: 600 mm Minor axis: 400 mm	
Filling Volume	12esolut. 30 liters	
Wooden Support	SPEAG standard phantom table	

Phantom for compliance testing of handheld and body-mounted wireless devices in the frequency range of 30 MHz to 6 GHz. ELI is fully compatible with the IEC 62209-2 standard and all known tissue simulating liquids. ELI has been optimized regarding its performance and can be integrated into our standard phantom tables. A cover prevents evaporation of the liquid. Reference markings on the phantom allow installation of the complete setup, including all predefined phantom positions and measurement grids, by teaching three points. The phantom is compatible with all SPEAG dosimetric probes and dipoles.

ELI V5.0 has the same shell geometry and is manufactured from the same material as ELI4, but has reinforced top structure.

3.5. Data acquisition electronics (DAE)

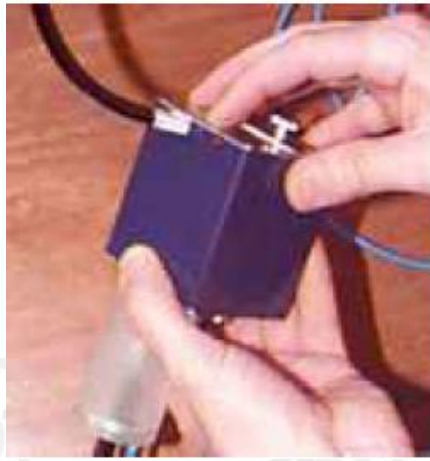
Model	DAE4	
Construction	Signal amplifier, multiplexer, A/D converter and control logic. Serial optical link for communication with DASY4/5 embedded system (fully remote controlled). Two step probe touch detector for mechanical surface detection and emergency robot stop.	
Measurement Range	-100 to +300 mv (16 bit resolution and two range settings: mV, 400 mV)	
Input Offset Voltage	< 5mv (with auto zero)	
Input Bias Current	< 50 fA	
Dimensions	60 x 60 x 68 mm	

3.6. Device holder for transmitters



The DASY device holder is designed to cope with different positions given in the standard. It has two scales for the device rotation (with respect to the body axis) and the device inclination (with respect to the line between the ear reference points). The rotation centres for both scales are the ear reference point (ERP). Thus the device needs no repositioning when changing the angles.

The DASY device holder has been made out of low-loss POM material having the following dielectric parameters: relative permittivity $\epsilon=3$ and loss tangent $\delta=0.02$. The amount of dielectric material has been reduced in the closest vicinity of the device, since measurements have suggested that the influence of the clamp on the test results could thus be lowered.

4. Measurement procedure

4.1. Scanning procedure

Step 1: Power reference measurement

The “reference” and “drift” measurements are located at the beginning and end of the batch process. They measure the field drift at one single point in the liquid over the complete procedure.

Step 2: Area scan

The SAR distribution at the exposed side of the head was measured at a distance of 4mm from the inner surface of the shell. The area covered the entire dimension of the head and the horizontal grid spacing was 15mm*15mm or 12mm*12mm or 10mm*10mm. Based on the area scan data, the area of the maximum absorption was determined by spline interpolation.

Step 3: Zoom scan

Around this point, a volume of 30mm*30mm*30mm (fine resolution volume scan, zoom scan) was assessed by measuring 5x5x7 points ($\leq 2\text{GHz}$) and 7x7x7 points ($\geq 2\text{GHz}$). On this basis of this data set, the spatial peak SAR value was evaluated with the following procedure:

The data at the surface was extrapolated, since the centre of the dipoles is 2.0mm away from the tip of the probe and the distance between the surface and the lowest measuring point is 1.2mm. (This can be variable. Refer to the probe specification). The extrapolation was based on a least square algorithm. A polynomial of the fourth order was calculated through the points in z-axes. This polynomial was then used to evaluate the points between the surface and the probe tip. The maximum interpolated value was searched with a straight-forward algorithm. Around this maximum the SAR values averaged over the spatial volumes (1g or 10g) were computed using the 3D-Spline interpolation algorithm. The volume was integrated with the trapezoidal algorithm. One thousand points were interpolated to calculate the average. All neighbouring volumes were evaluated until no neighboring volume with a higher average value was found.

The area and zoom scan resolutions specified in the table below must be applied to the SAR measurements. Probe boundary effect error compensation is required for measurements with the probe tip closer than half a probe tip diameter to the phantom surface. Both the probe tip diameter and sensor offset distance must satisfy measurement protocols; to ensure probe boundary effect errors are minimized and the higher fields closest to the phantom surface can be correctly measured and extrapolated to the phantom surface for computing 1-g SAR. Tolerances of the post-processing algorithms must be verified by the test laboratory for the scan resolutions used in the SAR measurements, according to the reference distribution functions specified in IEEE 1528-2013.

		≤ 3 GHz	> 3 GHz
Maximum distance from closest measurement point (geometric center of probe sensors) to phantom surface		5 mm \pm 1 mm	$\frac{1}{2} \cdot \delta \cdot \ln(2)$ mm \pm 0.5 mm
Maximum probe angle from probe axis to phantom surface normal at the measurement location		$30^\circ \pm 1^\circ$	$20^\circ \pm 1^\circ$
Maximum area scan spatial resolution: Δx_{Area} , Δy_{Area}		≤ 2 GHz: ≤ 15 mm 2 – 3 GHz: ≤ 12 mm	3 – 4 GHz: ≤ 12 mm 4 – 6 GHz: ≤ 10 mm
		When the x or y dimension of the test device, in the measurement plane orientation, is smaller than the above, the measurement resolution must be \leq the corresponding x or y dimension of the test device with at least one measurement point on the test device.	
Maximum zoom scan spatial resolution: Δx_{Zoom} , Δy_{Zoom}		≤ 2 GHz: ≤ 8 mm 2 – 3 GHz: ≤ 5 mm*	3 – 4 GHz: ≤ 5 mm* 4 – 6 GHz: ≤ 4 mm*
Maximum zoom scan spatial resolution, normal to phantom surface	uniform grid: $\Delta z_{Zoom}(n)$	≤ 5 mm	3 – 4 GHz: ≤ 4 mm 4 – 5 GHz: ≤ 3 mm 5 – 6 GHz: ≤ 2 mm
	graded grid $\Delta z_{Zoom}(1)$: between 1 st two points closest to phantom surface	≤ 4 mm	3 – 4 GHz: ≤ 3 mm 4 – 5 GHz: ≤ 2.5 mm 5 – 6 GHz: ≤ 2 mm
	$\Delta z_{Zoom}(n>1)$: between subsequent points	$\leq 1.5 \cdot \Delta z_{Zoom}(n-1)$ mm	
Minimum zoom scan volume	x, y, z	≥ 30 mm	3 – 4 GHz: ≥ 28 mm 4 – 5 GHz: ≥ 25 mm 5 – 6 GHz: ≥ 22 mm
Note: δ is the penetration depth of a plane-wave at normal incidence to the tissue medium; see IEEE Std 1528-2013 for details.			
* When zoom scan is required and the <i>reported</i> SAR from the <i>area scan based 1-g SAR estimation</i> procedures of KDB Publication 447498 is ≤ 1.4 W/kg, ≤ 8 mm, ≤ 7 mm and ≤ 5 mm zoom scan resolution may be applied, respectively, for 2 GHz to 3 GHz, 3 GHz to 4 GHz and 4 GHz to 6 GHz.			

Step 4: Power reference measurement (drift)

The Power Drift Measurement job measures the field at the same location as the most recent power reference measurement job within the same procedure, and with the same settings. The indicated drift is mainly the variation of the DUT's output power and should vary max. $\pm 5\%$

Step 5: Z-Scan (FCC only)

The Z scan measures points along a vertical straight line. The line runs along the Z-axis of a one-dimensional grid. In order to get a reasonable extrapolation, the extrapolated distance should not be greater than the step size in Z-direction.

5. Description of test position

5.1. Body-worn accessory configurations

Body-worn operating configurations should be tested with the belt-clips and holsters attached to the device and positioned against a flat phantom in normal use configurations.

Body-worn operating configurations are tested with the belt-clips and holsters attached to the device and positioned against a flat phantom in a normal use configuration. Per FCC KDB Publication 648474 D04, Body-worn accessory exposure is typically related to voice mode operations when handsets are carried in body-worn accessories. The body-worn accessory procedures in FCC KDB Publication 447498 D01 should be used to test for body-worn accessory SAR compliance, without a headset connected to it. This enables the test results for such configuration to be compatible with that required for hotspot mode when the body-worn accessory test separation distance is greater than or equal to that required for hotspot mode, when applicable. When the reported SAR for a body-worn accessory, measured without a headset connected to the handset, is > 1.2 W/kg, the highest reported SAR configuration for that wireless mode and frequency band should be repeated for that body-worn accessory with a headset attached to the handset.

Accessories for Body-worn operation configurations are divided into two categories: those that do not contain metallic components and those that do contain metallic components. When multiple accessories that do not contain metallic components are supplied with the device, the device is tested with only the accessory that dictates the closest spacing to the body. Then multiple accessories that contain metallic components are tested with the device with each accessory. If multiple accessories share an identical metallic component (i.e., the same metallic belt-clip used with different holsters with no other metallic components) only the accessory that dictates the closest spacing to the body is tested.

Body-worn accessories may not always be supplied or available as options for some devices intended to be authorized for body-worn use. In this case, a test configuration with a separation distance between the back of the device and the flat phantom is used. Test position spacing was documented. Transmitters that are designed to operate in front of a person's face, as in push-to-talk configurations, are tested for SAR compliance with the front of the device positioned to face the flat phantom in head fluid. For devices that are carried next to the body such as a shoulder, waist or chest-worn transmitters, SAR compliance is tested with the accessories, including headsets and microphones, attached to the device and positioned against a flat phantom in a normal use configuration.

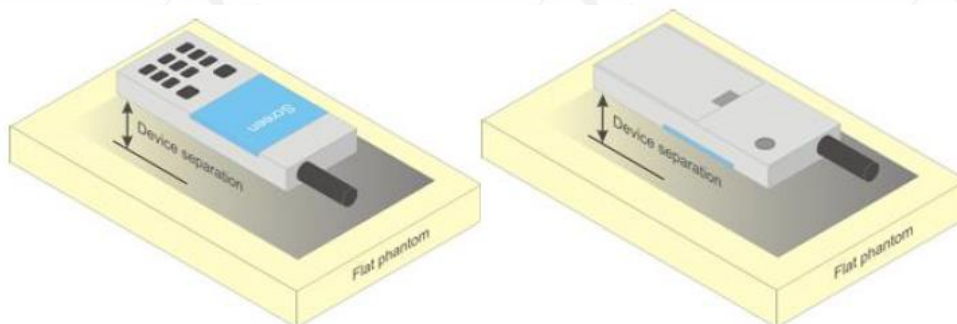

5.2. Extremity exposure configurations

Devices that are designed or intended for use on extremities or mainly operated in extremity only exposure conditions: i.e., hands, wrists, feet and ankles, may require extremity SAR evaluation.

When the device also operates in close proximity to the user's body, SAR compliance for the body is also required. The 1-g body and 10-g extremity SAR Exclusion Thresholds found in KDB Publication 447498 D01v06 should be applied to determine SAR test requirements.

For smart phones with a display diagonal dimension >15.0 cm or an overall diagonal dimension > 16.0 cm that provide similar mobile web access and multimedia support found in mini-tablets or UMPC mini-tablets that support voice calls next to the ear. the phablets procedures outlined in KDB Publication 648474 D04 v01r03 should be applied to evaluate SAR compliance. A device marketed as phablets, regardless of form factors and operating characteristics must be tested as a phablet to determine SAR compliance. In addition to the normally required head and body-worn accessory SAR test procedures required for handsets, the UMPC mini-tablet procedures must also be applied to test the SAR of all surfaces and edges with an antenna ≤ 25 mm from that surface or edge, in direct contact with the phantom, for 10-g SAR. The UMPC mini-tablet 1-g SAR at 5 mm is not required. When hotspot mode applies, 10-g SAR is required only for the surfaces and edges with hotspot to the maximum output power (including tolerance) is 1-g SAR > 1.2 W/kg.

6. RF exposure conditions

6.1. EUT sides and antenna position

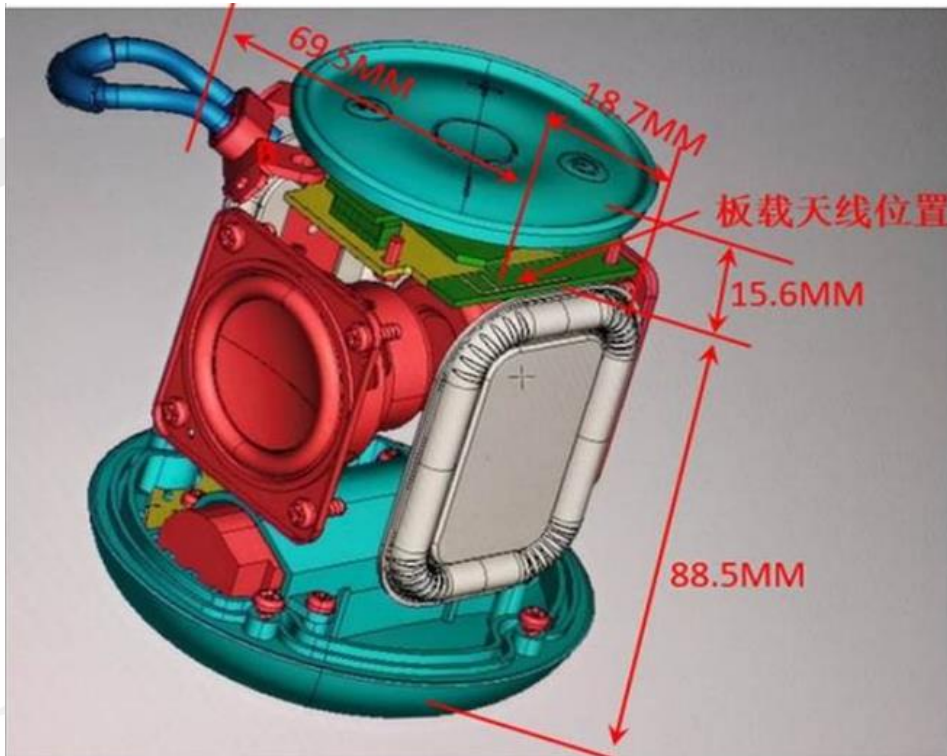

Review

6.2. Standalone SAR test exclusion considerations

According to the KDB447498, the SAR test exclusion threshold:

MHz	5	10	15	20	25	mm
150	39	77	116	155	194	SAR Test Exclusion Threshold (mW)
300	27	55	82	110	137	
450	22	45	67	89	112	
835	16	33	49	66	82	
900	16	32	47	63	79	
1500	12	24	37	49	61	
1900	11	22	33	44	54	
2450	10	19	29	38	48	
3600	8	16	24	32	40	
5200	7	13	20	26	33	
5400	6	13	19	26	32	
5800	6	12	19	25	31	
MHz	30	35	40	45	50	
150	232	271	310	349	387	SAR Test Exclusion Threshold (mW)
300	164	192	219	246	274	
450	134	157	179	201	224	
835	98	115	131	148	164	
900	95	111	126	142	158	
1500	73	86	98	110	122	
1900	65	76	87	98	109	
2450	57	67	77	86	96	
3600	47	55	63	71	79	
5200	39	46	53	59	66	
5400	39	45	52	58	65	
5800	37	44	50	56	62	

According to RSS-102, the SAR test exclusion threshold:

Frequency (MHz)	Exemption Limits (mW)				
	At separation distance of ≤ 5 mm	At separation distance of 10 mm	At separation distance of 15 mm	At separation distance of 20 mm	At separation distance of 25 mm
≤ 300	71 mW	101 mW	132 mW	162 mW	193 mW
450	52 mW	70 mW	88 mW	106 mW	123 mW
835	17 mW	30 mW	42 mW	55 mW	67 mW
1900	7 mW	10 mW	18 mW	34 mW	60 mW
2450	4 mW	7 mW	15 mW	30 mW	52 mW
3500	2 mW	6 mW	16 mW	32 mW	55 mW
5800	1 mW	6 mW	15 mW	27 mW	41 mW

Frequency (MHz)	Exemption Limits (mW)				
	At separation distance of 30 mm	At separation distance of 35 mm	At separation distance of 40 mm	At separation distance of 45 mm	At separation distance of ≥ 50 mm
≤ 300	223 mW	254 mW	284 mW	315 mW	345 mW
450	141 mW	159 mW	177 mW	195 mW	213 mW
835	80 mW	92 mW	105 mW	117 mW	130 mW
1900	99 mW	153 mW	225 mW	316 mW	431 mW
2450	83 mW	123 mW	173 mW	235 mW	309 mW
3500	86 mW	124 mW	170 mW	225 mW	290 mW
5800	56 mW	71 mW	85 mW	97 mW	106 mW

6.3. Test sides

SAR test sides							
Antenna	Band	Head & Extremities					
		Front	Back	Top	Bottom	Left	Right
ANT	BT	√	√	√	√	√	√

Note: The Head SAR test distance is 0mm between EUT outer surface with the phantom.

7. SAR system verification procedure

7.1. Tissue simulate liquid

7.1.1. Target dielectric properties of head tissue-equivalent material

Frequency (MHz)	Relative permittivity (ϵ_r)	Conductivity (σ) (S/m)
300	45.3	0.87
450	43.5	0.87
<i>750</i>	<i>41.9</i>	<i>0.89</i>
835	41.5	0.90
900	41.5	0.97
1450	40.5	1.20
<i>1500</i>	<i>40.4</i>	<i>1.23</i>
<i>1640</i>	<i>40.2</i>	<i>1.31</i>
<i>1750</i>	<i>40.1</i>	<i>1.37</i>
1800	40.0	1.40
1900	40.0	1.40
2000	40.0	1.40
<i>2100</i>	<i>39.8</i>	<i>1.49</i>
<i>2300</i>	<i>39.5</i>	<i>1.67</i>
2450	39.2	1.80
<i>2600</i>	<i>39.0</i>	<i>1.96</i>
3000	38.5	2.40
<i>3500</i>	<i>37.9</i>	<i>2.91</i>
<i>4000</i>	<i>37.4</i>	<i>3.43</i>
<i>4500</i>	<i>36.8</i>	<i>3.94</i>
<i>5000</i>	<i>36.2</i>	<i>4.45</i>
<i>5200</i>	<i>36.0</i>	<i>4.66</i>
<i>5400</i>	<i>35.8</i>	<i>4.86</i>
<i>5600</i>	<i>35.5</i>	<i>5.07</i>
5800	35.3	5.27
<i>6000</i>	<i>35.1</i>	<i>5.48</i>

NOTE—For convenience, permittivity and conductivity values at some frequencies that are not part of the original data from Drossos et al. [B60] or the extension to 5800 MHz are provided (i.e., the values shown in italics). These values were linearly interpolated between the values in this table that are immediately above and below these values, except the values at 6000 MHz that were linearly extrapolated from the values at 3000 MHz and 5800 MHz.

7.1.2. Measurement for tissue simulate liquid

The dielectric properties for this Tissue Simulate Liquids were measured by using the Agilent Model 85070E Dielectric Probe in conjunction with Agilent E5071C Network Analyzer (300 KHz-8500 MHz). The Conductivity (σ) and Permittivity (ρ) are listed in table. For the SAR measurement given in this report. The temperature variation of the Tissue Simulate Liquids was $\pm 2^\circ\text{C}$.

Tissue Type	Freq. (MHz)	Target Tissue ($\pm 5\%$)		Measured Tissue		Liquid Temp. ($^{\circ}\text{C}$)	Measured Date
		ϵ_r	$\sigma(\text{S/m})$	ϵ_r	$\sigma(\text{S/m})$		
2.4G head	2360	39.38 (37.411~41.349)	1.722 (1.6359~1.808)	39.75	1.749	23.0	2024/01/11
	2402	39.3 (37.33~41.27)	1.76 (1.672~1.848)	39.71	1.778	23.0	2024/01/11
	2440	39.22 (37.25~41.18)	1.79 (1.7005~1.879)	39.68	1.811	23.0	2024/01/11
	2441	39.22 (37.25~41.18)	1.79 (1.7005~1.879)	39.68	1.812	23.0	2024/01/11
	2450	39.20 (37.240~41.160)	1.80 (1.710~1.890)	39.68	1.822	23.0	2024/01/11
	2480	39.16 (37.20~41.12)	1.83 (1.750~1.920)	39.66	1.846	23.0	2024/01/11
	2540	39.02 (37.069~40.971)	1.878 (1.7841~1.972)	39.60	1.898	23.0	2024/01/11

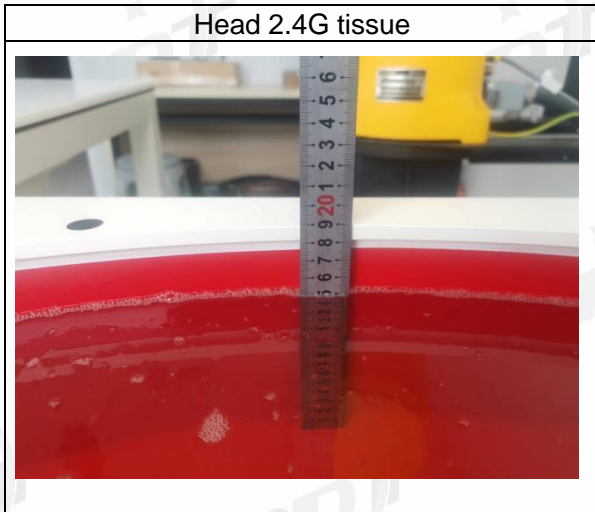

7.2. SAR system validation

The microwave circuit arrangement for system verification is sketched in bellow figure. The daily system accuracy verification occurs within the flat section of the SAM phantom. A SAR measurement was performed to see if the measured SAR was within +/- 10% from the target SAR values. The tests were conducted on the same days as the measurement of the EUT. The obtained results from the system accuracy verification are displayed in the table 5 (A power level of 250mw was input to the dipole antenna). During the tests, The laboratory temperature range shall not exceed 2°C, the relative humidity was in the range 75% and the liquid depth above the ear reference points was above 15 cm in all the cases. It is seen that the system is operating within its specification, as the results are within acceptable tolerance of the reference values.

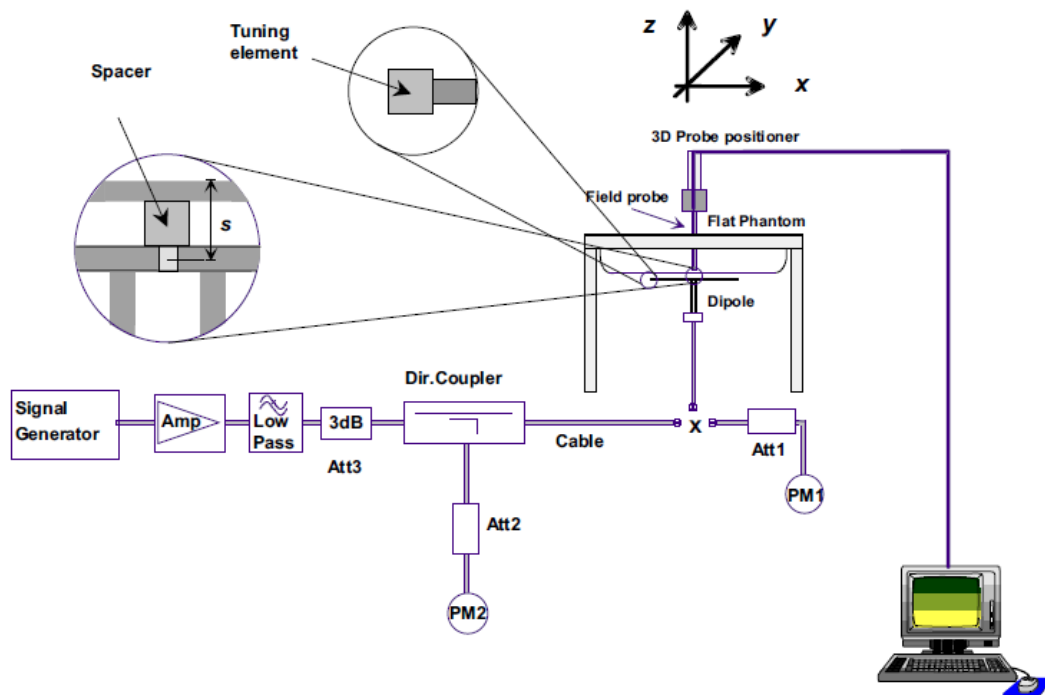

7.2.1. Justification for extended SAR dipole calibrations

1) Referring to KDB865664 D01 requirements for dipole calibration, instead of the typical annual calibration recommended by measurement standards, longer calibration intervals of up to three years may be considered when it is demonstrated that the SAR target, impedance and return loss of a dipole have remain stable according to the following requirements. Each measured dipole is expected to evaluate with the following criteria at least on annual interval in Appendix C.

- a) There is no physical damage on the dipole;
- b) System check with specific dipole is within 10% of calibrated value;
- c) Return-loss is within 10% of calibrated measurement;
- d) Impedance is within 5Ω from the previous measurement.

2) Network analyzer probe calibration against air, distilled water and a shorting block performed before measuring liquid parameters.

7.2.2. Validation test setup photograph



7.2.3. Summary system validation results

Validation Kit		Measured SAR 250mW (W/kg)	Measured SAR normalized to 1w (W/kg)	Target SAR normalized to 1w (±10%) (W/kg)	Liquid Temp. (°C)	Measured Date
D2450V2 @2450MHz	1-g	12.4	49.6	53.1 (47.79~58.41)	23.0	2024/01/11
	10-g	5.81	23.24	24.5 (22.05~26.95)	23.0	2024/01/11

7.2.4. Detailed system validation results

See the Appendix A.

8. Equipment list

Test Platform	SPEAG DASY5 Professional				
Location	SAR room				
Description	SAR Test System (Frequency range 300MHz-6GHz)				
Equipment	Manufacturer	Model	Serial Number	Calibration Date	Due date of calibration
Robot	Staubli	TX90 XL	F12/5N3XC/A/01	NCR	NCR
ELI Phantom	SPEAG	QDOVA002 AA	1752	NCR	NCR
Data Acquisition Electronics	SPEAG	DAE4	1366	2023-04-10	2024-04-9
SAR test Probe	SPEAG	EX3DV4	3906	2023-04-21	2024-04-20
Validation Kits	SPEAG	D2450V2	904	2022-01-26	2025-01-25
Agilent Network Analyzer	Agilent	E5071C	MY46316792	2023-04-21	2024-04-20
Dielectric Probe Kit	Agilent	85070E	85070-20037	NCR	NCR
0.1G-2Ghz DUAL DIRECTIONAL COUPLER	Agilent	778D	MY52180233	NCR	NCR
2G-18Ghz DUAL DIRECTIONAL COUPLER	Agilent	772D	MY52180116	NCR	NCR
Signal Generator	Agilent	N5171B	MY51350349	2023-04-21	2024-04-20
Preamplifier	Mini-Circuits	ZHL-42W	QA1240001	NCR	NCR
Preamplifier	Mini-Circuits	ZVE-8G+	926701231	NCR	NCR
EPM Series Power Meter	Agilent	E4417A	MY50000999	2023-04-21	2024-04-20
Power Sensor	Agilent	E9327A	MY44420458	2023-04-21	2024-04-20
Power Sensor	Agilent	E9327A	MY44420760	2023-04-21	2024-04-20
Attenuator	Agilent	8491A 3dB	MY52460179	NCR	NCR
Attenuator	Agilent	8491A 10dB	MY52460275	NCR	NCR
Humidity and Temperature Indicator	Euchamp Electronics	YSWS3020	20210916	2023-08-22	2024-08-21
Test software	Speag	DASY5	N/A	N/A	N/A

9. Measurement uncertainty

Uncertainty Component	probability distribution	Contains the factor	Standard uncertainty U_i	C1(1g)	C1(10g)
Sensitivity of probe	N	1	±6.55%	1	1
Isotropy of the probe	R	$\sqrt{3}$	±1.08%	1	1
Linearity of the probe	R	$\sqrt{3}$	±0.35%	1	1
Coupling effect between probe and dielectric boundary	R	$\sqrt{3}$	±0.46%	1	1
The detection limit of the system	R	$\sqrt{3}$	±0.14%	1	1
Errors in electronic reading equipment	N	1	±0.35%	1	1
Measure the response time of the equipment	R	$\sqrt{3}$	0	1	1
Measure the integral time of the equipment	R	$\sqrt{3}$	±1.50%	1	1
Data post-processing algorithm	R	$\sqrt{3}$	±0.58%	1	1
Electromagnetic environment disturbance	R	$\sqrt{3}$	±1.73%	1	1
the positioning accuracy of the probe	R	$\sqrt{3}$	±0.87%	1	1
The positioning accuracy of the probe tip relative to the model surface	R	$\sqrt{3}$	±1.67%	1	1
Manufacturing tolerances for models	R	$\sqrt{3}$	±2.31%	1	1
Deviation of measured liquid conductivity from target value	R	$\sqrt{3}$	±2.89%	0.64	0.43
Liquid conductivity test system accuracy	N	1	±2.5%	0.64	0.43
The deviation between the measured permittivity of liquid and the target value	R	$\sqrt{3}$	±2.89%	0.6	0.49
Test precision of liquid permittivity test system	N	1	±2.5%	0.6	0.49
The disturbance of the positioning fixture	N	1	±5.2%	1	1
Accuracy of sample positioning	N	1	±4.6%	1	1
The output power of the tested sample drifts	R	$\sqrt{3}$	±2.89%	1	1
Combined standard uncertainty	Uc(1g)=11.3%, Uc(10g)=11.0%				
Expanded uncertainty (95% confidence interval) k=2	U(1g)=22.6%, U(10g)=22%				

10. Test results and measurement data

10.1. RF conducted power

Antenna conducted power

Bluetooth BR/EDR					
Average conducted power					
Mode	Channel	Frequency (MHz)	Power (dBm)	Duty-Cycle	Max. Tune-up Power (dBm)
DH5	0	2402	8.72	0.7713	9.5
	39	2441	9.05	0.7713	9.5
	78	2480	8.82	0.7707	9.5
2DH5	0	2402	10.61	0.7733	11.0
	39	2441	10.87	0.7733	11.0
	78	2480	10.94	0.7733	11.0
3DH5	0	2402	10.99	0.7713	12.0
	39	2441	11.27	0.7713	12.0
	78	2480	11.36	0.7713	12.0

Note:

- 1.The output power of the device was set to transmit at maximum power for all test.
- 2.The Bluetooth maximum output power mode is 3DH5, select 3DH5 mode to test SAR.

10.2. Measurement of head SAR data

Bluetooth Head 0mm SAR 1-g											
Test position	Test mode	Test Ch./Freq (MHz)	Duty Cycle	SAR 1-g (W/kg)	Power drift (dB)	Conduct power (dBm)	Max. Tune-up Power (dBm)	Scaled factor	Scaled SAR 1-g (W/kg)	Liquid Temp. (°C)	SAR limit 1-g (W/kg)
Front	3DH5	39/2441	0.7713	0.0113	0.09	11.27	12.0	1.534	< 0.02	23.0	1.6
Back	3DH5	39/2441	0.7713	0.0015	0.11	11.27	12.0	1.534	< 0.01	23.0	1.6
Top	3DH5	39/2441	0.7713	0.0360	0.06	11.27	12.0	1.534	0.06	23.0	1.6
Bottom	3DH5	39/2441	0.7713	0.0094	0.13	11.27	12.0	1.534	< 0.01	23.0	1.6
Left	3DH5	39/2441	0.7713	0.0079	0.14	11.27	12.0	1.534	< 0.01	23.0	1.6
Right	3DH5	39/2441	0.7713	0.0063	0.08	11.27	12.0	1.534	< 0.01	23.0	1.6

Note:

- 1)The maximum Scaled SAR value is marked in bold. Graph Results refer to Appendix B
- 2)If the reported (scaled) SAR measured at the middle channel or highest output power channel for each test configuration is ≤ 0.8 W/kg then testing at the other channels is not required for such test configuration(s).
- 3)Scaled factor= (Max. Tune-up Power in mW) / (Conducted Power in mW) / (Duty Cycle)
- 4)Scaled SAR=Test SAR * Scaled factor

Appendix

Appendix A: System Validation Plots

Appendix B: Highest Test Plots

Appendix C: Calibration Certification

Appendix D: Test setup photograph

END REPORT