

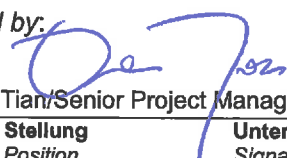

<b>Prüfbericht-Nr.:</b> <i>Test Report No.:</i>	17052521 004	<b>Auftrags-Nr.:</b> <i>Order No.:</i>	164044450	Seite 1 von 31 <i>Page 1 of 31</i>	
<b>Kunden-Referenz-Nr.:</b> <i>Client Reference No.:</i>	N/A	<b>Auftragsdatum:</b> <i>Order date:</i>	07.09.2015		
<b>Auftraggeber:</b> <i>Client:</i>	Shenzhen Zowee Technology Co., Ltd. Science & Technology Industrial Park of Privately Owned Enterprises, Pingshan, Xili, Nanshan District, Shenzhen, China				
<b>Prüfgegenstand:</b> <i>Test item:</i>	Tablet PC				
<b>Bezeichnung / Typ-Nr.:</b> <i>Identification / Type No.:</i>	NS-P11W6100				
<b>Auftrags-Inhalt:</b> <i>Order content:</i>	FCC/IC Certification				
<b>Prüfgrundlage:</b> <i>Test specification:</i>	CFR Title 47 Part 2 Subpart J Section 2.1093 ANSI/IEEE C95.1-1992 IEEE 1528-2013 KDB 447498 D01 v05r02 RSS-102 Issue 5 March 2015				
<b>Wareneingangsdatum:</b> <i>Date of receipt:</i>	05.09.2015				
<b>Prüfmuster-Nr.:</b> <i>Test sample No.:</i>	A000248673-004				
<b>Prüfzeitraum:</b> <i>Testing period:</i>	10.09.2015				
<b>Ort der Prüfung:</b> <i>Place of testing:</i>	Shenzhen EMTEK Co., Ltd.				
<b>Prüflaboratorium:</b> <i>Testing laboratory:</i>	TÜV Rheinland (Shenzhen) Co., Ltd.				
<b>Prüfergebnis*:</b> <i>Test result*:</i>	Pass				
<b>geprüft von / tested by:</b>			<b>kontrolliert von / reviewed by:</b>		
29.09.2015	Owen Tian/Senior Project Manager		29.09.2015	Sam Lin/Technical Certifier	
<b>Datum</b> <i>Date</i>	<b>Name / Stellung</b> <i>Name / Position</i>	<b>Unterschrift</b> <i>Signature</i>	<b>Datum</b> <i>Date</i>	<b>Name / Stellung</b> <i>Name / Position</i>	<b>Unterschrift</b> <i>Signature</i>
<b>Sonstiges / Other:</b>	FCC ID: 2AAP6ZM1100B1 IC: 8257A-NSP11W6100				
<b>Zustand des Prüfgegenstandes bei Anlieferung:</b> <i>Condition of the test item at delivery:</i>	Prüfmuster vollständig und unbeschädigt <i>Test item complete and undamaged</i>				
* Legende:	1 = sehr gut P(ass) = entspricht o.g. Prüfgrundlage(n)	2 = gut F(all) = entspricht nicht o.g. Prüfgrundlage(n)	3 = befriedigend N/A = nicht anwendbar	4 = ausreichend N/T = nicht getestet	5 = mangelhaft
Legend:	1 = very good P(ass) = passed a.m. test specification(s)	2 = good F(all) = failed a.m. test specification(s)	3 = satisfactory N/A = not applicable	4 = sufficient N/T = not tested	5 = poor
<b>Dieser Prüfbericht bezieht sich nur auf das o.g. Prüfmuster und darf ohne Genehmigung der Prüfstelle nicht auszugsweise vervielfältigt werden. Dieser Bericht berechtigt nicht zur Verwendung eines Prüfzeichens.</b> <i>This test report only relates to the a. m. test sample. Without permission of the test center this test report is not permitted to be duplicated in extracts. This test report does not entitle to carry any test mark.</i>					

## STATEMENT OF COMPLIANCE

TEST ITEM	SPECIFICATION	RESULT
Specific Absorption Rate - Wi-Fi 802.11 b/g/n - 2.4GHz Band	Exposure Rules 47 C.F.R 2.1093 Radiofrequency Radiation Exposure Evaluation:	PASS
Specific Absorption Rate - Wi-Fi 802.11 a/n - 5.2GHz Band	Portable Devices KDB 447498 D01 General RF Exposure Guidance v05r02	PASS
Specific Absorption Rate - Wi-Fi 802.11 a/n - 5.8GHz Band	KDB 248227 D01 802.11 Wi-Fi SAR v02r01 KDB 865664 D01 SAR Measurement 100 MHz to 6 GHz v01r03	PASS
Specific Absorption Rate – Bluetooth BDR - 2.4GHz Band	KDB 865664 D02 RF Exposure Reporting v01r01 KDB 616217 D04 SAR for laptop and tablets v01r01 KDB 941225 D06 Hotspot Mode v02	PASS

This device complies with Specific Absorption Rate (SAR) for general population/uncontrolled exposure limits (1.6W/kg) specified in CFR Title 47 Part 2 Subpart J Section 2.1093 and ANSI/IEEE C95.1-1992.

This device has been tested in accordance with the measurement methods and procedure specified in IEEE 1528-2003 and Published RF exposure KDB procedures

Refer to the maximum results of Specific Absorption Rate (SAR) during testing as below.

FREQUENCY BAND	EXPOSURE POSITION	EQUIPMENT CLASS	HIGHEST REPORTED SAR VALUE (W/KG)
802.11 b/g/n - 2.4GHz Band	Body	DTS	0.685
802.11 a/n - 5.2GHz Band	Body	NII	0.318
802.11 a/n - 5.8GHz Band	Body		0.455

## Contents

<b>1.</b>	<b>GENERAL REMARKS .....</b>	<b>5</b>
<b>1.1</b>	<b>COMPLEMENTARY MATERIALS .....</b>	<b>5</b>
<b>2.</b>	<b>TEST SITES .....</b>	<b>5</b>
<b>2.1</b>	<b>TEST FACILITIES .....</b>	<b>5</b>
<b>2.2</b>	<b>LIST OF TEST AND MEASUREMENT INSTRUMENTS.....</b>	<b>6</b>
<b>3.</b>	<b>GENERAL PRODUCT INFORMATION .....</b>	<b>7</b>
<b>3.1</b>	<b>PRODUCT FUNCTION AND INTENDED USE.....</b>	<b>7</b>
<b>3.2</b>	<b>RATINGS AND SYSTEM DETAILS .....</b>	<b>7</b>
<b>3.3</b>	<b>INDEPENDENT OPERATION MODES .....</b>	<b>9</b>
<b>3.4</b>	<b>SUBMITTED DOCUMENTS .....</b>	<b>9</b>
<b>4.</b>	<b>SAR MEASUREMENTS SYSTEM CONFIGURATION.....</b>	<b>10</b>
<b>4.1</b>	<b>SAR MEASUREMENTS SET-UP .....</b>	<b>10</b>
<b>4.2</b>	<b>DASY5 E-FIELD PROBE SYSTEM .....</b>	<b>11</b>
<b>4.3</b>	<b>E-FILED PROBE CALIBRATION.....</b>	<b>12</b>
<b>4.4</b>	<b>OTHER TEST EQUIPMENT .....</b>	<b>12</b>
4.4.1	<i>Data Acquisition Electronics (DAE).....</i>	<i>12</i>
4.4.2	<i>Robot.....</i>	<i>13</i>
4.4.3	<i>Measurement Server.....</i>	<i>14</i>
4.4.4	<i>Device Holder for Phantom .....</i>	<i>14</i>
4.4.5	<i>Phantom.....</i>	<i>15</i>
<b>4.5</b>	<b>SCANNING PROCEDURE .....</b>	<b>16</b>
<b>4.6</b>	<b>DATA STORAGE AND EVALUATION.....</b>	<b>18</b>
4.6.1	<i>Data Storage .....</i>	<i>18</i>
4.6.2	<i>Data Evaluation by SEMCAD.....</i>	<i>18</i>
<b>5.</b>	<b>TEST SET-UP AND OPERATION MODES .....</b>	<b>20</b>
<b>5.1</b>	<b>PRINCIPLE OF CONFIGURATION SELECTION.....</b>	<b>20</b>
<b>5.2</b>	<b>TISSUE SIMULATING LIQUID INGREDIENTS .....</b>	<b>20</b>
<b>5.3</b>	<b>SPECIFIC ABSORPTION RATE (SAR) SYSTEM CHECK .....</b>	<b>21</b>
<b>5.4</b>	<b>EXPOSURE POSITIONS CONSIDERATION.....</b>	<b>23</b>
<b>5.5</b>	<b>TEST OPERATION AND TEST SOFTWARE .....</b>	<b>24</b>
<b>5.6</b>	<b>SPECIAL ACCESSORIES AND AUXILIARY EQUIPMENT .....</b>	<b>24</b>
<b>6.</b>	<b>TEST RESULTS .....</b>	<b>25</b>
<b>6.1</b>	<b>HUAMAN EXPOSURE TO RADIOFREQUENCY ELECTROMAGNETIC FIELDS.....</b>	<b>25</b>
<b>6.2</b>	<b>MEASUREMENT UNCERTAINTY.....</b>	<b>29</b>
6.2.1	<i>Measurement uncertainty evaluation .....</i>	<i>29</i>

7.	PHOTOGRAPHS OF THE TEST SET-UP .....	30
8.	LIST OF TABLES .....	31
9.	LIST OF PHOTOGRAPHS .....	31

## 1. General Remarks

### 1.1 Complementary Materials

All attachments are integral parts of this test report. This applies especially to the following appendix:

- Appendix A: System Performance Check
- Appendix B: Test Plots of SAR Measurement
- Appendix C: Calibration Certificate

## 2. Test Sites

### 2.1 Test Facilities

Shenzhen EMTEK Co., Ltd.  
Bldg 69, Majialong Industry Zone, Nanshan District,  
Shenzhen, Guangdong, P.R. China

The tests at the test site have been conducted under the supervision of a TÜV engineer.

## 2.2 List of Test and Measurement Instruments

**Table 1: List of Test and Measurement Equipment**

Equipment	Manufacturer	Model No.	Serial No.	Last Cal.	Cal. Interval
Signal Generator	Agilent	N5181A	MY50145187	5/16/2015	1year
RF Power Meter. Dual Channel	BOONTON	4232A	10539	5/16/2015	1year
Power Sensor	BOONTON	51011EMC	34236/34238	5/16/2015	1year
Wideband Radio Communication Tester	R&S	CMW500	1201.0002K50- 140822zk	5/16/2015	1year
Signal Analyzer	Agilent	N9010A	My53470879	5/16/2015	1year
Network Analyzer	Agilent	E5071C	MY46316645	5/16/2015	1year
E-Field Probe	SPEAG	EX3DV4	3801	6/18/2014	1year
DAE	SPEAG	DAE4	918	11/29/2014	1year
Validation Kit 2450MHz	SPEAG	D2450V2	927	1/13/2014	2year
Validation Kit 5GHz	SPEAG	D5GHzV2	1169	1/13/2014	2year
Dual Directional Coupler	Agilent	EE393	TW5451008	5/16/2015	1year
10dB Attenuator	Mini-Circuits	15542	3 1344	5/16/2015	1year
10dB Attenuator	Mini-Circuits	15542	3 1415	5/16/2015	1year
30dB Attenuator	Mini-Circuits	15542	3 1420	5/16/2015	1year
Power Amplifier	MILMEGA	80RF1000-175	1059345	5/16/2015	1 Year
Power Amplifier	MILMEGA	AS0102-55	1018770	5/16/2015	1 Year
Power Amplifier	MILMEGA	AS1860-50	1059346	5/16/2015	1 Year
Power Meter	Agilent	N1918A	MY54180006	5/16/2015	1 Year
ELI V5.0	SPEAG	QD 0VA 022 AA	1231	N/A	N/A
Device Holder	SPEAG	N/A	N/A	N/A	N/A

### 3. General Product Information

#### 3.1 Product Function and Intended Use

The EUT is 11.6" windows tablet with Wi-Fi, Bluetooth function.  
 For details refer to the User Manual and Circuit Diagram.

#### 3.2 Ratings and System Details

**Table 2: Technical Specification**

Device type:	Portable device						
EUT Name:	Tablet PC						
Type Identification:	NS-P11W6100						
Serial Number	A000248673-004						
FCC ID:	2AAP6ZM1100B1						
IC	8257A-NSP11W6100						
Operating mode(s) / WiFi:	IEEE 802.11b	IEEE 802.11g	IEEE 802.11n (HT20)	IEEE 802.11n (HT40)	IEEE 802.11a	IEEE 802.11n (HT20)	IEEE 802.11n (HT40)
Test modulation	DSSS (DBPSK, DQPSK), CCK)	OFDM (DBPSK, DQPSK)	OFDM (BPSK, QPSK, 16-QAM, 64-QAM)	OFDM (BPSK, QPSK, 16-QAM, 64-QAM)	OFDM (BPSK, QPSK, 16-QAM, 64-QAM)	OFDM (BPSK, QPSK, 16-QAM, 64-QAM)	OFDM (BPSK, QPSK, 16-QAM, 64-QAM)
Transmit Frequency Range (MHz):	2412 - 2472	2412 - 2472	2412 - 2472	2422 - 2462	5180 - 5240, 5745 - 5825	5180 - 5240, 5745 - 5825	5190 - 5230, 5755 - 5795
Maximum tune-up average output power (dBm):	14.5	13.5	12.5	13	9.5	9	8.5
Operating mode(s) / Bluetooth:	Bluetooth 4.0						
Test modulation	GFSK, $\pi/4$ DQPSK, 8DPSK for BDR & EDR mode, GFSK for Low Energy mode						
Transmit Frequency Range (MHz):	2402-2480						
Maximum tune-up average output power (dBm):	3						
Hardware version:	IP3_T1C_MB						
Software version:	Windows 10						
Antenna type:	Integrated antenna						
Battery options:	DC 3.7V						

**Table 3: List of WLAN Channel of 802.11b/g/n mode**

802.11b		802.11g		802.11n (HT20)		802.11n (HT40)	
Channel Number	Frequency (MHz)	Channel Number	Frequency (MHz)	Channel Number	Frequency (MHz)	Channel Number	Frequency (MHz)
1	2412	1	2412	1	2412	3	2422
2	2417	2	2417	2	2417	4	2427
3	2422	3	2422	3	2422	5	2432
4	2427	4	2427	4	2427	6	2437
5	2432	5	2432	5	2432	7	2442
6	2437	6	2437	6	2437	8	2447
7	2442	7	2442	7	2442	9	2452
8	2447	8	2447	8	2447	10	2457
9	2452	9	2452	9	2452	11	2462
10	2457	10	2457	10	2457		
11	2462	11	2462	11	2462		

**Table 4: List of WLAN Channel of 802.11a/n mode**

802.11a		802.11n (HT20)		802.11n (HT40)	
Channel Number	Frequency (MHz)	Channel Number	Frequency (MHz)	Channel Number	Frequency (MHz)
36	5180	36	5180	38	5190
40	5200	40	5200	46	5230
44	5220	44	5220	151	5755
48	5240	48	5240	159	5795
149	5745	149	5745		
153	5765	153	5765		
157	5785	157	5785		
161	5805	161	5805		
165	5825	165	5825		

**Table 5: List of Bluetooth Channel**

Bluetooth (BDR & EDR)		Bluetooth (Low Energy)	
Channel Number	Frequency (MHz)	Channel Number	Frequency (MHz)
0	2402	0	2402
39	2441	19	2440
78	2480	39	2480



### 3.3 Independent Operation Modes

The basic operation modes are:

- A. On, transmitting
  - 1. 802.11b
  - 2. 802.11g
  - 3. 802.11n (HT20)
  - 4. 802.11n (HT40)
  - 5. 802.11a
  - 6. Bluetooth BDR
  - 7. Bluetooth EDR
  - 8. Bluetooth Low Energy
- B. Off

### 3.4 Submitted Documents

- Bill of Material
- Constructional Drawing
- PCB Layout
- Photo Document
- Circuit Diagram
- Instruction Manual
- Rating Label

## 4. SAR Measurements System Configuration

### 4.1 SAR Measurements Set-up

The DASY5 system for performing compliance tests consists of the following items:

- A standard high precision 6-axis robot (Stäubli TX=RX family) with controller, teach pendant and software. An arm extension for accommodating the data acquisition electronics (DAE).
- An isotropic field probe optimized and calibrated for the targeted measurement.
- A data acquisition electronics (DAE) which performs the signal amplification, signal multiplexing, AD-conversion, offset measurements, mechanical surface detection, collision detection, etc. The unit is battery powered with standard or rechargeable batteries. The signal is optically transmitted to the EOC.
- The Electro-optical converter (EOC) performs the conversion from optical to electrical signals for the digital communication to the DAE. To use optical surface detection, a special version of the EOC is required. The EOC signal is transmitted to the measurement server.
- The function of the measurement server is to perform the time critical tasks such as signal filtering, control of the robot operation and fast movement interrupts.
- The Light Beam used is for probe alignment. This improves the (absolute) accuracy of the probe positioning.
- A computer running WinXP and the DASY5 software.
- Remote control and teach pendant as well as additional circuitry for robot safety such as warning lamps, etc.
- The generic twin phantom enabling the testing of left-hand and right-hand usage.
- The device holder for handheld mobile phones.
- Tissue simulating liquid mixed according to the given recipes.
- System validation dipoles allowing to validate the proper functioning of the system.

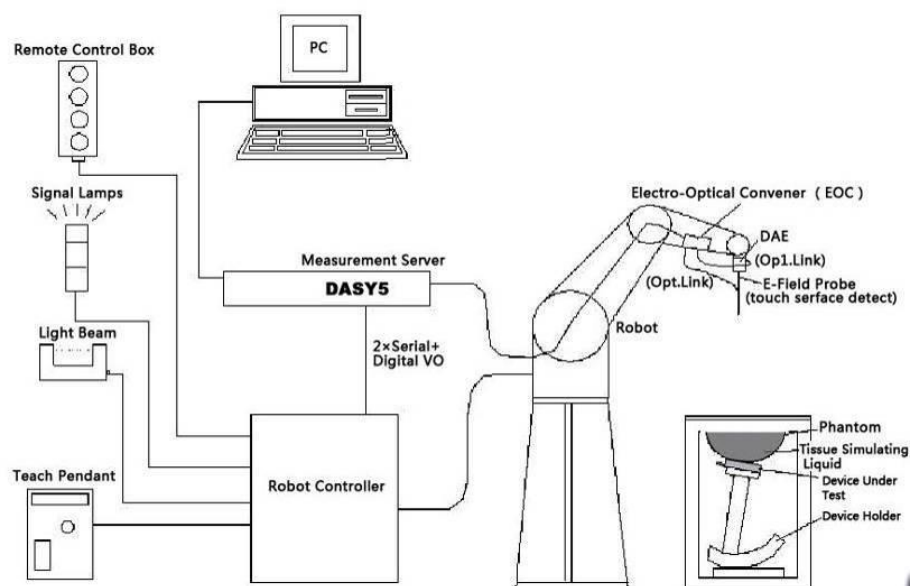

**Picture 1 SAR Lab Test Measurement Set-up**

## 4.2 DASY5 E-Fild Probe System

The SAR measurements were conducted with the dosimetric probe designed in the classical triangular configuration and optimized for dosimetric evaluation. The probe is constructed using the thick film technique; with printed resistive lines on ceramic substrates. The probe is equipped with an optical multifiber line ending at the front of the probe tip. It is connected to the EOC box on the robot arm and provides an automatic detection of the phantom surface. Half of the fibers are connected to a pulsed infrared transmitter, the other half to a synchronized receiver. As the probe approaches the surface, the reflection from the surface produces a coupling from the transmitting to the receiving fibers. This reflection increases first during the approach, reaches maximum and then decreases. If the probe is flatly touching the surface, the coupling is zero. The distance of the coupling maximum to the surface is independent of the surface reflectivity and largely independent of the surface to probe angle. The DASY5 software reads the reflection turning a software approach and looks for the maximum using 2<sup>nd</sup> ord curve fitting. The approach is stopped at reaching the maximum.

### Probe Specifications:

Model: EX3DV4  
Frequency Range: 10MHz — 6.0GHz (EX3DV4)  
Calibration: In head and body simulating tissue at  
Frequencies from 835 up to 5800MHz  
Linearity:  $\pm 0.2$  dB (30 MHz to 6 GHz) for EX3DV4  
Dynamic Range: 10 mW/kg — 100W/kg  
Probe Length: 330 mm  
Probe Tip Length: 20 mm  
Body Diameter: 12 mm  
Tip Diameter: 2.5 mm  
Tip-Center: 1 mm  
Application: SAR Dosimetry Testing  
Compliance tests of mobile phones  
Dosimetry in strong gradient fields



Picture 2 E-field Probe

### 4.3 E-Filed Probe Calibration

Each E-Probe/Probe Amplifier combination has unique calibration parameters. A TEM cell calibration procedure is conducted to determine the proper amplifier settings to enter in the probe parameters. The amplifier settings are determined for a given frequency by subjecting the probe to a known E-field density (1 mW/cm<sup>2</sup>) using an RF Signal generator, TEM cell, and RF Power Meter.

The free space E-field from amplified probe outputs is determined in a test chamber. This calibration can be performed in a TEM cell if the frequency is below 1 GHz and in a waveguide or other methodologies above 1 GHz for free space. For the free space calibration, the probe is placed in the volumetric center of the cavity and at the proper orientation with the field. The probe is then rotated 360 degrees until the three channels show the maximum reading. The power density readings equate to 1 mW/cm<sup>2</sup>.

E-field temperature correlation calibration is performed in a flat phantom filled with the appropriate simulated brain tissue. The E-field in the medium correlates with the temperature rise in the dielectric medium. For temperature correlation calibration a RF transparent thermistor-based temperature probe is used in conjunction with the E-field probe.

$$SAR = C \frac{\Delta T}{\Delta t}$$

Where:

$\Delta t$  = Exposure time (30 seconds),

C = Heat capacity of tissue (brain or muscle),

$\Delta T$  = Temperature increase due to RF exposure.

$$SAR = \frac{|E|^2 \cdot \sigma}{\rho}$$

Where:

$\sigma$  = Simulated tissue conductivity,

$\rho$  = Tissue density (kg/m<sup>3</sup>).

### 4.4 Other Test Equipment

#### 4.4.1 Data Acquisition Electronics (DAE)

The data acquisition electronics consist of a highly sensitive electrometer-grade preamplifier with auto-zeroing, a channel and gain-switching multiplexer, a fast 16 bit AD-converter and a command decoder with a control logic unit. Transmission to the measurement server is accomplished through an optical downlink for data and status information, as well as an optical uplink for commands and the clock.

The mechanical probe mounting device includes two different sensor systems for frontal and sideways probe contacts. They are used for mechanical surface detection and probe collision detection.

The input impedance of the DAE is 200 MOhm; the inputs are symmetrical and floating. Common mode rejection is above 80 dB.



Picture 3 DAE

#### 4.4.2 Robot

The SPEAG DASY system uses the high precision robots (DASY5: TX60XL) type from Stäubli SA (France). For the 6-axis controller system, the robot controller version from Stäubli is used. The Stäubli robot series have many features that are important for our application:

High precision (repeatability 0.02mm)

High reliability (industrial design)

Low maintenance costs (virtually maintenance free due to direct drive gears; no belt drives)

Jerk-free straight movements (brushless synchron motors; no stepper motors)

Low ELF interference (motor control fields shielded via the closed metallic construction shields)

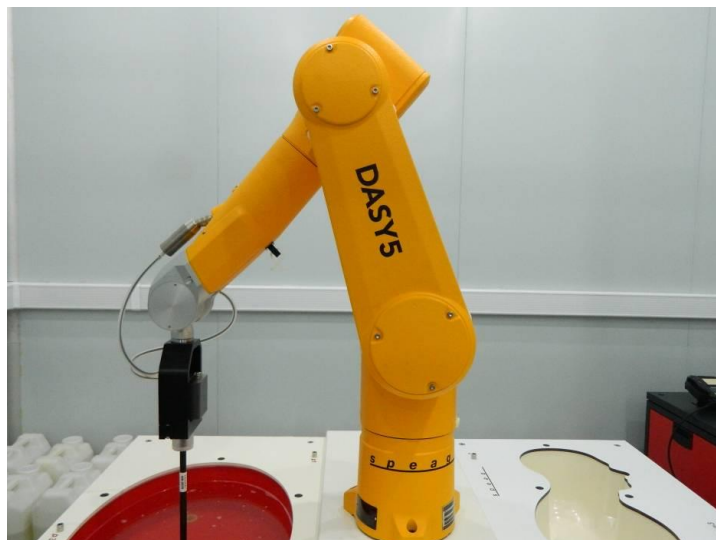

Picture 4 DASY 5

### 4.4.3 Measurement Server

The Measurement server is based on a PC/104 CPU board with CPU (DASY5: 400 MHz, Intel Celeron), chip disk (DASY5: 128MB), RAM (DASY5: 128MB). The necessary circuits for communication with the DAE electronic box, as well as the 16 bit AD converter system for optical detection and digital I/O interface are contained on the DASY I/O board, which is directly connected to the PC/104 bus of the CPU board.



Picture 5 Server for DASY 5

The measurement server performs all real-time data evaluation of field measurements and surface detection, controls robot movements and handles safety operation. The PC operating system cannot interfere with these time critical processes. All connections are supervised by a watchdog, and disconnection of any of the cables to the measurement server will automatically disarm the robot and disable all program-controlled robot movements. Furthermore, the measurement server is equipped with an expansion port which is reserved for future applications. Please note that this expansion port does not have a standardized pinout, and therefore only devices provided by SPEAG can be connected. Devices from any other supplier could seriously damage the measurement server.

### 4.4.4 Device Holder for Phantom

The SAR in the phantom is approximately inversely proportional to the square of the distance between the source and the liquid surface. For a source at 5mm distance, a positioning uncertainty of  $\pm 0.5\text{mm}$  would produce a SAR uncertainty of  $\pm 20\%$ . Accurate device positioning is therefore crucial for accurate and repeatable measurements. The positions in which the devices must be measured are defined by the standards.

The DASY device holder is designed to cope with the different positions given in the standard. It has two scales for device rotation (with respect to the body axis) and device inclination (with respect to the line between the ear reference points). The rotation centers for both scales are the ear reference point (ERP). Thus the device needs no repositioning when changing the angles.

The DASY device holder is constructed of low-loss POM material having the following dielectric parameters: relative permittivity  $\epsilon = 3$  and loss tangent  $\delta = 0.02$ . The amount of dielectric material has been reduced in the closest vicinity of the device, since measurements have suggested that the influence of the clamp on the test results could thus be lowered.

<Laptop Extension Kit>

The extension is lightweight and made of POM, acrylic glass and foam. It fits easily on the upper part of the Mounting Device in place of the phone positioner. The extension is fully compatible with the Twin-SAM and ELI phantoms.

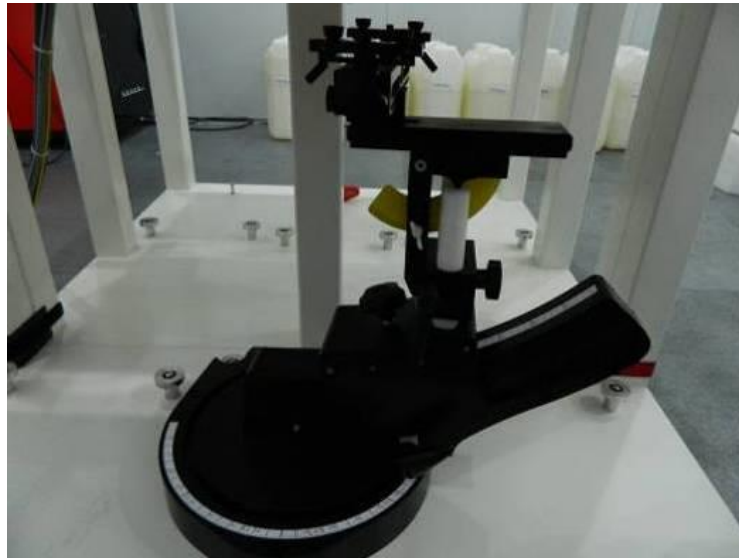

Picture 6 Device Holder

#### 4.4.5 Phantom

The SAM Twin Phantom V4.0 is constructed of a fiberglass shell integrated in a table. The shape of the shell is based on data from an anatomical study designed to Represent the 90<sup>th</sup> percentile of the population. The phantom enables the dissymmetric evaluation of SAR for both left and right handed handset usage, as well as body-worn usage using the flat phantom region. Reference markings on the Phantom allow the complete setup of all predefined phantom positions and measurement grids by manually teaching three points in the robot. The shell phantom has a 2mm shell thickness (except the ear region where shell thickness increases to 6 mm).

Shell Thickness:  $2 \pm 0.2$  mm

Filling Volume: Approx. 25 liters

Dimensions: 810 x 1000 x 500 mm (H x L x W)

Available: Special

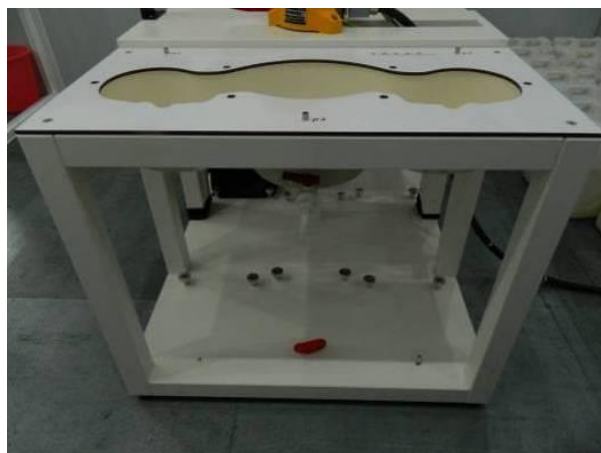

Picture 7 SAM Twin Phantom

Phantom for compliance testing of handheld and body-mounted wireless devices in the frequency range of 30 MHz to 6 GHz. ELI is fully compatible with the IEC 62209-2 standard and all known tissue simulating liquids. ELI has been optimized regarding its performance and can be integrated into our standard phantom tables. A cover prevents evaporation of the liquid. Reference markings on the phantom allow installation of the complete setup, including all predefined phantom positions and measurement grids, by teaching three points. The phantom is compatible with all SPEAG dosimetric probes and dipoles.

Shell Thickness  $2\pm 0.2$  mm

Filling Volume Approx. 30 liters

Dimensions 190x600x0 mm (H x L x W)

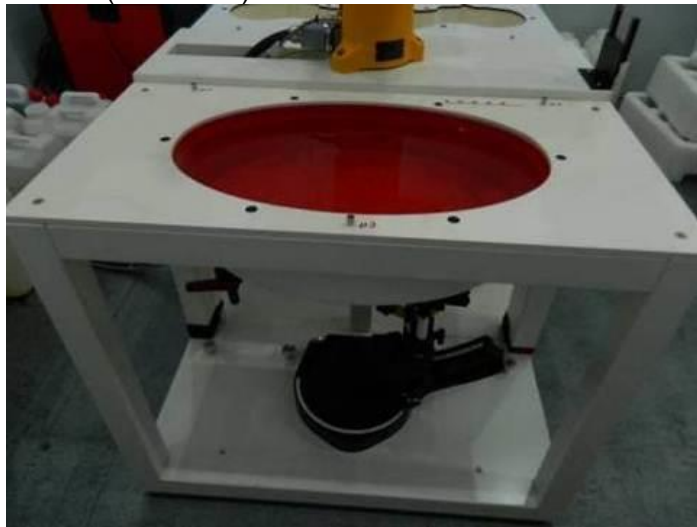

Picture 8 ELI4 Phantom

## 4.5 Scanning Procedure

The DASY5 installation includes predefined files with recommended procedures for measurements and validation. They are read-only document files and destined as fully defined but unmeasured masks. All test positions (head or body-worn) are tested with the same configuration of test steps differing only in the grid definition for the different test positions.

The “reference” and “drift” measurements are located at the beginning and end of the batch process. They measure the field drift at one single point in the liquid over the complete procedure. The indicated drift is mainly the variation of the DUT’s output power and should vary max.  $\pm 5$  %.

The “surface check” measurement tests the optical surface detection system of the DASY5 system by repeatedly detecting the surface with the optical and mechanical surface detector and comparing the results. The output gives the detecting heights of both systems, the difference between the two systems and the standard deviation of the detection repeatability. Air bubbles or refraction in the liquid due to separation of the sugar-water mixture gives poor repeatability (above  $\pm 0.1$ mm). To prevent wrong results tests are only executed when the liquid is free of air bubbles. The difference between the optical surface detection and the actual surface depends on the probe and is specified with each probe. (It does not depend on the surface reflectivity or the probe angle to the surface within  $\pm 30^\circ$ .)



### Area Scan

The Area Scan is used as a fast scan in two dimensions to find the area of high field values before running a detailed measurement around the hot spot. Before starting the area scan a grid spacing is set according to FCC KDB Publication 865664. During scan the distance of the probe to the phantom remains unchanged. After finishing area scan, the field maxima within a range of 2 dB will be ascertained.

### Zoom Scan

After the maximum interpolated values were calculated between the points in the cube, the SAR was averaged over the spatial volume (1g or 10g) using a 3D-Spline interpolation algorithm. The 3D-spline is composed of three one-dimensional splines with the "Not a knot" condition (in x, y, and z directions). The volume was then integrated with the trapezoidal algorithm.

### Spatial Peak Detection

The procedure for spatial peak SAR evaluation has been implemented and can determine values of masses of 1g and 10g, as well as for user-specific masses. The DASY5 system allows evaluations that combine measured data and robot positions, such as:

- maximum search
- extrapolation
- boundary correction
- peak search for averaged SAR

During a maximum search, global and local maxima searches are automatically performed in 2-D after each Area Scan measurement with at least 6 measurement points. It is based on the evaluation of the local SAR gradient calculated by the Quadratic Shepard's method. The algorithm will find the global maximum and all local maxima within -2 dB of the global maxima for all SAR distributions.

Extrapolation routines are used to obtain SAR values between the lowest measurement points and the inner phantom surface. The extrapolation distance is determined by the surface detection distance and the probe sensor offset. Several measurements at different distances are necessary for the extrapolation. Extrapolation routines require at least 10 measurement points in 3-D space.

They are used in the Zoom Scan to obtain SAR values between the lowest measurement points and the inner phantom surface. The routine uses the modified Quadratic Shepard's method for extrapolation.

A Z-axis scan measures the total SAR value at the x-and y-position of the maximum SAR value found during the cube scan. The probe is moved away in z-direction from the bottom of the SAM phantom in 5mm steps.

### Area and Zoom Scan Resolutions per FCC KDB Publication 865664 D01

Frequency	Maximum Area Scan Resolution (mm) ( $\Delta x_{area}$ , $\Delta y_{area}$ )	Maximum Zoom Scan Resolution (mm) ( $\Delta x_{zoom}$ , $\Delta y_{zoom}$ )	Maximum Zoom Scan Spatial Resolution (mm) $\Delta z_{zoom}(n)$	Minimum Zoom Scan Volume (mm) (x,y,z)
≤2 GHz	≤15	≤8	≤5	≥ 30
2-3 GHz	≤12	≤5	≤5	≥30
3-4 GHz	≤12	≤5	≤4	≥28
4-5 GHz	≤10	≤4	≤3	≥25
5-6 GHz	≤10	≤4	≤2	≥22

## 4.6 Data Storage and Evaluation

### 4.6.1 Data Storage

The DASY5 software stores the acquired data from the data acquisition electronics as raw data (in microvolt readings from the probe sensors), together with all necessary software parameters for the data evaluation (probe calibration data, liquid parameters and device frequency and modulation data) in measurement files with the extension “.DAE4”. The software evaluates the desired unit and format for output each time the data is visualized or exported. This allows verification of the complete software setup even after the measurement and allows correction of incorrect parameter settings. For example, if a measurement has been performed with a wrong crest factor parameter in the device set up, the parameter can be corrected afterwards and the data can be re-evaluated.

The measured data can be visualized or exported in different units or formats, depending on the selected probe type ([V/m], [A/m], [°C], [mW/g], [mW/cm<sup>2</sup>], [dBrel], etc.). Some of these units are not available in certain situations or show meaningless results, e.g., a SAR output in a loss less media will always be zero. Raw data can also be exported to perform the evaluation with other software packages.

### 4.6.2 Data Evaluation by SEMCAD

The SEMCAD software automatically executes the following procedures to calculate the field units from the microvolt readings at the probe connector. The parameters used in the evaluation are stored in the configuration modules of the software:

Probe parameters: - Sensitivity       $\text{Norm}_i, a_{i0}, a_{i1}, a_{i2}$

- Conversion factor       $\text{ConvF}_i$

- Diode compression point       $\text{Dcp}_i$

Device parameters: - Frequency       $f$

- Crest factor       $cf$

Media parameters: - Conductivity  
- Density

These parameters must be set correctly in the software. They can be found in the component documents or they can be imported into the software from the configuration files issued for the DASY5 components. In the direct measuring mode of the multimeter option, the parameters of the actual system setup are used. In the scan visualization and export modes, the parameters stored in the corresponding document files are used.

The first step of the evaluation is a linearization of the filtered input signal to account for the compression characteristics of the detector diode. The compensation depends on the input signal, the diode type and the DC-transmission factor from the diode to the evaluation electronics.

If the exciting field is pulsed, the crest factor of the signal must be known to correctly compensate for peak power. The formula for each channel can be given as:

$$\mathbf{V}_i = \mathbf{U}_i + \mathbf{U}_i^2 \cdot \mathbf{c} \mathbf{f} / \mathbf{dcp}_i$$

With  $\mathbf{V}_i$  = compensated signal of channel i ( i = x, y, z )

$\mathbf{U}_i$  = input signal of channel i ( i = x, y, z )

$\mathbf{cf}$  = crest factor of exciting field (DASY parameter)

$\mathbf{dcp}_i$  = diode compression point (DASY parameter)

From the compensated input signals the primary field data for each channel can be evaluated:

E-field probes:  $\mathbf{E}_i = ( \mathbf{V}_i / \mathbf{Norm}_i \cdot \mathbf{ConvF} )^{1/2}$

H-field probes:  $\mathbf{H}_i = ( \mathbf{V}_i )^{1/2} \cdot ( \mathbf{a}_{i0} + \mathbf{a}_{i1} \mathbf{f} + \mathbf{a}_{i2} \mathbf{f}^2 ) / \mathbf{f}$

With  $\mathbf{V}_i$  = compensated signal of channel i ( i = x, y, z )

$\mathbf{Norm}_i$  = sensor sensitivity of channel i ( i = x, y, z )

[mV/(V/m)<sup>2</sup>] for E-field Probes

$\mathbf{ConvF}$  = sensitivity enhancement in solution

$\mathbf{a}_{ij}$  = sensor sensitivity factors for H-field probes

$\mathbf{f}$  = carrier frequency [GHz]

$\mathbf{E}_i$  = electric field strength of channel i in V/m

$\mathbf{H}_i$  = magnetic field strength of channel i in A/m

The RSS value of the field components gives the total field strength (Hermitian magnitude):

$$\mathbf{E}_{\text{tot}} = (\mathbf{E}_x^2 + \mathbf{E}_y^2 + \mathbf{E}_z^2)^{1/2}$$

The primary field data are used to calculate the derived field units.

$$\mathbf{SAR} = (\mathbf{E}_{\text{tot}})^2 \cdot \sigma / (\rho \cdot 1000)$$

with  $\mathbf{SAR}$  = local specific absorption rate in mW/g

$\mathbf{E}_{\text{tot}}$  = total field strength in V/m

= conductivity in [mho/m] or [Siemens/m]

= equivalent tissue density in g/cm<sup>3</sup>

Note that the density is normally set to 1 (or 1.06), to account for actual brain density rather than the density of the simulation liquid. The power flow density is calculated assuming the excitation field to be a free space field.

$$\mathbf{P}_{\text{pwe}} = \mathbf{E}_{\text{tot}}^2 / 3770 \text{ or } \mathbf{P}_{\text{pwe}} = \mathbf{H}_{\text{tot}}^2 \cdot 37.7$$

with  $\mathbf{P}_{\text{pwe}}$  = equivalent power density of a plane wave in mW/cm<sup>2</sup>

$\mathbf{E}_{\text{tot}}$  = total electric field strength in V/m;  $\mathbf{H}_{\text{tot}}$  = total magnetic field strength in A/m

## 5. Test Set-up and Operation Modes

### 5.1 Principle of Configuration Selection

The EUT is commanded to operate at maximum transmitting power. The EUT shall use its internal transmitter. The antenna, battery and accessories shall be those specified by the manufacturer. The EUT battery must be fully charged and checked periodically during the test to ascertain uniform power output.

**Table 6: Configuration of EUT**

Operation mode	Frequency Range (MHz)	Modulation	Default Test Channel			Power Control Level
			Low	Middle	High	
802.11b/g/n(HT20)	2412-2462	DSSS, OFDM	CH1	CH6	CH11	Test software was used to configure the EUT to transmit at maximum output power
802.11n(HT40)	2422-2462	OFDM	CH3	CH7	CH11	
802.11a/n(HT20)	5180-5240	OFDM	CH40	---	CH44	
	5745-5825	OFDM	CH149	CH157	CH165	
802.11n(HT40)	5190-5230	OFDM	CH38	---	CH46	
	5755-5795	OFDM	CH151	---	CH159	
Bluetooth (BDR & EDR)	2402-2480	FHSS	CH0	CH39	CH78	
Bluetooth (Low Energy)	2402-2480	GFSK	CH0	CH19	CH39	

### 5.2 Tissue Simulating Liquid Ingredients

The liquid is consisted of Water, Salt, Glycol and DGBE. The liquid has previously been proven to be suited for worst-case. The following table shows the detail solution.

**Table 7: Composition of Tissue Simulating Liquid**

MIXTURE%(Weight)	FREQUENCY (Body) 2450MHz
Water	73.2
Glycol	26.7
Salt	0.1
Dielectric Parameters Target Value	f=2450MHz $\epsilon=52.70$ $\sigma=1.95$
MIXTURE%(Weight)	FREQUENCY (Body) 5GHz
Water	75.68
DGBE	4.42
Triton X-100	19.47
Salt	0.43
Dielectric Parameters Target Value	f=5200MHz $\epsilon=49.00$ $\sigma=5.30$ f=5300MHz $\epsilon=48.90$ $\sigma=5.42$ f=5500MHz $\epsilon=48.60$ $\sigma=5.65$ f=5600MHz $\epsilon=48.50$ $\sigma=5.77$ f=5800MHz $\epsilon=48.20$ $\sigma=6.00$

### 5.3 Specific Absorption Rate (SAR) System Check

The manufacturer calibrates the probes annually. Dielectric parameters of the tissue simulants were measured every day using the dielectric probe kit and the network analyzer. A system check measurement was made following the determination of the dielectric parameters of the simulant, using the dipole validation kit. A power level of 250 mW was supplied to the dipole antenna, which was placed under the flat section of the twin SAM phantom. The system check results (dielectric parameters and SAR values) are given in the table 5. System check results have to be equal or near the values determined during dipole calibration with the relevant liquids and test system ( $\pm 10\%$ ). System check is performed regularly on all frequency bands where tests are performed with the DASY5 system.

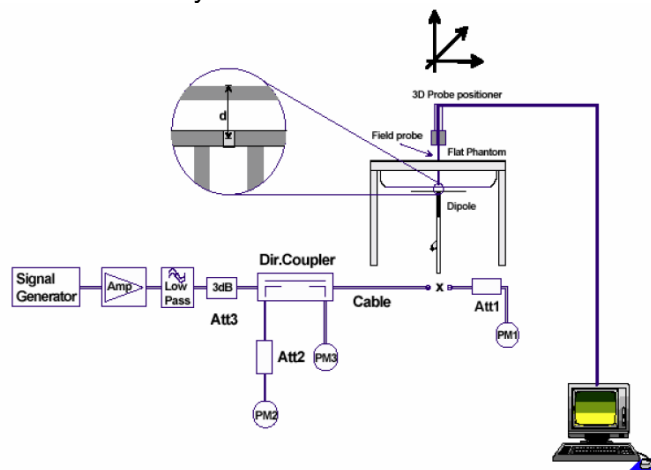

Picture 9 System Check Set-up

Table 8: System Check Results of Tissue Simulating Liquid

Tissue Verification										
CH	Frequency (MHz)	Liquid Type	Conductivity ( $\sigma$ )	Permittivity ( $\epsilon_r$ )	Conductivity Target ( $\sigma$ )	Permittivity Target ( $\epsilon_r$ )	Delta ( $\sigma$ ) (%)	Delta ( $\epsilon_r$ ) (%)	Limit (%)	Date
1	2412	Body	1.973	52.917	1.914	52.751	3.30	0.22	$\pm 5$	2015-09-10
6	2437	Body	2.008	52.871	1.938	52.717	3.51	0.32	$\pm 5$	2015-09-10
11	2462	Body	2.046	52.782	1.967	52.684	3.86	0.16	$\pm 5$	2015-09-10
36	5180	Body	5.247	49.272	5.276	49.027	-0.63	0.56	$\pm 5$	2015-09-10
48	5240	Body	5.347	49.089	5.346	48.960	-0.06	0.18	$\pm 5$	2015-09-10
149	5745	Body	6.027	48.284	5.936	48.283	1.46	-0.03	$\pm 5$	2015-09-10
165	5825	Body	6.203	48.002	6.000	48.200	3.38	-0.41	$\pm 5$	2015-09-10

Frequency (MHz)	Tissue Type	Liquid Temp. ( $^{\circ}\text{C}$ )	Conductivity ( $\sigma$ )	Permittivity ( $\epsilon_r$ )	Conductivity Target ( $\sigma$ )	Permittivity Target ( $\epsilon_r$ )	Delta ( $\sigma$ ) (%)	Delta ( $\epsilon_r$ ) (%)	Limit (%)	Date
2450	Body	22.8	2.028	52.823	1.95	52.70	4.00	0.23	$\pm 5$	2015-09-10
5200	Body	22.7	5.266	49.165	5.30	49.00	-0.64	0.34	$\pm 5$	2015-09-10
5800	Body	22.6	6.128	47.929	6.00	48.20	2.13	-0.56	$\pm 5$	2015-09-10

**Table 9: System Validation**

Frequency (MHz)	Tissue Type	Input Power (mW)	Dipole S/N	Probe S/N	DAE S/N	Measured 1g SAR (W/kg)	Targeted 1g SAR (W/kg)	Normalized 1g SAR (W/kg)	Deviation (%)	SAR (1g or 10g)
2450	Body	250	927	3970	1418	12.90	50.40	51.6	2.38	1g
5200	Body	100	1169	3970	1418	7.65	73.80	76.5	3.66	1g
5800	Body	100	1169	3970	1418	7.52	74.30	75.2	1.21	1g

## 5.4 Exposure Positions Consideration

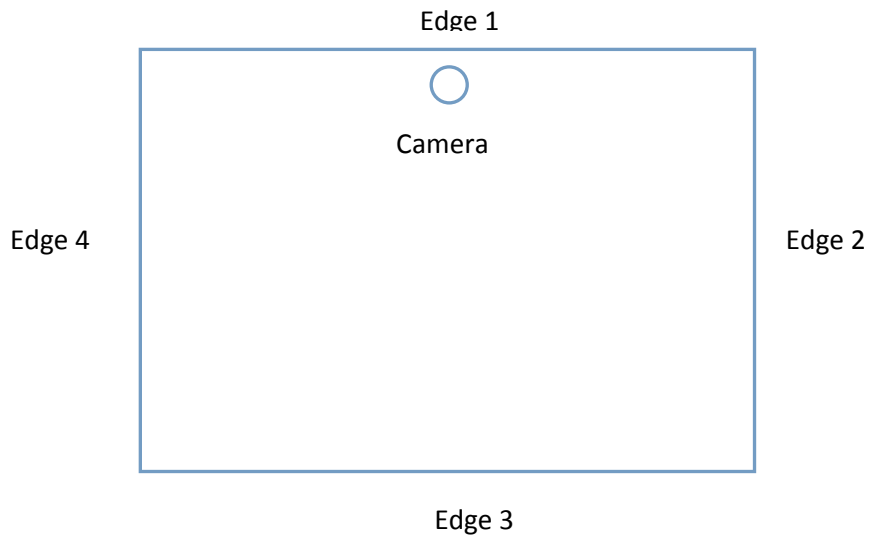

**Distance of the Antenna to the EUT surface/edge**

	<b>Bottom</b>	<b>Front</b>	<b>Edge 1</b>	<b>Edge 2</b>	<b>Edge 3</b>	<b>Edge 4</b>
<b>Antennas</b>						
<b>WWAN Main</b>	≤ 25mm	> 25mm	≤ 25mm	> 25mm	> 25mm	>25mm

## 5.5 Test Operation and Test Software

Test operation refers to test setup in chapter 5.

For WLAN SAR testing, WLAN engineering testing software installed on the EUT can provide continuous transmitting RF signal. This RF signal utilized in SAR measurement has almost 100% duty cycle and its crest factor is 1.

For the 802.11b/g/n SAR tests, a communication link is setup with the test mode software for WIFI mode test, during the test, each test frequency channel, the EUT is operated at the RF continuous emission mode. Each channel should be tested at the lowest data rate. Testing at higher data rates is not required when the maximum average output power is less than 0.25dB higher than those measured at the lowest data rate.

802.11b/g/n operating modes are tested independently according to the service requirements in each frequency band. 802.11b/g/n modes are tested on the maximum average output channel.

SAR is not required for 802.11g/n channels when the maximum average output power is less than 0.25dB higher than that measured on the corresponding 802.11b channels.

For the 2.4GHz and 5GHz bands, when the same maximum output power was specified for multiple OFDM transmission mode configurations in a frequency band or aggregated band, SAR is measured using the configuration with largest channel bandwidth, lowest order modulation and lowest data rate. When the maximum output power of a channel is the same for equivalent OFDM configurations, the lower order 802.11 mode is used for SAR measurement.

## 5.6 Special Accessories and Auxiliary Equipment

None.



## 6. Test Results

### 6.1 Human Exposure to Radiofrequency Electromagnetic Fields

**RESULT:** **Passed**

Date of testing : 2015-09-10  
Test standard : CFR Title 47 Part 2 Subpart J Section 2.1093  
ANSI/IEEE C95.1-1992  
IEEE 1528-2003  
FCC KDB Publication : KDB 447498 D01 v05r01  
KDB 248227 D01 v01r02  
KDB 616217 D04 v01r01  
KDB 865664 D01 v01r01  
RSS-102 Issue 5 March 2015  
Limits : 1.6W/kg

#### Test setup

Operation mode : A  
Ambient temperature : 23°C  
Relative humidity : 50%  
Atmospheric pressure : 101.0kPa

Note: Wi-Fi antenna and Bluetooth cannot transmitter simultaneously.

**Table 10: Conducted Power of 802.11b**

Channel	Frequency (MHz)	Average power (dBm)				Tune-Up Limit	Duty Cycle %
		Data Rate					98.28
		1Mbps	2Mbps	5.5Mbps	11Mbps		Max
CH 1	2412	14.08				14.5	14.26
CH 6	2437	14.26	14.21	14.16	13.94		
CH 11	2462	13.79					

**Table 11: Conducted Power of 802.11g**

Channel	Frequency (MHz)	Average power (dBm)								Tune-Up Limit	Duty Cycle %
		Data Rate									92.66
		6Mbps	9Mbps	12Mbps	18Mbps	24Mbps	36Mbps	48Mbps	54Mbps		Max
CH 1	2412	13.31								13.5	13.43
CH 6	2437	13.43	13.36	13.24	13.07	12.82	12.43	12.09	11.91		
CH 11	2462	13.01									



**Table 16: Conducted Power of 802.11n HT40**

Channel	Frequency (MHz)	Average Power (dBm)								Tune-up Limit	Duty Cycle %
		MCS Index									86.922
		MCS0	MCS1	MCS2	MCS3	MCS4	MCS5	MCS6	MCS7		Max
CH 38	5190	7.72	7.17	6.76	6.47	5.85	5.32	5.15	4.97	8	7.72
CH 46	5230	7.67								8	
CH 151	5755	7.68								8.5	8.18
CH 159	5795	8.18	7.68	7.22	6.89	6.31	5.85	5.68	5.48	8.5	

**Table 17: Conducted Power of Bluetooth (BDR & EDR)**

Channel	Frequency (MHz)	Bluetooth Average power (dBm)		
		1Mbps	2Mbps	3Mbps
CH 00	2402	-1.39	-2.67	-2.24
CH 39	2441	-0.34	-2.27	-1.80
CH 78	2480	-0.03	-2.10	-1.62

**Table 18: Conducted Power of Bluetooth (Low Energy)**

Channel	Frequency (MHz)	Bluetooth Average power (dBm)
		GFSK
CH 00	2402	2.69
CH 19	2440	2.52
CH 39	2480	2.48

**Table 19: Test result of SAR Values**

Band	Mode	Test Position	Gap (cm)	Ch.	Freq. (MHz)	configure	Average Power (dBm)	Tune-Up Limit (dBm)	Tune-up Scaling Factor	Duty Cycle %	Duty Cycle Scaling Factor	Power Drift (dB)	Measured 1g SAR (W/kg)	Reported 1g SAR (W/kg)	Date
WLAN2.4G	802.11b	Bottom Face	0	6	2437	1Mbps	14.26	14.50	1.057	98.28	1.018	-0.09	0.578	0.622	2015-09-10
WLAN2.4G	802.11b	Edge 1	0	6	2437	1Mbps	14.26	14.50	1.057	98.28	1.018	-0.04	0.226	0.243	2015-09-10
WLAN2.4G	802.11b	Bottom Face	0	1	2412	1Mbps	14.08	14.50	1.102	98.28	1.018	-0.03	0.549	0.616	2015-09-10
WLAN2.4G	802.11b	Bottom Face	0	11	2462	1Mbps	13.79	14.50	1.178	98.28	1.018	-0.08	0.571	<b>0.685</b>	2015-09-10
WLAN5G Band 1	802.11a	Bottom Face	0	48	5240	6Mbps	9.42	9.50	1.019	93.668	1.068	-0.09	0.292	<b>0.318</b>	2015-09-10
WLAN5G Band 1	802.11a	Edge 1	0	48	5240	6Mbps	9.42	9.50	1.019	93.668	1.068	-0.03	0.212	0.231	2015-09-10
WLAN5G Band 1	802.11a	Bottom Face	0	36	5180	6Mbps	8.59	9.50	1.233	93.668	1.068	-0.05	0.22	0.290	2015-09-10
WLAN5G Band 4	802.11a	Bottom Face	0	149	5745	6Mbps	9.16	9.50	1.081	93.668	1.068	-0.03	0.306	0.353	2015-09-10
WLAN5G Band 4	802.11a	Edge 1	0	149	5745	6Mbps	9.16	9.50	1.081	93.668	1.068	-0.07	0.203	0.234	2015-09-10
WLAN5G Band 4	802.11a	Bottom Face	0	165	5825	6Mbps	7.93	9.50	1.435	93.668	1.068	-0.06	0.297	<b>0.455</b>	2015-09-10

Refer to attached Appendix B for details of test results.

## 6.2 Measurement Uncertainty

### 6.2.1 Measurement uncertainty evaluation

This measurement uncertainty budget is suggested by IEEE P1528. The breakdown of the individual uncertainties is as follows:

**Table 20: Measurement Uncertainties**

No.	Description	Type	Uncertainty Value (%)	Probably Distribution	Div.	(Ci) 1g	(Ci) 10g	Std. Unc. (1g)	Std. Unc. (10g)	Degree of freedom
<b>Measurement system</b>										
1	Probe calibration	B	5.5	N	1	1	1	5.5	5.5	∞
2	Isotropy	B	4.7	R	$\sqrt{3}$	0.7	0.7	1.9	1.9	∞
3	Boundary effect	B	1.0	R	$\sqrt{3}$	1	1	0.6	0.6	∞
4	Linearity	B	4.7	R	$\sqrt{3}$	1	1	2.7	2.7	∞
5	Detection limit	B	1.0	N	1	1	1	0.6	0.6	∞
6	Readout electronics	B	0.3	R	$\sqrt{3}$	1	1	0.3	0.3	∞
7	Response time	B	0.8	R	$\sqrt{3}$	1	1	0.5	0.5	∞
8	Integration time	B	2.6	R	$\sqrt{3}$	1	1	1.5	1.5	∞
9	RF ambient conditions-noise	B	0	R	$\sqrt{3}$	1	1	0	0	∞
10	RF ambient conditions-reflection	B	0	R	$\sqrt{3}$	1	1	0	0	∞
11	Probe positioned mech. restrictions	B	0.4	R	$\sqrt{3}$	1	1	0.2	0.2	∞
12	Probe positioning with respect to phantom shell	B	2.9	R	$\sqrt{3}$	1	1	1.7	1.7	∞
13	Post-processing	B	1.0	R	$\sqrt{3}$	1	1	0.6	0.6	∞
<b>Test sample related</b>										
14	Test sample positioning	A	3.3	N	1	1	1	3.3	3.3	71
15	Device holder uncertainty	A	3.4	N	1	1	1	3.4	3.4	5
16	Drift of output power	B	5.0	R	$\sqrt{3}$	1	1	2.9	2.9	∞
<b>Phantom and set-up</b>										
17	Phantom uncertainty	B	4.0	R	$\sqrt{3}$	1	1	2.3	2.3	∞
18	Liquid conductivity (target)	B	5.0	R	$\sqrt{3}$	0.64	0.43	1.8	1.2	∞
19	Liquid conductivity (meas.)	A	2.06	N	1	0.64	0.43	1.32	0.89	43
20	Liquid permittivity (target)	B	5.0	R	$\sqrt{3}$	0.6	0.49	1.7	1.4	∞
21	Liquid permittivity (meas.)	A	1.6	N	1	0.6	0.49	1.0	0.8	521
Combined standard uncertainty		$u_c = \sqrt{\sum_{i=1}^{21} c_i^2 u_i^2}$						9.25	9.12	257
Expanded uncertainty (Confidence interval of 95%)		$u_e = 2u_c$						18.5	18.2	\

## 7. Photographs of the Test Set-Up

Photograph 1: Set-up for Bottom Face

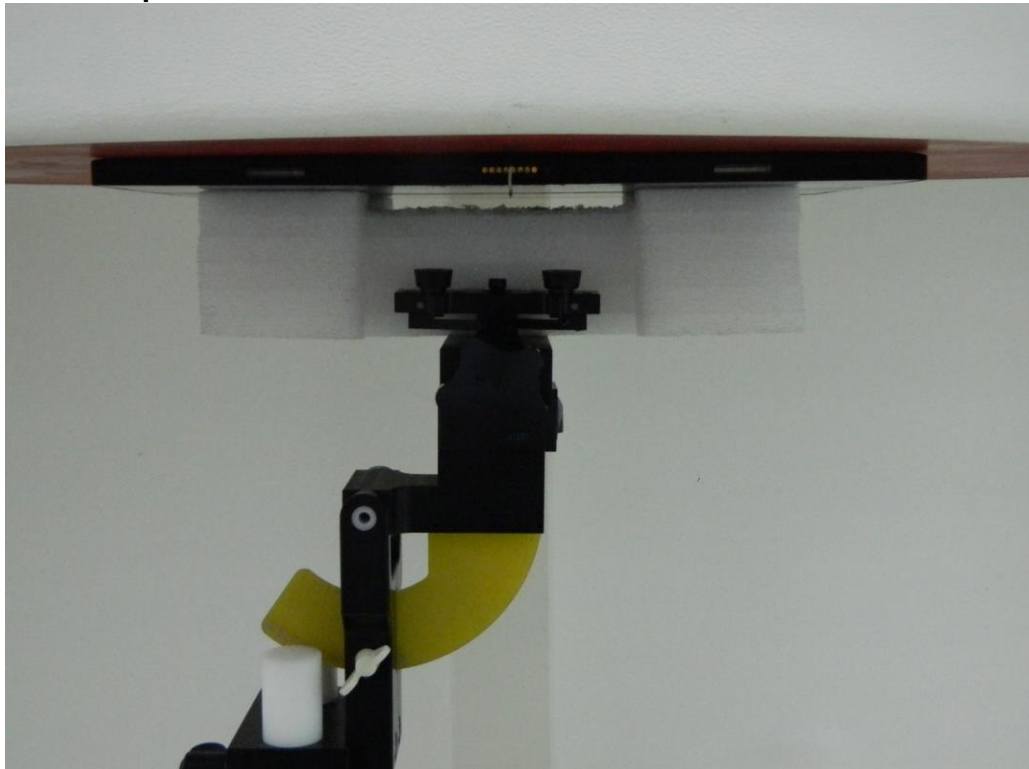

Photograph 2: Set-up for Edge 1



## 8. List of Tables

Table 1: List of Test and Measurement Equipment .....	6
Table 2: Technical Specification .....	7
Table 3: List of WLAN Channel of 802.11b/g/n mode .....	8
Table 4: List of WLAN Channel of 802.11a/n mode .....	8
Table 5: List of Bluetooth Channel .....	8
Table 6: Configuration of EUT .....	20
Table 7: Composition of Tissue Simulating Liquid .....	20
Table 8: System Check Results of Tissue Simulating Liquid .....	21
Table 9: System Validation .....	22
Table 10: Conducted Power of 802.11b .....	25
Table 11: Conducted Power of 802.11g .....	25
Table 12: Conducted Power of 802.11n (HT20) .....	26
Table 13: Conducted Power of 802.11n (HT40) .....	26
Table 14: Conducted Power of 802.11a .....	26
Table 15: Conducted Power of 802.11n HT20 .....	26
Table 16: Conducted Power of 802.11n HT40 .....	27
Table 17: Conducted Power of Bluetooth (BDR & EDR) .....	27
Table 18: Conducted Power of Bluetooth (Low Energy) .....	27
Table 19: Test result of SAR Values .....	28
Table 20: Measurement Uncertainties .....	29

## 9. List of Photographs

Photograph 1: Set-up for Bottom Face .....	30
Photograph 2: Set-up for Edge 1 .....	30

Test Laboratory: Shenzhen EMTEK Co.,Ltd.

Date/Time: 10.09.2015

### SystemPerformanceCheck-D2450V2-MSL-150910

**DUT: Dipole 2450 MHz D2450V2 SN:927**

Communication System: UID 0, CW (0); Frequency: 2450 MHz;Duty Cycle: 1:1

Medium: MSL\_2450\_150910

Medium parameters used:  $f = 2450$  MHz;  $\sigma = 2.028$  S/m;  $\epsilon_r = 52.823$ ;  $\rho = 1000$  kg/m<sup>3</sup>

Ambient Temperature: 23.5 °C; Liquid Temperature: 22.8 °C

DASY Configuration:

- Probe: EX3DV4 - SN3970; ConvF(7.66, 7.66, 7.66); Calibrated: 10.07.2015;
- Sensor-Surface: 2mm (Mechanical Surface Detection)
- Electronics: DAE4 Sn1418; Calibrated: 23.06.2015
- Phantom: ELI v5.0; Type: QDOVA002AA; Serial: TP:1231
- DASY52 52.8.7(1137); SEMCAD X 14.6.10(7164)

**System Performance Check at Frequency at 2450MHz/d=10mm, Pin=250mW, dist=2.0mm (EX-Probe)/Area Scan (41x61x1):** Interpolated grid: dx=12mm, dy=12mm  
Maximum value of SAR (interpolated) = 17.1 W/kg

**System Performance Check at Frequency at 2450MHz/d=10mm, Pin=250mW, dist=2.0mm (EX-Probe)/Zoom Scan (7x7x7)/Cube 0:** Measurement grid: dx=5mm, dy=5mm, dz=5mm

Reference Value = 95.967 V/m; Power Drift = 0.05 dB

Peak SAR (extrapolated) = 26.6 W/kg

**SAR(1 g) = 12.9 W/kg; SAR(10 g) = 5.92 W/kg**

Maximum value of SAR (measured) = 16.9 W/kg

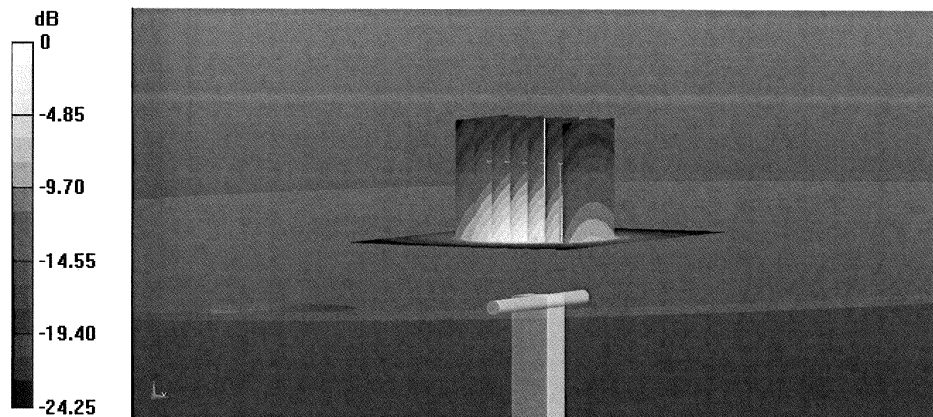

0 dB = 16.9 W/kg = 12.28 dBW/kg



Test Laboratory: Shenzhen EMTEK Co.,Ltd.

Date/Time: 10.09.2015

**SystemPerformanceCheck-D5GHzV2-5200MHz-MSL-150910**

**DUT: Dipole D5GHzV2 SN:1169**

Communication System: UID 0, CW (0); Frequency: 5200 MHz;Duty Cycle: 1:1

Medium: MSL\_5G\_150910

Medium parameters used:  $f = 5200$  MHz;  $\sigma = 5.266$  S/m;  $\epsilon_r = 49.165$ ;  $\rho = 1000$  kg/m<sup>3</sup>

Ambient Temperature: 23.3 °C; Liquid Temperature: 22.7 °C

DASY Configuration:

- Probe: EX3DV4 - SN3970; ConvF(5.08, 5.08, 5.08); Calibrated: 10.07.2015;
- Sensor-Surface: 1.4mm (Mechanical Surface Detection)
- Electronics: DAE4 Sn1418; Calibrated: 23.06.2015
- Phantom: ELI v5.0; Type: QDOVA002AA; Serial: TP:1231
- DASY52 52.8.7(1137); SEMCAD X 14.6.10(7164)

**System Performance Check at Frequency at 5200MHz/d=10mm, Pin=100mW, dist=1.4mm (EX-Probe)/Area Scan (91x91x1):** Interpolated grid: dx=10mm, dy=10mm  
Maximum value of SAR (interpolated) = 16.3 W/kg

**System Performance Check at Frequency at 5200MHz/d=10mm, Pin=100mW, dist=1.4mm (EX-Probe)/Zoom Scan (7x7x9)/Cube 0:** Measurement grid: dx=4mm, dy=4mm, dz=2.5mm

Reference Value = 64.4 V/m; Power Drift = 0.01 dB

Peak SAR (extrapolated) = 29.1 W/kg

**SAR(1 g) = 7.65 W/kg; SAR(10 g) = 2.21 W/kg**

Maximum value of SAR (measured) = 16.5 W/kg

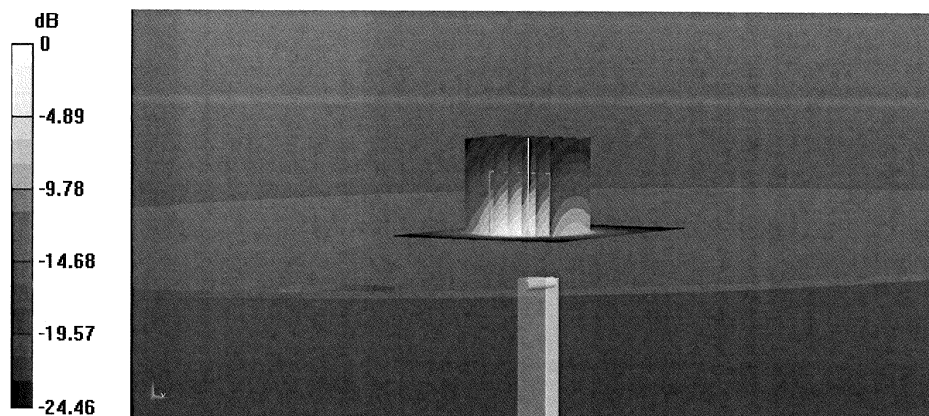

0 dB = 16.5 W/kg = 12.17 dBW/kg

Test Laboratory: Shenzhen EMTEK Co.,Ltd.

Date/Time: 10.09.2015

**SystemPerformanceCheck-D5GHzV2-5800MHz-MSL-150910**

**DUT: Dipole D5GHzV2 SN:1169**

Communication System: UID 0, CW (0); Frequency: 5800 MHz;Duty Cycle: 1:1

Medium: MSL\_5G\_150910

Medium parameters used:  $f = 5800$  MHz;  $\sigma = 6.128$  S/m;  $\epsilon_r = 47.929$ ;  $\rho = 1000$  kg/m<sup>3</sup>

Ambient Temperature: 23.4 °C; Liquid Temperature: 22.6 °C

DASY Configuration:

- Probe: EX3DV4 - SN3970; ConvF(4.69, 4.69, 4.69); Calibrated: 10.07.2015;
- Sensor-Surface: 1.4mm (Mechanical Surface Detection)
- Electronics: DAE4 Sn1418; Calibrated: 23.06.2015
- Phantom: ELI v5.0; Type: QDOVA002AA; Serial: TP:1231
- DASY52 52.8.7(1137); SEMCAD X 14.6.10(7164)

**System Performance Check at Frequency at 5800MHz/d=10mm, Pin=100mW, dist=1.4mm (EX-Probe)/Area Scan (91x91x1):** Interpolated grid: dx=10mm, dy=10mm  
Maximum value of SAR (interpolated) = 16.1 W/kg

**System Performance Check at Frequency at 5800MHz/d=10mm, Pin=100mW, dist=1.4mm (EX-Probe)/Zoom Scan (7x7x9)/Cube 0:** Measurement grid: dx=4mm, dy=4mm, dz=2.5mm

Reference Value = 68.2 V/m; Power Drift = 0.01 dB

Peak SAR (extrapolated) = 28.9 W/kg

**SAR(1 g) = 7.52 W/kg; SAR(10 g) = 2.19 W/kg**

Maximum value of SAR (measured) = 16.2 W/kg

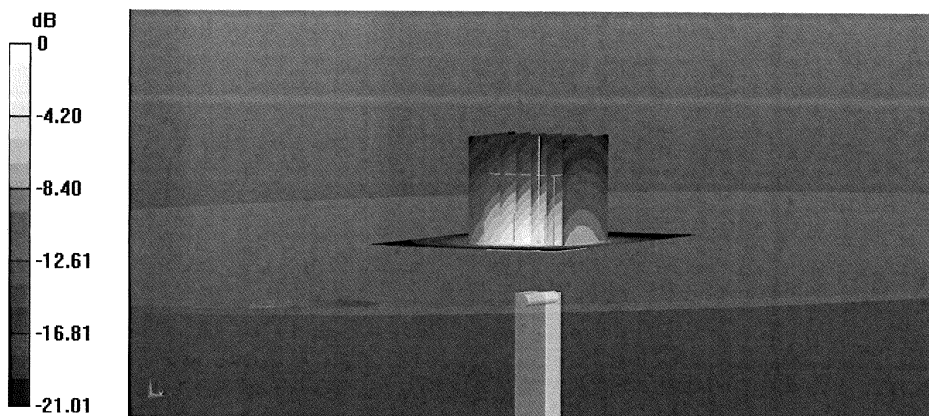

0 dB = 16.2 W/kg = 12.10 dBW/kg

Test Laboratory: Shenzhen EMTEK Co.,Ltd.

Date/Time: 10.09.2015

**01-WLAN2.4GHz-802.11b 1Mbps-Bottom Face-0cm-Ch6**

Communication System: UID 0, WIFI (0); Frequency: 2437 MHz;Duty Cycle: 1:1.018

Medium: MSL\_2450\_150910

Medium parameters used:  $f = 2437$  MHz;  $\sigma = 2.008$  S/m;  $\epsilon_r = 52.871$ ;  $\rho = 1000$  kg/m<sup>3</sup>

Ambient Temperature: 23.5 °C; Liquid Temperature: 22.8 °C

DASY Configuration:

- Probe: EX3DV4 - SN3970; ConvF(7.66, 7.66, 7.66); Calibrated: 10.07.2015;
- Sensor-Surface: 2mm (Mechanical Surface Detection)
- Electronics: DAE4 Sn1418; Calibrated: 23.06.2015
- Phantom: ELI v5.0; Type: QDOVA002AA; Serial: TP:1231
- DASY52 52.8.7(1137); SEMCAD X 14.6.10(7164)

**Configuration/Ch6/Area Scan (81x271x1):** Interpolated grid: dx=12mm, dy=12mm  
Maximum value of SAR (interpolated) = 0.922 W/kg

**Configuration/Ch6/Zoom Scan (7x7x7)/Cube 0:** Measurement grid: dx=5mm, dy=5mm, dz=5mm

Reference Value = 1.741 V/m; Power Drift = -0.09 dB

Peak SAR (extrapolated) = 1.33 W/kg

**SAR(1 g) = 0.578 W/kg; SAR(10 g) = 0.244 W/kg**

Maximum value of SAR (measured) = 0.944 W/kg

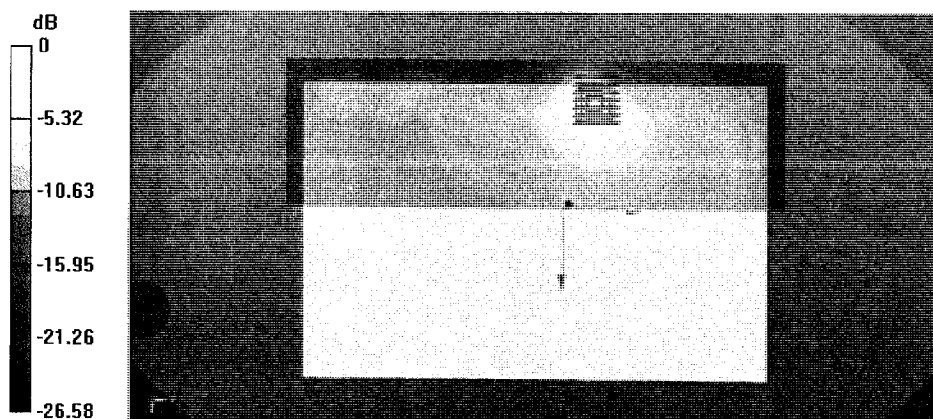

0 dB = 0.944 W/kg = -0.25 dBW/kg

Test Laboratory: Shenzhen EMTEK Co.,Ltd.

Date/Time: 10.09.2015

**02-WLAN2.4GHz-802.11b 1Mbps-Edge 1-0cm-Ch6**

Communication System: UID 0, WIFI (0); Frequency: 2437 MHz;Duty Cycle: 1:1.018

Medium: MSL\_2450\_150910

Medium parameters used:  $f = 2437$  MHz;  $\sigma = 2.008$  S/m;  $\epsilon_r = 52.871$ ;  $\rho = 1000$  kg/m<sup>3</sup>

Ambient Temperature: 23.5 °C; Liquid Temperature: 22.8 °C

DASY Configuration:

- Probe: EX3DV4 - SN3970; ConvF(7.66, 7.66, 7.66); Calibrated: 10.07.2015;
- Sensor-Surface: 2mm (Mechanical Surface Detection)
- Electronics: DAE4 Sn1418; Calibrated: 23.06.2015
- Phantom: ELI v5.0; Type: QDOVA002AA; Serial: TP:1231
- DASY52 52.8.7(1137); SEMCAD X 14.6.10(7164)

**Configuration/Ch6/Area Scan (41x271x1):** Interpolated grid: dx=12mm, dy=12mm  
Maximum value of SAR (interpolated) = 0.351 W/kg

**Configuration/Ch6/Zoom Scan (7x7x7)/Cube 0:** Measurement grid: dx=5mm, dy=5mm, dz=5mm  
Reference Value = 4.589 V/m; Power Drift = -0.04 dB  
Peak SAR (extrapolated) = 0.571 W/kg  
**SAR(1 g) = 0.226 W/kg; SAR(10 g) = 0.089 W/kg**  
Maximum value of SAR (measured) = 0.393 W/kg

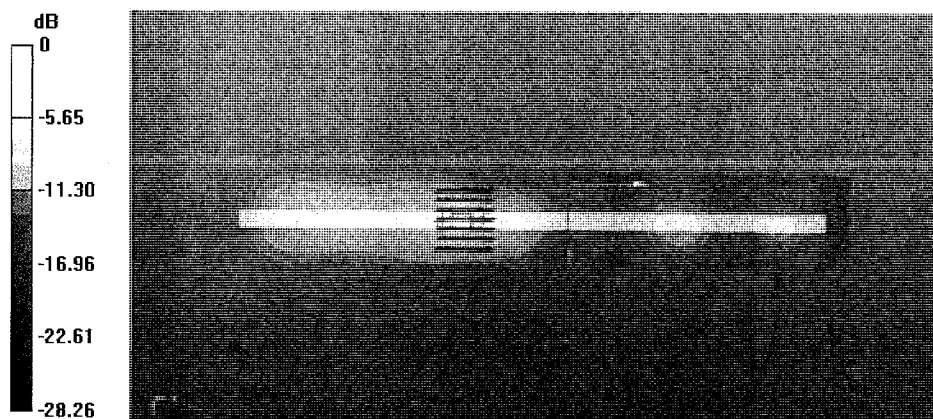

0 dB = 0.393 W/kg = -4.06 dBW/kg

Test Laboratory: Shenzhen EMTEK Co.,Ltd.

Date/Time: 10.09.2015

**03-WLAN2.4GHz-802.11b 1Mbps-Bottom Face-0cm-Ch1**

Communication System: UID 0, WIFI (0); Frequency: 2412 MHz;Duty Cycle: 1:1.018

Medium: MSL\_2450\_150910

Medium parameters used:  $f = 2412$  MHz;  $\sigma = 1.973$  S/m;  $\epsilon_r = 52.917$ ;  $\rho = 1000$  kg/m<sup>3</sup>

Ambient Temperature: 23.5 °C; Liquid Temperature: 22.8 °C

DASY Configuration:

- Probe: EX3DV4 - SN3970; ConvF(7.66, 7.66, 7.66); Calibrated: 10.07.2015;
- Sensor-Surface: 2mm (Mechanical Surface Detection)
- Electronics: DAE4 Sn1418; Calibrated: 23.06.2015
- Phantom: ELI v5.0; Type: QDOVA002AA; Serial: TP:1231
- DASY52 52.8.7(1137); SEMCAD X 14.6.10(7164)

**Configuration/Ch1/Area Scan (61x101x1):** Interpolated grid: dx=12mm, dy=12mm  
Maximum value of SAR (interpolated) = 0.842 W/kg

**Configuration/Ch1/Zoom Scan (7x7x7)/Cube 0:** Measurement grid: dx=5mm, dy=5mm,  
dz=5mm

Reference Value = 1.341 V/m; Power Drift = -0.03 dB

Peak SAR (extrapolated) = 1.25 W/kg

**SAR(1 g) = 0.549 W/kg; SAR(10 g) = 0.234 W/kg**

Maximum value of SAR (measured) = 0.898 W/kg

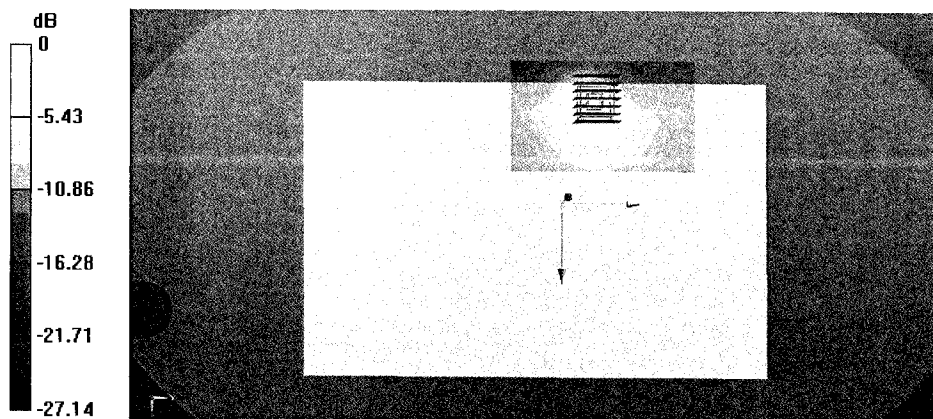

0 dB = 0.898 W/kg = -0.47 dBW/kg

Test Laboratory: Shenzhen EMTEK Co.,Ltd.

Date/Time: 10.09.2015

**04-WLAN2.4GHz-802.11b 1Mbps-Bottom Face-0cm-Ch11**

Communication System: UID 0, WIFI (0); Frequency: 2462 MHz;Duty Cycle: 1:1.018

Medium: MSL\_2450\_150910

Medium parameters used:  $f = 2462$  MHz;  $\sigma = 2.046$  S/m;  $\epsilon_r = 52.782$ ;  $\rho = 1000$  kg/m<sup>3</sup>

Ambient Temperature: 23.5 °C; Liquid Temperature: 22.8 °C

DASY Configuration:

- Probe: EX3DV4 - SN3970; ConvF(7.66, 7.66, 7.66); Calibrated: 10.07.2015;
- Sensor-Surface: 2mm (Mechanical Surface Detection)
- Electronics: DAE4 Sn1418; Calibrated: 23.06.2015
- Phantom: ELI v5.0; Type: QDOVA002AA; Serial: TP:1231
- DASY52 52.8.7(1137); SEMCAD X 14.6.10(7164)

**Configuration/Ch11/Area Scan (61x101x1):** Interpolated grid: dx=12mm, dy=12mm  
Maximum value of SAR (interpolated) = 0.897 W/kg

**Configuration/Ch11/Zoom Scan (7x7x7)/Cube 0:** Measurement grid: dx=5mm, dy=5mm, dz=5mm

Reference Value = 1.631 V/m; Power Drift = -0.08 dB

Peak SAR (extrapolated) = 1.31 W/kg

**SAR(1 g) = 0.571 W/kg; SAR(10 g) = 0.244 W/kg**

Maximum value of SAR (measured) = 0.924 W/kg

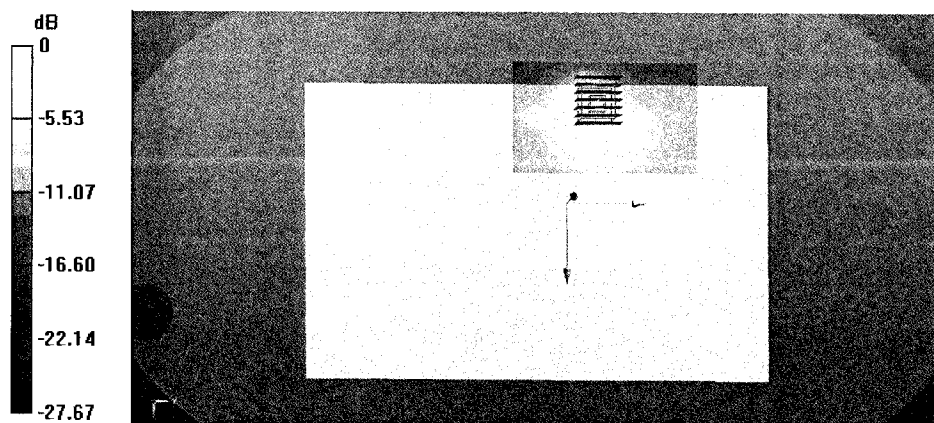

0 dB = 0.924 W/kg = -0.34 dBW/kg

Test Laboratory: Shenzhen EMTEK Co.,Ltd.

Date/Time: 10.09.2015

**05-WLAN5GHz Band 1-802.11a 6Mbps-Bottom Face-0cm-Ch48**

Communication System: UID 0, WIFI (0); Frequency: 5240 MHz;Duty Cycle: 1:1.068

Medium: MSL\_5G\_150910

Medium parameters used:  $f = 5240$  MHz;  $\sigma = 5.347$  S/m;  $\epsilon_r = 49.089$ ;  $\rho = 1000$  kg/m<sup>3</sup>

Ambient Temperature: 23.3 °C; Liquid Temperature: 22.7 °C

DASY Configuration:

- Probe: EX3DV4 - SN3970; ConvF(5.08, 5.08, 5.08); Calibrated: 10.07.2015;
- Sensor-Surface: 1.4mm (Mechanical Surface Detection)
- Electronics: DAE4 Sn1418; Calibrated: 23.06.2015
- Phantom: ELI v5.0; Type: QDOVA002AA; Serial: TP:1231
- DASY52 52.8.7(1137); SEMCAD X 14.6.10(7164)

**Configuration/Ch48/Area Scan (71x91x1):** Interpolated grid: dx=10mm, dy=10mm  
Maximum value of SAR (interpolated) = 0.631 W/kg

**Configuration/Ch48/Zoom Scan (7x7x7)/Cube 0:** Measurement grid: dx=4mm, dy=4mm, dz=1.4mm

Reference Value = 1.054 V/m; Power Drift = -0.09 dB

Peak SAR (extrapolated) = 1.29 W/kg

**SAR(1 g) = 0.292 W/kg; SAR(10 g) = 0.095 W/kg**

Maximum value of SAR (measured) = 0.720 W/kg

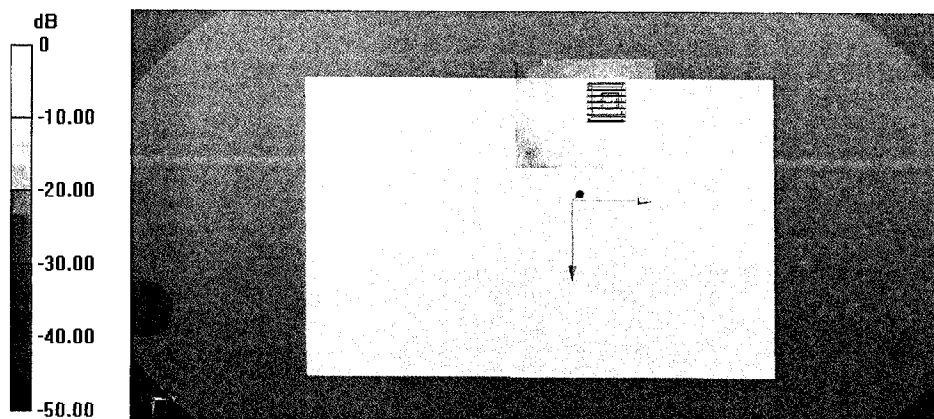

0 dB = 0.720 W/kg = -1.43 dBW/kg

Test Laboratory: Shenzhen EMTEK Co.,Ltd.

Date/Time: 10.09.2015

**06-WLAN5GHz Band 1-802.11a 6Mbps-Edge 1-0cm-Ch48**

Communication System: UID 0, WIFI (0); Frequency: 5240 MHz;Duty Cycle: 1:1.068

Medium: MSL\_5G\_150910

Medium parameters used:  $f = 5240$  MHz;  $\sigma = 5.347$  S/m;  $\epsilon_r = 49.089$ ;  $\rho = 1000$  kg/m<sup>3</sup>

Ambient Temperature: 23.3 °C; Liquid Temperature: 22.7 °C

DASY Configuration:

- Probe: EX3DV4 - SN3970; ConvF(5.08, 5.08, 5.08); Calibrated: 10.07.2015;
- Sensor-Surface: 1.4mm (Mechanical Surface Detection)
- Electronics: DAE4 Sn1418; Calibrated: 23.06.2015
- Phantom: ELI v5.0; Type: QDOVA002AA; Serial: TP:1231
- DASY52 52.8.7(1137); SEMCAD X 14.6.10(7164)

**Configuration/Ch48/Area Scan (41x121x1):** Interpolated grid: dx=10mm, dy=10mm  
Maximum value of SAR (interpolated) = 0.391 W/kg

**Configuration/Ch48/Zoom Scan (7x7x7)/Cube 0:** Measurement grid: dx=4mm, dy=4mm, dz=1.4mm

Reference Value = 2.754 V/m; Power Drift = -0.03 dB

Peak SAR (extrapolated) = 1.00 W/kg

**SAR(1 g) = 0.212 W/kg; SAR(10 g) = 0.069 W/kg**

Maximum value of SAR (measured) = 0.543 W/kg

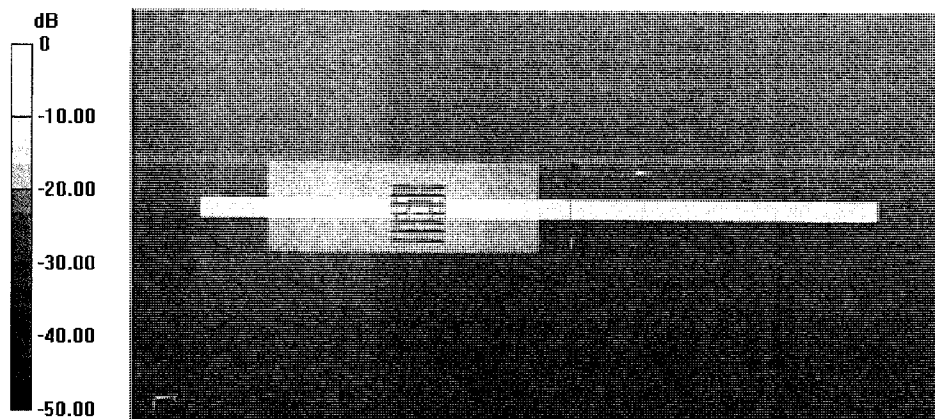

0 dB = 0.543 W/kg = -2.65 dBW/kg



Test Laboratory: Shenzhen EMTEK Co.,Ltd.

Date/Time: 10.09.2015

**07-WLAN5GHz Band 1-802.11a 6Mbps-Bottom Face-0cm-Ch36**

Communication System: UID 0, WIFI (0); Frequency: 5180 MHz;Duty Cycle: 1:1.068

Medium: MSL\_5G\_150910

Medium parameters used:  $f = 5180$  MHz;  $\sigma = 5.247$  S/m;  $\epsilon_r = 49.272$ ;  $\rho = 1000$  kg/m<sup>3</sup>

Ambient Temperature: 23.3 °C; Liquid Temperature: 22.7 °C

DASY Configuration:

- Probe: EX3DV4 - SN3970; ConvF(5.08, 5.08, 5.08); Calibrated: 10.07.2015;
- Sensor-Surface: 1.4mm (Mechanical Surface Detection)
- Electronics: DAE4 Sn1418; Calibrated: 23.06.2015
- Phantom: ELI v5.0; Type: QDOVA002AA; Serial: TP:1231
- DASY52 52.8.7(1137); SEMCAD X 14.6.10(7164)

**Configuration/Ch36/Area Scan (71x91x1):** Interpolated grid: dx=10mm, dy=10mm

Maximum value of SAR (interpolated) = 0.467 W/kg

**Configuration/Ch36/Zoom Scan (7x7x7)/Cube 0:** Measurement grid: dx=4mm, dy=4mm, dz=1.4mm

Reference Value = 2.322 V/m; Power Drift = -0.05 dB

Peak SAR (extrapolated) = 0.985 W/kg

**SAR(1 g) = 0.220 W/kg; SAR(10 g) = 0.073 W/kg**

Maximum value of SAR (measured) = 0.551 W/kg

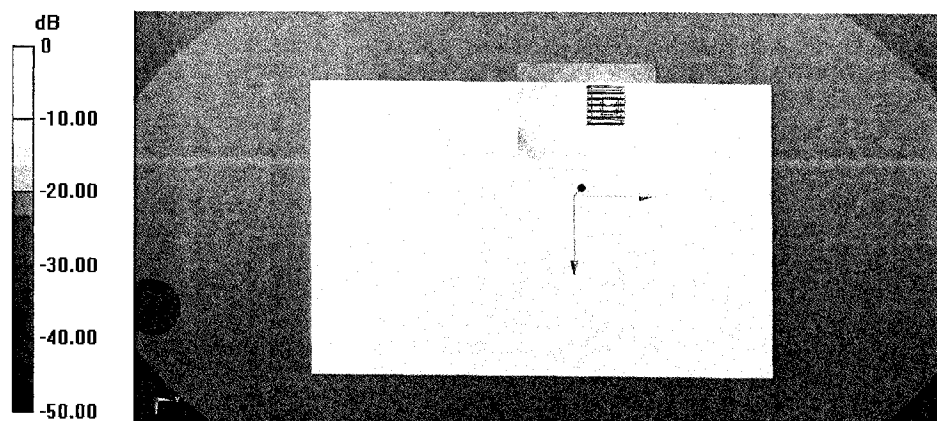

0 dB = 0.551 W/kg = -2.59 dBW/kg

Test Laboratory: Shenzhen EMTEK Co.,Ltd.

Date/Time: 10.09.2015

**08-WLAN5GHz Band 4-802.11a 6Mbps-Bottom Face-0cm-Ch149**

Communication System: UID 0, WIFI (0); Frequency: 5745 MHz; Duty Cycle: 1:1.068

Medium: MSL\_5G\_150910

Medium parameters used:  $f = 5745$  MHz;  $\sigma = 6.027$  S/m;  $\epsilon_r = 48.284$ ;  $\rho = 1000$  kg/m<sup>3</sup>

Ambient Temperature: 23.4 °C; Liquid Temperature: 22.6 °C

DASY Configuration:

- Probe: EX3DV4 - SN3970; ConvF(4.69, 4.69, 4.69); Calibrated: 10.07.2015;
- Sensor-Surface: 1.4mm (Mechanical Surface Detection)
- Electronics: DAE4 Sn1418; Calibrated: 23.06.2015
- Phantom: ELI v5.0; Type: QDOVA002AA; Serial: TP:1231
- DASY52 52.8.7(1137); SEMCAD X 14.6.10(7164)

**Configuration/Ch149/Area Scan (71x91x1):** Interpolated grid: dx=10mm, dy=10mm  
Maximum value of SAR (interpolated) = 0.667 W/kg

**Configuration/Ch149/Zoom Scan (7x7x7)/Cube 0:** Measurement grid: dx=4mm, dy=4mm, dz=1.4mm

Reference Value = 1.025 V/m; Power Drift = -0.03 dB

Peak SAR (extrapolated) = 1.64 W/kg

**SAR(1 g) = 0.306 W/kg; SAR(10 g) = 0.096 W/kg**

Maximum value of SAR (measured) = 0.810 W/kg

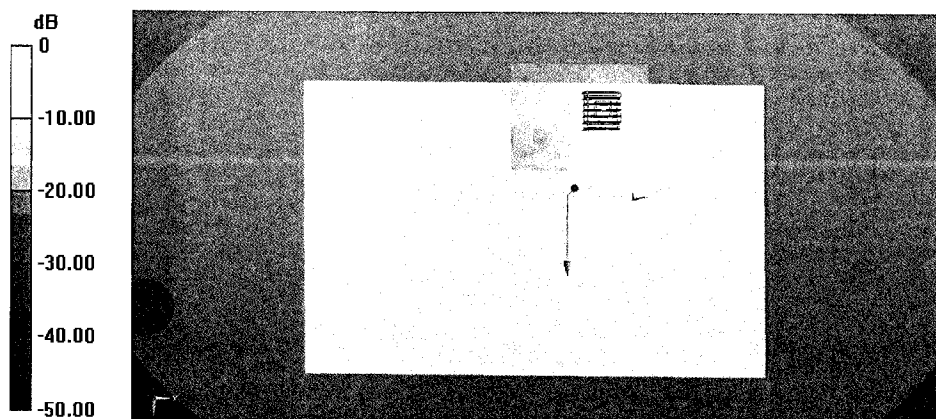

0 dB = 0.810 W/kg = -0.92 dBW/kg

Test Laboratory: Shenzhen EMTEK Co.,Ltd.

Date/Time: 10.09.2015

**09-WLAN5GHz Band 1-802.11a 6Mbps-Edge 1-0cm-Ch149**

Communication System: UID 0, WIFI (0); Frequency: 5745 MHz; Duty Cycle: 1:1.068

Medium: MSL\_5G\_150910

Medium parameters used:  $f = 5745$  MHz;  $\sigma = 6.027$  S/m;  $\epsilon_r = 48.284$ ;  $\rho = 1000$  kg/m<sup>3</sup>

Ambient Temperature: 23.4 °C; Liquid Temperature: 22.6 °C

DASY Configuration:

- Probe: EX3DV4 - SN3970; ConvF(4.69, 4.69, 4.69); Calibrated: 10.07.2015;
- Sensor-Surface: 1.4mm (Mechanical Surface Detection)
- Electronics: DAE4 Sn1418; Calibrated: 23.06.2015
- Phantom: EL1 v5.0; Type: QDOVA002AA; Serial: TP:1231
- DASY52 52.8.7(1137); SEMCAD X 14.6.10(7164)

**Configuration/Ch149/Area Scan (41x121x1):** Interpolated grid: dx=10mm, dy=10mm  
Maximum value of SAR (interpolated) = 0.394 W/kg

**Configuration/Ch149/Zoom Scan (7x7x7)/Cube 0:** Measurement grid: dx=4mm, dy=4mm, dz=1.4mm

Reference Value = 1.151 V/m; Power Drift = -0.07 dB

Peak SAR (extrapolated) = 1.03 W/kg

**SAR(1 g) = 0.203 W/kg; SAR(10 g) = 0.060 W/kg**

Maximum value of SAR (measured) = 0.520 W/kg

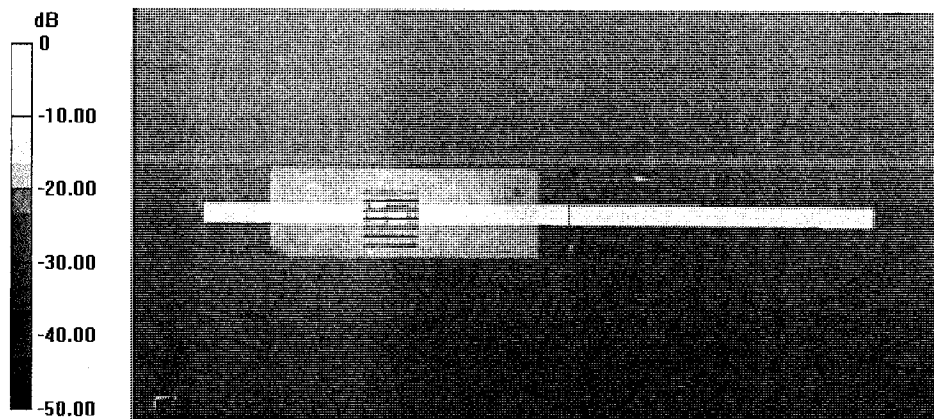

0 dB = 0.520 W/kg = -2.84 dBW/kg

Test Laboratory: Shenzhen EMTEK Co.,Ltd.

Date/Time: 10.09.2015

**10-WLAN5GHz Band 4-802.11a 6Mbps-Bottom Face-0cm-Ch165**

Communication System: UID 0, WIFI (0); Frequency: 5825 MHz;Duty Cycle: 1:1.068

Medium: MSL\_5G\_150910

Medium parameters used:  $f = 5825$  MHz;  $\sigma = 6.203$  S/m;  $\epsilon_r = 48.002$ ;  $\rho = 1000$  kg/m<sup>3</sup>

Ambient Temperature: 23.4 °C; Liquid Temperature: 22.6 °C

DASY Configuration:

- Probe: EX3DV4 - SN3970; ConvF(4.69, 4.69, 4.69); Calibrated: 10.07.2015;
- Sensor-Surface: 1.4mm (Mechanical Surface Detection)
- Electronics: DAE4 Sn1418; Calibrated: 23.06.2015
- Phantom: ELI v5.0; Type: QDOVA002AA; Serial: TP:1231
- DASY52 52.8.7(1137); SEMCAD X 14.6.10(7164)

**Configuration/Ch165/Area Scan (71x91x1):** Interpolated grid: dx=10mm, dy=10mm  
Maximum value of SAR (interpolated) = 0.652 W/kg

**Configuration/Ch165/Zoom Scan (7x7x7)/Cube 0:** Measurement grid: dx=4mm, dy=4mm, dz=1.4mm

Reference Value = 1.146 V/m; Power Drift = -0.06 dB

Peak SAR (extrapolated) = 1.70 W/kg

**SAR(1 g) = 0.297 W/kg; SAR(10 g) = 0.087 W/kg**

Maximum value of SAR (measured) = 0.846 W/kg

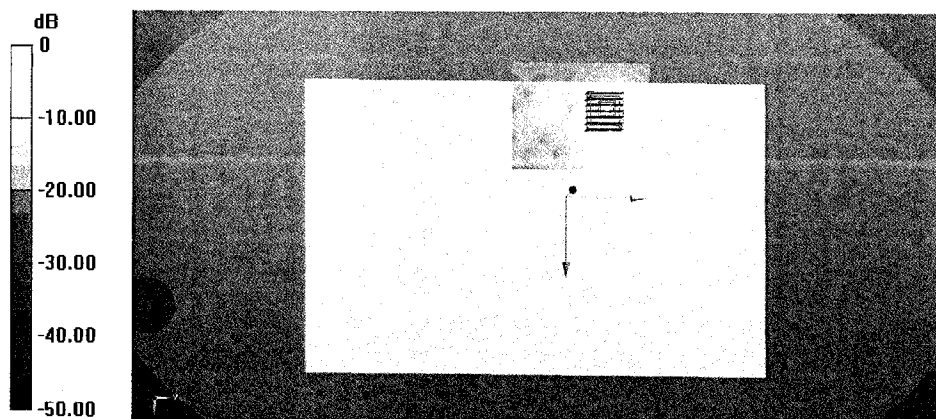

0 dB = 0.846 W/kg = -0.73 dBW/kg

**Calibration Laboratory of  
 Schmid & Partner  
 Engineering AG**  
 Zeughausstrasse 43, 8004 Zurich, Switzerland



**S** Schweizerischer Kalibrierdienst  
**S** Service suisse d'étalonnage  
**S** Servizio svizzero di taratura  
**S** Swiss Calibration Service

Accredited by the Swiss Accreditation Service (SAS)  
 The Swiss Accreditation Service is one of the signatories to the EA  
 Multilateral Agreement for the recognition of calibration certificates

Accreditation No.: **SCS 108**

Client **MRT-CERT (Auden)**

Certificate No: **D5GHzV2-1169\_Jan14**

**CALIBRATION CERTIFICATE**

Object **D5GHzV2 - SN: 1169**

Calibration procedure(s) **QA CAL-22.v2  
 Calibration procedure for dipole validation kits between 3-6 GHz**



Calibration date: **January 07, 2014**

This calibration certificate documents the traceability to national standards, which realize the physical units of measurements (SI).  
 The measurements and the uncertainties with confidence probability are given on the following pages and are part of the certificate.

All calibrations have been conducted in the closed laboratory facility: environment temperature (22 ± 3)°C and humidity < 70%.

Calibration Equipment used (M&TE critical for calibration)

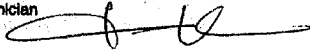
Primary Standards	ID #	Cal Date (Certificate No.)	Scheduled Calibration
Power meter EPM-442A	GB37480704	09-Oct-13 (No. 217-01827)	Oct-14
Power sensor HP 8481A	US37292783	09-Oct-13 (No. 217-01827)	Oct-14
Power sensor HP 8481A	MY41082317	09-Oct-13 (No. 217-01828)	Oct-14
Reference 20 dB Attenuator	SN: 5058 (20k)	04-Apr-13 (No. 217-01736)	Apr-14
Type-N mismatch combination	SN: 5047.3 / 06327	04-Apr-13 (No. 217-01739)	Apr-14
Reference Probe EX3DV4	SN: 3503	30-Dec-13 (No. EX3-3503_Dec13)	Dec-14
DAE4	SN: 601	25-Apr-13 (No. DAE4-601_Apr13)	Apr-14
Secondary Standards	ID #	Check Date (in house)	Scheduled Check
RF generator R&S SMT-06	100005	04-Aug-99 (in house check Oct-13)	in house check: Oct-16
Network Analyzer HP 8753E	US37390585 S4206	18-Oct-01 (in house check Oct-13)	in house check: Oct-14

Calibrated by:	Name <b>Jeton Kastrati</b>	Function <b>Laboratory Technician</b>	Signature 
Approved by:	Name <b>Katja Pokovic</b>	Technical Manager	

Issued: January 8, 2014

This calibration certificate shall not be reproduced except in full without written approval of the laboratory.

**Calibration Laboratory of**  
Schmid & Partner  
Engineering AG  
Zeughausstrasse 43, 8004 Zurich, Switzerland



**S** Schweizerischer Kalibrierdienst  
**C** Service suisse d'étalonnage  
**S** Servizio svizzero di taratura  
**S** Swiss Calibration Service

Accreditation No.: **SCS 108**

Accredited by the Swiss Accreditation Service (SAS)  
The Swiss Accreditation Service is one of the signatories to the EA  
Multilateral Agreement for the recognition of calibration certificates

**Glossary:**

TSL	tissue simulating liquid
ConvF	sensitivity in TSL / NORM x,y,z
N/A	not applicable or not measured

**Calibration is Performed According to the Following Standards:**

- IEC 62209-2, "Evaluation of Human Exposure to Radio Frequency Fields from Handheld and Body-Mounted Wireless Communication Devices in the Frequency Range of 30 MHz to 6 GHz: Human models, Instrumentation, and Procedures"; Part 2: "Procedure to determine the Specific Absorption Rate (SAR) for including accessories and multiple transmitters", March 2010
- KDB 865664, "SAR Measurement Requirements for 100 MHz to 6 GHz"
- IEEE Std 1528-2013, "IEEE Recommended Practice for Determining the Peak Spatial-Averaged Specific Absorption Rate (SAR) in the Human Head from Wireless Communications Devices: Measurement Techniques", June 2013

**Additional Documentation:**

- DASY4/5 System Handbook

**Methods Applied and Interpretation of Parameters:**

- Measurement Conditions:** Further details are available from the Validation Report at the end of the certificate. All figures stated in the certificate are valid at the frequency indicated.
- Antenna Parameters with TSL:** The dipole is mounted with the spacer to position its feed point exactly below the center marking of the flat phantom section, with the arms oriented parallel to the body axis.
- Feed Point Impedance and Return Loss:** These parameters are measured with the dipole positioned under the liquid filled phantom. The impedance stated is transformed from the measurement at the SMA connector to the feed point. The Return Loss ensures low reflected power. No uncertainty required.
- Electrical Delay:** One-way delay between the SMA connector and the antenna feed point. No uncertainty required.
- SAR measured:** SAR measured at the stated antenna input power.
- SAR normalized:** SAR as measured, normalized to an input power of 1 W at the antenna connector.
- SAR for nominal TSL parameters:** The measured TSL parameters are used to calculate the nominal SAR result.

The reported uncertainty of measurement is stated as the standard uncertainty of measurement multiplied by the coverage factor  $k=2$ , which for a normal distribution corresponds to a coverage probability of approximately 95%.

**Measurement Conditions**

DASY system configuration, as far as not given on page 1.

<b>DASY Version</b>	DASY5	V52.8.7
<b>Extrapolation</b>	Advanced Extrapolation	
<b>Phantom</b>	Modular Flat Phantom V5.0	
<b>Distance Dipole Center - TSL</b>	10 mm	with Spacer
<b>Zoom Scan Resolution</b>	dx, dy = 4.0 mm, dz = 1.4 mm	Graded Ratio = 1.4 (Z direction)
<b>Frequency</b>	5200 MHz ± 1 MHz 5300 MHz ± 1 MHz 5500 MHz ± 1 MHz 5600 MHz ± 1 MHz 5800 MHz ± 1 MHz	

**Head TSL parameters at 5200 MHz**

The following parameters and calculations were applied.

	Temperature	Permittivity	Conductivity
<b>Nominal Head TSL parameters</b>	22.0 °C	36.0	4.66 mho/m
<b>Measured Head TSL parameters</b>	(22.0 ± 0.2) °C	35.5 ± 6 %	4.43 mho/m ± 6 %
<b>Head TSL temperature change during test</b>	< 0.5 °C	----	----

**SAR result with Head TSL at 5200 MHz**

<b>SAR averaged over 1 cm<sup>3</sup> (1 g) of Head TSL</b>	Condition	
SAR measured	100 mW input power	8.00 W/kg
SAR for nominal Head TSL parameters	normalized to 1W	<b>79.7 W/kg ± 19.9 % (k=2)</b>

<b>SAR averaged over 10 cm<sup>3</sup> (10 g) of Head TSL</b>	condition	
SAR measured	100 mW input power	2.30 W/kg
SAR for nominal Head TSL parameters	normalized to 1W	<b>22.9 W/kg ± 19.5 % (k=2)</b>

**Head TSL parameters at 5300 MHz**

The following parameters and calculations were applied.

	Temperature	Permittivity	Conductivity
Nominal Head TSL parameters	22.0 °C	35.9	4.76 mho/m
Measured Head TSL parameters	(22.0 ± 0.2) °C	35.3 ± 6 %	4.54 mho/m ± 6 %
Head TSL temperature change during test	< 0.5 °C	----	----

**SAR result with Head TSL at 5300 MHz**

SAR averaged over 1 cm <sup>3</sup> (1 g) of Head TSL	Condition	
SAR measured	100 mW input power	8.34 W/kg
SAR for nominal Head TSL parameters	normalized to 1W	<b>83.0 W / kg ± 19.9 % (k=2)</b>

SAR averaged over 10 cm <sup>3</sup> (10 g) of Head TSL	condition	
SAR measured	100 mW input power	2.40 W/kg
SAR for nominal Head TSL parameters	normalized to 1W	<b>23.8 W/kg ± 19.5 % (k=2)</b>

**Head TSL parameters at 5500 MHz**

The following parameters and calculations were applied.

	Temperature	Permittivity	Conductivity
Nominal Head TSL parameters	22.0 °C	35.6	4.96 mho/m
Measured Head TSL parameters	(22.0 ± 0.2) °C	35.1 ± 6 %	4.75 mho/m ± 6 %
Head TSL temperature change during test	< 0.5 °C	----	----

**SAR result with Head TSL at 5500 MHz**

SAR averaged over 1 cm <sup>3</sup> (1 g) of Head TSL	Condition	
SAR measured	100 mW input power	8.50 W/kg
SAR for nominal Head TSL parameters	normalized to 1W	<b>84.6 W/kg ± 19.9 % (k=2)</b>

SAR averaged over 10 cm <sup>3</sup> (10 g) of Head TSL	condition	
SAR measured	100 mW input power	2.43 W/kg
SAR for nominal Head TSL parameters	normalized to 1W	<b>24.2 W/kg ± 19.5 % (k=2)</b>



### Head TSL parameters at 5600 MHz

The following parameters and calculations were applied.

	Temperature	Permittivity	Conductivity
Nominal Head TSL parameters	22.0 °C	35.5	5.07 mho/m
Measured Head TSL parameters	(22.0 ± 0.2) °C	35.0 ± 6 %	4.84 mho/m ± 6 %
Head TSL temperature change during test	< 0.5 °C	----	----

### SAR result with Head TSL at 5600 MHz

SAR averaged over 1 cm <sup>3</sup> (1 g) of Head TSL	Condition	
SAR measured	100 mW input power	8.54 W/kg
SAR for nominal Head TSL parameters	normalized to 1W	<b>85.0 W/kg ± 19.9 % (k=2)</b>

SAR averaged over 10 cm <sup>3</sup> (10 g) of Head TSL	condition	
SAR measured	100 mW input power	2.43 W/kg
SAR for nominal Head TSL parameters	normalized to 1W	<b>24.2 W/kg ± 19.5 % (k=2)</b>

### Head TSL parameters at 5800 MHz

The following parameters and calculations were applied.

	Temperature	Permittivity	Conductivity
Nominal Head TSL parameters	22.0 °C	35.3	5.27 mho/m
Measured Head TSL parameters	(22.0 ± 0.2) °C	34.7 ± 6 %	5.05 mho/m ± 6 %
Head TSL temperature change during test	< 0.5 °C	----	----

### SAR result with Head TSL at 5800 MHz

SAR averaged over 1 cm <sup>3</sup> (1 g) of Head TSL	Condition	
SAR measured	100 mW input power	8.13 W/kg
SAR for nominal Head TSL parameters	normalized to 1W	<b>80.9 W/kg ± 19.9 % (k=2)</b>

SAR averaged over 10 cm <sup>3</sup> (10 g) of Head TSL	condition	
SAR measured	100 mW input power	2.32 W/kg
SAR for nominal Head TSL parameters	normalized to 1W	<b>23.1 W/kg ± 19.5 % (k=2)</b>

**Body TSL parameters at 5200 MHz**

The following parameters and calculations were applied.

	Temperature	Permittivity	Conductivity
Nominal Body TSL parameters	22.0 °C	49.0	5.30 mho/m
Measured Body TSL parameters	(22.0 ± 0.2) °C	47.2 ± 6 %	5.38 mho/m ± 6 %
Body TSL temperature change during test	< 0.5 °C	----	----

**SAR result with Body TSL at 5200 MHz**

SAR averaged over 1 cm <sup>3</sup> (1 g) of Body TSL	Condition	
SAR measured	100 mW input power	7.43 W/kg
SAR for nominal Body TSL parameters	normalized to 1W	<b>73.8 W/kg ± 19.9 % (k=2)</b>

SAR averaged over 10 cm <sup>3</sup> (10 g) of Body TSL	condition	
SAR measured	100 mW input power	2.08 W/kg
SAR for nominal Body TSL parameters	normalized to 1W	<b>20.6 W/kg ± 19.5 % (k=2)</b>

**Body TSL parameters at 5300 MHz**

The following parameters and calculations were applied.

	Temperature	Permittivity	Conductivity
Nominal Body TSL parameters	22.0 °C	48.9	5.42 mho/m
Measured Body TSL parameters	(22.0 ± 0.2) °C	47.0 ± 6 %	5.52 mho/m ± 6 %
Body TSL temperature change during test	< 0.5 °C	----	----

**SAR result with Body TSL at 5300 MHz**

SAR averaged over 1 cm <sup>3</sup> (1 g) of Body TSL	Condition	
SAR measured	100 mW input power	7.58 W/kg
SAR for nominal Body TSL parameters	normalized to 1W	<b>75.2 W/kg ± 19.9 % (k=2)</b>

SAR averaged over 10 cm <sup>3</sup> (10 g) of Body TSL	condition	
SAR measured	100 mW input power	2.12 W/kg
SAR for nominal Body TSL parameters	normalized to 1W	<b>21.0 W/kg ± 19.5 % (k=2)</b>

**Body TSL parameters at 5500 MHz**

The following parameters and calculations were applied.

	Temperature	Permittivity	Conductivity
<b>Nominal Body TSL parameters</b>	22.0 °C	48.6	5.65 mho/m
<b>Measured Body TSL parameters</b>	(22.0 ± 0.2) °C	46.7 ± 6 %	5.80 mho/m ± 6 %
<b>Body TSL temperature change during test</b>	< 0.5 °C	----	----

**SAR result with Body TSL at 5500 MHz**

SAR averaged over 1 cm <sup>3</sup> (1 g) of Body TSL	Condition	
SAR measured	100 mW input power	7.98 W/kg
SAR for nominal Body TSL parameters	normalized to 1W	<b>79.2 W/kg ± 19.9 % (k=2)</b>

SAR averaged over 10 cm <sup>3</sup> (10 g) of Body TSL	condition	
SAR measured	100 mW input power	2.22 W/kg
SAR for nominal Body TSL parameters	normalized to 1W	<b>22.0 W/kg ± 19.5 % (k=2)</b>

**Body TSL parameters at 5600 MHz**

The following parameters and calculations were applied.

	Temperature	Permittivity	Conductivity
<b>Nominal Body TSL parameters</b>	22.0 °C	48.5	5.77 mho/m
<b>Measured Body TSL parameters</b>	(22.0 ± 0.2) °C	46.6 ± 6 %	5.92 mho/m ± 6 %
<b>Body TSL temperature change during test</b>	< 0.5 °C	----	----

**SAR result with Body TSL at 5600 MHz**

SAR averaged over 1 cm <sup>3</sup> (1 g) of Body TSL	Condition	
SAR measured	100 mW input power	8.03 W/kg
SAR for nominal Body TSL parameters	normalized to 1W	<b>79.7 W/kg ± 19.9 % (k=2)</b>

SAR averaged over 10 cm <sup>3</sup> (10 g) of Body TSL	condition	
SAR measured	100 mW input power	2.23 W/kg
SAR for nominal Body TSL parameters	normalized to 1W	<b>22.1 W/kg ± 19.5 % (k=2)</b>

**Body TSL parameters at 5800 MHz**

The following parameters and calculations were applied.

	Temperature	Permittivity	Conductivity
Nominal Body TSL parameters	22.0 °C	48.2	6.00 mho/m
Measured Body TSL parameters	(22.0 ± 0.2) °C	46.2 ± 6 %	6.20 mho/m ± 6 %
Body TSL temperature change during test	< 0.5 °C	----	----

**SAR result with Body TSL at 5800 MHz**

SAR averaged over 1 cm <sup>3</sup> (1 g) of Body TSL	Condition	
SAR measured	100 mW input power	7.48 W/kg
SAR for nominal Body TSL parameters	normalized to 1W	<b>74.3 W/kg ± 19.9 % (k=2)</b>

SAR averaged over 10 cm <sup>3</sup> (10 g) of Body TSL	condition	
SAR measured	100 mW input power	2.07 W/kg
SAR for nominal Body TSL parameters	normalized to 1W	<b>20.5 W/kg ± 19.5 % (k=2)</b>

**Appendix**

**Antenna Parameters with Head TSL at 5200 MHz**

Impedance, transformed to feed point	49.7 $\Omega$ - 8.2 j $\Omega$
Return Loss	- 21.7 dB

**Antenna Parameters with Head TSL at 5300 MHz**

Impedance, transformed to feed point	49.5 $\Omega$ - 5.8 j $\Omega$
Return Loss	- 24.7 dB

**Antenna Parameters with Head TSL at 5500 MHz**

Impedance, transformed to feed point	52.7 $\Omega$ - 3.3 j $\Omega$
Return Loss	- 27.6 dB

**Antenna Parameters with Head TSL at 5600 MHz**

Impedance, transformed to feed point	54.7 $\Omega$ - 2.7 j $\Omega$
Return Loss	- 25.8 dB

**Antenna Parameters with Head TSL at 5800 MHz**

Impedance, transformed to feed point	55.7 $\Omega$ - 4.4 j $\Omega$
Return Loss	- 23.4 dB

**Antenna Parameters with Body TSL at 5200 MHz**

Impedance, transformed to feed point	49.6 $\Omega$ - 7.5 j $\Omega$
Return Loss	- 22.5 dB

**Antenna Parameters with Body TSL at 5300 MHz**

Impedance, transformed to feed point	49.7 $\Omega$ - 4.7 j $\Omega$
Return Loss	- 26.5 dB

**Antenna Parameters with Body TSL at 5500 MHz**

Impedance, transformed to feed point	53.2 $\Omega$ - 2.2 j $\Omega$
Return Loss	- 28.5 dB

**Antenna Parameters with Body TSL at 5600 MHz**

Impedance, transformed to feed point	55.2 $\Omega$ - 1.6 j $\Omega$
Return Loss	- 25.8 dB

**Antenna Parameters with Body TSL at 5800 MHz**

Impedance, transformed to feed point	55.9 $\Omega$ - 2.9 j $\Omega$
Return Loss	- 24.1 dB

**General Antenna Parameters and Design**

Electrical Delay (one direction)	1.207 ns
----------------------------------	----------

After long term use with 100W radiated power, only a slight warming of the dipole near the feedpoint can be measured.

The dipole is made of standard semirigid coaxial cable. The center conductor of the feeding line is directly connected to the second arm of the dipole. The antenna is therefore short-circuited for DC-signals. On some of the dipoles, small end caps are added to the dipole arms in order to improve matching when loaded according to the position as explained in the "Measurement Conditions" paragraph. The SAR data are not affected by this change. The overall dipole length is still according to the Standard.

No excessive force must be applied to the dipole arms, because they might bend or the soldered connections near the feedpoint may be damaged.

**Additional EUT Data**

Manufactured by	SPEAG
Manufactured on	December 09, 2013

## DASY5 Validation Report for Head TSL

Date: 07.01.2014

Test Laboratory: SPEAG, Zurich, Switzerland

**DUT: Dipole 5GHz; Type: D5GHzV2; Serial: D5GHzV2 - SN: 1169**

Communication System: UID 0 - CW; Frequency: 5200 MHz, Frequency: 5300 MHz, Frequency: 5500 MHz, Frequency: 5600 MHz, Frequency: 5800 MHz

Medium parameters used:  $f = 5200$  MHz;  $\sigma = 4.43$  S/m;  $\epsilon_r = 35.5$ ;  $\rho = 1000$  kg/m<sup>3</sup>, Medium parameters used:  $f = 5300$  MHz;  $\sigma = 4.54$  S/m;  $\epsilon_r = 35.3$ ;  $\rho = 1000$  kg/m<sup>3</sup>, Medium parameters used:  $f = 5500$  MHz;  $\sigma = 4.75$  S/m;  $\epsilon_r = 35.1$ ;  $\rho = 1000$  kg/m<sup>3</sup>, Medium parameters used:  $f = 5600$  MHz;  $\sigma = 4.84$  S/m;  $\epsilon_r = 35$ ;  $\rho = 1000$  kg/m<sup>3</sup>, Medium parameters used:  $f = 5800$  MHz;  $\sigma = 5.05$  S/m;  $\epsilon_r = 34.7$ ;  $\rho = 1000$  kg/m<sup>3</sup>

Phantom section: Flat Section

Measurement Standard: DASY5 (IEEE/IEC/ANSI C63.19-2007)

DASY52 Configuration:

- Probe: EX3DV4 - SN3503; ConvF(5.52, 5.52, 5.52); Calibrated: 30.12.2013, ConvF(5.2, 5.2, 5.2); Calibrated: 30.12.2013, ConvF(5.01, 5.01, 5.01); Calibrated: 30.12.2013, ConvF(4.86, 4.86, 4.86); Calibrated: 30.12.2013, ConvF(4.91, 4.91, 4.91); Calibrated: 30.12.2013;
- Sensor-Surface: 1.4mm (Mechanical Surface Detection)
- Electronics: DAE4 Sn601; Calibrated: 25.04.2013
- Phantom: Flat Phantom 5.0 (front); Type: QD000P50AA; Serial: 1001
- DASY52 52.8.7(1137); SEMCAD X 14.6.10(7164)

### Dipole Calibration for Head Tissue/Pin=100mW, dist=10mm, f=5200 MHz/Zoom Scan, dist=1.4mm (8x8x7)/Cube 0: Measurement grid: dx=4mm, dy=4mm, dz=1.4mm

Reference Value = 63.584 V/m; Power Drift = 0.05 dB

Peak SAR (extrapolated) = 28.9 W/kg

**SAR(1 g) = 8 W/kg; SAR(10 g) = 2.3 W/kg**

Maximum value of SAR (measured) = 18.6 W/kg

### Dipole Calibration for Head Tissue/Pin=100mW, dist=10mm, f=5300 MHz/Zoom Scan, dist=1.4mm (8x8x7)/Cube 0: Measurement grid: dx=4mm, dy=4mm, dz=1.4mm

Reference Value = 64.034 V/m; Power Drift = 0.06 dB

Peak SAR (extrapolated) = 31.5 W/kg

**SAR(1 g) = 8.34 W/kg; SAR(10 g) = 2.4 W/kg**

Maximum value of SAR (measured) = 19.5 W/kg

### Dipole Calibration for Head Tissue/Pin=100mW, dist=10mm, f=5500 MHz/Zoom Scan, dist=1.4mm (8x8x7)/Cube 0: Measurement grid: dx=4mm, dy=4mm, dz=1.4mm

Reference Value = 63.164 V/m; Power Drift = 0.04 dB

Peak SAR (extrapolated) = 33.6 W/kg

**SAR(1 g) = 8.5 W/kg; SAR(10 g) = 2.43 W/kg**

Maximum value of SAR (measured) = 20.5 W/kg

**Dipole Calibration for Head Tissue/Pin=100mW, dist=10mm, f=5600 MHz/Zoom Scan, dist=1.4mm (8x8x7)/Cube 0:** Measurement grid: dx=4mm, dy=4mm, dz=1.4mm  
Reference Value = 63.543 V/m; Power Drift = 0.04 dB  
Peak SAR (extrapolated) = 33.9 W/kg  
SAR(1 g) = 8.54 W/kg; SAR(10 g) = 2.43 W/kg  
Maximum value of SAR (measured) = 20.6 W/kg

**Dipole Calibration for Head Tissue/Pin=100mW, dist=10mm, f=5800 MHz/Zoom Scan, dist=1.4mm (8x8x7)/Cube 0:** Measurement grid: dx=4mm, dy=4mm, dz=1.4mm  
Reference Value = 60.517 V/m; Power Drift = 0.07 dB  
Peak SAR (extrapolated) = 33.6 W/kg  
SAR(1 g) = 8.13 W/kg; SAR(10 g) = 2.32 W/kg  
Maximum value of SAR (measured) = 19.9 W/kg

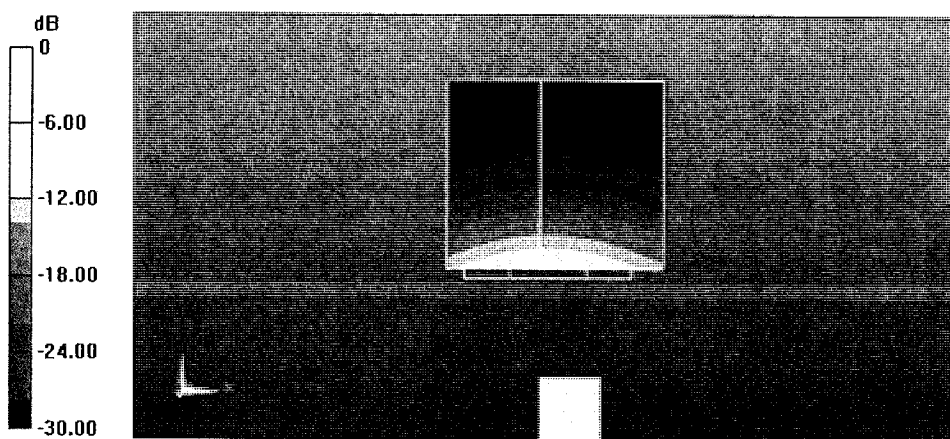

0 dB = 19.9 W/kg = 12.99 dBW/kg



Impedance Measurement Plot for Head TSL

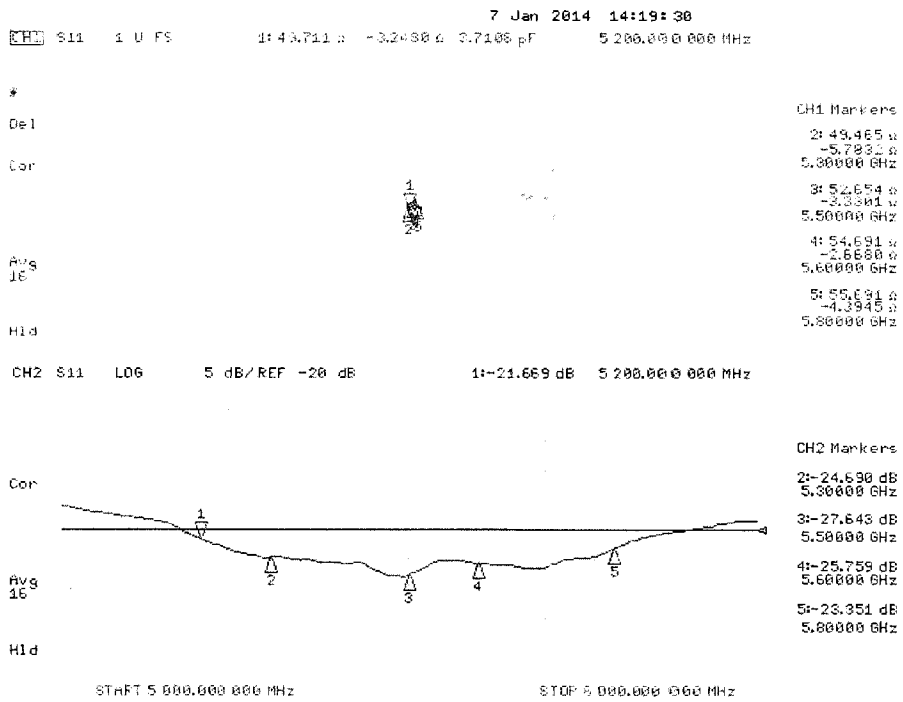

## DASY5 Validation Report for Body TSL

Date: 07.01.2014

Test Laboratory: SPEAG, Zurich, Switzerland

**DUT: Dipole 5GHz; Type: D5GHzV2; Serial: D5GHzV2 - SN: 1169**

Communication System: UID 0 - CW; Frequency: 5200 MHz, Frequency: 5300 MHz, Frequency: 5600 MHz, Frequency: 5500 MHz, Frequency: 5800 MHz

Medium parameters used:  $f = 5200$  MHz;  $\sigma = 5.38$  S/m;  $\epsilon_r = 47.2$ ;  $\rho = 1000$  kg/m<sup>3</sup>, Medium parameters used:  $f = 5300$  MHz;  $\sigma = 5.52$  S/m;  $\epsilon_r = 47$ ;  $\rho = 1000$  kg/m<sup>3</sup>, Medium parameters used:  $f = 5600$  MHz;  $\sigma = 5.92$  S/m;  $\epsilon_r = 46.6$ ;  $\rho = 1000$  kg/m<sup>3</sup>, Medium parameters used:  $f = 5500$  MHz;  $\sigma = 5.8$  S/m;  $\epsilon_r = 46.7$ ;  $\rho = 1000$  kg/m<sup>3</sup>, Medium parameters used:  $f = 5800$  MHz;  $\sigma = 6.2$  S/m;  $\epsilon_r = 46.2$ ;  $\rho = 1000$  kg/m<sup>3</sup>

Phantom section: Flat Section

Measurement Standard: DASY5 (IEEE/IEC/ANSI C63.19-2007)

DASY52 Configuration:

- Probe: EX3DV4 - SN3503; ConvF(5.01, 5.01, 5.01); Calibrated: 30.12.2013, ConvF(4.76, 4.76, 4.76); Calibrated: 30.12.2013, ConvF(4.3, 4.3, 4.3); Calibrated: 30.12.2013, ConvF(4.52, 4.52, 4.52); Calibrated: 30.12.2013, ConvF(4.47, 4.47, 4.47); Calibrated: 30.12.2013;
- Sensor-Surface: 1.4mm (Mechanical Surface Detection)
- Electronics: DAE4 Sn601; Calibrated: 25.04.2013
- Phantom: Flat Phantom 5.0 (back); Type: QD000P50AA; Serial: 1002
- DASY52 52.8.7(1137); SEMCAD X 14.6.10(7164)

**Dipole Calibration for Body Tissue/Pin=100mW, dist=10mm, f=5200 MHz/Zoom Scan, dist=1.4mm (8x8x7)/Cube 0:** Measurement grid: dx=4mm, dy=4mm, dz=1.4mm  
Reference Value = 58.646 V/m; Power Drift = -0.05 dB  
Peak SAR (extrapolated) = 29.4 W/kg  
**SAR(1 g) = 7.43 W/kg; SAR(10 g) = 2.08 W/kg**  
Maximum value of SAR (measured) = 17.5 W/kg

**Dipole Calibration for Body Tissue/Pin=100mW, dist=10mm, f=5300 MHz/Zoom Scan, dist=1.4mm (8x8x7)/Cube 0:** Measurement grid: dx=4mm, dy=4mm, dz=1.4mm  
Reference Value = 58.747 V/m; Power Drift = -0.01 dB  
Peak SAR (extrapolated) = 30.6 W/kg  
**SAR(1 g) = 7.58 W/kg; SAR(10 g) = 2.12 W/kg**  
Maximum value of SAR (measured) = 17.9 W/kg

**Dipole Calibration for Body Tissue/Pin=100mW, dist=10mm, f=5600 MHz/Zoom Scan, dist=1.4mm (8x8x7)/Cube 0:** Measurement grid: dx=4mm, dy=4mm, dz=1.4mm  
Reference Value = 58.868 V/m; Power Drift = 0.01 dB  
Peak SAR (extrapolated) = 35.7 W/kg  
**SAR(1 g) = 8.03 W/kg; SAR(10 g) = 2.23 W/kg**  
Maximum value of SAR (measured) = 19.8 W/kg

**Dipole Calibration for Body Tissue/Pin=100mW, dist=10mm, f=5500 MHz/Zoom Scan, dist=1.4mm (8x8x7)/Cube 0:** Measurement grid: dx=4mm, dy=4mm, dz=1.4mm  
Reference Value = 59.036 V/m; Power Drift = -0.00 dB  
Peak SAR (extrapolated) = 34.4 W/kg  
SAR(1 g) = 7.98 W/kg; SAR(10 g) = 2.22 W/kg  
Maximum value of SAR (measured) = 19.3 W/kg

**Dipole Calibration for Body Tissue/Pin=100mW, dist=10mm, f=5800 MHz/Zoom Scan, dist=1.4mm (8x8x7)/Cube 0:** Measurement grid: dx=4mm, dy=4mm, dz=1.4mm  
Reference Value = 55.673 V/m; Power Drift = 0.01 dB  
Peak SAR (extrapolated) = 35.0 W/kg  
SAR(1 g) = 7.48 W/kg; SAR(10 g) = 2.07 W/kg  
Maximum value of SAR (measured) = 18.7 W/kg

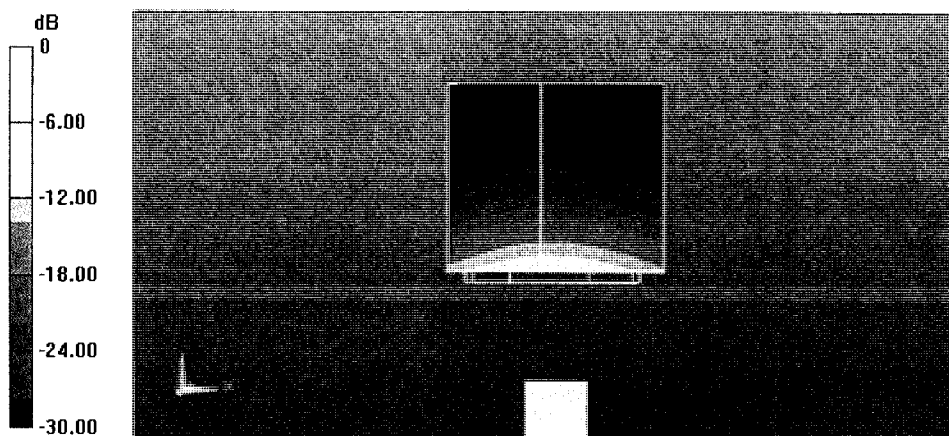

0 dB = 18.7 W/kg = 12.72 dBW/kg

Impedance Measurement Plot for Body TSL

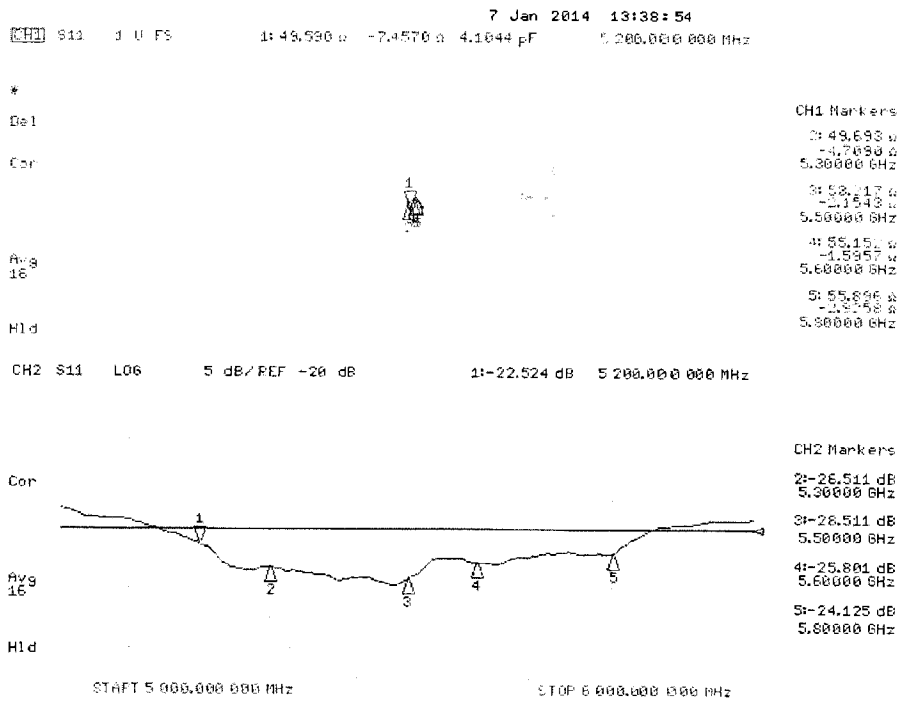

**Calibration Laboratory of  
 Schmid & Partner  
 Engineering AG**  
 Zeughausstrasse 43, 8004 Zurich, Switzerland



**S** Schweizerischer Kalibrierdienst  
**C** Service suisse d'étalonnage  
**S** Servizio svizzero di taratura  
**S** Swiss Calibration Service

Accredited by the Swiss Accreditation Service (SAS)  
 The Swiss Accreditation Service is one of the signatories to the EA  
 Multilateral Agreement for the recognition of calibration certificates

Accreditation No.: **SCS 108**

Client **MRT-CERT (Auden)**

Certificate No.: **D2450V2-927\_Jan14**

**CALIBRATION CERTIFICATE**

Object **D2450V2 - SN: 927**

Calibration procedure(s) **QA CAL-05.v9  
 Calibration procedure for dipole validation kits above 700 MHz**

Calibration date: **January 13, 2014**

This calibration certificate documents the traceability to national standards, which realize the physical units of measurements (SI).  
 The measurements and the uncertainties with confidence probability are given on the following pages and are part of the certificate.



All calibrations have been conducted in the closed laboratory facility: environment temperature (22 ± 3)°C and humidity < 70%.

Calibration Equipment used (M&TE critical for calibration)

Primary Standards	ID #	Cal Date (Certificate No.)	Scheduled Calibration
Power meter EPM-442A	GB37480704	09-Oct-13 (No. 217-01827)	Oct-14
Power sensor HP 8481A	US37282783	09-Oct-13 (No. 217-01827)	Oct-14
Power sensor HP 8481A	MY41092317	09-Oct-13 (No. 217-01826)	Oct-14
Reference 20 dB Attenuator	SN: 5058 (20k)	04-Apr-13 (No. 217-01736)	Apr-14
Type-N mismatch combination	SN: 5047.3 / 06327	04-Apr-13 (No. 217-01739)	Apr-14
Reference Probe ES3DV3	SN: 3205	30-Dec-13 (No. ES3-3205_Dec13)	Dec-14
DAE4	SN: 601	25-Apr-13 (No. DAE4-601_Apr13)	Apr-14
Secondary Standards	ID #	Check Date (in house)	Scheduled Check
RF generator R&S SMT-06	100005	04-Aug-99 (in house check Oct-13)	In house check: Oct-16
Network Analyzer HP 8753E	US37390585 S4206	18-Oct-01 (in house check Oct-13)	In house check: Oct-14

Calibrated by: **Name** **Israe El-Naouq** **Function** **Laboratory Technician**

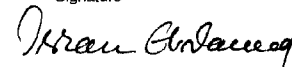
Approved by: **Katja Pokovic** **Technical Manager**

Signature  
  

Issued: January 13, 2014

This calibration certificate shall not be reproduced except in full without written approval of the laboratory.

**Calibration Laboratory of  
Schmid & Partner  
Engineering AG**  
Zeughausstrasse 43, 8004 Zurich, Switzerland



**S** Schweizerischer Kalibrierdienst  
**S** Service suisse d'étalonnage  
**C** Servizio svizzero di taratura  
**S** Swiss Calibration Service

Accredited by the Swiss Accreditation Service (SAS)  
The Swiss Accreditation Service is one of the signatories to the EA  
Multilateral Agreement for the recognition of calibration certificates

Accreditation No.: **SCS 108**

**Glossary:**

TSL	tissue simulating liquid
ConvF	sensitivity in TSL / NORM x,y,z
N/A	not applicable or not measured

**Calibration is Performed According to the Following Standards:**

- IEEE Std 1528-2013, "IEEE Recommended Practice for Determining the Peak Spatial-Averaged Specific Absorption Rate (SAR) in the Human Head from Wireless Communications Devices: Measurement Techniques", June 2013
- IEC 62209-1, "Procedure to measure the Specific Absorption Rate (SAR) for hand-held devices used in close proximity to the ear (frequency range of 300 MHz to 3 GHz)", February 2005
- KDB 865664, "SAR Measurement Requirements for 100 MHz to 6 GHz"

**Additional Documentation:**

- DASY4/5 System Handbook

**Methods Applied and Interpretation of Parameters:**

- Measurement Conditions:** Further details are available from the Validation Report at the end of the certificate. All figures stated in the certificate are valid at the frequency indicated.
- Antenna Parameters with TSL:** The dipole is mounted with the spacer to position its feed point exactly below the center marking of the flat phantom section, with the arms oriented parallel to the body axis.
- Feed Point Impedance and Return Loss:** These parameters are measured with the dipole positioned under the liquid filled phantom. The impedance stated is transformed from the measurement at the SMA connector to the feed point. The Return Loss ensures low reflected power. No uncertainty required.
- Electrical Delay:** One-way delay between the SMA connector and the antenna feed point. No uncertainty required.
- SAR measured:** SAR measured at the stated antenna input power.
- SAR normalized:** SAR as measured, normalized to an input power of 1 W at the antenna connector.
- SAR for nominal TSL parameters:** The measured TSL parameters are used to calculate the nominal SAR result.

The reported uncertainty of measurement is stated as the standard uncertainty of measurement multiplied by the coverage factor  $k=2$ , which for a normal distribution corresponds to a coverage probability of approximately 95%.

**Measurement Conditions**

DASY system configuration, as far as not given on page 1.

<b>DASY Version</b>	DASY5	V52.8.7
<b>Extrapolation</b>	Advanced Extrapolation	
<b>Phantom</b>	Modular Flat Phantom	
<b>Distance Dipole Center - TSL</b>	10 mm	with Spacer
<b>Zoom Scan Resolution</b>	dx, dy, dz = 5 mm	
<b>Frequency</b>	2450 MHz ± 1 MHz	

**Head TSL parameters**

The following parameters and calculations were applied.

	<b>Temperature</b>	<b>Permittivity</b>	<b>Conductivity</b>
<b>Nominal Head TSL parameters</b>	22.0 °C	39.2	1.80 mho/m
<b>Measured Head TSL parameters</b>	(22.0 ± 0.2) °C	39.3 ± 6 %	1.83 mho/m ± 6 %
<b>Head TSL temperature change during test</b>	< 0.5 °C	----	----

**SAR result with Head TSL**

<b>SAR averaged over 1 cm<sup>3</sup> (1 g) of Head TSL</b>	Condition	
SAR measured	250 mW input power	13.4 W/kg
SAR for nominal Head TSL parameters	normalized to 1W	<b>53.2 W/kg ± 17.0 % (k=2)</b>

<b>SAR averaged over 10 cm<sup>3</sup> (10 g) of Head TSL</b>	condition	
SAR measured	250 mW input power	6.22 W/kg
SAR for nominal Head TSL parameters	normalized to 1W	<b>24.8 W/kg ± 16.5 % (k=2)</b>

**Body TSL parameters**

The following parameters and calculations were applied.

	<b>Temperature</b>	<b>Permittivity</b>	<b>Conductivity</b>
<b>Nominal Body TSL parameters</b>	22.0 °C	52.7	1.95 mho/m
<b>Measured Body TSL parameters</b>	(22.0 ± 0.2) °C	51.8 ± 6 %	2.00 mho/m ± 6 %
<b>Body TSL temperature change during test</b>	< 0.5 °C	---	---

**SAR result with Body TSL**

<b>SAR averaged over 1 cm<sup>3</sup> (1 g) of Body TSL</b>	Condition	
SAR measured	250 mW input power	12.8 W/kg
SAR for nominal Body TSL parameters	normalized to 1W	<b>50.4 W/kg ± 17.0 % (k=2)</b>

<b>SAR averaged over 10 cm<sup>3</sup> (10 g) of Body TSL</b>	condition	
SAR measured	250 mW input power	5.89 W/kg
SAR for nominal Body TSL parameters	normalized to 1W	<b>23.3 W/kg ± 16.5 % (k=2)</b>

## Appendix

### Antenna Parameters with Head TSL

Impedance, transformed to feed point	55.2 $\Omega$ + 2.9 j $\Omega$
Return Loss	- 24.9 dB

### Antenna Parameters with Body TSL

Impedance, transformed to feed point	51.4 $\Omega$ + 4.7 j $\Omega$
Return Loss	- 26.3 dB

### General Antenna Parameters and Design

Electrical Delay (one direction)	1.158 ns
----------------------------------	----------

After long term use with 100W radiated power, only a slight warming of the dipole near the feedpoint can be measured.

The dipole is made of standard semirigid coaxial cable. The center conductor of the feeding line is directly connected to the second arm of the dipole. The antenna is therefore short-circuited for DC-signals. On some of the dipoles, small end caps are added to the dipole arms in order to improve matching when loaded according to the position as explained in the "Measurement Conditions" paragraph. The SAR data are not affected by this change. The overall dipole length is still according to the Standard.

No excessive force must be applied to the dipole arms, because they might bend or the soldered connections near the feedpoint may be damaged.

### Additional EUT Data

Manufactured by	SPEAG
Manufactured on	September 26, 2013



### DASY5 Validation Report for Head TSL

Date: 13.01.2014

Test Laboratory: SPEAG, Zurich, Switzerland

**DUT: Dipole 2450 MHz; Type: D2450V2; Serial: D2450V2 - SN: 927**

Communication System: UID 0 - CW; Frequency: 2450 MHz

Medium parameters used:  $f = 2450$  MHz;  $\sigma = 1.83$  S/m;  $\epsilon_r = 39.3$ ;  $\rho = 1000$  kg/m<sup>3</sup>

Phantom section: Flat Section

Measurement Standard: DASY5 (IEEE/IEC/ANSI C63.19-2007)

DASY52 Configuration:

- Probe: ES3DV3 - SN3205; ConvF(4.53, 4.53, 4.53); Calibrated: 30.12.2013;
- Sensor-Surface: 3mm (Mechanical Surface Detection)
- Electronics: DAE4 Sn601; Calibrated: 25.04.2013
- Phantom: Flat Phantom 5.0 (front); Type: QD000P50AA; Serial: 1001
- DASY52 52.8.7(1137); SEMCAD X 14.6.10(7164)

### Dipole Calibration for Head Tissue/Pin=250 mW, d=10mm/Zoom Scan (7x7x7)/Cube 0:

Measurement grid: dx=5mm, dy=5mm, dz=5mm

Reference Value = 100.3 V/m; Power Drift = 0.06 dB

Peak SAR (extrapolated) = 27.9 W/kg

**SAR(1 g) = 13.4 W/kg; SAR(10 g) = 6.22 W/kg**

Maximum value of SAR (measured) = 17.1 W/kg

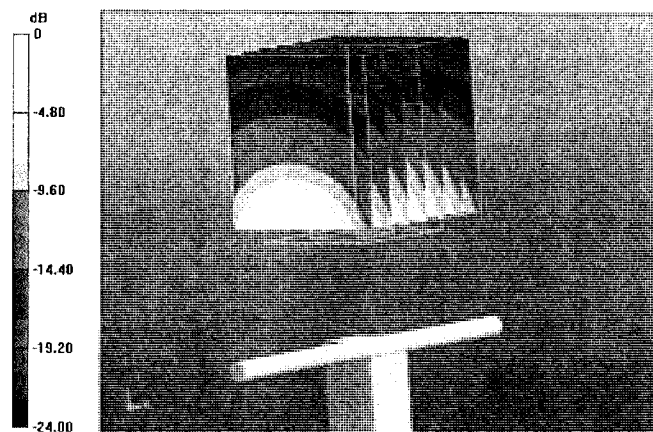

0 dB = 17.1 W/kg = 12.33 dBW/kg

### Impedance Measurement Plot for Head TSL

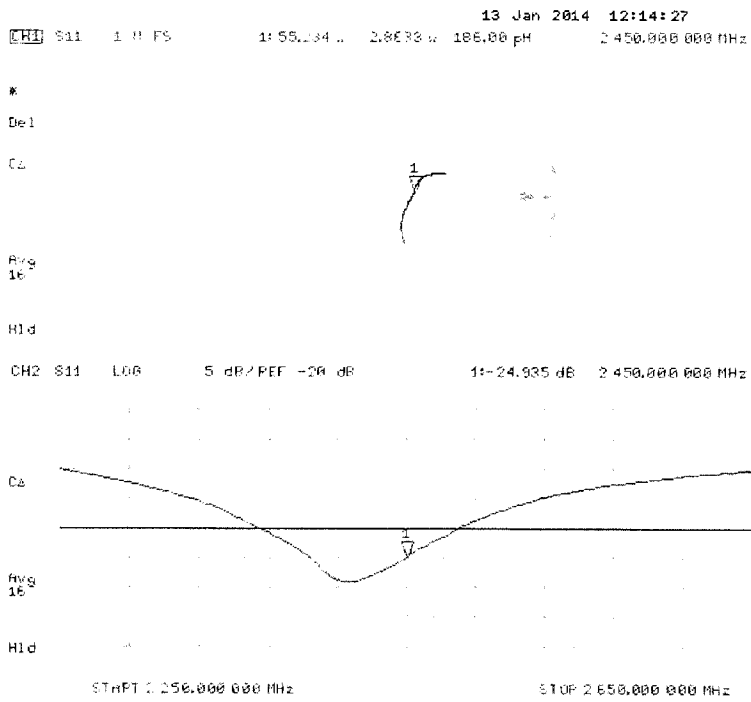

### DASY5 Validation Report for Body TSL

Date: 13.01.2014

Test Laboratory: SPEAG, Zurich, Switzerland

**DUT: Dipole 2450 MHz; Type: D2450V2; Serial: D2450V2 - SN: 927**

Communication System: UID 0 - CW; Frequency: 2450 MHz

Medium parameters used:  $f = 2450$  MHz;  $\sigma = 2$  S/m;  $\epsilon_r = 51.8$ ;  $\rho = 1000$  kg/m<sup>3</sup>

Phantom section: Flat Section

Measurement Standard: DASY5 (IEEE/IEC/ANSI C63.19-2007)

DASY52 Configuration:

- Probe: ES3DV3 - SN3205; ConvF(4.35, 4.35, 4.35); Calibrated: 30.12.2013;
- Sensor-Surface: 3mm (Mechanical Surface Detection)
- Electronics: DAE4 Sn601; Calibrated: 25.04.2013
- Phantom: Flat Phantom 5.0 (back); Type: QD000P50AA; Serial: 1002
- DASY52 52.8.7(1137); SEMCAD X 14.6.10(7164)

### Dipole Calibration for Body Tissue/Pin=250 mW, d=10mm/Zoom Scan (7x7x7)/Cube 0:

Measurement grid: dx=5mm, dy=5mm, dz=5mm

Reference Value = 94.560 V/m; Power Drift = -0.02 dB

Peak SAR (extrapolated) = 26.7 W/kg

**SAR(1 g) = 12.8 W/kg; SAR(10 g) = 5.89 W/kg**

Maximum value of SAR (measured) = 16.8 W/kg

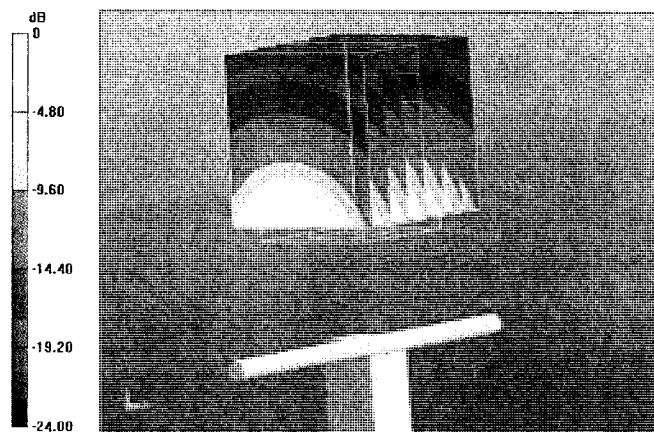

0 dB = 16.8 W/kg = 12.25 dBW/kg

### Impedance Measurement Plot for Body TSL

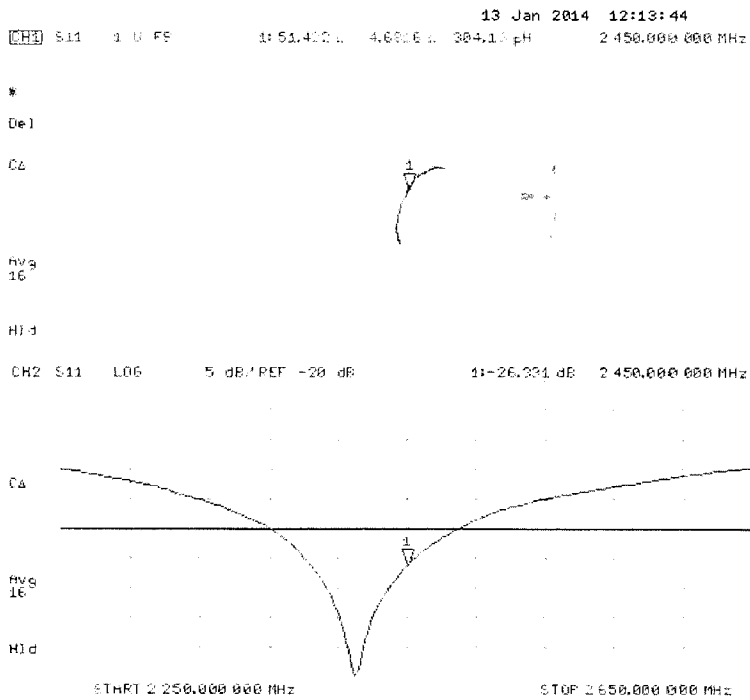



In Collaboration with  
**s p e a g**  
**CALIBRATION LABORATORY**

Add: No.51 Xueyuan Road, Haidian District, Beijing, 100191, China  
 Tel: +86-10-62304633-2218 Fax: +86-10-62304633-2209  
 E-mail: [ctl@chinatl.com](mailto:ctl@chinatl.com) [Http://www.chinatl.cn](http://www.chinatl.cn)



Client : **Emttek(Shenzhen)**

Certificate No: **Z15-97078**

**CALIBRATION CERTIFICATE**

Object **DAE4 - SN: 1418**

Calibration Procedure(s) **FD-Z11-2-002-01**  
**Calibration Procedure for the Data Acquisition Electronics (DAEx)**

Calibration date: **June 23, 2015**

This calibration Certificate documents the traceability to national standards, which realize the physical units of measurements(SI). The measurements and the uncertainties with confidence probability are given on the following pages and are part of the certificate.

All calibrations have been conducted in the closed laboratory facility: environment temperature(22±3)°C and humidity<70%.

Calibration Equipment used (M&TE critical for calibration)

Primary Standards	ID #	Cal Date(Calibrated by, Certificate No.)	Scheduled Calibration
Process Calibrator 753	1971018	01-July-14 (CTTL, No:J14X02147)	July-15

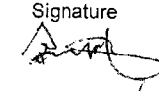
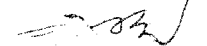
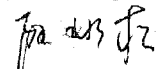
	Name	Function	Signature
Calibrated by:	Yu Zongying	SAR Test Engineer	
Reviewed by:	Qi Dianyuan	SAR Project Leader	
Approved by:	Lu Bingsong	Deputy Director of the laboratory	

Issued June 23, 2015

This calibration certificate shall not be reproduced except in full without written approval of the laboratory.



In Collaboration with  
**s p e a g**  
CALIBRATION LABORATORY

Add: No.51 Xueyuan Road, Haidian District, Beijing, 100191, China  
Tel: +86-10-62304633-2218 Fax: +86-10-62304633-2209  
E-mail: [cttl@chinattl.com](mailto:cttl@chinattl.com) [Http://www.chinattl.cn](http://www.chinattl.cn)

**Glossary:**

DAE data acquisition electronics  
Connector angle information used in DASY system to align probe sensor X to the robot coordinate system.

**Methods Applied and Interpretation of Parameters:**

- *DC Voltage Measurement:* Calibration Factor assessed for use in DASY system by comparison with a calibrated instrument traceable to national standards. The figure given corresponds to the full scale range of the voltmeter in the respective range.
- *Connector angle:* The angle of the connector is assessed measuring the angle mechanically by a tool inserted. Uncertainty is not required.
- The report provide only calibration results for DAE, it does not contain other performance test results.



In Collaboration with  
**s p e a g**  
**CALIBRATION LABORATORY**

Add: No.51 Xueyuan Road, Haidian District, Beijing, 100191, China  
 Tel: +86-10-62304633-2218 Fax: +86-10-62304633-2209  
 E-mail: cttl@chinattl.com Http://www.chinattl.cn

**DC Voltage Measurement**

A/D - Converter Resolution nominal

High Range: 1LSB = 6.1μV, full range = -100...+300 mV

Low Range: 1LSB = 61nV, full range = -1.....+3mV

DASY measurement parameters: Auto Zero Time: 3 sec; Measuring time: 3 sec

Calibration Factors	X	Y	Z
High Range	404.131 ± 0.15% (k=2)	404.672 ± 0.15% (k=2)	404.359 ± 0.15% (k=2)
Low Range	3.99123 ± 0.7% (k=2)	4.00231 ± 0.7% (k=2)	3.97879 ± 0.7% (k=2)

**Connector Angle**

Connector Angle to be used in DASY system	154° ± 1°
-------------------------------------------	-----------



Add: No.51 Xueyuan Road, Haidian District, Beijing, 100191, China  
 Tel: +86-10-62304633-2218 Fax: +86-10-62304633-2209  
 E-mail: cttl@chinattl.com Http://www.chinattl.cn



Client **Emtek(Shenzhen)** Certificate No: **Z15-97079**

**CALIBRATION CERTIFICATE**



Object EX3DV4 - SN:3970  
 Calibration Procedure(s) FD-Z11-2-004-01  
 Calibration Procedures for Dosimetric E-field Probes  
 Calibration date: July 10, 2015

This calibration Certificate documents the traceability to national standards, which realize the physical units of measurements(SI). The measurements and the uncertainties with confidence probability are given on the following pages and are part of the certificate.

All calibrations have been conducted in the closed laboratory facility: environment temperature(22±3)°c and humidity<70%.

Calibration Equipment used (M&TE critical for calibration)

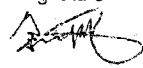
Primary Standards	ID #	Cal Date(Calibrated by, Certificate No.)	Scheduled Calibration
Power Meter NRP2	101919	01-Jul-15 (CTTL, No.J15X04256)	Jun-16
Power sensor NRP-Z91	101547	01-Jul-15 (CTTL, No.J15X04256)	Jun-16
Power sensor NRP-Z91	101548	01-Jul-15 (CTTL, No.J15X04256)	Jun-16
Reference10dBAttenuator	18N50W-10dB	13-Mar-14(TMC,No.JZ14-1103)	Mar-16
Reference20dBAttenuator	18N50W-20dB	13-Mar-14(TMC,No.JZ14-1104)	Mar-16
Reference Probe EX3DV4	SN 3617	28-Aug-14(SPEAG,No.EX3-3617_Aug14)	Aug-15
DAE4	SN 777	17-Sep-14 (SPEAG, DAE4-777_Sep14)	Sep -15
Secondary Standards	ID #	Cal Date(Calibrated by, Certificate No.)	Scheduled Calibration
SignalGeneratorMG3700A	6201052605	01-Jul-15 (CTTL, No.J15X04255)	Jun-16
Network Analyzer E5071C	MY46110673	03-Feb-15 (CTTL, No.J15X00728)	Feb-16

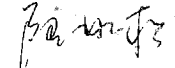
	Name	Function	Signature
Calibrated by:	Yu Zongying	SAR Test Engineer	
Reviewed by:	Qi Dianyuan	SAR Project Leader	
Approved by:	Lu Bingsong	Deputy Director of the laboratory	

Issued: July 15, 2015

This calibration certificate shall not be reproduced except in full without written approval of the laboratory.





In Collaboration with  
**s p e a q**  
CALIBRATION LABORATORY

Add: No.51 Xueyuan Road, Haidian District, Beijing, 100191, China  
Tel: +86-10-62304633-2218 Fax: +86-10-62304633-2209  
E-mail: cctl@chinattl.com [Http://www.chinattl.cn](http://www.chinattl.cn)

#### Glossary:

TSL	tissue simulating liquid
NORM <sub>x,y,z</sub>	sensitivity in free space
ConvF	sensitivity in TSL / NORM <sub>x,y,z</sub>
DCP	diode compression point
CF	crest factor (1/duty_cycle) of the RF signal
A,B,C,D	modulation dependent linearization parameters
Polarization $\Phi$	$\Phi$ rotation around probe axis
Polarization $\theta$	$\theta$ rotation around an axis that is in the plane normal to probe axis (at measurement center), i $\theta=0$ is normal to probe axis

Connector Angle information used in DASY system to align probe sensor X to the robot coordinate system

#### Calibration is Performed According to the Following Standards:

- IEEE Std 1528-2013, "IEEE Recommended Practice for Determining the Peak Spatial-Averaged Specific Absorption Rate (SAR) in the Human Head from Wireless Communications Devices: Measurement Techniques", June 2013
- IEC 62209-1, "Procedure to measure the Specific Absorption Rate (SAR) for hand-held devices used in close proximity to the ear (frequency range of 300MHz to 3GHz)", February 2005

#### Methods Applied and Interpretation of Parameters:

- NORM<sub>x,y,z</sub>:** Assessed for E-field polarization  $\theta=0$  ( $f \leq 900$ MHz in TEM-cell;  $f > 1800$ MHz: waveguide). NORM<sub>x,y,z</sub> are only intermediate values, i.e., the uncertainties of NORM<sub>x,y,z</sub> does not effect the  $E^2$ -field uncertainty inside TSL (see below ConvF).
- NORM(f)<sub>x,y,z</sub> = NORM<sub>x,y,z</sub> \* frequency\_response** (see Frequency Response Chart). This linearization is implemented in DASY4 software versions later than 4.2. The uncertainty of the frequency response is included in the stated uncertainty of ConvF.
- DCP<sub>x,y,z</sub>:** DCP are numerical linearization parameters assessed based on the data of power sweep (no uncertainty required). DCP does not depend on frequency nor media.
- PAR:** PAR is the Peak to Average Ratio that is not calibrated but determined based on the signal characteristics.
- A<sub>x,y,z</sub>; B<sub>x,y,z</sub>; C<sub>x,y,z</sub>; VR<sub>x,y,z</sub>; A,B,C** are numerical linearization parameters assessed based on the data of power sweep for specific modulation signal. The parameters do not depend on frequency nor media. VR is the maximum calibration range expressed in RMS voltage across the diode.
- ConvF and Boundary Effect Parameters:** Assessed in flat phantom using E-field (or Temperature Transfer Standard for  $f \leq 800$ MHz) and inside waveguide using analytical field distributions based on power measurements for  $f > 800$ MHz. The same setups are used for assessment of the parameters applied for boundary compensation (alpha, depth) of which typical uncertainty valued are given. These parameters are used in DASY4 software to improve probe accuracy close to the boundary. The sensitivity in TSL corresponds to NORM<sub>x,y,z</sub>\* ConvF whereby the uncertainty corresponds to that given for ConvF. A frequency dependent ConvF is used in DASY version 4.4 and higher which allows extending the validity from  $\pm 50$ MHz to  $\pm 100$ MHz.
- Spherical isotropy (3D deviation from isotropy):** in a field of low gradients realized using a flat phantom exposed by a patch antenna.
- Sensor Offset:** The sensor offset corresponds to the offset of virtual measurement center from the probe tip (on probe axis). No tolerance required.
- Connector Angle:** The angle is assessed using the information gained by determining the NORM<sub>x</sub> (no uncertainty required).



In Collaboration with  
**s p e a g**  
CALIBRATION LABORATORY

Add: No.51 Xueyuan Road, Haidian District, Beijing, 100191, China  
Tel: +86-10-62304633-2218 Fax: +86-10-62304633-2209  
E-mail: [ctl@chinattl.com](mailto:ctl@chinattl.com) [Http://www.chinattl.cn](http://www.chinattl.cn)

# Probe EX3DV4

SN: 3970

Calibrated: July 10, 2015

Calibrated for DASY/EASY Systems

(Note: non-compatible with DASY2 system!)



Add: No.51 Xueyuan Road, Haidian District, Beijing, 100191, China  
 Tel: +86-10-62304633-2218 Fax: +86-10-62304633-2209  
 E-mail: [ctl@chinattl.com](mailto:ctl@chinattl.com) [Http://www.chinattl.cn](http://www.chinattl.cn)

## DASY/EASY – Parameters of Probe: EX3DV4 – SN: 3970

### Basic Calibration Parameters

	Sensor X	Sensor Y	Sensor Z	Unc (k=2)
Norm( $\mu\text{V}/(\text{V}/\text{m})^2$ ) <sup>A</sup>	0.48	0.64	0.26	$\pm 10.8\%$
DCP(mV) <sup>B</sup>	99.9	105.3	96.9	

### Modulation Calibration Parameters

UID	Communication System Name		A dB	B dB/ $\mu\text{V}$	C	D dB	VR mV	Unc <sup>E</sup> (k=2)
0	CW	X	0.0	0.0	1.0	0.00	191.3	$\pm 2.2\%$
		Y	0.0	0.0	1.0		233.1	
		Z	0.0	0.0	1.0		125.4	

The reported uncertainty of measurement is stated as the standard uncertainty of Measurement multiplied by the coverage factor k=2, which for a normal distribution Corresponds to a coverage probability of approximately 95%.

<sup>A</sup> The uncertainties of Norm X, Y, Z do not affect the E<sup>2</sup>-field uncertainty inside TSL (see Page 5 and Page 6).  
<sup>B</sup> Numerical linearization parameter: uncertainty not required.  
<sup>E</sup> Uncertainty is determined using the max. deviation from linear response applying rectangular distribution and is expressed for the square of the field value.



In Collaboration with  
**S P E A G**  
 CALIBRATION LABORATORY  
 Add: No.51 Xueyuan Road, Haidian District, Beijing, 100191, China  
 Tel: +86-10-62304633-2218 Fax: +86-10-62304633-2209  
 E-mail: [ctl@chinattl.com](mailto:ctl@chinattl.com) <http://www.chinattl.cn>

## DASY/EASY – Parameters of Probe: EX3DV4 – SN: 3970

### Calibration Parameter Determined in Head Tissue Simulating Media

f [MHz] <sup>C</sup>	Relative Permittivity <sup>F</sup>	Conductivity (S/m) <sup>F</sup>	ConvF X	ConvF Y	ConvF Z	Alpha <sup>G</sup>	Depth <sup>G</sup> (mm)	Unct. (k=2)
750	41.9	0.89	10.38	10.38	10.38	0.20	1.07	± 12%
835	41.5	0.90	10.08	10.08	10.08	0.25	1.08	± 12%
900	41.5	0.97	9.88	9.88	9.88	0.17	1.22	± 12%
1810	40.0	1.40	8.18	8.18	8.18	0.21	1.12	± 12%
2000	40.0	1.40	8.14	8.14	8.14	0.17	1.35	± 12%
2100	39.8	1.49	8.36	8.36	8.36	0.22	1.26	± 12%
2300	39.5	1.67	7.77	7.77	7.77	0.29	1.10	± 12%
2450	39.2	1.80	7.36	7.36	7.36	0.27	1.26	± 12%
5200	36.0	4.66	5.64	5.64	5.64	0.50	1.00	± 13%
5300	35.9	4.76	5.36	5.36	5.36	0.47	1.19	± 13%
5500	35.6	4.96	5.15	5.15	5.15	0.48	1.16	± 13%
5600	35.5	5.07	5.02	5.02	5.02	0.48	1.07	± 13%
5800	35.3	5.27	4.93	4.93	4.93	0.49	1.12	± 13%

<sup>C</sup> Frequency validity of ±100MHz only applies for DASY v4.4 and higher (Page 2), else it is restricted to ±50MHz. The uncertainty is the RSS of ConvF uncertainty at calibration frequency and the uncertainty for the indicated frequency band.

<sup>F</sup> At frequency below 3 GHz, the validity of tissue parameters ( $\epsilon$  and  $\sigma$ ) can be relaxed to ±10% if liquid compensation formula is applied to measured SAR values. At frequencies above 3 GHz, the validity of tissue parameters ( $\epsilon$  and  $\sigma$ ) is restricted to ±5%. The uncertainty is the RSS of the ConvF uncertainty for indicated target tissue parameters.

<sup>G</sup> Alpha/Depth are determined during calibration. SPEAG warrants that the remaining deviation due to the boundary effect after compensation is always less than ± 1% for frequencies below 3 GHz and below ± 2% for the frequencies between 3-6 GHz at any distance larger than half the probe tip diameter from the boundary.



In Collaboration with  
**s p e a g**  
**CALIBRATION LABORATORY**

Add: No.51 Xueyuan Road, Haidian District, Beijing, 100191, China  
 Tel: +86-10-62304633-2218 Fax: +86-10-62304633-2209  
 E-mail: cttl@chinattl.com [Http://www.chinattl.cn](http://www.chinattl.cn)

### DASY/EASY – Parameters of Probe: EX3DV4 – SN: 3970

#### Calibration Parameter Determined in Body Tissue Simulating Media

f [MHz] <sup>C</sup>	Relative Permittivity <sup>F</sup>	Conductivity (S/m) <sup>F</sup>	ConvF X	ConvF Y	ConvF Z	Alpha <sup>G</sup>	Depth <sup>G</sup> (mm)	Unct. (k=2)
750	55.5	0.96	10.32	10.32	10.32	0.38	0.90	± 12%
835	55.2	0.97	10.27	10.27	10.27	0.14	1.60	± 12%
900	55.0	1.05	9.90	9.90	9.90	0.21	1.23	± 12%
1810	53.3	1.52	8.06	8.06	8.06	0.16	1.48	± 12%
2000	53.3	1.52	7.92	7.92	7.92	0.29	1.59	± 12%
2100	53.2	1.62	8.31	8.31	8.31	0.14	2.17	± 12%
2300	52.9	1.81	7.87	7.87	7.87	0.28	1.32	± 12%
2450	52.7	1.95	7.66	7.66	7.66	0.34	1.10	± 12%
5200	49.0	5.30	5.08	5.08	5.08	0.48	1.13	± 13%
5300	48.9	5.42	4.82	4.82	4.82	0.47	1.15	± 13%
5500	48.6	5.65	4.57	4.57	4.57	0.51	1.10	± 13%
5600	48.5	5.77	4.52	4.52	4.52	0.52	1.04	± 13%
5800	48.2	6.00	4.69	4.69	4.69	0.51	1.12	± 13%

<sup>C</sup> Frequency validity of ±100MHz only applies for DASY v4.4 and higher (Page 2), else it is restricted to ±50MHz. The uncertainty is the RSS of ConvF uncertainty at calibration frequency and the uncertainty for the indicated frequency band.

<sup>F</sup> At frequency below 3 GHz, the validity of tissue parameters ( $\epsilon$  and  $\sigma$ ) can be relaxed to ±10% if liquid compensation formula is applied to measured SAR values. At frequencies above 3 GHz, the validity of tissue parameters ( $\epsilon$  and  $\sigma$ ) is restricted to ±5%. The uncertainty is the RSS of the ConvF uncertainty for indicated target tissue parameters.

<sup>G</sup> Alpha/Depth are determined during calibration. SPEAG warrants that the remaining deviation due to the boundary effect after compensation is always less than ± 1% for frequencies below 3 GHz and below ± 2% for the frequencies between 3-6 GHz at any distance larger than half the probe tip diameter from the boundary.

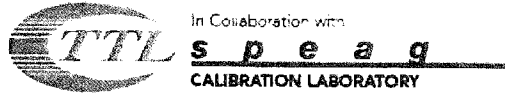

Add: No.51 Xueyuan Road, Haidian District, Beijing, 100191, China  
Tel: +86-10-62304633-2218 Fax: +86-10-62304633-2209  
E-mail: [cttl@chinattl.com](mailto:cttl@chinattl.com) [Http://www.chinattl.cn](http://www.chinattl.cn)

### Frequency Response of E-Field (TEM-Cell: ifi110 EXX, Waveguide: R22)

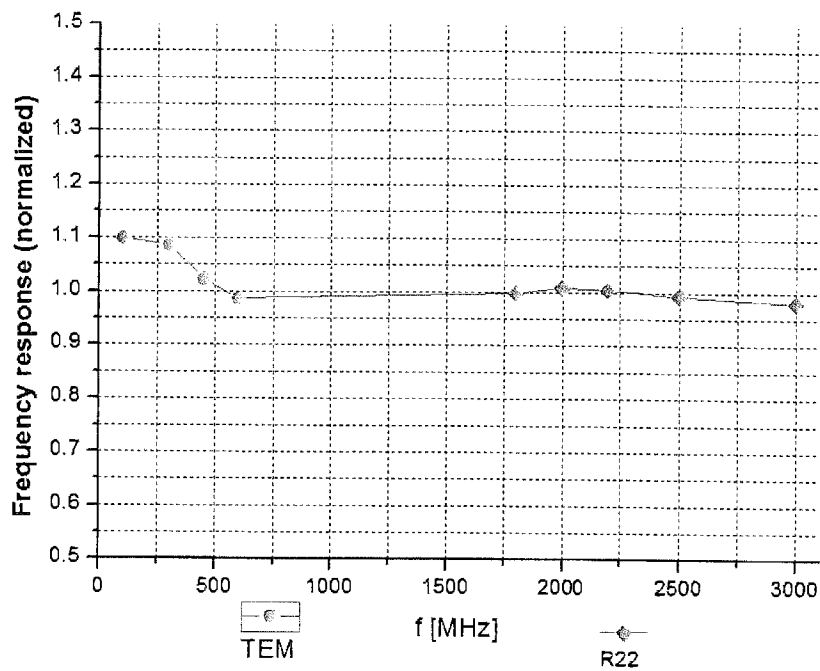

Uncertainty of Frequency Response of E-field:  $\pm 7.5\%$  (k=2)



Add: No.51 Xueyuan Road, Haidian District, Beijing, 100191, China  
Tel: +86-10-62304633-2218 Fax: +86-10-62304633-2209  
E-mail: cttl@chinattl.com [Http://www.chinattl.cn](http://www.chinattl.cn)

### Receiving Pattern ( $\Phi$ ), $\theta=0^\circ$

f=600 MHz, TEM

f=1800 MHz, R22

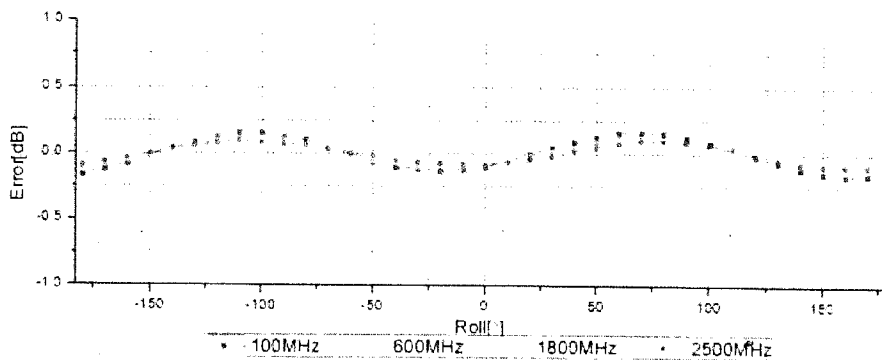
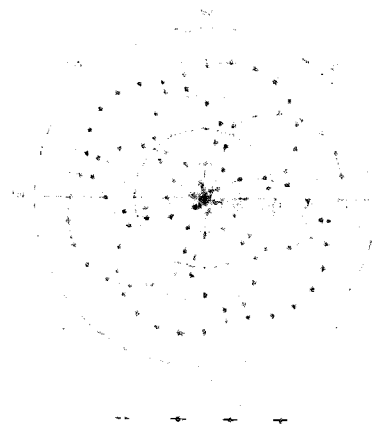
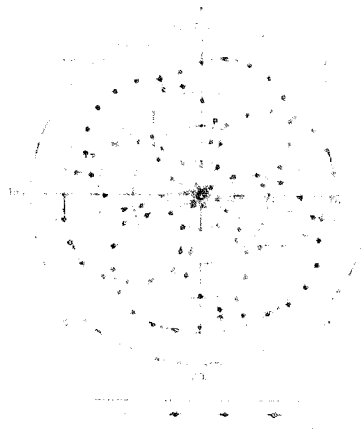

Uncertainty of Axial Isotropy Assessment:  $\pm 0.9\%$  (k=2)

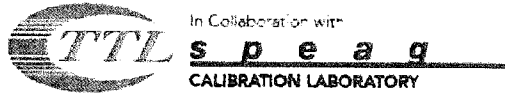

Add: No.51 Xueyuan Road, Haidian District, Beijing, 100191, China  
 Tel: +86-10-62304633-2218 Fax: +86-10-62304633-2209  
 E-mail: cttl@chinattl.com [Http://www.chinattl.cn](http://www.chinattl.cn)

### Dynamic Range f(SAR<sub>head</sub>) (TEM cell, f = 900 MHz)

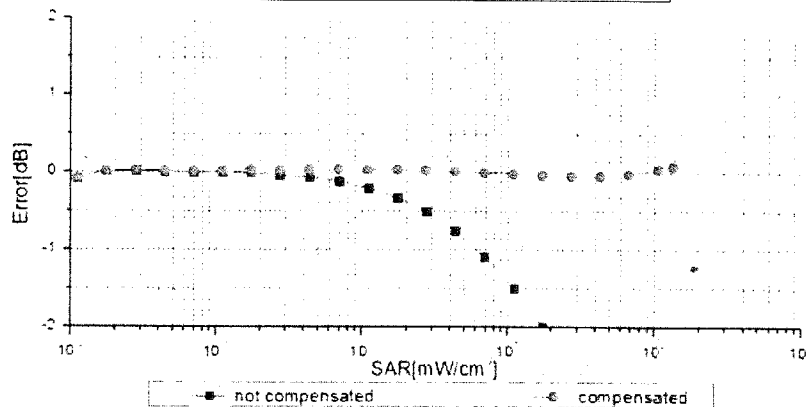
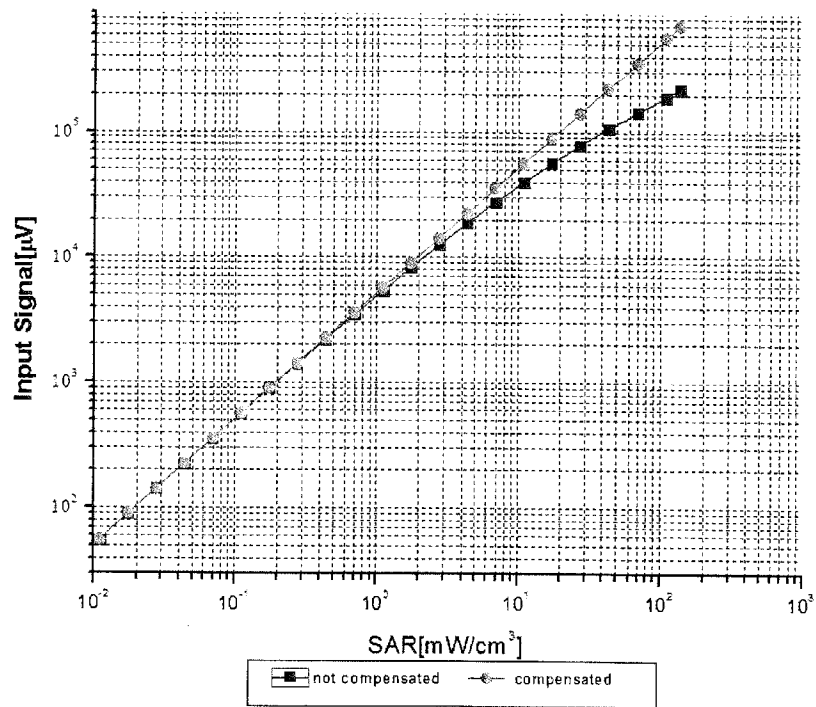

Uncertainty of Linearity Assessment: ±0.9% (k=2)





Add: No.51 Xueyuan Road, Haidian District, Beijing, 100191, China  
 Tel: +86-10-62304633-2218 Fax: +86-10-62304633-2209  
 E-mail: cttl@chinattl.com [Http://www.chinattl.cn](http://www.chinattl.cn)

### Conversion Factor Assessment

f=900 MHz, WGLS R9(H\_convF)

f=1810 MHz, WGLS R22(H\_convF)

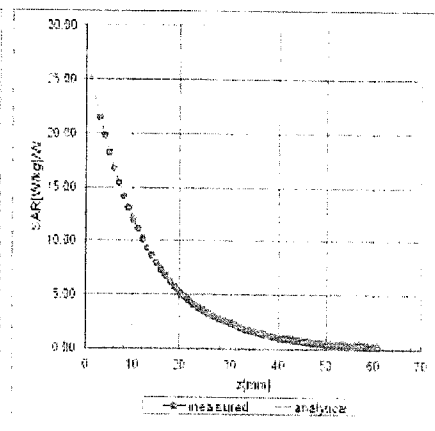
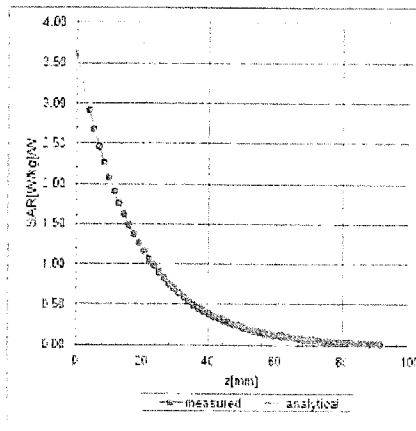

### Deviation from Isotropy in Liquid

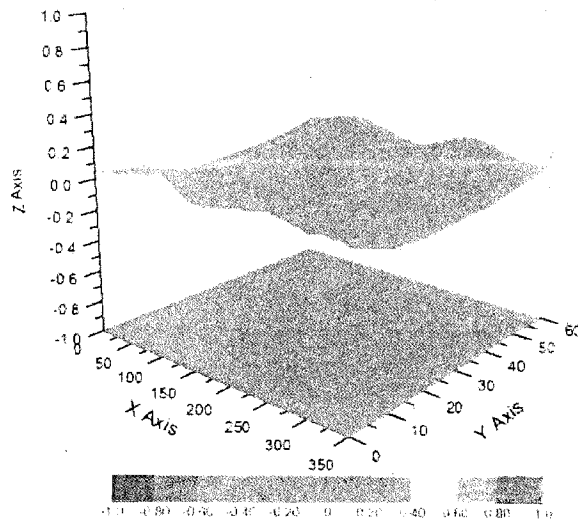

Uncertainty of Spherical Isotropy Assessment:  $\pm 2.8\%$  (K=2)



Add: No.51 Xueyuan Road, Haidian District, Beijing, 100191, China  
Tel: +86-10-62304633-2218 Fax: +86-10-62304633-2209  
E-mail: [cttl@chinatl.com](mailto:cttl@chinatl.com) [Http://www.chinatl.cn](http://www.chinatl.cn)

## DASY/EASY – Parameters of Probe: EX3DV4 – SN: 3970

### Other Probe Parameters

Sensor Arrangement	Triangular
Connector Angle (°)	158.1
Mechanical Surface Detection Mode	enabled
Optical Surface Detection Mode	disable
Probe Overall Length	337mm
Probe Body Diameter	10mm
Tip Length	9mm
Tip Diameter	2.5mm
Probe Tip to Sensor X Calibration Point	1mm
Probe Tip to Sensor Y Calibration Point	1mm
Probe Tip to Sensor Z Calibration Point	1mm
Recommended Measurement Distance from Surface	1.4mm

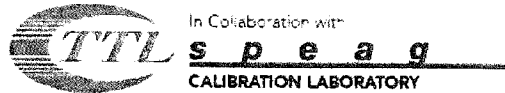

Add: No.51 Xueyuan Road, Haidian District, Beijing, 100191, China  
Tel: +86-10-62304633-2079 Fax: +86-10-62304633-2504  
E-mail: cttl@chinattl.com Http://www.chinattl.cn



Client **Emtek(Shenzhen)** Certificate No: **Z15-97094**

**CALIBRATION CERTIFICATE**

Object EX3DV4 - SN:3970  
Calibration Procedure(s) TMC-OS-E-02-195  
Calibration Procedures for Dosimetric E-field Probes  
Calibration date: July 21, 2015 (**Additional Conversion Factors**)

This calibration Certificate documents the traceability to national standards, which realize the physical units of measurements(SI). The measurements and the uncertainties with confidence probability are given on the following pages and are part of the certificate.

All calibrations have been conducted in the closed laboratory facility: environment temperature (22±3)°C and humidity<70%.

Calibration Equipment used (M&TE critical for calibration)

Primary Standards	ID #	Cal Date(Calibrated by, Certificate No.)	Scheduled Calibration
Power Meter NRP2	101919	01-Jul-15 (CTTL, No.J15X04256)	Jun-16
Power sensor NRP-Z91	101547	01-Jul-15 (CTTL, No.J15X04256)	Jun-16
Power sensor NRP-Z91	101548	01-Jul-15 (CTTL, No.J15X04256)	Jun-16
Reference10dBAttenuator	18N50W-10dB	13-Mar-14(TMC,No.JZ14-1103)	Mar-16
Reference20dBAttenuator	18N50W-20dB	13-Mar-14(TMC,No.JZ14-1104)	Mar-16
Reference Probe EX3DV4	SN 3617	28-Aug-14(SPEAG,No.EX3-3617_Aug 14)	Aug-15
DAE4	SN 777	17-Sep-14 (SPEAG, DAE4-777_Sep14)	Sep -15
Secondary Standards	ID #	Cal Date(Calibrated by, Certificate No.)	Scheduled Calibration
SignalGeneratorMG3700A	6201052605	01-Jul-15 (CTTL, No.J15X04255)	Jun-16
Network Analyzer E5071C	MY46110673	03-Feb-15 (CTTL, No.J15X00728)	Feb-16

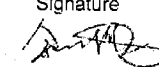
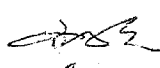
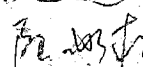
	Name	Function	Signature
Calibrated by:	Yu Zongying	SAR Test Engineer	
Reviewed by:	Qi Dianyuan	SAR Project Leader	
Approved by:	Lu Bingsong	Deputy Director of the laboratory	

Issued: July 21, 2015

This calibration certificate shall not be reproduced except in full without written approval of the laboratory.

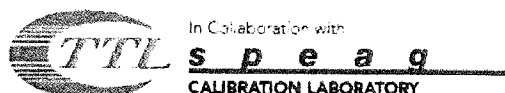

Add: No.51 Xueyuan Road, Haidian District, Beijing, 100191, China  
Tel: +86-10-62304633-2079 Fax: +86-10-62304633-2504  
E-mail: cttl@chinattl.com Http://www.chinattl.cn

#### Glossary:

TSL	tissue simulating liquid
NORM <sub>x,y,z</sub>	sensitivity in free space
ConvF	sensitivity in TSL / NORM <sub>x,y,z</sub>
DCP	diode compression point
CF	crest factor (1/duty_cycle) of the RF signal
A,B,C,D	modulation dependent linearization parameters
Polarization $\Phi$	$\Phi$ rotation around probe axis
Polarization $\theta$	$\theta$ rotation around an axis that is in the plane normal to probe axis (at measurement center), i $\theta=0$ is normal to probe axis

Connector Angle information used in DASY system to align probe sensor X to the robot coordinate system

#### Calibration is Performed According to the Following Standards:

- IEEE Std 1528-2013, "IEEE Recommended Practice for Determining the Peak Spatial-Averaged Specific Absorption Rate (SAR) in the Human Head from Wireless Communications Devices: Measurement Techniques", June 2013
- IEC 62209-1, "Procedure to measure the Specific Absorption Rate (SAR) for hand-held devices used in close proximity to the ear (frequency range of 300MHz to 3GHz)", February 2005

#### Methods Applied and Interpretation of Parameters:

- NORM<sub>x,y,z</sub>:** Assessed for E-field polarization  $\theta=0$  ( $f \leq 900$ MHz in TEM-cell;  $f > 1800$ MHz: waveguide). NORM<sub>x,y,z</sub> are only intermediate values, i.e., the uncertainties of NORM<sub>x,y,z</sub> does not effect the  $E^2$ -field uncertainty inside TSL (see below ConvF).
- NORM(f)<sub>x,y,z</sub> = NORM<sub>x,y,z</sub> \* frequency\_response** (see Frequency Response Chart). This linearization is implemented in DASY4 software versions later than 4.2. The uncertainty of the frequency response is included in the stated uncertainty of ConvF.
- DCP<sub>x,y,z</sub>:** DCP are numerical linearization parameters assessed based on the data of power sweep (no uncertainty required). DCP does not depend on frequency nor media.
- PAR:** PAR is the Peak to Average Ratio that is not calibrated but determined based on the signal characteristics.
- A<sub>x,y,z</sub>; B<sub>x,y,z</sub>; C<sub>x,y,z</sub>; VR<sub>x,y,z</sub>; A,B,C** are numerical linearization parameters assessed based on the data of power sweep for specific modulation signal. The parameters do not depend on frequency nor media. VR is the maximum calibration range expressed in RMS voltage across the diode.
- ConvF and Boundary Effect Parameters:** Assessed in flat phantom using E-field (or Temperature Transfer Standard for  $f \leq 800$ MHz) and inside waveguide using analytical field distributions based on power measurements for  $f > 800$ MHz. The same setups are used for assessment of the parameters applied for boundary compensation (alpha, depth) of which typical uncertainty valued are given. These parameters are used in DASY4 software to improve probe accuracy close to the boundary. The sensitivity in TSL corresponds to NORM<sub>x,y,z</sub> \* ConvF whereby the uncertainty corresponds to that given for ConvF. A frequency dependent ConvF is used in DASY version 4.4 and higher which allows extending the validity from  $\pm 50$ MHz to  $\pm 100$ MHz.
- Spherical isotropy (3D deviation from isotropy):** in a field of low gradients realized using a flat phantom exposed by a patch antenna.
- Sensor Offset:** The sensor offset corresponds to the offset of virtual measurement center from the probe tip (on probe axis). No tolerance required.
- Connector Angle:** The angle is assessed using the information gained by determining the NORM<sub>x</sub> (no uncertainty required).



In Collaboration with  
**s p e a g**  
CALIBRATION LABORATORY

Add: No.51 Xueyuan Road, Haidian District, Beijing, 100191, China  
Tel: +86-10-62304633-2079 Fax: +86-10-62304633-2504  
E-mail: [ctl@chinattl.com](mailto:ctl@chinattl.com) [Http://www.chinattl.cn](http://www.chinattl.cn)

# Probe EX3DV4

SN: 3970

Calibrated: July 21, 2015

Calibrated for DASY/EASY Systems

(Note: non-compatible with DASY2 system!)

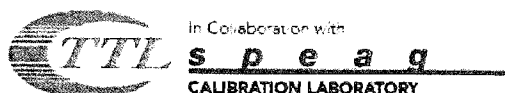

In Collaboration with  
**S P E A G**  
**CALIBRATION LABORATORY**  
 Add: No.51 Xueyuan Road, Haidian District, Beijing, 100191, China  
 Tel: +86-10-62304633-2079 Fax: +86-10-62304633-2504  
 E-mail: cttj@chinattl.com Http://www.chinattl.cn

## DASY – Parameters of Probe: EX3DV4 - SN: 3970

### Calibration Parameter Determined in Head Tissue Simulating Media

f [MHz] <sup>C</sup>	Relative Permittivity <sup>F</sup>	Conductivity (S/m) <sup>F</sup>	ConvF X	ConvF Y	ConvF Z	Alpha <sup>G</sup>	Depth <sup>G</sup> (mm)	Unct. (k=2)
2600	39.0	1.96	7.36	7.36	7.36	0.47	0.84	± 12%

### Calibration Parameter Determined in Body Tissue Simulating Media

f [MHz] <sup>C</sup>	Relative Permittivity <sup>F</sup>	Conductivity (S/m) <sup>F</sup>	ConvF X	ConvF Y	ConvF Z	Alpha <sup>G</sup>	Depth <sup>G</sup> (mm)	Unct. (k=2)
2600	52.5	2.16	7.57	7.57	7.57	0.46	0.89	± 12%

<sup>C</sup> Frequency validity of ±100MHz only applies for DASY v4.4 and higher (Page 2), else it is restricted to ±50MHz. The uncertainty is the RSS of ConvF uncertainty at calibration frequency and the uncertainty for the indicated frequency band.

<sup>F</sup> At frequency below 3 GHz, the validity of tissue parameters ( $\epsilon$  and  $\sigma$ ) can be relaxed to ±10% if liquid compensation formula is applied to measured SAR values. At frequencies above 3 GHz, the validity of tissue parameters ( $\epsilon$  and  $\sigma$ ) is restricted to ±5%. The uncertainty is the RSS of the ConvF uncertainty for indicated target tissue parameters.

<sup>G</sup> Alpha/Depth are determined during calibration. SPEAG warrants that the remaining deviation due to the boundary effect after compensation is always less than ± 1% for frequencies below 3 GHz and below ± 2% for the frequencies between 3-6 GHz at any distance larger than half the probe tip diameter from the boundary.

**Note: For other parameters please refer to report (No. Z15-97079). And this report should be used together with No. Z15-97079 report.**