



# TEST REPORT

**Report Reference No.**..... : **TRE1404004501** R/C.....:46475

**FCC ID**..... : **2AAP6M7033**

**Applicant's name**..... : **SHENZHEN ZOWEE TECHNOLOGY CO.,LTD.**

**Address**..... : Science &Technology Industrial Park of Privately Owned Enterprises,  
Pingshan, Xili, Nanshan District, Shenzhen, PR CHINA

**Manufacturer**..... : SHENZHEN ZOWEE TECHNOLOGY CO.,LTD.

.....:

**Address**..... : Science &Technology Industrial Park of Privately Owned Enterprises,  
Pingshan, Xili, Nanshan District, Shenzhen, PR CHINA

.....:

**Test item description** ..... : **Internet Tablet**

**Trade Mark** ..... : DOPO, D.AGE,TMAX, APEX, Nobis

**Model/Type reference**..... : M7033

**List Model** ..... : NB7850 S,NB7850M,NB7850MD,NB7855 S,NB7850  
SM,TM785M2,TM785MS,TM785M5,TM785M8,DP785,DP786,DP788,D  
P785 S,DP785M,M7048,M7033

**Standard** ..... : **FCC CFR Title 47 Part 15 Subpart C Section 15.247**

**Date of receipt of test sample**..... : Apr 10, 2014

**Date of testing** ..... : Apr 12, 2014- May18, 2014

**Date of issue**..... : Apr 19, 2014

**Result**..... : **PASS**

**Compiled by**  
 ( position+printed name+signature)..: File administrators Jerome Luo 

**Supervised by**  
 ( position+printed name+signature)..: Project Engineer Yuchao Wang 

**Approved by**  
 ( position+printed name+signature)..: RF Manager Hans Hu 

**Testing Laboratory Name** ..... : **Shenzhen Huatongwei International Inspection Co., Ltd**

**Address**..... : Keji Nan No.12 Road, Hi-tech Park, Shenzhen, China

**Shenzhen Huatongwei International Inspection Co., Ltd. All rights reserved.**

This publication may be reproduced in whole or in part for non-commercial purposes as long as the Shenzhen Huatongwei International Inspection Co., Ltd is acknowledged as copyright owner and source of the material. Shenzhen Huatongwei International Inspection Co., Ltd takes no responsibility for and will not assume liability for damages resulting from the reader's interpretation of the reproduced material due to its placement and context.

## Contents

<b>1.</b>	<b><u>TEST STANDARDS AND TEST DESCRIPTION.....</u></b>	<b>3</b>
1.1.	Test Standards	3
1.2.	Test Description	3
<b>2.</b>	<b><u>SUMMARY .....</u></b>	<b>4</b>
2.1.	Client Information	4
2.2.	Product Description	4
2.3.	EUT operation mode	5
2.4.	EUT configuration	5
2.5.	Modifications	5
<b>3.</b>	<b><u>TEST ENVIRONMENT .....</u></b>	<b>6</b>
3.1.	Address of the test laboratory	6
3.2.	Test Facility	6
3.3.	Environmental conditions	7
3.4.	Statement of the measurement uncertainty	7
3.5.	Equipments Used during the Test	8
<b>4.</b>	<b><u>TEST CONDITIONS AND RESULTS.....</u></b>	<b>9</b>
4.1.	Antenna requirement	9
4.2.	Conducted Emission (AC Main)	10
4.3.	Conducted Peak Output Power	13
4.4.	Power Spectral Density	17
4.5.	6dB bandwidth	21
4.6.	Band Edge	25
4.7.	Spurious Emission (conducted)	34
4.8.	Spurious Emission (radiated)	44
<b>5.</b>	<b><u>TEST SETUP PHOTOS OF THE EUT .....</u></b>	<b>49</b>
<b>6.</b>	<b><u>EXTERNAL AND INTERNAL PHOTOS OF THE EUT.....</u></b>	<b>51</b>

# 1. TEST STANDARDS AND TEST DESCRIPTION

## 1.1. Test Standards

The tests were performed according to following standards:

[FCC Rules Part 15.247](#): Frequency Hopping, Direct Spread Spectrum and Hybrid Systems that are in operation within the bands of 902-928 MHz, 2400-2483.5 MHz, and 5725-5850 MHz.

[ANSI C63.10](#): American National Standard for Testing Unlicensed Wireless Devices

[KDB558074 D01 V03](#): Guidance for Performing Compliance Measurements on Digital Transmission Systems (DTS) Operating Under §15.247

## 1.2. Test Description

Test Item	Section in CFR 47	Result
Antenna requirement	15.203/15.247 (c)	Pass
Line Conducted Emission (AC Main)	15.207	Pass
Conducted Peak Output Power	15.247 (b)(3)	Pass
Power Spectral Density	15.247 (e)	Pass
6dB Bandwidth	15.247 (a)(2)	Pass
Band Edge	15.247(d)	Pass
Spurious Emission	15.205/15.209	Pass

Remark: The measurement uncertainty is not included in the test result.

## 2. SUMMARY

### 2.1. Client Information

Applicant:	SHENZHEN ZOWEE TECHNOLOGY CO.,LTD.
Address:	Science &Technology Industrial Park of Privately Owned Enterprises, Pingshan, Xili, Nanshan District, Shenzhen, PR CHINA
Manufacturer:	SHENZHEN ZOWEE TECHNOLOGY CO.,LTD.
Address:	Science &Technology Industrial Park of Privately Owned Enterprises, Pingshan, Xili, Nanshan District, Shenzhen, PR CHINA

### 2.2. Product Description

Name of EUT	Internet Tablet
Trade Mark:	DOPO, D.AGE, TMAX, APEX, Nobis
Model No.:	M7033
List Model:	NB7850 S,NB7850M,NB7850MD,NB7855 S,NB7850 SM,TM785M2,TM785M S,TM785M5,TM785M8,DP785,DP786,DP788,DP785 S,DP785M,M7048,M70 33
Power supply:	DC 3.7V From Internal Battery
Adapter information:	Mode:JK050200-S04USA INPUT:100-240V 50/60Hz 0.5A OUTPUT:5V 2000mA
<b>WIFI</b>	
Supported type:	802.11b/802.11g/802.11n(H20)
Modulation:	802.11b: DSSS 802.11g/802.11n(H20)
Operation frequency:	802.11b/802.11g/802.11n(H20): 2412MHz~2462MHz
Bit Rate:	<b>802.11b:</b> 1/2/5.5/11Mbps <b>802.11g:</b> 6/9/12/18/24/36/48/54Mbps <b>802.11n(H20):</b> MCS0~MCS7: 6.5/13/19.5/26/39/52/58.5/65Mbps MCS8~MCS15: 13/26/39/52/78/104/117/130Mbps
Channel number:	802.11b/802.11g/802.11n(H20): 11
Channel separation:	5MHz
Antenna type:	Internal Antenna
Antenna gain:	1.28 dBi

Operation Frequency List:

802.11b/g/n(H20)	
Channel	Frequency (MHz)
01	2412
02	2417
⋮	⋮
06	2437
⋮	⋮
10	2457
11	2462

Note:

In section 15.31(m), regards to the operating frequency range over 10 MHz, the Lowest frequency, the middle frequency, and the highest frequency of channel were selected to perform the test, please see the above gray bottom.

### 2.3. EUT operation mode

The EUT has been tested under test mode condition. The Applicant provides software to control the EUT for staying in continuous transmitting and receiving mode for testing.

And found which the below bit rate is worst case mode, so only show data which it is a worst case mode.

Mode	Bit rate (worst mode)
802.11b	11Mbps
802.11g	54Mbps
802.11n(H20)	130Mbps

### 2.4. EUT configuration

The following peripheral devices and interface cables were connected during the measurement:

- - supplied by the manufacturer
- - supplied by the lab

<input type="radio"/>	Power Cable	Length (m) : /
		Shield : /
		Detachable : /
<input type="radio"/>	Multimeter	Manufacturer : /
		Model No. : /

### 2.5. Modifications

No modifications were implemented to meet testing criteria.

### **3. TEST ENVIRONMENT**

#### **3.1. Address of the test laboratory**

Shenzhen Huatongwei International Inspection Co., Ltd.  
Keji Nan No.12 Road, Hi-tech Park, Shenzhen, China  
Phone: 86-755-26748019 Fax: 86-755-26748089

#### **3.2. Test Facility**

The test facility is recognized, certified, or accredited by the following organizations:

##### **CNAS-Lab Code: L1225**

Shenzhen Huatongwei International Inspection Co., Ltd. has been assessed and proved to be in compliance with CNAS-CL01 Accreditation Criteria for Testing and Calibration Laboratories (identical to ISO/IEC 17025: 2005 General Requirements) for the Competence of Testing and Calibration Laboratories, Date of Registration: Mar. 01, 2012. Valid time is until February 28, 2015.

##### **A2LA-Lab Cert. No. 2243.01**

Shenzhen Huatongwei International Inspection Co., Ltd. EMC Laboratory has been accredited by A2LA for technical competence in the field of electrical testing, and proved to be in compliance with ISO/IEC 17025: 2005 General Requirements for the Competence of Testing and Calibration Laboratories and any additional program requirements in the identified field of testing. Valid time is until Sept 30, 2015.

##### **FCC-Registration No.: 662850**

Shenzhen Huatongwei International Inspection Co., Ltd. EMC Laboratory has been registered and fully described in a report filed with the FCC (Federal Communications Commission). The acceptance letter from the FCC is maintained in our files. Registration 662850, Renewal date Jul. 01, 2012, valid time is until Jun. 01, 2015.

##### **IC-Registration No.: 5377A**

The 3m Alternate Test Site of Shenzhen Huatongwei International Inspection Co., Ltd. has been registered by Certification and Engineering Bureau of Industry Canada for the performance of radiated measurements with Registration No. 5377A on Dec. 31, 2013, valid time is until Dec. 31, 2016.

##### **ACA**

Shenzhen Huatongwei International Inspection Co., Ltd. EMC Laboratory can also perform testing for the Australian C-Tick mark as a result of our A2LA accreditation.

##### **VCCI**

The 3m Semi-anechoic chamber (12.2m×7.95m×6.7m) of Shenzhen Huatongwei International Inspection Co., Ltd. has been registered in accordance with the Regulations for Voluntary Control Measures with Registration No.:R-2484. Date of Registration: Dec. 20, 2012. Valid time is until Dec. 29, 2015.

Radiated disturbance above 1GHz measurement of Shenzhen Huatongwei International Inspection Co., Ltd. has been registered in accordance with the Regulations for Voluntary Control Measures with Registration No.: G-292. Date of Registration: Dec. 24, 2013. Valid time is until Dec. 23, 2016.

Main Ports Conducted Interference Measurement of Shenzhen Huatongwei International Inspection Co., Ltd. has been registered in accordance with the Regulations for Voluntary Control Measures with Registration No.: C-2726. Date of Registration: Dec. 20, 2012. Valid time is until Dec. 19, 2015.

Telecommunication Ports Conducted Interference Measurement of Shenzhen Huatongwei International Inspection Co., Ltd. has been registered in accordance with the Regulations for Voluntary Control Measures with Registration No.: T-1837. Date of Registration: May 07, 2013. Valid time is until May 06, 2016.

##### **DNV**

Shenzhen Huatongwei International Inspection Co., Ltd. has been found to comply with the requirements of DNV towards subcontractor of EMC and safety testing services in conjunction with the EMC and Low voltage Directives and in the voluntary field. The acceptance is based on a formal quality Audit and follow-ups according to relevant parts of ISO/IEC Guide 17025 (2005), in accordance with the requirements of the DNV Laboratory Quality Manual towards subcontractors. Valid time is until Aug. 24, 2016.

### 3.3. Environmental conditions

During the measurement the environmental conditions were within the listed ranges:

Temperature:	15~35°C
Relative Humidity:	30~60 %
Air Pressure:	950~1050mba

### 3.4. Statement of the measurement uncertainty

The data and results referenced in this document are true and accurate. The reader is cautioned that there may be errors within the calibration limits of the equipment and facilities. The measurement uncertainty was calculated for all measurements listed in this test report according to TR-100028-01 "Electromagnetic compatibility and Radio spectrum Matters (ERM); Uncertainties in the measurement of mobile radio equipment characteristics; Part 1" and TR-100028-02 "Electromagnetic compatibility and Radio spectrum Matters (ERM); Uncertainties in the measurement of mobile radio equipment characteristics; Part 2" and is documented in the Shenzhen Huatongwei International Inspection Co., Ltd quality system according to DIN EN ISO/IEC 17025. Furthermore, component and process variability of devices similar to that tested may result in additional deviation. The manufacturer has the sole responsibility of continued compliance of the device.

Hereafter the best measurement capability for Shenzhen Huatongwei laboratory is reported:

Test Items	Measurement Uncertainty	Notes
Transmitter power conducted	0.57 dB	(1)
Transmitter power Radiated	2.20 dB	(1)
Conducted spurious emission 9KHz-40 GHz	1.60 dB	(1)
Radiated spurious emission 9KHz-40 GHz	2.20 dB	(1)
Conducted Emission 9KHz-30MHz	3.39 dB	(1)
Radiated Emission 30~1000MHz	4.24 dB	(1)
Radiated Emission 1~18GHz	5.16 dB	(1)
Radiated Emission 18-40GHz	5.54 dB	(1)
Occupied Bandwidth	-----	(1)

(1) This uncertainty represents an expanded uncertainty expressed at approximately the 95% confidence level using a coverage factor of  $k=1.96$ .

**3.5. Equipments Used during the Test**

AC Power Conducted Emission					
Item	Test Equipment	Manufacturer	Model No.	Serial No.	Cal Due
1	Artificial Mains	Rohde&Schwarz	ESH2-Z5	100028	2014/10/25
2	EMI Test Receiver	Rohde&Schwarz	ESCI3	100038	2014/10/25
3	Pulse Limiter	Rohde&Schwarz	ESHSZ2	100044	2014/10/25
4	EMI Test Software	Rohde&Schwarz	ES-K1 V1.71	N/A	N/A

Radiated Emission					
Item	Test Equipment	Manufacturer	Model No.	Serial No.	Cal Due
1	Ultra-Broadband Antenna	ShwarzBeck	VULB9163	538	2014/10/25
2	EMI TEST RECEIVER	Rohde&Schwarz	ESI 26	100009	2014/10/25
3	EMI TEST Software	Audix	E3	N/A	N/A
4	TURNTABLE	ETS	2088	2149	N/A
5	ANTENNA MAST	ETS	2075	2346	N/A
6	EMI TEST Software	Rohde&Schwarz	ESK1	N/A	N/A
7	HORN ANTENNA	ShwarzBeck	9120D	1011	2014/10/25
8	Amplifer	Sonoma	310N	E009-13	2014/10/25
9	JS amplifer	Rohde&Schwarz	JS4-00101800-28-5A	F201504	2014/10/25
10	High pass filter	Compliance Direction systems	BSU-6	34202	2014/10/25
11	HORN ANTENNA	ShwarzBeck	9120D	1012	2014/10/25
12	Amplifer	Compliance Direction systems	PAP1-4060	120	2014/10/25
13	Loop Antenna	Rohde&Schwarz	HFH2-Z2	100020	2014/10/25
14	TURNTABLE	MATURO	TT2.0	----	N/A
15	ANTENNA MAST	MATURO	TAM-4.0-P	----	N/A
16	Horn Antenna	SCHWARZBECK	BBHA9170	25841	2014/10/25
17	ULTRA-BROADBAND ANTENNA	Rohde&Schwarz	HL562	100015	2014/10/25

Maximum Peak Output Power / Power Spectral Density / 6dB Bandwidth / Band Edge Compliance of RF Emission / Spurious RF Conducted Emission					
Item	Test Equipment	Manufacturer	Model No.	Serial No.	Cal Due
1	Spectrum Analyzer	Rohde&Schwarz	FSP	1164.4391.40	2014/10/25

The Cal.Interval was one year



## 4. TEST CONDITIONS AND RESULTS

### 4.1. Antenna requirement

#### Requirement

##### **FCC CFR Title 47 Part 15 Subpart C Section 15.203:**

An intentional radiator shall be designed to ensure that no antenna other than that furnished by the responsible party shall be used with the device. The use of a permanently attached antenna or of an antenna that uses a unique coupling to the intentional radiator, the manufacturer may design the unit so that a broken antenna can be replaced by the user, but the use of a standard antenna jack or electrical connector is prohibited.

##### **FCC CFR Title 47 Part 15 Subpart C Section 15.247(c) (1)(i):**

(i) Systems operating in the 2400-2483.5 MHz band that is used exclusively for fixed. Point-to-point operations may employ transmitting antennas with directional gain greater than 6dBi provided the maximum conducted output power of the intentional radiator is reduced by 1 dB for every 3 dB that the directional gain of the antenna exceeds 6dBi.

#### Test Result:

The antenna is integral antenna, the best case gain of the antenna is 1.28dBi



## 4.2. Conducted Emission (AC Main)

### LIMIT

FCC CFR Title 47 Part 15 Subpart C Section 15.207

Frequency range (MHz)	Limit (dBuV)	
	Quasi-peak	Average
0.15-0.5	66 to 56*	56 to 46*
0.5-5	56	46
5-30	60	50

\* Decreases with the logarithm of the frequency.

### TEST CONFIGURATION

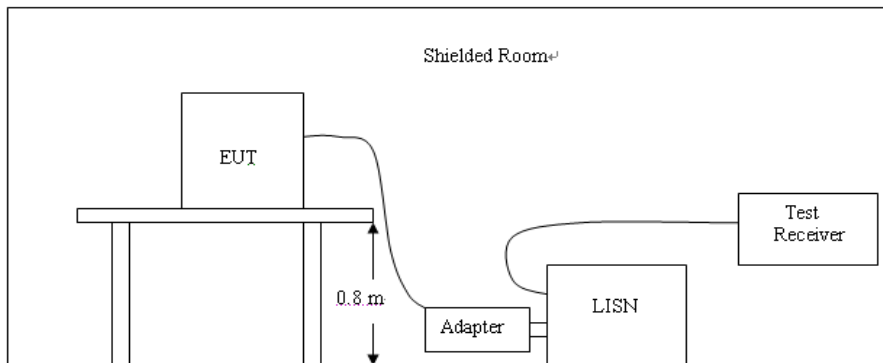

### TEST PROCEDURE

1. The equipment was set up as per the test configuration to simulate typical actual usage per the user's manual. The EUT is a tabletop system, a wooden table with a height of 0.8 meters is used and is placed on the ground plane as per ANSI C63.10-2009.
2. Support equipment, if needed, was placed as per ANSI C63.10-2009
3. All I/O cables were positioned to simulate typical actual usage as per ANSI C63.10-2009
4. The EUT received DC5V power from the adapter, the adapter received AC120V/60Hz power through a Line Impedance Stabilization Network (LISN) which supplied power source and was grounded to the ground plane.
5. All support equipments received AC power from a second LISN, if any.
6. The EUT test program was started. Emissions were measured on each current carrying line of the EUT using a spectrum Analyzer / Receiver connected to the LISN powering the EUT. The LISN has two monitoring points: Line 1 (Hot Side) and Line 2 (Neutral Side). Two scans were taken: one with Line 1 connected to Analyzer / Receiver and Line 2 connected to a 50 ohm load; the second scan had Line 1 connected to a 50 ohm load and Line 2 connected to the Analyzer / Receiver.
7. Analyzer / Receiver scanned from 150 KHz to 30MHz for emissions in each of the test modes.
8. During the above scans, the emissions were maximized by cable manipulation.

### TEST RESULTS

Test mode:	WIFI mode	Polarization	L
------------	-----------	--------------	---

**SCAN TABLE: "Voltage (9K-30M) FIN"**

Short Description: 150K-30M Voltage

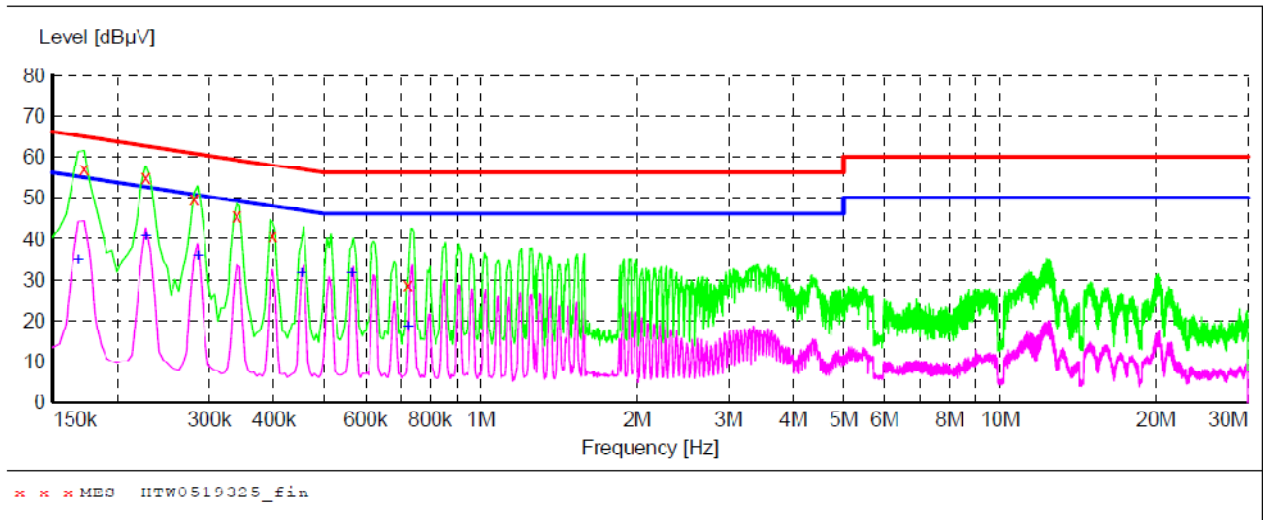

**MEASUREMENT RESULT: "HTW0519325\_fin"**

Frequency MHz	Level dBµV	Transd dB	Limit dBµV	Margin dB	Detector	Line	PE
0.172500	57.10	10.3	65	7.7	QP	L1	GND
0.226500	54.80	10.5	63	7.8	QP	L1	GND
0.280500	49.70	10.6	61	11.1	QP	L1	GND
0.339000	45.60	10.6	59	13.6	QP	L1	GND
0.397500	40.80	10.5	58	17.1	QP	L1	GND
0.726000	28.70	10.2	56	27.3	QP	L1	GND

**MEASUREMENT RESULT: "HTW0519325\_fin2"**

Frequency MHz	Level dBµV	Transd dB	Limit dBµV	Margin dB	Detector	Line	PE
0.168000	34.80	10.3	55	20.3	AV	L1	GND
0.226500	40.50	10.5	53	12.1	AV	L1	GND
0.285000	35.60	10.6	51	15.1	AV	L1	GND
0.451500	31.50	10.4	47	15.3	AV	L1	GND
0.564000	31.30	10.3	46	14.7	AV	L1	GND
0.726000	18.50	10.2	46	27.5	AV	L1	GND

Test mode:	WIFI mode	Polarization	N
------------	-----------	--------------	---

**SCAN TABLE: "Voltage (9K-30M) FIN"**

Short Description: 150K-30M Voltage

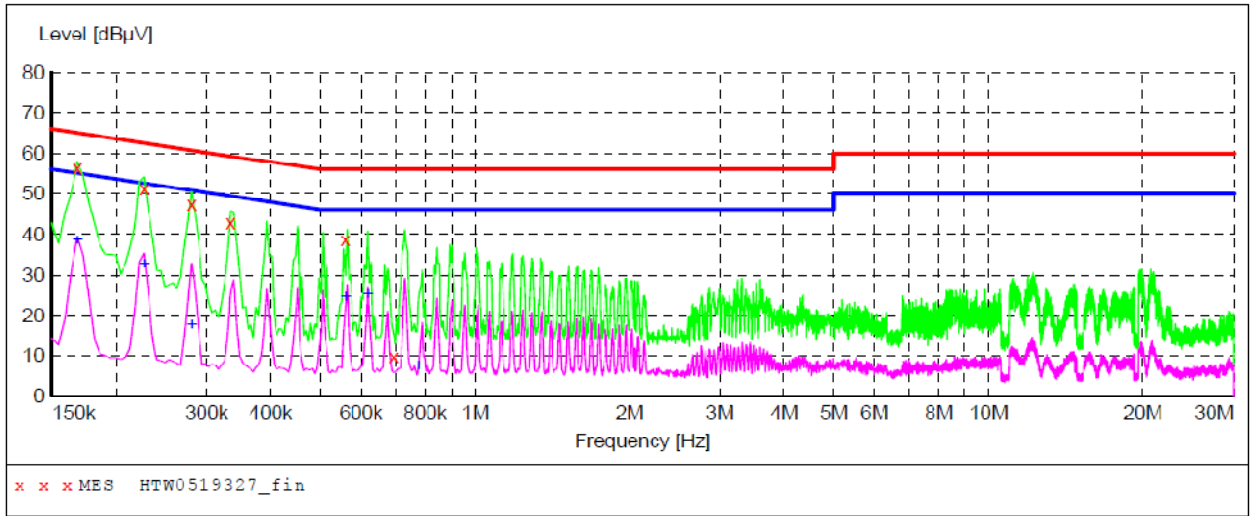

**MEASUREMENT RESULT: "HTW0519327\_fin"**

Frequency MHz	Level dBµV	Transd dB	Limit dBµV	Margin dB	Detector	Line	PE
0.168000	56.30	10.3	65	8.8	QP	N	GND
0.226500	51.20	10.5	63	11.4	QP	N	GND
0.280500	47.40	10.6	61	13.4	QP	N	GND
0.334500	42.90	10.6	59	16.4	QP	N	GND
0.559500	38.70	10.3	56	17.3	QP	N	GND
0.694500	9.70	10.3	56	46.3	QP	N	GND

**MEASUREMENT RESULT: "HTW0519327\_fin2"**

Frequency MHz	Level dBµV	Transd dB	Limit dBµV	Margin dB	Detector	Line	PE
0.168000	38.30	10.3	55	16.8	AV	N	GND
0.226500	32.70	10.5	53	19.9	AV	N	GND
0.280500	17.60	10.6	51	33.2	AV	N	GND
0.559500	24.40	10.3	46	21.6	AV	N	GND
0.618000	25.10	10.3	46	20.9	AV	N	GND
0.775500	7.40	10.2	46	38.6	AV	N	GND

### 4.3. Conducted Peak Output Power

**LIMIT**

FCC CFR Title 47 Part 15 Subpart C Section 15.247 (b)(3): **30dBm**

**TEST CONFIGURATION**



**TEST PROCEDURE**

1. The EUT was directly connected to the spectrum analyzer and antenna output port as show in the block diagram as TEST CONFIGURATION shows.
2. According to KDB558074 D01 V03 Integrated band power method for this procedure may be used when the maximum available RBW of the measurement instrument is less than the DTS bandwidth.  
RBW = 3 MHz, VBW =10 MHz, span =3 MHz, Detector = peak,
3. Allow trace to fully stabilize, use peak marker function to determine the peak amplitude level.

**TEST RESULTS**

Type	Channel	Output power (dBm)	Limit (dBm)	Result
802.11b	01	15.12	30.00	Pass
	06	14.57		
	11	14.67		
802.11g	01	18.66	30.00	Pass
	06	18.90		
	11	18.11		
802.11n(H20)	01	17.61	30.00	Pass
	06	17.55		
	11	17.31		

Test plot as follows:

### 802.11b



Ref 21 dBm      \*Att 30 dB      \*RBW 1 MHz  
Offset 1 dB      SWT 2.5 ms      \*VBW 3 MHz

1 PK  
MAXH

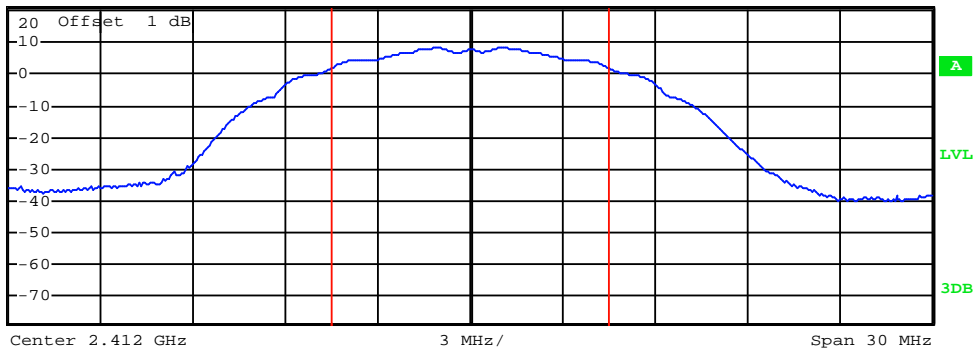

**Tx Channel**  
Bandwidth                      9 MHz      Power                      15.12 dBm

### CH01



Ref 21 dBm      \*Att 30 dB      \*RBW 1 MHz  
Offset 1 dB      SWT 2.5 ms      \*VBW 3 MHz

1 PK  
MAXH

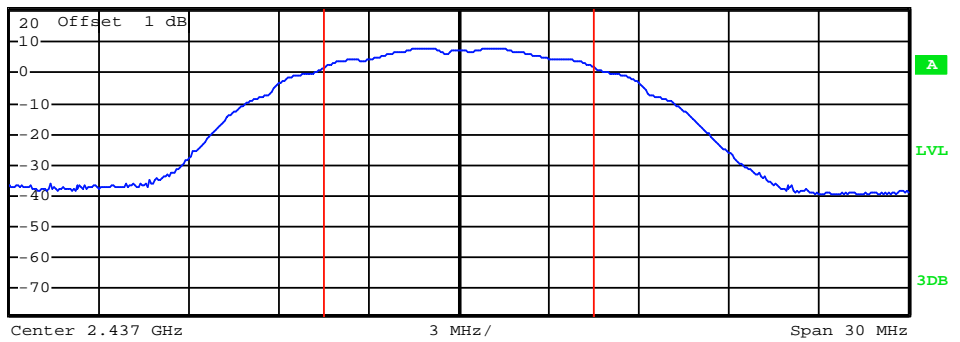

**Tx Channel**  
Bandwidth                      9 MHz      Power                      14.87 dBm

### CH06



Ref 21 dBm      \*Att 30 dB      \*RBW 1 MHz  
Offset 1 dB      SWT 2.5 ms      \*VBW 3 MHz

1 PK  
MAXH

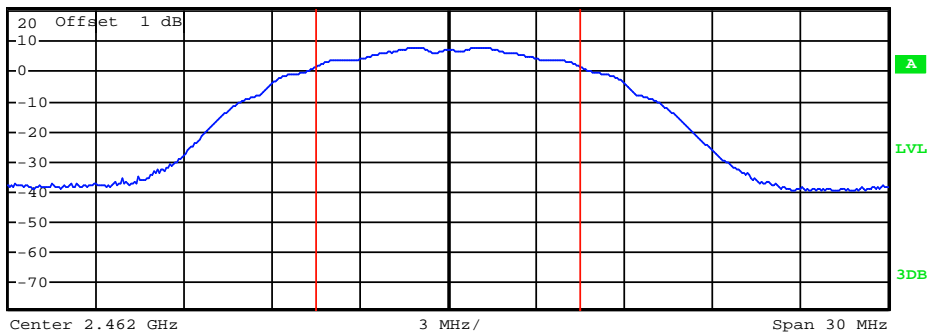

**Tx Channel**  
Bandwidth                      9 MHz      Power                      14.67 dBm

### CH11

### 802.11g

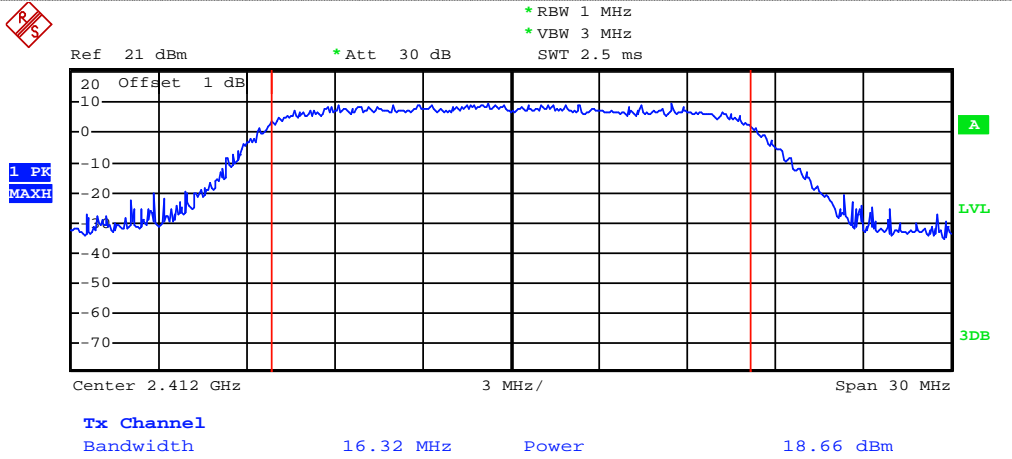

### CH01

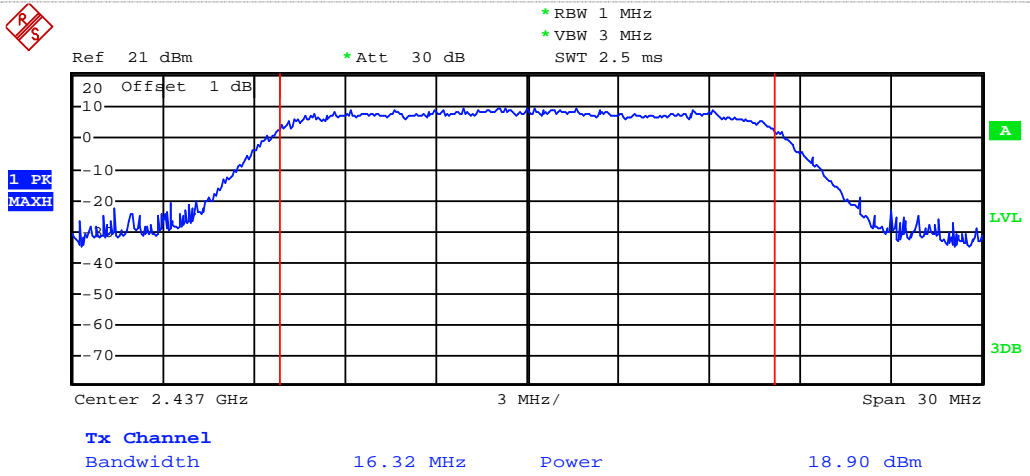

### CH06

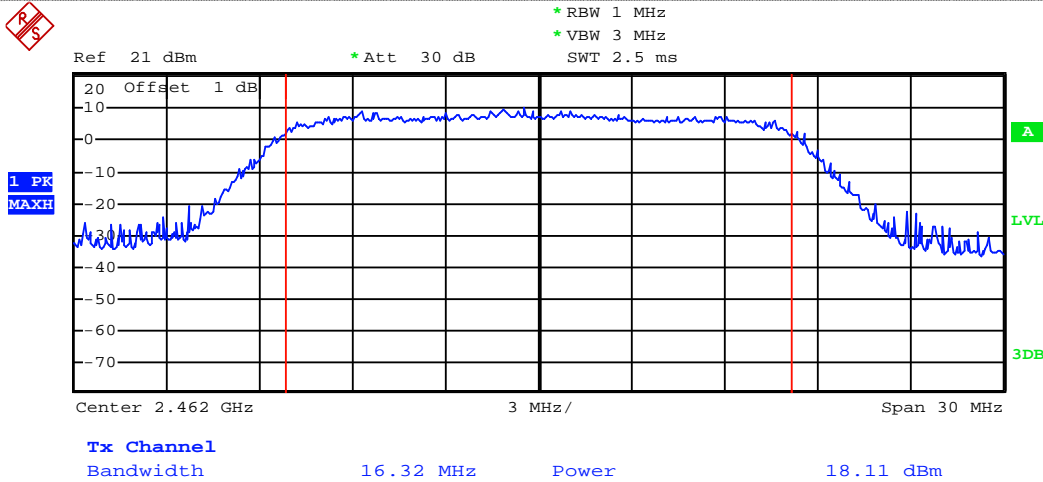

### CH11

### 802.11n(H20)

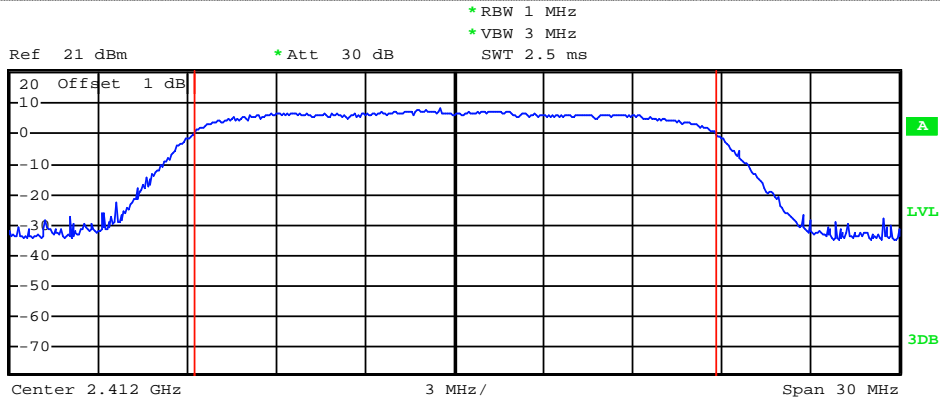

**Tx Channel**  
Bandwidth 17.58 MHz Power 17.61 dBm

### CH01

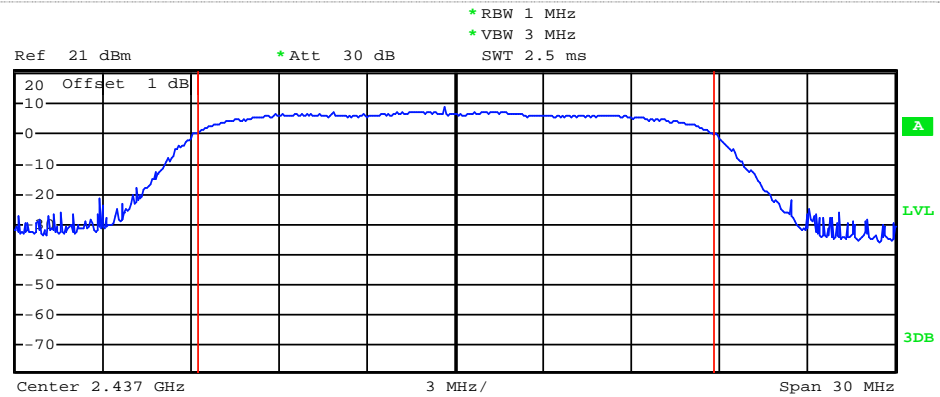

**Tx Channel**  
Bandwidth 17.58 MHz Power 17.55 dBm

### CH06

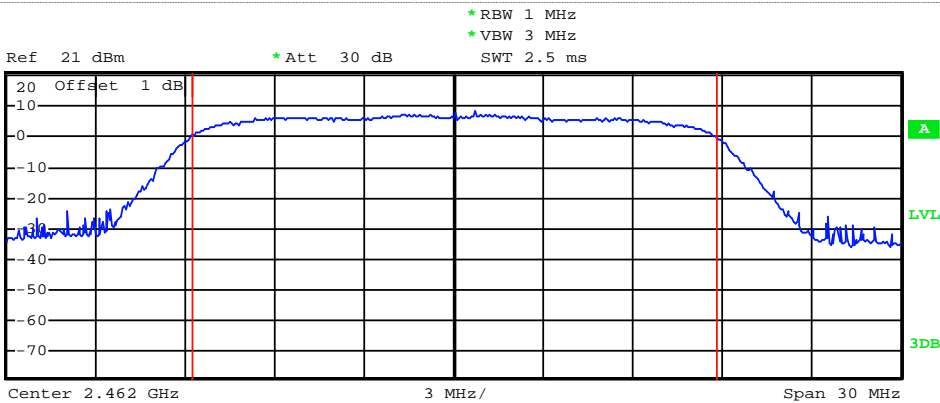

**Tx Channel**  
Bandwidth 17.58 MHz Power 17.31 dBm

### CH11



### 4.4. Power Spectral Density

#### LIMIT

FCC CFR Title 47 Part 15 Subpart C Section 15.247 (e): **8dBm/3KHz**

*For digitally modulated systems, the power spectral density conducted from the intentional radiator to the antenna shall not be greater than 8 dBm in any 3 kHz band during any time interval of continuous transmission.*

#### TEST CONFIGURATION



#### TEST PROCEDURE

1. According to KDB 558074 D01 V03 Method PKPSD (peak PSD) This procedure shall be used if maximum peak conducted output power was used to demonstrate compliance, and is optional if the maximum conducted (average) output power was used to demonstrate compliance.
2. Analyzer set:  
Center frequency =Channel center frequency  
RBW =3 kHz~100 kHz, VBW ≥3RBW, Detector=Peak, Span=1.5 times the bandwidth
3. Allow trace to fully stabilize, use the peak marker function to determine the maximum amplitude level within the RBW.
4. If measured value exceeds limit, reduce RBW (no less than 3 kHz) and repeat.

#### TEST RESULTS

Type	Channel	Power Spectral Density (dBm/3KHz)	Limit (dBm/3KHz)	Result
802.11b	01	-9.59	8.00	Pass
	06	-10.51		
	11	-10.74		
802.11g	01	-13.85	8.00	Pass
	06	-14.78		
	11	-13.77		
802.11n(H20)	01	-14.67	8.00	Pass
	06	-15.33		
	11	-16.52		

Test plot as follows:

### 802.11b

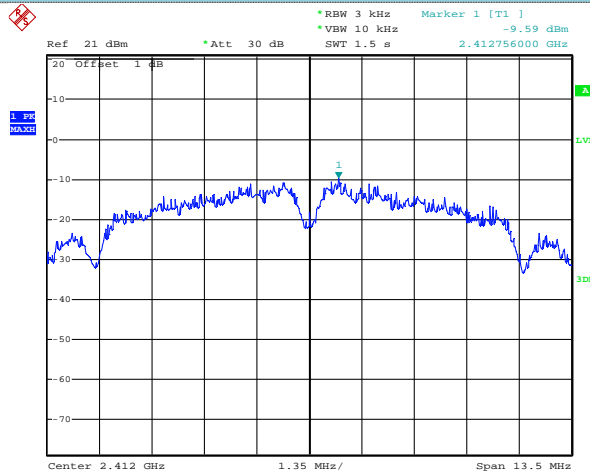

Date: 7.MAY.2014 16:24:45

### CH01

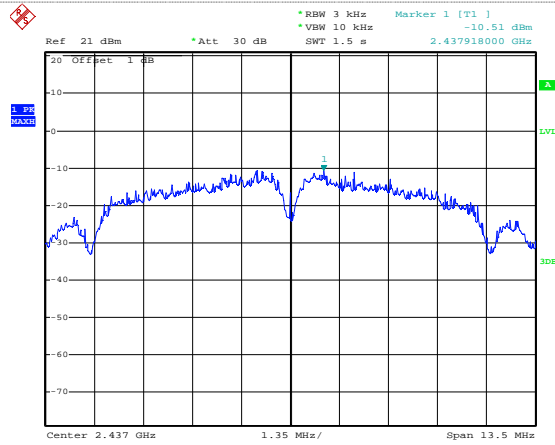

Date: 7.MAY.2014 16:25:10

### CH06

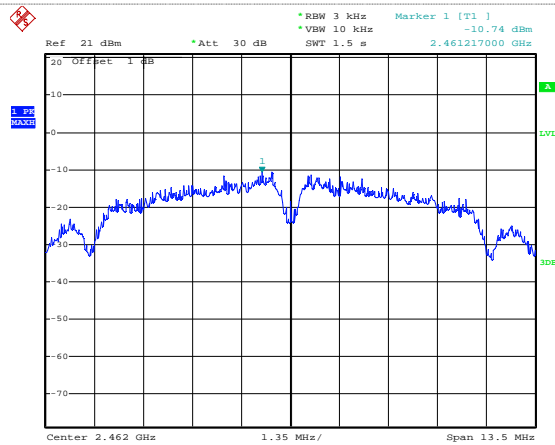

Date: 7.MAY.2014 16:25:26

### CH11

### 802.11g

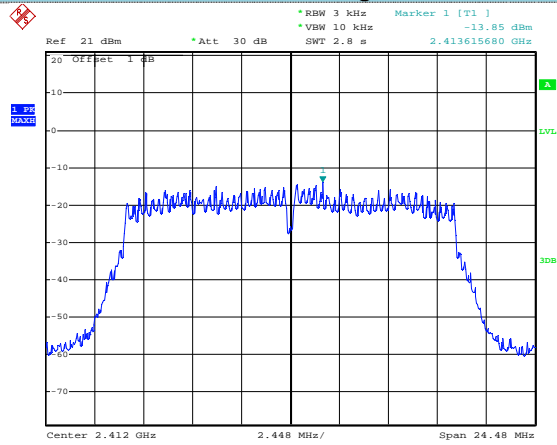

Date: 7.MAY.2014 16:26:33

### CH01

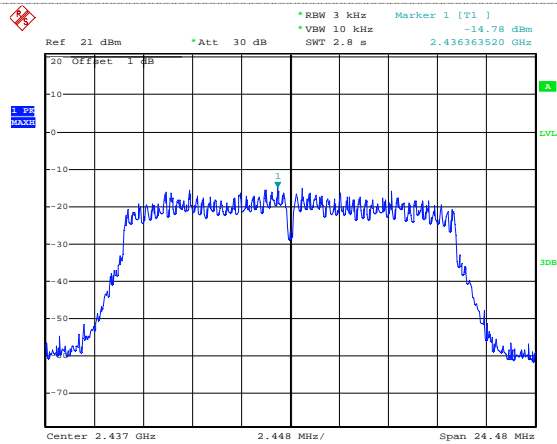

Date: 7.MAY.2014 16:26:50

### CH06

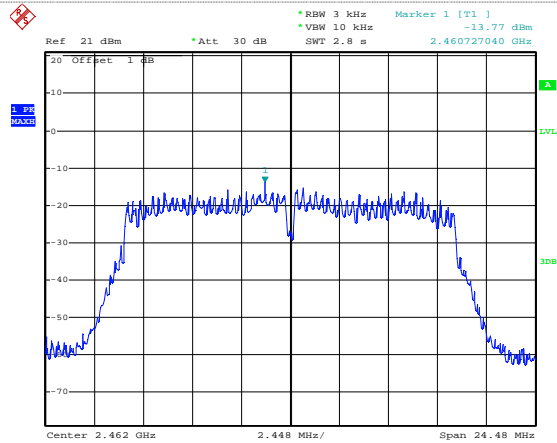

Date: 7.MAY.2014 16:27:05

### CH11

### 802.11n(H20)

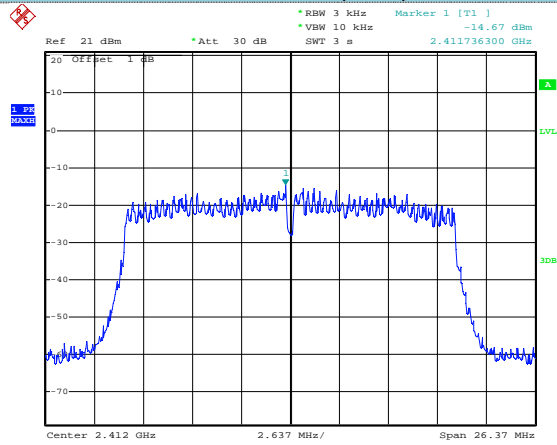

Date: 7.MAY.2014 16:27:53

### CH01

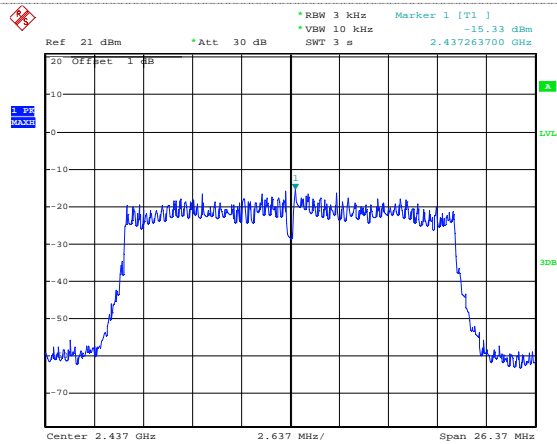

Date: 7.MAY.2014 16:28:09

### CH06

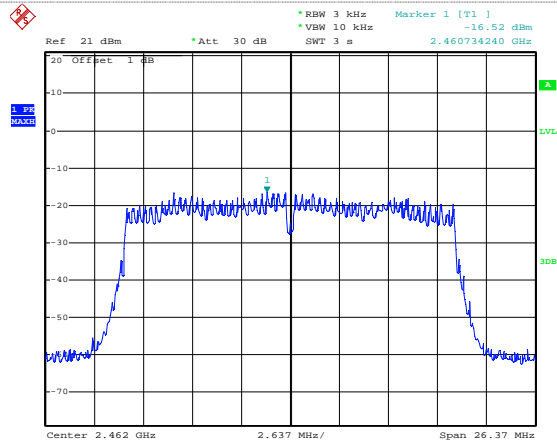

Date: 7.MAY.2014 16:28:33

### CH11

### 4.5. 6dB bandwidth

#### LIMIT

FCC CFR Title 47 Part 15 Subpart C Section 15.247 (a)(2): **500KHz**

*For digital modulation systems, the minimum 6 dB bandwidth shall be at least 500 kHz.*

#### TEST CONFIGURATION



#### TEST PROCEDURE

1. The transmitter output was connected to the spectrum analyzer through an attenuator. The bandwidth of the fundamental frequency was measured by spectrum analyzer
2. The 6dB bandwidth is defined as the total spectrum the power of which is higher than peak power minus 6dB.
3. According to KDB558074 D01 V03 for one of the following procedures may be used to determine the modulated DTS device signal bandwidth.  
Center frequency =Channel center frequency  
RBW =100 kHz, VBW ≥3RBW, Detector=Peak,
4. Allow the trace to stabilize.
5. Measure the maximum width of the emission that is constrained by the frequencies associated with the two outermost amplitude points (upper and lower frequencies) that are attenuated by 6 dB relative to the maximum level measured in the fundamental emission.

#### TEST RESULTS

Type	Channel	6dB Bandwidth (MHz)	Limit (KHz)	Result
802.11b	01	9.00	≥500	Pass
	06	9.00		
	11	9.00		
802.11g	01	16.32	≥500	Pass
	06	16.32		
	11	16.32		
802.11n(H20)	01	17.58	≥500	Pass
	06	17.52		
	11	17.52		

Test plot as follows:

### 802.11b

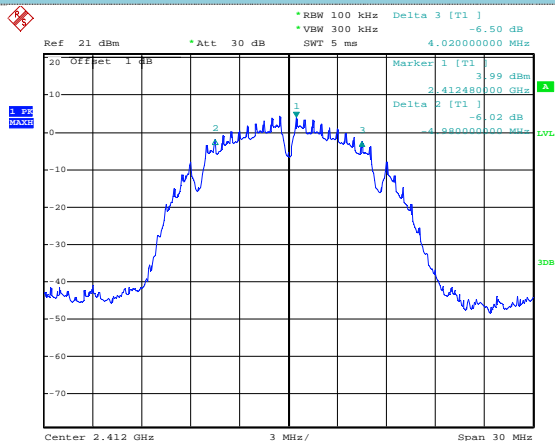

Date: 7.MAY.2014 16:11:10

### CH01

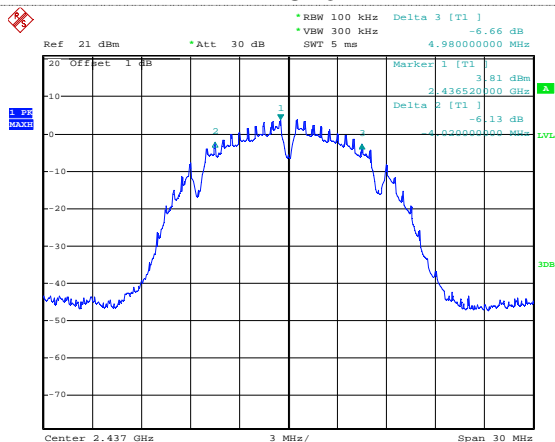

Date: 7.MAY.2014 16:12:49

### CH06

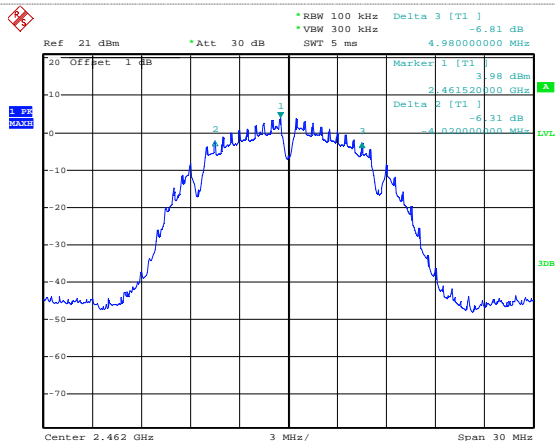

Date: 7.MAY.2014 16:13:37

### CH11

### 802.11g

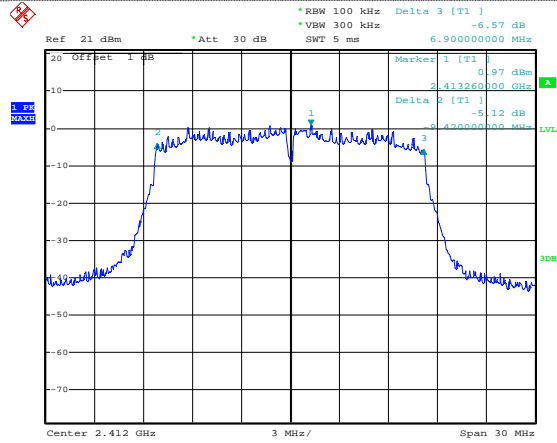

Date: 7.MAY.2014 16:14:56

### CH01

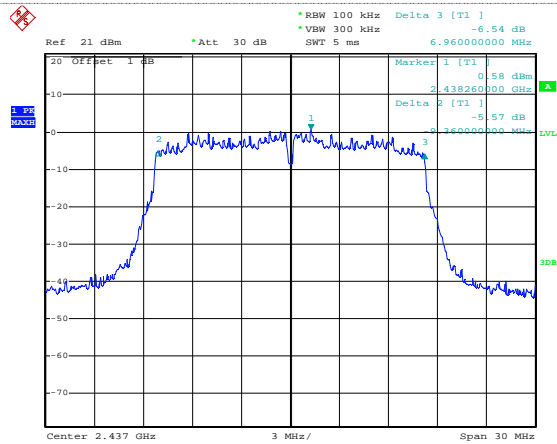

Date: 7.MAY.2014 16:15:33

### CH06

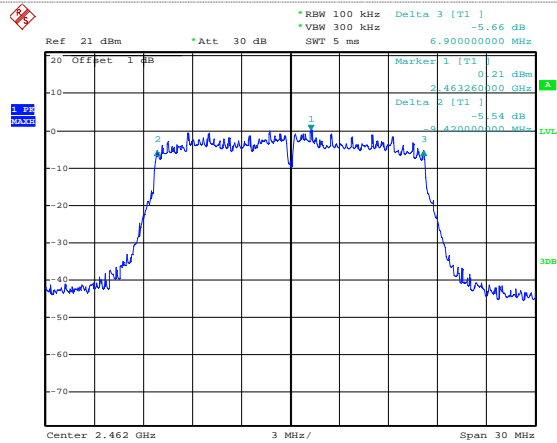

Date: 7.MAY.2014 16:15:53

### CH11

### 802.11n(H20)

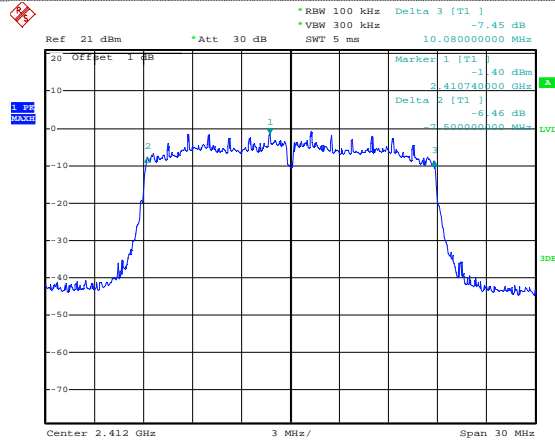

Date: 7.MAY.2014 16:16:44

### CH01

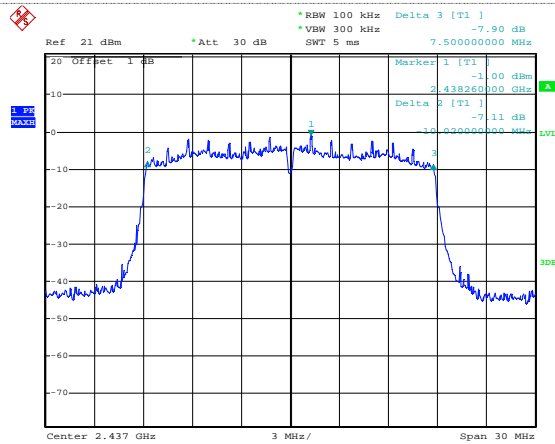

Date: 7.MAY.2014 16:17:17

### CH06

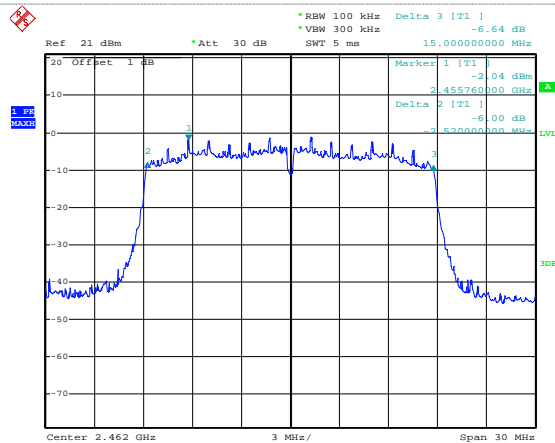

Date: 7.MAY.2014 16:17:55

### CH11



## 4.6. Band Edge

### LIMIT

FCC CFR Title 47 Part 15 Subpart C Section 15.247 (d):

*In any 100 kHz bandwidth outside the frequency band in which the spread spectrum or digitally modulated intentional radiator is operating, the radio frequency power that is produced by the intentional radiator shall be at least 20 dB below that in the 100 kHz bandwidth within the band that contains the highest level of the desired power, based on either an RF conducted or a radiated measurement, provided the transmitter demonstrates compliance with the peak conducted power limits. If the transmitter complies with the conducted power limits based on the use of RMS averaging over a time interval, as permitted under paragraph (b)(3) of this section, the attenuation required under this paragraph shall be 30 dB instead of 20 dB. Attenuation below the general limits specified in §15.209(a) is not required. In addition, radiated emissions which fall in the restricted bands, as defined in §15.205(a), must also comply with the radiated emission limits specified in §15.209(a) (see §15.205(c)).*

### TEST CONFIGURATION



### TEST PROCEDURE

1. According to KDB 558074 D01 V03 for Antenna-port conducted measurement. Antenna-port conducted measurements may also be used as an alternative to radiated measurements for demonstrating compliance in the restricted frequency bands. If conducted measurements are performed, then proper impedance matching must be ensured and an additional radiated test for cabinet/case spurious emissions is required.
2. Remove the antenna from the EUT and then connect to a low loss RF cable from the antenna port to a EMI test receiver, then turn on the EUT and make it operate in transmitting mode. Then set it to Low Channel and High Channel within its operating range, and make sure the instrument is operated in its linear range.
3. Set both RBW and VBW of spectrum analyzer to 100 kHz with a convenient frequency span including 100kHz bandwidth from band edge, for Radiated emissions restricted band RBW=1MHz, VBW=3MHz for peak detector and RBW=1MHz, VBW=10Hz for average detector.
4. Measure the highest amplitude appearing on spectral display and set it as a reference level. Plot the graph with marking the highest point and edge frequency.
5. Repeat above procedures until all measured frequencies were complete.
6. Measure the conducted output power (in dBm) using the detector specified by the appropriate regulatory agency
7. Add the maximum transmit antenna gain (in dBi) to the measured output power level to determine the EIRP level
8. Add the appropriate maximum ground reflection factor to the EIRP level (6 dB for frequencies  $\leq 30$  MHz, 4.7 dB for frequencies between 30 MHz and 1000 MHz, inclusive and 0 dB for frequencies  $> 1000$  MHz).
9. For devices with multiple antenna-ports, measure the power of each individual chain and sum the EIRP of all chains in linear terms (e.g., Watts, mW).
10. Convert the resultant EIRP level to an equivalent electric field strength using the following relationship:  

$$E = \text{EIRP} - 20\log D + 104.8$$
 where:  
 E = electric field strength in dB $\mu$ V/m,  
 EIRP = equivalent isotropic radiated power in dBm  
 D = specified measurement distance in meters.
11. Since the out-of-band characteristics of the EUT transmit antenna will often be unknown, the use of a conservative antenna gain value is necessary. Thus, when determining the EIRP based on the measured conducted power, the upper bound on antenna gain for a device with a single RF output shall be selected as the maximum in-band gain of the antenna across all operating bands, or 2 dBi, whichever is greater. However, for devices that operate in multiple frequency bands while using the same transmit antenna, the highest gain of the antenna within the operating band nearest in frequency to the restricted band emission being measured may be used in lieu of the overall highest gain when the emission is at a frequency that is within 20 percent of the nearest band edge frequency, but in no case shall a value less than 2 dBi be used.
12. Compare the resultant electric field strength level to the applicable regulatory limit.
13. Perform radiated spurious emission test dures until all measured frequencies were complete.

### TEST RESULTS

4.5.1 802.11b Test Mode

A. Test Verdict

Frequency (MHz)	Conducted Power (dBm)	Antenna Gain (dBi)	Ground Reflection Factor (dB)	Covert Radiated E Level At 3m (dBuV/m)	Detector	Limit (dBuV/m)	Refer to Plot
2390.00	-44.96	2.00	0.00	52.30	Peak	74.00	Plot 4.5.1 A1
2390.00	-55.52	2.00	0.00	41.74	AV	54.00	Plot 4.5.1 A2
2413.08	8.31	2.00	0.00	105.57	Peak	---	Plot 4.5.1 A1
2411.28	3.77	2.00	0.00	101.03	AV	---	Plot 4.5.1 A2
2463.08	7.79	2.00	0.00	105.05	Peak	---	Plot 4.5.1 A3
2461.28	3.15	2.00	0.00	100.41	AV	---	Plot 4.5.1 A4
2483.50	-45.26	2.00	0.00	52.00	Peak	74.00	Plot 4.5.1 A3
2483.50	-57.21	2.00	0.00	40.05	AV	54.00	Plot 4.5.1 A4

- Note: 1. For 802.11b mode at final test to get the worst-case emission at 1Mbps.  
 2. The test results including the cable lose.  
 3. "----" means that the fundamental frequency not for 15.209 limits requirement.

B. Test Plots

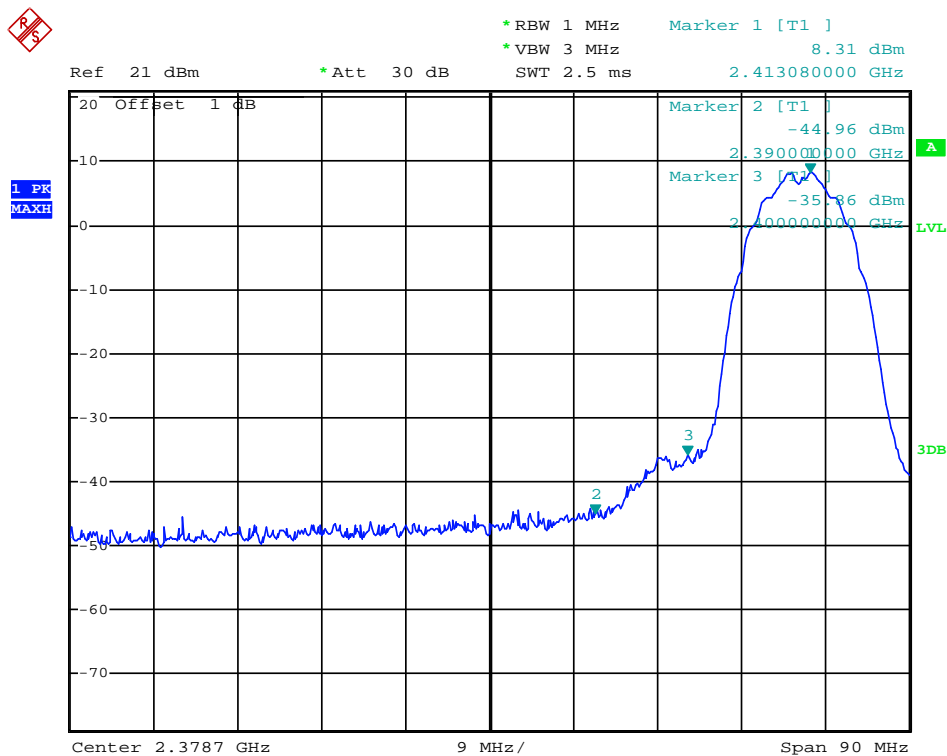

Date: 7.MAY.2014 16:39:16

(Plot 4.5.1 A1: Channel 1: 2412MHz @ 802.11b)

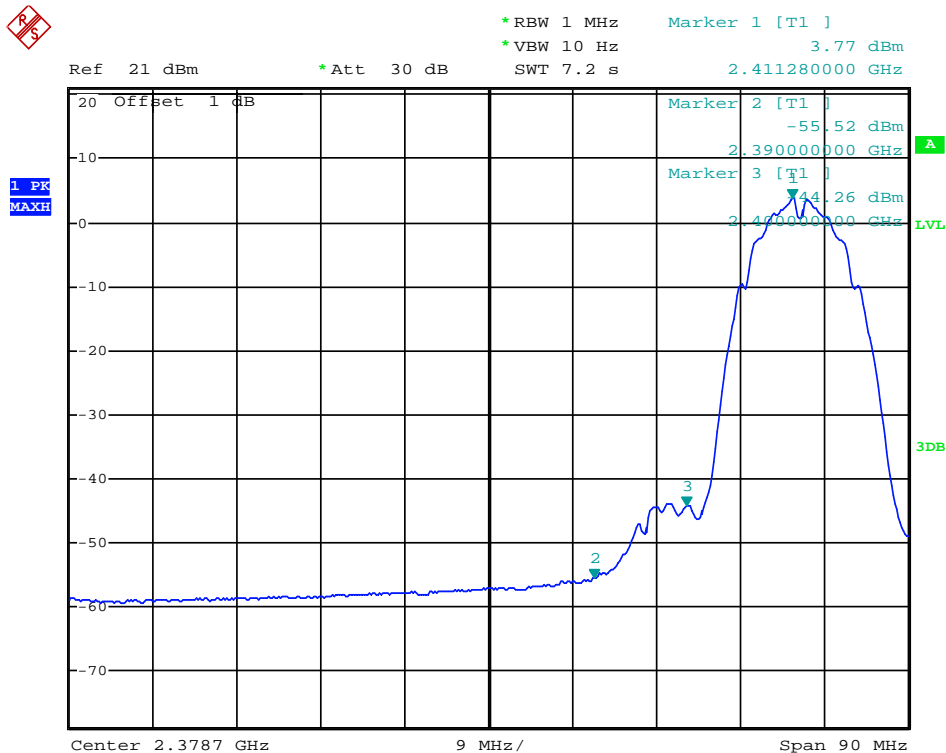

Date: 7.MAY.2014 16:39:37

(Plot 4.5.1 A2: Channel 1: 2412MHz @ 802.11b)

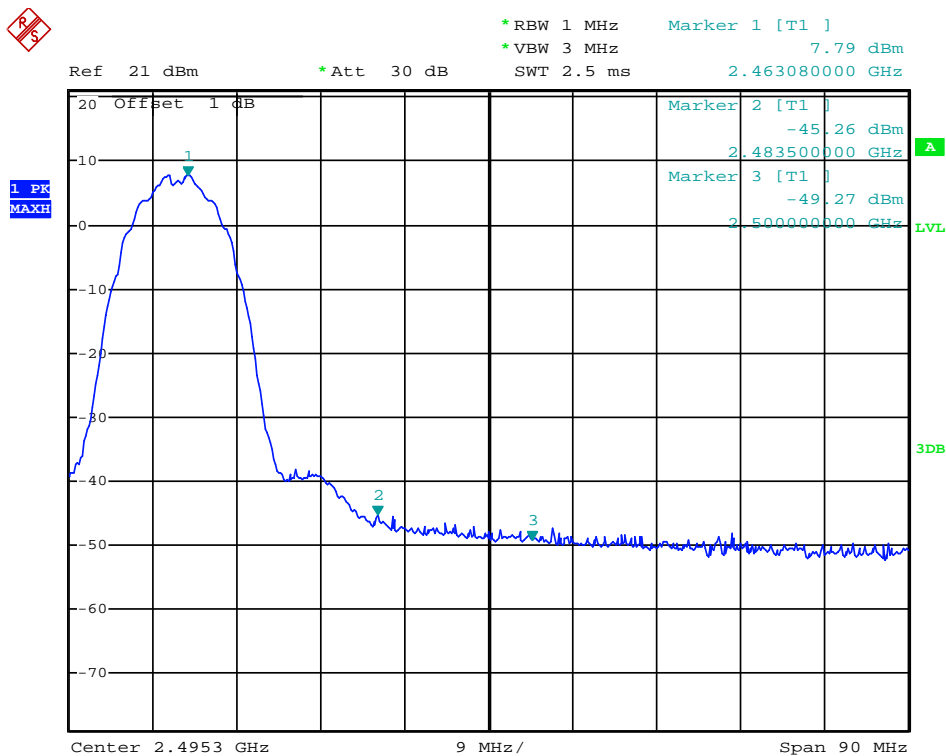

Date: 7.MAY.2014 16:44:41

(Plot 4.5.1 A3: Channel 11: 2462MHz @ 802.11b)

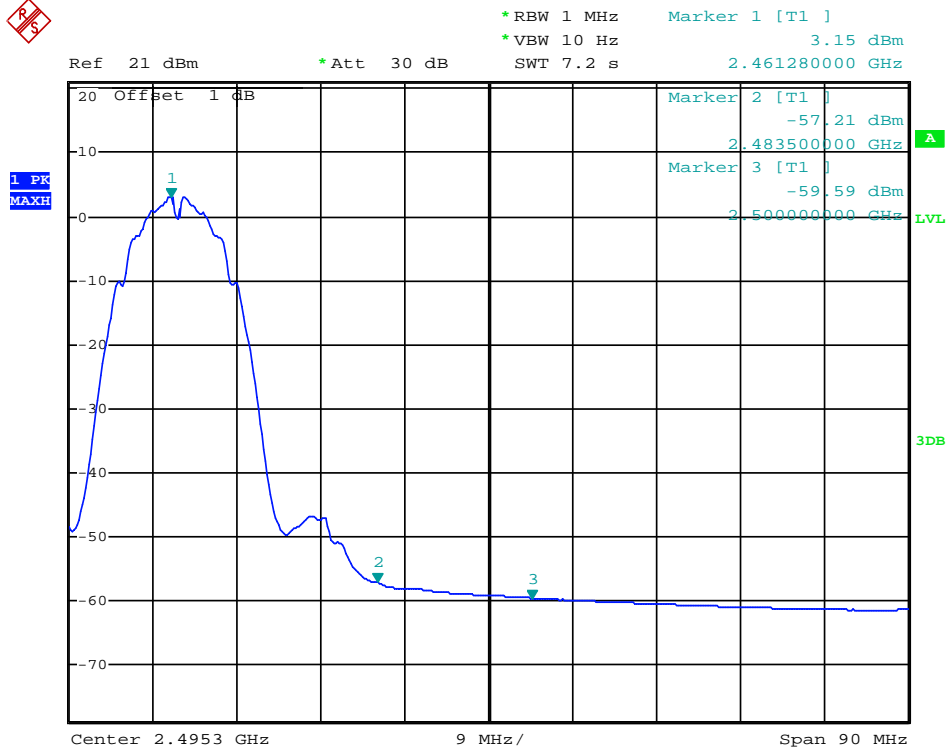

Date: 7.MAY.2014 16:44:55

(Plot 4.5.1 A4: Channel 11: 2462MHz @ 802.11b)

### 4.5.2 802.11g Test Mode

#### A. Test Verdict

Frequency (MHz)	Conducted Power (dBm)	Antenna Gain (dBi)	Ground Reflection Factor (dB)	Covert Radiated E Level At 3m (dBuV/m)	Detector	Limit (dBuV/m)	Refer to Plot
2390.00	-36.21	2.00	0.00	61.05	Peak	74.00	Plot 4.5.2 A1
2390.00	-51.28	2.00	0.00	45.98	AV	54.00	Plot 4.5.2 A2
2412.28	9.95	2.00	0.00	107.21	Peak	---	Plot 4.5.2 A1
2412.90	-11.72	2.00	0.00	85.54	AV	---	Plot 4.5.2 A2
2461.82	10.37	2.00	0.00	107.63	Peak	---	Plot 4.5.2 A3
2462.72	-12.24	2.00	0.00	85.02	AV	---	Plot 4.5.2 A4
2483.50	-35.29	2.00	0.00	61.97	Peak	74.00	Plot 4.5.2 A3
2483.50	-52.95	2.00	0.00	44.31	AV	54.00	Plot 4.5.2 A4

Note: 1. For 802.11g mode at final test to get the worst-case emission at 6Mbps.  
 2. The test results including the cable lose.  
 3. “---” means that the fundamental frequency not for 15.209 limits requirement.

#### B. Test Plots

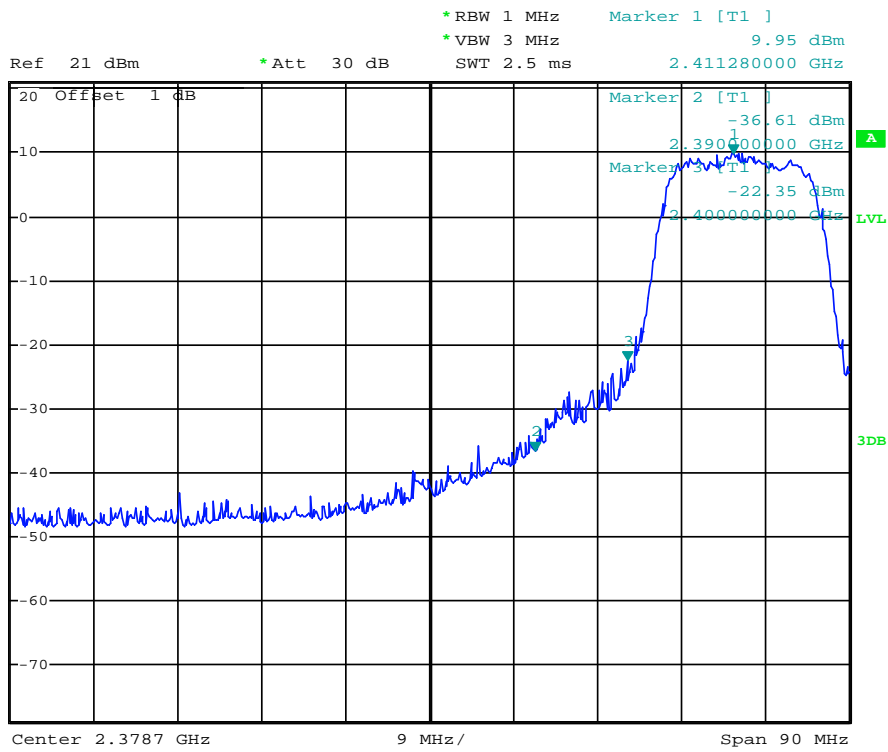

Date: 7.MAY.2014 16:40:18

(Plot 4.5.2 A1: Channel 1: 2412MHz @ 802.11g)

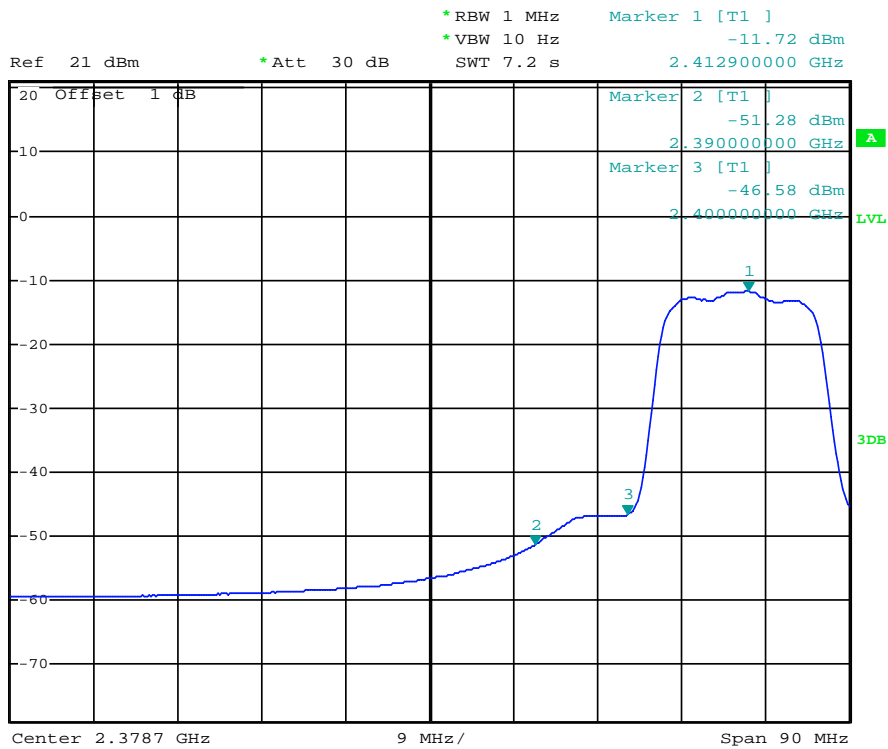

Date: 7.MAY.2014 16:41:03

(Plot 4.5.2 A2: Channel 1: 2412MHz @ 802.11g)

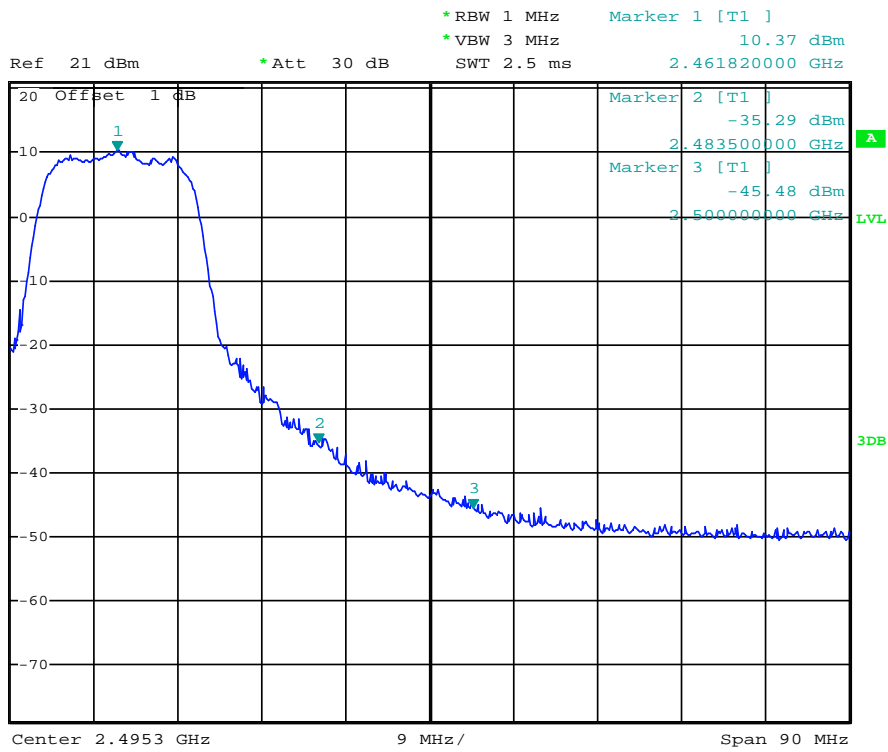

Date: 7.MAY.2014 16:46:53

(Plot 4.5.2 A3: Channel 11: 2462MHz @ 802.11g)

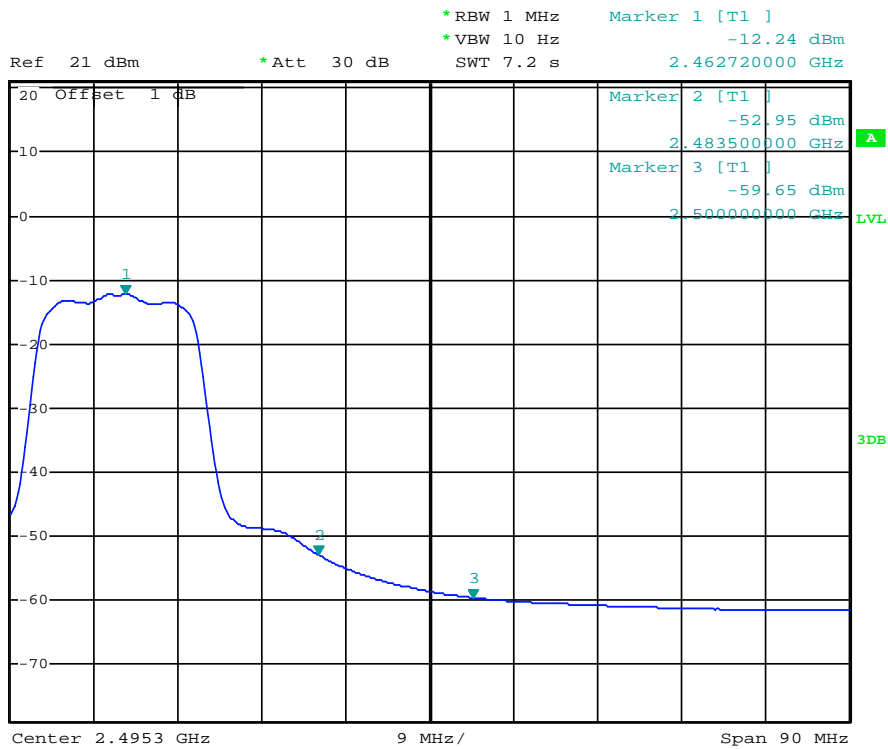

Date: 7.MAY.2014 16:47:18

(Plot 4.5.2 A4: Channel 11: 2462MHz @ 802.11g)

4.5.3 802.11n(20MHz) Test Mode

A. Test Verdict

Frequency (MHz)	Conducted Power (dBm)	Antenna Gain (dBi)	Ground Reflection Factor (dB)	Covert Radiated E Level At 3m (dBuV/m)	Detector	Limit (dBuV/m)	Refer to Plot
2390.00	-37.21	2.00	0.00	60.05	Peak	74.00	Plot 4.5.3 A1
2390.00	-50.30	2.00	0.00	46.96	AV	54.00	Plot 4.5.3 A2
2408.58	7.66	2.00	0.00	104.92	Peak	---	Plot 4.5.3 A1
2411.10	-4.36	2.00	0.00	92.90	AV	---	Plot 4.5.3 A2
2461.64	7.87	2.00	0.00	105.13	Peak	---	Plot 4.5.3 A3
2460.92	-4.89	2.00	0.00	92.37	AV	---	Plot 4.5.3 A4
2483.50	-39.51	2.00	0.00	57.75	Peak	74.00	Plot 4.5.3 A3
2483.50	-52.77	2.00	0.00	44.49	AV	54.00	Plot 4.5.3 A4

- Note: 1. For 802.11n(20MHz) mode at final test to get the worst-case emission at 6.5Mbps.  
 2. The test results including the cable lose.  
 3. "----" means that the fundamental frequency not for 15.209 limits requirement.

B. Test Plots

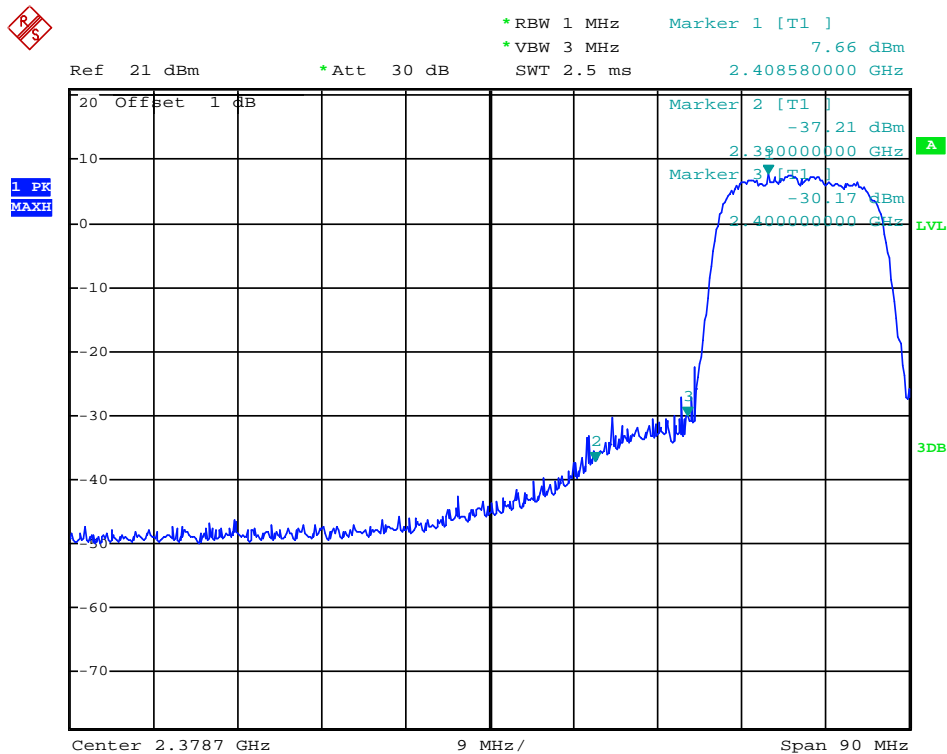

Date: 7.MAY.2014 16:41:52

(Plot 4.5.3 A1: Channel 1: 2412MHz @ 802.11n(20MHz))

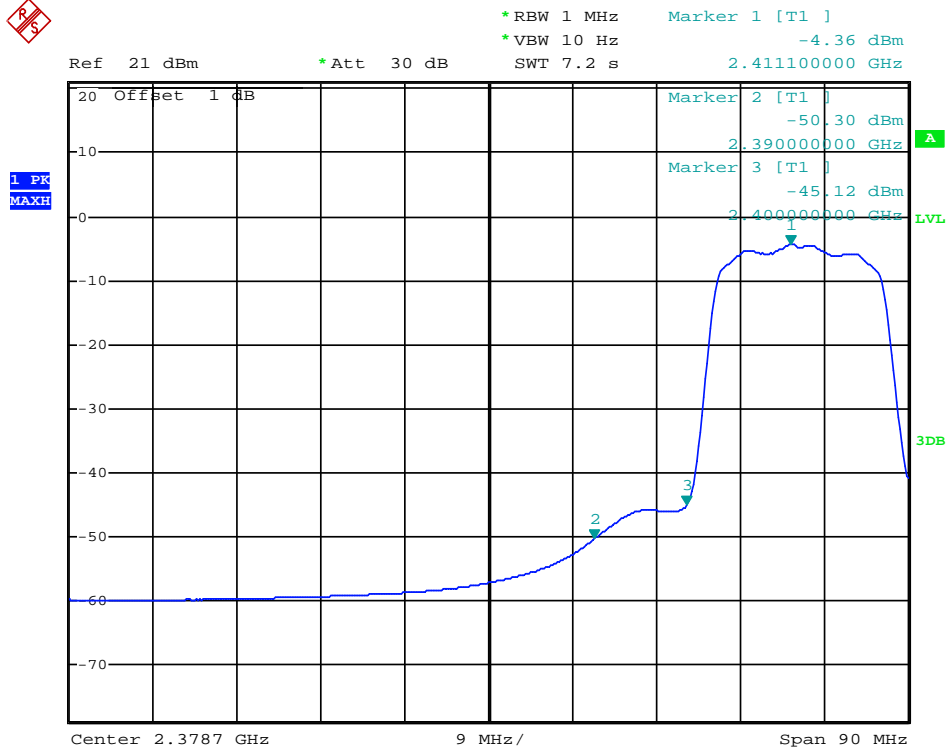

Date: 7.MAY.2014 16:42:10

(Plot 4.5.3 A2: Channel 1: 2412MHz @ 802.11n(20MHz))

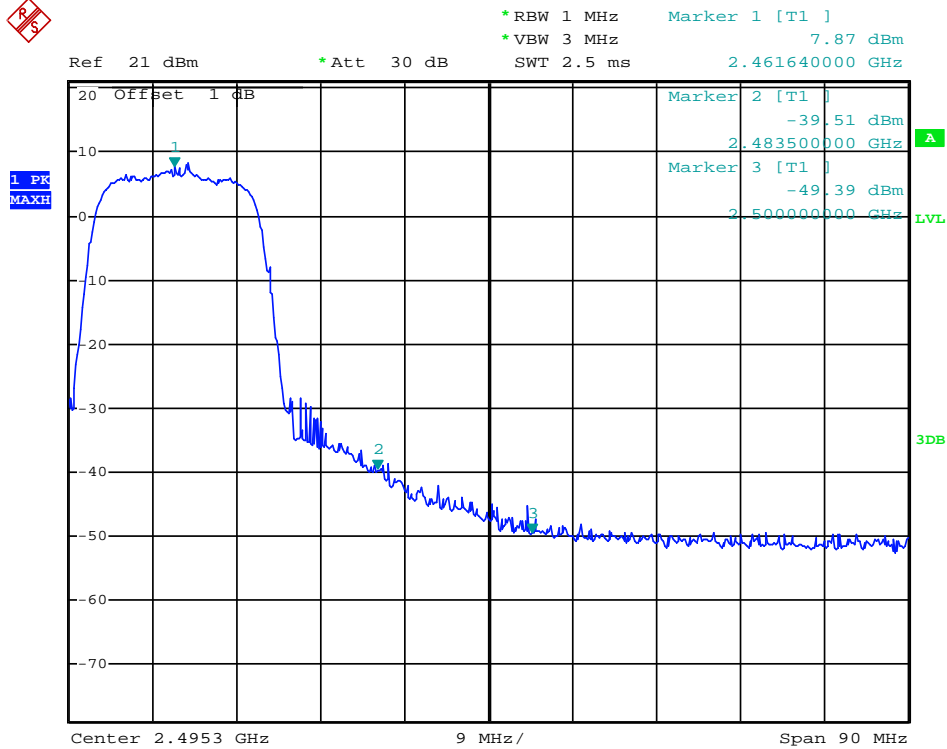

Date: 7.MAY.2014 16:43:42

(Plot 4.5.3 A3: Channel 11: 2462MHz @ 802.11n(20MHz))





\*RBW 1 MHz      Marker 1 [T1 ]  
\*VBW 10 Hz      -4.89 dBm  
SWT 7.2 s      2.460920000 GHz

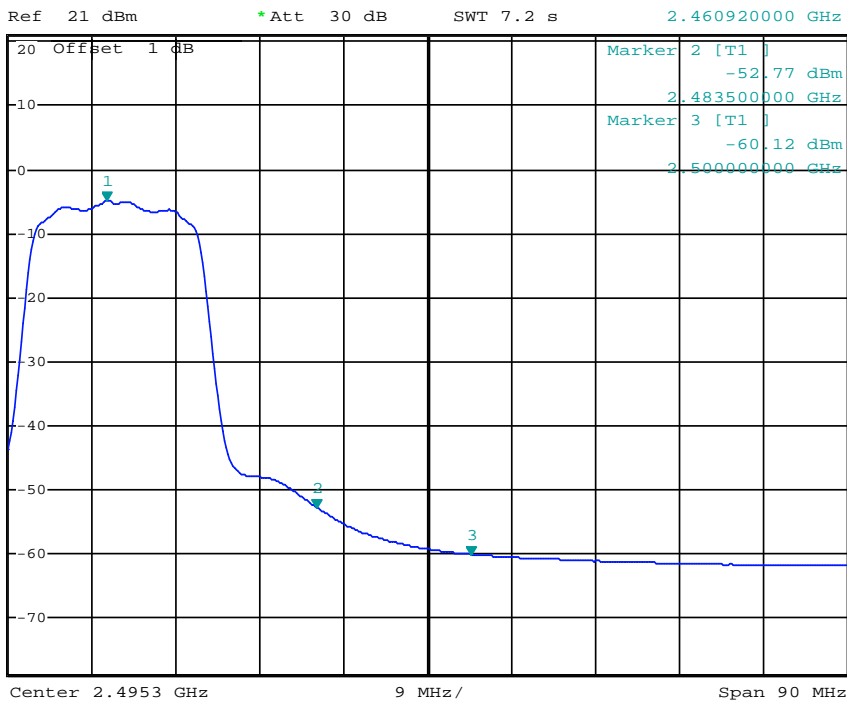

Date: 7.MAY.2014 16:43:58

(Plot 4.5.3 A4: Channel 11: 2462MHz @ 802.11n(20MHz))

## 4.7. Spurious Emission (conducted)

### LIMIT

FCC CFR Title 47 Part 15 Subpart C Section 15.247 (d):

*In any 100 kHz bandwidth outside the frequency band in which the spread spectrum intentional radiator is operating, the radio frequency power that is produced by the intentional radiator shall be at least 20 dB below that in the 100 kHz bandwidth within the band that contains the highest level of the desired power, based on either an RF conducted or a radiated measurement.*

### TEST CONFIGURATION



### TEST PROCEDURE

1. The transmitter output was connected to the spectrum analyzer through an attenuator.
2. The bandwidth of the fundamental frequency was measured by spectrum analyzer with RBW=100 KHz and VBW=300KHz.
3. Below -20dB of the highest emission level in operating band.

### TEST RESULTS

Test plot as follows:

### 802.11b mode

Test channel :

01

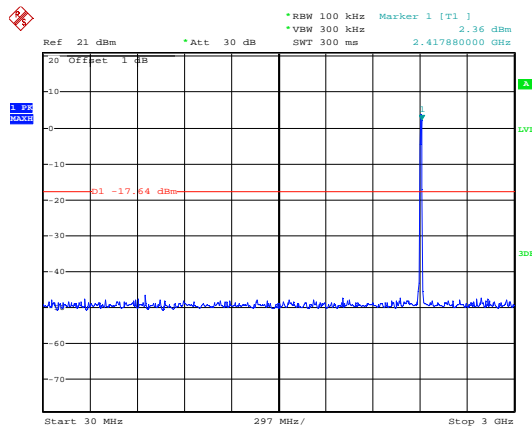

Date: 7.MAY.2014 16:30:05

### 30MHz~3GHz

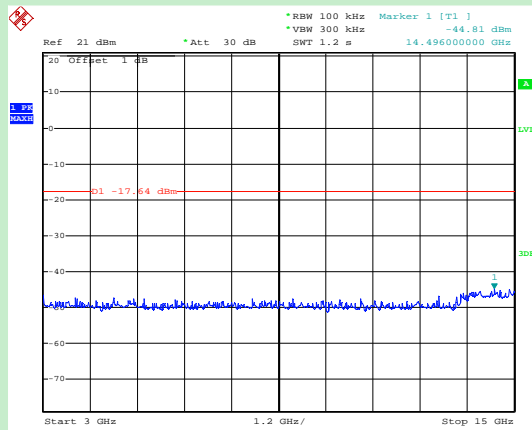

Date: 7.MAY.2014 16:30:17

### 3GHz~15GHz

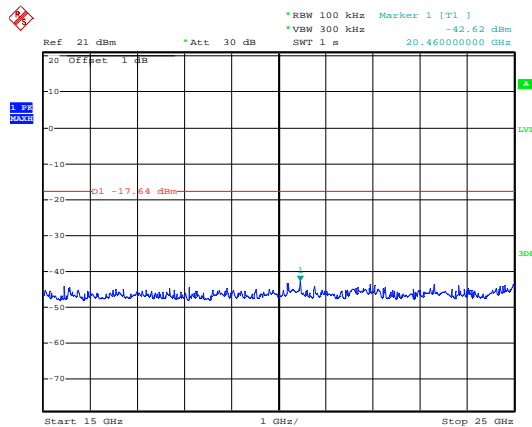

Date: 7.MAY.2014 16:30:28

### 15GHz~25GHz

Test channel :

06

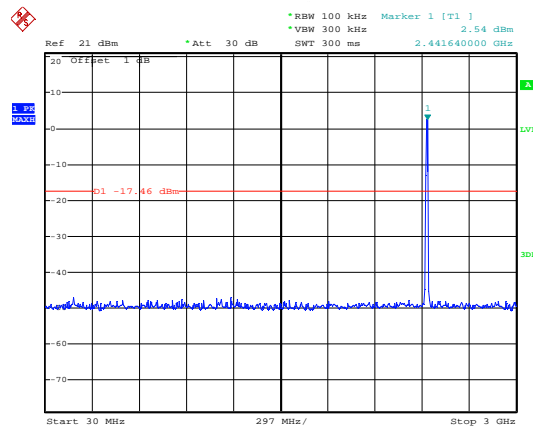

Date: 7.MAY.2014 16:30:58

### 30MHz~3GHz

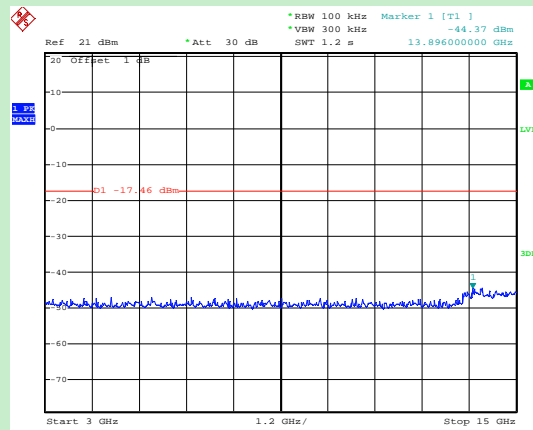

Date: 7.MAY.2014 16:31:24

### 3GHz~15GHz

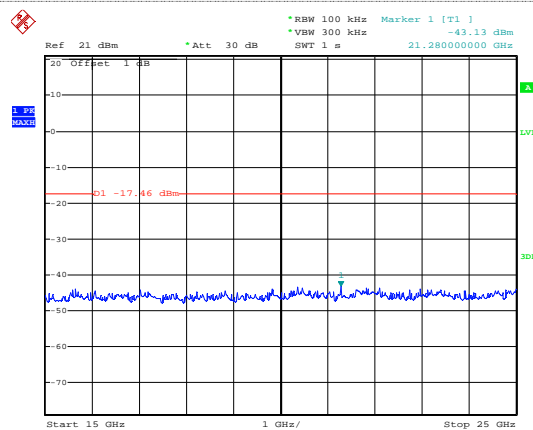

Date: 7.MAY.2014 16:31:35

### 15GHz~25GHz

Test channel :

11

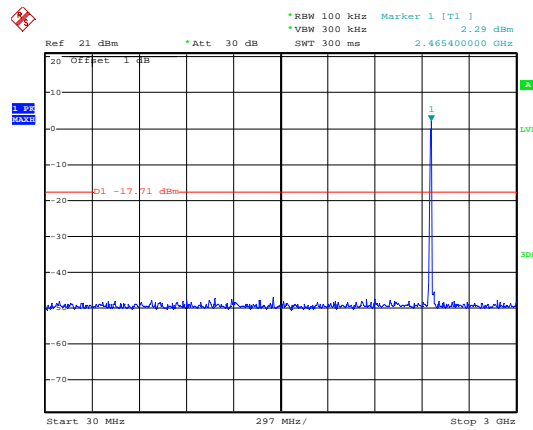

Date: 7.MAY.2014 16:32:08

### 30MHz~3GHz

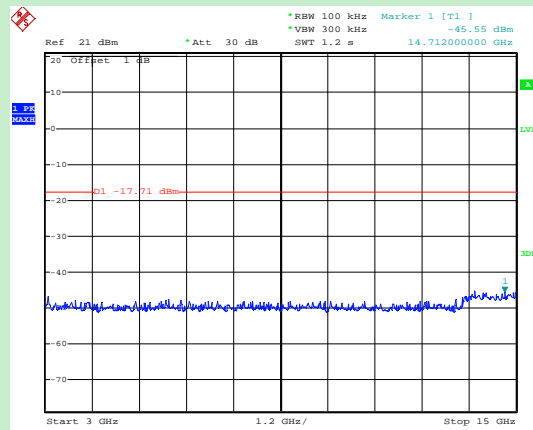

Date: 7.MAY.2014 16:32:18

### 3GHz~15GHz

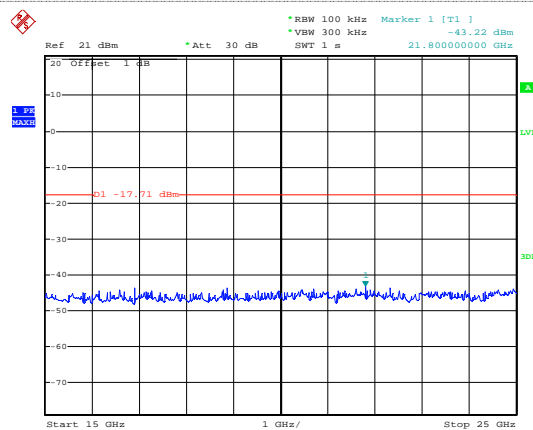

Date: 7.MAY.2014 16:32:30

### 15GHz~25GHz

### 802.11g mode

Test channel :

01

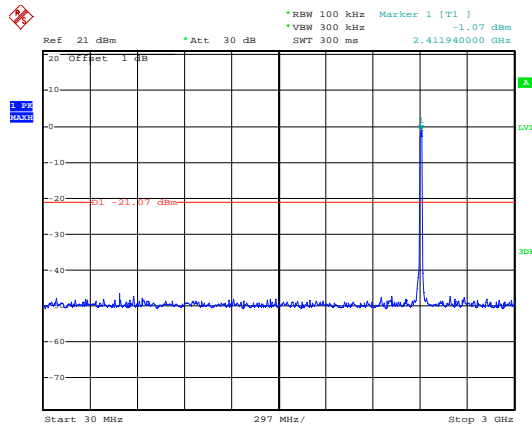

Date: 7.MAY.2014 16:32:55

### 30MHz~3GHz

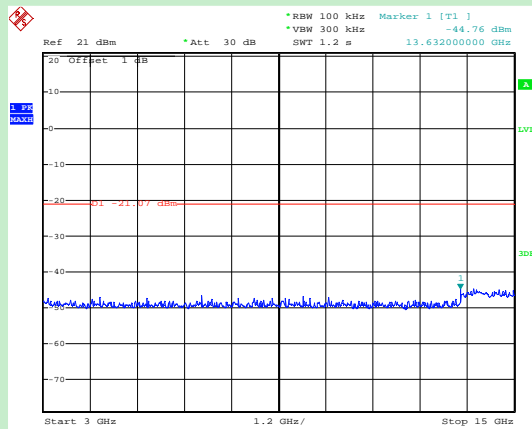

Date: 7.MAY.2014 16:33:15

### 3GHz~15GHz

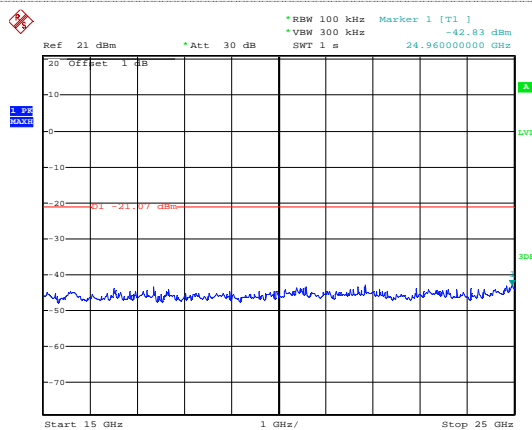

Date: 7.MAY.2014 16:33:29

### 15GHz~25GHz

Test channel :

06

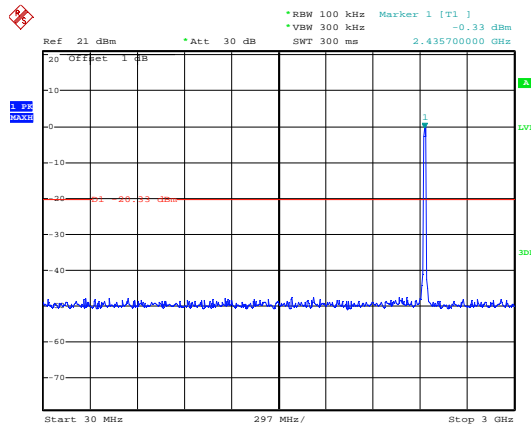

Date: 7.MAY.2014 16:33:57

### 30MHz~3GHz

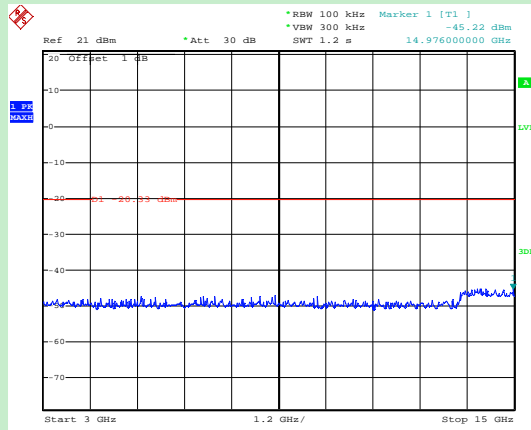

Date: 7.MAY.2014 16:34:18

### 3GHz~15GHz

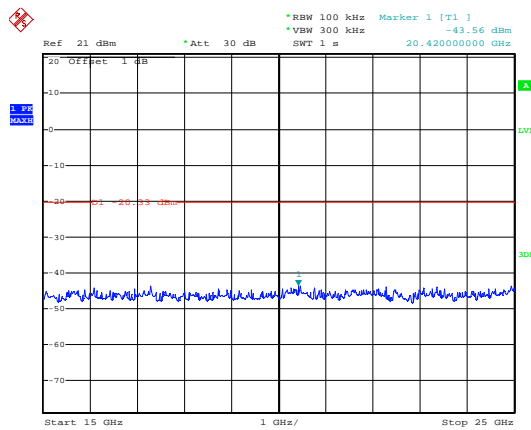

Date: 7.MAY.2014 16:34:26

### 15GHz~25GHz

Test channel :

11

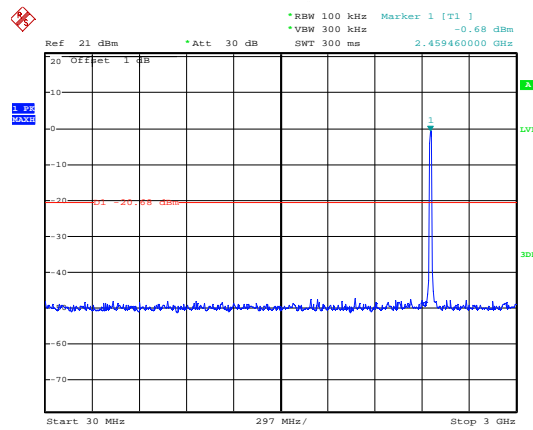

Date: 7.MAY.2014 16:34:46

### 30MHz~3GHz

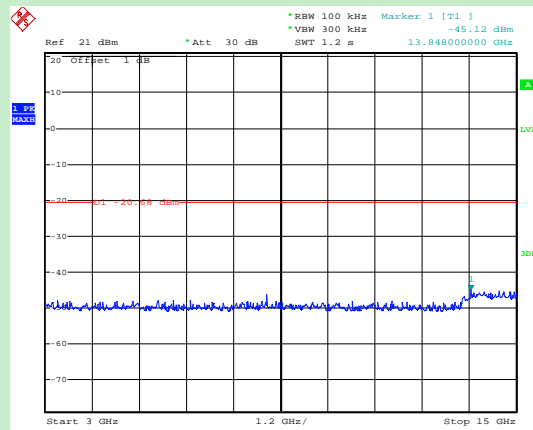

Date: 7.MAY.2014 16:34:56

### 3GHz~15GHz

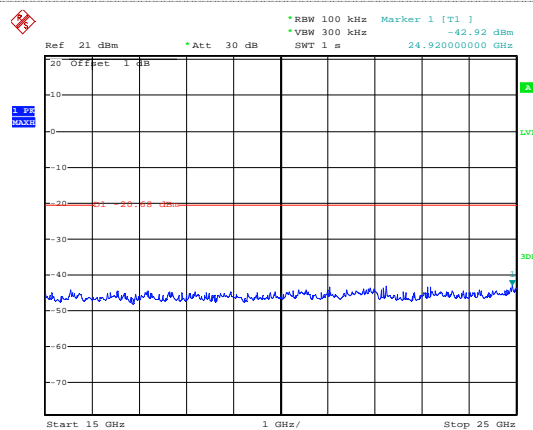

Date: 7.MAY.2014 16:35:06

### 15GHz~25GHz



### 802.11n(H20) mode

Test channel :

01

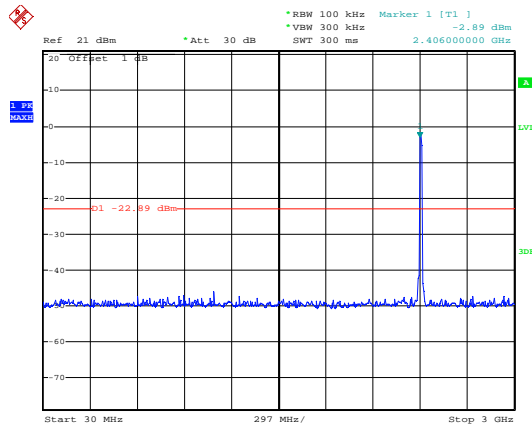

Date: 7.MAY.2014 16:35:39

### 30MHz~3GHz

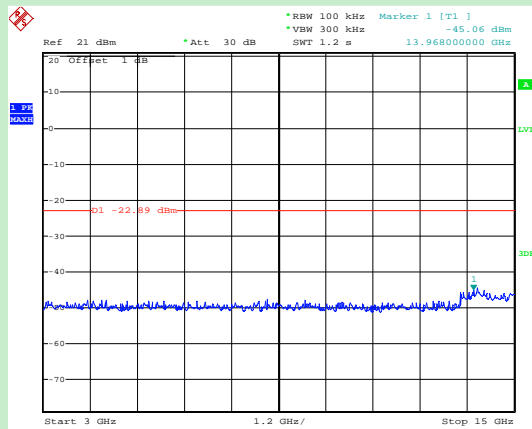

Date: 7.MAY.2014 16:35:49

### 3GHz~15GHz

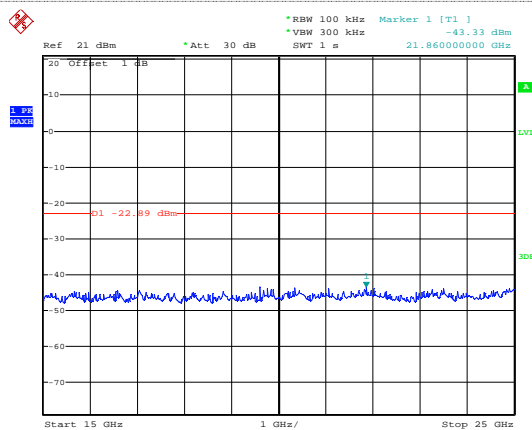

Date: 7.MAY.2014 16:36:00

### 15GHz~25GHz

Test channel :

06

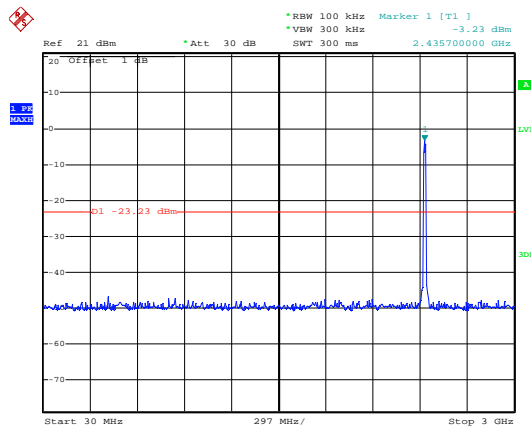

Date: 7.MAY.2014 16:36:25

### 30MHz~3GHz

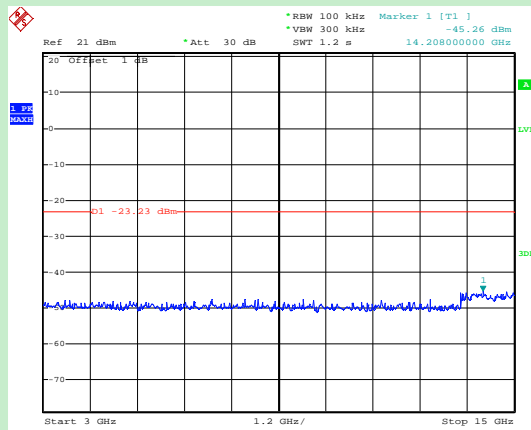

Date: 7.MAY.2014 16:36:35

### 3GHz~15GHz

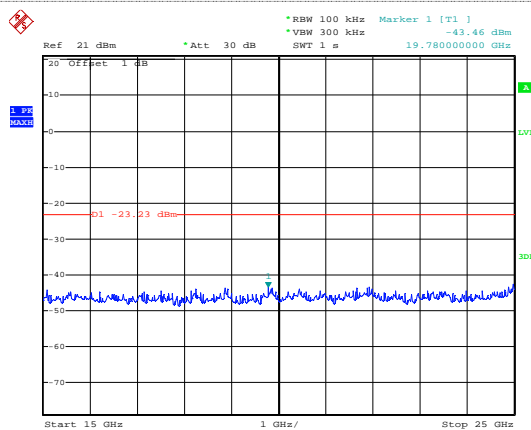

Date: 7.MAY.2014 16:36:42

### 15GHz~25GHz

Test channel :

11

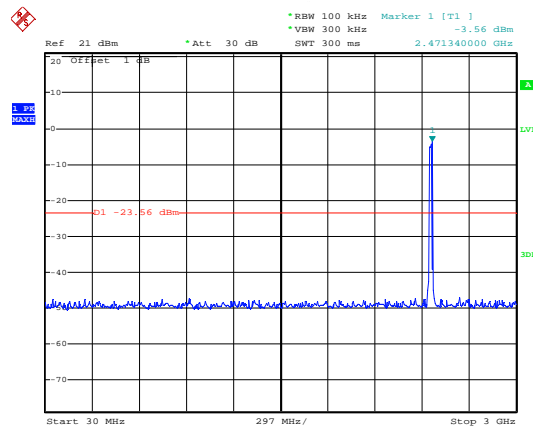

Date: 7.MAY.2014 16:37:19

### 30MHz~3GHz

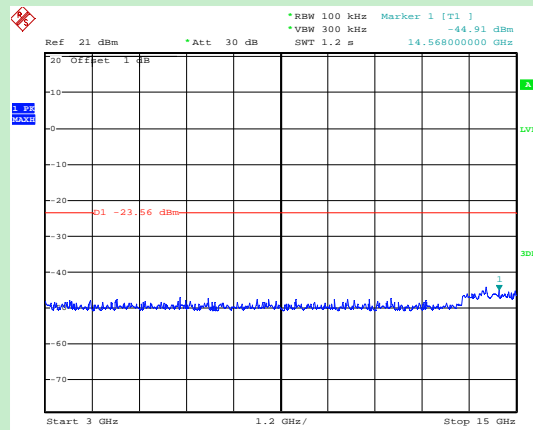

Date: 7.MAY.2014 16:37:31

### 3GHz~15GHz

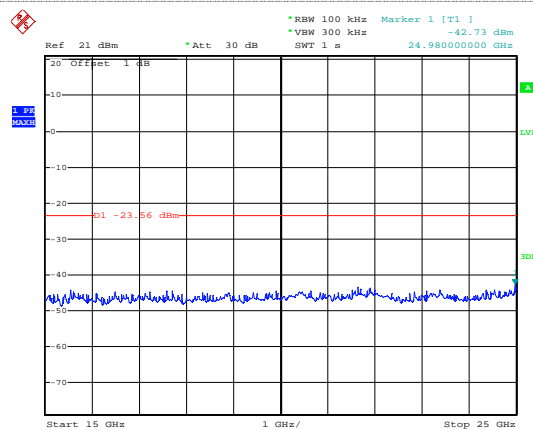

Date: 7.MAY.2014 16:37:42

### 15GHz~25GHz

### 4.8. Spurious Emission (radiated)

**LIMIT**

FCC CFR Title 47 Part 15 Subpart C Section 15.209

Frequency	Limit (dBuV/m @3m)	Value
30MHz-88MHz	40.00	Quasi-peak
88MHz-216MHz	43.50	Quasi-peak
216MHz-960MHz	46.00	Quasi-peak
960MHz-1GHz	54.00	Quasi-peak
Above 1GHz	54.00	Average
	74.00	Peak

**TEST CONFIGURATION**

- Below 30MHz

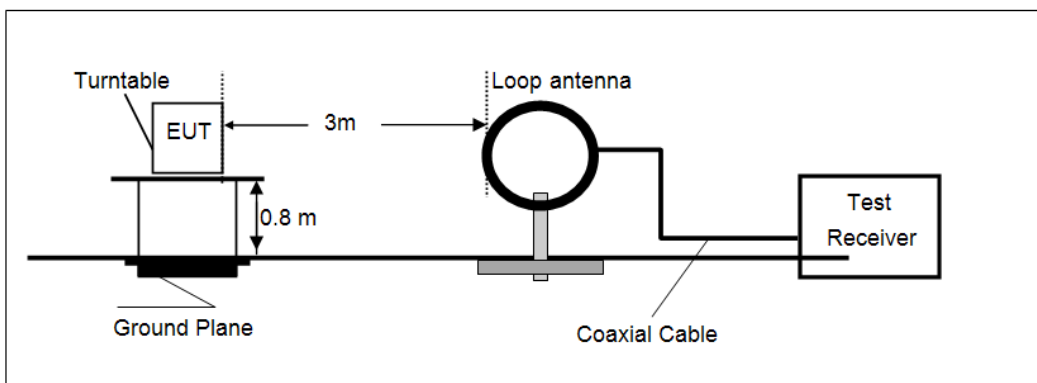

- 30MHz~1000MHz

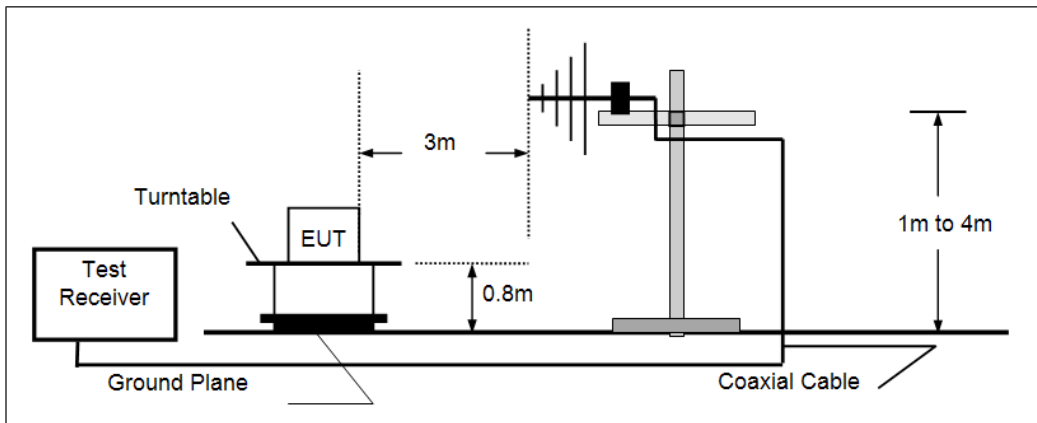

- Above 1GHz

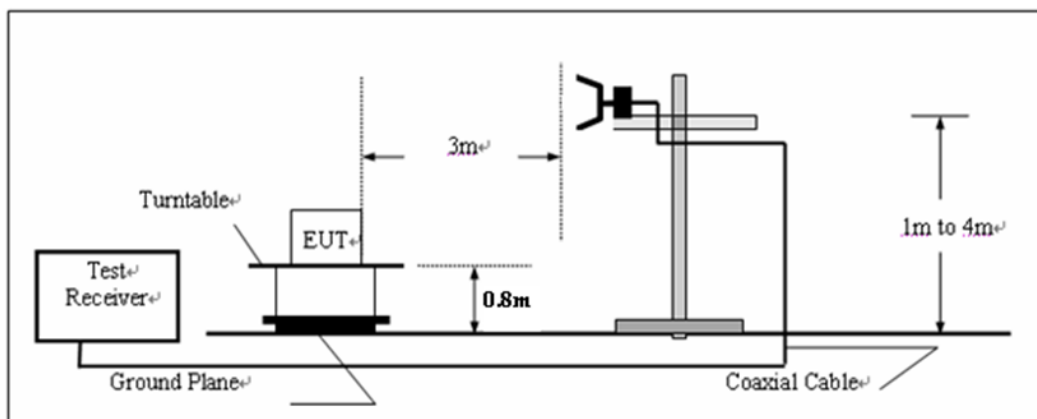

**TEST PROCEDURE**

1. The EUT was placed on the top of a rotating table 0.8 meters above the ground at a 3 meter camber. The table was rotated 360 degrees to determine the position of the highest radiation.
2. The EUT was set 3 meters away from the interference-receiving antenna, which was mounted on the top of a variable-height antenna tower.
3. The antenna height is varied from one meter to four meters above the ground to determine the maximum value of the field strength. Both horizontal and vertical polarizations of the antenna are set to make the measurement.
4. For each suspected emission, the EUT was arranged to its worst case and then the antenna was tuned to heights from 1 meter to 4 meters and the rota table was turned from 0 degrees to 360 degrees to find the maximum reading.
5. The test-receiver system was set to Peak Detect Function and Specified Bandwidth with Maximum Hold Mode.

**TEST RESULTS**

*Noted:*

*Have pre-scan all modulation mode, found the 11B modulation which it was worst case, so only the worst case's data on the test report.*

**For 9KHz to 30MHz**

Frequency (MHz)	Level (dBuV/m)@3m	Limit Line (dBuV/m)@3m	Margin (dB)	Detector	Result
12.00	42.98	69.54	26.56	QP	PASS
24.00	40.91	69.54	28.63	QP	PASS

**Measurement data:****■ Below 1GHz**

Frequency (MHz)	Read Level (dBuV)	Antenna Factor (dB/m)	Cable Loss (dB)	Preamplifier Factor (dB)	Level (dBuV/m)	Limit Line (dBuV/m)	Margin Limit (dB)	Polarization
34.87	49.70	15.82	0.61	32.06	34.07	40.00	5.93	Vertical
54.06	43.76	16.15	0.81	31.95	28.77	40.00	11.23	Vertical
113.39	48.15	14.15	1.31	31.83	31.78	43.50	11.72	Vertical
234.16	44.35	14.88	2.04	32.16	29.11	46.00	16.89	Vertical
742.26	39.08	22.34	4.24	31.25	34.41	46.00	11.59	Vertical
925.71	39.85	23.99	4.95	31.20	37.59	46.00	8.41	Vertical
34.28	48.51	15.80	0.60	32.06	32.85	40.00	7.15	Horizontal
72.54	49.41	12.53	0.96	31.84	31.06	40.00	8.94	Horizontal
96.44	47.70	16.02	1.16	31.75	33.13	43.50	10.37	Horizontal
147.36	52.87	11.27	1.55	31.97	33.72	43.50	9.78	Horizontal
239.15	41.80	15.06	2.06	32.16	26.76	46.00	19.24	Horizontal
929.01	38.33	23.99	4.96	31.20	36.08	46.00	9.92	Horizontal

■ Above 1GHz

Test channel:	01
---------------	----

**Peak value:**

Frequency (MHz)	Read Level (dBuV)	Antenna Factor (dB/m)	Cable Loss (dB)	Preamp Factor (dB)	Level (dBuV/m)	Limit Line (dBuV/m)	Margin Limit (dB)	Polarization
4804.00	46.45	31.44	5.87	35.46	48.30	74.00	25.70	Vertical
7206.00	52.67	36.38	7.08	35.32	60.81	74.00	13.19	Vertical
9608.00	45.05	38.01	9.01	35.72	56.35	74.00	17.65	Vertical
12010.00						74.00		Vertical
14412.00						74.00		Vertical
4804.00	45.13	31.44	5.87	35.46	46.98	74.00	27.02	Horizontal
7206.00	48.59	36.38	7.08	35.32	56.73	74.00	17.27	Horizontal
9608.00	43.25	38.01	9.01	35.72	54.55	74.00	19.45	Horizontal
12010.00	*					74.00		Horizontal
14412.00	*					74.00		Horizontal

**Average value:**

Frequency (MHz)	Read Level (dBuV)	Antenna Factor (dB/m)	Cable Loss (dB)	Preamp Factor (dB)	Level (dBuV/m)	Limit Line (dBuV/m)	Margin Limit (dB)	Polarization
4804.00	25.87	31.44	5.87	35.46	27.72	54.00	26.28	Vertical
7206.00	31.68	36.38	7.08	35.32	39.82	54.00	14.18	Vertical
9608.00	28.90	38.01	9.01	35.72	40.20	54.00	13.80	Vertical
12010.00						54.00		Vertical
14412.00						54.00		Vertical
4804.00	25.39	31.44	5.87	35.46	27.24	54.00	26.76	Horizontal
7206.00	32.14	36.38	7.08	35.32	40.28	54.00	13.72	Horizontal
9608.00	25.90	38.01	9.01	35.72	37.20	54.00	16.80	Horizontal
12010.00						54.00		Horizontal
14412.00						54.00		Horizontal

*Remark:*

1. *Final Level = Receiver Read level + Antenna Factor + Cable Loss – Pre-amplifier Factor*
2. *“\*”, means this data is the too weak instrument of signal is unable to test.*
3. *The emission levels of other frequencies are very lower than the limit and not show in test report.*

Test channel:	06
---------------	----

**Peak value:**

Frequency (MHz)	Read Level (dBuV)	Antenna Factor (dB/m)	Cable Loss (dB)	Preamp Factor (dB)	Level (dBuV/m)	Limit Line (dBuV/m)	Over Limit (dB)	Polarization
4804.00	46.54	30.88	5.70	35.27	47.85	74.00	26.15	Vertical
7206.00	52.76	35.82	6.91	35.13	60.36	74.00	13.64	Vertical
9608.00	45.14	37.45	8.84	35.53	55.90	74.00	18.10	Vertical
12010.00						74.00		Vertical
14412.00						74.00		Vertical
4804.00	45.22	30.88	5.70	35.27	46.53	74.00	27.47	Horizontal
7206.00	48.68	35.82	6.91	35.13	56.28	74.00	17.72	Horizontal
9608.00	43.34	37.45	8.84	35.53	54.10	74.00	19.90	Horizontal
12010.00						74.00		Horizontal
14412.00						74.00		Horizontal

**Average value:**

Frequency (MHz)	Read Level (dBuV)	Antenna Factor (dB/m)	Cable Loss (dB)	Preamp Factor (dB)	Level (dBuV/m)	Limit Line (dBuV/m)	Over Limit (dB)	Polarization
4804.00	26.27	30.88	5.70	35.27	27.58	54.00	26.42	Vertical
7206.00	32.08	35.82	6.91	35.13	39.68	54.00	14.32	Vertical
9608.00	29.30	37.45	8.84	35.53	40.06	54.00	13.94	Vertical
12010.00						54.00		Vertical
14412.00						54.00		Vertical
4804.00	25.79	30.88	5.70	35.27	27.1	54.00	26.90	Horizontal
7206.00	32.54	35.82	6.91	35.13	40.14	54.00	13.86	Horizontal
9608.00	26.30	37.45	8.84	35.53	37.06	54.00	16.94	Horizontal
12010.00						54.00		Horizontal
14412.00						54.00		Horizontal

**Remark:**

1. Final Level = Receiver Read level + Antenna Factor + Cable Loss – Pre-amplifier Factor
2. “\*”, means this data is the too weak instrument of signal is unable to test.
3. The emission levels of other frequencies are very lower than the limit and not show in test report.

Test channel:	11
---------------	----

**Peak value:**

Frequency (MHz)	Read Level (dBuV)	Antenna Factor (dB/m)	Cable Loss (dB)	Preamp Factor (dB)	Level (dBuV/m)	Limit Line (dBuV/m)	Over Limit (dB)	Polarization
4804.00	45.97	30.98	5.73	35.32	47.36	74.00	26.64	Vertical
7206.00	52.19	35.92	6.94	35.18	59.87	74.00	14.13	Vertical
9608.00	44.57	37.55	8.87	35.58	55.41	74.00	18.59	Vertical
12010.00						74.00		Vertical
14412.00						74.00		Vertical
4804.00	44.65	30.98	5.73	35.32	46.04	74.00	27.96	Horizontal
7206.00	48.11	35.92	6.94	35.18	55.79	74.00	18.21	Horizontal
9608.00	42.77	37.55	8.87	35.58	53.61	74.00	20.39	Horizontal
12010.00						74.00		Horizontal
14412.00						74.00		Horizontal

**Average value:**

Frequency (MHz)	Read Level (dBuV)	Antenna Factor (dB/m)	Cable Loss (dB)	Preamp Factor (dB)	Level (dBuV/m)	Limit Line (dBuV/m)	Over Limit (dB)	Polarization
4804.00	25.67	30.98	5.73	35.32	27.06	54.00	26.94	Vertical
7206.00	31.48	35.92	6.94	35.18	39.16	54.00	14.84	Vertical
9608.00	28.70	37.55	8.87	35.58	39.54	54.00	14.46	Vertical
12010.00						54.00		Vertical
14412.00						54.00		Vertical
4804.00	25.19	30.98	5.73	35.32	26.58	54.00	27.42	Horizontal
7206.00	31.94	35.92	6.94	35.18	39.62	54.00	14.38	Horizontal
9608.00	25.70	37.55	8.87	35.58	36.54	54.00	17.46	Horizontal
12010.00						54.00		Horizontal
14412.00						54.00		Horizontal

**Remark:**

1. Final Level = Receiver Read level + Antenna Factor + Cable Loss – Pre-amplifier Factor
2. “\*”, means this data is the too weak instrument of signal is unable to test.
3. The emission levels of other frequencies are very lower than the limit and not show in test report.



## 5. Test Setup Photos of the EUT

Radiated Emission (Below 30MHz)



Radiated Emission (30MHz-1GHz)

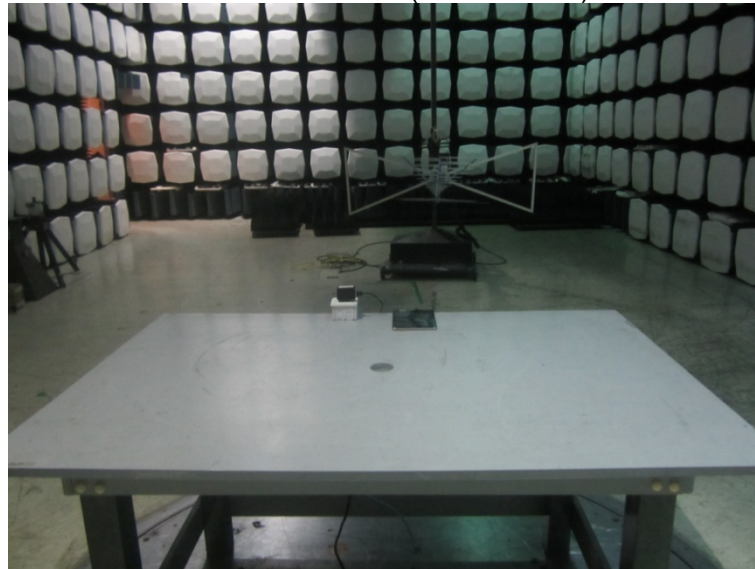

Radiated Emission (above 1GHz)

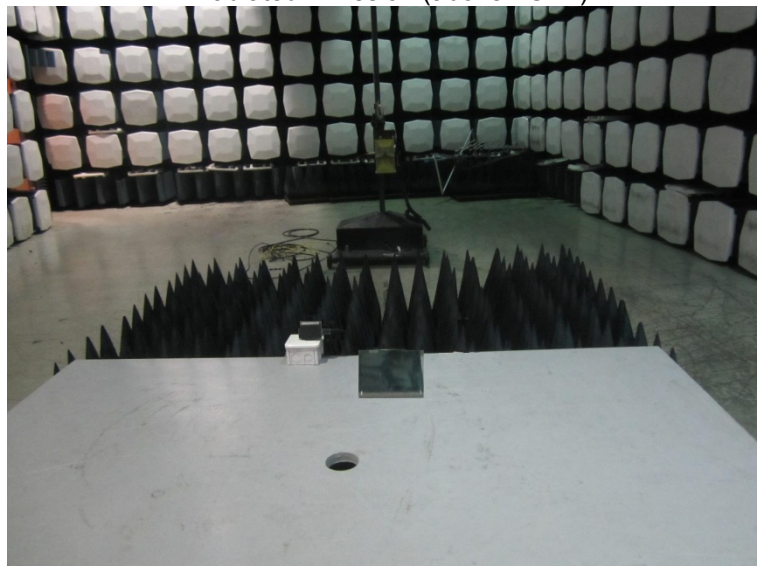

Conducted Emission (AC Mains)



## 6. External and Internal Photos of the EUT

### External photos of the EUT

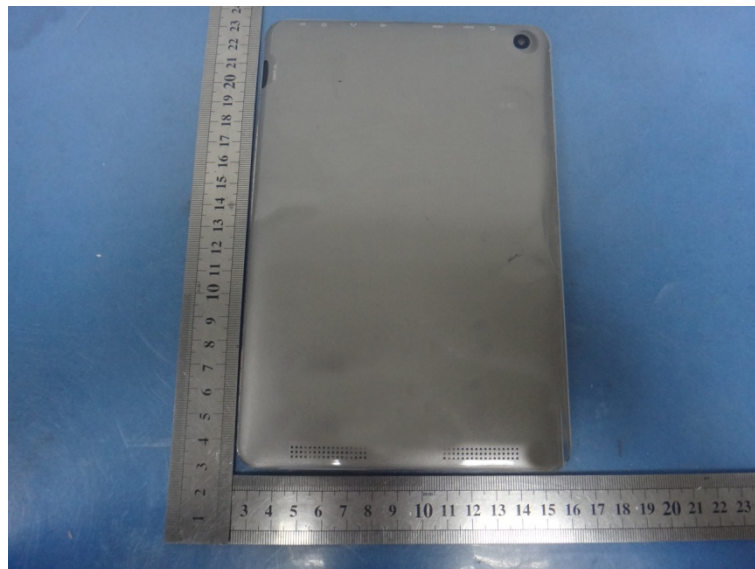





**Internal photos of the EUT**

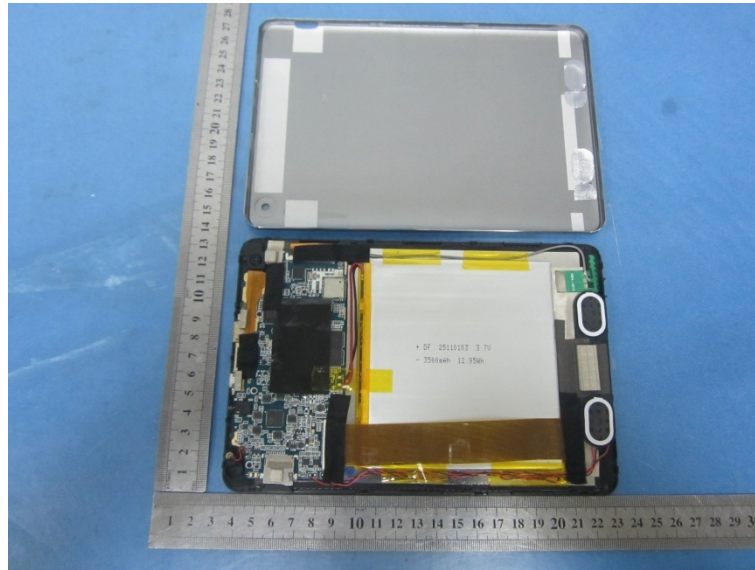

WIFI&BT Antenna Location

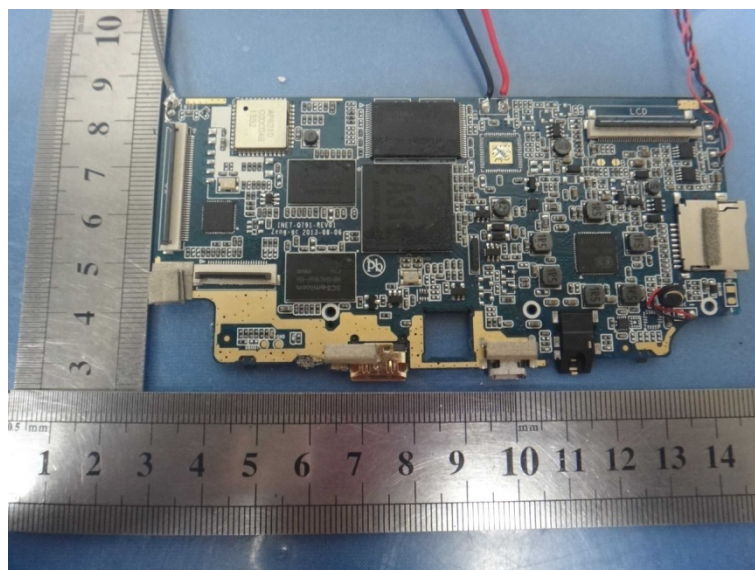

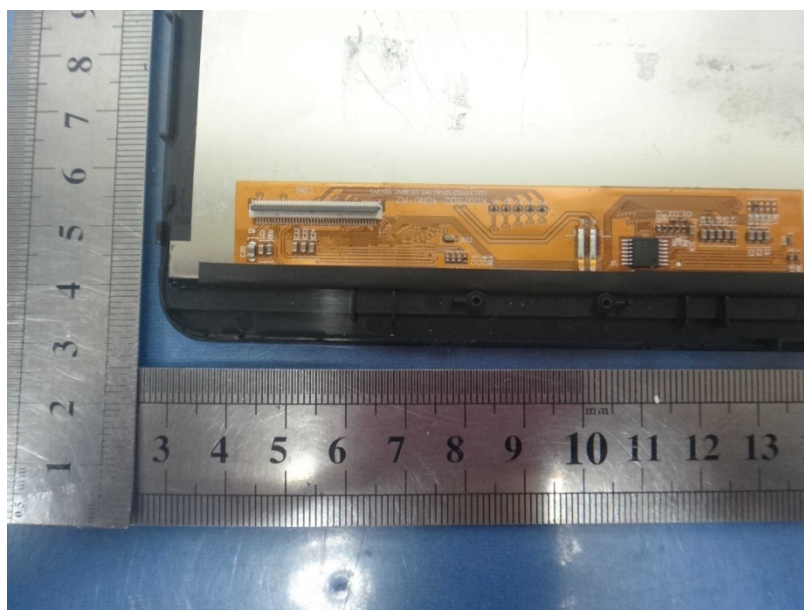
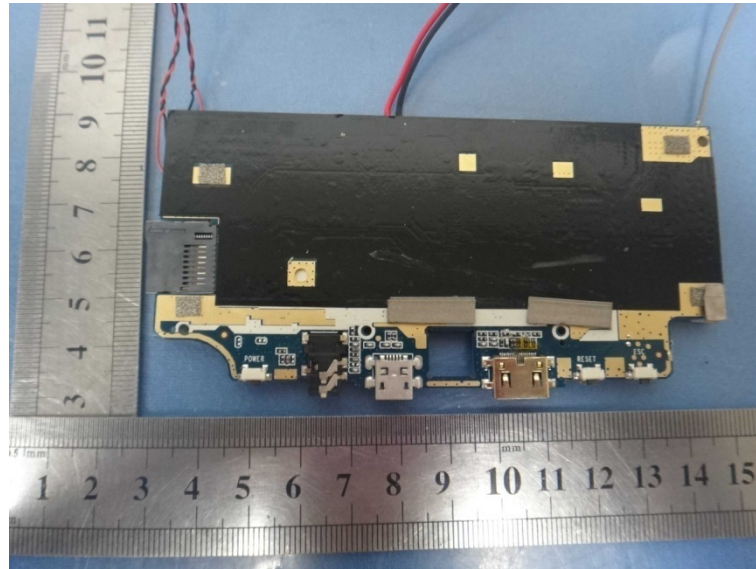

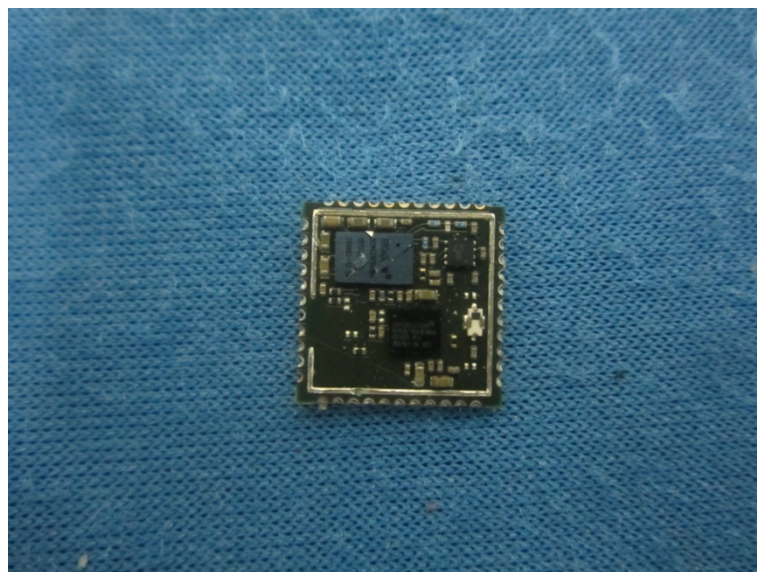
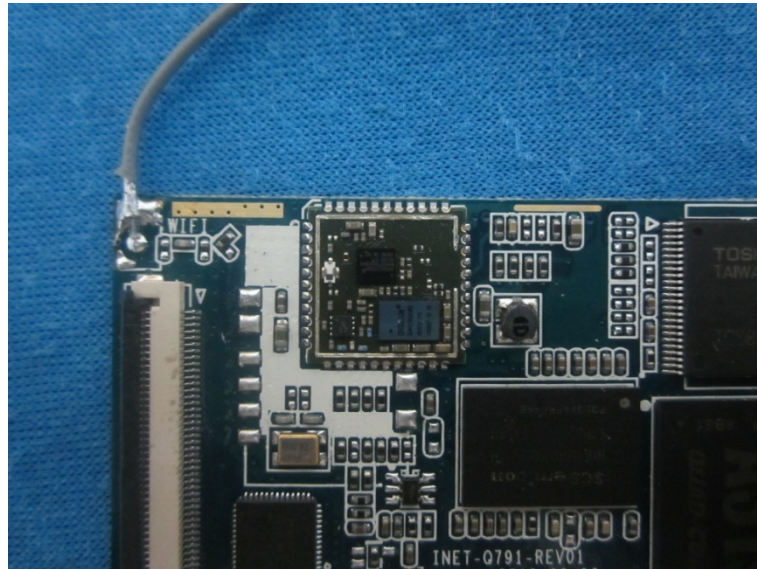

.....End of Report.....