



TEST REPORT

Report Reference No...... : **TRE14080066** R/C.....: 23244
FCC ID..... : **2AAP6M1041**
Applicant's name..... : **SHENZHEN ZOWEE TECHNOLOGY CO.,LTD**
 Address.....: Science &Technology Industrial Park of Privately Owned Enterprises,
 Pingshan, Xili, Nanshan District, Shenzhen, PR CHINA
Manufacturer.....: **SHENZHEN ZOWEE TECHNOLOGY CO.,LTD**
 Address.....: Science &Technology Industrial Park of Privately Owned Enterprises,
 Pingshan, Xili, Nanshan District, Shenzhen, PR CHINA
Test item description : **Internet Tablet**
 Trade Mark: NOBIS,DOPO,TMAX,APEX,D.AGE,NUVISION
 Model/Type reference.....: M1041
 Listed Model(s): NB1022, NB1022S,DPM1081, DPM1081K,D1081,
 M1081,D1081,M1080, D1022,M1022,DM1022,
 DM1020,DPM1020,NB1020, NB1020S,NB1081,NB1080.
Standard : **ANSI C95.1-1999/47CFR § 2.1093**
 Date of receipt of test sample.....: Aug 19, 2014
 Date of testing.....: Aug 25, 2014
 Date of issue.....: Sept 01, 2014
Result.....: **PASS**

Compiled by
 (position+printed name+signature)..: File administrators Vivi Zhou *Vivi Zhou*
 Supervised by
 (position+printed name+signature)..: Project Engineer Jerome Luo *Jerome Luo*
 Approved by
 (position+printed name+signature)..: RF Manager Hans Hu *Hans Hu*

Testing Laboratory Name : **Shenzhen Huatongwei International Inspection Co., Ltd**
 Address.....: Keji Nan No.12 Road, Hi-tech Park, Shenzhen, China

Shenzhen Huatongwei International Inspection Co., Ltd. All rights reserved.
 This publication may be reproduced in whole or in part for non-commercial purposes as long as the Shenzhen Huatongwei International Inspection Co., Ltd is acknowledged as copyright owner and source of the material. Shenzhen Huatongwei International Inspection Co., Ltd takes no responsibility for and will not assume liability for damages resulting from the reader's interpretation of the reproduced material due to its placement and context.

Contents

1.	<u>TEST STANDARDS</u>	3
2.	<u>SUMMARY</u>	4
2.1.	General Remarks	错
	误! 未定义书签。	
2.2.	Product Description	错
	误! 未定义书签。	
2.3.	Statement of Compliance	5
2.4.	Equipment under Test	5
2.5.	Short description of the Equipment under Test (EUT)	5
2.6.	EUT configuration	5
3.	<u>TEST ENVIRONMENT</u>	6
3.1.	Address of the test laboratory	6
3.2.	Test Facility	6
3.3.	Environmental conditions	7
3.4.	SAR Limits	7
3.5.	Equipments Used during the Test	7
4.	<u>SAR MEASUREMENTS SYSTEM CONFIGURATION</u>	8
4.1.	SAR Measurement Set-up	8
4.2.	DASY5 E-field Probe System	9
4.3.	Phantoms	10
4.4.	Device Holder	10
4.5.	Scanning Procedure	11
4.6.	Data Storage and Evaluation	11
4.7.	Tissue Dielectric Parameters for Head and Body Phantoms	13
4.8.	Tissue equivalent liquid properties	14
4.9.	System Check	14
4.10.	SAR measurement procedure	15
5.	<u>TEST CONDITIONS AND RESULTS</u>	19
5.1.	Conducted Power Results	19
5.2.	Simultaneous TX SAR Considerations	20
5.3.	SAR Measurement Results	22
5.4.	SAR Measurement Variability	23
5.5.	Measurement Uncertainty (300MHz-3GHz)	23
5.6.	System Check Results	25
5.7.	SAR Test Graph Results	26
6.	<u>CALIBRATION CERTIFICATE</u>	27
6.1.	Probe Calibration Certificate	27
6.2.	D2450V2 Dipole Calibration Certificate	38
6.3.	DAE4 Calibration Certificate	46
7.	<u>TEST SETUP PHOTOS</u>	49

1. TEST STANDARDS

The tests were performed according to following standards:

[IEEE Std C95.1, 1999](#): IEEE Standard for Safety Levels with Respect to Human Exposure to Radio Frequency Electromagnetic Fields, 3 KHz to 300 GHz. It specifies the maximum exposure limit of 1.6 W/kg as averaged over any 1 gram of tissue for portable devices being used within 20 cm of the user in the uncontrolled environment.

[IEEE Std 1528™-2003](#): IEEE Recommended Practice for Determining the Peak Spatial-Average Specific Absorption Rate (SAR) in the Human Head from Wireless Communications Devices: Measurement Techniques.

[KDB 447498 D01 Mobile Portable RF Exposure v05r02](#): Mobile and Portable Device RF Exposure Procedures and Equipment Authorization Policies

[KDB 616217 D04 SAR for laptop and tablets v01](#): SAR Evaluation Considerations for Laptop, Notebook, Netbook and Tablet Computers

[KDB865664 D01 SAR measurement 100 MHz to 6 GHz v01r03](#): SAR Measurement Requirements for 100 MHz to 6 GHz

[KDB865664 D02 SAR Reporting v01](#): RF Exposure Compliance Reporting and Documentation Considerations

[KDB248227](#): SAR measurement procedures for 802.112abg transmitters

[FCC Part 2.1093 Radiofrequency Radiation Exposure Evaluation](#): Portable Devices

2. SUMMARY

2.1. Client Information

Applicant:	SHENZHEN ZOWEE TECHNOLOGY CO.,LTD
Address:	Science &Technology Industrial Park of Privately Owned Enterprises, Pingshan, Xili, Nanshan District, Shenzhen, PR CHINA
Manufacturer:	SHENZHEN ZOWEE TECHNOLOGY CO.,LTD
Address:	Science &Technology Industrial Park of Privately Owned Enterprises, Pingshan, Xili, Nanshan District, Shenzhen, PR CHINA

2.2. Product Description

Name of EUT	Internet Tablet
Trade Mark:	NOBIS,DOPO,TMAX,APEX,D.AGE,NUVISION
Model No.:	M1041
Listed Model(s):	NB1022, NB1022S,DPM1081, DPM1081K,D1081, M1081,D1081,M1080, D1022,M1022,DM1022, DM1020,DPM1020,NB1020, NB1020S,NB1081,NB1080.
Power supply:	DC 3.7V From Internal Battery
Adapter information:	Model No.:JK050200-S04USA Input: AC 100~240V, 50/60Hz, 0.5A Output: DC 5.0V 2A
WIFI	
Supported type:	802.11b/802.11g/802.11n(H20)/802.11n(H40)
Modulation:	802.11b: DSSS 802.11g/802.11n(H20)/802.11n(H40):OFDM
Operation frequency:	802.11b/802.11g/802.11n(H20): 2412MHz~2462MHz 802.11n(H40): 2422MHz~2452MHz
Channel number:	802.11b/802.11g/802.11n(H20): 11 802.11n(H40): 7
Channel separation:	5MHz
Antenna type:	Internal Antenna
Antenna gain:	2.0 dBi
Bluetooth	
Version:	Supported BT2.1+EDR
Modulation:	GFSK, $\pi/4$ DQPSK, 8DPSK
Operation frequency:	2402MHz~2480MHz
Channel number:	79
Channel separation:	1MHz
Antenna type:	Internal Antenna
Antenna gain:	2.0dBi
Bluetooth	
Version:	Supported BT4.0
Modulation:	GFSK
Operation frequency:	2402MHz~2480MHz
Channel number:	40

Channel separation:	2MHz
Antenna type:	Internal Antenna
Antenna gain:	2.0dBi

2.3. Statement of Compliance

The maximum of results of SAR found during testing for M1047 are follows:

Exposure Configuration	Technolohy Band	Highest Reported SAR 1g(W/Kg)	Equipment Class
Body (Separation Distance 0mm)	WLAN2450	0.693	DTS

The SAR values found for theTable PC are below the maximum recommended levels of 1.6W/Kg as averaged over any 1g tissue accordintg to the ANSI C95.1-1999.

The EUT battery must be fully charged and checked periodically during the test to ascertain iniform power output.

The highest reported SAR values is obtained at the case of,and the values are: **0.693 W/Kg(1g)**.

2.4. Equipment under Test

Power supply system utilised

Power supply voltage	:	<input type="radio"/> 120V / 60 Hz	<input type="radio"/> 115V / 60Hz
		<input type="radio"/> 12 V DC	<input type="radio"/> 24 V DC
		<input checked="" type="radio"/> Other (specified in blank below)	

DC 3.70 V/DC 5.0V Adapter from AC 120V/60Hz

2.5. Short description of the Equipment under Test (EUT)

Internet Tablet (Model: M1041).

The EUT battery must be fully charged and checked periodically during the test to ascertain maximum power output.

2.6. EUT configuration

The following peripheral devices and interface cables were connected during the measurement:

● - supplied by the manufacturer

○ - supplied by the lab

<input type="radio"/> Power Cable	Length (m) :	/
	Shield :	/
	Detachable :	/
<input type="radio"/> Multimeter	Manufacturer :	/
	Model No. :	/

3. TEST ENVIRONMENT

3.1. Address of the test laboratory

Test Laboratory: Shenzhen Huatongwei International Inspection Co., Ltd
Address: Keji Nan No.12 Road, Hi-tech Park, Shenzhen, China
Phone: 86-755-26715686 Fax: 86-755-26748089

3.2. Test Facility

The test facility is recognized, certified, or accredited by the following organizations:

CNAS-Lab Code: L1225

Shenzhen Huatongwei International Inspection Co., Ltd. has been assessed and proved to be in compliance with CNAS-CL01 Accreditation Criteria for Testing and Calibration Laboratories (identical to ISO/IEC 17025: 2005 General Requirements) for the Competence of Testing and Calibration Laboratories, Date of Registration: Mar. 29, 2012. Valid time is until Feb. 28, 2015.

A2LA-Lab Cert. No. 2243.01

Shenzhen Huatongwei International Inspection Co., Ltd. EMC Laboratory has been accredited by A2LA for technical competence in the field of electrical testing, and proved to be in compliance with ISO/IEC 17025: 2005 General Requirements for the Competence of Testing and Calibration Laboratories and any additional program requirements in the identified field of testing. Valid time is until Sept. 30, 2013.

FCC-Registration No.: 662850

Shenzhen Huatongwei International Inspection Co., Ltd. EMC Laboratory has been registered and fully described in a report filed with the FCC (Federal Communications Commission). The acceptance letter from the FCC is maintained in our files. Registration 662850, Renewal date June. 01, 2012, valid time is until June. 01, 2015.

IC-Registration No.: 5377A

The 3m Alternate Test Site of Shenzhen Huatongwei International Inspection Co., Ltd. has been registered by Certification and Engineering Bureau of Industry Canada for the performance of radiated measurements with Registration No. 5377A on Jan. 25, 2011, valid time is until Jan. 24, 2014.

ACA

Shenzhen Huatongwei International Inspection Co., Ltd. EMC Laboratory can also perform testing for the Australian C-Tick mark as a result of our A2LA accreditation.

VCCI

The 3m Semi-anechoic chamber (12.2m×7.95m×6.7m) and Shielded Room (8m×4m×3m) of Shenzhen Huatongwei International Inspection Co., Ltd. has been registered in accordance with the Regulations for Voluntary Control Measures with Registration No.: G-292. Date of Registration: Dec. 24, 2010. Valid time is until Dec. 23, 2013.

Main Ports Conducted Interference Measurement of Shenzhen Huatongwei International Inspection Co., Ltd. has been registered in accordance with the Regulations for Voluntary Control Measures with Registration No.: C-2726. Date of Registration: Dec. 20, 2012. Valid time is until Dec. 19, 2015.

Telecommunication Ports Conducted Interference Measurement of Shenzhen Huatongwei International Inspection Co., Ltd. has been registered in accordance with the Regulations for Voluntary Control Measures with Registration No.: T-1837. Date of Registration: May 07, 2013. Valid time is until May 06, 2016.

DNV

Shenzhen Huatongwei International Inspection Co., Ltd. has been found to comply with the requirements of DNV towards subcontractor of EMC and safety testing services in conjunction with the EMC and Low voltage Directives and in the voluntary field. The acceptance is based on a formal quality Audit and follow-ups according to relevant parts of ISO/IEC Guide 17025 (2005), in accordance with the requirements of the DNV Laboratory Quality Manual towards subcontractors. Valid time is until Aug. 24, 2016.

3.3. Environmental conditions

During the measurement the environmental conditions were within the listed ranges:

Temperature:	18-25 ° C
Humidity:	40-65 %
Atmospheric pressure:	950-1050mbar

3.4. SAR Limits

EXPOSURE LIMITS	FCC Limit (1g Tissue)	
	SAR (W/kg)	
	(General Population / Uncontrolled Exposure Environment)	(Occupational / Controlled Exposure Environment)
Spatial Average (averaged over the whole body)	0.08	0.4
Spatial Peak (averaged over any 1 g of tissue)	1.60	8.0
Spatial Peak (hands/wrists/feet/ankles averaged over 10 g)	4.0	20.0

Population/Uncontrolled Environments are defined as locations where there is the exposure of individual who have no knowledge or control of their exposure.

Occupational/Controlled Environments are defined as locations where there is exposure that may be incurred by people who are aware of the potential for exposure (i.e. as a result of employment or occupation).

3.5. Equipments Used during the Test

Test Equipment	Manufacturer	Type/Model	Serial Number	Calibration	
				Last Calibration	Calibration Interval
Data Acquisition Electronics DAEx	SPEAG	DAE4	1315	2013/11/25	1
E-field Probe	SPEAG	EX3DV4	3842	2014/06/06	1
System Validation Dipole 2450V2	SPEAG	D2450V2	884	2013/12/11	1
Dielectric Probe Kit	Agilent	85070E	US44020288	/	/
Power meter	Agilent	E4417A	GB41292254	2013/12/26	1
Power sensor	Agilent	8481H	MY41095360	2013/12/26	1
Network analyzer	Agilent	8753E	US37390562	2013/12/25	1
Universal Radio Communication Tester	ROHDE & SCHWARZ	CMU200	112012	2013/10/23	1

4. SAR Measurements System configuration

4.1. SAR Measurement Set-up

The DASY5 system for performing compliance tests consists of the following items:

A standard high precision 6-axis robot (Stäubli RX family) with controller and software. An arm extension for accommodating the data acquisition electronics (DAE).

A dosimetric probe, i.e. an isotropic E-field probe optimized and calibrated for usage in tissue simulating liquid. The probe is equipped with an optical surface detector system.

A data acquisition electronic (DAE) which performs the signal amplification, signal multiplexing, AD-conversion, offset measurements, mechanical surface detection, collision detection, etc. The unit is battery powered with standard or rechargeable batteries. The signal is optically transmitted to the EOC.

A unit to operate the optical surface detector which is connected to the EOC.

The Electro-Optical Coupler (EOC) performs the conversion from the optical into a digital electric signal of the DAE. The EOC is connected to the DASY5 measurement server.

The DASY5 measurement server, which performs all real-time data evaluation for field measurements and surface detection, controls robot movements and handles safety operation. A computer operating Windows 2003.

DASY5 software and SEMCAD data evaluation software.

Remote control with teach panel and additional circuitry for robot safety such as warning lamps, etc.

The generic twin phantom enabling the testing of left-hand and right-hand usage.

The device holder for handheld mobile phones.

Tissue simulating liquid mixed according to the given recipes.

System validation dipoles allowing to validate the proper functioning of the system.

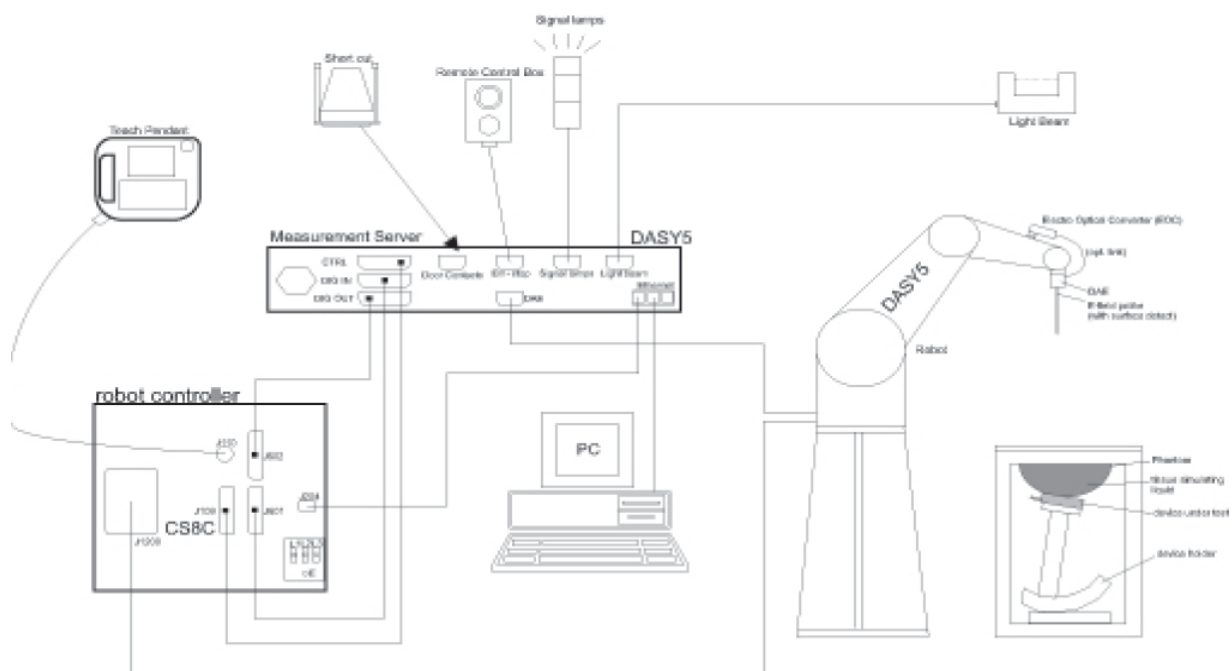

4.2. DASY5 E-field Probe System

The SAR measurements were conducted with the dosimetric probe ES3DV3 (manufactured by SPEAG), designed in the classical triangular configuration and optimized for dosimetric evaluation.

Probe Specification

Construction	Symmetrical design with triangular core Interleaved sensors Built-in shielding against static charges PEEK enclosure material (resistant to organic solvents, e.g., DGBE)
Calibration	ISO/IEC 17025 calibration service available.
Frequency	10 MHz to 4 GHz; Linearity: ± 0.2 dB (30 MHz to 4 GHz)
Directivity	± 0.2 dB in HSL (rotation around probe axis) ± 0.3 dB in tissue material (rotation normal to probe axis)
Dynamic Range	5 μ W/g to > 100 mW/g; Linearity: ± 0.2 dB
Dimensions	Overall length: 337 mm (Tip: 20 mm) Tip diameter: 3.9 mm (Body: 12 mm) Distance from probe tip to dipole centers: 2.0 mm
Application	General dosimetry up to 4 GHz Dosimetry in strong gradient fields Compliance tests of mobile phones
Compatibility	DASY3, DASY4, DASY52 SAR and higher, EASY4/MRI



Isotropic E-Field Probe

The isotropic E-Field probe has been fully calibrated and assessed for isotropicity, and boundary effect within a controlled environment. Depending on the frequency for which the probe is calibrated the method utilized for calibration will change.

The E-Field probe utilizes a triangular sensor arrangement as detailed in the diagram below:

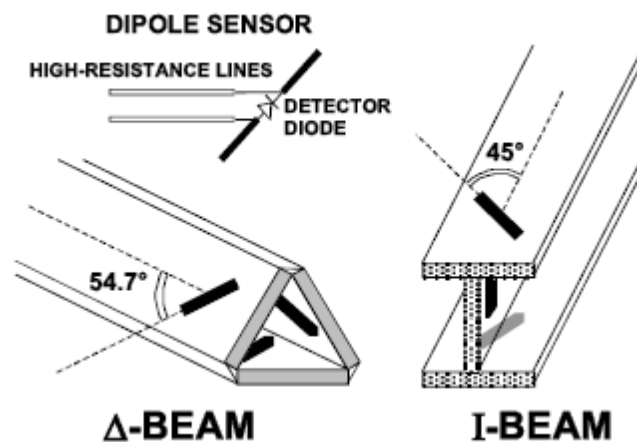

4.3. Phantoms

The phantom used for all tests i.e. for both system checks and device testing, was the twin-headed "SAM Phantom", manufactured by SPEAG. The SAM twin phantom is a fiberglass shell phantom with 2mm shell thickness (except the ear region, where shell thickness increases to 6mm).

System checking was performed using the flat section, whilst Head SAR tests used the left and right head profile sections. Body SAR testing also used the flat section between the head profiles.



SAM Twin Phantom

4.4. Device Holder

The device was placed in the device holder (illustrated below) that is supplied by SPEAG as an integral part of the DASY system.

The DASY device holder is designed to cope with the different positions given in the standard. It has two scales for device rotation (with respect to the body axis) and device inclination (with respect to the line between the ear reference points). The rotation centers for both scales is the ear reference point (ERP). Thus the device needs no repositioning when changing the angles.



Device holder supplied by SPEAG

4.5. Scanning Procedure

The DASY5 installation includes predefined files with recommended procedures for measurements and validation. They are read-only document files and destined as fully defined but unmeasured masks. All test positions (head or body-worn) are tested with the same configuration of test steps differing only in the grid definition for the different test positions.

The “reference” and “drift” measurements are located at the beginning and end of the batch process. They measure the field drift at one single point in the liquid over the complete procedure. The indicated drift is mainly the variation of the DUT’s output power and should vary max. $\pm 5\%$.

The “surface check” measurement tests the optical surface detection system of the DASY5 system by repeatedly detecting the surface with the optical and mechanical surface detector and comparing the results. The output gives the detecting heights of both systems, the difference between the two systems and the standard deviation of the detection repeatability. Air bubbles or refraction in the liquid due to separation of the sugar-water mixture gives poor repeatability (above $\pm 0.1\text{mm}$). To prevent wrong results tests are only executed when the liquid is free of air bubbles. The difference between the optical surface detection and the actual surface depends on the probe and is specified with each probe (It does not depend on the surface reflectivity or the probe angle to the surface within $\pm 30^\circ$.)

Area Scan

The Area Scan is used as a fast scan in two dimensions to find the area of high field values before running a detailed measurement around the hot spot. Before starting the area scan a grid spacing of 15 mm x 15 mm is set. During the scan the distance of the probe to the phantom remains unchanged. After finishing area scan, the field maxima within a range of 2 dB will be ascertained.

Zoom Scan

Zoom Scans are used to estimate the peak spatial SAR values within a cubic averaging volume containing 1 g and 10 g of simulated tissue. The default Zoom Scan is done by 7x7x7 points within a cube whose base is centered around the maxima found in the preceding area scan.

Spatial Peak Detection

The procedure for spatial peak SAR evaluation has been implemented and can determine values of masses of 1g and 10g, as well as for user-specific masses. The DASY5 system allows evaluations that combine measured data and robot positions, such as: • maximum search • extrapolation • boundary correction • peak search for averaged SAR. During a maximum search, global and local maxima searches are automatically performed in 2-D after each Area Scan measurement with at least 6 measurement points. It is based on the evaluation of the local SAR gradient calculated by the Quadratic Shepard’s method. The algorithm will find the global maximum and all local maxima within -2 dB of the global maxima for all SAR distributions.

Extrapolation routines are used to obtain SAR values between the lowest measurement points and the inner phantom surface. The extrapolation distance is determined by the surface detection distance and the probe sensor offset. Several measurements at different distances are necessary for the extrapolation. Extrapolation routines require at least 10 measurement points in 3-D space. They are used in the Zoom Scan to obtain SAR values between the lowest measurement points and the inner phantom surface. The routine uses the modified Quadratic Shepard’s method for extrapolation. For a grid using 7x7x7 measurement points with 5mm resolution amounting to 343 measurement points, the uncertainty of the extrapolation routines is less than 1% for 1g and 10g cubes.

A Z-axis scan measures the total SAR value at the x-and y-position of the maximum SAR value found during the cube 7x7x7 scan. The probe is moved away in z-direction from the bottom of the SAM phantom in 5mm steps.

4.6. Data Storage and Evaluation

Data Storage

The DASY5 software stores the acquired data from the data acquisition electronics as raw data (in microvolt readings from the probe sensors), together with all necessary software parameters for the data evaluation (probe calibration data, liquid parameters and device frequency and modulation data) in measurement files with the extension “.DA4”. The software evaluates the desired unit and format for output each time the data is visualized or exported. This allows verification of the complete software setup even after the measurement and allows correction of incorrect parameter settings. For example, if a measurement has been performed

with a wrong crest factor parameter in the device setup, the parameter can be corrected afterwards and the data can be re-evaluated.

The measured data can be visualized or exported in different units or formats, depending on the selected probe type ([V/m], [A/m], [°C], [mW/g], [mW/cm²], [dBrel], etc.). Some of these units are not available in certain situations or show meaningless results, e.g., a SAR output in a lossless media will always be zero. Raw data can also be exported to perform the evaluation with other software packages.

Data Evaluation

The SEMCAD software automatically executes the following procedures to calculate the field units from the microvolt readings at the probe connector. The parameters used in the evaluation are stored in the configuration modules of the software:

Probe parameters:	- Sensitivity	Normi, ai0, ai1, ai2
	- Conversion factor	ConvFi
	- Diode compression point	Dcpi
Device parameters:	- Frequency	f
	- Crest factor	cf
Media parameters:	- Conductivity	σ
	- Density	ρ

These parameters must be set correctly in the software. They can be found in the component documents or they can be imported into the software from the configuration files issued for the DASY5 components. In the direct measuring mode of the multimeter option, the parameters of the actual system setup are used. In the scan visualization and export modes, the parameters stored in the corresponding document files are used.

The first step of the evaluation is a linearization of the filtered input signal to account for the compression characteristics of the detector diode. The compensation depends on the input signal, the diode type and the DC-transmission factor from the diode to the evaluation electronics. If the exciting field is pulsed, the crest factor of the signal must be known to correctly compensate for peak power. The formula for each channel can be given as:

$$V_i = U_i + U_i^2 \cdot \frac{cf}{dcp_i}$$

With	V_i	= compensated signal of channel i	(i = x, y, z)
	U_i	= input signal of channel i	(i = x, y, z)
	cf	= crest factor of exciting field	(DASY parameter)
	dcp _i	= diode compression point	(DASY parameter)

From the compensated input signals the primary field data for each channel can be evaluated:

$$\text{E - fieldprobes : } E_i = \sqrt{\frac{V_i}{\text{Norm}_i \cdot \text{ConvF}}}$$

$$\text{H - fieldprobes : } H_i = \sqrt{V_i} \cdot \frac{a_{i0} + a_{i1}f + a_{i2}f^2}{f}$$

With	V_i	= compensated signal of channel i	(i = x, y, z)
	Norm _i	= sensor sensitivity of channel i	(i = x, y, z)
		[mV/(V/m) ²] for E-field Probes	
	ConvF	= sensitivity enhancement in solution	
	a _{ij}	= sensor sensitivity factors for H-field probes	
	f	= carrier frequency [GHz]	
	E_i	= electric field strength of channel i in V/m	
	H_i	= magnetic field strength of channel i in A/m	

The RSS value of the field components gives the total field strength (Hermitian magnitude):

$$E_{tot} = \sqrt{E_x^2 + E_y^2 + E_z^2}$$

The primary field data are used to calculate the derived field units.

$$SAR = E_{tot}^2 \cdot \frac{\sigma}{\rho \cdot 1'000}$$

with	SAR	= local specific absorption rate in mW/g
	E_{tot}	= total field strength in V/m
	σ	= conductivity in [mho/m] or [Siemens/m]
	ρ	= equivalent tissue density in g/cm ³

Note that the density is normally set to 1 (or 1.06), to account for actual brain density rather than the density of the simulation liquid.

4.7. Tissue Dielectric Parameters for Head and Body Phantoms

The liquid is consisted of water,salt,Glycol,Sugar,Preventol and Cellulose.The liquid has previously been proven to be suited for worst-case.The table 3 and table 4 show the detail solition.It's satisfying the latest tissue dielectric parameters requirements proposed by the KDB865664.

Table 3:Composition of the Head Tissue Equivalent Matter

MIXTURE%	FREQUENCY(Brain) 835MHz
Water	41.45
Sugar	56
Salt	1.45
Preventol	0.12
Cellulose	1.0
Dielectric Paramters Target Value	f=835MHz $\epsilon=41.50$ $\sigma=0.9$

MIXTURE%	FREQUENCY(Brain) 1750MHz
Water	55.24
Glycol	44.45
Salt	0.31
Dielectric Paramters Target Value	f=1750MHz $\epsilon=40.10$ $\sigma=1.37$

MIXTURE%	FREQUENCY(Brain) 1900MHz
Water	55.242
Glycol monobutyl	44.452
Salt	0.306
Dielectric Paramters Target Value	f=1900MHz $\epsilon=40.00$ $\sigma=1.40$

MIXTURE%	FREQUENCY(Brain) 2450MHz
Water	62.70
Glycol	36.80
Salt	0.50
Dielectric Paramters Target Value	f=2450MHz $\epsilon=39.20$ $\sigma=1.80$

Table 4:Composition of the Body Tissue Equivalent Matter

MIXTURE%	FREQUENCY(Brain) 835MHz
Water	52.50
Sugar	45
Salt	1.40
Preventol	0.10
Cellulose	1.00
Dielectric Paramters Target Value	f=835MHz $\epsilon=55.20$ $\sigma=0.97$

MIXTURE%	FREQUENCY(Brain) 1750MHz
Water	69.61
Glycol	29.97
Salt	0.12
Dielectric Paramters Target Value	f=1750MHz $\epsilon=53.40$ $\sigma=1.49$

MIXTURE%	FREQUENCY(Brain) 1900MHz
Water	69.91
Glycol monobutyl	29.96
Salt	0.13
Dielectric Paramters Target Value	f=1900MHz $\epsilon=53.30$ $\sigma=1.52$

MIXTURE%	FREQUENCY(Brain) 2450MHz
Water	73.20
Glycol	26.70
Salt	0.10
Dielectric Paramters Target Value	f=2450MHz $\epsilon=52.70$ $\sigma=1.95$

4.8. Tissue equivalent liquid properties

Dielectric performance of Body tissue simulating liquid

Frequency	Description	Dielectric parameters	
		ϵ_r	σ
2450MHz(Body)	Target Value $\pm 5\%$	52.7 (50.1~55.3)	1.95 (1.85~2.05)
	Measurement Value 2014-08-25	53.6	1.98

4.9. System Check

The purpose of the system check is to verify that the system operates within its specifications at the device test frequency. The system check is simple check of repeatability to make sure that the system works correctly at the time of the compliance test;

System check results have to be equal or near the values determined during dipole calibration with the relevant liquids and test system ($\pm 10\%$).

System check is performed regularly on all frequency bands where tests are performed with the DASY5 system.

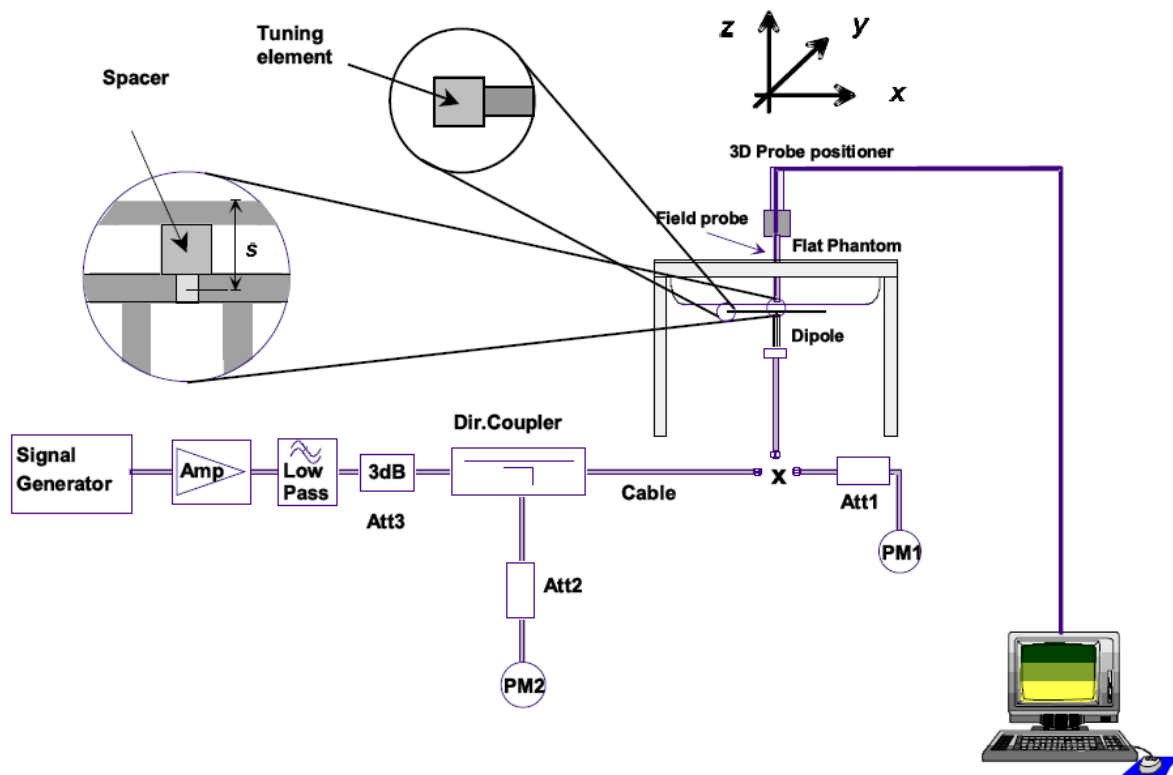

The output power on dipole port must be calibrated to 24 dBm (250mW) before dipole is connected.

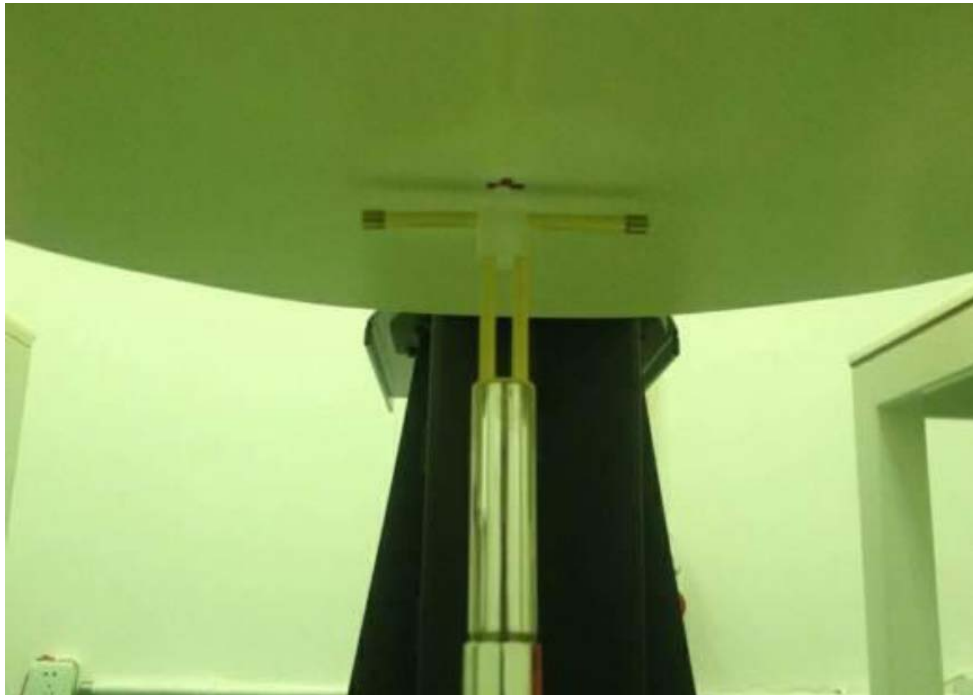

Photo of Dipole Setup

System Validation of Body

Measurement is made at temperature 22.0 °C and relative humidity 55%.							
Liquid temperature 22.0 °C							
Measurement Date: 2450MHz Aug 25 th , 2014							
Verification results	Frequency (MHz)	Target value (W/kg)		Measured value (W/kg)		Deviation	
		1 g Average	10 g Average	1 g Average	10 g Average	1 g Average	10 g Average
	2450	12.80	5.98	12.72	5.95	-0.62%	0.50%

4.10. SAR measurement procedure

4.10.1 Tests to be performed

In order to determine the highest value of the peak spatial-average SAR of a handset, all device positions, configurations and operational modes shall be tested for each frequency band according to steps 1 to 3 below. A flowchart of the test process is shown in Picture 11.1.

Step 1: The tests described in 11.2 shall be performed at the channel that is closest to the centre of the transmit frequency band (f_c) for:

- all device positions (cheek and tilt, for both left and right sides of the SAM phantom);
- all configurations for each device position in a), e.g., antenna extended and retracted, and
- all operational modes, e.g., analogue and digital, for each device position in a) and configuration in b) in each frequency band.

If more than three frequencies need to be tested according to 11.1 (i.e., $N_c > 3$), then all frequencies, configurations and modes shall be tested for all of the above test conditions.

Step 2: For the condition providing highest peak spatial-average SAR determined in Step 1, perform all tests described in 11.2 at all other test frequencies, i.e., lowest and highest frequencies. In addition, for all other conditions (device position, configuration and operational mode) where the peak spatial-average SAR value determined in Step 1 is within 3 dB of the applicable SAR limit, it is recommended that all other test frequencies shall be tested as well.

Step 3: Examine all data to determine the highest value of the peak spatial-average SAR found in Steps 1 to 2.

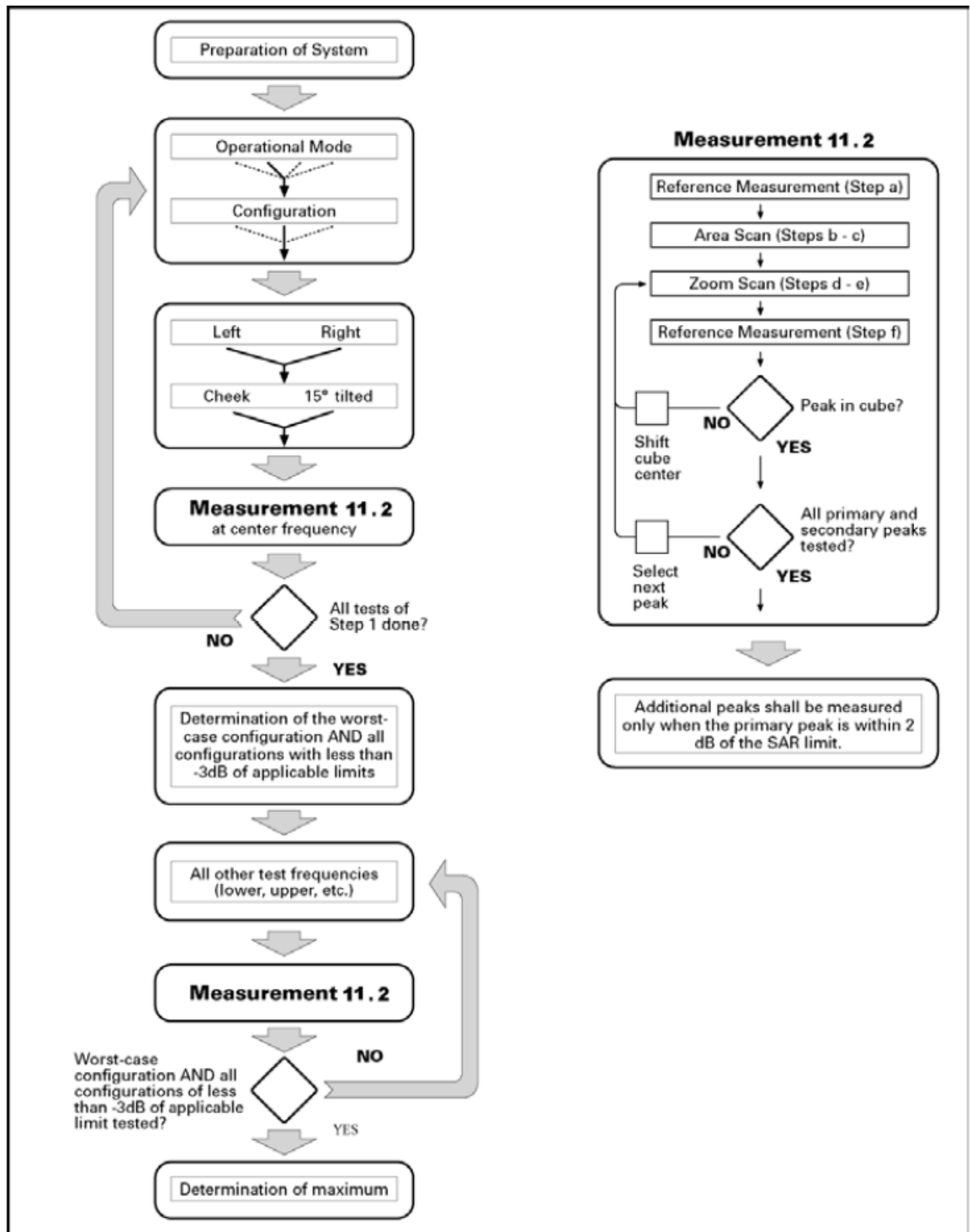

Picture 10.1 Block diagram of the tests to be performed

4.10.2 General Measurement Procedure

The area and zoom scan resolutions specified in the table below must be applied to the SAR measurements and fully documented in SAR reports to qualify for TCB approval. Probe boundary effect error compensation is required for measurements with the probe tip closer than half a probe tip diameter to the phantom surface. Both the probe tip diameter and sensor offset distance must satisfy measurement protocols; to ensure probe boundary effect errors are minimized and the higher fields closest to the phantom surface can be correctly measured and extrapolated to the phantom surface for computing 1-g SAR. Tolerances of the post-processing

algorithms must be verified by the test laboratory for the scan resolutions used in the SAR measurements, according to the reference distribution functions specified in IEEE Std 1528-2003. The results should be documented as part of the system validation records and may be requested to support test results when all the measurement parameters in the following table are not satisfied.

		≤ 3 GHz	> 3 GHz
Maximum distance from closest measurement point (geometric center of probe sensors) to phantom surface		5 ± 1 mm	$\frac{1}{2} \delta \ln(2) \pm 0.5$ mm
Maximum probe angle from probe axis to phantom surface normal at the measurement location		$30^\circ \pm 1^\circ$	$20^\circ \pm 1^\circ$
Maximum area scan spatial resolution: Δx_{Area} , Δy_{Area}		≤ 2 GHz: ≤ 15 mm 2 – 3 GHz: ≤ 12 mm	3 – 4 GHz: ≤ 12 mm 4 – 6 GHz: ≤ 10 mm
		When the x or y dimension of the test device, in the measurement plane orientation, is smaller than the above, the measurement resolution must be \leq the corresponding x or y dimension of the test device with at least one measurement point on the test device.	
Maximum zoom scan spatial resolution: Δx_{Zoom} , Δy_{Zoom}		≤ 2 GHz: ≤ 8 mm 2 – 3 GHz: ≤ 5 mm*	3 – 4 GHz: ≤ 5 mm* 4 – 6 GHz: ≤ 4 mm*
Maximum zoom scan spatial resolution, normal to phantom surface	uniform grid: $\Delta z_{Zoom}(n)$	≤ 5 mm	3 – 4 GHz: ≤ 4 mm 4 – 5 GHz: ≤ 3 mm 5 – 6 GHz: ≤ 2 mm
	graded grid $\Delta z_{Zoom}(1)$: between 1 st two points closest to phantom surface	≤ 4 mm	3 – 4 GHz: ≤ 3 mm 4 – 5 GHz: ≤ 2.5 mm 5 – 6 GHz: ≤ 2 mm
	$\Delta z_{Zoom}(n>1)$: between subsequent points	$\leq 1.5 \cdot \Delta z_{Zoom}(n-1)$	
Minimum zoom scan volume	x, y, z	≥ 30 mm	3 – 4 GHz: ≥ 28 mm 4 – 5 GHz: ≥ 25 mm 5 – 6 GHz: ≥ 22 mm
Note: δ is the penetration depth of a plane-wave at normal incidence to the tissue medium; see draft standard IEEE P1528-2011 for details.			
* When zoom scan is required and the <i>reported</i> SAR from the area scan based <i>I-g SAR estimation</i> procedures of KDB 447498 is ≤ 1.4 W/kg, ≤ 8 mm, ≤ 7 mm and ≤ 5 mm zoom scan resolution may be applied, respectively, for 2 GHz to 3 GHz, 3 GHz to 4 GHz and 4 GHz to 6 GHz.			

4.10.3 WLAN Measurement Procedures for SAR

For WLAN SAR testing, WLAN engineering testing software installed on the DUT can provide continuous transmitting RF signal. The Tx power is set to 58 for 802.11 b mode, set to 48 for 802.11 g mode, set to 40 for 802.11 n mode by software. This RF signal utilized in SAR measurement has almost 100% duty cycle and its crest factor is 1.

For the 802.11b/g/n SAR tests, a communication link is set up with the test mode software for WIFI mode test. During the test, at the each test frequency channel, the EUT is operated at the RF continuous emission mode. Each channel should be tested at the highest power rate.

802.11b/g/n operating modes are tested independently according to the service requirements in each frequency band. 802.11b/g/n modes are tested on the maximum average output channel;

SAR is not required for 802.11g/n channels when the maximum average output power is less than 0.25dB higher than that measured on the corresponding 802.11b channels.

4.10.4 Power Drift

To control the output power stability during the SAR test, DASY5 system calculates the power drift by measuring the E-field at the same location at the beginning and at the end of the measurement for each test position. These drift values can be found in Table 14.1 to Table 14.11 labeled as: (Power Drift [dB]). This ensures that the power drift during one measurement is within 5%.

4.10.4 Area Scan Based 1-g SAR

4.10.4.1 Requirement of KDB

According to the KDB447498 D01 v05, when the implementation is based the specific polynomial fit algorithm as presented at the 29th Bioelectromagnetics Society meeting (2007) and the estimated 1-g SAR is ≤ 1.2 W/kg, a zoom scan measurement is not required provided it is also not needed for any other purpose; for example, if the peak SAR location required for simultaneous transmission SAR test exclusion can be determined accurately by the SAR system or manually to discriminate between distinctive peaks and scattered noisy SAR distributions from area scans.

There must not be any warning or alert messages due to various measurement concerns identified by the SAR system; for example, noise in measurements, peaks too close to scan boundary, peaks are too sharp, spatial resolution and uncertainty issues etc. The SAR system verification must also demonstrate that the area scan estimated 1-g SAR is within 3% of the zoom scan 1-g SAR (See Annex B). When all the SAR results for each exposure condition in a frequency band and wireless mode are based on estimated 1-g SAR, the 1-g SAR for the highest SAR configuration must be determined by a zoom scan.

4.10.4.2 Fast SAR Algorithms

The approach is based on the area scan measurement applying a frequency dependent attenuation parameter. This attenuation parameter was empirically determined by analyzing a large number of phones. The MOTOROLA FAST SAR was developed and validated by the MOTOROLA Research Group in Ft. Lauderdale.

In the initial study, an approximation algorithm based on Linear fit was developed. The accuracy of the algorithm has been demonstrated across a broad frequency range (136-2450 MHz) and for both 1- and 10-g averaged SAR using a sample of 264 SAR measurements from 55 wireless handsets. For the sample size studied, the root-mean-squared errors of the algorithm are 1.2% and 5.8% for 1- and 10-g averaged SAR, respectively

In the second step, the same research group optimized the fitting algorithm to an Polynomial fit whereby the frequency validity was extended to cover the range 30-6000MHz. Details of this study can be found in the BEMS 2007 Proceedings.

Both algorithms are implemented in DASY software.

5. TEST CONDITIONS AND RESULTS

5.1. Conducted Power Results

Max Conducted power measurement results and power drift from tune-up tolerance provide by manufacturer:

WLAN

Mode	Channel	Frequency (MHz)	Worst case Data rate of worst case	Conducted Output Power (dBm)	
				Peak	Average
802.11b	1	2412	1Mbps	21.62	17.54
	6	2437	1Mbps	21.98	17.94
	11	2462	1Mbps	22.22	17.76
802.11g	1	2412	6Mbps	17.65	14.96
	6	2437	6Mbps	18.83	14.68
	11	2462	6Mbps	18.42	14.72
802.11n(20MHz)	1	2412	6.5 Mbps	19.89	13.89
	6	2437	6.5 Mbps	21.20	14.12
	11	2462	6.5 Mbps	20.06	13.78
802.11n(40MHz)	1	2412	13.5 Mbps	17.65	13.36
	6	2437	13.5 Mbps	20.01	13.67
	11	2462	13.5 Mbps	17.99	13.38

Note: SAR is not required for 802.11g/n channels if the output power is less than 0.25dB higher than that measured on the corresponding 802.11b channels, and for each frequency band, testing at higher data rates and higher order modulations is not required when the maximum average output power for each of these configurations is less than 0.25dB higher than those measured at the lowest data rate. According to the above conducted power, the EUT should be tested for "802.11b, 1Mbps".

The conducted power measurement results for Bluetooth v4.0

Mode	Channel	Frequency (MHz)	Conducted Output Power	
			(dBm)	(mW)
GFSK-BLE	1	2402	-0.23	0.95
	20	2440	-0.13	0.97
	40	2480	-0.20	0.95
GFSK	01	2402	3.34	2.16
	40	2441	3.47	2.22
	79	2480	3.21	2.09
$\pi/4$ DQPSK	01	2402	2.67	1.85
	40	2441	2.63	1.83
	79	2480	2.59	1.82
8DPSK	01	2402	2.13	1.63
	40	2441	2.24	1.67
	79	2480	2.76	1.89

WLAN

802.11b			
Channel	Channel 1	Channel 6	Channel 11
Target (dBm)	17.0	17.0	17.0
Tolerance \pm (dB)	1	1	1
802.11g			
Channel	Channel 810	Channel 661	Channel 512
Target (dBm)	14.0	14.0	14.0
Tolerance \pm (dB)	1	1	1
802.11n(20MHz)			
Channel	Channel 1	Channel 6	Channel 11
Target (dBm)	13.5	13.5	13.5
Tolerance \pm (dB)	1	1	1
802.11n(40MHz)			

Channel	Channel 1	Channel 6	Channel 11
Target (dBm)	13.0	13.0	13.0
Tolerance \pm (dB)	1	1	1

**Bluetooth
GFSK-BLE**

Channel	Channel 01	Channel 20	Channel 40
Target (dBm)	0.0	0.0	0.0
Tolerance \pm (dB)	1	1	1

GFSK

Channel	Channel 01	Channel 40	Channel 79
Target (dBm)	2.5	2.5	2.5
Tolerance \pm (dB)	1	1	1

π /4DQPSK

Channel	Channel 01	Channel 40	Channel 79
Target (dBm)	1.0	1.0	1.0
Tolerance \pm (dB)	1	1	1

8DPSK

Channel	Channel 01	Channel 40	Channel 79
Target (dBm)	1.0	1.0	1.0
Tolerance \pm (dB)	1	1	1

5.2. Simultaneous TX SAR Considerations

5.2.1 Introduction

The following procedures adopted from "FCC SAR Considerations for Cell Phones with Multiple Transmitters" are applicable to handsets with built-in unlicensed transmitters such as 802.11 a/b/g devices which may simultaneously transmit with the licensed transmitter.

5.2.2 Transmit Antenna Separation Distances

The product can support WLAN function, according to following picture 1 showed that the diagonal dimension (29cm > 20cm) and figure 2 for antenna position of the DUT. So according to KDB 616217 and KDB447498 for SAR testing.



Figure 1: The diagonal dimension of the DUT

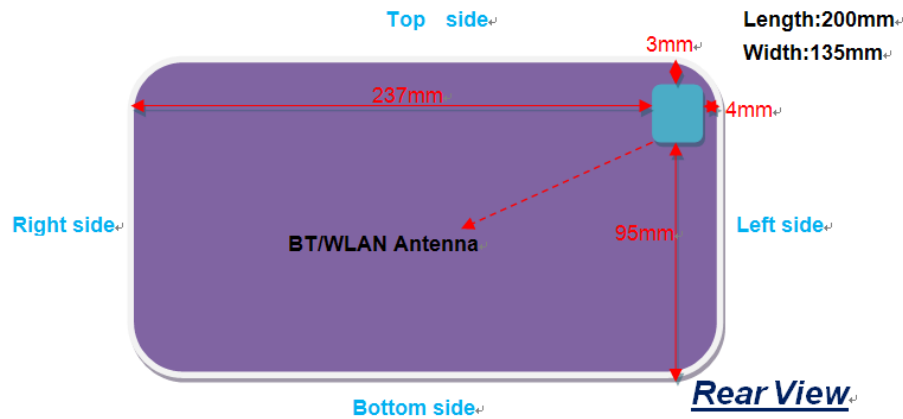

Figure 2: The antenna positions of the DUT

5.2.3 SAR Measurement Positions

According to KDB447498 Section 4.3.1 1) for test distance ≤50mm and 2) for test distance >50mm of SAR test exclusion threshold, refer to Figure 2 for antenna positions of the DUT; For test distance ≤50mm, SAR test exclusion as following table 1

Table 1 SAR test exclusion for test distance ≤50mm

Mode	Position	Distance (mm)	Maximum Output Power including tune-up tolerance (dBm)	Maximum Output Power including tune-up tolerance (mW)	Evaluated SAR test exclusion	SAR test exclusion thresholds	SAR test exclusion
WLAN	Front Side	0	17.94	62.23	7.3	3.0	yes ^[1]
	Rear Side	0	17.94	62.23	7.3	3.0	no
	Top Edge Side	3	17.94	62.23	7.3	3.0	no
	Left Edge Side	4	17.94	62.23	7.3	3.0	no
BT	Front Side	0	3.47	2.22	7.3	3.0	yes ^[1]
	Rear Side	0	3.47	2.22	7.3	3.0	yes
	Top Edge Side	3	3.47	2.22	7.3	3.0	yes
	Left Edge Side	4	3.47	2.22	7.3	3.0	yes

For test distance >50mm, SAR test exclusion as following table 2

Table 2 SAR test exclusion for test distance >50mm

Mode	Position	Distance (mm)	Maximum Output Power including tune-up tolerance (dBm)	Maximum Output Power including tune-up tolerance (mW)	SAR test exclusion thresholds (mW)	SAR test exclusion
WLAN	Right Edge Side	237	17.94	62.23	1870.72	yes
	Bottom Edge Side	95	17.94	62.23	450.72	yes
BT	Right Edge Side	237	3.47	2.22	1870.72	yes
	Bottom Edge Side	95	3.47	2.22	450.72	yes

Note: 1. Front side SAR test not required according to KDB 616217 D04 SAR for laptop and tablets v01;
 2. According to KDB 447498 D01 Mobile Portable RF Exposure v05r02, When the minimum test separation distance is < 5 mm, a distance of 5 mm according to 5) in section 4.1 is applied to determine SAR test exclusion.

5.2.4 Standalone SAR Test Exclusion Considerations

Standalone 1-g head or body SAR evaluation by measurement or numerical simulation is not required when the corresponding SAR Exclusion Threshold condition, listed below, is satisfied.

The 1-g SAR test exclusion threshold for 100 MHz to 6 GHz at test separation distances ≤ 50 mm are determined by:

$$[(\text{max. power of channel, including tune-up tolerance, mW}) / (\text{min. test separation distance, mm})] \cdot [\sqrt{f(\text{GHz})}] \leq 3.0 \text{ for 1-g SAR, where}$$

- f(GHz) is the RF channel transmit frequency in GHz

- Power and distance are rounded to the nearest mW and mm before calculation
- The result is rounded to one decimal place for comparison

Appendix A

SAR Test Exclusion Thresholds for 100 MHz – 6 GHz and ≤ 50 mm

Approximate SAR Test Exclusion Power Thresholds at Selected Frequencies and Test Separation Distances are illustrated in the following Table.

MHz	5	10	15	20	25	mm
150	39	77	116	155	194	SAR Test Exclusion Threshold (mW)
300	27	55	82	110	137	
450	22	45	67	89	112	
835	16	33	49	66	82	
900	16	32	47	63	79	
1500	12	24	37	49	61	
1900	11	22	33	44	54	
2450	10	19	29	38	48	
3600	8	16	24	32	40	
5200	7	13	20	26	33	
5400	6	13	19	26	32	
5800	6	12	19	25	31	

Picture 12.2 Power Thresholds

5.2.5 Estimated SAR

When standalone SAR is not required to be measured per FCC KDB 447498 D01, the following equation must be used to estimate the standalone 1g SAR for simultaneous transmission assessment involving that transmitter.

$$\text{Estimated SAR} = \frac{(\text{max. power of channel, including tune-up tolerance, mW})}{(\text{min. test separation distance, mm})} * \frac{\sqrt{f(\text{GHz})}}{7.5}$$

Per FCC KD B447498 D01, simultaneous transmission SAR test exclusion may be applied when the sum of the 1-g SAR for all the transmitting antenna in a specific a physical test configuration is ≤ 1.6 W/Kg. When the sum is greater than the SAR limit, SAR test exclusion is determined by the SAR to peak location separation ratio.

$$\text{Ratio} = \frac{(\text{SAR}_1 + \text{SAR}_2)^{1.5}}{(\text{peak location separation, mm})} < 0.04$$

5.3. SAR Measurement Results

It is determined by user manual for the distance between the EUT and the phantom bottom. The distance is 5mm and just applied to the condition of body worn accessory.

The calculated SAR is obtained by the following formula:

$$\text{Reported SAR} = \text{Measured SAR} * 10^{(P_{\text{target}} - P_{\text{measured}})/10}$$

$$\text{Scaling factor} = 10^{(P_{\text{target}} - P_{\text{measured}})/10}$$

$$\text{Reported SAR} = \text{Measured SAR} * \text{Scaling factor}$$

Where P_{target} is the power of manufacturing upper limit;

P_{measured} is the measured power;

Measured SAR is measured SAR at measured power which including power drift)

Reported SAR which including Power Drift and Scaling factor

Duty Cycle	
Test Mode WLAN2450	Duty Cycle 1:1

SAR Values (WiFi2450z 802.11b-Body)

Test Frequency		Test Position	Maximum Allowed Power (dBm)	Conducted Power (dBm)	Measurement SAR over 1g(W/kg)	Power drift	Scaling Factor	Reported SAR over1g (W/kg)	SAR limit 1g (W/kg)	Ref. Plot #
Ch	MHz									
6	2437	Front	18.00	17.94	N/A	N/A	N/A	N/A	N/A	N/A
6	2437	Rear	18.00	17.94	0.637	-0.04	1.01	0.643	1.60	--
6	2437	Left	18.00	17.94	0.629	-0.02	1.01	0.635	1.60	--
6	2437	Top	18.00	17.94	0.602	-0.03	1.01	0.608	1.60	--
6	2437	Right	18.00	17.94	N/A	N/A	N/A	N/A	N/A	N/A
6	2437	Bottom	18.00	17.94	N/A	N/A	N/A	N/A	N/A	N/A
1	2412	Front	18.00	17.54	N/A	N/A	N/A	N/A	N/A	N/A
1	2412	Rear	18.00	17.54	0.624	-0.05	1.11	0.693	1.60	1
1	2412	Left	18.00	17.54	0.605	-0.02	1.11	0.672	1.60	--
1	2412	Top	18.00	17.54	0.583	-0.03	1.11	0.647	1.60	--
1	2412	Right	18.00	17.54	N/A	N/A	N/A	N/A	N/A	N/A
1	2412	Bottom	18.00	17.54	N/A	N/A	N/A	N/A	N/A	N/A
11	2462	Front	18.00	17.76	N/A	N/A	N/A	N/A	N/A	N/A
11	2462	Rear	18.00	17.76	0.561	-0.04	1.06	0.595	1.60	--
11	2462	Left	18.00	17.76	0.542	-0.02	1.06	0.575	1.60	--
11	2462	Top	18.00	17.76	0.528	-0.03	1.06	0.560	1.60	--
11	2462	Right	18.00	17.76	N/A	N/A	N/A	N/A	N/A	N/A
11	2462	Bottom	18.00	17.76	N/A	N/A	N/A	N/A	N/A	N/A

Note: 1. According to KDB447498, When the 1-g SAR for the mid-band channel, or the channel with highest output power satisfy the following conditions, testing of the other channels in the band is not required.

$\leq 0.8W/Kg$ and transmission band $\leq 100MHz$;

$\leq 0.6W/Kg$ and $100MHz \leq$ transmission band $\leq 200MHz$;

$\leq 0.4W/Kg$ and transmission band $>200MHz$

2. According to KDB 248227, Each channel should be tested at the lowest data rate in each mode.

5.4. SAR Measurement Variability

SAR measurement variability must be assessed for each frequency band, which is determined by the SAR probe calibration point and tissue-equivalent medium used for the device measurements. When both head and body tissue-equivalent media are required for SAR measurements in a frequency band, the variability measurement procedures should be applied to the tissue medium with the highest measured SAR, using the highest measured SAR configuration for that tissue-equivalent medium. The following procedures are applied to determine if repeated measurements are required.

- 1) Repeated measurement is not required when the original highest measured SAR is < 0.80 W/kg; steps 2) through 4) do not apply.
- 2) When the original highest measured SAR is ≥ 0.80 W/kg, repeat that measurement once.
- 3) Perform a second repeated measurement only if the ratio of largest to smallest SAR for the original and first repeated measurements is > 1.20 or when the original or repeated measurement is ≥ 1.45 W/kg ($\sim 10\%$ from the 1-g SAR limit).
- 4) Perform a third repeated measurement only if the original, first or second repeated measurement is ≥ 1.5 W/kg and the ratio of largest to smallest SAR for the original, first and second repeated measurements is > 1.20 .

5.5. Measurement Uncertainty (300MHz-3GHz)

No.	Error Description	Type	Uncertainty Value	Probably Distribution	Div.	(Ci) 1g	(Ci) 10g	Std. Unc. (1g)	Std. Unc. (10g)	Degree of freedom
Measurement System										
1	Probe calibration	B	5.50%	N	1	1	1	5.50%	5.50%	∞
2	Axial isotropy	B	4.70%	R	$\sqrt{3}$	0.7	0.7	1.90%	1.90%	∞
3	Hemispherical isotropy	B	9.60%	R	$\sqrt{3}$	0.7	0.7	3.90%	3.90%	∞
4	Boundary Effects	B	1.00%	R	$\sqrt{3}$	1	1	0.60%	0.60%	∞
5	Probe Linearity	B	4.70%	R	$\sqrt{3}$	1	1	2.70%	2.70%	∞

6	Detection limit	B	1.00%	R	$\sqrt{3}$	1	1	0.60%	0.60%	∞
7	RF ambient conditions-noise	B	0.00%	R	$\sqrt{3}$	1	1	0.00%	0.00%	∞
8	RF ambient conditions-reflection	B	0.00%	R	$\sqrt{3}$	1	1	0.00%	0.00%	∞
9	Response time	B	0.80%	R	$\sqrt{3}$	1	1	0.50%	0.50%	∞
10	Integration time	B	5.00%	R	$\sqrt{3}$	1	1	2.90%	2.90%	∞
11	RF ambient	B	3.00%	R	$\sqrt{3}$	1	1	1.70%	1.70%	∞
12	Probe positioned mech. restrictions	B	0.40%	R	$\sqrt{3}$	1	1	0.20%	0.20%	∞
13	Probe positioning with respect to phantom shell	B	2.90%	R	$\sqrt{3}$	1	1	1.70%	1.70%	∞
14	Max.SAR evaluation	B	3.90%	R	$\sqrt{3}$	1	1	2.30%	2.30%	∞
Test Sample Related										
15	Test sample positioning	A	1.86%	N	1	1	1	1.86%	1.86%	∞
16	Device holder uncertainty	A	1.70%	N	1	1	1	1.70%	1.70%	∞
17	Drift of output power	B	5.00%	R	$\sqrt{3}$	1	1	2.90%	2.90%	∞
Phantom and Set-up										
18	Phantom uncertainty	B	4.00%	R	$\sqrt{3}$	1	1	2.30%	2.30%	∞
19	Liquid conductivity (target)	B	5.00%	R	$\sqrt{3}$	0.64	0.43	1.80%	1.20%	∞
20	Liquid conductivity (meas.)	A	0.50%	N	1	0.64	0.43	0.32%	0.26%	∞
21	Liquid permittivity (target)	B	5.00%	R	$\sqrt{3}$	0.64	0.43	1.80%	1.20%	∞
22	Liquid cpermittivity (meas.)	A	0.16%	N	1	0.64	0.43	0.10%	0.07%	∞
Combined standard uncertainty	$u_c = \sqrt{\sum_{i=1}^{22} c_i^2 u_i^2}$		/	/	/	/	/	10.20%	10.00%	∞
Expanded uncertainty (confidence interval of 95 %)	$u_e = 2u_c$		/	R	K=2	/	/	20.40%	20.00%	∞

5.6. System Check Results

System Performance Check at 2450 MHz Body

DUT: Dipole 2450 MHz; Type: D2450V2; Serial: 884

Date/Time: 25/08/2014 AM

Communication System: CW; Frequency: 2450 MHz; Duty Cycle: 1:1

Medium parameters used (interpolated): $f = 2450$ MHz; $\sigma = 1.99$ S/m; $\epsilon_r = 53.70$; $\rho = 1000$ kg/m³

Phantom section: Flat Section

DASY5 Configuration:

Probe: ES3DV3 - SN3842; ConvF(6.93, 6.93, 6.93); Calibrated: 06/06/2013;

Sensor-Surface: 3mm (Mechanical Surface Detection)

Electronics: DAE4 Sn1315; Calibrated: 02/27/2013

Phantom: SAM 1; Type: SAM;

Measurement SW: DASY52, Version 52.8 (1); SEMCAD X Version 14.6.5 (6469)

Area Scan (61x91x1): Measurement grid: $dx=12.00$ mm, $dy=12.00$ mm

Maximum value of SAR (interpolated) = 12.97W/kg

Zoom Scan (7x7x7)/Cube 0: Measurement grid: $dx=5$ mm, $dy=5$ mm, $dz=5$ mm

Reference Value = 99.872 V/m; Power Drift = 0.0028 dB

Peak SAR (extrapolated) = 17.651 mW/g

SAR(1 g) = 12.72 mW/g; SAR(10 g) = 5.95 mW/g

Maximum value of SAR (measured) = 13.563 W/kg

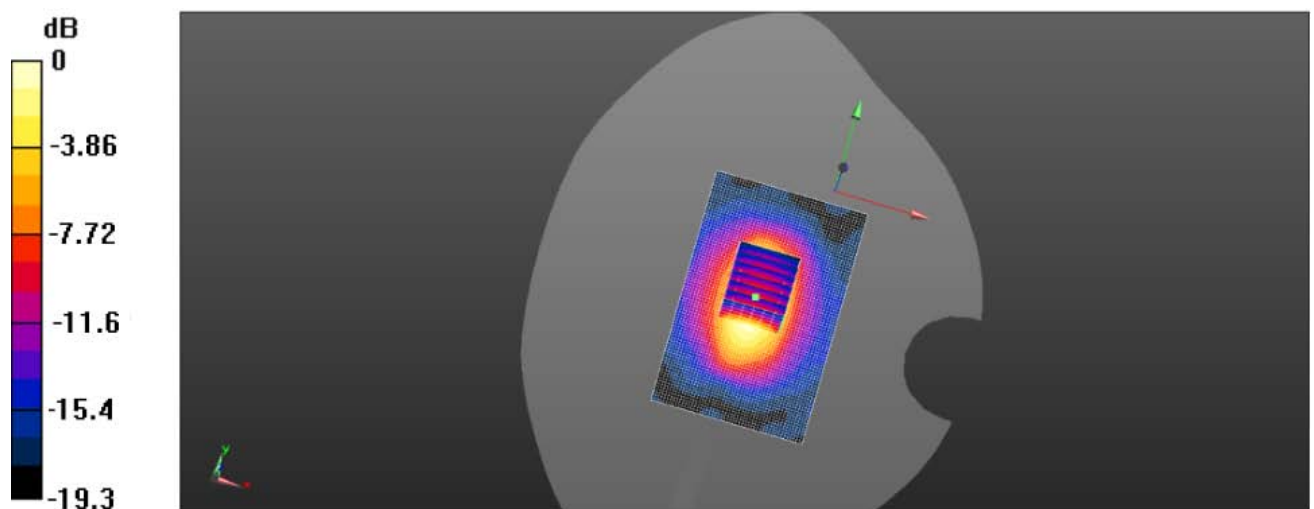

0 dB = 13.56 mW/g = 22.647 dB mW/g

System Performance Check 2450MHz Body 250mW

5.7. SAR Test Graph Results

WLAN2450 Rear Side Middle Channel -Channel 1-2412MHz (1Mbps)

Communication System: Customer System; Frequency: 2412 MHz; Duty Cycle: 1:1

Medium parameters used (interpolated): $f = 2412$ MHz; $\sigma = 2.02$ S/m; $\epsilon_r = 53.00$; $\rho = 1000$ kg/m³

Phantom section: Body- worn

Probe: ES3DV3 - SN3842; ConvF(6.93, 6.93, 6.93); Calibrated: 06/06/2013;

Sensor-Surface: 4mm (Mechanical Surface Detection)

Electronics: DAE4 Sn1315; Calibrated: 25/11/2013

Phantom: SAM 1; Type: SAM;

Measurement SW: DASY52, Version 52.8 (2); SEMCAD X Version 14.6.6 (6824)

Area Scan (31x91x1): Measurement grid: $dx=1.50$ mm, $dy=1.50$ mm

Maximum value of SAR (interpolated) = 0.689 W/kg

Zoom Scan (7x7x5)/Cube 0: Measurement grid: $dx=5$ mm, $dy=5$ mm, $dz=5$ mm

Reference Value = 6.862 V/m; Power Drift = -0.05 dB

Peak SAR (extrapolated) = 0.836 W/Kg

SAR(1 g) = 0.624 W/Kg; SAR(10 g) = 0.341 W/Kg

Maximum value of SAR (measured) = 0.836 W/kg

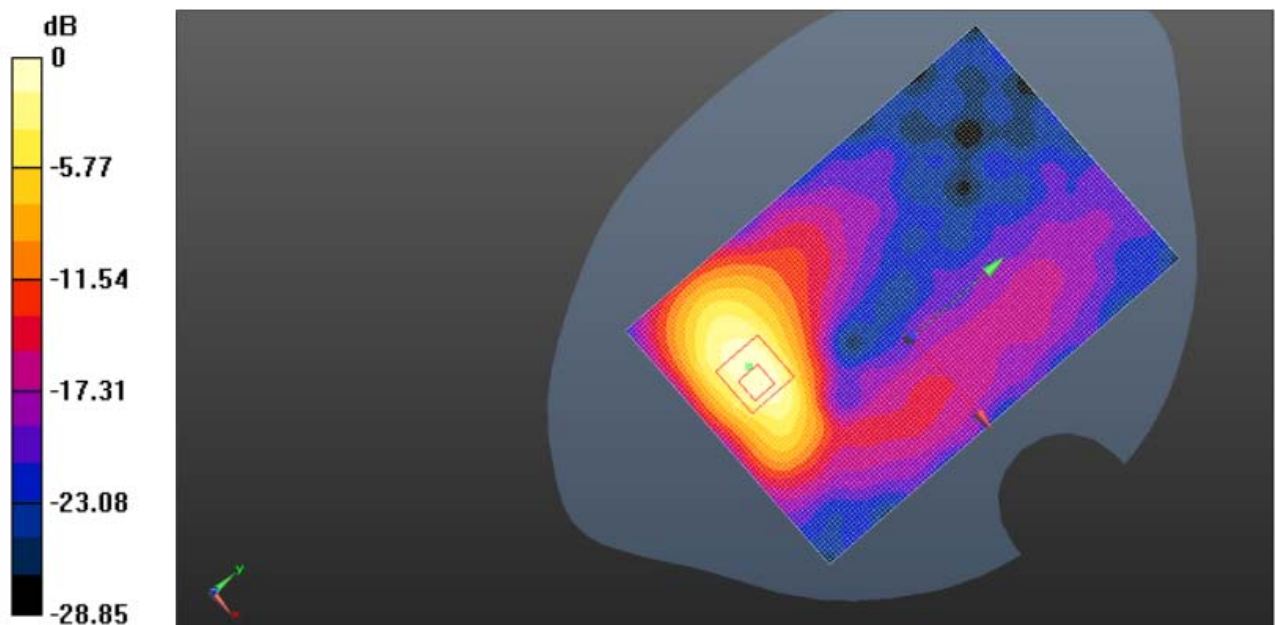

Plot 1: WLAN2450 Rear Side Middle Channel -Channel 1-2412MHz (1Mbps)

6. Calibration Certificate

6.1. Probe Calibration Certificate

Calibration Laboratory of
Schmid & Partner
Engineering AG
Zeughausstrasse 43, 8004 Zurich, Switzerland



S Schweizerischer Kalibrierdienst
C Service suisse d'étalonnage
S Servizio svizzero di taratura
S Swiss Calibration Service

Accredited by the Swiss Accreditation Service (SAS)
The Swiss Accreditation Service is one of the signatories to the EA
Multilateral Agreement for the recognition of calibration certificates

Accreditation No.: SCS 108

Client **CIQ-SZ (Auden)**

Certificate No: EX3-3842_Jun13

CALIBRATION CERTIFICATE

Object **EX3DV4 - SN:3842**

Calibration procedure(s) **QA CAL-01.v8, QA CAL-12.v7, QA CAL-23.v4, QA CAL-25.v4
Calibration procedure for dosimetric E-field probes**

Calibration date: **June 6, 2014**

This calibration certificate documents the traceability to national standards, which realize the physical units of measurements (SI).
The measurements and the uncertainties with confidence probability are given on the following pages and are part of the certificate.

All calibrations have been conducted in the closed laboratory facility: environment temperature (22 ± 3)°C and humidity < 70%.

Calibration Equipment used (M&TE critical for calibration)

Primary Standards	ID	Cal Date (Certificate No.)	Scheduled Calibration
Power meter E4419B	GB41293874	04-Apr-13 (No. 217-01733)	Apr-14
Power sensor E4412A	MY41498087	04-Apr-13 (No. 217-01733)	Apr-14
Reference 3 dB Attenuator	SN: S5054 (3c)	04-Apr-13 (No. 217-01737)	Apr-14
Reference 20 dB Attenuator	SN: S5277 (20x)	04-Apr-13 (No. 217-01735)	Apr-14
Reference 30 dB Attenuator	SN: S5129 (30b)	04-Apr-13 (No. 217-01738)	Apr-14
Reference Probe ES3DV2	SN: 3013	28-Dec-12 (No. ES3-3013_Dec12)	Dec-13
DAE4	SN: 660	31-Jan-13 (No. DAE4-660_Jan13)	Jan-14
Secondary Standards	ID	Check Date (in house)	Scheduled Check
RF generator HP 8648C	US3642U01700	4-Aug-99 (in house check Apr-13)	In house check: Apr-15
Network Analyzer HP 8753E	US37390585	18-Oct-01 (in house check Oct-12)	In house check: Oct-13

	Name	Function	Signature
Calibrated by:	Jeton Kastrati	Laboratory Technician	
Approved by:	Katja Pokovic	Technical Manager	
			Issued: June 6, 2014

This calibration certificate shall not be reproduced except in full without written approval of the laboratory.

**Calibration Laboratory of
Schmid & Partner
Engineering AG**
Zeughausstrasse 43, 8004 Zurich, Switzerland



S Schweizerischer Kalibrierdienst
C Service suisse d'étalonnage
S Servizio svizzero di taratura
S Swiss Calibration Service

Accredited by the Swiss Accreditation Service (SAS)

The Swiss Accreditation Service is one of the signatories to the EA
Multilateral Agreement for the recognition of calibration certificates

Accreditation No.: **SCS 108**

Glossary:

TSL	tissue simulating liquid
NORM _{x,y,z}	sensitivity in free space
ConvF	sensitivity in TSL / NORM _{x,y,z}
DCP	diode compression point
CF	crest factor (1/duty_cycle) of the RF signal
A, B, C, D	modulation dependent linearization parameters
Polarization φ	φ rotation around probe axis
Polarization ϑ	ϑ rotation around an axis that is in the plane normal to probe axis (at measurement center), i.e., $\vartheta = 0$ is normal to probe axis

Calibration is Performed According to the Following Standards:

- IEEE Std 1528-2013, "IEEE Recommended Practice for Determining the Peak Spatial-Averaged Specific Absorption Rate (SAR) in the Human Head from Wireless Communications Devices: Measurement Techniques", December 2013
- IEC 62209-1, "Procedure to measure the Specific Absorption Rate (SAR) for hand-held devices used in close proximity to the ear (frequency range of 300 MHz to 3 GHz)", February 2005

Methods Applied and Interpretation of Parameters:

- NORM_{x,y,z}**: Assessed for E-field polarization $\vartheta = 0$ ($f \leq 900$ MHz in TEM-cell; $f > 1800$ MHz: R22 waveguide). NORM_{x,y,z} are only intermediate values, i.e., the uncertainties of NORM_{x,y,z} does not affect the E²-field uncertainty inside TSL (see below ConvF).
- NORM(f)_{x,y,z}** = NORM_{x,y,z} * frequency_response (see Frequency Response Chart). This linearization is implemented in DASY4 software versions later than 4.2. The uncertainty of the frequency response is included in the stated uncertainty of ConvF.
- DCP_{x,y,z}**: DCP are numerical linearization parameters assessed based on the data of power sweep with CW signal (no uncertainty required). DCP does not depend on frequency nor media.
- PAR**: PAR is the Peak to Average Ratio that is not calibrated but determined based on the signal characteristics
- A_{x,y,z}; B_{x,y,z}; C_{x,y,z}; D_{x,y,z}; VR_{x,y,z}**: A, B, C, D are numerical linearization parameters assessed based on the data of power sweep for specific modulation signal. The parameters do not depend on frequency nor media. VR is the maximum calibration range expressed in RMS voltage across the diode.
- ConvF and Boundary Effect Parameters**: Assessed in flat phantom using E-field (or Temperature Transfer Standard for $f \leq 800$ MHz) and inside waveguide using analytical field distributions based on power measurements for $f > 800$ MHz. The same setups are used for assessment of the parameters applied for boundary compensation (alpha, depth) of which typical uncertainty values are given. These parameters are used in DASY4 software to improve probe accuracy close to the boundary. The sensitivity in TSL corresponds to NORM_{x,y,z} * ConvF whereby the uncertainty corresponds to that given for ConvF. A frequency dependent ConvF is used in DASY version 4.4 and higher which allows extending the validity from ± 50 MHz to ± 100 MHz.
- Spherical isotropy (3D deviation from isotropy)**: in a field of low gradients realized using a flat phantom exposed by a patch antenna.
- Sensor Offset**: The sensor offset corresponds to the offset of virtual measurement center from the probe tip (on probe axis). No tolerance required.

EX3DV4 – SN:3842

June 6, 2014

Probe EX3DV4

SN:3842

Manufactured: October 25, 2011
Repaired: June 3, 2014
Calibrated: June 6, 2014

Calibrated for DASY/EASY Systems
(Note: non-compatible with DASY2 system!)

EX3DV4- SN:3842

June 6, 2014

DASY/EASY - Parameters of Probe: EX3DV4 - SN:3842**Basic Calibration Parameters**

	Sensor X	Sensor Y	Sensor Z	Unc (k=2)
Norm ($\mu\text{V}/(\text{V}/\text{m})^2$) ^A	0.35	0.52	0.42	$\pm 10.1 \%$
DCP (mV) ^B	104.7	100.4	100.5	

Modulation Calibration Parameters

UID	Communication System Name		A dB	B dB $\sqrt{\mu\text{V}}$	C	D dB	VR mV	Unc ^E (k=2)
0	CW	X	0.0	0.0	1.0	0.00	132.3	$\pm 3.5 \%$
		Y	0.0	0.0	1.0		162.7	
		Z	0.0	0.0	1.0		147.6	

The reported uncertainty of measurement is stated as the standard uncertainty of measurement multiplied by the coverage factor k=2, which for a normal distribution corresponds to a coverage probability of approximately 95%.

^A The uncertainties of NormX,Y,Z do not affect the E²-field uncertainty inside TSL (see Pages 5 and 6).

^B Numerical linearization parameter: uncertainty not required.

^E Uncertainty is determined using the max. deviation from linear response applying rectangular distribution and is expressed for the square of the field value.

EX3DV4- SN:3842

June 6, 2014

DASY/EASY - Parameters of Probe: EX3DV4 - SN:3842**Calibration Parameter Determined in Head Tissue Simulating Media**

f (MHz) ^C	Relative Permittivity ^F	Conductivity (S/m) ^F	ConvF X	ConvF Y	ConvF Z	Alpha	Depth (mm)	Unct. (k=2)
450	43.5	0.87	10.00	10.00	10.00	0.15	1.10	± 13.4 %
835	41.5	0.91	8.83	8.83	8.83	0.28	1.07	± 12.0 %
900	41.5	0.97	8.78	8.78	8.78	0.32	1.00	± 12.0 %
1810	40.0	1.40	7.68	7.68	7.68	0.38	0.88	± 12.0 %
1900	40.0	1.40	7.55	7.55	7.55	0.50	0.77	± 12.0 %
2450	39.2	1.80	7.26	7.26	7.26	0.71	0.63	± 12.0 %

^C Frequency validity of ± 100 MHz only applies for DASY v4.4 and higher (see Page 2), else it is restricted to ± 50 MHz. The uncertainty is the RSS of the ConvF uncertainty at calibration frequency and the uncertainty for the indicated frequency band.

^F At frequencies below 3 GHz, the validity of tissue parameters (ϵ and σ) can be relaxed to ± 10% if liquid compensation formula is applied to measured SAR values. At frequencies above 3 GHz, the validity of tissue parameters (ϵ and σ) is restricted to ± 5%. The uncertainty is the RSS of the ConvF uncertainty for indicated target tissue parameters.

EX3DV4- SN:3842

June 6, 2014

DASY/EASY - Parameters of Probe: EX3DV4 - SN:3842

Calibration Parameter Determined in Body Tissue Simulating Media

f (MHz) ^C	Relative Permittivity ^F	Conductivity (S/m) ^F	ConvF X	ConvF Y	ConvF Z	Alpha	Depth (mm)	Unct. (k=2)
450	56.7	0.94	10.34	10.34	10.34	0.09	1.00	± 13.4 %
835	55.2	0.98	9.09	9.09	9.09	0.42	0.84	± 12.0 %
900	55.0	1.05	9.16	9.16	9.16	0.47	0.79	± 12.0 %
1810	53.3	1.52	7.78	7.78	7.78	0.50	0.81	± 12.0 %
1900	53.3	1.52	7.43	7.43	7.43	0.29	1.07	± 12.0 %
2450	52.7	1.95	6.93	6.93	6.93	0.80	0.59	± 12.0 %

^C Frequency validity of ± 100 MHz only applies for DASY v4.4 and higher (see Page 2), else it is restricted to ± 50 MHz. The uncertainty is the RSS of the ConvF uncertainty at calibration frequency and the uncertainty for the indicated frequency band.

^F At frequencies below 3 GHz, the validity of tissue parameters (ϵ and α) can be relaxed to ± 10% if liquid compensation formula is applied to measured SAR values. At frequencies above 3 GHz, the validity of tissue parameters (ϵ and α) is restricted to ± 5%. The uncertainty is the RSS of the ConvF uncertainty for indicated target tissue parameters.

EX3DV4- SN:3842

June 6, 2014

Frequency Response of E-Field (TEM-Cell: ifi110 EXX, Waveguide: R22)

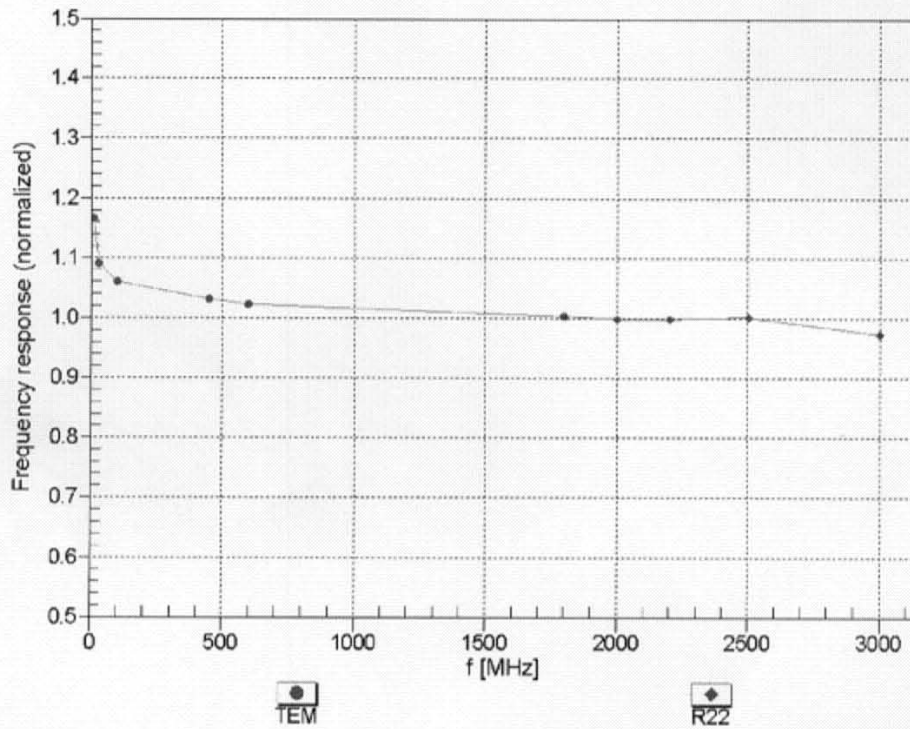

Uncertainty of Frequency Response of E-field: $\pm 6.3\%$ (k=2)

EX3DV4- SN:3842

June 6, 2014

Receiving Pattern (ϕ), $\theta = 0^\circ$

f=600 MHz, TEM

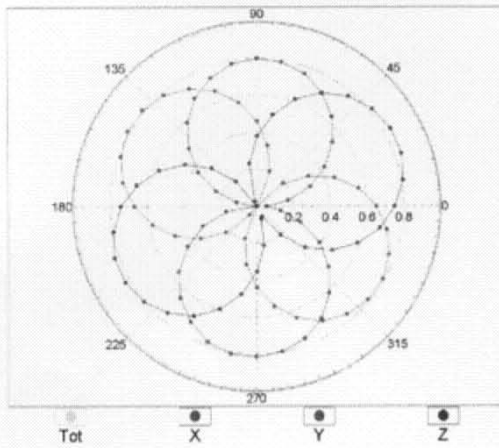

f=1800 MHz, R22

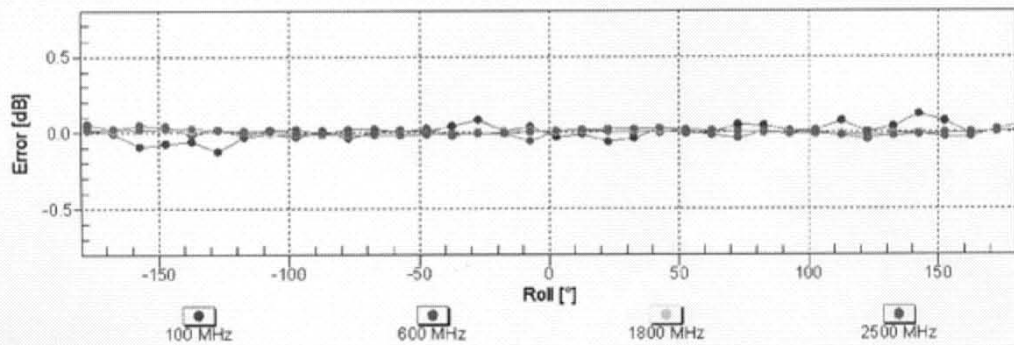
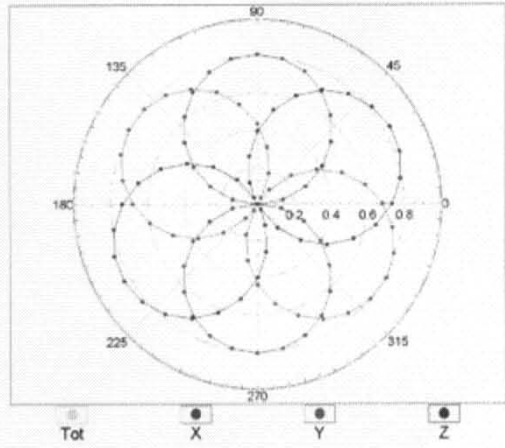

Uncertainty of Axial Isotropy Assessment: $\pm 0.5\%$ ($k=2$)

EX3DV4- SN:3842

June 6, 2014

Dynamic Range $f(\text{SAR}_{\text{head}})$ (TEM cell , $f = 900 \text{ MHz}$)

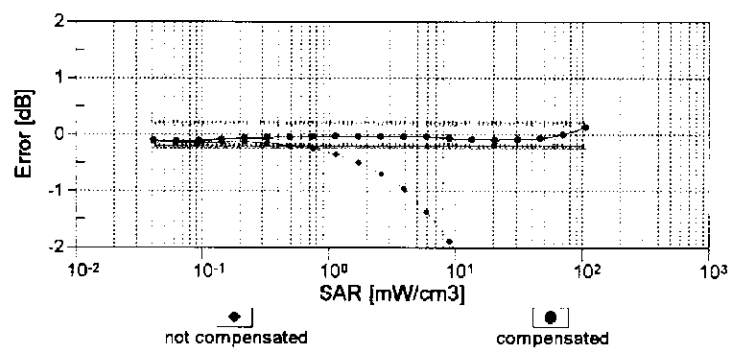
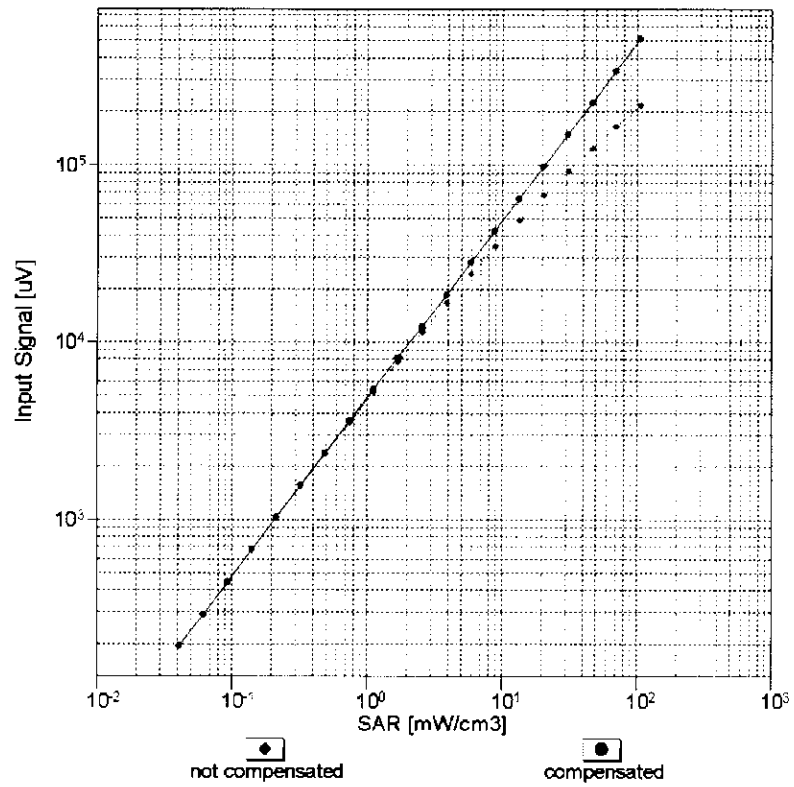

Uncertainty of Linearity Assessment: $\pm 0.6\%$ ($k=2$)

EX3DV4- SN:3842

June 6, 2014

Conversion Factor Assessment

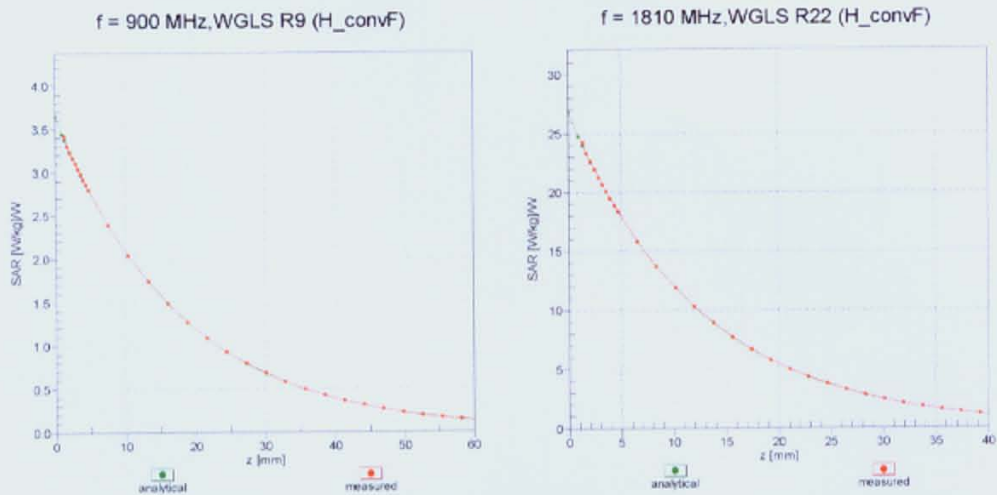

Deviation from Isotropy in Liquid

Error (ϕ, θ), f = 900 MHz

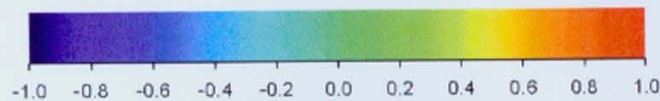
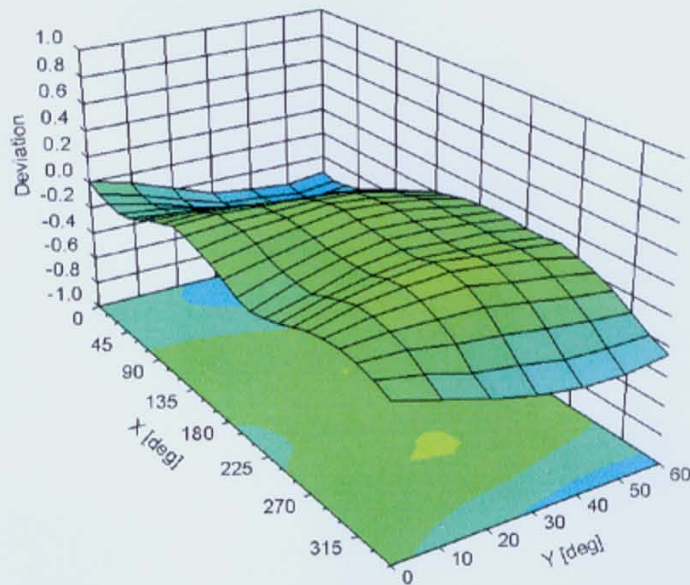

Uncertainty of Spherical Isotropy Assessment: $\pm 2.6\%$ (k=2)

EX3DV4- SN:3842

June 6, 2014

DASY/EASY - Parameters of Probe: EX3DV4 - SN:3842**Other Probe Parameters**

Sensor Arrangement	Triangular
Connector Angle (°)	-117.4
Mechanical Surface Detection Mode	enabled
Optical Surface Detection Mode	disabled
Probe Overall Length	337 mm
Probe Body Diameter	10 mm
Tip Length	9 mm
Tip Diameter	2.5 mm
Probe Tip to Sensor X Calibration Point	1 mm
Probe Tip to Sensor Y Calibration Point	1 mm
Probe Tip to Sensor Z Calibration Point	1 mm
Recommended Measurement Distance from Surface	2 mm

6.2. D2450V2 Dipole Calibration Certificate



In Collaboration with
s p e a g
 CALIBRATION LABORATORY

Add: No.52 Huayuanbei Road, Haidian District, Beijing, 100191, China
 Tel: +86-10-62304633-2079 Fax: +86-10-62304633-2504
 E-mail: Info@emcite.com Http://www.emcite.com

Client **CIQ SZ (Auden)**Certificate No: **J13-2-3053****CALIBRATION CERTIFICATE**Object **D2450V2 - SN: 884**

Calibration Procedure(s) **TMC-OS-E-02-194**
Calibration procedure for dipole validation kits

Calibration date: **December 11, 2013**

This calibration Certificate documents the traceability to national standards, which realize the physical units of measurements(SI). The measurements and the uncertainties with confidence probability are given on the following pages and are part of the certificate.

All calibrations have been conducted in the closed laboratory facility: environment temperature(22±3)°C and humidity<70%.

Calibration Equipment used (M&TE critical for calibration)

Primary Standards	ID #	Cal Date(Calibrated by, Certificate No.)	Scheduled Calibration
Power Meter NRVD	102083	11-Sep-13 (TMC, No.JZ13-443)	Sep-14
Power sensor NRV-Z5	100595	11-Sep-13 (TMC, No. JZ13-443)	Sep -14
Reference Probe ES3DV3	SN 3149	5- Sep-13 (SPEAG, No.ES3-3149_Sep13)	Sep-14
DAE4	SN 777	22-Feb-13 (SPEAG, DAE4-777_Feb13)	Feb -14
Signal Generator E4438C	MY49070393	13-Nov-13 (TMC, No.JZ13-394)	Nov-14
Network Analyzer E8362B	MY43021135	19-Oct-13 (TMC, No.JZ13-278)	Oct-14

	Name	Function	Signature
Calibrated by:	Zhao Jing	SAR Test Engineer	
Reviewed by:	Qi Dianyuan	SAR Project Leader	
Approved by:	Lu Bingsong	Deputy Director of the laboratory	

Issued: December 17, 2013

This calibration certificate shall not be reproduced except in full without written approval of the laboratory.



Add: No.52 Huayuanbei Road, Haidian District, Beijing, 100191, China
 Tel: +86-10-62304633-2079 Fax: +86-10-62304633-2504
 E-mail: Info@emcite.com [Http://www.emcite.com](http://www.emcite.com)

Glossary:

TSL	tissue simulating liquid
ConvF	sensitivity in TSL / NORM _{x,y,z}
N/A	not applicable or not measured

Calibration is Performed According to the Following Standards:

- IEEE Std 1528-2013, "IEEE Recommended Practice for Determining the Peak Spatial-Averaged Specific Absorption Rate (SAR) in the Human Head from Wireless Communications Devices: Measurement Techniques", June 2013
- IEC 62209-1, "Procedure to measure the Specific Absorption Rate (SAR) For hand-held devices used in close proximity to the ear (frequency range of 300MHz to 3GHz)", February 2005
- KDB865664, SAR Measurement Requirements for 100 MHz to 6 GHz

Additional Documentation:

- DASY4/5 System Handbook

Methods Applied and Interpretation of Parameters:

- Measurement Conditions:** Further details are available from the Validation Report at the end of the certificate. All figures stated in the certificate are valid at the frequency indicated.
- Antenna Parameters with TSL:** The dipole is mounted with the spacer to position its feed point exactly below the center marking of the flat phantom section, with the arms oriented parallel to the body axis.
- Feed Point Impedance and Return Loss:** These parameters are measured with the dipole positioned under the liquid filled phantom. The impedance stated is transformed from the measurement at the SMA connector to the feed point. The Return Loss ensures low reflected power. No uncertainty required.
- Electrical Delay:** One-way delay between the SMA connector and the antenna feed point. No uncertainty required.
- SAR measured:** SAR measured at the stated antenna input power.
- SAR normalized:** SAR as measured, normalized to an input power of 1 W at the antenna connector.
- SAR for nominal TSL parameters:** The measured TSL parameters are used to calculate the nominal SAR result.

The reported uncertainty of measurement is stated as the standard uncertainty of Measurement multiplied by the coverage factor $k=2$, which for a normal distribution Corresponds to a coverage probability of approximately 95%.



In Collaboration with
s p e a g
CALIBRATION LABORATORY

Add: No.52 Huayuanbei Road, Haidian District, Beijing, 100191, China
Tel: +86-10-62304633-2079 Fax: +86-10-62304633-2504
E-mail: Info@emcite.com [Http://www.emcite.com](http://www.emcite.com)

Measurement Conditions

DASY system configuration, as far as not given on page 1.

DASY Version	DASY52	52.8.7.1137
Extrapolation	Advanced Extrapolation	
Phantom	Twin Phantom	
Distance Dipole Center - TSL	10 mm	with Spacer
Zoom Scan Resolution	dx, dy, dz = 5 mm	
Frequency	2450 MHz \pm 1 MHz	

Head TSL parameters

The following parameters and calculations were applied.

	Temperature	Permittivity	Conductivity
Nominal Head TSL parameters	22.0 °C	39.2	1.80 mho/m
Measured Head TSL parameters	(22.0 \pm 0.2) °C	39.0 \pm 6 %	1.82 mho/m \pm 6 %
Head TSL temperature change during test	<0.5 °C	----	----

SAR result with Head TSL

SAR averaged over 1 cm^3 (1 g) of Head TSL	Condition	
SAR measured	250 mW input power	13.0 mW / g
SAR for nominal Head TSL parameters	normalized to 1W	51.7 mW / g \pm 20.8 % (k=2)
SAR averaged over 10 cm^3 (10 g) of Head TSL	Condition	
SAR measured	250 mW input power	6.05 mW / g
SAR for nominal Head TSL parameters	normalized to 1W	24.1 mW / g \pm 20.4 % (k=2)

Body TSL parameters

The following parameters and calculations were applied.

	Temperature	Permittivity	Conductivity
Nominal Body TSL parameters	22.0 °C	52.7	1.95 mho/m
Measured Body TSL parameters	(22.0 \pm 0.2) °C	52.8 \pm 6 %	1.94 mho/m \pm 6 %
Body TSL temperature change during test	<0.5 °C	----	----

SAR result with Body TSL

SAR averaged over 1 cm^3 (1 g) of Body TSL	Condition	
SAR measured	250 mW input power	12.9 mW / g
SAR for nominal Body TSL parameters	normalized to 1W	51.8 mW / g \pm 20.8 % (k=2)
SAR averaged over 10 cm^3 (10 g) of Body TSL	Condition	
SAR measured	250 mW input power	5.98 mW / g
SAR for nominal Body TSL parameters	normalized to 1W	24.0 mW / g \pm 20.4 % (k=2)



In Collaboration with

s p e a g**CALIBRATION LABORATORY**

Add: No.52 Huayuanbei Road, Haidian District, Beijing, 100191, China

Tel: +86-10-62304633-2079

Fax: +86-10-62304633-2504

E-mail: Info@emcite.com

Http://www.emcite.com

Appendix

Antenna Parameters with Head TSL

Impedance, transformed to feed point	46.8Ω+ 3.76jΩ
Return Loss	- 25.9dB

Antenna Parameters with Body TSL

Impedance, transformed to feed point	55.2Ω+ 2.38jΩ
Return Loss	- 25.4dB

General Antenna Parameters and Design

Electrical Delay (one direction)	1.199 ns
----------------------------------	----------

After long term use with 100W radiated power, only a slight warming of the dipole near the feedpoint can be measured.

The dipole is made of standard semirigid coaxial cable. The center conductor of the feeding line is directly connected to the second arm of the dipole. The antenna is therefore short-circuited for DC-signals. On some of the dipoles, small end caps are added to the dipole arms in order to improve matching when loaded according to the position as explained in the "Measurement Conditions" paragraph. The SAR data are not affected by this change. The overall dipole length is still according to the Standard.

No excessive force must be applied to the dipole arms, because they might bend or the soldered connections near the feedpoint may be damaged.

Additional EUT Data

Manufactured by	SPEAG
-----------------	-------



Add: No.52 Huayuanbei Road, Haidian District, Beijing, 100191, China
Tel: +86-10-62304633-2079 Fax: +86-10-62304633-2504
E-mail: Info@emcite.com [Http://www.emcite.com](http://www.emcite.com)

DASY5 Validation Report for Head TSL

Date: 12.10.2013

Test Laboratory: TMC, Beijing, China

DUT: Dipole 2450 MHz; Type: D2450V2; Serial: D2450V2 - SN: 884

Communication System: CW; Frequency: 2450 MHz

Medium parameters used: $f = 2450$ MHz; $\sigma = 1.817$ mho/m; $\epsilon_r = 38.96$; $\rho = 1000$ kg/m³

Phantom section: Flat Section

Measurement Standard: DASY5 (IEEE/IEC/ANSI C63.19-2007)

DASY5 Configuration:

- Probe: ES3DV3 - SN3149; ConvF(4.48,4.48,4.48); Calibrated: 2013/9/5
- Sensor-Surface: 3mm (Mechanical Surface Detection)
- Electronics: DAE4 Sn777; Calibrated: 22/2/2013
- Phantom: SAM 1593; Type: QD000P40CC;
- DASY52 52.8.7(1137); SEMCAD X Version 14.6.10 (7164)

Dipole Calibration for Head Tissue/Pin=250mW, d=10mm/Zoom Scan

(7x7x7)/Cube 0: Measurement grid: dx=5mm, dy=5mm, dz=5mm

Reference Value = 86.529 V/m; Power Drift = -0.07 dB

Peak SAR (extrapolated) = 27.0 W/kg

SAR(1 g) = 13 W/kg; SAR(10 g) = 6.05 W/kg

Maximum value of SAR (measured) = 16.2 W/kg

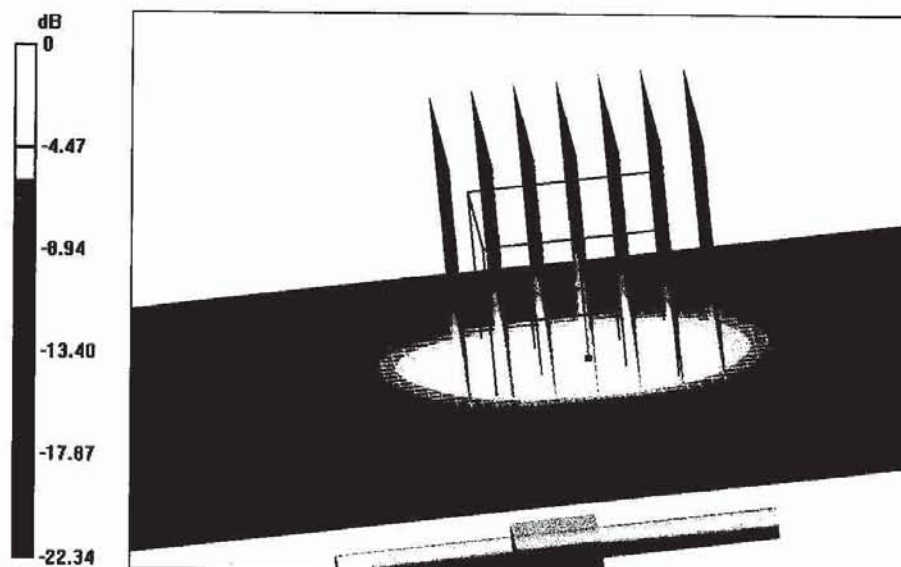

0 dB = 16.2 W/kg = 12.10 dBW/kg



In Collaboration with
s p e a g
CALIBRATION LABORATORY

Add: No.52 Huayuanbei Road, Haidian District, Beijing, 100191, China
Tel: +86-10-62304633-2079 Fax: +86-10-62304633-2504
E-mail: Info@emcite.com [Http://www.emcite.com](http://www.emcite.com)

Impedance Measurement Plot for Head TSL

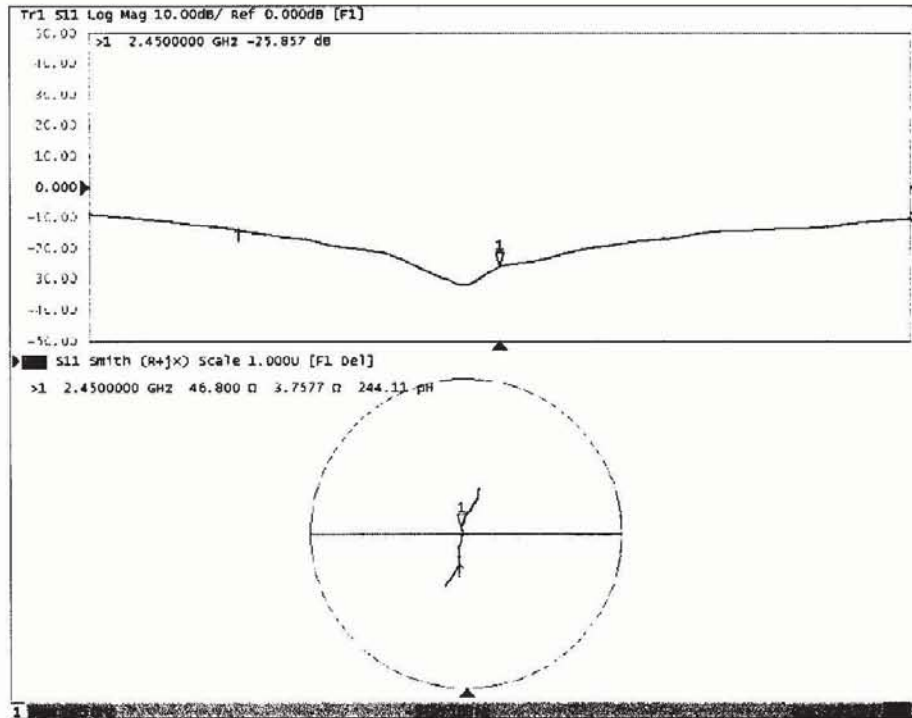



In Collaboration with

s p e a g**CALIBRATION LABORATORY**

Add: No.52 Huayuanbei Road, Haidian District, Beijing, 100191, China
 Tel: +86-10-62304633-2079 Fax: +86-10-62304633-2504
 E-mail: Info@emcite.com Http://www.emcite.com

DASY5 Validation Report for Body TSL

Date: 12.11.2013

Test Laboratory: TMC, Beijing, China

DUT: Dipole 2450 MHz; Type: D2450V2; Serial: D2450V2 - SN: 884

Communication System: CW; Frequency: 2450 MHz;

Medium parameters used: $f = 2450$ MHz; $\sigma = 1.939$ mho/m; $\epsilon_r = 52.97$; $\rho = 1000$ kg/m³

Phantom section: Flat Phantom

Measurement Standard: DASY5 (IEEE/IEC/ANSI C63.19-2007)

DASY5 Configuration:

- Probe: ES3DVS - SN3149; ConvF(4.21,4.21,4.21) ; Calibrated: 2013/9/5
- Sensor-Surface: 3mm (Mechanical Surface Detection)
- Electronics: DAE4 Sn777; Calibrated: 22/2/2013
- Phantom: SAM1186; Type: QD000P40CC;
- DASY52 52.8.7(1137); SEMCAD X Version 14.6.10 (7164)

Dipole Calibration for Body Tissue/Pin=250mW, d=10mm/Zoom Scan

(7x7x7)/Cube 0: Measurement grid: dx=5mm, dy=5mm, dz=5mm

Reference Value = 84.687 V/m; Power Drift = -0.03 dB

Peak SAR (extrapolated) = 27.1 W/kg

SAR(1 g) = 12.9 W/kg; SAR(10 g) = 5.98 W/kg

Maximum value of SAR (measured) = 16.0 W/kg

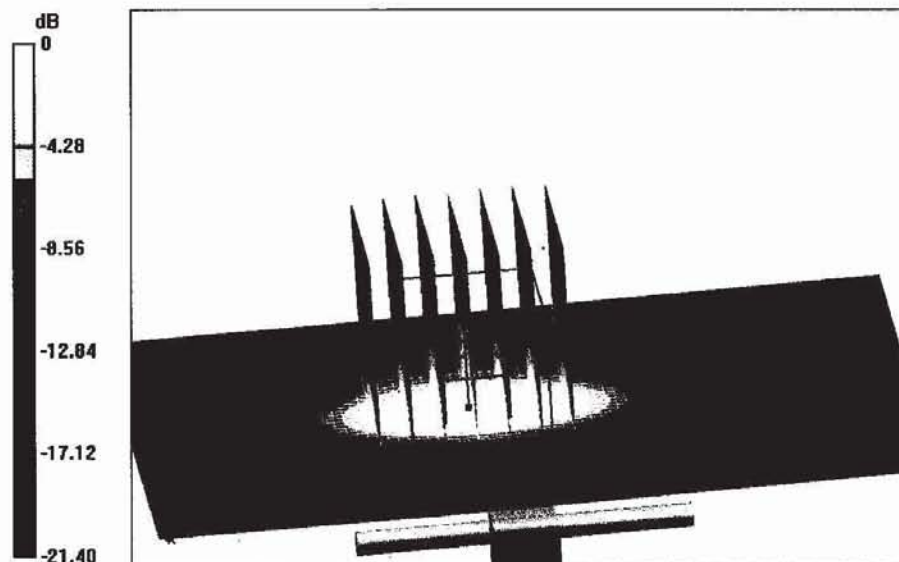

0 dB = 16.0 W/kg = 12.04 dBW/kg



In Collaboration with
s p e a g
CALIBRATION LABORATORY

Add: No.52 Huayuanbei Road, Haidian District, Beijing, 100191, China
Tel: +86-10-62304633-2079 Fax: +86-10-62304633-2504
E-mail: Info@emcite.com [Http://www.emcite.com](http://www.emcite.com)

Impedance Measurement Plot for Body TSL

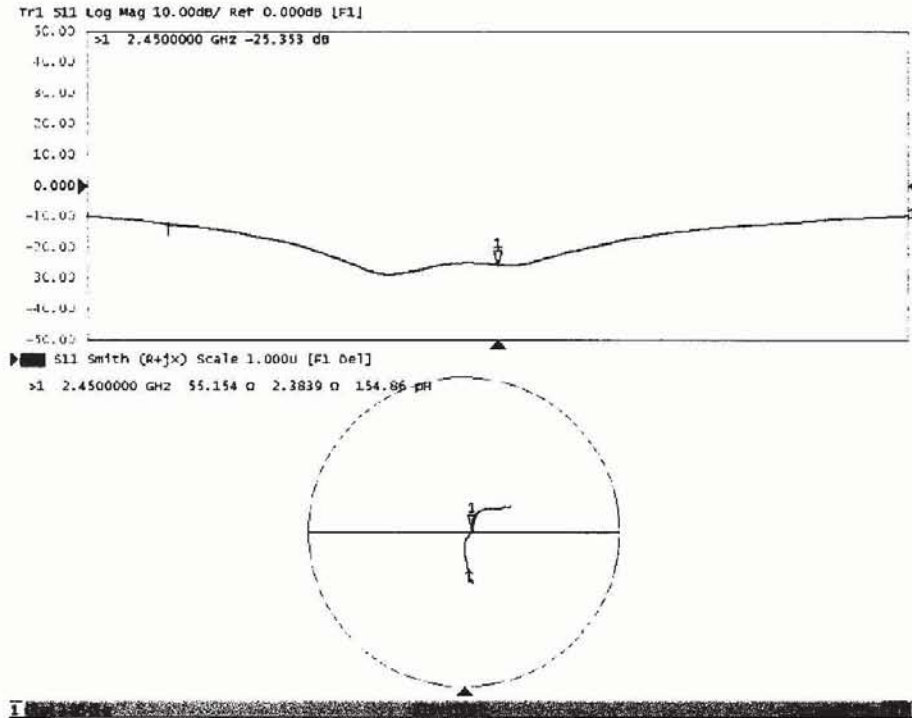

6.3. DAE4 Calibration Certificate



In Collaboration with

s p e a g
 CALIBRATION LABORATORY

 Add: No.52 Huayuanbei Road, Haidian District, Beijing, 100191, China
 Tel: +86-10-62304633-2079 Fax: +86-10-62304633-2504
 E-mail: info@emcite.com Http://www.emcite.com

Client : CIQ SZ (Auden)

Certificate No: J13-2-3048

CALIBRATION CERTIFICATE

Object DAE4 - SN: 1315

 Calibration Procedure(s) TMC-OS-E-01-198
 Calibration Procedure for the Data Acquisition Electronics (DAEx)

Calibration date: November 25, 2013

This calibration Certificate documents the traceability to national standards, which realize the physical units of measurements(SI). The measurements and the uncertainties with confidence probability are given on the following pages and are part of the certificate.

All calibrations have been conducted in the closed laboratory facility: environment temperature(22±3)°C and humidity<70%.

Calibration Equipment used (M&TE critical for calibration)

Primary Standards	ID #	Cal Date(Calibrated by, Certificate No.)	Scheduled Calibration
Documenting Process Calibrator 753	1971018	01-July-13 (TMC, No:JW13-049)	July-14

	Name	Function	Signature
Calibrated by:	Yu zongying	SAR Test Engineer	
Reviewed by:	Qi Dianyuan	SAR Project Leader	
Approved by:	Lu Bingsong	Deputy Director of the laboratory	

Issued: November 25, 2013

This calibration certificate shall not be reproduced except in full without written approval of the laboratory.



In Collaboration with

s p e a g
CALIBRATION LABORATORY

Add: No.52 Huayuanbei Road, Haidian District, Beijing, 100191, China
Tel: +86-10-62304633-2079 Fax: +86-10-62304633-2504
E-mail: Info@emcite.com Http://www.emcite.com

Glossary:

DAE data acquisition electronics
Connector angle information used in DASY system to align probe sensor X to the robot coordinate system.

Methods Applied and Interpretation of Parameters:

- *DC Voltage Measurement:* Calibration Factor assessed for use in DASY system by comparison with a calibrated instrument traceable to national standards. The figure given corresponds to the full scale range of the voltmeter in the respective range.
- *Connector angle:* The angle of the connector is assessed measuring the angle mechanically by a tool inserted. Uncertainty is not required.
- The report provide only calibration results for DAE, it does not contain other performance test results.



In Collaboration with
s p e a g
 CALIBRATION LABORATORY

Add: No.52 Huayuanbei Road, Haidian District, Beijing, 100191, China
 Tel: +86-10-62304633-2079 Fax: +86-10-62304633-2504
 E-mail: Info@emcite.com Http://www.emcite.com

DC Voltage Measurement

A/D - Converter Resolution nominal

High Range: 1LSB = 6.1 μ V, full range = -100...+300 mV

Low Range: 1LSB = 61nV, full range = -1.....+3mV

DASY measurement parameters: Auto Zero Time: 3 sec; Measuring time: 3 sec

Calibration Factors	X	Y	Z
High Range	403.915 \pm 0.15% (k=2)	405.171 \pm 0.15% (k=2)	404.667 \pm 0.15% (k=2)
Low Range	3.98903 \pm 0.7% (k=2)	3.94180 \pm 0.7% (k=2)	3.93862 \pm 0.7% (k=2)

Connector Angle

Connector Angle to be used in DASY system	162.5° \pm 1°
---	-----------------

7. Test Setup Photos



Photograph of the depth in the Body Phantom (2450MHz)

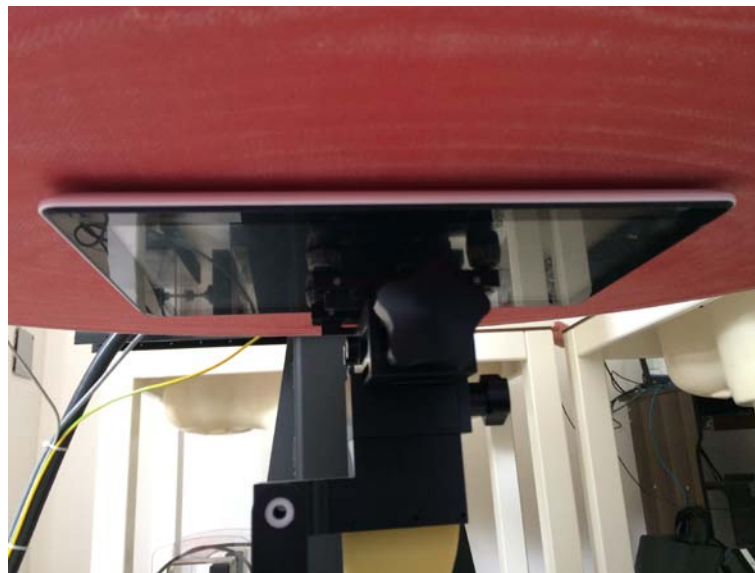

0mm Body Rear Side Setup Photo



0mm Body Top Side Setup Photo



0mm Body Left Side Setup Photo

8. External Photos of the EUT

External photos of the EUT

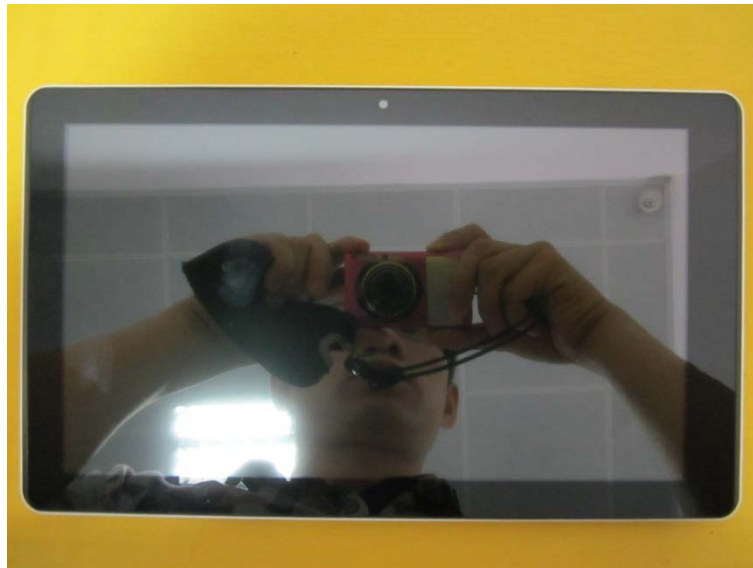





Internal photos of the EUT

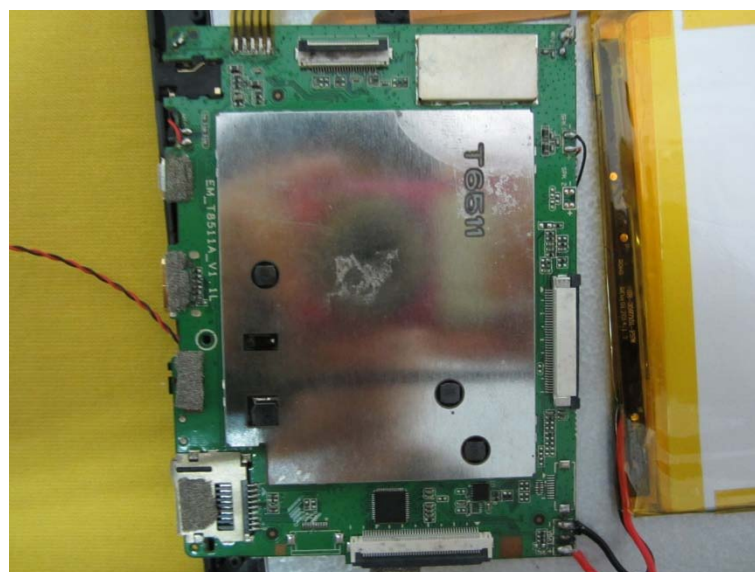
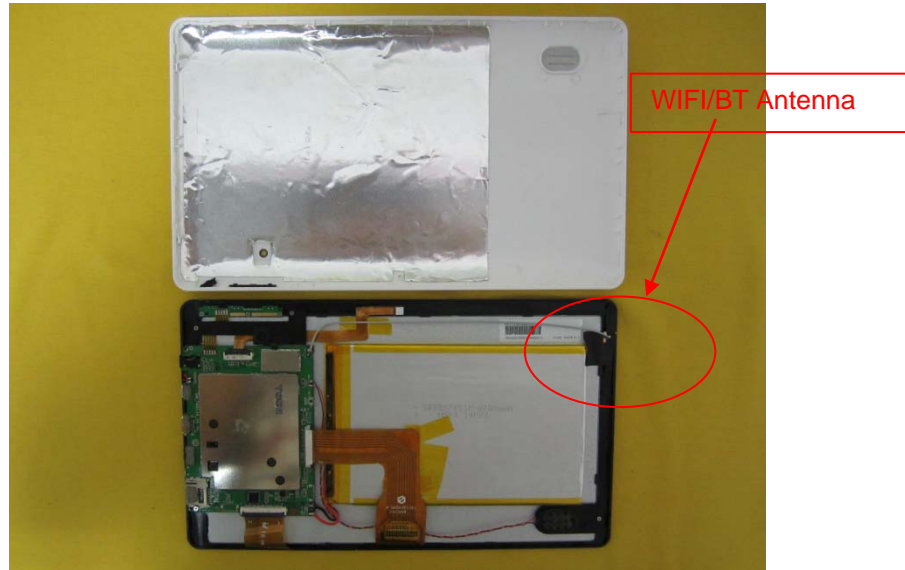

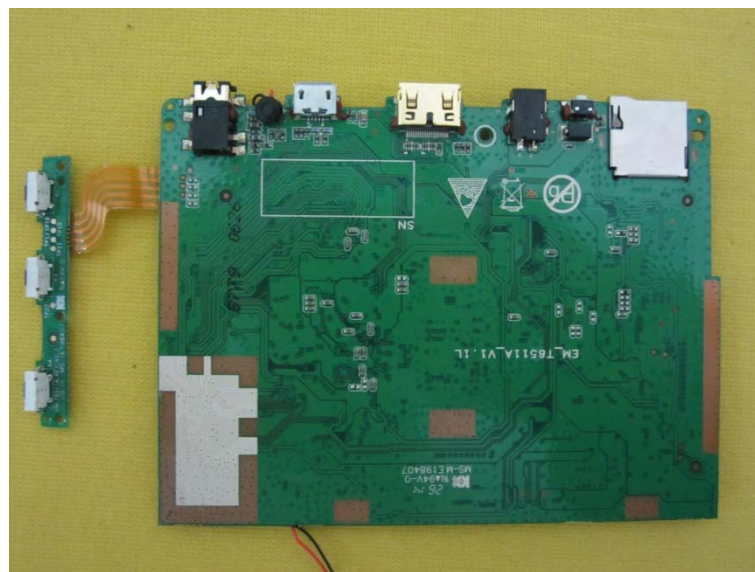
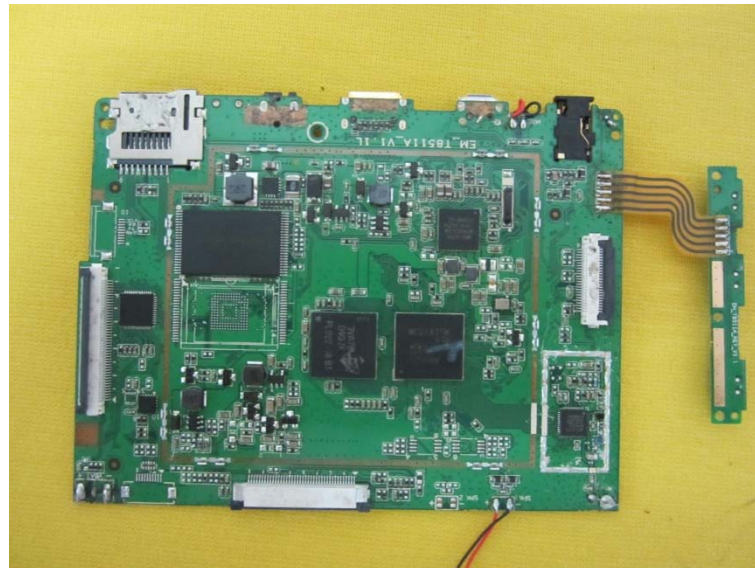

.....End of Report.....