



Shenzhen Certification Technology Service Co., Ltd.
2F, Building B, East Area of Nanchang Second Industrial
Zone, Gushu 2nd Road, Bao'an District, Shenzhen
518126, P.R. China

TEST REPORT

FCC ID: 2AAOJWS-303

Applicant : Wisort Technology Limited
Address : 3F Lixinda Industrial Park, Fuyong No.1 Industrial Zone,
Baoan, Shenzhen, China

Equipment Under Test (EUT):

Name : Bluetooth Speaker
Model : WS-303

In Accordance with: FCC PART 15, SUBPART C: 2013 (Section 15.247)

Report No : CST-TCB141104060
Date of Test : November 17-28, 2014
Date of Issue : December 05, 2014

Test Result: **PASS**

In the configuration tested, the EUT complied with the standards specified above

Authorized Signature

A handwritten signature in black ink that reads "Mark Zhu". The signature is written in a cursive style and is positioned above a horizontal line.

(Mark Zhu)

General Manager

The manufacture should ensure that all the products in series production are in conformity with the product sample detailed in this report. If the product in this report is used in any configuration other than that detailed in the report, the manufacturer must ensure the new system complies with all relevant standards. Any mention of Shenzhen Certification Technology Service Co., Ltd. Or test done by Shenzhen Certification Technology Service Co., Ltd. Approvals in connection with, distribution or use of the product described in this report must be approved by Shenzhen Certification Technology Service Co., Ltd. Approvals in writing.

Contents

1. General Information.....	4
1.1. Description of Device (EUT).....	4
1.2. Accessories of device (EUT).....	4
1.3. Test Lab information.....	4
2. Summary of test	5
2.1. Summary of test result	5
2.2. Assistant equipment used for test.....	5
2.3. Block Diagram	6
2.4. Test mode	6
2.5. Test Conditions.....	7
2.6. Measurement Uncertainty (95% confidence levels, k=2).....	7
2.7. Test Equipment.....	8
3. Maximum Peak Output power	9
3.1. Limit.....	9
3.2. Test Procedure.....	9
3.3. Test Setup.....	9
3.4. Test Result.....	9
4. Bandwidth	10
4.1. Limit.....	10
4.2. Test Procedure.....	10
4.3. Test Result.....	10
5. Carrier Frequency Separation.....	14
5.1. Limit.....	14
5.2. Test Procedure.....	14
5.3. Test Result.....	14
6. Number Of Hopping Channel	20
6.1. Limit.....	20
6.2. Test Procedure.....	20
6.3. Test Result.....	20
7. Dwell Time.....	23
7.1. Test limit	23
7.2. Test Procedure.....	23
7.3. Test Results	23
8. Radiated emissions.....	29
8.1. Limit.....	29
8.2. Block Diagram of Test setup.....	30
8.3. Test Procedure.....	30
8.4. Test Result.....	31
9. Band Edge Compliance	37
9.1. Block Diagram of Test Setup	37
9.2. Limit.....	37
9.3. Test Procedure.....	37

9.4. Test Result.....	37
10. Power Line Conducted Emissions	62
10.1. Block Diagram of Test Setup	62
10.2. Limit.....	62
10.3. Test Procedure.....	62
10.4. Test Result.....	62
11. Antenna Requirements.....	65
12. Test setup photo	66
12.1. Photos of Radiated emission	66
12.2. Photos of Conducted Emission test.....	67
13. Photos of EUT	68

1. General Information

1.1. Description of Device (EUT)

EUT : Bluetooth Speaker

Model No. : WS-303

Trade mark : N/A

Power supply : DC 3.7V From battery or DC 5V From USB For Charge

Radio Technology : Bluetooth 2.1+EDR

Operation frequency : Bluetooth 2.1+EDR: 2402-2480MHz

Modulation : GFSK, $\pi/4$ DQPSK, 8-DPSK,

Channel No. : 79

Antenna Type : PCB Antenna, max gain 0 dBi

Applicant : Wisort Technology Limited

Address : 3F Lixinda Industrial Park, Fuyong No.1 Industrial Zone,
Baoan, Shenzhen, China.

Manufacturer : BONPIE AUDIO LTD.

Address : 3F Lixinda Industrial Park, Fuyong No.1 Industrial Zone,
Baoan, Shenzhen, China.

1.2. Accessories of device (EUT)

N/A

1.3. Test Lab information

Shenzhen Certification Technology Service Co., Ltd.

2F, Building B, East Area of Nanchang Second Industrial Zone,
Gushu 2nd Road, Bao'an District, Shenzhen 518126, P.R. China

FCC Registered No.:197647

IC Registered No.: 8528B

2. Summary of test

2.1. Summary of test result

Description of Test Item	Standard	Results
Maximum Peak Output Power	FCC Part 15: 15.247(b)(1)	PASS
Bandwidth	FCC Part 15: 15.215	PASS
Carrier Frequency Separation	FCC Part 15: 15.247(a)(1)	PASS
Number Of Hopping Channel	FCC Part 15: 15.247(a)(1)(iii)	PASS
Dwell Time	FCC Part 15: 15.247(a)(1)(iii)	PASS
Radiated Emission	FCC Part 15: 15.209 FCC Part 15: 15.247(d)	PASS
Band Edge Compliance	FCC Part 15: 15.247(d)	PASS
Power Line Conducted Emissions	FCC Part 15: 15.207	PASS
Antenna requirement	FCC Part 15: 15.203	PASS

2.2. Assistant equipment used for test

Description	:	Notebook
Manufacturer	:	Acer
Model No.	:	ZQT

2.3. Block Diagram

1, For radiated emissions test: EUT was placed on a turn table, which is 0.8 meter high above ground. EUT was be set into BT TX mode

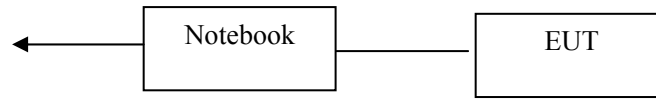

2, For Power Line Conducted Emissions Test: EUT was connected to PC by 1m USB line

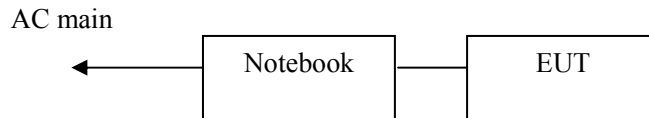

2.4. Test mode

Keep the EUT work in Continuous TX mode, and select test channel, wireless mode

Tested mode, channel, and data rate information		
Mode	Channel	Frequency (MHz)
BDR:GFSK	Low :CH0	2402
	Middle: CH39	2441
	High: CH78	2480
EDR: $\pi/4$ DQPSK	Low :CH0	2402
	Middle: CH39	2441
	High: CH78	2480
EDR:8-DPSK	Low :CH0	2402
	Middle: CH39	2441
	High: CH78	2480

2.5. Test Conditions

Temperature range	22-25°C
Humidity range	40-75%
Pressure range	86-106kPa

2.6. Measurement Uncertainty (95% confidence levels, k=2)

Item	MU	Remark
Uncertainty for Power point Conducted Emissions Test	2.42dB	
Uncertainty for Radiation Emission test in 3m chamber (below 30MHz)	2.13 dB	Polarize: V
	2.57dB	Polarize: H
Uncertainty for Radiation Emission test in 3m chamber (30MHz to 1GHz)	3.54dB	Polarize: V
	4.1dB	Polarize: H
Uncertainty for Radiation Emission test in 3m chamber (1GHz to 25GHz)	2.08dB	Polarize: H
	2.56dB	Polarize: V
Uncertainty for radio frequency	1×10^{-9}	
Uncertainty for conducted RF Power	0.65dB	
Uncertainty for temperature	0.2°C	
Uncertainty for humidity	1%	
Uncertainty for DC and low frequency voltages	0.06%	

2.7. Test Equipment

Equipment	Manufacture	Model No.	Serial No.	Cal. Due day	Cal Interval
3m Semi-Anechoic	ETS-LINDGREN	N/A	SEL0017	2017.01.19	3Year
Spectrum analyzer	Agilent	E4407B	MY49510055	2015.01.19	1Year
Receiver	R&S	ESCI	101165	2015.01.19	1Year
Receiver	R&S	ESCI	101202	2015.01.19	1Year
Bilog Antenna	SCHWARZBECK	VULB 9168	9168-438	2016.01.21	2Year
Horn Antenna	SCHWARZBECK	BBHA 9120 D	BBHA 9120 D(1201)	2016.01.21	2Year
Horn Antenna	SCHWARZBECK	BBHA 9170	BBHA 9170 D(1432)	2016.01.21	2Year
Active Loop Antenna	Beijing Daze	ZN30900A	SEL0097	2016.01.21	1Year
L.I.S.N.	SCHWARZBECK	NSLK8126	8126466	2015.01.19	1Year
Cable	Resenberger	SUCOFLEX 104	MY6562/4	2015.01.19	1Year
Cable	Resenberger	SUCOFLEX 104	309972/4	2015.01.19	1Year
Cable	Resenberger	SUCOFLEX 104	329112/4	2015.01.19	1Year
Power Meter	Anritsu	ML2487A	6K00001491	2015.01.19	1Year
Power sensor	Anritsu	ML2491A	32516	2015.01.19	1Year
Pre-amplifier	SCHWARZBECK	BBV9743	9743-019	2015.01.19	1Year
Pre-amplifier	Quietek	AP-180C	CHM-0602012	2015.01.19	1Year

3. Maximum Peak Output power

3.1. Limit

Please refer section 15.247.

For frequency hopping systems operating in the 2400-2483.5 MHz band employing at least 75 non-overlapping hopping channels, and all frequency hopping systems in the 5725-5850 MHz band: 1 watt. For all other frequency hopping systems in the 2400-2483.5 MHz band: 0.125 watts, the e.i.r.p shall not exceed 4W

3.2. Test Procedure

The transmitter output is connected to the RF Power Meter. The RF Power Meter is set to the peak power detection.

3.3. Test Setup

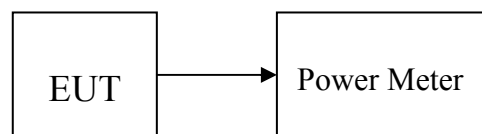

3.4. Test Result

EUT: Bluetooth Speaker		M/N: WS-303			
Test date: 2014-11-28		Test site: RF site		Tested by: Store	
Mode	Freq (MHz)	PK Output Power (dBm)	PK Output Power (mW)	Limit (dBm)	Test result
GFSK	2402	2.15	1.64	21.00	PASS
	2441	2.30	1.70	21.00	
	2480	2.11	1.66	21.00	
$\pi/4$ DQPSK	2402	1.91	1.55	21.00	
	2441	1.84	1.53	21.00	
	2480	1.89	1.55	21.00	
8-DPSK	2402	1.83	1.52	21.00	
	2441	1.79	1.51	21.00	
	2480	1.87	1.54	21.00	

4. Bandwidth

4.1. Limit

Intentional radiators operating under the alternative provisions to the general emission limits, as contained in §§ 15.217 through 15.257 and in Subpart E of this part, must be designed to ensure that the 20 dB bandwidth of the emission, or whatever bandwidth may otherwise be specified in the specific rule section under which the equipment operates, is contained within the frequency band designated in the rule section under which the equipment is operated.

4.2. Test Procedure

The transmitter output was coupled to a spectrum analyzer via a antenna. The bandwidth of the fundamental frequency was measured by spectrum analyzer with $RBW \geq 1\%$ of the 20dB bandwidth and $VBW \geq RBW$. The 20dB bandwidth is defined as the total spectrum the power of which is higher than peak power minus 20dB.

4.3. Test Result

EUT: Bluetooth Speaker		M/N: WS-303		
Test date: 2014-11-28		Test site: RF site		Tested by: Store
Mode	Freq (MHz)	20dB Bandwidth (MHz)	Limit (kHz)	Conclusion
GFSK	2402	0.5602	N/A	PASS
	2441	0.5130		
	2480	0.5136		
Pi/4-DQPSK	2402	1.032		
	2441	1.033		
	2480	1.030		
8-DPSK	2402	1.115		
	2441	1.157		
	2480	1.158		

Original Test data For 20dB bandwidth
GFSK

Lowest CH

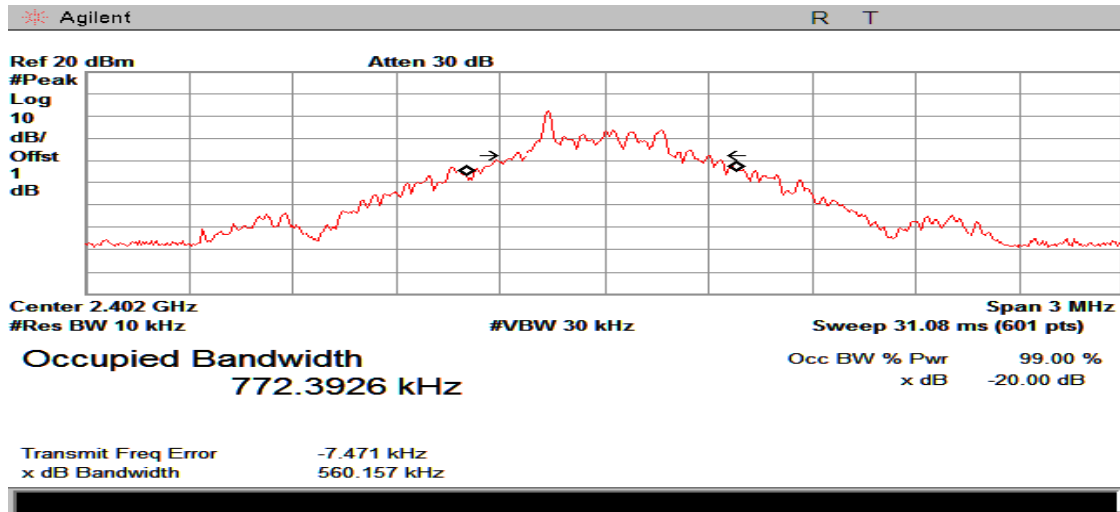

Middle CH

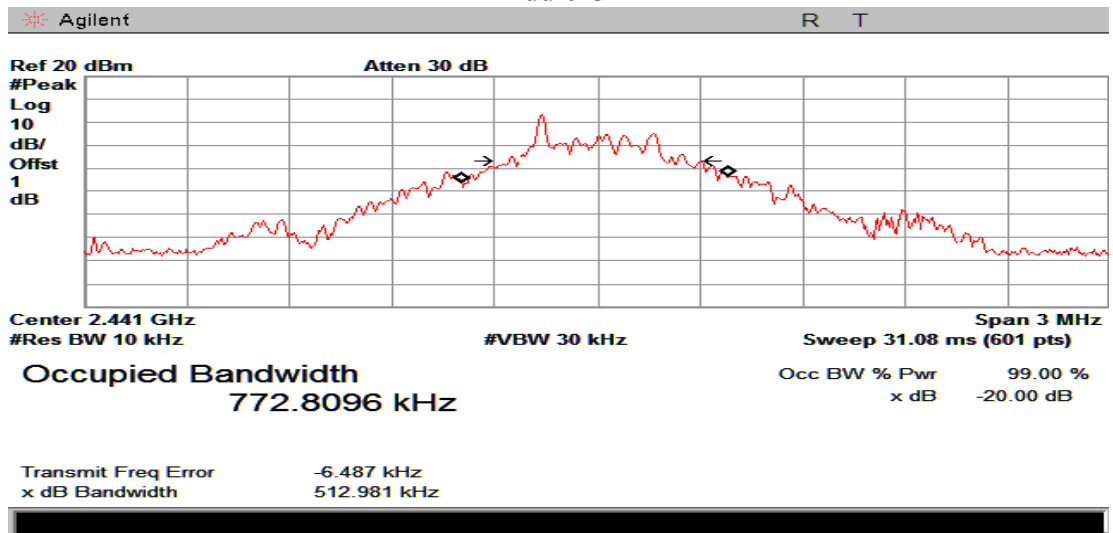

Highest CH

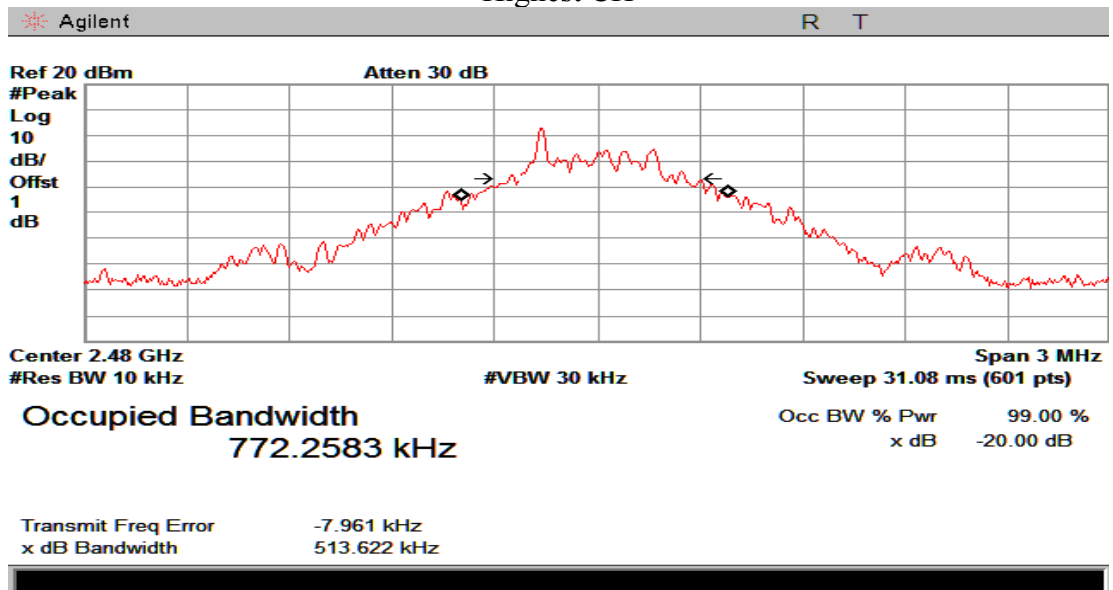

Pi/4-DQPSK

Lowest CH

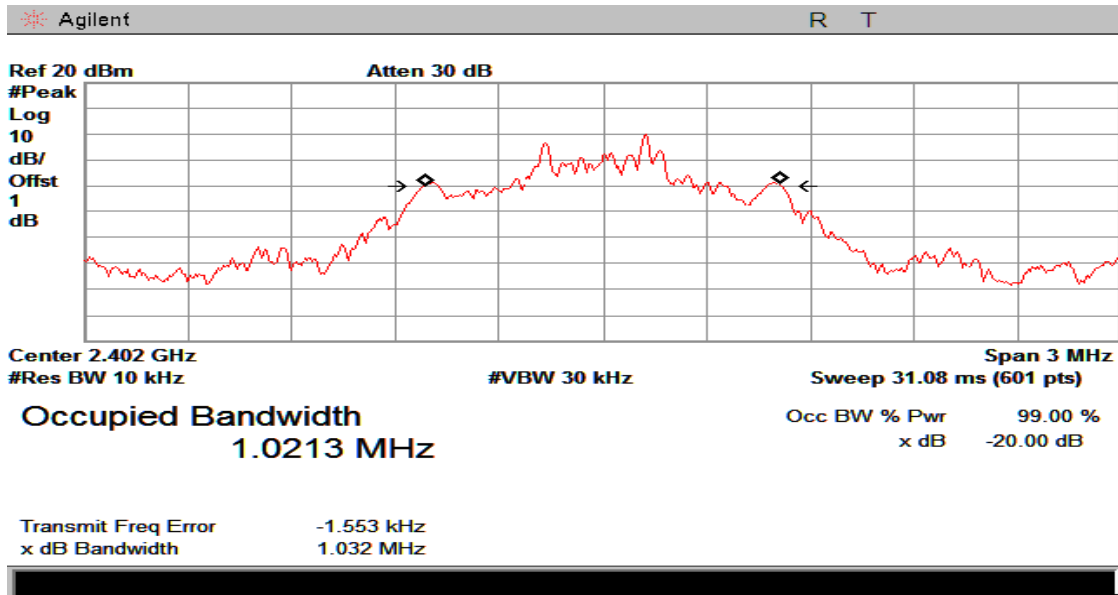

Middle CH

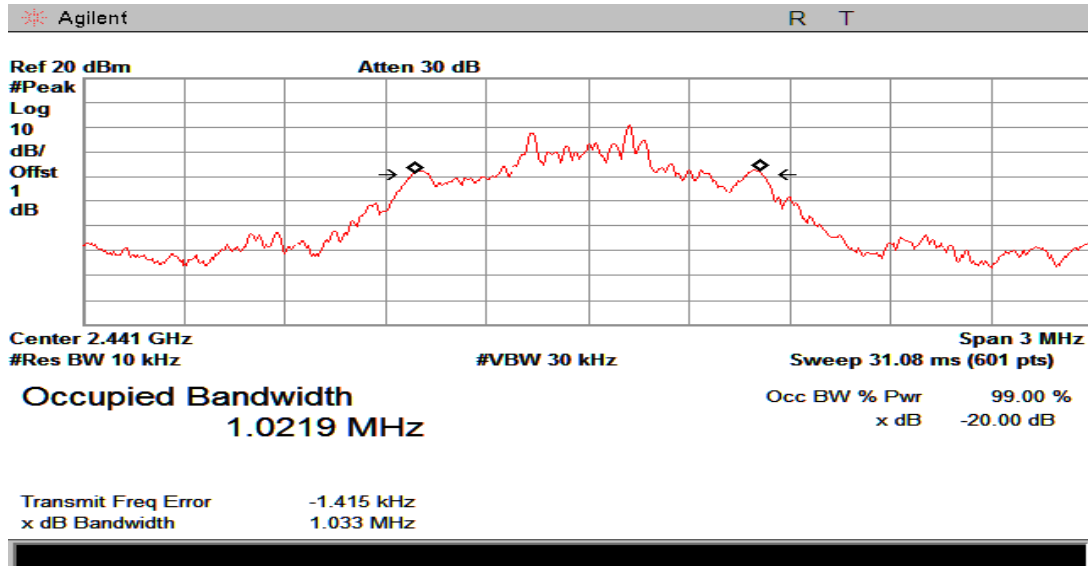

Highest CH

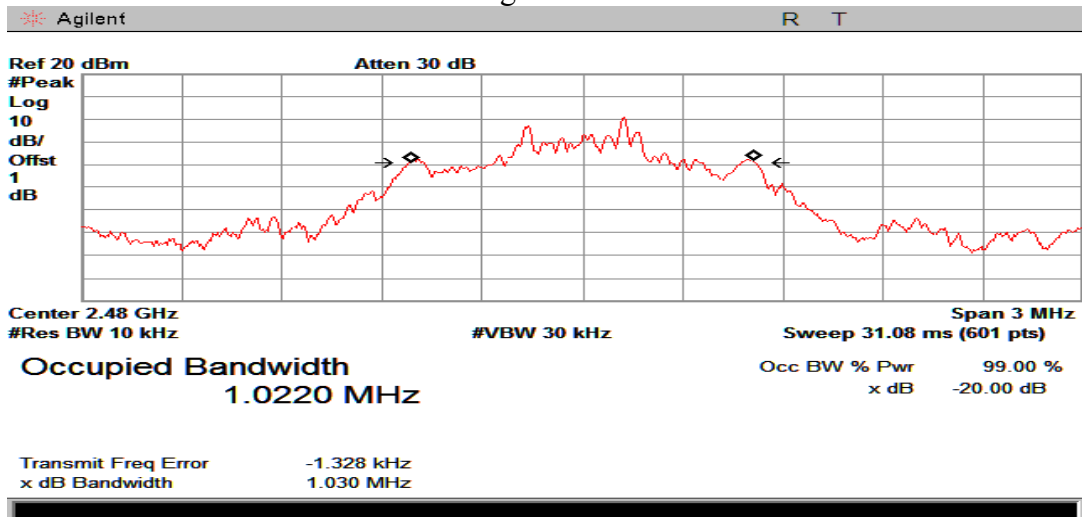

8-DPSK

Lowest CH

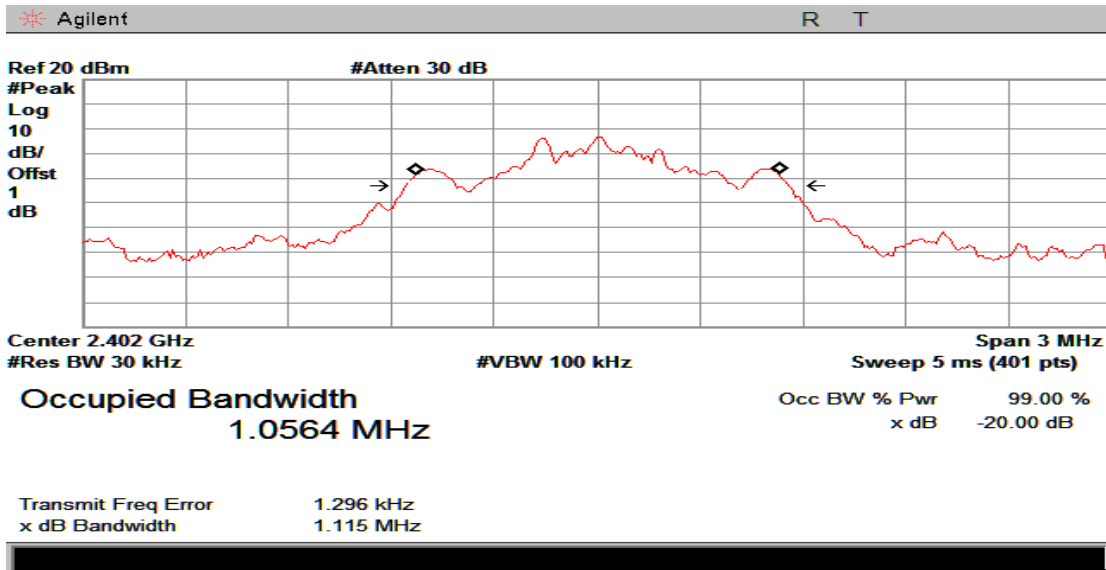

Middle CH

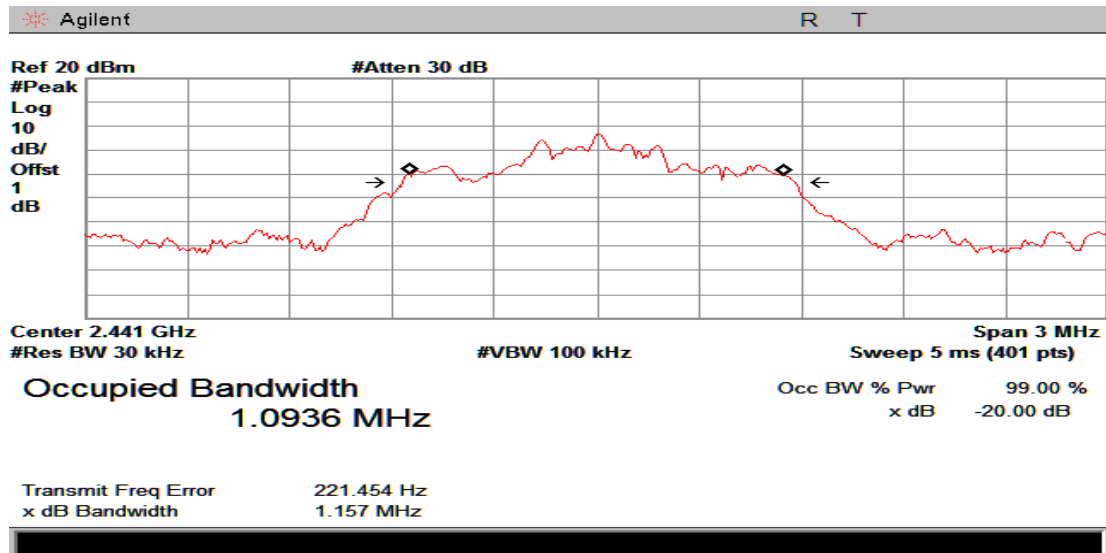

Highest CH

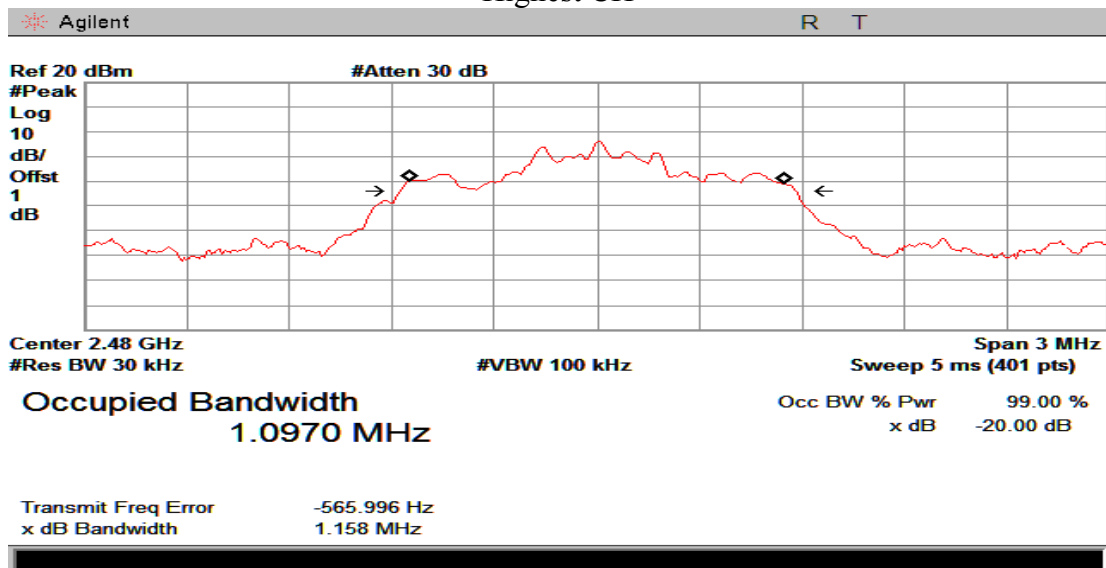

5. Carrier Frequency Separation

5.1. Limit

Frequency hopping systems shall have hopping channel carrier frequencies separated by a minimum of 25 kHz or the 20 dB bandwidth of the hopping channel, whichever is greater. Alternatively, frequency hopping systems operating in the 2400-2483.5 MHz band may have hopping channel carrier frequencies that are separated by 25 kHz or two-thirds of the 20 dB bandwidth of the hopping channel, whichever is greater, provided the systems operate with an output power no greater than 125 mW

5.2. Test Procedure

The transmitter output was coupled to a spectrum analyzer via a antenna. The carrier frequency was measured by spectrum analyzer with 100 kHz RBW and 300 kHz VBW.

5.3. Test Result

GFSK:

EUT: Bluetooth Speaker M/N: WS-303				
Test date: 2014-11-28		Test site: RF site		Tested by: Store
Mode	Channel separation (MHz)	20dB Bandwidth (MHz)	Limit (MHz)	Conclusion
Lowest	1.000	0.5602	2/3 20dB bandwidth or 25kHz	PASS
Middle	1.000	0.5130		
Highest	1.000	0.5136		

Pi/4DQPSK

EUT: Bluetooth Speaker M/N: WS-303				
Test date: 2014-11-28		Test site: RF site		Tested by: Store
Mode	Channel separation (MHz)	20dB Bandwidth (MHz)	Limit (MHz)	Conclusion
Lowest	1.000	1.032	2/3 20dB bandwidth or 25kHz	PASS
Middle	1.000	1.033		
Highest	1.000	1.030		

8-DPSK

EUT: Bluetooth Speaker M/N: WS-303				
Test date: 2014-11-28		Test site: RF site		Tested by: Store
Mode	Channel separation (MHz)	20dB Bandwidth (MHz)	Limit (MHz)	Conclusion
Lowest	1.000	0.7576	2/3 20dB bandwidth or 25kHz	PASS
Middle	1.000	0.7555		
Highest	1.000	0.7552		

Original test data for channel separation

GFSK

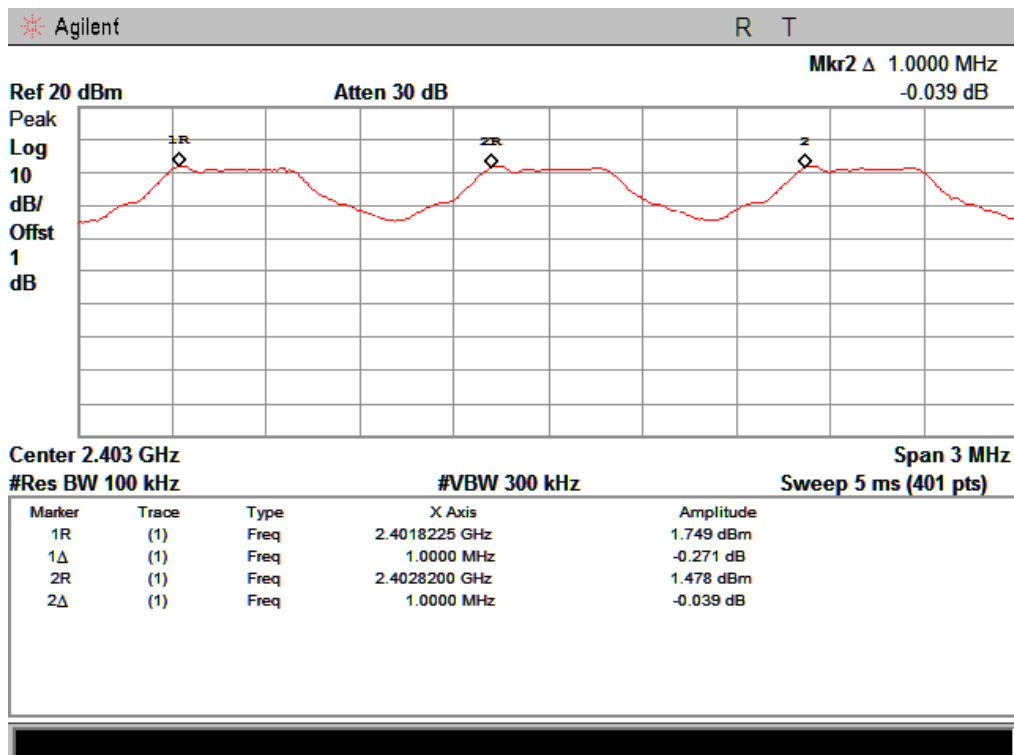

Lowest

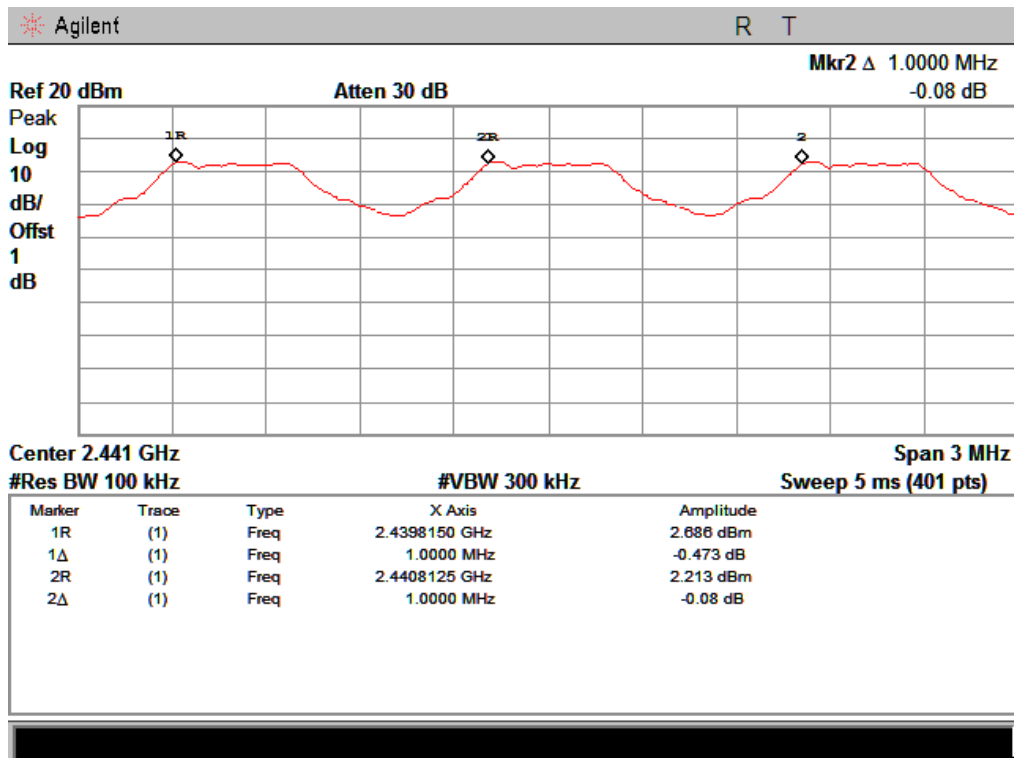

Middle

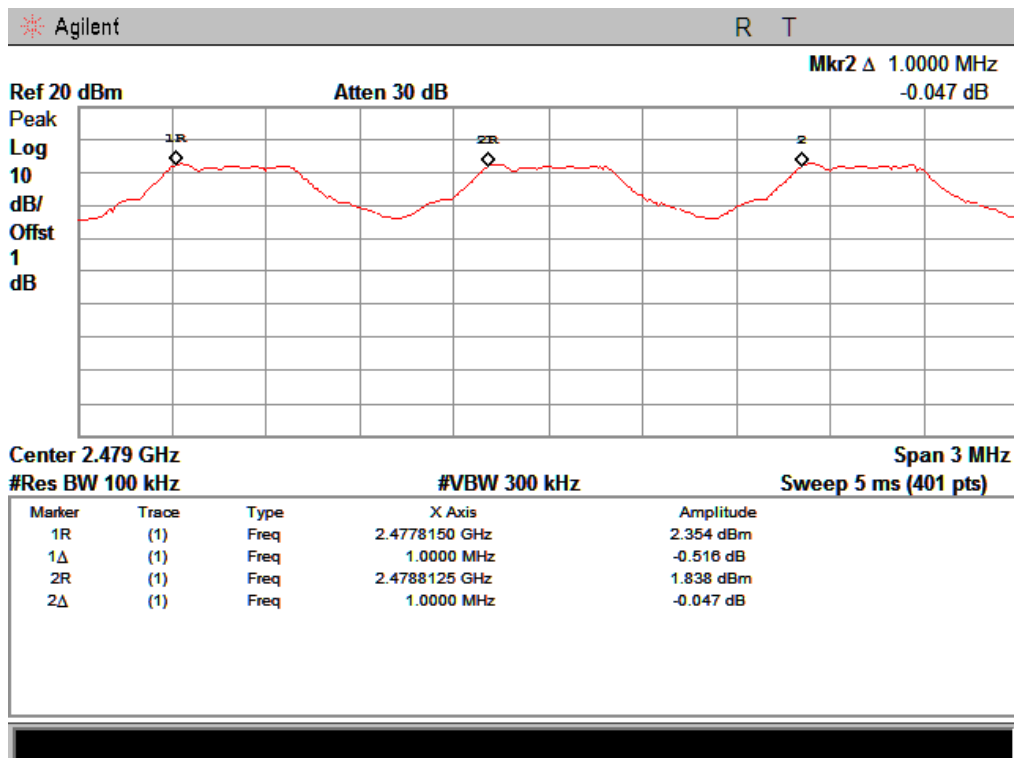

Highest

Pi/4-DQPSK

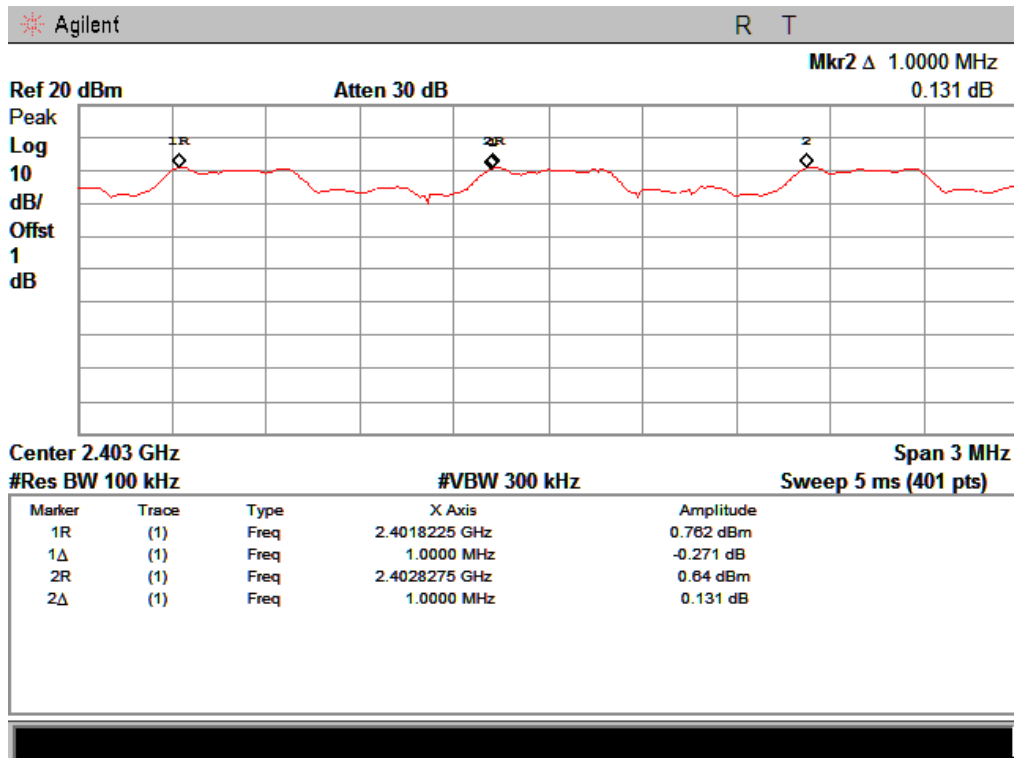

Lowest

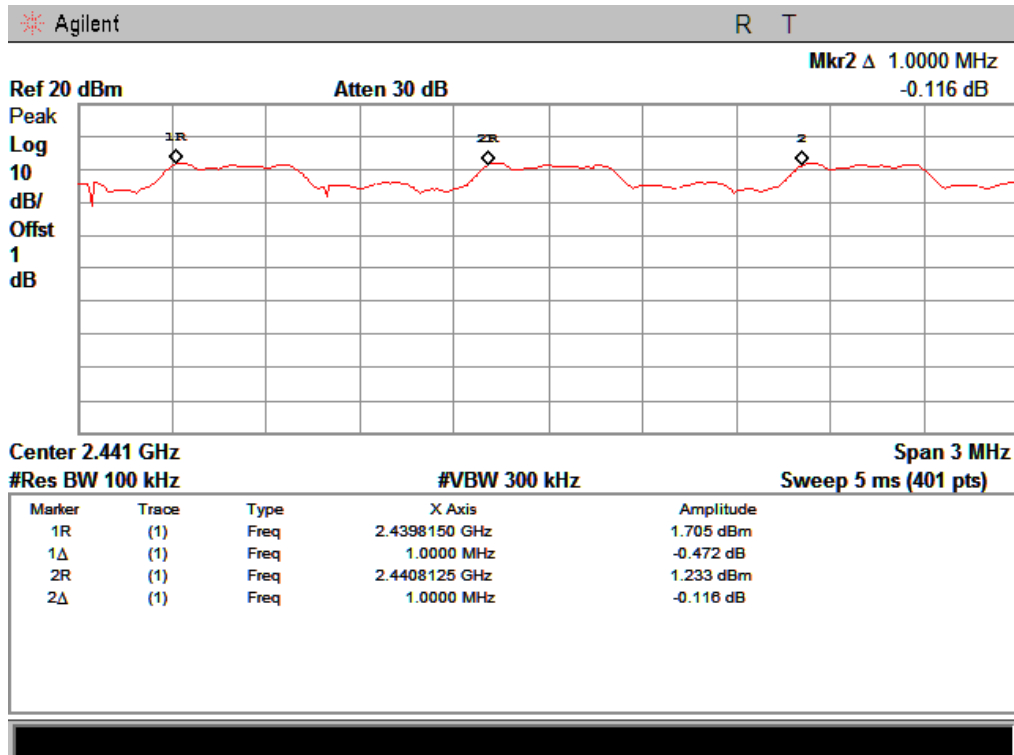

Middle

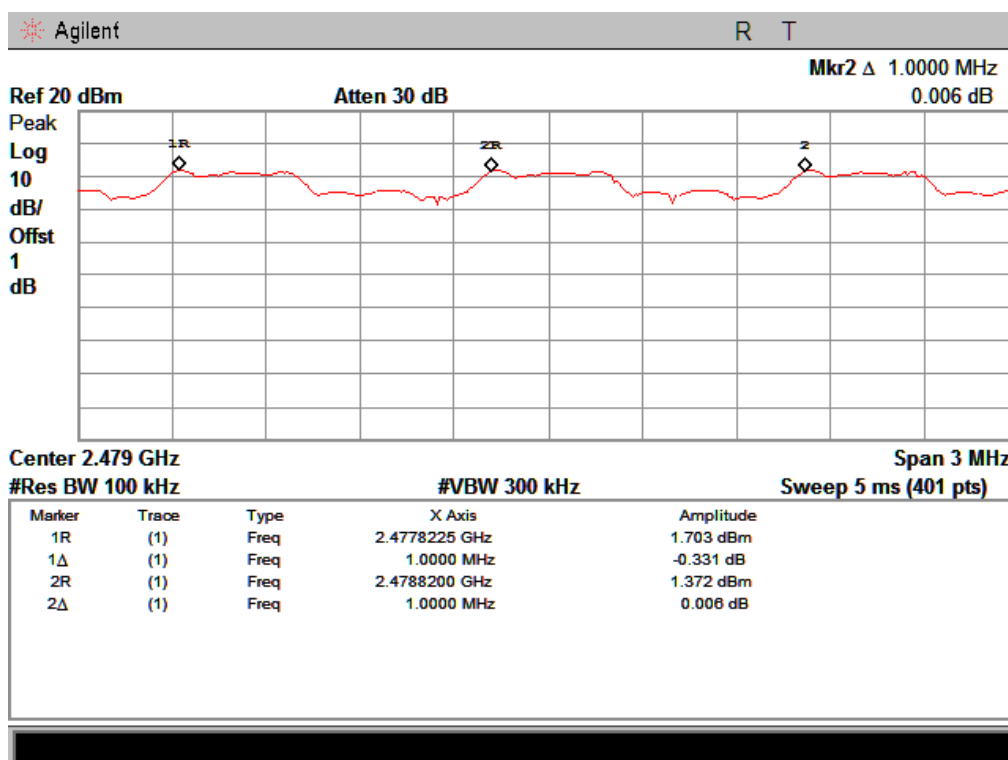

Highest

8-DPSK

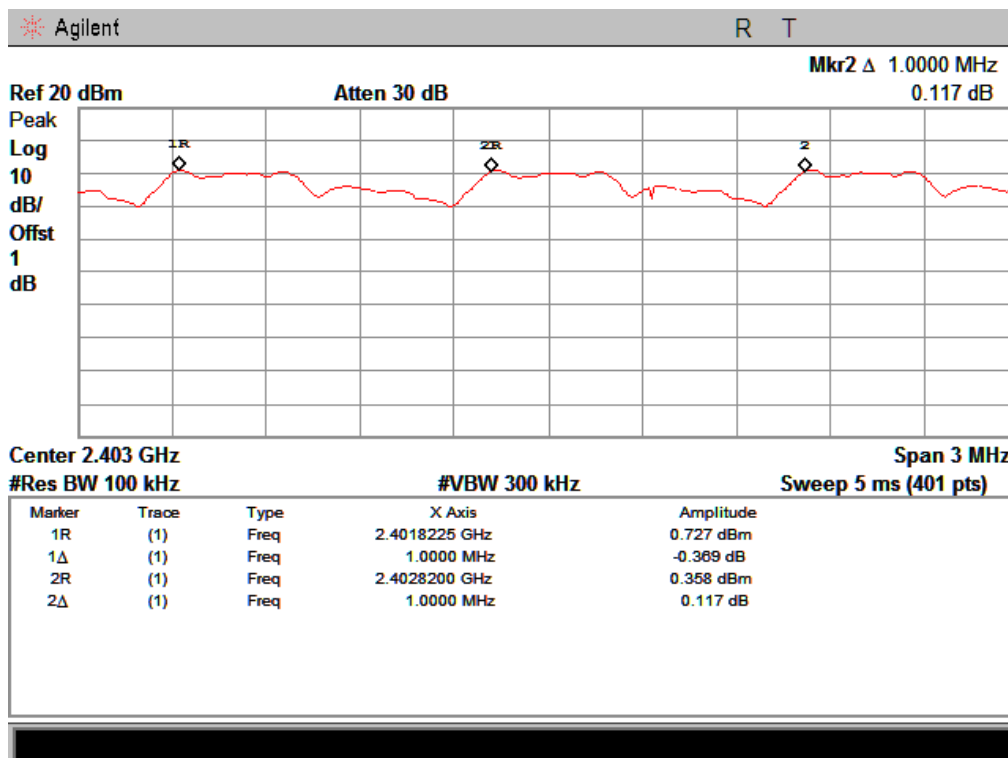

Lowest

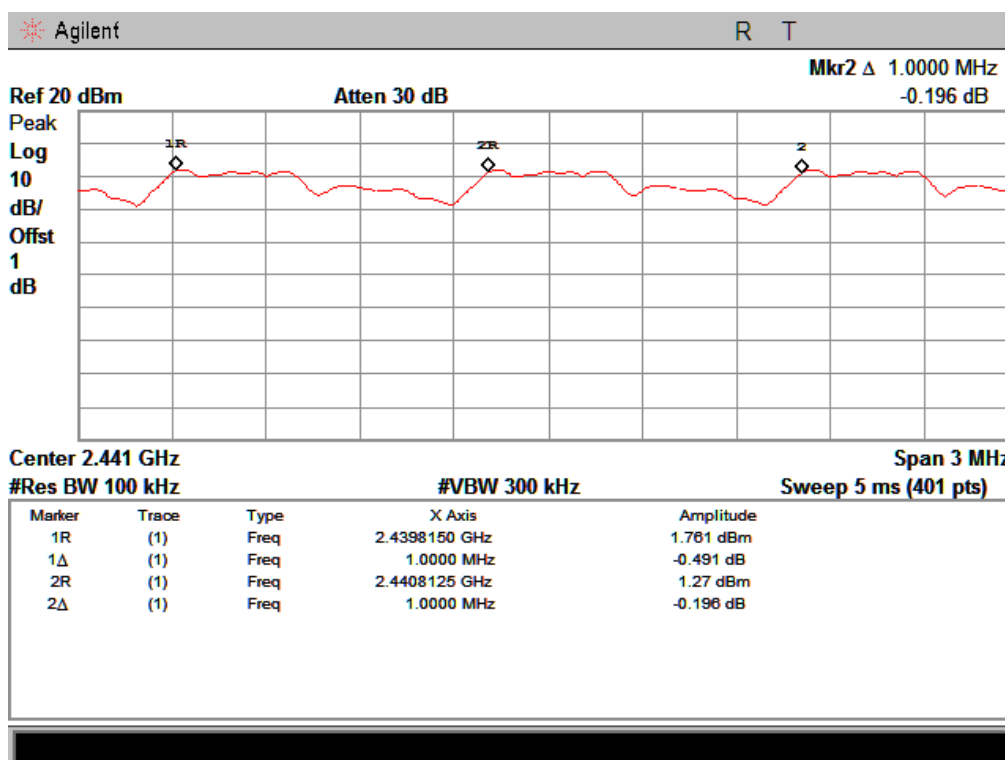

Middle

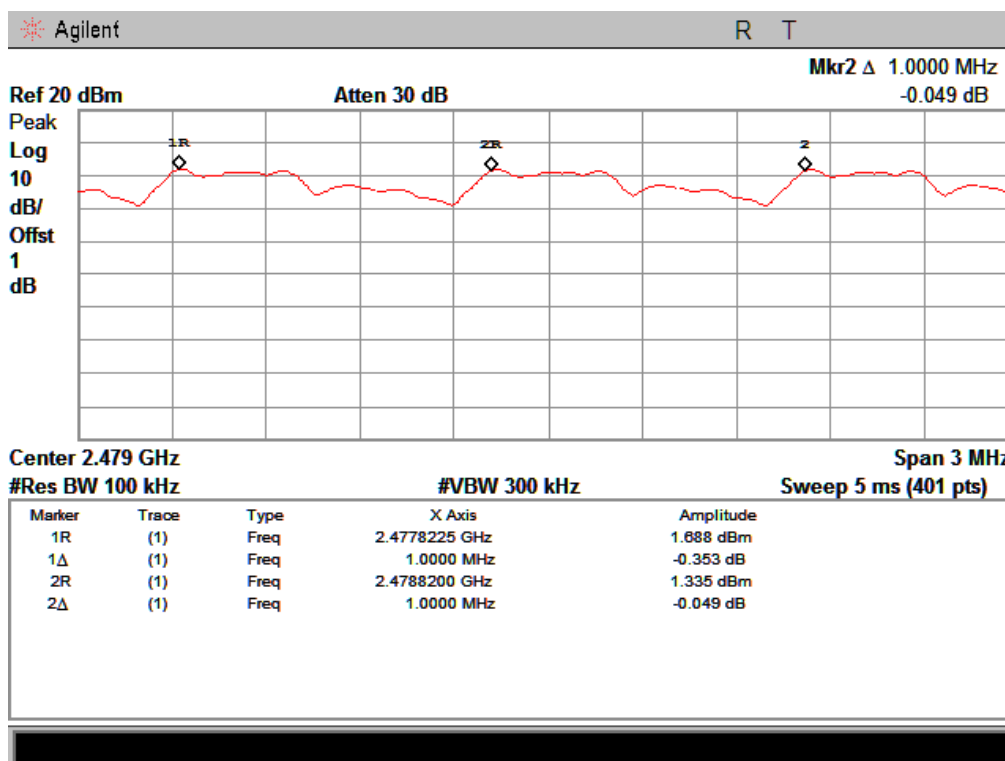

Highest

6. Number Of Hopping Channel

6.1. Limit

Frequency hopping systems in the 2400-2483.5 MHz band shall use at least 15 channels

6.2. Test Procedure

The transmitter output was coupled to a spectrum analyzer via a antenna. The number of hopping channel was measured by spectrum analyzer with 100kHz RBW and 300kHz VBW.

6.3. Test Result

EUT: Bluetooth Speaker		M/N: WS-303	
Test date: 2014-11-28		Test site: RF site	Tested by: Store
Mode	Number of hopping channel	Limit	Conclusion
GFSK	79	>15	PASS
Pi/4-DQPSK	79		
8-DPSK	79		

Original test data for hopping channel number
GFSK

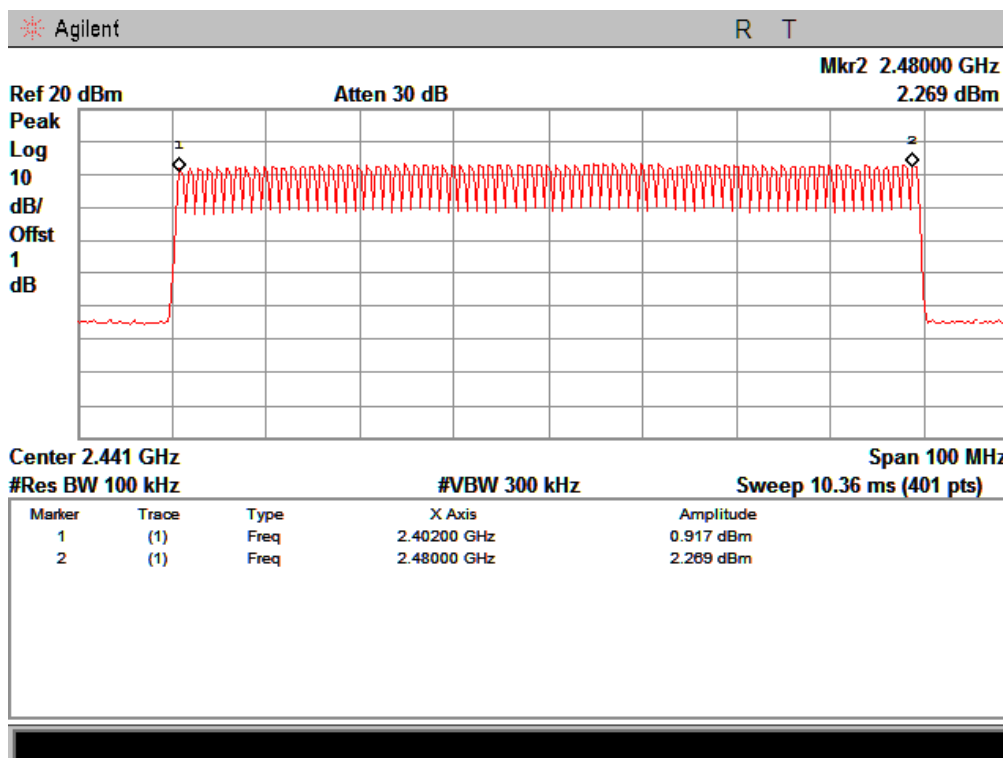

Pi/4-DQPSK

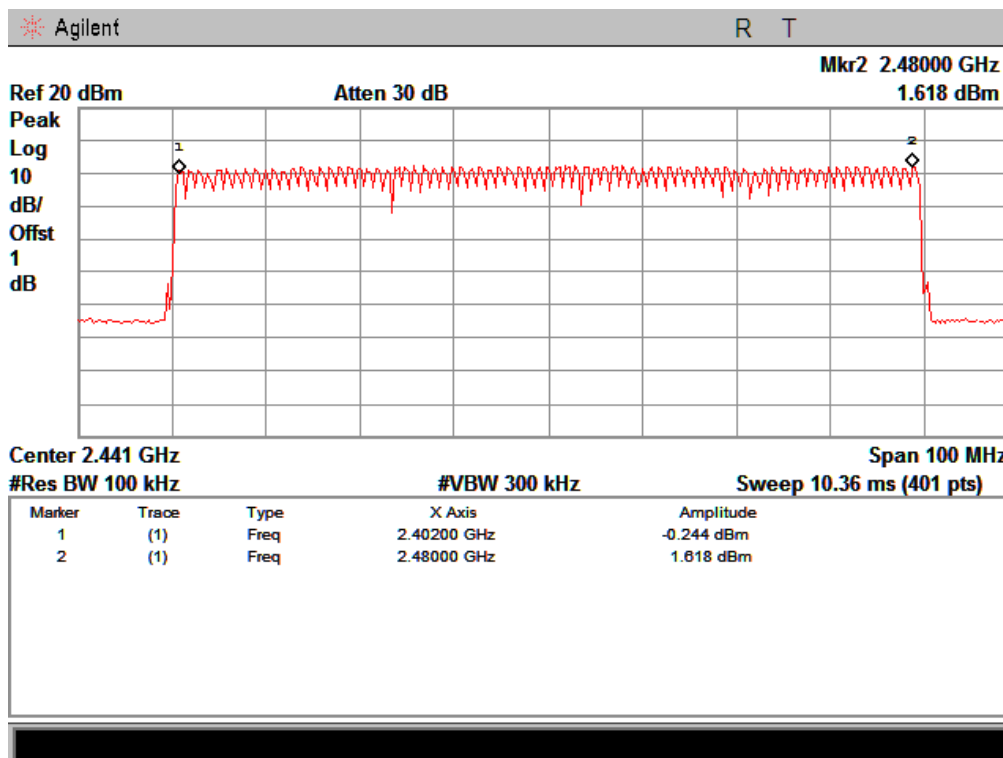

8-DPSK

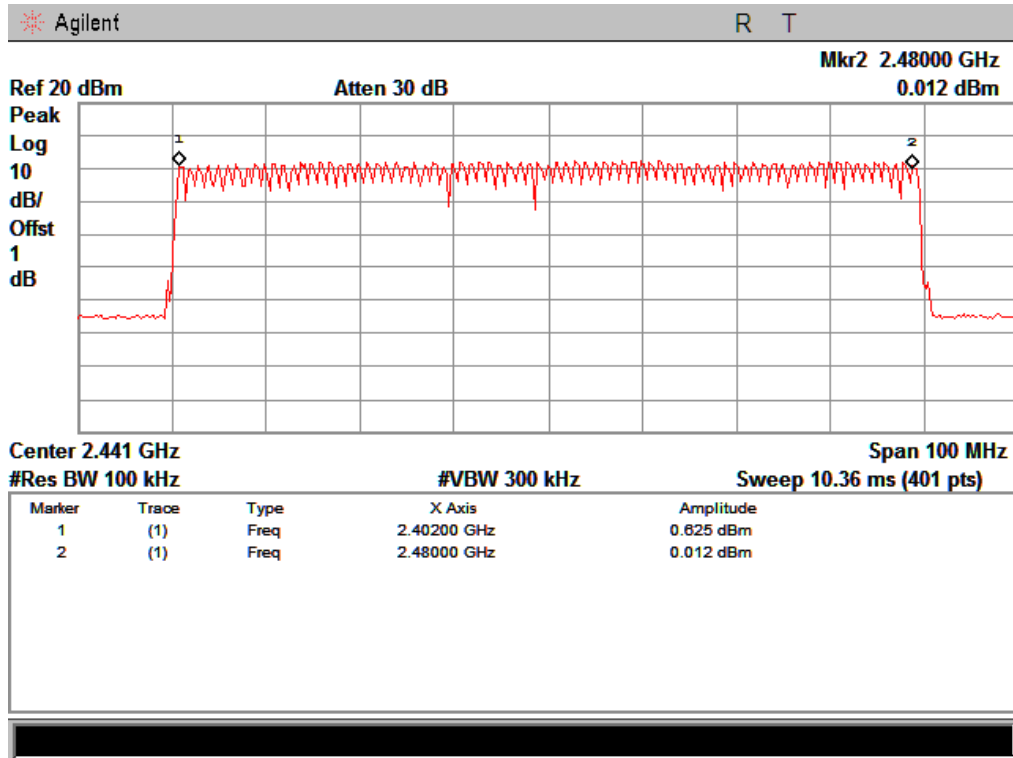

7. Dwell Time

7.1. Test limit

Please refer section 15.247

According to §15.247(a)(1)(iii), Frequency hopping systems operating in the 2400MHz-2483.5 MHz. The average time of occupancy on any frequency shall not greater than 0.4 s within period of 0.4 seconds multiplied by the number of hopping channel employed.

7.2. Test Procedure

7.2.1. Place the EUT on the table and set it in transmitting mode.

7.2.2. Remove the antenna from the EUT and then connect a low loss RF cable from the antenna port to the spectrum analyzer.

7.2.3. Set center frequency of spectrum analyzer = operating frequency.

7.2.4. Set the spectrum analyzer as RBW, VBW=1MHz, Span = 0Hz, Sweep = auto.

7.2.5. Repeat above procedures until all frequency measured were complete.

7.3. Test Results

PASS.

Detailed information please see the following page.

Mode	Packet	Dwell time (second)	Limit (second)	Result
GFSK	DH1	0.131	0.4	Pass
	DH3	0.266		
	DH5	0.313		
Pi/4DQPSK	2-DH1	0.134	0.4	Pass
	2-DH3	0.264		
	2-DH5	0.310		
8DPSK	3-DH1	0.141	0.4	Pass
	3-DH3	0.264		
	3-DH5	0.311		

Note: 1 A period time = 0.4 (s) * 79 = 31.6(s)

2 DH1 time slot = Pulse Duration * (1600/(2*79)) * A period time

DH3 time slot = Pulse Duration * (1600/(4*79)) * A period time

DH5 time slot = Pulse Duration * (1600/(6*79)) * A period time

DH1:

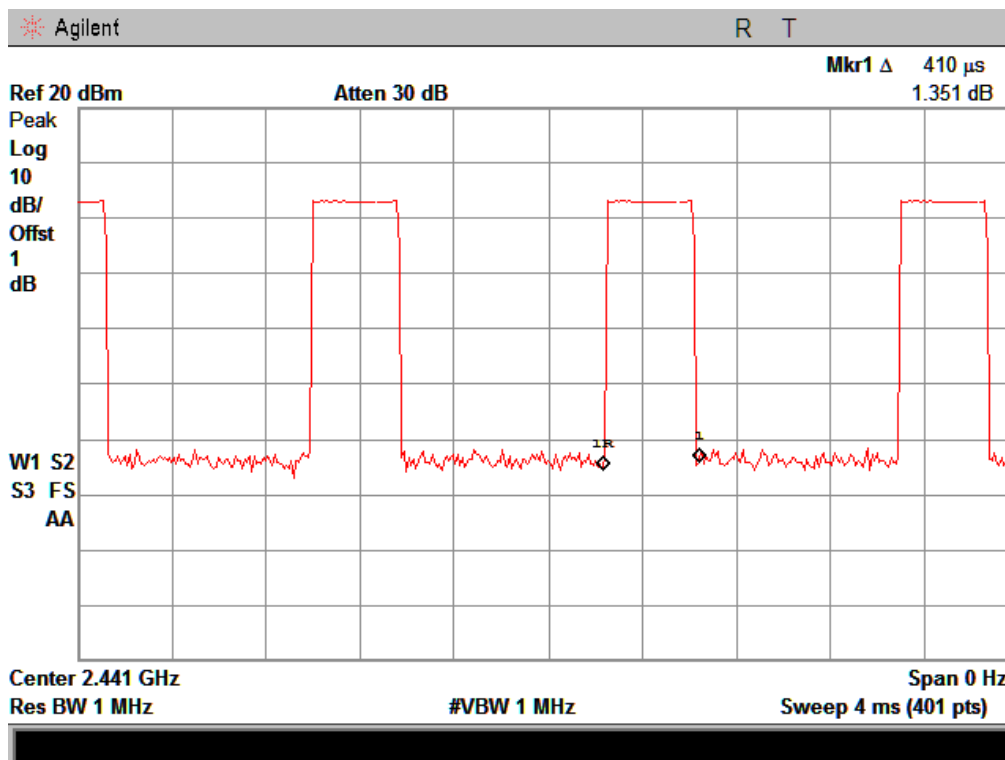

DH3:

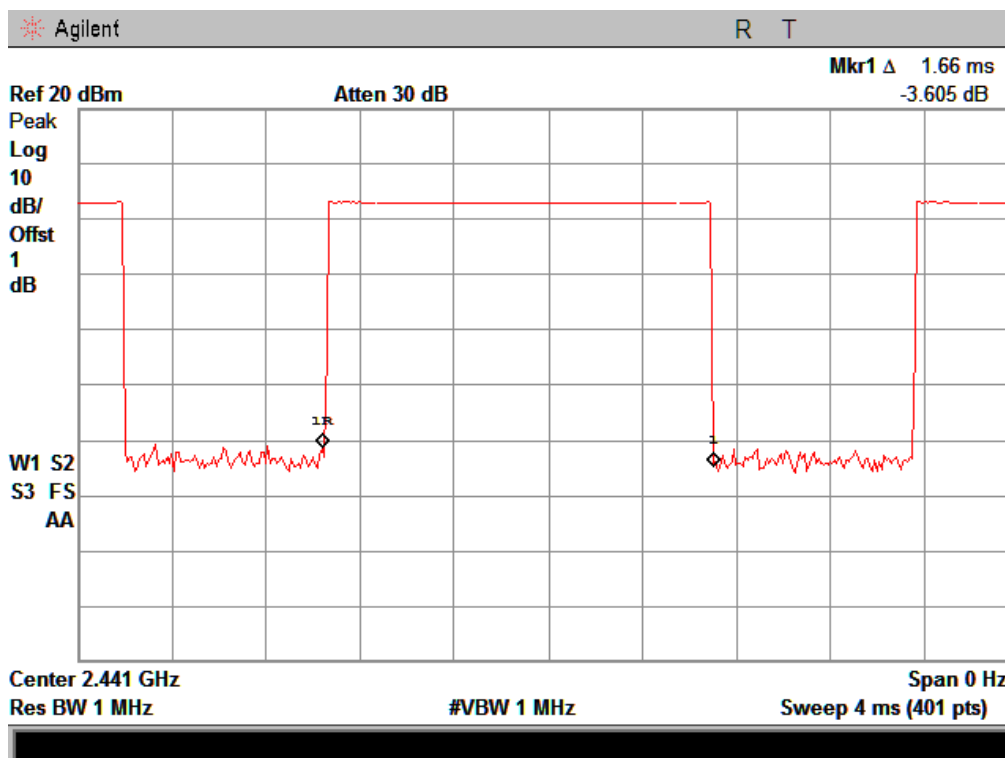

DH5:

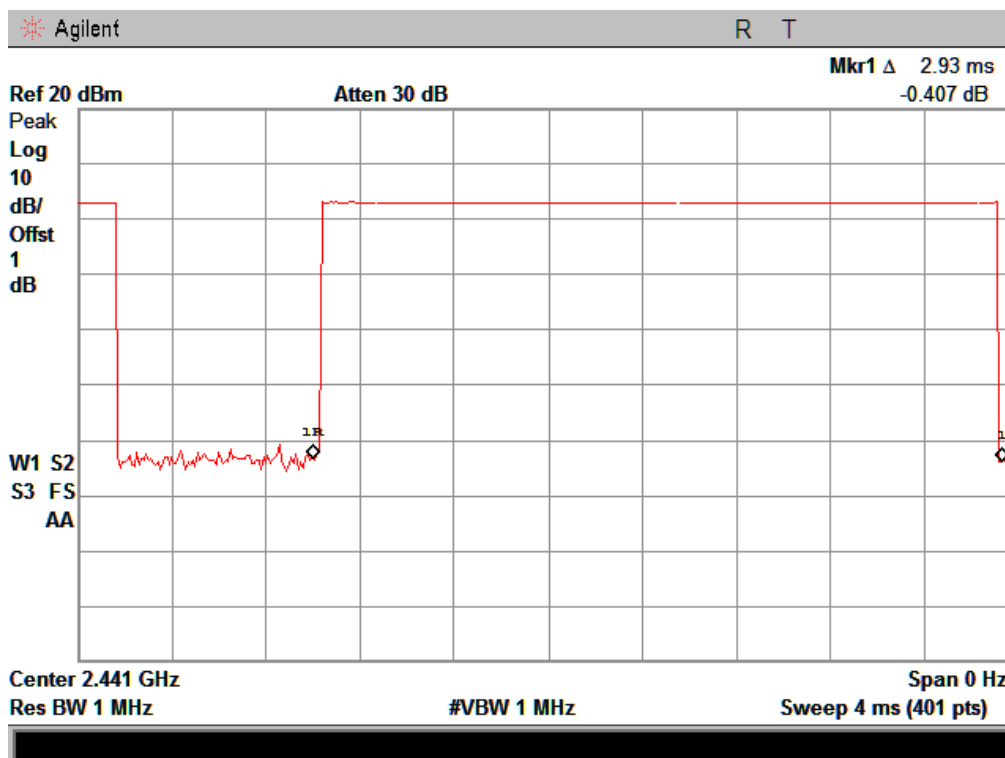

2DH1:

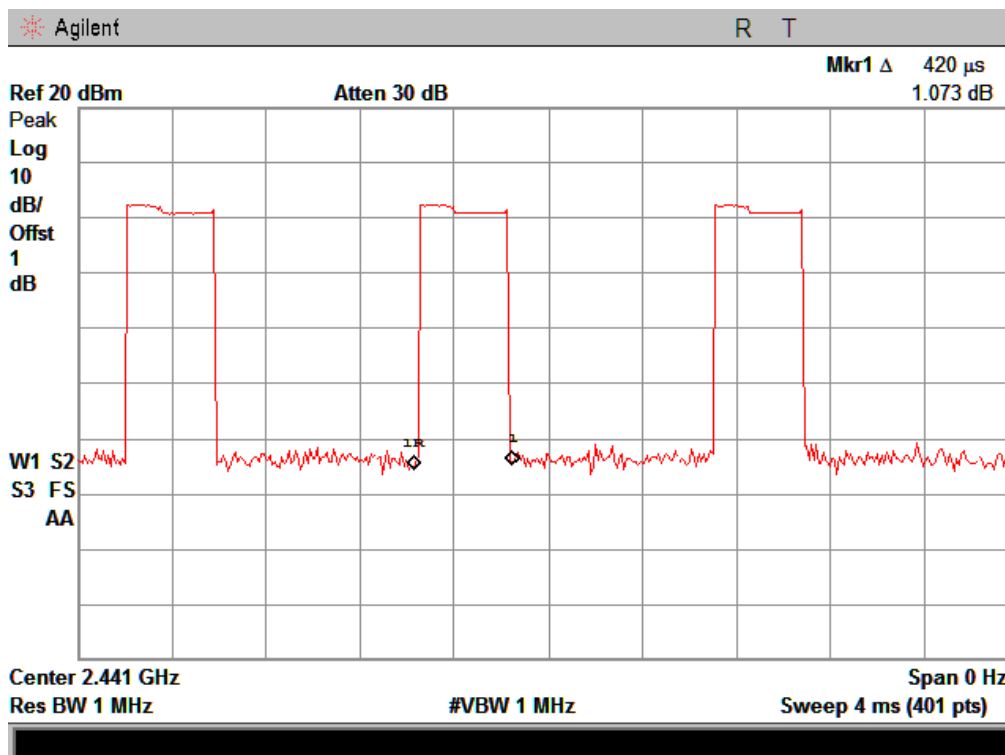

2DH3:

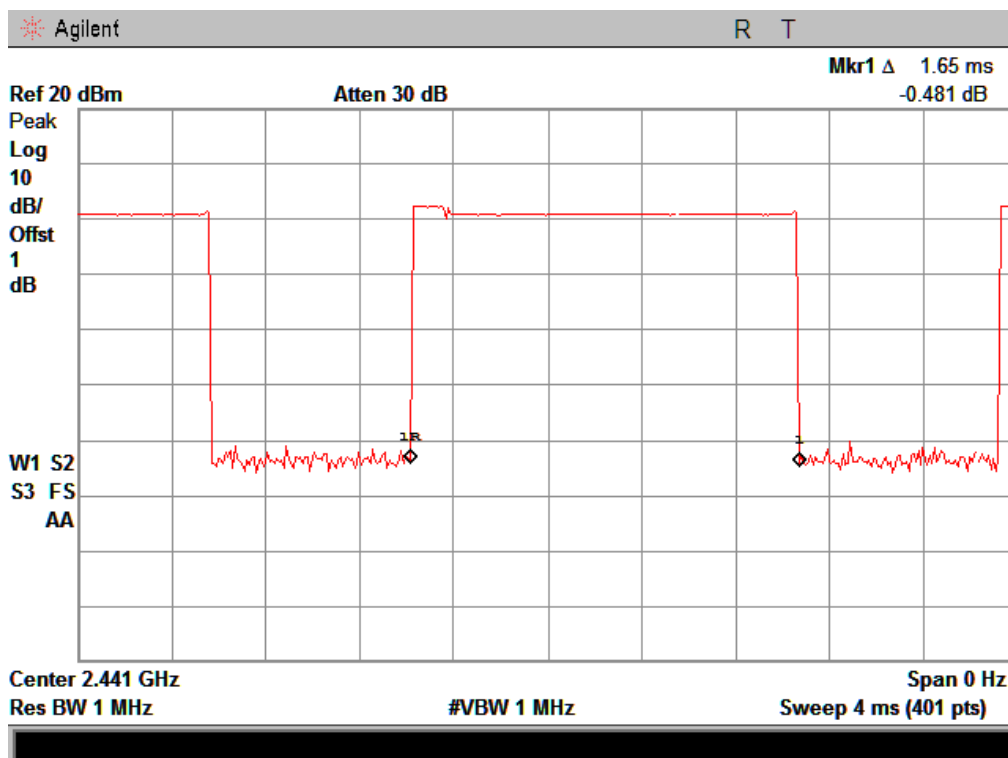

2DH5:

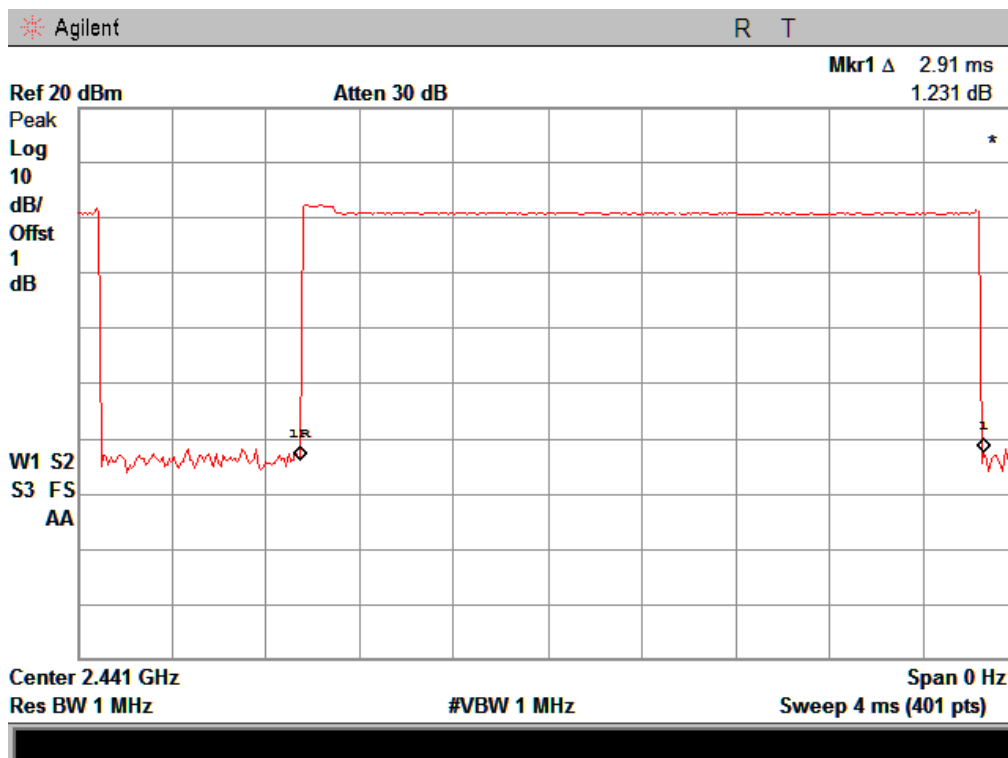

3DH1:

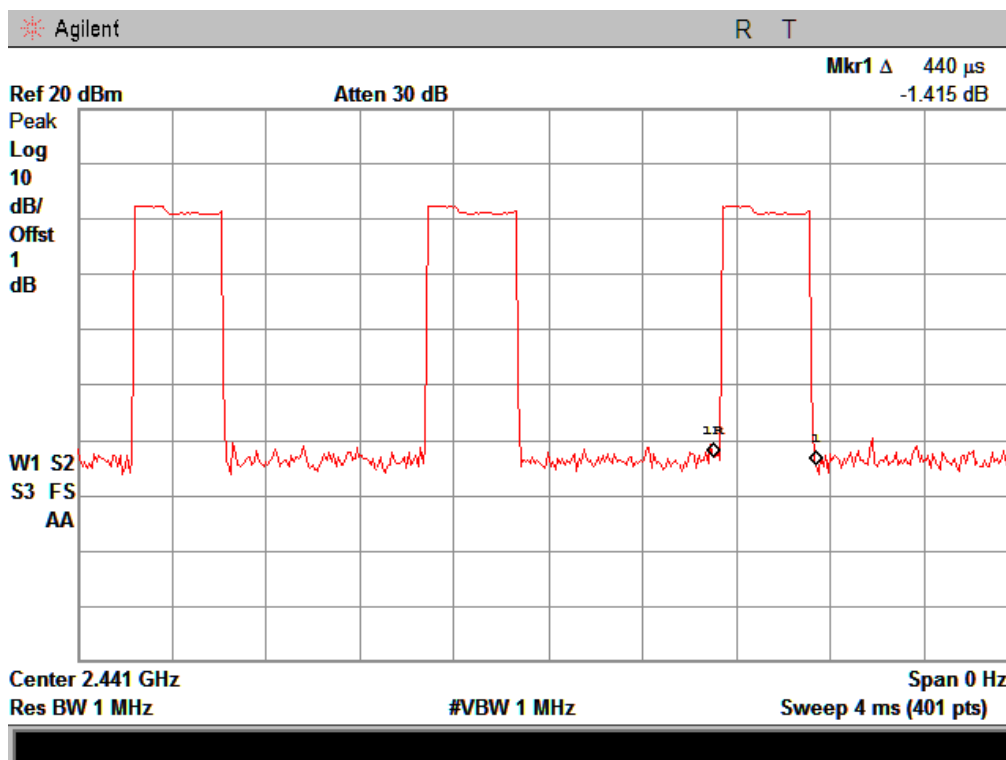

3DH3:

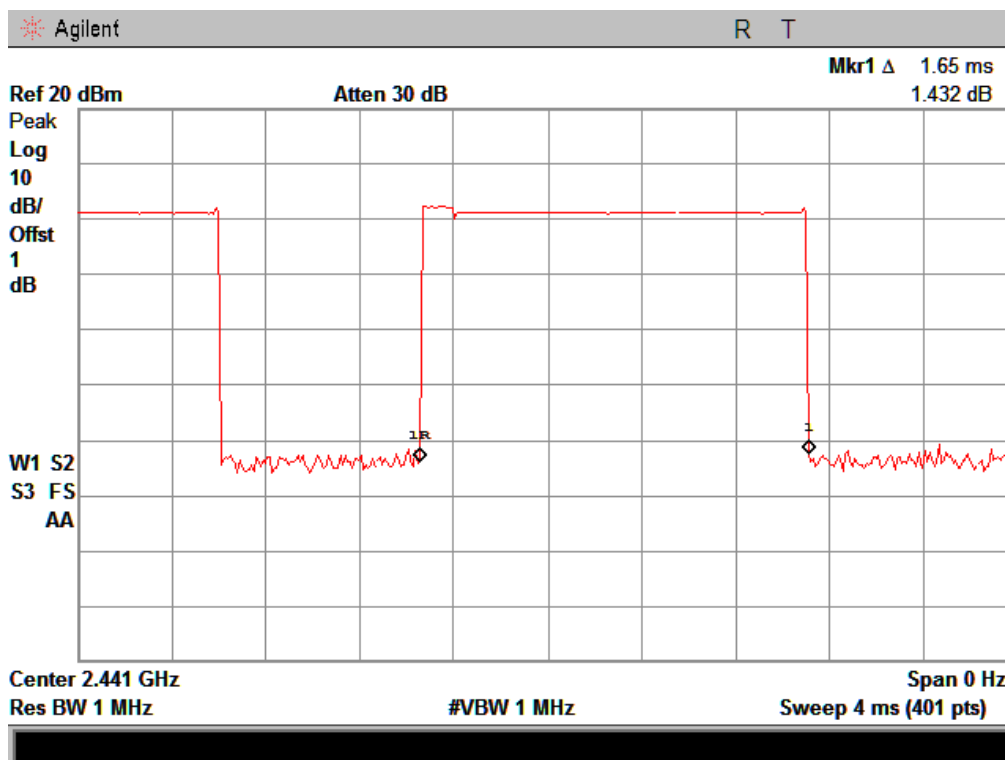

3DH5:

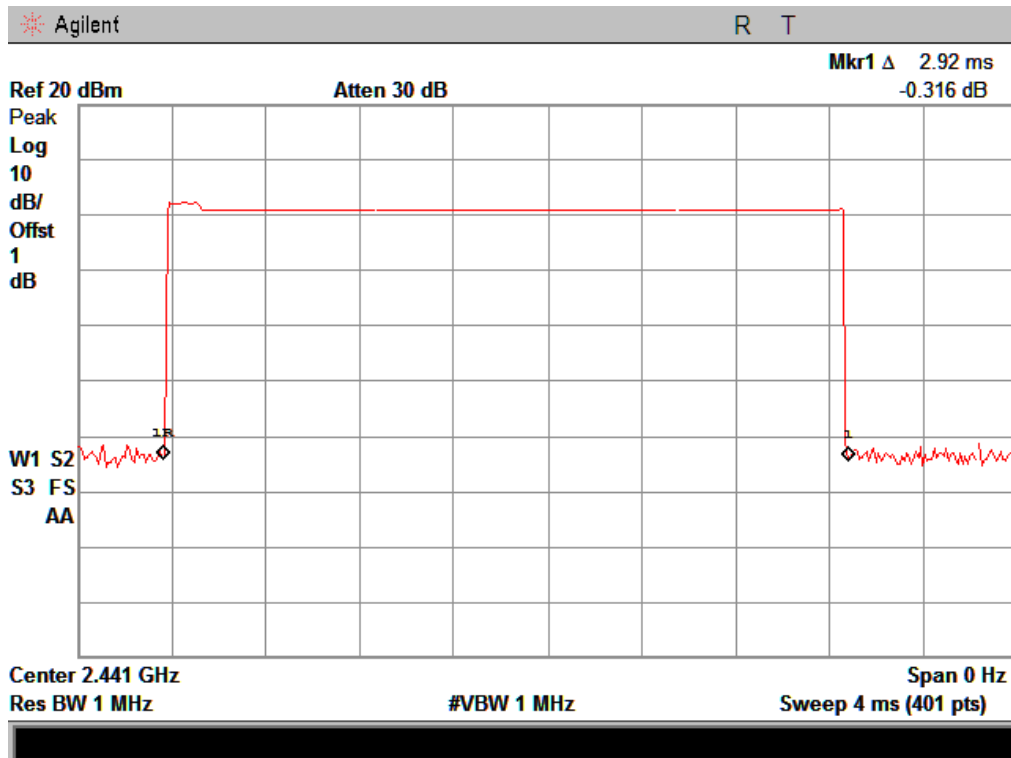

8. Radiated emissions

8.1. Limit

All the emissions appearing within 15.205 restricted frequency bands shall not exceed the limits shown in 15.209, all the other emissions shall be at least 20dB below the fundamental emissions, or comply with 15.209 limits.

15.205 Restricted frequency band

MHz	MHz	MHz	GHz
0.090 - 0.110	16.42 - 16.423	399.9 - 410	4.5 - 5.15
0.495 - 0.505	16.69475 - 16.69525	608 - 614	5.35 - 5.46
2.1735 - 2.1905	16.80425 - 16.80475	960 - 1240	7.25 - 7.75
4.125 - 4.128	25.5 - 25.67	1300 - 1427	8.025 - 8.5
4.17725 - 4.17775	37.5 - 38.25	1435 - 1626.5	9.0 - 9.2
4.20725 - 4.20775	73 - 74.6	1645.5 - 1646.5	9.3 - 9.5
6.215 - 6.218	74.8 - 75.2	1660 - 1710	10.6 - 12.7
6.26775 - 6.26825	108 - 121.94	1718.8 - 1722.2	13.25 - 13.4
6.31175 - 6.31225	123 - 138	2200 - 2300	14.47 - 14.5
8.291 - 8.294	149.9 - 150.05	2310 - 2390	15.35 - 16.2
8.362 - 8.366	156.52475 - 156.52525	2483.5 - 2500	17.7 - 21.4
8.37625 - 8.38675	156.7 - 156.9	2690 - 2900	22.01 - 23.12
8.41425 - 8.41475	162.0125 - 167.17	3260 - 3267	23.6 - 24.0
12.29 - 12.293	167.72 - 173.2	3332 - 3339	31.2 - 31.8
12.51975 - 12.52025	240 - 285	3345.8 - 3358	36.43 - 36.5
12.57675 - 12.57725	322 - 335.4	3600 - 4400	(²)

15.209 Limit

FREQUENCY MHz	DISTANCE Meters	FIELD STRENGTHS LIMIT	
		μV/m	dB(μV)/m
0.009-0.490	300	2400/F(KHz)	/
0.490-1.705	30	24000/F(KHz)	/
1.705-30	30	30	29.5
30~88	3	100	40.0
88~216	3	150	43.5
216~960	3	200	46.0
960~1000	3	500	54.0
Above 1000	3	74.0 dB(μV)/m (Peak) 54.0 dB(μV)/m (Average)	

8.2. Block Diagram of Test setup

8.2.1. In 3m Anechoic Chamber Test Setup Diagram for below 1GHz

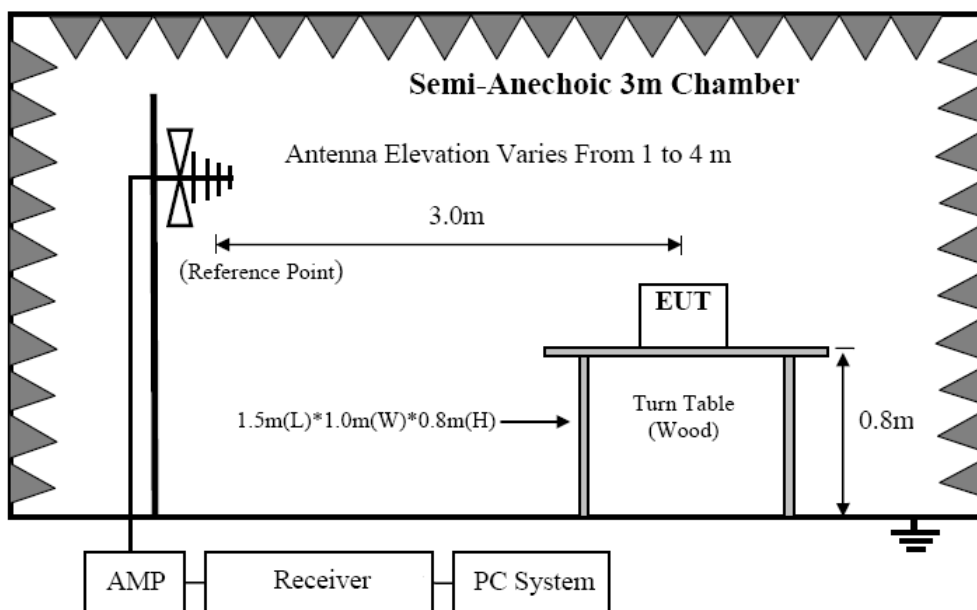

8.2.2. In 3m Anechoic Chamber Test Setup Diagram for frequency above 1GHz

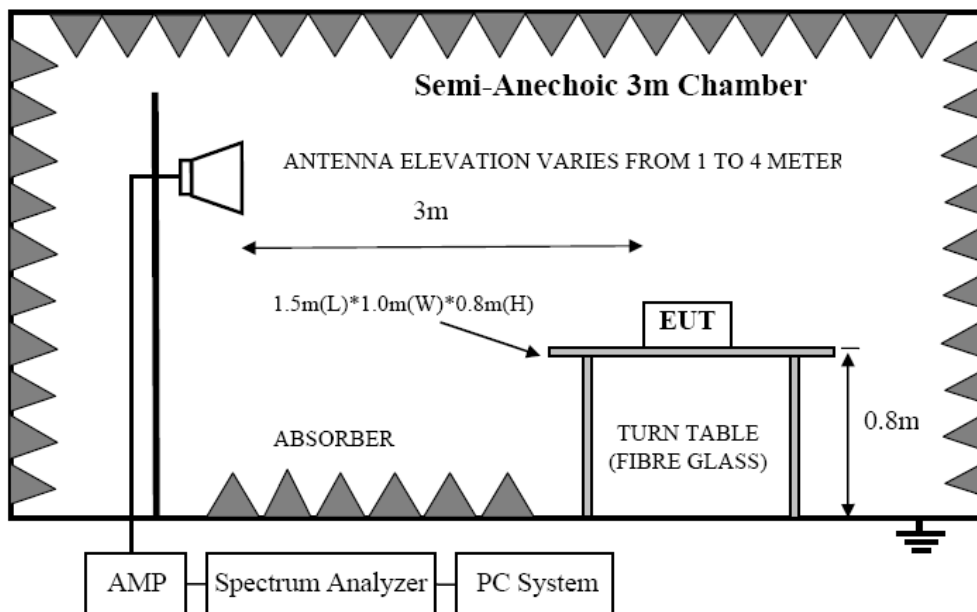

Note: For harmonic emissions test a appropriate high pass filter was inserted in the input port of AMP.

8.3. Test Procedure

- (1) EUT was placed on a non-metallic table, 80 cm above the ground plane inside a semi-anechoic chamber.
- (2) Setup EUT and simulator as shown in section 1.4 and 6.1

- (3) Test antenna was located 3m from the EUT on an adjustable mast. Below pre-scan procedure was first performed in order to find prominent radiated emissions.
 - (a) Change work frequency or channel of device if practicable.
 - (b) Change modulation type of device if practicable.
 - (c) Power supplied by DC 5V From PC AC120V/60Hz or DC 3.7V from battery.
 - (d) Rotated EUT though three orthogonal axes to determine the attitude of EUT arrangement produce highest emissions
- (4) Spectrum frequency from 9 kHz to 25GHz (tenth harmonic of fundamental frequency) was investigated
- (5) For final emissions measurements at each frequency of interest, the EUT were rotated and the antenna height was varied between 1m and 4m in order to maximize the emission. Measurements in both horizontal and vertical polarities were made and the data was recorded. In order to find the maximum emission, the relative positions of equipments and all of the interface cables were changed according to ANSI C63.4 2003 on Radiated Emission test.
- (6) For emissions above 1GHz, both Peak and Average level were measured with Spectrum Analyzer, and the RBW is set at 1MHz, VBW is set at 3MHz for Peak measure; RBW is set at 1MHz, VBW is set at 10Hz for Average measure.

8.4. Test Result

We have scanned the 10th harmonic from 9 kHz to the EUT.
Detailed information please see the following page.

From 9 kHz to 30 MHz: Conclusion: PASS

Note: The amplitude of spurious emissions which are attenuated by more than 20dB below the permissible value has no need to be reported.

Remark: All three modulations of EUT have been tested, only show the test data of the worst modulation in this report, and we found the worst modulation is GFSK (Low Channel CH0)

From 30MHz to 1000MHz: Conclusion: PASS

Horizontal:

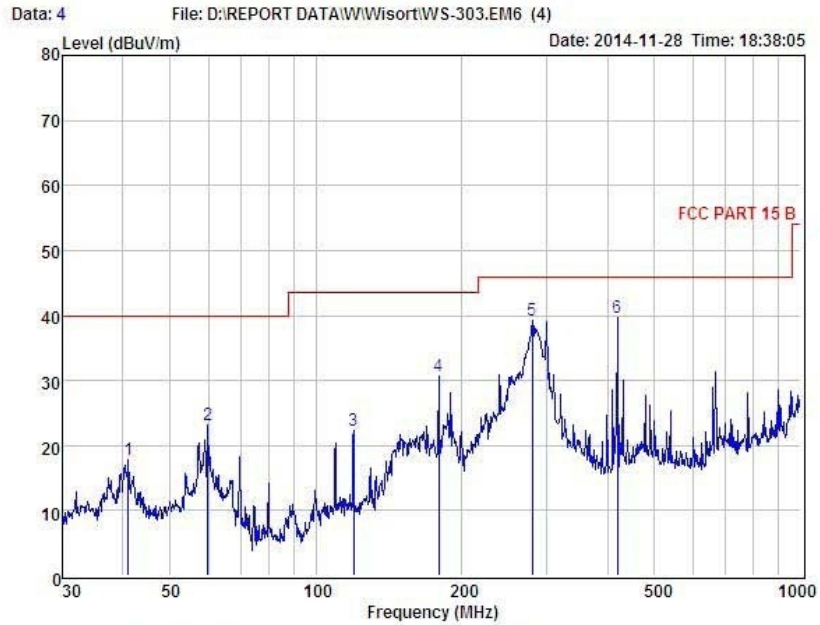

Condition : FCC PART 15 B 3m POL: HORIZONTAL
 EUT : Bluetooth Speaker
 Model No : WS-303
 Test Mode : GFSK TX Low CH0
 Power : DC 5V From PC With AC 120V/60Hz
 Test Engineer : Store
 Remark :
 Temp : 24.2°C
 Hum : 54%

Item	Freq MHz	Read Level dBuV	Antenna Factor dB	Preamp Factor dB	Cable Loss dB	Level dBuV	Limit dBuV	Margin dBuV	Remark
1	40.99	34.89	13.93	31.12	0.18	17.88	40.00	-22.12	QP
2	59.86	41.43	12.75	31.31	0.24	23.11	40.00	-16.89	QP
3	119.86	41.18	12.06	31.31	0.36	22.29	43.50	-21.21	QP
4	179.39	49.32	11.98	31.08	0.46	30.68	43.50	-12.82	QP
5	280.02	57.35	12.37	31.06	0.60	39.26	46.00	-6.74	QP
6	419.11	54.25	15.23	30.63	0.78	39.63	46.00	-6.37	QP

Remark: Level = Read Level + Antenna Factor - Preamp Factor + Cable Loss

Vertical:

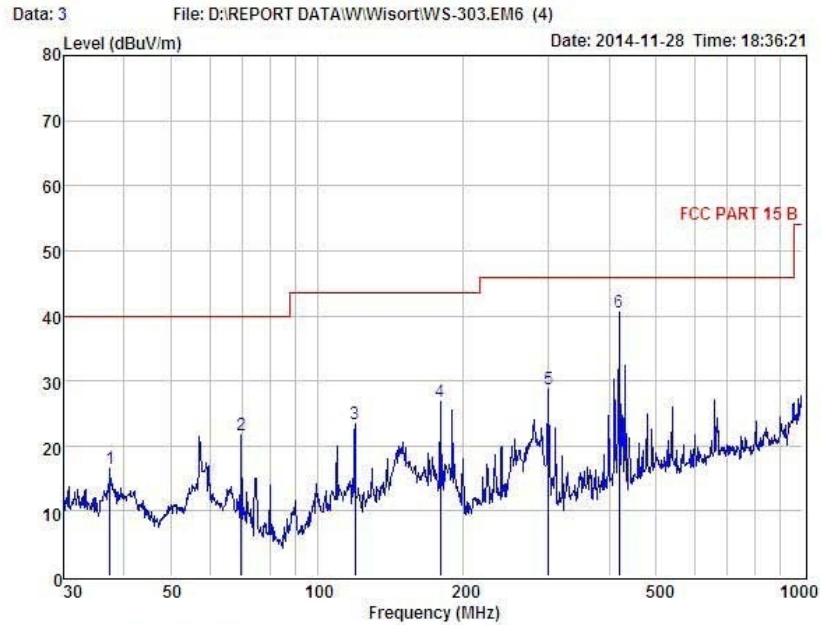

Condition : FCC PART 15 B 3m POL: VERTICAL
 EUT : Bluetooth Speaker
 Model No : WS-303
 Test Mode : GFSK TX Low CH0
 Power : DC 5V From PC With AC 120V/60Hz
 Test Engineer : Store
 Remark :
 Temp : 24.2°C
 Hum : 54%

Item	Freq MHz	Read Level dBuV	Antenna Factor dB	Preamp Factor dB	Cable Loss dB	Level dBuV	Limit dBuV	Margin dBuV	Remark
1	37.42	33.80	13.73	31.06	0.08	16.55	40.00	-23.45	QP
2	69.84	41.96	10.82	31.38	0.24	21.64	40.00	-18.36	QP
3	119.86	42.18	12.06	31.31	0.36	23.29	43.50	-20.21	QP
4	179.39	45.35	11.98	31.08	0.46	26.71	43.50	-16.79	QP
5	299.32	46.23	12.80	30.91	0.69	28.81	46.00	-17.19	QP
6	419.11	55.26	15.23	30.63	0.78	40.64	46.00	-5.36	QP

Remark: Level = Read Level + Antenna Factor - Preamp Factor + Cable Loss

1GHz—25GHz Radiated emission Test result									
EUT: Bluetooth Speaker					M/N: WS-303				
Power: DC 5V From PC AC 120V/60Hz									
Test date: 2014-11-28 Test site: 3m Chamber Tested by: Store									
Test mode: GFSK Tx CH0 2402MHz									
Antenna polarity: Vertical									
No	Freq (MHz)	Read Level (dBuV/m)	Antenna Factor (dB/m)	Cable loss(dB)	Amp Factor (dB)	Result (dBuV/m)	Limit (dBuV/m)	Margin (dB)	Remark
1	4804	51.66	33.95	10.18	34.26	61.53	74	12.47	PK
2	4804	37.80	33.95	10.18	34.26	47.67	54	6.33	AV
3	7206	/							
4	9608	/							
5	12010	/							
Antenna Polarity: Horizontal									
1	4804	52.09	33.95	10.18	34.26	61.96	74	12.04	PK
2	4804	38.25	33.95	10.18	34.26	48.12	54	5.88	AV
3	7206	/							
4	9608	/							
5	12010	/							
Note:									
1, Measuring frequency from 1GHz to 25GHz									
2, Spectrum Set for PK measure: RBW=1MHz, VBW=1MHz, Sweep time=Auto, Detector: PK									
2, Spectrum Set for AV measure: RBW=1MHz, VBW=10Hz, Sweep time=Auto, Detector: PK									
3, Result = Read level + Antenna factor + cable loss-Amp factor									
4, All the other emissions not reported were too low to read and deemed to comply with FCC limit.									

1GHz—25GHz Radiated emission Test result									
EUT: Bluetooth Speaker					M/N: WS-303				
Power: DC 5V From PC AC 120V/60Hz									
Test date: 2014-11-28 Test site: 3m Chamber Tested by: Store									
Test mode: GFSK Tx CH39 2441MHz									
Antenna polarity: Vertical									
No	Freq (MHz)	Read Level (dBuV/m)	Antenna Factor (dB/m)	Cable loss(dB)	Amp Factor (dB)	Result (dBuV/m)	Limit (dBuV/m)	Margin (dB)	Remark
1	4882	50.73	33.93	10.2	34.29	60.57	74	13.43	PK
2	4882	38.26	33.93	10.2	34.29	48.10	54	5.90	AV
3	7323	/							
4	9764	/							
5	12205	/							
Antenna Polarity: Horizontal									
1	4882	51.21	33.93	10.2	34.29	61.05	74	12.95	PK
2	4882	39.28	33.93	10.2	34.29	49.12	54	4.88	AV
3	7323	/							
4	9764	/							
5	12205	/							
Note:									
1, Measuring frequency from 1GHz to 25GHz									
2, Spectrum Set for PK measure: RBW=1MHz, VBW=1MHz, Sweep time=Auto, Detector: PK									
2, Spectrum Set for AV measure: RBW=1MHz, VBW=10Hz, Sweep time=Auto, Detector: PK									
3, Result = Read level + Antenna factor + cable loss-Amp factor									
4, All the other emissions not reported were too low to read and deemed to comply with FCC limit.									

1GHz—25GHz Radiated emission Test result									
EUT: Bluetooth Speakers					M/N: WS-303				
Power: DC 5V From PC AC 120V/60Hz									
Test date: 2014-11-28 Test site: 3m Chamber Tested by: Store									
Test mode: GFSK Tx CH78 2480MHz									
Antenna polarity: Vertical									
No	Freq (MHz)	Read Level (dBuV/m)	Antenna Factor (dB/m)	Cable loss(dB)	Amp Factor (dB)	Result (dBuV/m)	Limit (dBuV/m)	Margin (dB)	Remark
1	4960	52.12	33.98	10.22	34.25	62.07	74	11.93	PK
2	4960	38.06	33.98	10.22	34.25	48.01	54	5.99	AV
3	7440	/							
4	9920	/							
5	12400	/							
Antenna Polarity: Horizontal									
1	4960	50.33	33.98	10.22	34.25	60.28	74	13.72	PK
2	4960	38.76	33.98	10.22	34.25	48.71	54	5.29	AV
3	7440	/							
4	9920	/							
5	12400	/							
Note:									
1, Measuring frequency from 1GHz to 25GHz									
2, Spectrum Set for PK measure: RBW=1MHz, VBW=1MHz, Sweep time=Auto, Detector: PK									
2, Spectrum Set for AV measure: RBW=1MHz, VBW=10Hz, Sweep time=Auto, Detector: PK									
3, Result = Read level + Antenna factor + cable loss-Amp factor									
4, All the other emissions not reported were too low to read and deemed to comply with FCC limit.									

9. Band Edge Compliance

9.1. Block Diagram of Test Setup

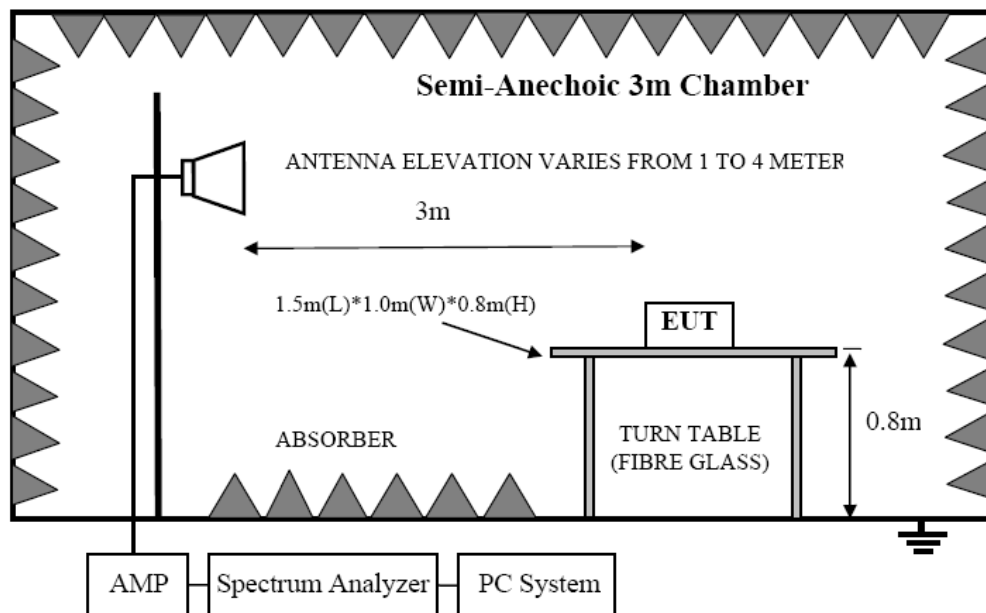

9.2. Limit

All the lower and upper band-edges emissions appearing within 2310MHz to 2390MHz and 2483.5MHz to 2500MHz restricted frequency bands shall not exceed the limits shown in 15.209, all the other emissions outside operation frequency band 2400MHz to 2483.5MHz and 5725MHz to 5850MHz shall be at least 20dB below the fundamental emissions, or comply with 15.209 limits.

9.3. Test Procedure

Same with clause 6.3 except change investigated frequency range from 2310MHz to 2405MHz, 2478MHz to 2510MHz.

9.4. Test Result

NOTE : The Band Edge is showed the maximum power data of all mode(GFSK, π /4 DQPSK, 8-DPSK)

PASS. (See below detailed test data)

GFSK
CH LOW :

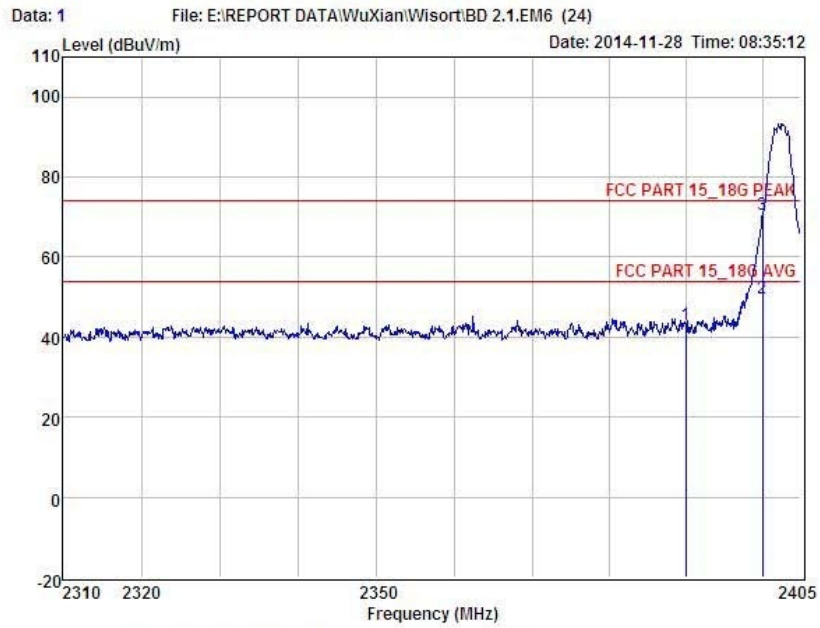

Condition : FCC PART 15_18G PEAK 3m POL: VERTICAL
 EUT : Bluetooth Speaker
 Model No : WS-303
 Test Mode : GFSK TX Low CH0
 Power : DC 5V From PC With AC 120V/60Hz
 Test Engineer : Store
 Remark :
 Temp : 24.2°C
 Hum : 54%

Item	Freq MHz	Read Level dBuV	Antenna Factor dB	Preamp Factor dB	Cable Loss dB	Level dBuV	Limit dBuV	Margin dBuV	Remark
1	2390.00	46.50	27.62	34.97	3.92	43.07	74.00	-30.93	Peak
2	2400.00	53.08	27.62	34.97	3.94	49.67	54.00	-4.33	Average
3	2400.00	74.12	27.62	34.97	3.94	70.71	74.00	-3.29	Peak

Remark: Level = Read Level + Antenna Factor - Preamp Factor + Cable Loss

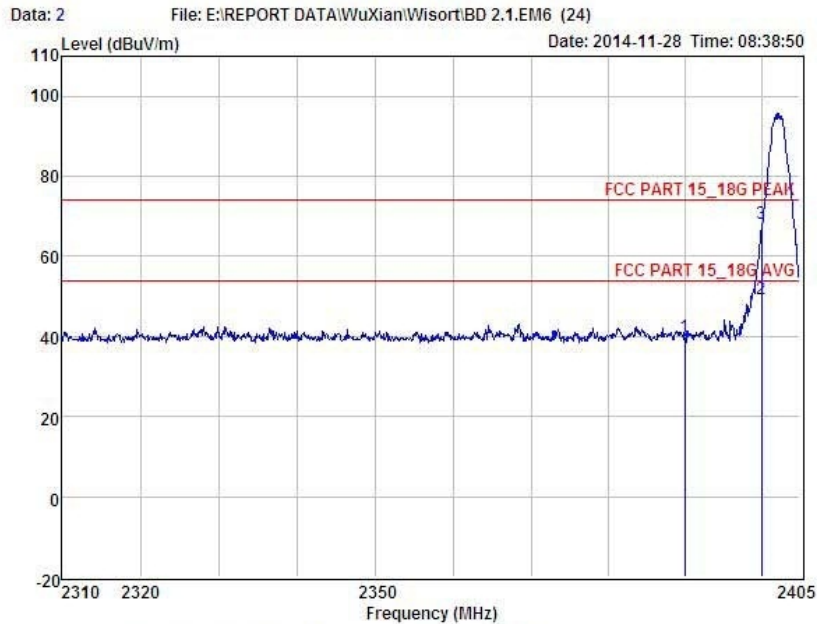

Condition : FCC PART 15_18G PEAK 3m POL: HORIZONTAL
 EUT : Bluetooth Speaker
 Model No : WS-303
 Test Mode : GFSK TX Low CH0
 Power : DC 5V From PC With AC 120V/60Hz
 Test Engineer : Store
 Remark :
 Temp : 24.2°C
 Hum : 54%

Item	Freq MHz	Read Level dBUV	Antenna Factor dB	Preamp Factor dB	Cable Loss dB	Level dBUV	Limit dBUV	Margin dBUV	Remark
1	2390.00	43.35	27.62	34.97	3.92	39.92	74.00	-34.08	Peak
2	2400.00	52.69	27.62	34.97	3.94	49.28	54.00	-4.72	Average
3	2400.00	71.47	27.62	34.97	3.94	68.06	74.00	-5.94	Peak

Remark: Level = Read Level + Antenna Factor - Preamp Factor + Cable Loss

CH High :

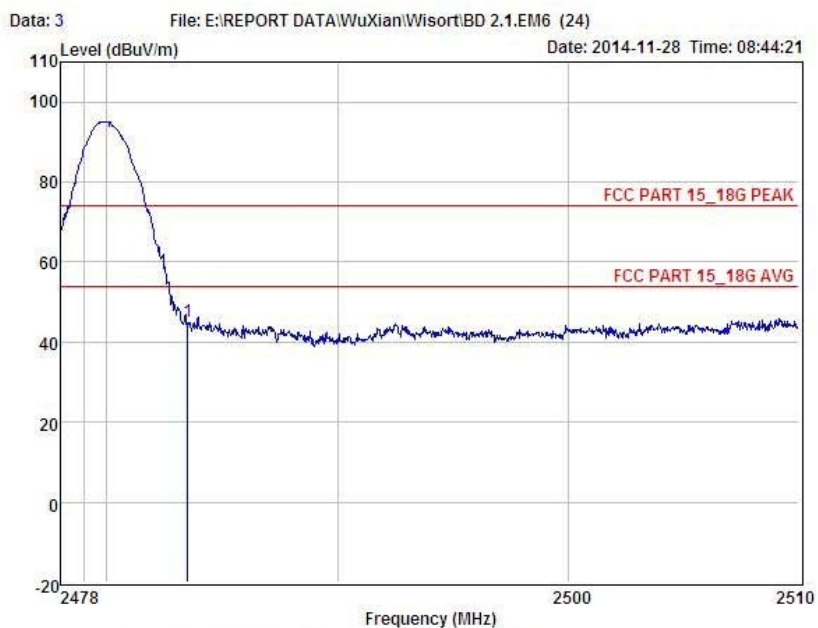

Condition : FCC PART 15_18G PEAK 3m POL: HORIZONTAL
 EUT : Bluetooth Speaker
 Model No : WS-303
 Test Mode : GFSK TX High CH78
 Power : DC 5V From PC With AC 120V/60Hz
 Test Engineer : Store
 Remark :
 Temp : 24.2°C
 Hum : 54%

Item	Freq MHz	Read Level dBuV	Antenna Factor dB	Preamp Factor dB	Cable Loss dB	Level dBuV	Limit dBuV	Margin dBuV	Remark
1	2483.50	48.47	27.59	34.97	4.00	48.09	74.00	-28.91	Peak

Remark: Level = Read Level + Antenna Factor - Preamp Factor + Cable Loss

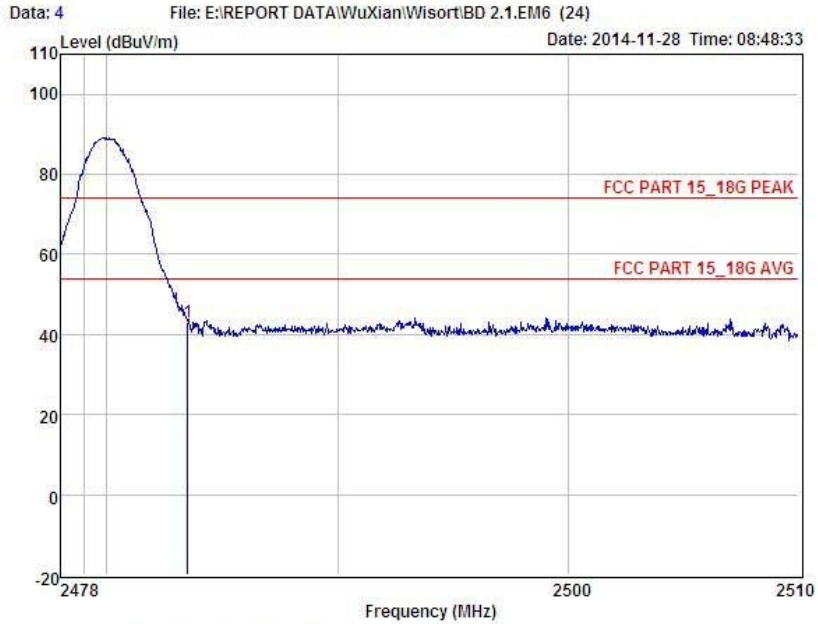

Condition : FCC PART 15_18G PEAK 3m POL: VERTICAL
 EUT : Bluetooth Speaker
 Model No : WS-303
 Test Mode : GFSK TX High CH78
 Power : DC 5V From PC With AC 120V/60Hz
 Test Engineer : Store
 Remark :
 Temp : 24.2°C
 Hum : 54%

Item	Freq MHz	Read Level dBUV	Antenna Factor dB	Preamp Factor dB	Cable Loss dB	Level dBUV	Limit dBUV	Margin dBUV	Remark
1	2483.50	46.58	27.59	34.97	4.00	43.20	74.00	-30.80	Peak

Remark: Level = Read Level + Antenna Factor - Preamp Factor + Cable Loss

Hopping

Lowest CH:

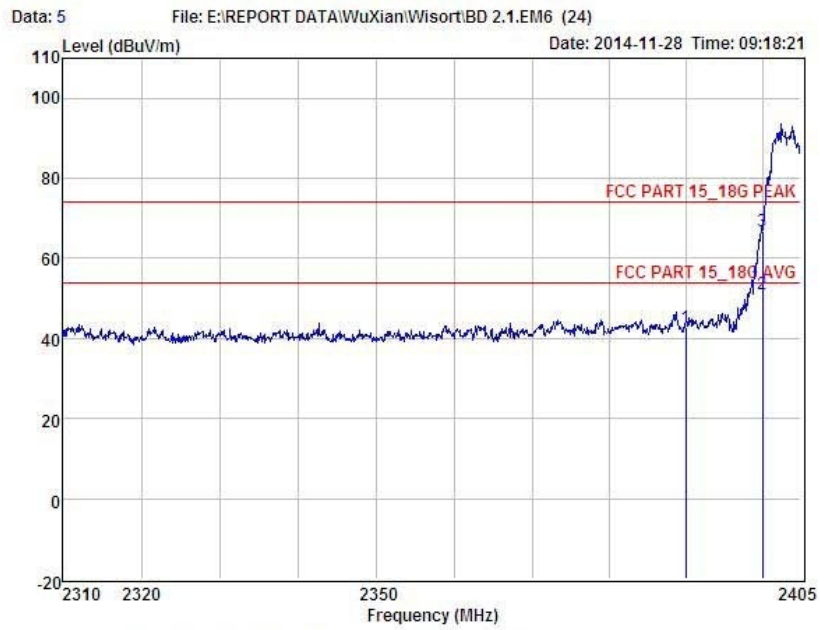

Condition : FCC PART 15_18G PEAK 3m POL: VERTICAL
 EUT : Bluetooth Speaker
 Model No : WS-303
 Test Mode : Hopping mode (GFSK) CH0
 Power : DC 5V From PC With AC 120V/60Hz
 Test Engineer : Store
 Remark :
 Temp : 24.2°C
 Hum : 54%

Item	Freq MHz	Read Level dBuV	Antenna Factor dB	Preamp Factor dB	Cable Loss dB	Level dBuV	Limit dBuV	Margin dBuV	Remark
1	2390.00	46.21	27.62	34.97	3.92	42.78	74.00	-31.22	Peak
2	2400.00	54.43	27.62	34.97	3.94	51.02	54.00	-2.98	Average
3	2400.00	70.33	27.62	34.97	3.94	66.92	74.00	-7.08	Peak

Remark: Level = Read Level + Antenna Factor - Preamp Factor + Cable Loss

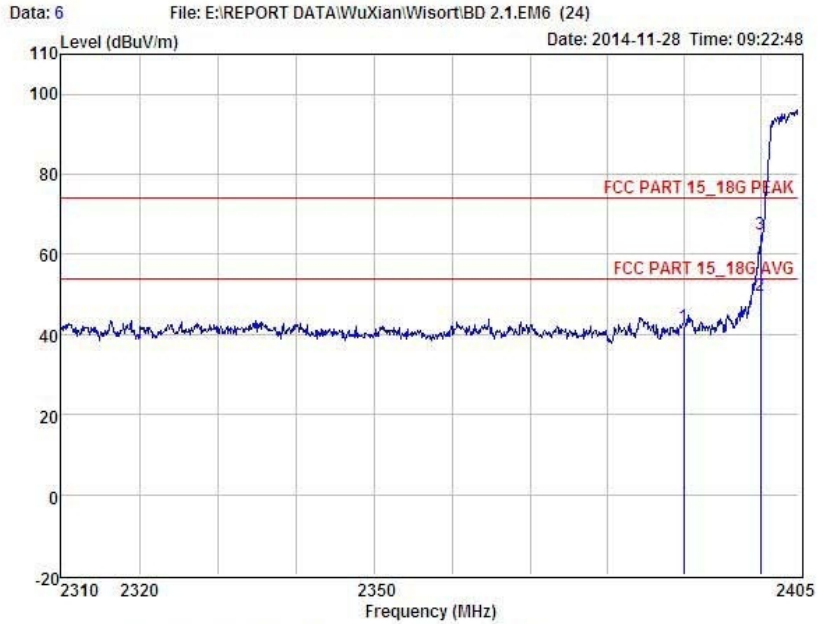

Condition : FCC PART 15_18G PEAK 3m POL: HORIZONTAL
 EUT : Bluetooth Speaker
 Model No : WS-303
 Test Mode : Hopping mode (GFSK) CH0
 Power : DC 5V From PC With AC 120V/60Hz
 Test Engineer : Store
 Remark :
 Temp : 24.2°C
 Hum : 54%

Item	Freq MHz	Read Level dBuV	Antenna Factor dB	Preamp Factor dB	Cable Loss dB	Level dBuV	Limit dBuV	Margin dBuV	Remark
1	2390.00	45.52	27.62	34.97	3.92	42.09	74.00	-31.91	Peak
2	2400.00	53.07	27.62	34.97	3.94	49.66	54.00	-4.34	Average
3	2400.00	68.34	27.62	34.97	3.94	64.93	74.00	-9.07	Peak

Remark: Level = Read Level + Antenna Factor - Preamp Factor + Cable Loss

Highest CH:

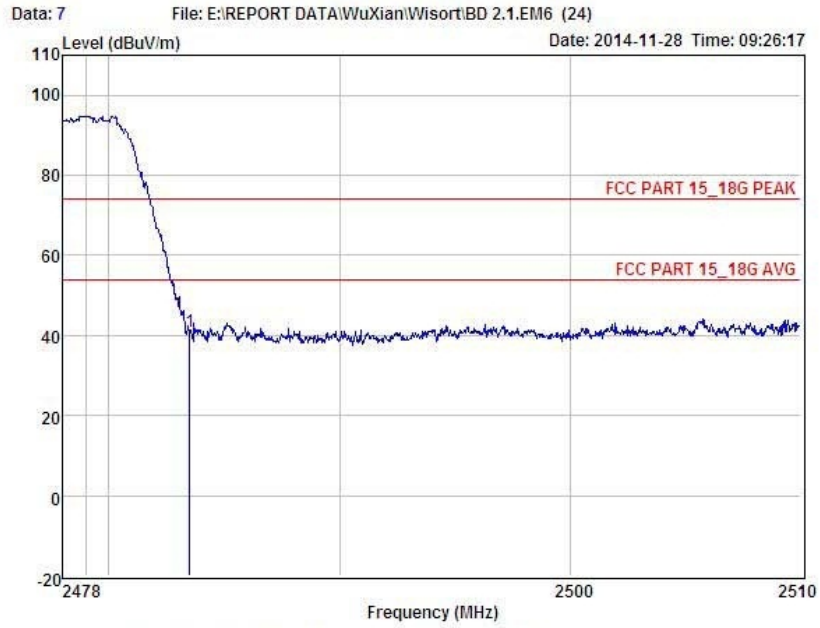

```

Condition : FCC PART 15_18G PEAK 3m      POL: HORIZONTAL
EUT       : Bluetooth Speaker
Model No  : WS-303
Test Mode : Hopping mode (GFSK) CH78
Power     : DC 5V From PC With AC 120V/60Hz
Test Engineer : Store
Remark    :
Temp      : 24.2°C
Hum       : 54%
    
```

Item	Freq MHz	Read Level dBuV	Antenna Factor dB	Preamp Factor dB	Cable Loss dB	Level dBuV	Limit dBuV	Margin dBuV	Remark
1	2483.50	44.38	27.59	34.97	4.00	41.00	74.00	-33.00	Peak

Remark: Level = Read Level + Antenna Factor - Preamp Factor + Cable Loss

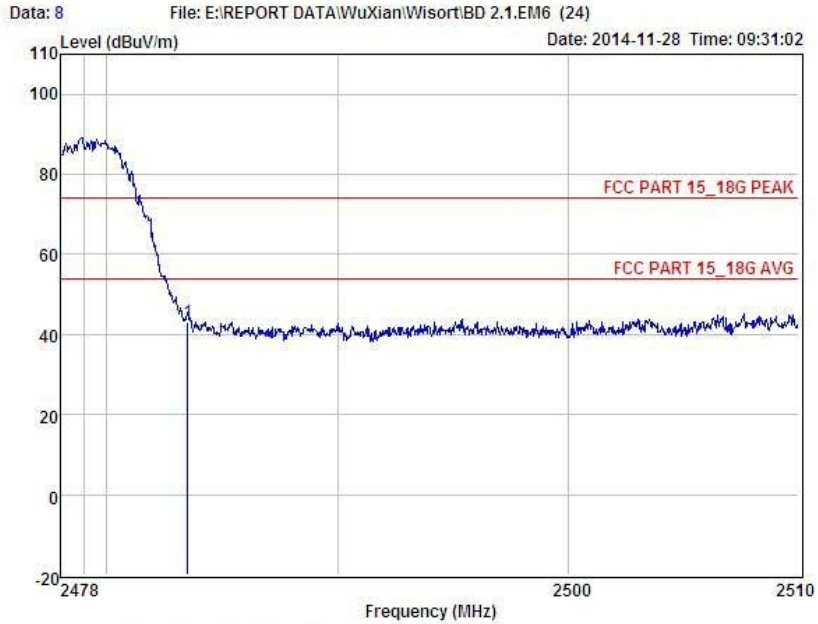

Condition : FCC PART 15_18G PEAK 3m POL: VERTICAL
 EUT : Bluetooth Speaker
 Model No : WS-303
 Test Mode : Hopping mode (GFSK) CH78
 Power : DC 5V From PC With AC 120V/60Hz
 Test Engineer : Store
 Remark :
 Temp : 24.2°C
 Hum : 54%

Item	Freq MHz	Read Level dBuV	Antenna Factor dB	Preamp Factor dB	Cable Loss dB	Level dBuV	Limit dBuV	Margin dBuV	Remark
1	2483.50	46.52	27.59	34.97	4.00	43.14	74.00	-30.86	Peak

Remark: Level = Read Level + Antenna Factor - Preamp Factor + Cable Loss

Pi/4-DQPSK
Lowest CH :

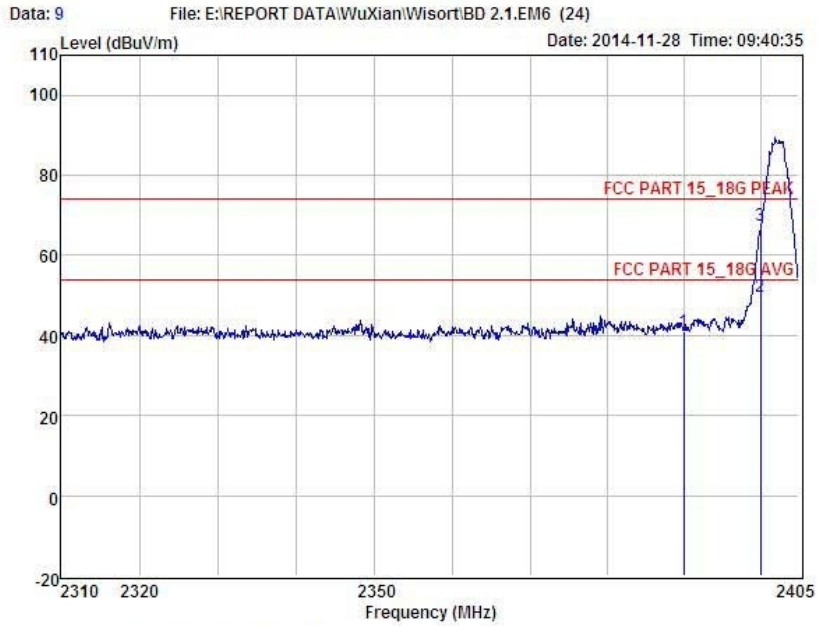

Condition : FCC PART 15_18G PEAK 3m POL: VERTICAL
 EUI : Bluetooth Speaker
 Model No : WS-303
 Test Mode : n/4DQPSK TX Low CH0
 Power : DC 5V From PC With AC 120V/60Hz
 Test Engineer : Store
 Remark :
 Temp : 24.2°C
 Hum : 54%

Item	Freq MHz	Read Level dBuV	Antenna Factor dB	Preamp Factor dB	Cable Loss dB	Level dBuV	Limit dBuV	Margin dBuV	Remark
1	2390.00	44.54	27.62	34.97	3.92	41.11	74.00	-32.89	Peak
2	2400.00	53.25	27.62	34.97	3.94	49.84	54.00	-4.16	Average
3	2400.00	70.84	27.62	34.97	3.94	67.43	74.00	-6.57	Peak

Remark: Level = Read Level + Antenna Factor - Preamp Factor + Cable Loss

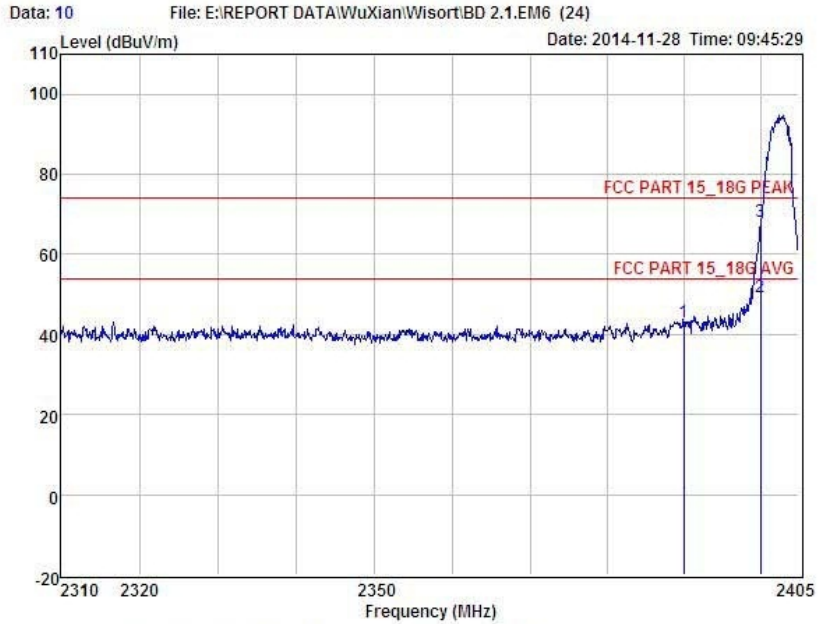

Condition : FCC PART 15_18G PEAK 3m POL: HORIZONTAL
 EUT : Bluetooth Speaker
 Model No : WS-303
 Test Mode : n/4QPSK TX Low CH0
 Power : DC 5V From PC With AC 120V/60Hz
 Test Engineer : Store
 Remark :
 Temp : 24.2°C
 Hum : 54%

Item	Freq MHz	Read Level dBuV	Antenna Factor dB	Preamplifier Factor dB	Cable Loss dB	Level dBuV	Limit dBuV	Margin dBuV	Remark
1	2390.00	46.43	27.62	34.97	3.92	43.00	74.00	-31.00	Peak
2	2400.00	52.61	27.62	34.97	3.94	49.20	54.00	-4.80	Average
3	2400.00	71.42	27.62	34.97	3.94	68.01	74.00	-5.99	Peak

Remark: Level = Read Level + Antenna Factor - Preamp Factor + Cable Loss

Highest CH:

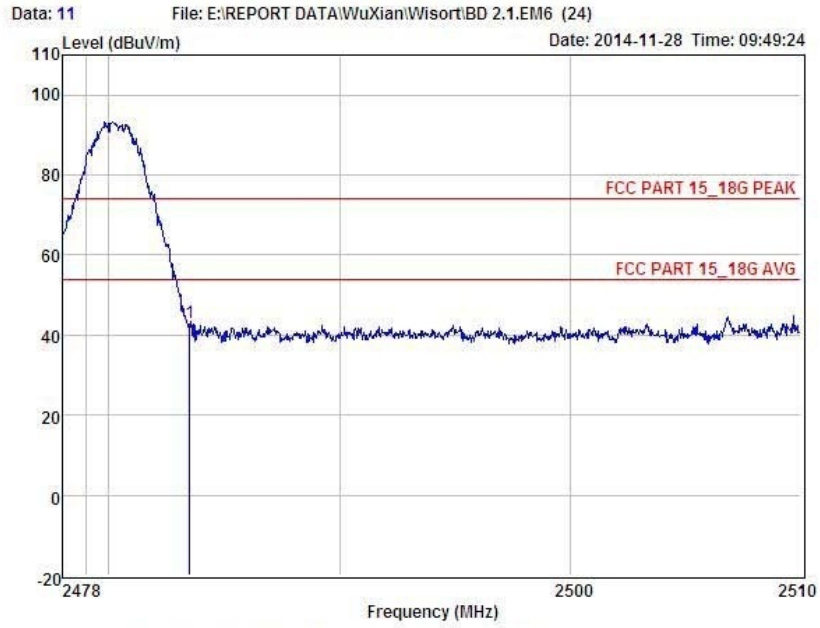

Condition : FCC PART 15_18G PEAK 3m POL: HORIZONTAL
 EUT : Bluetooth Speaker
 Model No : WS-303
 Test Mode : n/4DQPSK TX High CH78
 Power : DC 5V From PC With AC 120V/60Hz
 Test Engineer : Store
 Remark :
 Temp : 24.2°C
 Hum : 54%

Item	Freq MHz	Read Level dBuV	Antenna Factor dB	Preamp Factor dB	Cable Loss dB	Level dBuV	Limit dBuV	Margin dBuV	Remark
1	2483.50	46.42	27.59	34.97	4.00	43.04	74.00	-30.96	Peak

Remark: Level = Read Level + Antenna Factor - Preamp Factor + Cable Loss

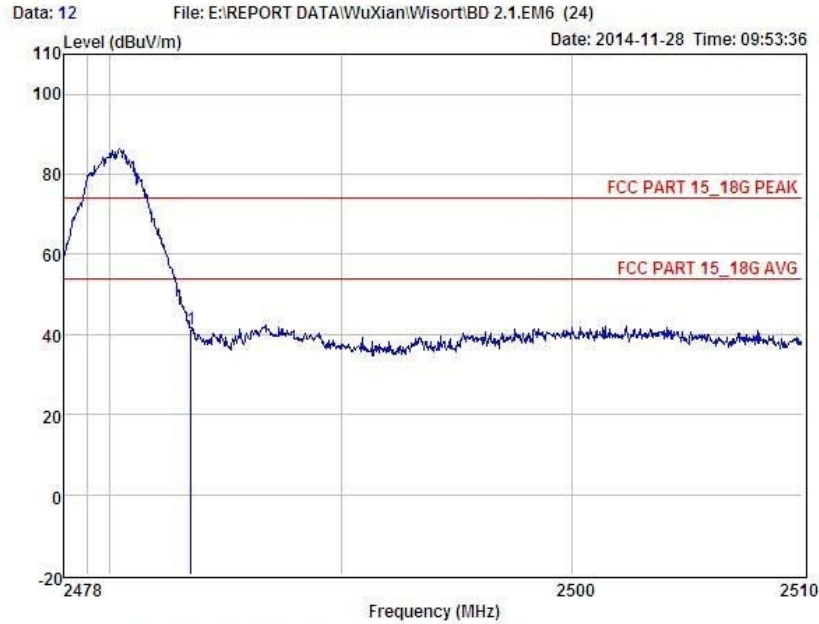

Condition : FCC PART 15_18G PEAK 3m POL: VERTICAL
 EUT : Bluetooth Speaker
 Model No : WS-303
 Test Mode : π/4DQPSK TX High CH78
 Power : DC 5V From PC With AC 120V/60Hz
 Test Engineer : Store
 Remark :
 Temp : 24.2°C
 Hum : 54%

Item	Freq MHz	Read Level dBuV	Antenna Factor dB	Preamp Factor dB	Cable Loss dB	Level dBuV	Limit dBuV	Margin dBuV	Remark
1	2483.50	44.61	27.59	34.97	4.00	41.23	74.00	-32.77	Peak

Remark: Level = Read Level + Antenna Factor - Preamp Factor + Cable Loss

Hopping mode:

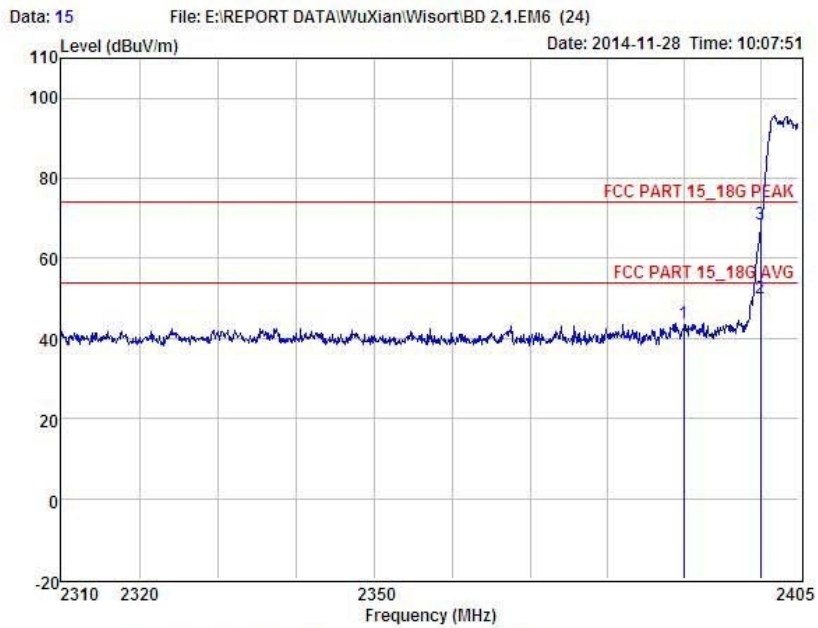

Condition : FCC PART 15_18G PEAK 3m POL: HORIZONTAL
 EUT : Bluetooth Speaker
 Model No : WS-303
 Test Mode : Hopping mode (m/4DQPSK) CH0
 Power : DC 5V From PC With AC 120V/60Hz
 Test Engineer : Store
 Remark :
 Temp : 24.2°C
 Hum : 54%

Item	Freq MHz	Read Level dBuV	Antenna Factor dB	Preamp Factor dB	Cable Loss dB	Level dBuV	Limit dBuV	Margin dBuV	Remark
1	2390.00	47.37	27.62	34.97	3.92	43.94	74.00	-30.06	Peak
2	2400.00	53.39	27.62	34.97	3.94	49.98	54.00	-4.02	Average
3	2400.00	72.09	27.62	34.97	3.94	68.68	74.00	-5.32	Peak

Remark: Level = Read Level + Antenna Factor - Preamp Factor + Cable Loss

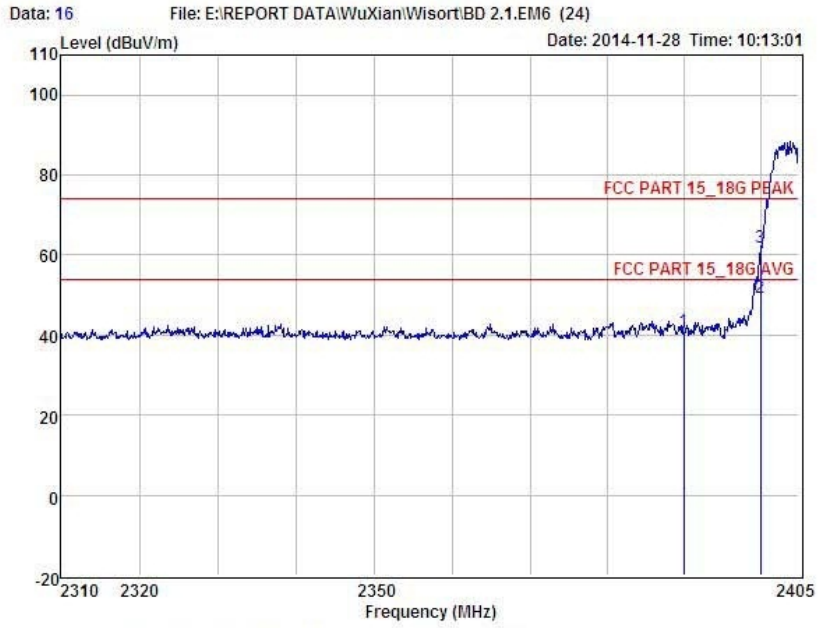

Condition : FCC PART 15_18G PEAK 3m POL: VERTICAL
 EUT : Bluetooth Speaker
 Model No : WS-303
 Test Mode : Hopping mode (π/4DQPSK) CH0
 Power : DC 5V From PC With AC 120V/60Hz
 Test Engineer : Store
 Remark :
 Temp : 24.2°C
 Hum : 54%

Item	Freq MHz	Read Level dBuV	Antenna Factor dB	Preamp Factor dB	Cable Loss dB	Level dBuV	Limit dBuV	Margin dBuV	Remark
1	2390.00	44.48	27.62	34.97	3.92	41.05	74.00	-32.95	Peak
2	2400.00	52.77	27.62	34.97	3.94	49.38	54.00	-4.64	Average
3	2400.00	65.28	27.62	34.97	3.94	61.87	74.00	-12.13	Peak

Remark: Level = Read Level + Antenna Factor - Preamp Factor + Cable Loss

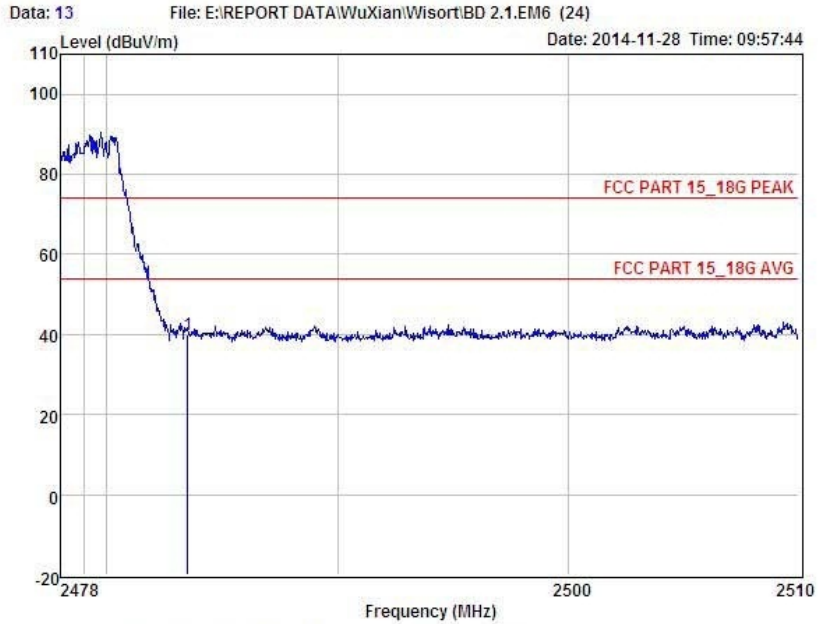

Condition : FCC PART 15_18G PEAK 3m POL: VERTICAL
 EUT : Bluetooth Speaker
 Model No : WS-303
 Test Mode : Hopping mode (π/4DQPSK) CH78
 Power : DC 5V From PC With AC 120V/60Hz
 Test Engineer : Store
 Remark :
 Temp : 24.2°C
 Hum : 54%

Item	Freq MHz	Read Level dBUV	Antenna Factor dB	Preamp Factor dB	Cable Loss dB	Level dBUV	Limit dBUV	Margin dBUV	Remark
1	2483.50	43.48	27.59	34.97	4.00	40.10	74.00	-33.90	Peak

Remark: Level = Read Level + Antenna Factor - Preamp Factor + Cable Loss

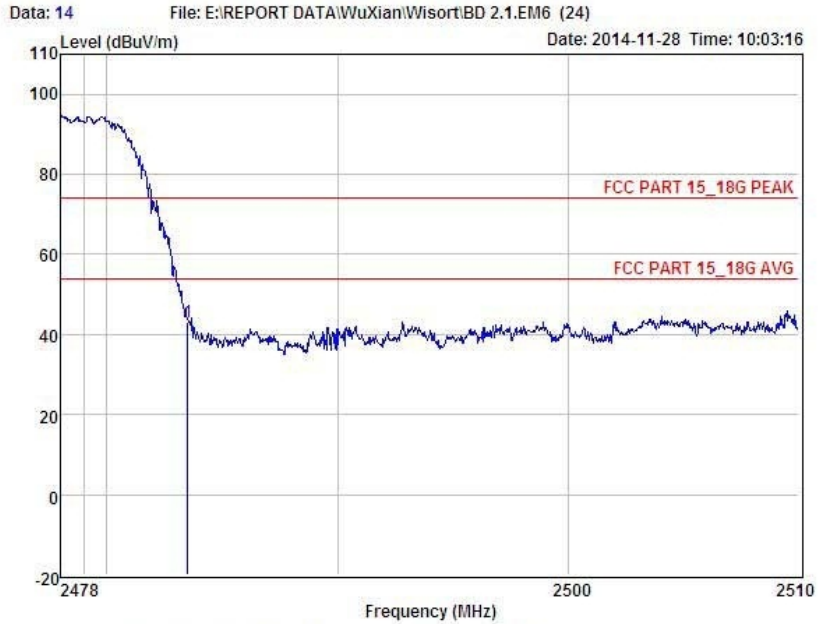

Condition : FCC PART 15_18G PEAK 3m POL: HORIZONTAL
 EUT : Bluetooth Speaker
 Model No : WS-303
 Test Mode : Hopping mode (π/4DQPSK) CH78
 Power : DC 5V From PC With AC 120V/60Hz
 Test Engineer : Store
 Remark :
 Temp : 24.2°C
 Hum : 54%

Item	Freq MHz	Read Level dBuV	Antenna Factor dB	Preamp Factor dB	Cable Loss dB	Level dBuV	Limit dBuV	Margin dBuV	Remark
1	2483.50	46.58	27.59	34.97	4.00	43.20	74.00	-30.80	Peak

Remark: Level = Read Level + Antenna Factor - Preamp Factor + Cable Loss

8-DPSK

Lowest CH:

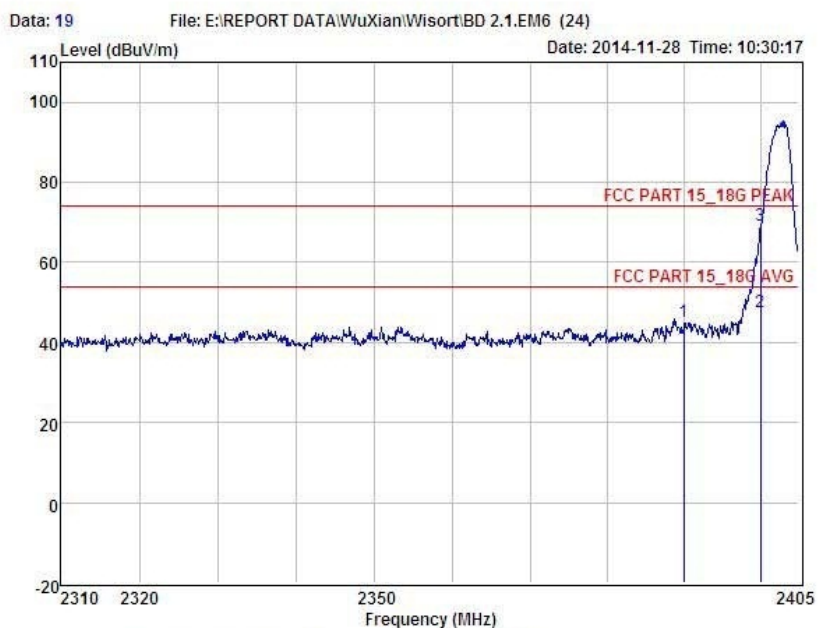

Condition : FCC PART 15_18G PEAK 3m POL: HORIZONTAL
 EUT : Bluetooth Speaker
 Model No : WS-303
 Test Mode : 8-DPSK TX Low CH0
 Power : DC 5V From PC With AC 120V/60Hz
 Test Engineer : Store
 Remark :
 Temp : 24.2°C
 Hum : 54%

Item	Freq MHz	Read Level dBuV	Antenna Factor dB	Preamp Factor dB	Cable Loss dB	Level dBuV	Limit dBuV	Margin dBuV	Remark
1	2390.00	48.60	27.62	34.97	3.92	45.17	74.00	-28.83	Peak
2	2400.00	51.09	27.62	34.97	3.94	47.68	54.00	-6.32	Average
3	2400.00	72.47	27.62	34.97	3.94	69.06	74.00	-4.94	Peak

Remark: Level = Read Level + Antenna Factor - Preamp Factor + Cable Loss

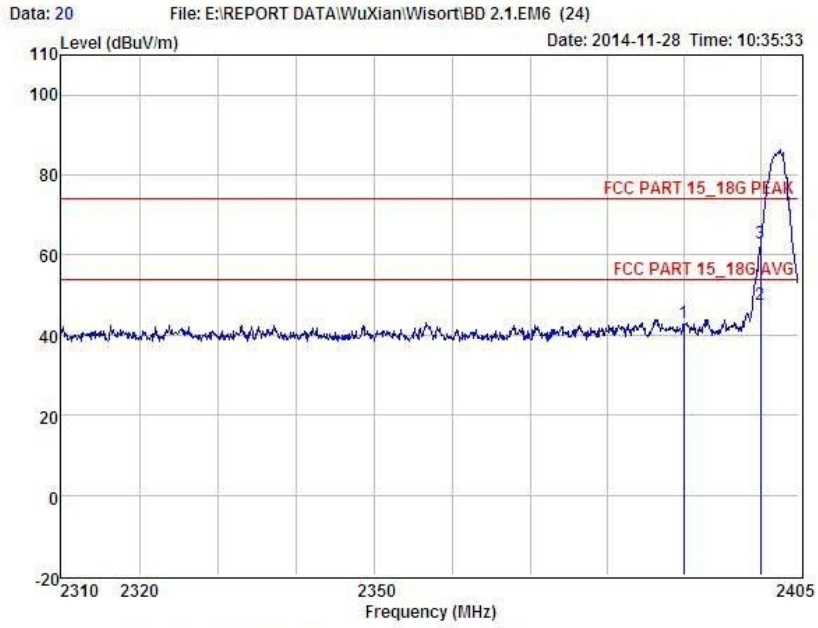

Condition : FCC PART 15_18G PEAK 3m POL: VERTICAL
 EUT : Bluetooth Speaker
 Model No : WS-303
 Test Mode : 8-DPSK TX Low CH0
 Power : DC 5V From PC With AC 120V/60Hz
 Test Engineer : Store
 Remark :
 Temp : 24.2°C
 Hum : 54%

Item	Freq MHz	Read Level dBuV	Antenna Factor dB	Preamp Factor dB	Cable Loss dB	Level dBuV	Limit dBuV	Margin dBuV	Remark
1	2390.00	46.53	27.62	34.97	3.92	43.10	74.00	-30.90	Peak
2	2400.00	51.09	27.62	34.97	3.94	47.68	54.00	-6.32	Average
3	2400.00	66.32	27.62	34.97	3.94	62.91	74.00	-11.09	Peak

Remark: Level = Read Level + Antenna Factor - Preamp Factor + Cable Loss

Highest CH:

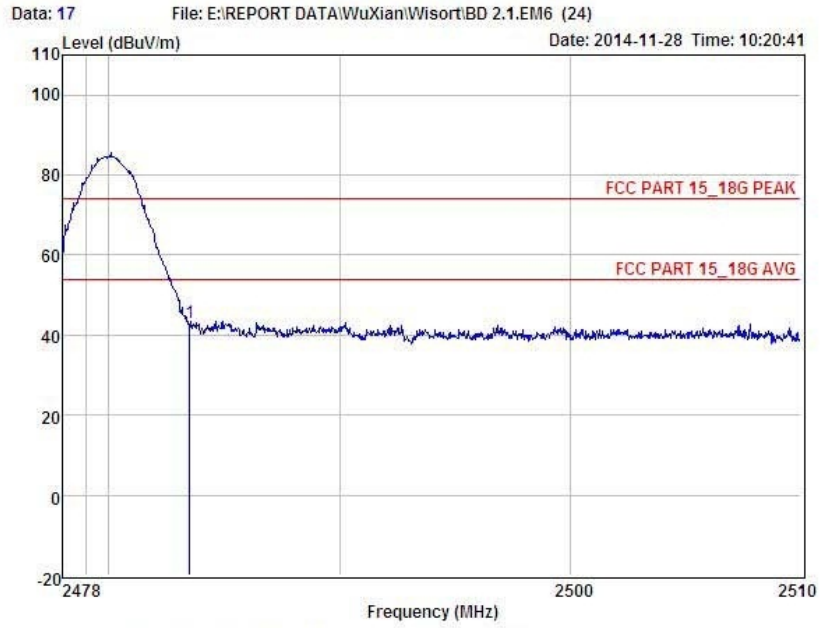

Condition : FCC PART 15_18G PEAK 3m POL: VERTICAL
 EUT : Bluetooth Speaker
 Model No : WS-303
 Test Mode : 8-DPSK TX High CH78
 Power : DC 5V From PC With AC 120V/60Hz
 Test Engineer : Store
 Remark :
 Temp : 24.2°C
 Hum : 54%

Item	Freq MHz	Read Level dBuV	Antenna Factor dB	Preamp Factor dB	Cable Loss dB	Level dBuV	Limit dBuV	Margin dBuV	Remark
1	2483.50	46.44	27.59	34.97	4.00	43.06	74.00	-30.94	Peak

Remark: Level = Read Level + Antenna Factor - Preamp Factor + Cable Loss

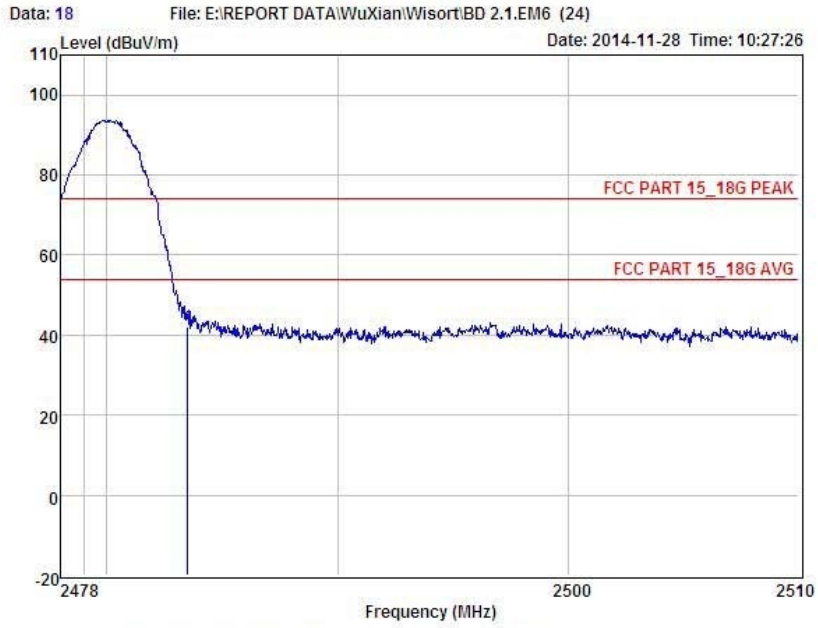

Condition : FCC PART 15_18G PEAK 3m POL: HORIZONTAL
 EUT : Bluetooth Speaker
 Model No : WS-303
 Test Mode : 8-DPSK TX High CH78
 Power : DC 5V From PC With AC 120V/60Hz
 Test Engineer : Store
 Remark :
 Temp : 24.2°C
 Hum : 54%

Item	Freq MHz	Read Level dBuV	Antenna Factor dB	Preamp Factor dB	Cable Loss dB	Level dBuV	Limit dBuV	Margin dBuV	Remark
1	2483.50	45.47	27.59	34.97	4.00	42.09	74.00	-31.91	Peak

Remark: Level = Read Level + Antenna Factor - Preamp Factor + Cable Loss

Hopping mode:

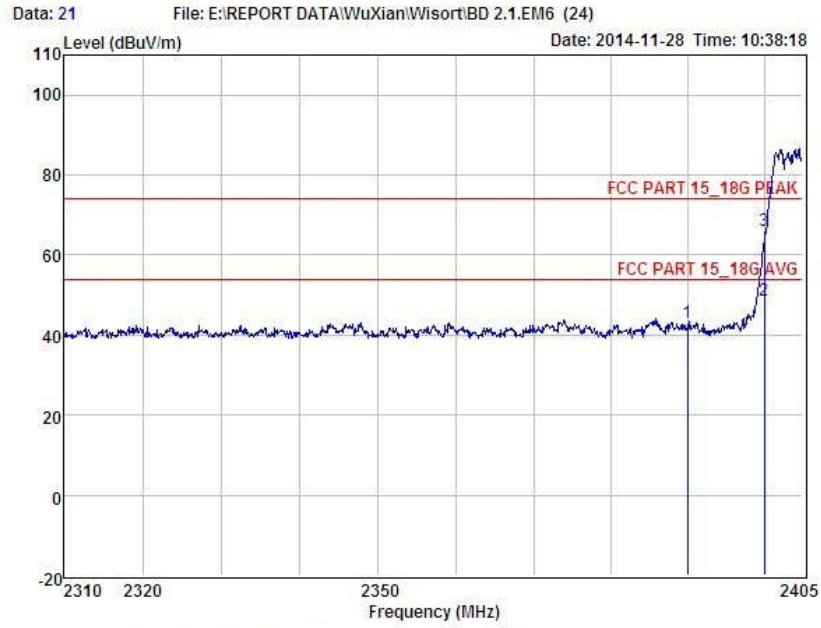

Condition : FCC PART 15_18G PEAK 3m POL: VERTICAL
 EUT : Bluetooth Speaker
 Model No : WS-303
 Test Mode : Hopping mode (8-DPSK) CH0
 Power : DC 5V From PC With AC 120V/60Hz
 Test Engineer : Store
 Remark :
 Temp : 24.2°C
 Hum : 54%

Item	Freq MHz	Read Level dBuV	Antenna Factor dB	Preamp Factor dB	Cable Loss dB	Level dBuV	Limit dBuV	Margin dBuV	Remark
1	2390.00	46.40	27.62	34.97	3.92	42.97	74.00	-31.03	Peak
2	2400.00	52.03	27.62	34.97	3.94	48.62	54.00	-5.38	Average
3	2400.00	69.38	27.62	34.97	3.94	65.97	74.00	-8.03	Peak

Remark: Level = Read Level + Antenna Factor - Preamp Factor + Cable Loss

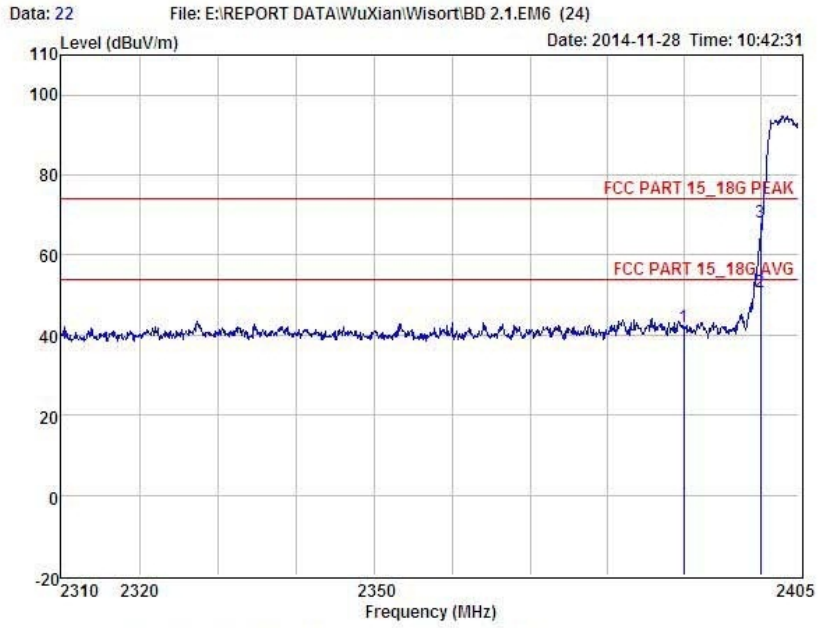

Condition : FCC PART 15_18G PEAK 3m POL: HORIZONTAL
 EUT : Bluetooth Speaker
 Model No : WS-303
 Test Mode : Hopping mode (8-DPSK) CH0
 Power : DC 5V From PC With AC 120V/60Hz
 Test Engineer : Store
 Remark :
 Temp : 24.2°C
 Hum : 54%

Item	Freq MHz	Read Level dBuV	Antenna Factor dB	Preamp Factor dB	Cable Loss dB	Level dBuV	Limit dBuV	Margin dBuV	Remark
1	2390.00	45.43	27.62	34.97	3.92	42.00	74.00	-32.00	Peak
2	2400.00	54.14	27.62	34.97	3.94	50.73	54.00	-3.27	Average
3	2400.00	71.56	27.62	34.97	3.94	68.15	74.00	-5.85	Peak

Remark: Level = Read Level + Antenna Factor - Preamp Factor + Cable Loss

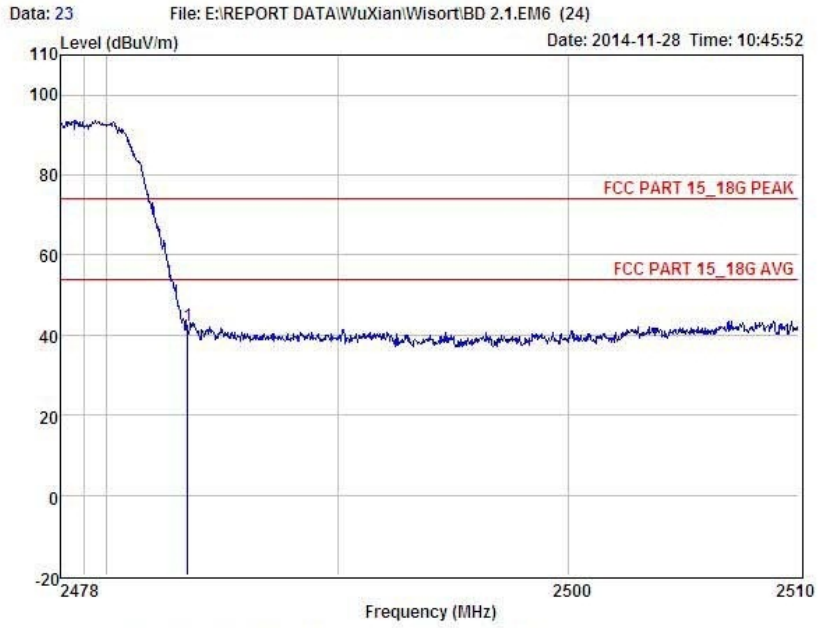

Condition : FCC PART 15_18G PEAK 3m POL: HORIZONTAL
 EUT : Bluetooth Speaker
 Model No : WS-303
 Test Mode : Hopping mode (8-DPSK) CH78
 Power : DC 5V From PC With AC 120V/60Hz
 Test Engineer : Store
 Remark :
 Temp : 24.2°C
 Hum : 54%

Item	Freq MHz	Read Level dBuV	Antenna Factor dB	Preamp Factor dB	Cable Loss dB	Level dBuV	Limit dBuV	Margin dBuV	Remark
1	2483.50	45.81	27.59	34.97	4.00	42.43	74.00	-31.57	Peak

Remark: Level = Read Level + Antenna Factor - Preamp Factor + Cable Loss

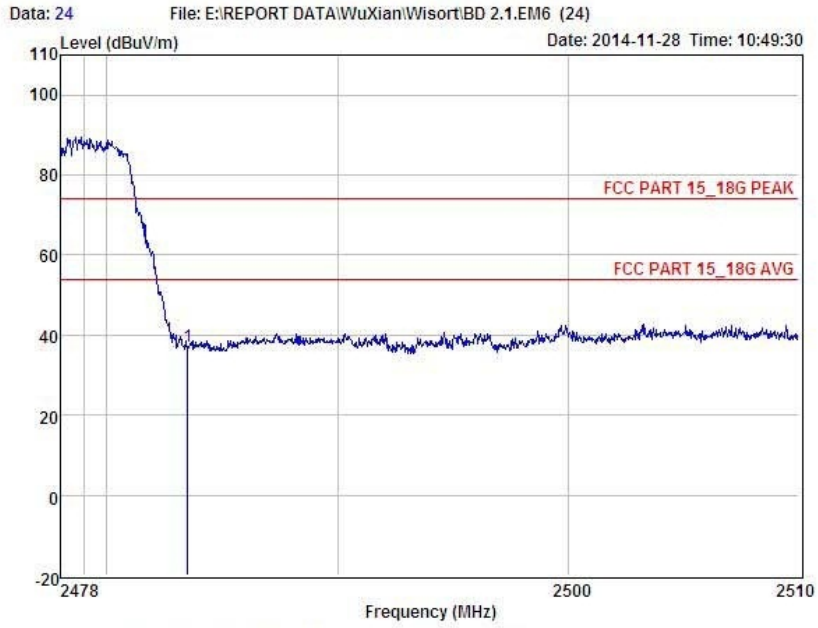

Condition : FCC PART 15_18G PEAK 3m POL: VERTICAL
 EUT : Bluetooth Speaker
 Model No : WS-303
 Test Mode : Hopping mode (8-DPSK) CH78
 Power : DC 5V From PC With AC 120V/60Hz
 Test Engineer : Store
 Remark :
 Temp : 24.2°C
 Hum : 54%

Item	Freq MHz	Read Level dBuV	Antenna Factor dB	Preamp Factor dB	Cable Loss dB	Level dBuV	Limit dBuV	Margin dBuV	Remark
1	2483.50	40.47	27.59	34.97	4.00	37.09	74.00	-36.91	Peak

Remark: Level = Read Level + Antenna Factor - Preamp Factor + Cable Loss

10. Power Line Conducted Emissions

10.1. Block Diagram of Test Setup

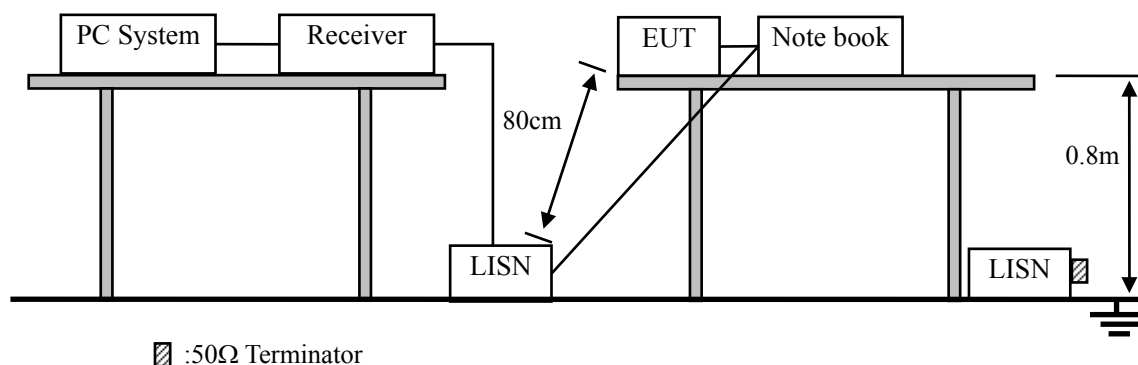

10.2. Limit

Frequency	Maximum RF Line Voltage	
	Quasi-Peak Level dB(μ V)	Average Level dB(μ V)
150kHz ~ 500kHz	66 ~ 56*	56 ~ 46*
500kHz ~ 5MHz	56	46
5MHz ~ 30MHz	60	50

Notes: 1. * Decreasing linearly with logarithm of frequency.

2. The lower limit shall apply at the transition frequencies.

10.3. Test Procedure

- (1) The EUT was placed on a non-metallic table, 80cm above the ground plane.
- (2) Setup the EUT and simulator as shown in 10.1
- (3) The EUT Power connected to the power mains through a power adapter and a line impedance stabilization network (L.I.S.N1). The other peripheral devices power cord connected to the power mains through a line impedance stabilization network (L.I.S.N2), this provided a 50-ohm coupling impedance for the EUT (Please refer to the block diagram of the test setup and photographs). Both sides of power line were checked for maximum conducted interference. In order to find the maximum emission, the relative positions of equipments and all of the interface cables were changed according to ANSI C63.4 2003 on conducted Emission test.
- (4) The bandwidth of test receiver is set at 10 kHz.
- (5) The frequency range from 150 KHz to 30MHz is checked.

10.4. Test Result

PASS. (See below detailed test data)

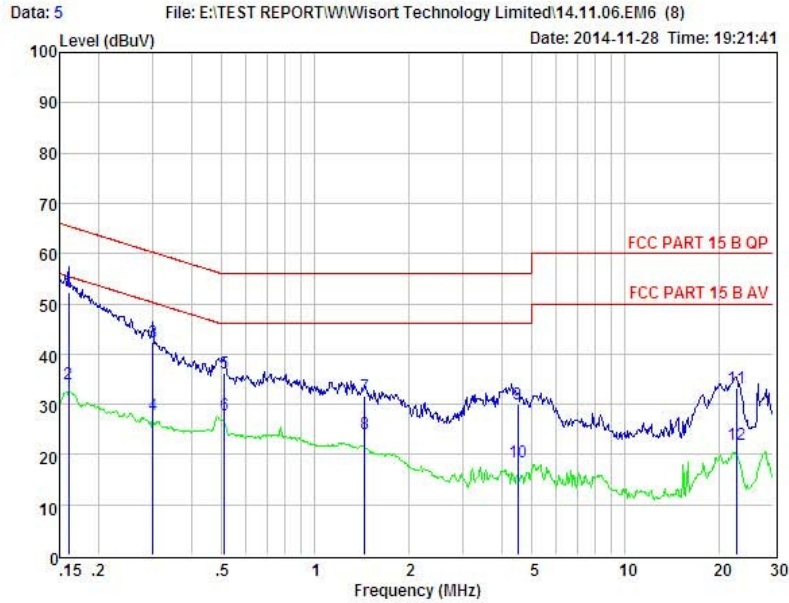

Condition : FCC PART 15 B QP POL: NEUTRAL Temp:24°C Hum:56%
 EUT : Bluetooth Speaker
 Model No : WS-303
 Test Mode : Charging and Link Mode
 Power : DC 5V From PC AC 120V/60Hz
 Test Engineer: Store
 Remark :

Item	Freq MHz	Read dBuV	LISN Factor dB	Preamp Factor dB	Cable Loss dB	Level dBuV	Limit dBuV	Margin dBuV	Remark
1	0.161	42.40	0.03	-9.72	0.10	52.25	65.43	-13.18	QP
2	0.161	24.15	0.03	-9.72	0.10	34.00	55.43	-21.43	Average
3	0.300	32.42	0.03	-9.72	0.10	42.27	60.24	-17.97	QP
4	0.300	17.95	0.03	-9.72	0.10	27.80	50.24	-22.44	Average
5	0.510	26.34	0.03	-9.72	0.10	36.19	56.00	-19.81	QP
6	0.510	18.15	0.03	-9.72	0.10	28.00	46.00	-18.00	Average
7	1.449	21.88	0.05	-9.71	0.10	31.74	56.00	-24.26	QP
8	1.449	14.14	0.05	-9.71	0.10	24.00	46.00	-22.00	Average
9	4.501	20.26	0.09	-9.68	0.12	30.15	56.00	-25.85	QP
10	4.501	8.61	0.09	-9.68	0.12	18.50	46.00	-27.50	Average
11	22.896	22.92	0.42	-9.55	0.43	33.32	60.00	-26.68	QP
12	22.896	11.60	0.42	-9.55	0.43	22.00	50.00	-28.00	Average

Remarks: Level = Read + LISN Factor - Preamp Factor + Cable loss

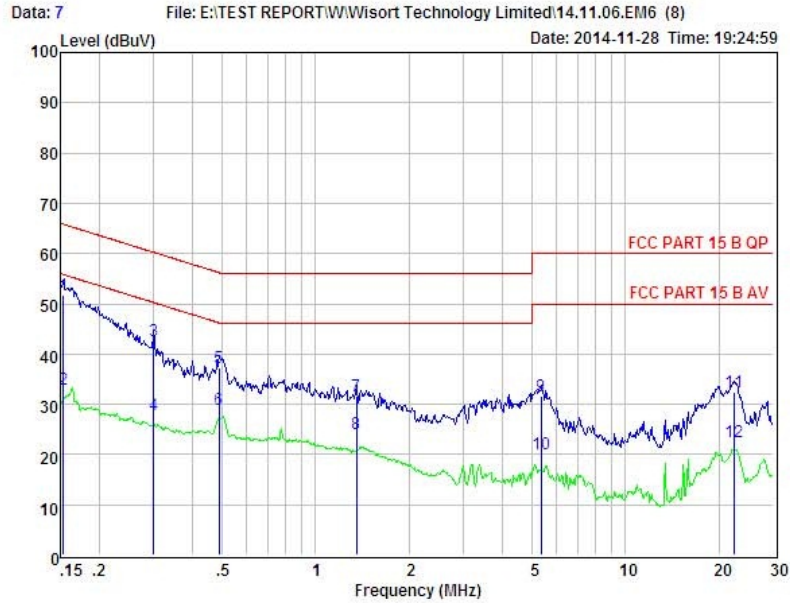

Condition : FCC PART 15 B QP POL: LINE Temp:24°C Hum:56%
 EUT : Bluetooth Speaker
 Model No : WS-303
 Test Mode : Charging and Link Mode
 Power : DC 5V From PC AC 120V/60Hz
 Test Engineer: Store
 Remark :

Item	Freq MHz	Read dBuV	LISN Factor dB	Preamp Factor dB	Cable Loss dB	Level dBuV	Limit dBuV	Margin dBuV	Remark
1	0.153	41.78	0.03	-9.72	0.10	51.63	65.82	-14.19	QP
2	0.153	23.15	0.03	-9.72	0.10	33.00	55.82	-22.82	Average
3	0.300	32.76	0.03	-9.72	0.10	42.61	60.24	-17.63	QP
4	0.300	18.15	0.03	-9.72	0.10	28.00	50.24	-22.24	Average
5	0.489	27.43	0.03	-9.72	0.10	37.28	56.19	-18.91	QP
6	0.489	19.15	0.03	-9.72	0.10	29.00	46.19	-17.19	Average
7	1.352	21.83	0.05	-9.71	0.10	31.69	56.00	-24.31	QP
8	1.352	14.14	0.05	-9.71	0.10	24.00	46.00	-22.00	Average
9	5.333	21.78	0.10	-9.66	0.13	31.67	60.00	-28.33	QP
10	5.333	10.11	0.10	-9.66	0.13	20.00	50.00	-30.00	Average
11	22.535	22.11	0.41	-9.54	0.41	32.47	60.00	-27.53	QP
12	22.535	12.14	0.41	-9.54	0.41	22.50	50.00	-27.50	Average

Remarks: Level = Read + LISN Factor - Preamp Factor + Cable loss

11. Antenna Requirements

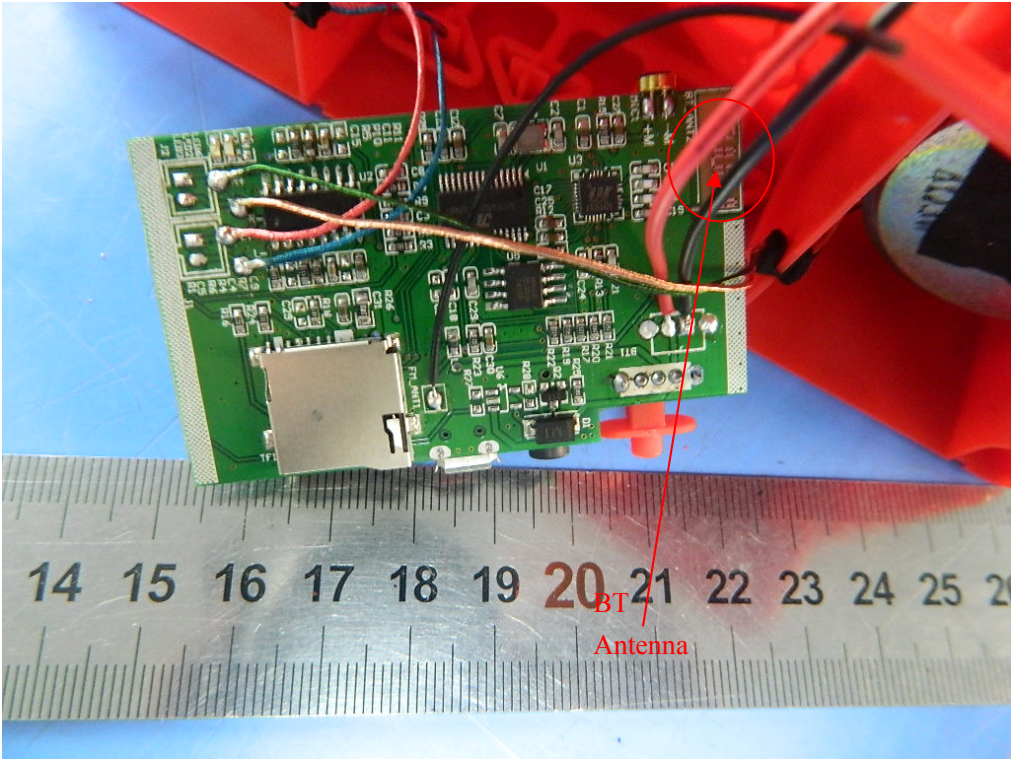
Standard requirement:	FCC Part15 C Section 15.203 /247(c)
<p>15.203 requirement: An intentional radiator shall be designed to ensure that no antenna other than that furnished by the responsible party shall be used with the device. The use of a permanently attached antenna or of an antenna that uses a unique coupling to the intentional radiator, the manufacturer may design the unit so that a broken antenna can be replaced by the user, but the use of a standard antenna jack or electrical connector is prohibited.</p> <p>15.247(c) (1)(i) requirement: (i) Systems operating in the 2400-2483.5 MHz band that is used exclusively for fixed. Point-to-point operations may employ transmitting antennas with directional gain greater than 6dBi provided the maximum conducted output power of the intentional radiator is reduced by 1 dB for every 3 dB that the directional gain of the antenna exceeds 6dBi.</p>	
E.U.T Antenna:	
<p>The antenna is PCB antenna, which permanently attached, and the best case gain of the antenna is 0 dBi.</p>	
	

12. Test setup photo

12.1. Photos of Radiated emission

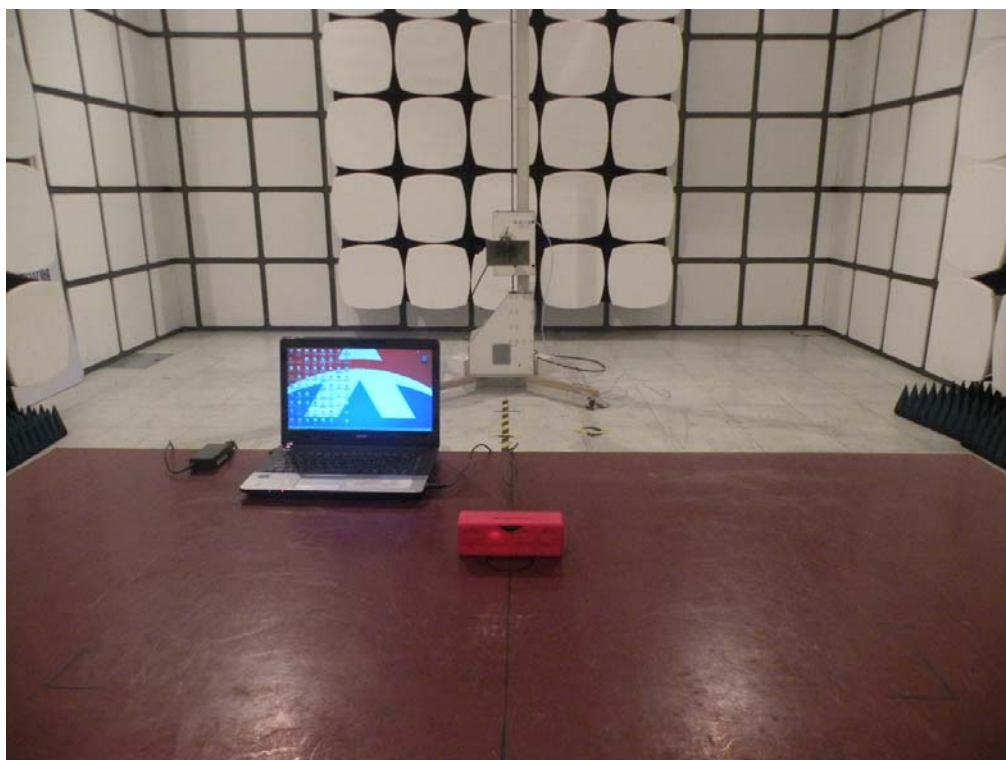
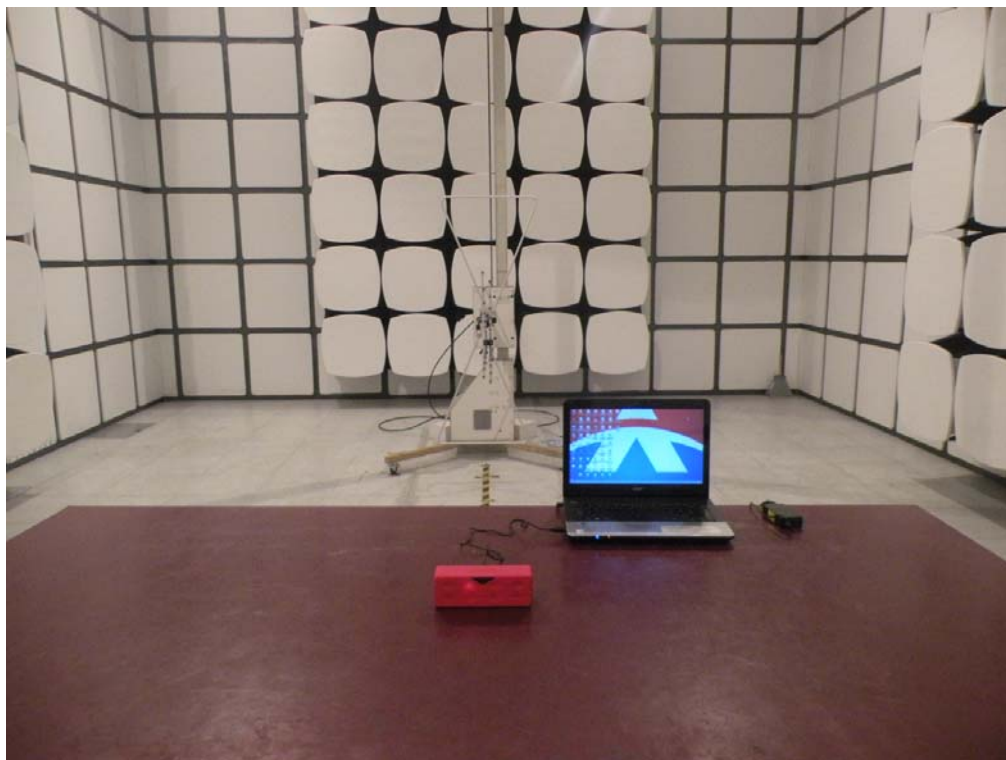

12.2.Photos of Conducted Emission test



13.Photos of EUT

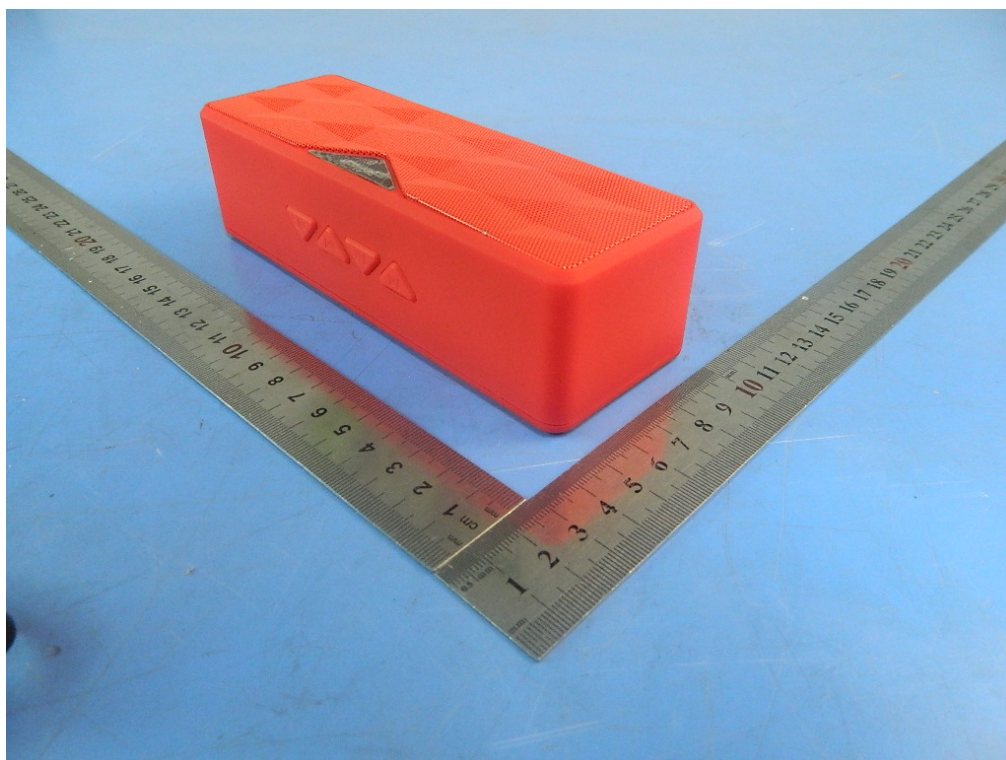

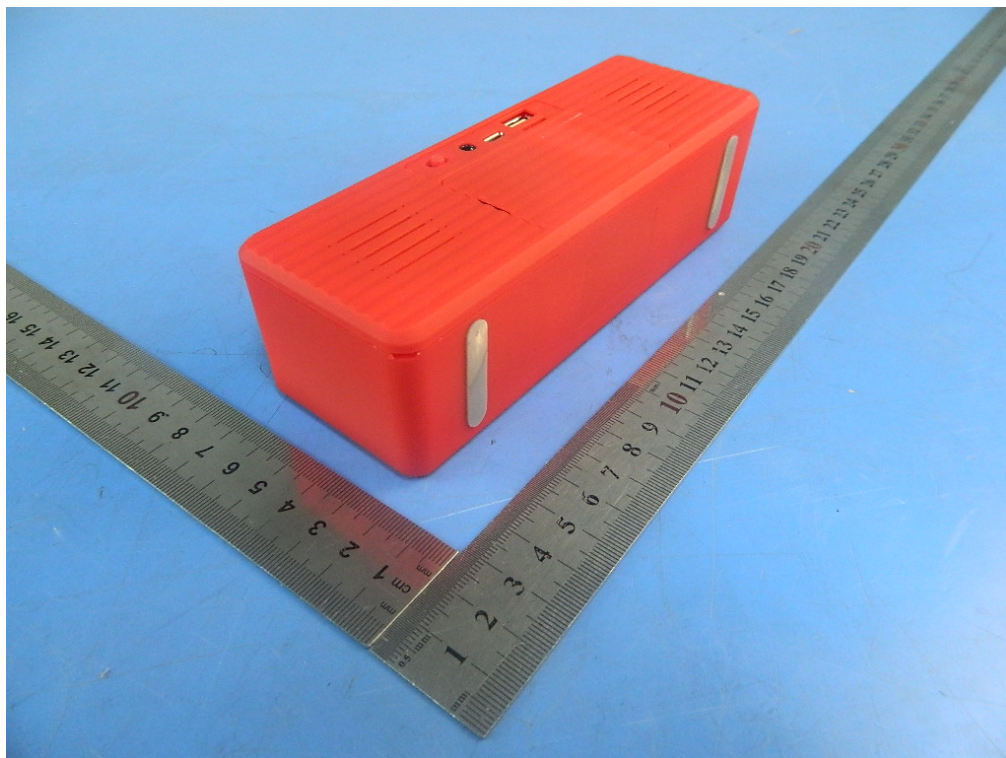

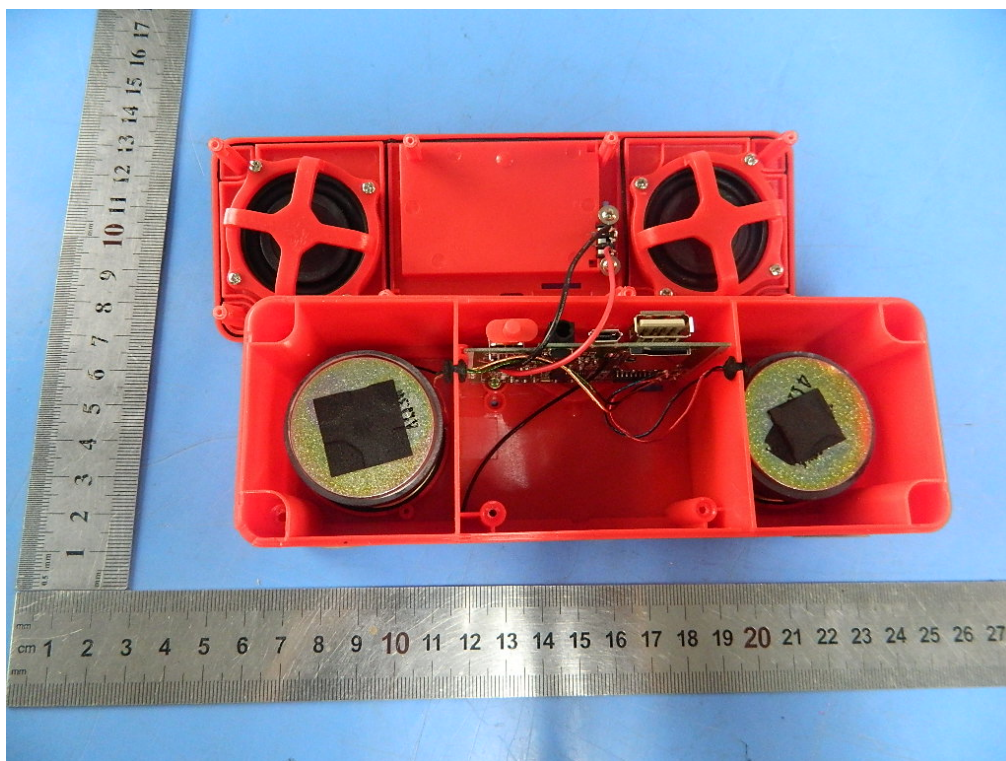

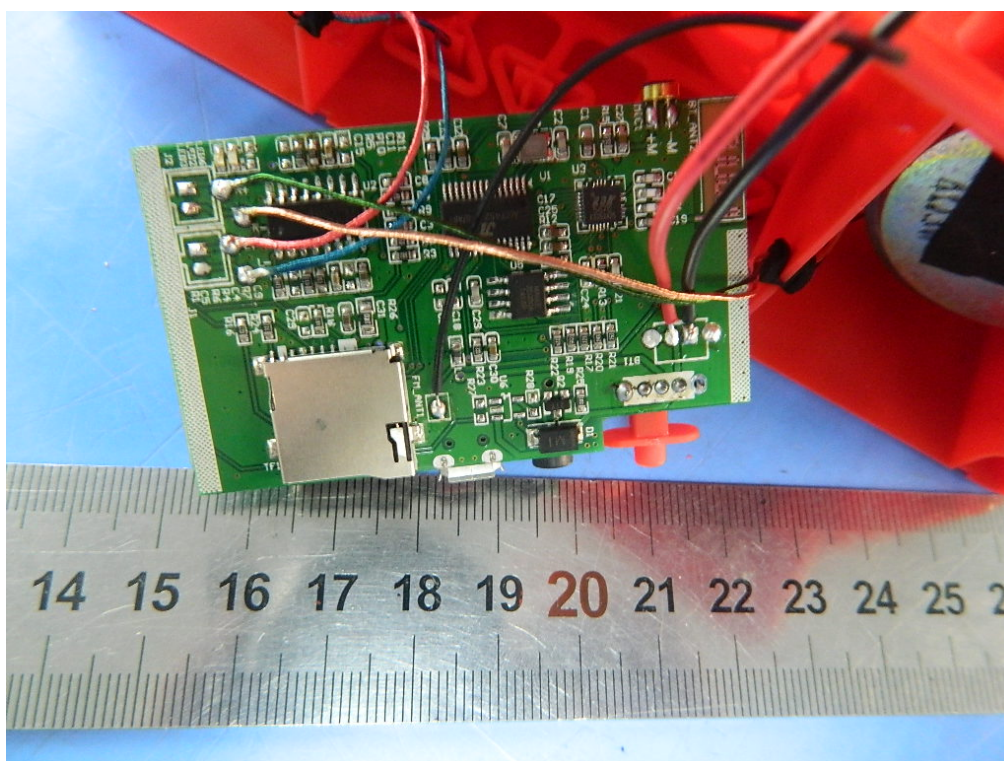
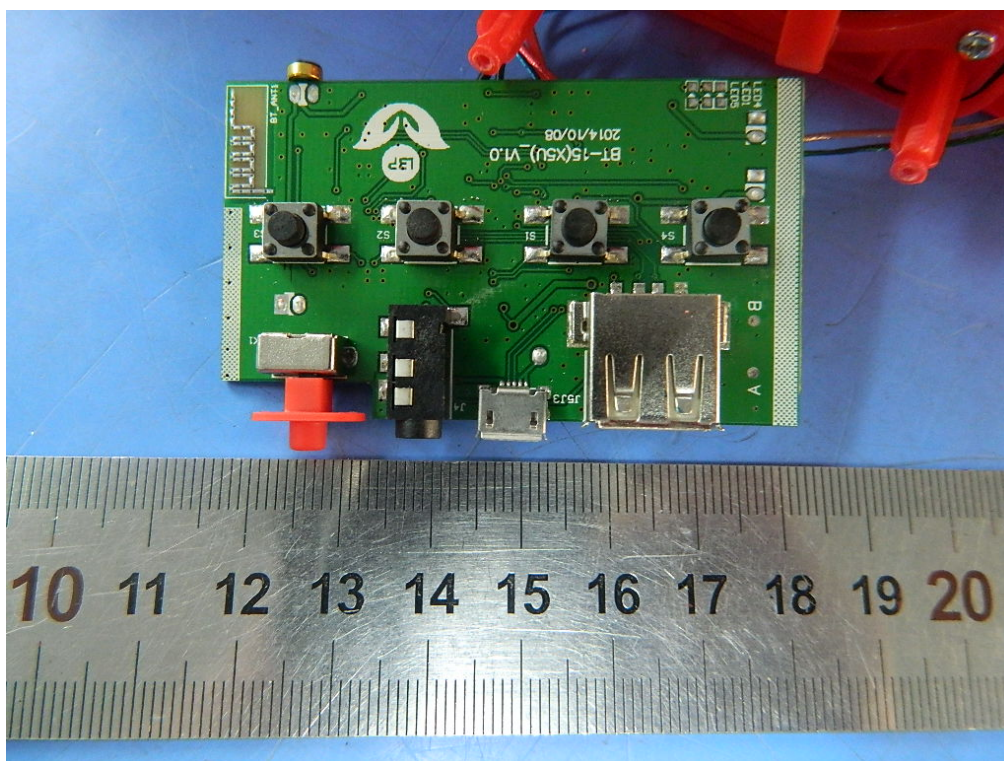

-----END OF THE REPORT-----