

# Genuine Product



## Multimedia Navigation System

⚠ Before using this navigation system, please read this manual carefully and preserve it properly for future reference.

---

Notes before Installation

---

Functions Instruction

---

AV Operation

---

Introducing Optional Function

---

Other Information

**FLYAUDIO**

V1.0

To avoid accident, please DO NOT watch video while driving .

## Safety Info

---

### **Please read through this User's Manual**

Before using this navigation system, please be sure to read through and fully understand the following safety information, so as to enjoy the advanced functions. Please preserve this User's Manual for future reference.

### **Ensure Safe Driving**

- Ensure obeying safety driving regulations and current traffic rules.
- Operating this navigation system (and the optional car reversing camera) may distract your attention of driving the car safely.
- If you need to watch the monitor to conduct any system operation, please park the car at a safety place, and take the parking brake, before making necessary adjustment.
- DO NOT set the volume of the navigation system too high, as you may not be aware of the traffic condition and SOS signal outside.

- For safety reason, some functions of the system may be disabled while driving, unless you stop the car or use stopping brake.
- Please DO NOT wear ear phone while driving.
- The blue and white wire at power connector is for detecting the status of car stopping. It must be connected with the power of car stopping switch. Improper connection or use of this wire may be law-breaking, and may endanger your personal safety.
- To avoid car accident and possible breaking to applicable law, please DO NOT use the navigation system for any other purpose other than navigation while driving. Likewise, the rearview monitor shouldn't be used while blocking the vision of the driver.
- When using the monitor connected to rear monitor output, the rearview monitor

output of this system is for connecting to monitor, so as the passengers in rear seats watch program and conduct relevant operation while driving.

### **Warning:**

- Please DO NOT install or fix your navigation system on your own. Danger could happen when this navigation system is installed or fixed by the personnel without receiving electronic device and automobile parts training, and you may be under the risk of electric shock or other dangers. Please DO NOT watch program and conduct relevant operation while driving.
- Watching video and conducting relevant operation while driving is prohibited by the laws in some countries. For your and other person's safety, please DO NOT do it while driving.
- DO NOT contact this system with liquid,

otherwise, electric shock may happen, it may also cause damage to the system, smoke and overheat etc.

### **Safety Announcement**

- The navigation function of this product (and the optional car reversing camera) serves as your assistance while driving. It doesn't mean that you could distract attention, absent-minded or lose judgment while driving. The accident it caused is irrelevant with our company.
- The intellectual right of the digital map written into TF card belongs to the supplier. Map supplier is responsible for the content of it.

---

### **Announcement**

This User's Manual mainly introduces the function, purpose and operation of the vehicle AV system product. This manual serves as an operation guideline for

## Announcement

---

users, rather than maintenance service evidence. If there is any alteration of design and specification as the constant improvement of product, we won't deliver separated notice. The product is subject to the material object. For details, please inquiry the dealers.

- The pictures in the manual are for reference only. The error of your understanding is irrelevant with our company.
- The registered trademarks and product names are held by the companies they belong to.
- The information in the manual could be altered without making announcement. Our company reserves the ultimate right of explanation of the information provided.
- If this product couldn't work normally, please inquiry to the customer services department of the manufacturer.

- Without prior written license by our company, any part of this material can't be copied, altered, dispatched or used in any other way.

- Product Notice

"This product incorporates copyright protection technology that is protected by U.S. patents and other intellectual property rights. Use of this copyright protection technology must be authorized by Rovi Corporation, and is intended for home and other limited viewing uses only unless otherwise authorized by Rovi Corporation. Reverse engineering and disassembly are prohibited."

## Before using the system

Notes before installation	1
Welcome	2
System installation	2
1. Installation key points	2
2. Mainframe installation	3
3. GPS antenna installation	3
Preparation before use	5
1. Power on/off	5
2. Installation steps	5
3. Special notices	6
4. Insert and take out Disc	7

---

## Front Panel Functions

Front panel diagram	8
Front panel parts	9

## Functions and AV operation

Touch screen operation	10
Main menu	10
Disc playback	11
Sound effect setup	15
Tune and balance	16
Listen to radio	18
Operating iPod	20
Operating MP3 player	22
Navigation system	23
Operating Bluetooth telephone functions	26
Operating Bluetooth music function	27
Operating function configuration	28

---

## Optional functions

Rear seats entertaining operation	34
Watching TV program	34
TPMS setup	35

## Index

---

### Appendix

Disc type for playback	37
Use the monitor correctly	38
1. Notice of use	38
2. About LCD monitor	38
3. About maintenance	38
Use of the Disc player	39
1. Notice of operating Disc player	39
2. About maintenance	39
3. Notice of preservation	39
4. About the environment of playing	40
Disc When with failure	40
Common Problem	41
DVD Video	43
CD/MP3Disc	44
Terms definition	45
1. CD/MP3 Disc	45
2. DVD Video	46

### Specification

Universal	47
GPS	47
Amplifier and audio parts	47
DVD player parts	47
FM parts	48
AM parts	48
Monitor parts	48
GPS antenna	48
Dimension	49

---

### Quick Installation Guide

### Notice before installation

Product manufacture doesn't recommend you to install or maintenance this navigation system on your own, as you may be under electric shock or other dangers. Please entrust all about the installation and maintenance to the official licensed staff.

#### **Warning:**

#### **Following dangerous installation positions or approaches are forbidden.**

- When the vehicle comes to a sudden stop, driver or passenger may be injured.
- Driver's vision or vehicle operation may be hindered. For example, front ground of driving seat, or where close to steering wheel and gear lever.
- Driver's ability of safe driving may be influenced.
- The product is forbidden to be installed on meter panel, car gate or column, as well

as the front or where close to the opening area of vehicle air bag. Please refer to your vehicle user's manual to understand such opening area.

#### **Caution :**

- If hole drilling or other alteration is needed while installing, please consult with the dealer nearby.
- When opening hole on panel, please make sure with rear space. Please DO NOT damage fuel cable, brake cable, electrical components, communication cable or power cable.
- When using screw, please make sure it is not contacted with any electric wire. Vibration may damage electric wire or the insulated skin, causing short circuit or damage to other vehicles.
- For ensuring correct installation, please use the standard parts to install in complied with the regulations. If using any non-standard part, the internal

## Before using the system

---

component of the product may be damaged or loosen, resulting product damage.

- If GPS antenna lead wraps steering column or gear lever, it is extremely dangerous. Please make the installation won't hinder driving.
- Please make sure all leads won't be hooked by car door or sliding mechanism of the seats, for avoiding short circuit.
- To prevent from electromagnetic interference, please put other cables or leads away from the FM, AM antenna and their leads, GPS antenna and its lead. You should arrange the above-mentioned leads separated each other. DO NOT bind up the leads or cross them, otherwise, electromagnetic interference may be intensified, leading to incorrect positioning or error display.
- After finishing navigation system installation, examine and confirm other devices of the vehicles are correctly connected.

## Welcome

---

Thank you for using our multimedia vehicle navigation system, we sincerely provide with excellent quality and superb experience to you.

## System Installation

---

### 1. Installation key points

- This product is used for vehicles with 12V storage battery and negative ground end. Before installation, please check out the voltage in storage battery.
- To avoid system short circuit, it is recommended to dismantle the negative wire of the battery.
- DO NOT directly connect this product to storage battery by over passing fuse.
- DO NOT directly connect the power cable of this product to the power cable of other electric appliances.



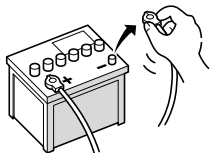

### 2. Mainframe installation

- Firstly take out the original mainframe.
- Dismantle the bracket and screws, and then preserve them. Use connection cable to finish connection.
- Lastly, put the mainframe in place, and use the original installing screws to fasten the mainframe.

**⚠ Caution: Don't damage or stain the panel.**

### 3. GPS antenna installation

- ① Before using binding tape to fasten the GPS antenna, please be sure to use proper

cleanse the adhering area. After cleansing, tear down the back paper, place the GPS antenna at a proper place, and press it tight with strength.

- ② Dismantle the side panel, take the cable through storage box, to the mainframe at central control platform. Please bind up the cable with the original cables.
- ③ Connect the GPS antenna port with the mainframe.

**⚠ Caution:**

- **Please make sure all devices are installed at safe places. If user's vehicle is installed with other devices, please make sure such installation won't interfere with its function.**
- **Before installation, please read through all instructions. It is advised to ask auto Hi-Fi professional dealer to install this machine.**

## Before using the system

---

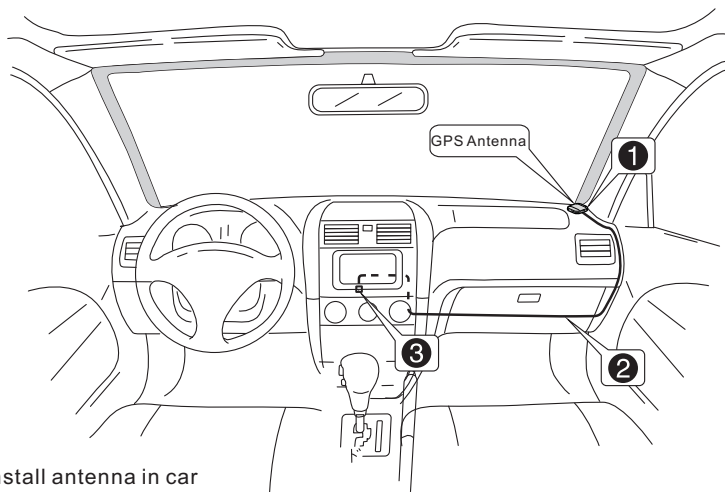

Choose to install antenna in car

### Preparation before use

#### 1. Power on/off

Turn on the ACC of the vehicle to on or start the engine, this machine will be automatically powered on and started. Starting picture appears on the monitor. A few seconds later, the following prompting box appears:



Press **(AGREE)** button to access to the screen last time turning off, turn OFF ACC (turn off engine) to shut down power, the machine will auto save current page—to which would be auto accessed when next time booting.

#### Warning:

For safety reason, the machine is designed for not being able to conduct complicated operations like destination setup while driving. Please pull over the vehicle at a safe place, take stopping brake, and conduct operation. Driver shouldn't conduct such operation while driving.

#### 2. Installation steps

- Check if the installation accessories are complete.
- Please dismantle the original Hi-Fi.
- Fasten the positioning bolt and positioning rubber cap onto the mainframe of the navigation system. (Some machines models are not equipped with positioning bolt and positioning rubber cap, so it's no need to install).
- Use the accessory special converting

## Before using the system

---

cable to quickly install as per the system connection diagram in the guideline.

Connect the original Hi-Fi cable, peripheral auxiliary devices and mainframe, connect automobile ACC key switch, turn on machine power to have a trial run. If the machine can't be turned on, please firstly check out the wiring, until the solution is found. If the machine can normally work, shut down ACC and turn off the vehicle.

- Install the correctly wired mainframe into the original Hi-Fi position, and make sure the installation stable.

### 3. Special notice

- Be careful of not damaging automobile wiring.
- To ensure normal playback of CD/DVD, the horizontal angle of installation should be less than 20°
- To avoid short circuit when wiring, it's advised to dismantle the negative end of the battery before installation.

- To prevent from accidental damage, please DO NOT plug the parts when power is on.
- Please verify the vehicle model is matching with one of the standard models in the vehicle conversion line of the navigation system.
- Please check out the connection of auto wiring with Hi-Fi cable in navigation system.
- Before power on, please confirm all parts of the system are correctly connected. Please verify the standard (+) pole (yellow) and ground wire (black) in converting cable in navigation system accessories are not short circuit. Connect the power cable to other wire may damage the machine or vehicle.
- DO NOT directly connect the power cable of this product to the power cable of other electric appliances.

#### 4. Insert and take out Disc

- **Insert Disc**

Directly put part of the Disc (text facing up) into the slot, and then the device will automatically suck the whole Disc into the slot.

- **Take out the Disc**

Press (OPEN) or (  ) key, the Disc will be ejected.



#### **Caution:**

- When the Disc is unable to be ejected, press and hold (  ) key for 2 seconds, the Disc driver will auto restart after power off, and the Disc can be ejected.
- After removing disc, please packaged it in CD-ROM box for safekeeping.

# Front Panel Functions

## Front panel diagram

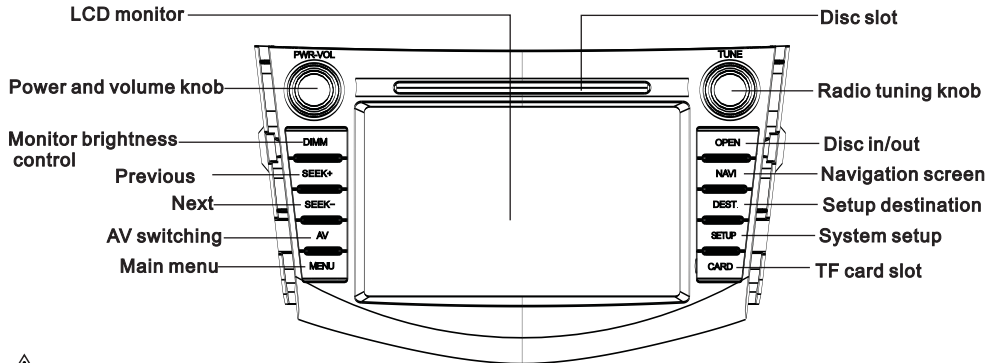

### ⚠ Caution:

- This picture is for reference only, the product is subject to material object!

### Function of front panel parts

**LCD monitor**—for touch screen control

**DIMM (Brightness control)**—for turning on screen, or making it dim, medium and bright.

**AV (Switch)**—Press it to rotate among DVD, FM1, FM2, AM, AUX and MP3.

**SEEK+ (Next)**—When playing AV, press to select next song; when listening to radio, press to select next .

**SEEK- (Previous)**—When playing AV, press to select previous song; when listening to radio, press to select previous radio channel.

**MENU (Main Menu)**—Press it to switch to main menu at any time.

**Power and volume knob**—Adjust the output volume

- Turn it clockwise to increase volume, turn it counter-clockwise to decrease volume.
- Press the knob to turn on/off mute.
- Press and hold the knob for 2 seconds,

monitor will be in stand-by mode, touch screen to continue previous operation.

**Disc in/out slot**—insert and take out Disc

**OPEN (Disc in/out control)**—to eject Disc, if without Disc, press it, the monitor will display “insert Disc” prompt.

**NAVI (Navigation screen)**—short cut to access to GPS navigation screen.

**DEST. (Destination)**— Access to destination setup.

**SETUP (System setup)**— Alter system relevant setup

**Radio turning knob**

- When listening to radio, turn the knob to select channel.
- Press the knob to access to “tune and balance”.
- In GPS navigation screen, turn the knob to zoom in/out the map.

**TF card slot**—Insert a TF card with GPS navigation software.

## Functions and AV operation

---

### Touch screen operation

#### Main menu

At the first time to run this system, press **(agree)** button in Caution screen, LCD monitor displays the default DVD screen. Click to return to main menu, as following picture :

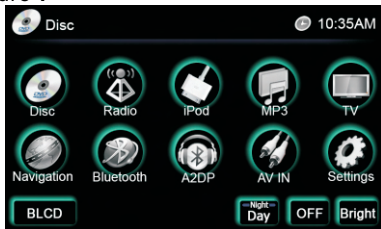

In the main menu, there are 10 functional buttons, as

**( Disc )** : Play DVD, VCD, CD and MP3.

channels.

**( iPod )** : Playing the songs or segments in iPod. (Note : with extra iPod cable to realize this function).

**( MP3 )** : Playing the song and image in USB or SD cards.

**( TV )** : Playing mobile TV.

**( Navigation )** : Access to GPS navigation system.

**( Bluetooth )** : Playing the music in mobile phone via Bluetooth module.

**( A2DP )** : Playing the music in mobile phone via Bluetooth module.

**( AV IN )** : Connect to external device.

**( Settings )** : Display and setup relevant information in the vehicle.

**( Rear LCD )** : Control rearview display output.



**(Day/Night)** : Press (Day/Night) button to switch to night mode, button indicator will be on, screen is dark. Press(Day/night mode) again to switch to day mode.

**(Off)(Dark)(Soft)(Bright)** : Between day mode and non-day mode, user may choose 1 out of 4 display modes as needed.

**⚠ Caution :**

● In this system, many functions are optional, and useable only when they are chosen. For detailed operation, please see optional function.

### 1. Disc Playback

**⚠ Caution:**

● For safety reason, when watching the image on monitor, please stop your vehicle and take stopping brake. For

detailed setup, see the “brake sensing” setup in later pages(P-28).

### DVD Disc playback

When the following picture appears in the monitor, the way to insert Disc: see the previous instruction of “Insert and take out Disc (P-7).



Insert Disc to auto access to playback screen. If this Disc is a DVD, you will see the following screen:

## Functions and AV operation



- ( **TITLE0** ) : Current playing program title.
- ( **TRAC001** ) : Current playing track No.
- ( **00'34"** ) : Display the playing time elapsed.
- ( **FOLDER** ) : Folder of current playing program.
- ( **FILE** ) : Name of current playing program file.
- ( **◀◀** ) : Fast backward.
- ( **◀◀** ) : Press it to play last song or track.
- ( **▶▶** ) : When Disc is in, press it to start playback; in playing mode, press it to.

stop playback; in playback mode, press it to pause. When it's in pause or stop mode, press it to resume normal playback.

- ( **■** ) : Press it to stop playing Disc.
- ( **▶▶** ) : Fast forward.
- ( **▶▶** ) : Press it to play next song or track.
- ( **TRACK LIST** ) : Press it to access to another screen displaying all tracks or songs in the Disc.
- ( **FOLDER** ) : Press it to access to select folder.
- ( **MUTE** ) : Press it to play Disc in mute mode.
- ( **4/3** ) : Display 4:3 video.
- ( **16:9** ) : Display 16:9 wide screen video.
- ( **Full Screen** ) : Press it to show full screen video.
- ( **Video** ) : Press it to access to video

operation and menu screen, as following picture :

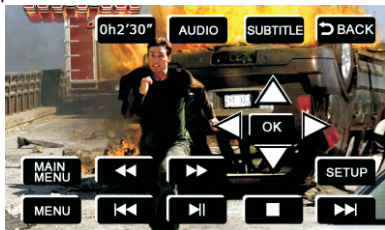

( **0h2'30"** ) : Display elapsed playback time.

( **AUDIO** ) : When using Disc recorded with multiple sound tracks format, press it when playing to switch to sound tracks in different formats (multiple format) .

( **SUBTITLE** ) : When using Disc recorded with multiple subtitles, press

it when playing to switch to different subtitles (multiple subtitles).

( **SETUP** ) : Adjust video color, contrast, chroma and brightness, as following picture:



( - ) or ( + ) : Increase or decrease, adjust to appropriate visual effect.

( **MENU** ) : This is first level menu. If it's playing, press it to pause and access to Disc main menu.

## Functions and AV operation

**( MAIN MENU )** : This is second level menu.  
If it's playing, press it to pause, and access to track selection screen. The screen list all tracks or songs in the Disc, you may choose any track to play as you like.

( ⏪ ) ( ⏩ ) ( ■ ) ( ⏸ ) ( ⏪ ) ( ⏩ ) ( ⏪ )  
Button functions and operations are completely the same as those in Disc screen.

( ⏪ ) ( ⏩ ) ( ■ ) ( ⏸ ) ( ⏪ ) ( ⏩ ) ( ⏪ )



: Use this 4-direction button to select your track from all directions, and press (OK) key to play the track selected.

### Playing CD or MP3 Disc

When VCD Disc is inserted, following picture appears:

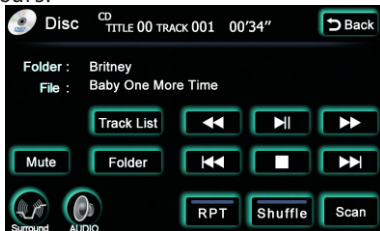

Part of function and text are similar as those in DVD function screen.

**( RPT )** : Press it to rotate playback mode.

**( Shuffle )** : Press it to start random playback.

**( Scan )** : Press it to scan program.

**( TRACKLIST )** : Access to another screen displaying all track or songs in the Disc, as following

picture:



**⚠ Caution :**

- Touch the button on screen to select relevant track or song for playback. The selected button will be highlighted, with serial No. and time displayed on top of the screen.

( **FOLDER** ) : Press it to show files list, as follows:

Program navigation : Touch (**Prev**) and (**Next**) on touch screen

to navigate files list or folders list.

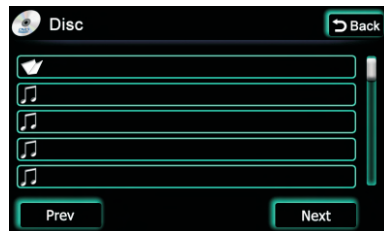

### Sound Effect Setup

Click ( **SURROUND** ) to set up sound effect, as follows :

## Functions and AV operation



The item selected will be highlighted.

- ( Pop )** : Pop music requires an average combination of vocal and instruments, so the curve is not seriously fluctuated.
- ( Jazz )** : Jazz music requires to elevates the music within 3-5 kHz improving live sense.
- ( Rock )** : Rock music requires great elevation at both ends. Bass delivers strong power and rhythm;

treble delivers clear or even harsh sound.

**(Classic)** : Classic also requires elevation of both ends, mainly highlighting the performance of instruments.

**(Turn Off Surround)** : Close all sound effects.

### Tune and balance

To a large extent, the quality of sound effect is subject to the mixed level of treble and bass. Actually, different music and vocal would be better under different sound levels. It's very important to keep optimal balance of right and left channels, as well as front and rear sound levels. Taking it into account, this product provides with AUDIO button in the pages of Disc, Radio, iPod, MP3 and Bluetooth music, press this button to set up treble and bass, as well as sound balance between front and rear, left and right, as following picture :

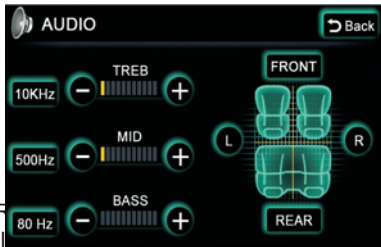

"TRE" e.  
"MI" le.

"BASS" ( + ) or ( - ) : Add or reduce bass.

( 10KHz ) : Intensify treble, switch treble frequency.

( 500Hz ) : Intensify alto, switch alto frequency.

( 80Hz ) : Intensify bass, switch bass frequency.

( FRONT ) or ( REAR ) : Adjust sound balance

between front and rear speakers.

( L ) or ( R ) : Adjust the sound balance between left and right speakers. Press ( L ) or ( R ), ( FRONT ) or ( REAR ) once, yellow bar will move to corresponding direction by 1 unit.

( ↩ Back ) : Press this button to return to operation screen of upper level.

### ⚠ Caution :

- When listening to stereo CD or radio, change left/right balance, the volume of a group of sound will increase, while that of the other group will decrease.

## Functions and AV operation

### 2.Listen to radio

#### Receive radio signal

AV sound source is switched to radio.

Press AV key to switch to radio, or select radio on main menu to access to radio page, receiving the radio signal last time received.

#### ⚠ Caution :

- Auto preset radio stations are listed.
- In tunnel, behind mountain, between mansions, where radio wave would easily interrupted, or where radio wave is weak, signal received is also weak. Even though with the list, sometimes signal couldn't be received according to current location and condition of radio wave.



**(190.60MHz)** : Frequency of radio currently playing.

**(FM1)&(FM2)** : Press it to select FM radio station.

**(AM)** : Press it to select AM radio station.

Press corresponding button to switch one mode to another.

There are 1 to 6 storage units for reserving radio channel under each mode. Touch the radio frequency stored in the unit to listen to this channel.



**(List)** : Click it to access to radio navigation and storage operation screen, as follows:



**(Favorite)** : Click to select the radio channel found, and click (Favorite) to store the selected radio channel. If you'd like to delete one stored radio channel, please click the selected radio channel, and click **(Favorite)** button to delete it.

**(Clear)**: Delete all channels stored .

**(SCAN)** : Auto scan radio frequency.

**Caution :**

●When battery is disconnected or fuse is burn, the preset channels will be deleted.

**Search radio frequency :**

**Preset channel :** Directly click on the radio channels stored in the list.

**Manual :** 1、 Touch ( ▼ ) 、 ( ▲ ) Button to select the channels needed.  
2、 Turn “radio tuning” knob on the panel to select the channel needed.