



FCC RADIO TEST REPORT

FCC ID: 2AAOI75342

Product : SUBARU 13 Forester

Trade Name : *FlyAudio* 飞歌

Model Name : 75342

Serial Model : N/A

Report No. : NTEK-2013NT0728721F

Prepared for

FLYAUDIO CORPORATION(CHINA)

FlyAudio Industrial Park No.16 Mingzhu Road,Economical & Technology
Development Zone,Guangzhou,Guangdong,china

Prepared by

NTEK Testing Technology Co., Ltd.

1/F, Building E, Fenda Science Park, Sanwei Community,Xixiang Street
Bao'an District, Shenzhen P.R. China

Tel.: +86-0755-61156588 Fax.: +86-0755-61156599

Website:www.ntek.org.cn

TEST RESULT CERTIFICATION

Applicant's name : FLYAUDIO CORPORATION(CHINA)
Address : FlyAudio Industrial Park No.16 Mingzhu Road,Economical & Technology Development Zone,Guangzhou,Guangdong,china
Manufacturer's Name..... : GUANGDONG CREATOR&FlyAudio ELECTRONIC Ltd
Address : Hengli Town, Dongguan Dongxing Industrial Zone Tianyu Technology Park Philco

Product description

Product name : SUBARU 13 Forester
Model and/or type reference : 75342
Serial Model : N/A

Standards : FCC Part15.247

Test procedure..... ANSI C63.4-2003

This device described above has been tested by NTEK, and the test results show that the equipment under test (EUT) is in compliance with the FCC requirements. And it is applicable only to the tested sample identified in the report.

This report shall not be reproduced except in full, without the written approval of NTEK, this document may be altered or revised by NTEK, personal only, and shall be noted in the revision of the document.

Date of Test :
Date (s) of performance of tests : 10 Jul. 2013 ~21 Jul. 2013
Date of Issue..... : 21 Jul. 2013
Test Result..... : **Pass**

Testing Engineer : Apple Huang
(Apple Huang)

Technical Manager : Tom Zhang
(Tom Zhang)

Authorized Signatory : Bovey Yang
(Bovey Yang)

Table of Contents

	Page
1 . SUMMARY OF TEST RESULTS	5
1.1 TEST FACILITY	6
1.2 MEASUREMENT UNCERTAINTY	6
2 . GENERAL INFORMATION	7
2.1 GENERAL DESCRIPTION OF EUT	7
2.2 DESCRIPTION OF TEST MODES	9
2.3 TABLE OF PARAMETERS OF TEXT SOFTWARE SETTING	9
2.4 BLOCK DIGRAM SHOWING THE CONFIGURATION OF SYSTEM TESTED	10
2.5 DESCRIPTION OF SUPPORT UNITS(CONDUCTED MODE)	11
2.6 EQUIPMENTS LIST FOR ALL TEST ITEMS	12
3 . EMC EMISSION TEST	13
3.1 CONDUCTED EMISSION MEASUREMENT	13
3.1.1 POWER LINE CONDUCTED EMISSION LIMITS	13
3.1.2 TEST PROCEDURE	14
3.1.3 DEVIATION FROM TEST STANDARD	14
3.1.4 TEST SETUP	14
3.1.5 EUT OPERATING CONDITIONS	14
3.1.6 TEST RESULTS	15
3.2 RADIATED EMISSION MEASUREMENT	16
3.2.1 RADIATED EMISSION LIMITS	16
3.2.2 TEST PROCEDURE	17
3.2.3 DEVIATION FROM TEST STANDARD	17
3.2.4 TEST SETUP	18
3.2.5 EUT OPERATING CONDITIONS	19
3.2.6 TEST RESULTS (BELOW 30 MHZ)	20
3.2.7 TEST RESULTS (BETWEEN 30M – 1000 MHZ)	21
3.2.8 TEST RESULTS (ABOVE 1000 MHZ)	23
3.2.9 TEST RESULTS (RESTRICTED BANDS REQUIREMENTS)	41
4 . NUMBER OF HOPPING CHANNEL	53
4.1 APPLIED PROCEDURES / LIMIT	53
4.1.1 TEST PROCEDURE	53
4.1.2 DEVIATION FROM STANDARD	53
4.1.3 TEST SETUP	53
4.1.4 EUT OPERATION CONDITIONS	53
4.1.5 TEST RESULTS	54
5 . AVERAGE TIME OF OCCUPANCY	55

Table of Contents

	Page
5.1 APPLIED PROCEDURES / LIMIT	55
5.1.1 TEST PROCEDURE	55
5.1.2 DEVIATION FROM STANDARD	55
5.1.3 TEST SETUP	56
5.1.4 EUT OPERATION CONDITIONS	56
5.1.5 TEST RESULTS	57
6 . HOPPING CHANNEL SEPARATION MEASUREMENT	59
6.1 APPLIED PROCEDURES / LIMIT	59
6.1.1 TEST PROCEDURE	59
6.1.2 DEVIATION FROM STANDARD	59
6.1.3 TEST SETUP	59
6.1.4 EUT OPERATION CONDITIONS	59
6.1.5 TEST RESULTS	60
7 . BANDWIDTH TEST	66
7.1 APPLIED PROCEDURES / LIMIT	66
7.1.1 TEST PROCEDURE	66
7.1.2 DEVIATION FROM STANDARD	66
7.1.3 TEST SETUP	66
7.1.4 EUT OPERATION CONDITIONS	66
7.1.5 TEST RESULTS	67
8 . PEAK OUTPUT POWER TEST	73
8.1 APPLIED PROCEDURES / LIMIT	73
8.1.1 TEST PROCEDURE	73
8.1.2 DEVIATION FROM STANDARD	73
8.1.3 TEST SETUP	73
8.1.4 EUT OPERATION CONDITIONS	73
8.1.5 TEST RESULTS	74
9 . ANTENNA REQUIREMENT	80
9.1 STANDARD REQUIREMENT	80
9.2 EUT ANTENNA	80
10 . EUT TEST PHOTO	81
APPENDIX-PHOTOGRAPHS OF EUT CONSTRUCTIONAL DETAILS	

1. SUMMARY OF TEST RESULTS

Test procedures according to the technical standards:

FCC Part15 (15.247) , Subpart C			
Standard Section	Test Item	Judgment	Remark
15.207	Conducted Emission	PASS	
15.247(a)(1)	Hopping Channel Separation	PASS	
15.247(b)(1)	Peak Output Power	PASS	
15.247(c)	Radiated Spurious Emission	PASS	
15.247(a)(iii)	Number of Hopping Frequency	PASS	
15.247(a)(iii)	Dwell Time	PASS	
15.247(a)(1)	Bandwidth	PASS	
15.205	Band Edge Emission	PASS	
15.203	Antenna Requirement	PASS	

NOTE:

(1) "N/A" denotes test is not applicable in this Test Report

1.1 TEST FACILITY

NTEK Testing Technology Co., Ltd
 Add. : 1/F, Building E, Fenda Science Park, Sanwei Community, Xixiang Street, Bao'an District, Shenzhen P.R. China.
 FCC Registration No.:238937; IC Registration No.:9270A-1
 CNAS Registration No.:L5516

1.2 MEASUREMENT UNCERTAINTY

The reported uncertainty of measurement $y \pm U$, where expanded uncertainty U is based on a standard uncertainty multiplied by a coverage factor of $k=2$, providing a level of confidence of approximately 95%.

No.	Item	Uncertainty
1	Conducted Emission Test	$\pm 1.38\text{dB}$
2	RF power,conducted	$\pm 0.16\text{dB}$
3	Spurious emissions,conducted	$\pm 0.21\text{dB}$
4	All emissions,radiated(<1G)	$\pm 4.68\text{dB}$
5	All emissions,radiated(>1G)	$\pm 4.89\text{dB}$
6	Temperature	$\pm 0.5^\circ\text{C}$
7	Humidity	$\pm 2\%$

2. GENERAL INFORMATION

2.1 GENERAL DESCRIPTION OF EUT

Equipment	SUBARU 13 Forester	
Trade Name	FlyAudio 飞歌	
Model Name	75342	
Serial Model	N/A	
Model Difference	N/A	
Product Description	The EUT is a SUBARU 13 Forester	
	Operation Frequency:	2402~2480 MHz
	Modulation Type:	BT(1Mbps): GFSK BT EDR(2Mbps): $\pi/4$ -DQPSK BT EDR(3Mbps): 8-DPSK
	Bit Rate of Transmitter	1Mbps/2Mbps/3Mbps
	Number Of Channel	79 CH
	Antenna Designation:	Please see Note 3.
	Output Power(Conducted):	BT(1Mbps): 1.011dBm BT EDR(2Mbps): -0.135dBm BT EDR(3Mbps): -0.363dBm
	Power:	DC12V
	More details of EUT technical specification, please refer to the User's Manual.	
Channel List	Please refer to the Note 2.	
Adapter	N/A	
Battery	N/A	
Connecting I/O Port(s)	Please refer to the User's Manual	

Note:

1. For a more detailed features description, please refer to the manufacturer's specifications or the User's Manual.

2.

Channel List					
Channel	Frequency (MHz)	Channel	Frequency (MHz)	Channel	Frequency (MHz)
00	2402	27	2429	54	2456
01	2403	28	2430	55	2457
02	2404	29	2431	56	2458
03	2405	30	2432	57	2459
04	2406	31	2433	58	2460
05	2407	32	2434	59	2461
06	2408	33	2435	60	2462
07	2409	34	2436	61	2463
08	2410	35	2437	62	2464
09	2411	36	2438	63	2465
10	2412	37	2439	64	2466
11	2413	38	2440	65	2467
12	2414	39	2441	66	2468
13	2415	40	2442	67	2469
14	2416	41	2443	68	2470
15	2417	42	2444	69	2471
16	2418	43	2445	70	2472
17	2419	44	2446	71	2473
18	2420	45	2447	72	2474
19	2421	46	2448	73	2475
20	2422	47	2449	74	2476
21	2423	48	2450	75	2477
22	2424	49	2451	76	2478
23	2425	50	2452	77	2479
24	2426	51	2453	78	2480
25	2427	52	2454		
26	2428	53	2455		

3.

Table for Filed Antenna

Ant	Brand	Model Name	Antenna Type	Connector	Gain (dBi)	NOTE
1	N/A	N/A	PCB Antenna	NA	0.7	BT Antenna

2.2 DESCRIPTION OF TEST MODES

To investigate the maximum EMI emission characteristics generates from EUT, the test system was pre-scanning tested base on the consideration of following EUT operation mode or test configuration mode which possible have effect on EMI emission level. Each of these EUT operation mode(s) or test configuration mode(s) mentioned above was evaluated respectively.

Pretest Mode	Description
Mode 1	CH00
Mode 2	CH39
Mode 3	CH78
Mode 4	TX

For Conducted Emission	
Final Test Mode	Description
Mode 4	TX

For Radiated Emission	
Final Test Mode	Description
Mode 4	TX

Note:

- (1) The measurements are performed at the highest, middle, lowest available channels.
- (2) The EUT use new battery.
- (3)The data rate was set in 1Mbps for radiated emission due to the highest RF output power.

2.3 TABLE OF PARAMETERS OF TEXT SOFTWARE SETTING

During testing channel & power controlling software provided by the customer was used to control the operating channel as well as the output power level. The RF output power selection is for the setting of RF output power expected by the customer and is going to be fixed on the firmware of the final end product power parameters of FHSS

Test software Version	Test program: Broadcom		
	2402 MHz	2441 MHz	2480 MHz
Frequency			
Parameters(1Mbps)	DEF	DEF	DEF
Parameters(2Mbps)	DEF	DEF	DEF
Parameters(3Mbps)	DEF	DEF	DEF

2.4 BLOCK DIGRAM SHOWING THE CONFIGURATION OF SYSTEM TESTED

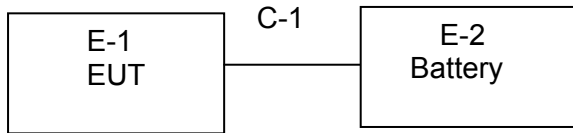

2.5 DESCRIPTION OF SUPPORT UNITS(CONDUCTED MODE)

The EUT has been tested as an independent unit together with other necessary accessories or support units. The following support units or accessories were used to form a representative test configuration during the tests.

Item	Equipment	Mfr/Brand	Model/Type No.	Series No.	Note
E-1	SUBARU 13 Forester		75342	N/A	EUT
E-2	Battery	N/A	A12	N/A	

Item	Shielded Type	Ferrite Core	Length	Note
c-1	No	No	120cm	

Note:

- (1) The support equipment was authorized by Declaration of Confirmation.
- (2) For detachable type I/O cable should be specified the length in cm in 『Length』 column.
- (3) “YES” is means “shielded” “with core”; “NO” is means “unshielded” “without core”.

2.6 EQUIPMENTS LIST FOR ALL TEST ITEMS

Radiation Test equipment

Item	Kind of Equipment	Manufacturer	Type No.	Serial No.	Last calibration	Calibrated until	Calibration period
1	Spectrum Analyzer	Agilent	E4407B	MY45108040	2013.07.06	2014.07.05	1 year
2	Test Receiver	R&S	ESPI	101318	2013.06.07	2014.06.06	1 year
3	Bilog Antenna	TESEQ	CBL6111D	31216	2013.07.06	2014.07.05	1 year
4	50Ω Coaxial Switch	Anritsu	MP59B	6200264416	2013.06.07	2014.06.06	1 year
5	Spectrum Analyzer	ADVANTEST	R3132	150900201	2013.06.07	2014.06.06	1 year
6	Horn Antenna	EM	EM-AH-10180	2011071402	2013.07.06	2014.07.05	1 year
7	Horn Ant	Schwarzbeck	BBHA 9170	9170-181	2013.07.06	2014.07.05	1 year
8	Amplifier	EM	EM-30180	060538	2013.12.22	2014.12.21	1 year
9	Loop Antenna	ARA	PLA-1030/B	1029	2013.06.08	2014.06.07	1 year
10	Power Meter	R&S	NRVS	100696	2013.07.06	2014.07.05	1 year
11	Power Sensor	R&S	URV5-Z4	0395.1619.05	2013.07.06	2014.07.05	1 year

Conduction Test equipment

Item	Kind of Equipment	Manufacturer	Type No.	Serial No.	Last calibration	Calibrated until	Calibration period
1	Test Receiver	R&S	ESCI	101160	2013.06.06	2014.06.05	1 year
2	LISN	R&S	ENV216	101313	2012.08.24	2013.08.23	1 year
3	LISN	EMCO	3816/2	00042990	2012.08.24	2013.08.23	1 year
4	50Ω Coaxial Switch	Anritsu	MP59B	6200264417	2013.06.07	2014.06.06	1 year
5	Passive Voltage Probe	R&S	ESH2-Z3	100196	2013.06.07	2014.06.06	1 year
6	Absorbing clamp	R&S	MOS-21	100423	2013.06.08	2014.06.07	1 year

3. EMC EMISSION TEST

3.1 CONDUCTED EMISSION MEASUREMENT

3.1.1 POWER LINE CONDUCTED EMISSION Limits (Frequency Range 150KHz-30MHz)

FREQUENCY (MHz)	Class A (dBuV)		Class B (dBuV)		Standard
	Quasi-peak	Average	Quasi-peak	Average	
0.15 -0.5	79.00	66.00	66 - 56 *	56 - 46 *	CISPR
0.50 -5.0	73.00	60.00	56.00	46.00	CISPR
5.0 -30.0	73.00	60.00	60.00	50.00	CISPR

0.15 -0.5	79.00	66.00	66 - 56 *	56 - 46 *	FCC
0.50 -5.0	73.00	60.00	56.00	46.00	FCC
5.0 -30.0	73.00	60.00	60.00	50.00	FCC

Note:

- (1) The tighter limit applies at the band edges.
- (2) The limit of " * " marked band means the limitation decreases linearly with the logarithm of the frequency in the range.

The following table is the setting of the receiver

Receiver Parameters	Setting
Attenuation	10 dB
Start Frequency	0.15 MHz
Stop Frequency	30 MHz
IF Bandwidth	9 kHz

3.1.2 TEST PROCEDURE

- a. The EUT was placed 0.4 meters from the horizontal ground plane with EUT being connected to the power mains through a line impedance stabilization network (LISN). All other support equipments powered from additional LISN(s). The LISN provide 50 Ohm/ 50uH of coupling impedance for the measuring instrument.
- b. Interconnecting cables that hang closer than 40 cm to the ground plane shall be folded back and forth in the center forming a bundle 30 to 40 cm long.
- c. I/O cables that are not connected to a peripheral shall be bundled in the center. The end of the cable may be terminated, if required, using the correct terminating impedance. The overall length shall not exceed 1 m.
- d. LISN at least 80 cm from nearest part of EUT chassis.
- e. For the actual test configuration, please refer to the related Item –EUT Test Photos.

3.1.3 DEVIATION FROM TEST STANDARD

No deviation

3.1.4 TEST SETUP

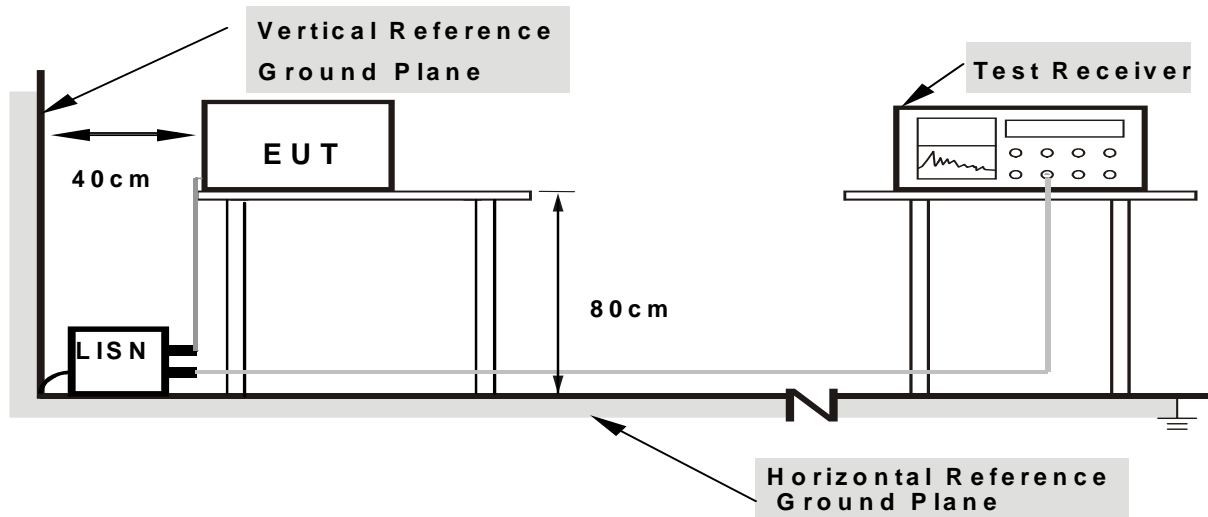

- Note:**
- 1.Support units were connected to second LISN.
 - 2.Both of LISNs (AMN) are 80 cm from EUT and at least 80 from other units and other metal planes

3.1.5 EUT OPERATING CONDITIONS

The EUT was configured for testing in a typical fashion (as a customer would normally use it). The EUT has been programmed to continuously transmit during test. This operating condition was tested and used to collect the included data.

3.1.6 TEST RESULTS

EUT :	SUBARU 13 Forester	Model Name :	75342
Temperature :	26 °C	Relative Humidity :	54%
Pressure :	1010hPa	Phase :	L
Test Voltage :	N/A	Test Mode :	Mode 1

3.2 RADIATED EMISSION MEASUREMENT

3.2.1 RADIATED EMISSION LIMITS (Frequency Range 9kHz-1000MHz)

20dBc in any 100 kHz bandwidth outside the operating frequency band. In case the emission fall within the restricted band specified on 15.205(a), then the 15.209(a) limit in the table below has to be followed.

Frequencies (MHz)	Field Strength (micorvolts/meter)	Measurement Distance (meters)
0.009~0.490	2400/F(KHz)	300
0.490~1.705	24000/F(KHz)	30
1.705~30.0	30	30
30~88	100	3
88~216	150	3
216~960	200	3
Above 960	500	3

LIMITS OF RADIATED EMISSION MEASUREMENT (Above 1000MHz)

FREQUENCY (MHz)	Class A (dBuV/m) (at 3M)		Class B (dBuV/m) (at 3M)	
	PEAK	AVERAGE	PEAK	AVERAGE
Above 1000	80	60	74	54

Notes:

- (1) The limit for radiated test was performed according to FCC PART 15C.
- (2) The tighter limit applies at the band edges.
- (3) Emission level (dBuV/m)=20log Emission level (uV/m).

FREQUENCY RANGE OF RADIATED MEASUREMENT (For unintentional radiators)

Highest frequency generated or Upper frequency of measurement used in the device or on which the device operates or tunes (MHz)	Range (MHz)
Below 1.705	30
1.705 – 108	1000
108 – 500	2000
500 – 1000	5000
Above 1000	5 th harmonic of the highest frequency or 40 GHz, whichever is lower

Spectrum Parameter	Setting
Attenuation	Auto
Start Frequency	1000 MHz
Stop Frequency	10th carrier harmonic
RB / VB (emission in restricted band)	1 MHz / 1 MHz for Peak, 1 MHz / 10Hz for Average

Receiver Parameter	Setting
Attenuation	Auto
Start ~ Stop Frequency	9kHz~150kHz / RB 200Hz for QP
Start ~ Stop Frequency	150kHz~30MHz / RB 9kHz for QP
Start ~ Stop Frequency	30MHz~1000MHz / RB 120kHz for QP

3.2.2 TEST PROCEDURE

- a. The measuring distance of at 3 m shall be used for measurements at frequency up to 1GHz. For frequencies above 1GHz, any suitable measuring distance may be used.
- b. The EUT was placed on the top of a rotating table 0.8 meters above the ground at a 3 meter open area test site. The table was rotated 360 degrees to determine the position of the highest radiation.
- c. The height of the equipment or of the substitution antenna shall be 0.8 m; the height of the test antenna shall vary between 1 m to 4 m. Both horizontal and vertical polarizations of the antenna are set to make the measurement.
- d. The initial step in collecting conducted emission data is a spectrum analyzer peak detector mode pre-scanning the measurement frequency range. Significant peaks are then marked and then Quasi Peak detector mode re-measured.
- e. If the Peak Mode measured value compliance with and lower than Quasi Peak Mode Limit, the EUT shall be deemed to meet QP Limits and then no additional QP Mode measurement performed.
- f. For the actual test configuration, please refer to the related Item –EUT Test Photos.

Note:

Both horizontal and vertical antenna polarities were tested and performed pretest to three orthogonal axis. The worst case emissions were reported

3.2.3 DEVIATION FROM TEST STANDARD

No deviation

3.2.4 TEST SETUP

(A) Radiated Emission Test-Up Frequency Below 30MHz

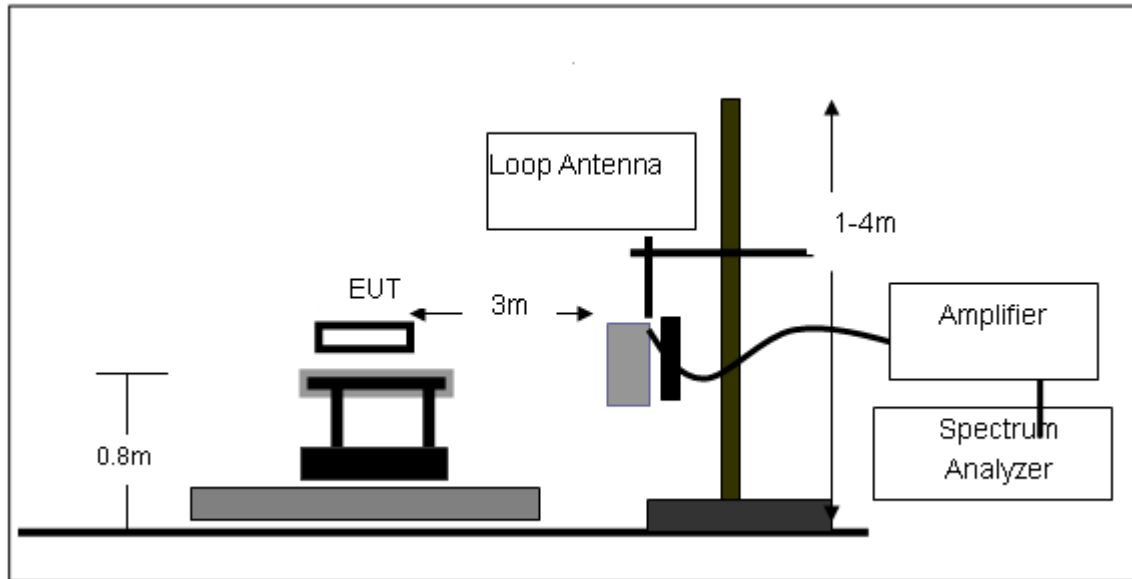

(B) Radiated Emission Test-Up Frequency 30MHz~1GHz

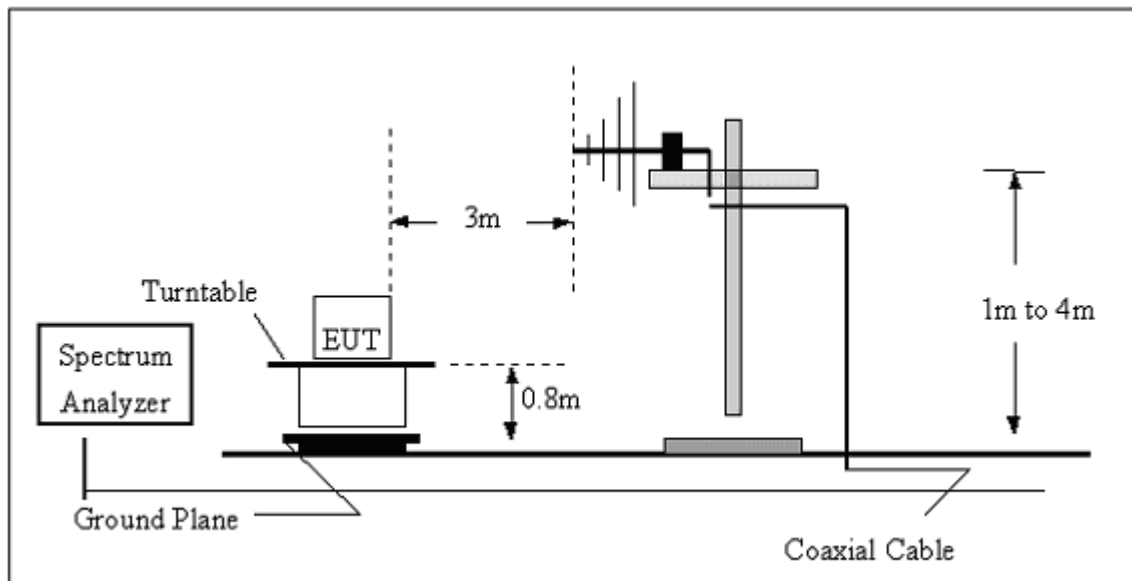

(C) Radiated Emission Test-Up Frequency Above 1GHz

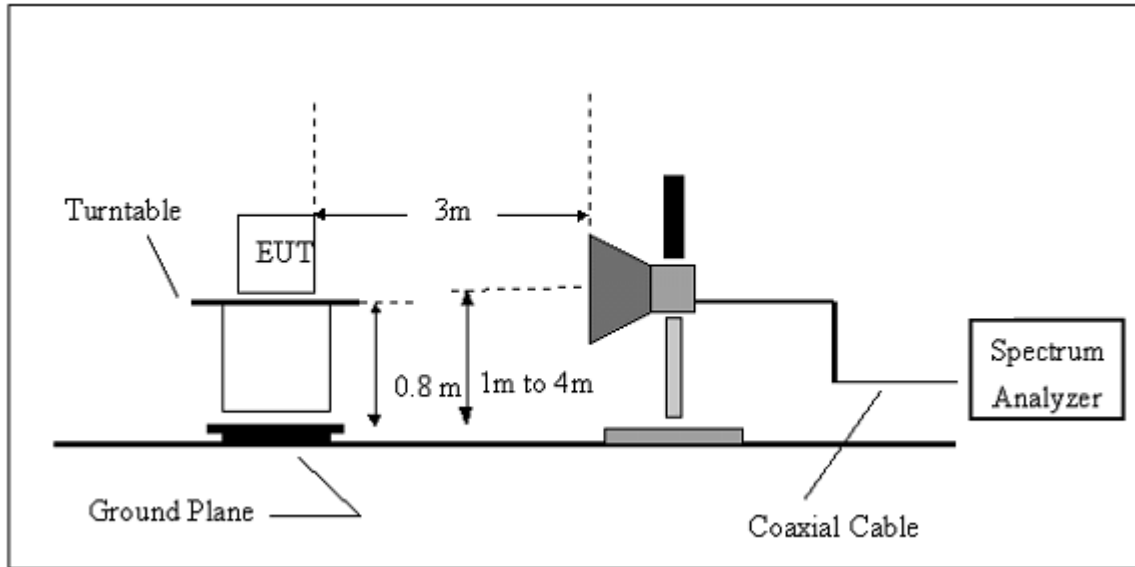

3.2.5 EUT OPERATING CONDITIONS

The EUT tested system was configured as the statements of 2.4 Unless otherwise a special operating condition is specified in the follows during the testing.

3.2.6 TEST RESULTS (BELOW 30 MHZ)

EUT :	SUBARU 13 Forester	Model Name :	75342
Temperature :	20 °C	Relative Humidity :	48%
Pressure :	1010 hPa	Polarization :	---
Test Voltage :	DC 12V		
Test Mode :	TX		

Freq.	Reading	Limit	Margin	State
(MHz)	(dBuV/m)	(dBuV/m)	(dB)	P/F
--	--	--	--	PASS
--	--	--	--	PASS

NOTE:

The amplitude of spurious emissions which are attenuated by more than 20dB below the permissible value has no need to be reported.

Distance extrapolation factor = $40 \log(\text{specific distance}/\text{test distance})$ (dB);

Limit line = specific limits(dBuv) + distance extrapolation factor.

3.2.7 TEST RESULTS (BETWEEN 30M – 1000 MHZ)

EUT :	SUBARU 13 Forester	Model Name :	75342
Temperature :	20 °C	Relative Humidity :	48%
Pressure :	1010 hPa	Polarization :	Horizontal
Test Voltage :	DC 12V		
Test Mode :	TX		

Frequency (MHz)	Meter Reading (dBμV)	Factor (dB)	Emission Level (dBμV/m)	Limits (dBμV/m)	Margin (dB)	Detector Type
31.0705	16.76	17.86	34.62	40	-5.38	QP
39.8541	20.45	13.46	33.91	40	-6.09	QP
79.8002	29.34	7.76	37.1	40	-2.9	QP
118.6013	19.65	12.05	31.7	43.5	-11.8	QP
302.4812	16.99	14.81	31.8	46	-14.2	QP
750.1082	7.71	26.39	34.1	46	-11.9	QP

Remark:
Factor = Antenna Factor + Cable Loss – Pre-amplifier.

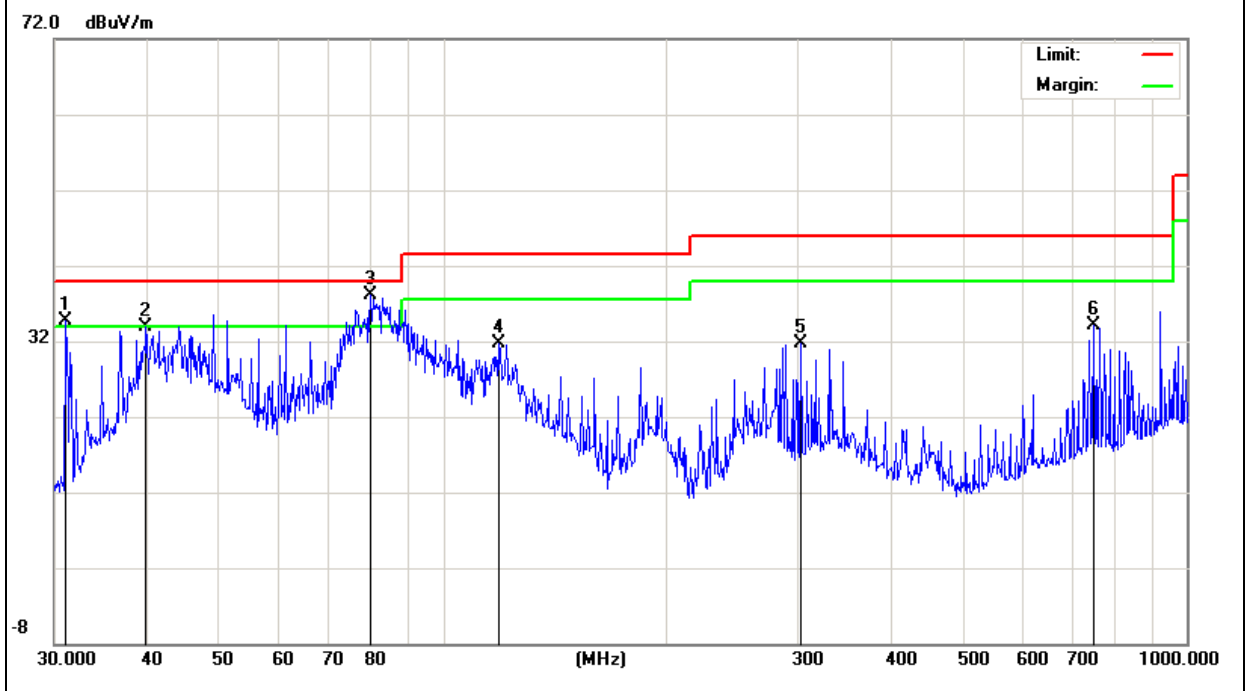

EUT :	SUBARU 13 Forester	Model Name :	75342
Temperature :	20 °C	Relative Humidity :	48%
Pressure :	1010 hPa	Polarization :	Vertical
Test Voltage :	DC 12V		
Test Mode :	TX		

Frequency (MHz)	Meter Reading (dBµV)	Factor (dB)	Emission Level (dBµV/m)	Limits (dBµV/m)	Margin (dB)	Detector Type
44.12	20.13	11.09	31.22	40	-8.78	QP
55.2207	25.86	6.21	32.07	40	-7.93	QP
85.8983	27.83	8.9	36.73	40	-3.27	QP
135.0319	25.46	12.25	37.71	43.5	-5.79	QP
209.3129	27.43	9.65	37.08	43.5	-6.42	QP
319.937	23.82	15.44	39.26	46	-6.74	QP

Remark:

Factor = Antenna Factor + Cable Loss – Pre-amplifier.

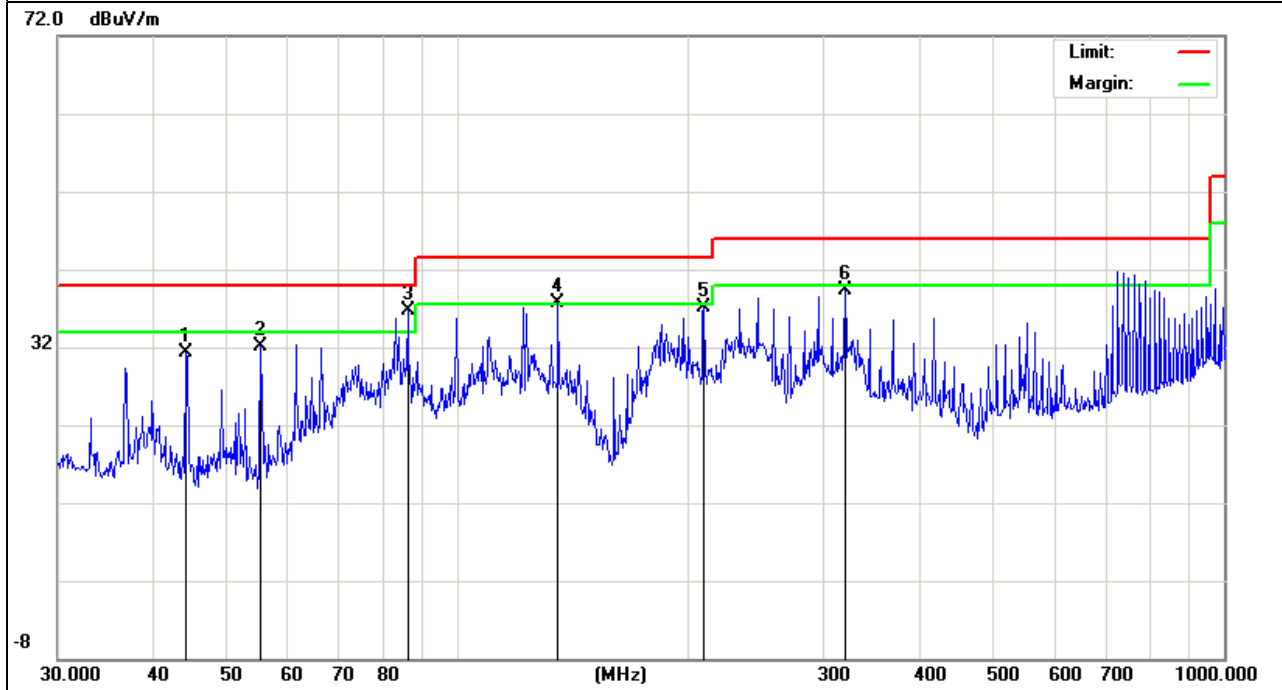

3.2.8 TEST RESULTS (ABOVE 1000 MHZ)

EUT :	SUBARU 13 Forester	Model Name :	75342
Temperature :	20 °C	Relative Humidity :	48%
Pressure :	1010 hPa	Test Voltage :	DC 12V
Test Mode :	TX 2402MHz – CH 00(1Mbps)	Polarization :	Horizontal

Frequency (MHz)	Meter Reading (dBμV)	Factor (dB)	Emission Level (dBμV/m)	Limits (dBμV/m)	Margin (dB)	Detector Type
4804.132	64.99	-3.64	61.35	74	-12.65	peak
4804.132	49.87	-3.64	46.23	54	-7.77	AVG
7206.284	56.73	-0.95	55.78	74	-18.22	peak
7206.284	45.51	-0.95	44.56	54	-9.44	AVG

Remark:
 Factor = Antenna Factor + Cable Loss – Pre-amplifier.
 No emission above 18GHz

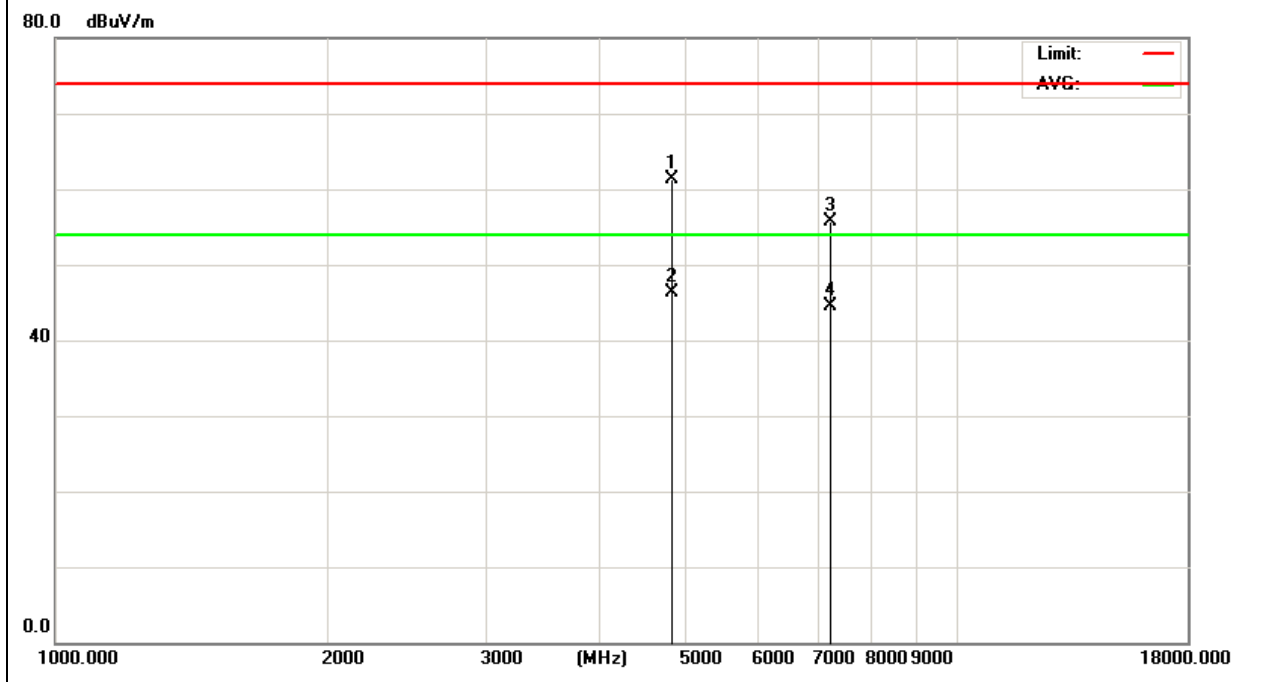

EUT :	SUBARU 13 Forester	Model Name :	75342
Temperature :	20 °C	Relative Humidity :	48%
Pressure :	1010 hPa	Test Voltage :	DC 12V
Test Mode :	TX 2402MHz – CH 00(1Mbps)	Polarization :	Vertical

Frequency (MHz)	Meter Reading (dBµV)	Factor (dB)	Emission Level (dBµV/m)	Limits (dBµV/m)	Margin (dB)	Detector Type
4804.176	63.52	-3.64	59.88	74	-14.12	peak
4804.176	49.32	-3.64	45.68	54	-8.32	AVG
7206.236	54.7	-0.95	53.75	74	-20.25	peak
7206.236	45.64	-0.95	44.69	54	-9.31	AVG

Remark:
 Factor = Antenna Factor + Cable Loss – Pre-amplifier.
 No emission above 18GHz

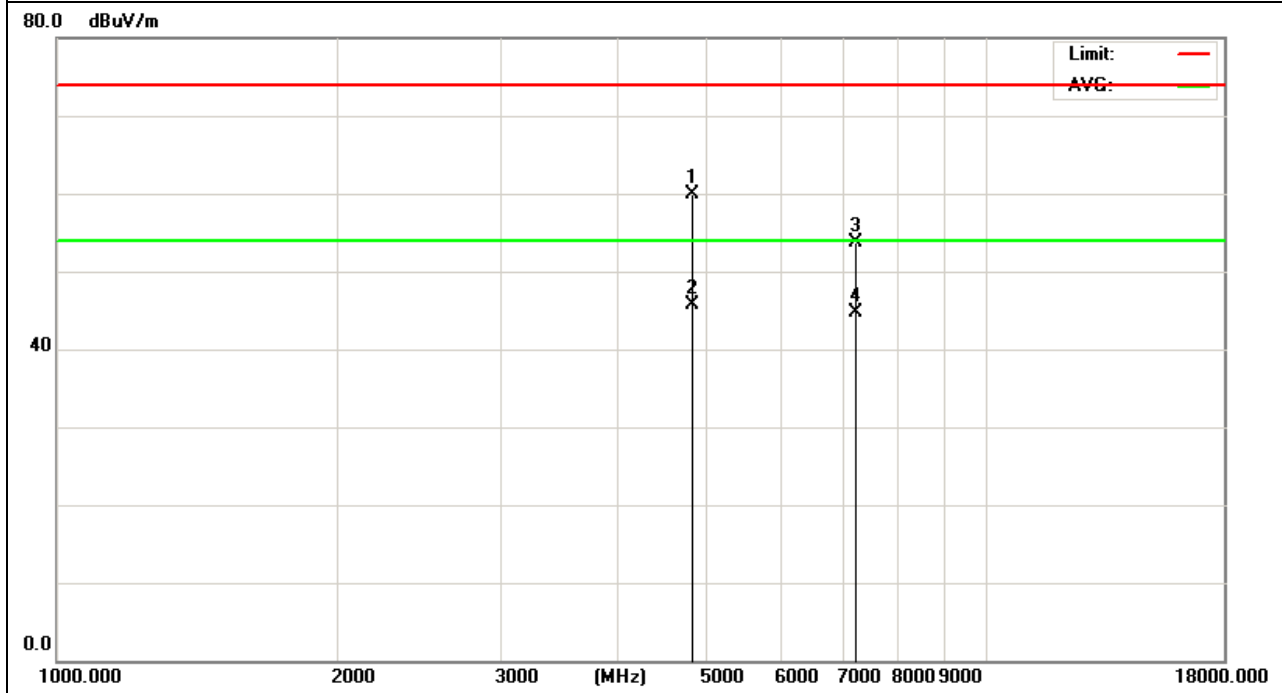

EUT :	SUBARU 13 Forester	Model Name :	75342
Temperature :	20 °C	Relative Humidity :	48%
Pressure :	1010 hPa	Test Voltage :	DC 12V
Test Mode :	TX 2441MHz – CH 39(1Mbps)	Polarization :	Vertical

Frequency (MHz)	Meter Reading (dBµV)	Factor (dB)	Emission Level (dBµV/m)	Limits (dBµV/m)	Margin (dB)	Detector Type
4882.429	68.42	-3.67	64.75	74	-9.25	peak
4882.429	48.99	-3.67	45.32	54	-8.68	AVG
7323.374	58.44	-0.82	57.62	74	-16.38	peak
7323.374	44.59	-0.82	43.77	54	-10.23	AVG

Remark:
 Factor = Antenna Factor + Cable Loss – Pre-amplifier.
 No emission above 18GHz

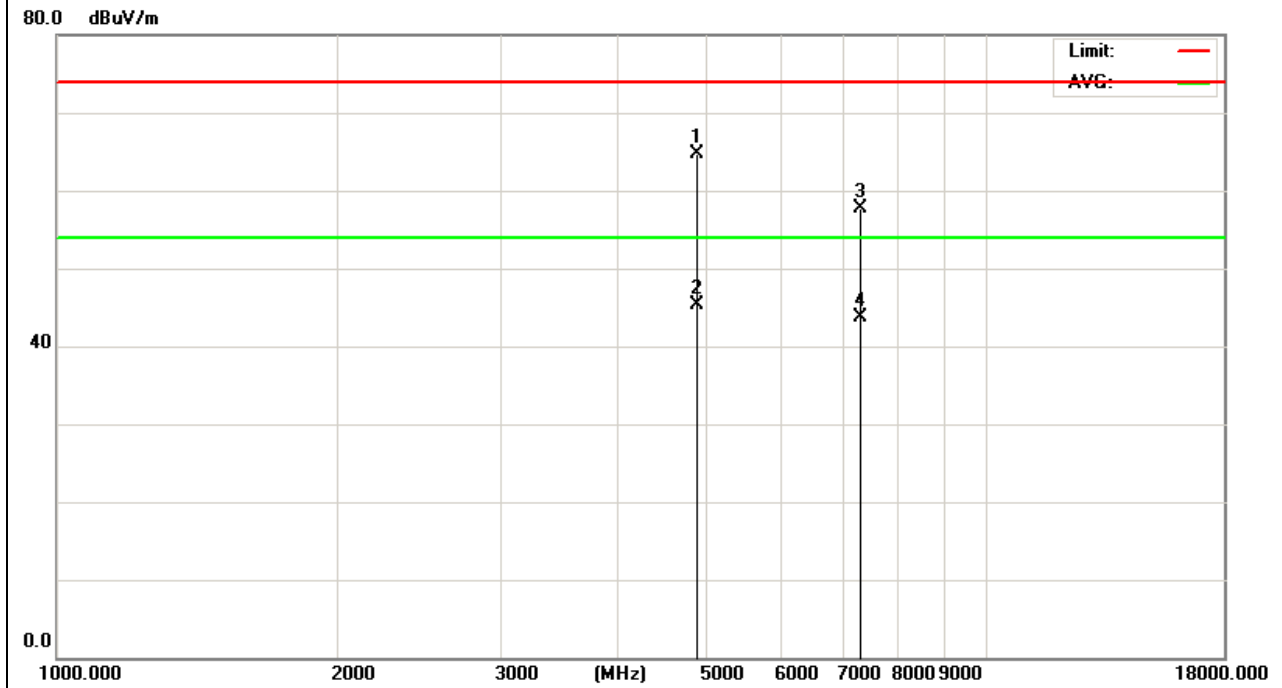

EUT :	SUBARU 13 Forester	Model Name :	75342
Temperature :	20 °C	Relative Humidity :	48%
Pressure :	1010 hPa	Test Voltage :	DC 12V
Test Mode :	TX 2441MHz – CH 39(1Mbps)	Polarization :	Horizontal

Frequency (MHz)	Meter Reading (dBμV)	Factor (dB)	Emission Level (dBμV/m)	Limits (dBμV/m)	Margin (dB)	Detector Type
4882.352	63.01	-3.67	59.34	74	-14.66	peak
4882.352	46.15	-3.67	42.48	54	-11.52	AVG
7323.233	55.31	-0.82	54.49	74	-19.51	peak
7323.233	40.95	-0.82	40.13	54	-13.87	AVG

Remark:
 Factor = Antenna Factor + Cable Loss – Pre-amplifier.
 No emission above 18GHz

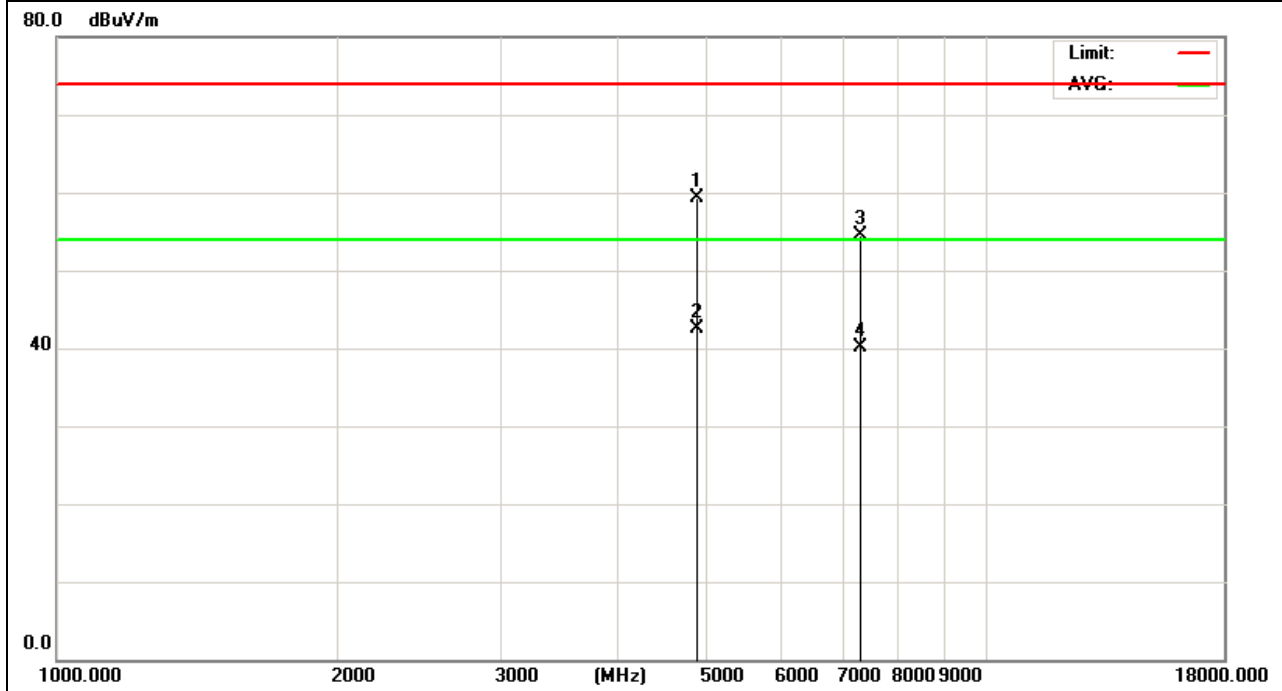

EUT :	SUBARU 13 Forester	Model Name :	75342
Temperature :	20 °C	Relative Humidity :	48%
Pressure :	1010 hPa	Test Voltage :	DC 12V
Test Mode :	TX 2480MHz – CH 78(1Mbps)	Polarization :	Horizontal

Frequency (MHz)	Meter Reading (dBμV)	Factor (dB)	Emission Level (dBμV/m)	Limits (dBμV/m)	Margin (dB)	Detector Type
4960.177	61.12	-3.59	57.53	74	-16.47	peak
4960.177	48.91	-3.59	45.32	54	-8.68	AVG
7440.486	54.03	-0.68	53.35	74	-20.65	peak
7440.486	42.93	-0.68	42.25	54	-11.75	AVG

Remark:
 Factor = Antenna Factor + Cable Loss – Pre-amplifier.
 No emission above 18GHz

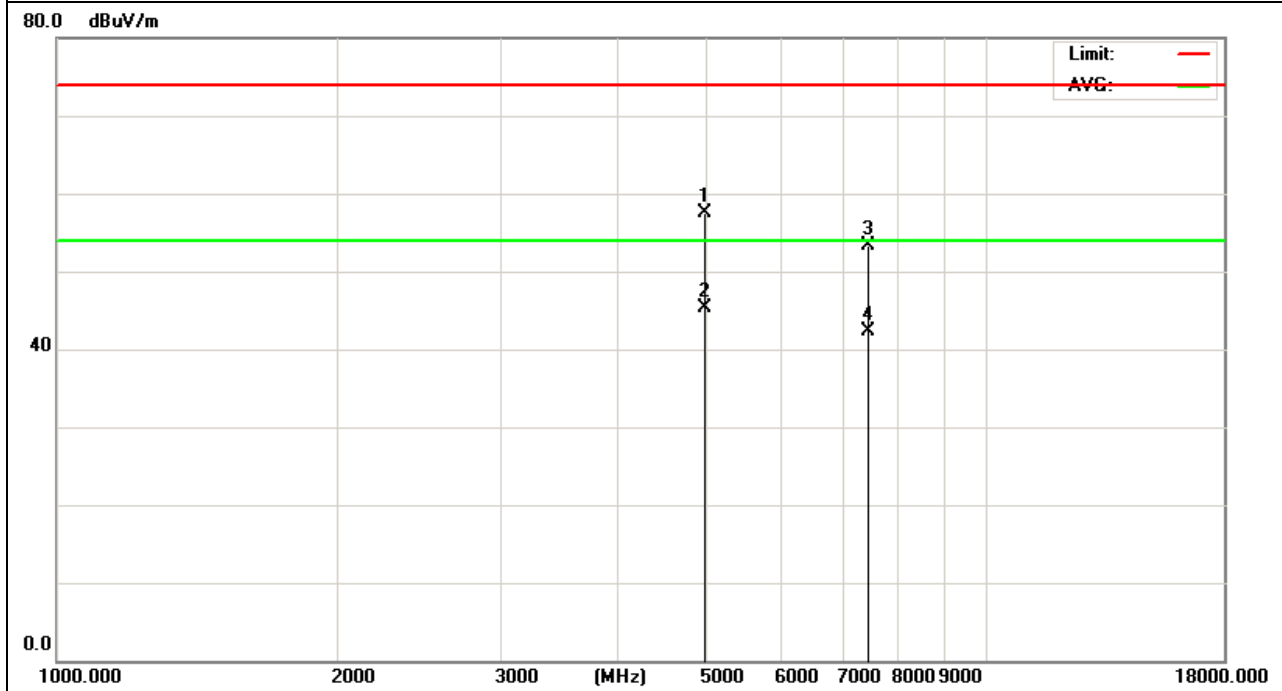

EUT :	SUBARU 13 Forester	Model Name :	75342
Temperature :	20 °C	Relative Humidity :	48%
Pressure :	1010 hPa	Test Voltage :	DC 12V
Test Mode :	TX 2480MHz – CH 78(1Mbps)	Polarization :	Vertical

Frequency (MHz)	Meter Reading (dBμV)	Factor (dB)	Emission Level (dBμV/m)	Limits (dBμV/m)	Margin (dB)	Detector Type
4960.146	62.01	-3.59	58.42	74	-15.58	peak
4960.146	47.17	-3.59	43.58	54	-10.42	AVG
7440.207	53.06	-0.68	52.38	74	-21.62	peak
7440.207	41.32	-0.68	40.64	54	-13.36	AVG

Remark:
 Factor = Antenna Factor + Cable Loss – Pre-amplifier.
 No emission above 18GHz

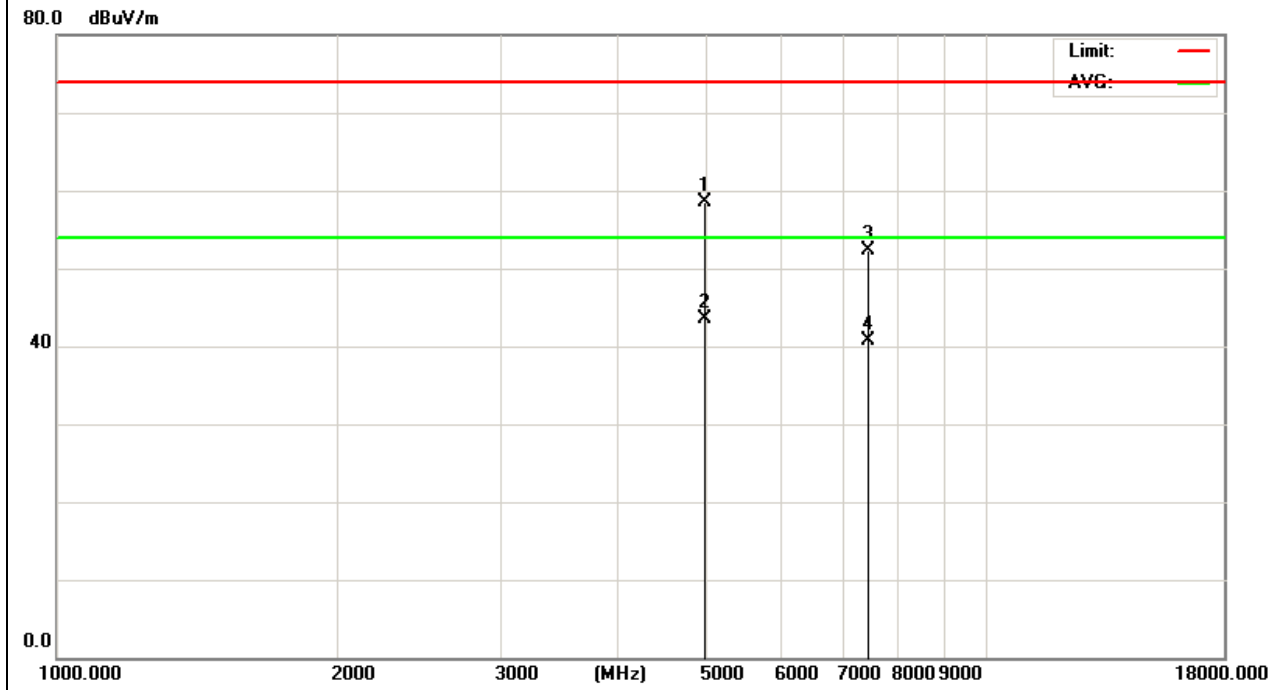

EUT :	SUBARU 13 Forester	Model Name :	75342
Temperature :	20 °C	Relative Humidity :	48%
Pressure :	1010 hPa	Test Voltage :	DC 12V
Test Mode :	TX 2402MHz – CH 00(2Mbps)	Polarization :	Horizontal

Frequency (MHz)	Meter Reading (dBµV)	Factor (dB)	Emission Level (dBµV/m)	Limits (dBµV/m)	Margin (dB)	Detector Type
4804.121	61.12	-3.64	57.48	74	-16.52	peak
4804.121	48.03	-3.64	44.39	54	-9.61	AVG
7206.379	54.4	-0.95	53.45	74	-20.55	peak
7206.379	41.08	-0.95	40.13	54	-13.87	AVG

Remark:
 Factor = Antenna Factor + Cable Loss – Pre-amplifier.
 No emission above 18GHz

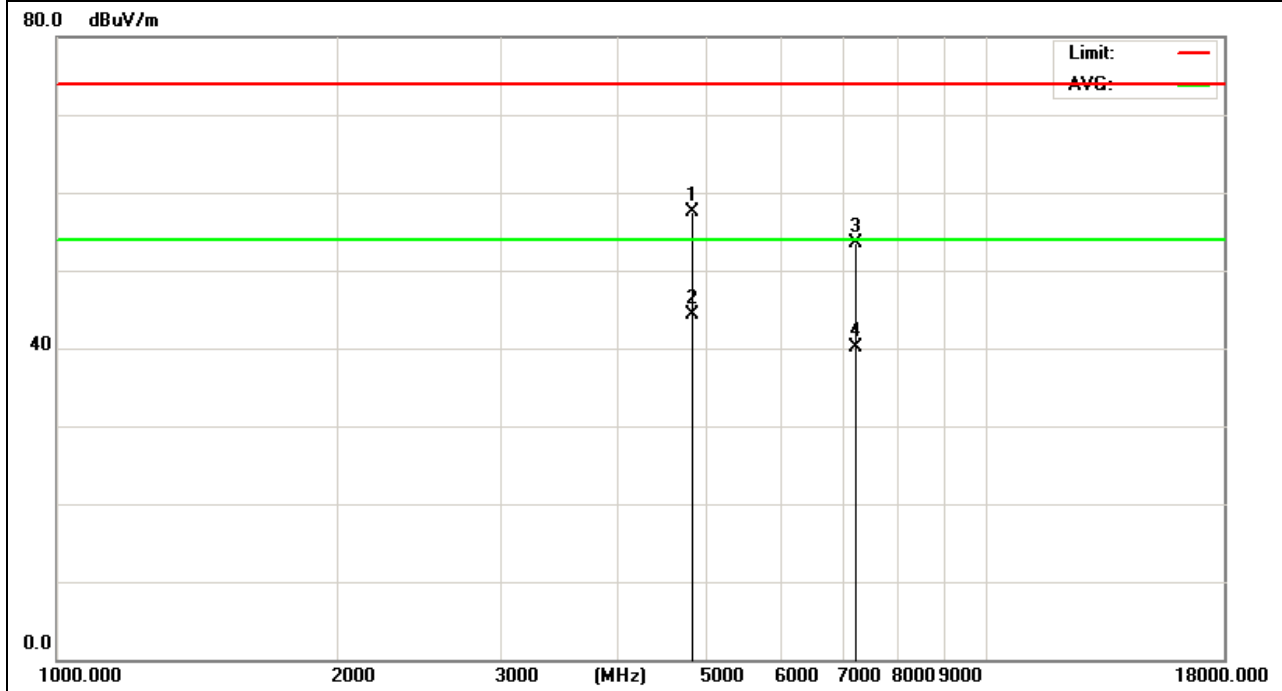

EUT :	SUBARU 13 Forester	Model Name :	75342
Temperature :	20 °C	Relative Humidity :	48%
Pressure :	1010 hPa	Test Voltage :	DC 12V
Test Mode :	TX 2402MHz – CH 00(2Mbps)	Polarization :	Vertical

Frequency (MHz)	Meter Reading (dBµV)	Factor (dB)	Emission Level (dBµV/m)	Limits (dBµV/m)	Margin (dB)	Detector Type
4804.225	59.96	-3.64	56.32	74	-17.68	peak
4804.225	48.49	-3.64	44.85	54	-9.15	AVG
7206.313	54.82	-0.95	53.87	74	-20.13	peak
7206.313	44.93	-0.95	43.98	54	-10.02	AVG

Remark:
 Factor = Antenna Factor + Cable Loss – Pre-amplifier.
 No emission above 18GHz

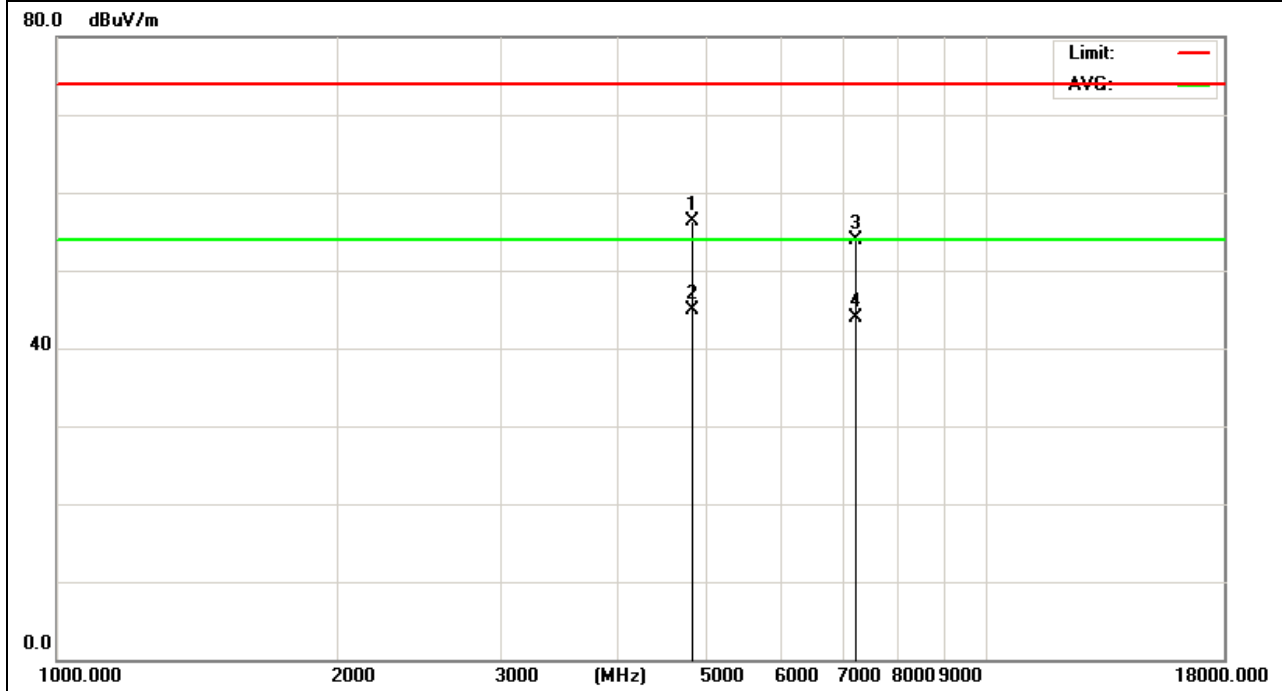

EUT :	SUBARU 13 Forester	Model Name :	75342
Temperature :	20 °C	Relative Humidity :	48%
Pressure :	1010 hPa	Test Voltage :	DC 12V
Test Mode :	TX 2441MHz – CH 39(2Mbps)	Polarization :	Horizontal

Frequency (MHz)	Meter Reading (dBµV)	Factor (dB)	Emission Level (dBµV/m)	Limits (dBµV/m)	Margin (dB)	Detector Type
4882.228	61.68	-3.67	58.01	74	-15.99	peak
4882.228	46.79	-3.67	43.12	54	-10.88	AVG
7323.42	55.11	-0.82	54.29	74	-19.71	peak
7323.42	41	-0.82	40.18	54	-13.82	AVG

Remark:
 Factor = Antenna Factor + Cable Loss – Pre-amplifier.
 No emission above 18GHz

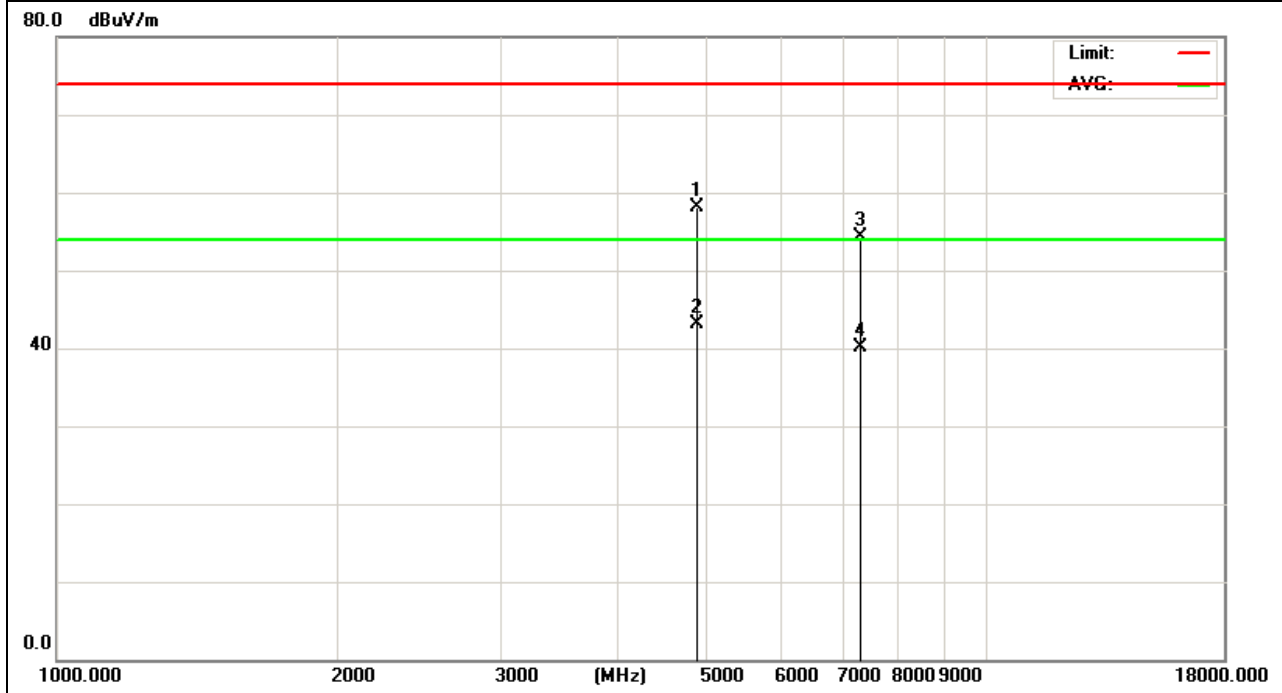

EUT :	SUBARU 13 Forester	Model Name :	75342
Temperature :	20 °C	Relative Humidity :	48%
Pressure :	1010 hPa	Test Voltage :	DC 12V
Test Mode :	TX 2441MHz – CH 39(2Mbps)	Polarization :	Vertical

Frequency (MHz)	Meter Reading (dBµV)	Factor (dB)	Emission Level (dBµV/m)	Limits (dBµV/m)	Margin (dB)	Detector Type
4882.175	63.15	-3.68	59.47	74	-14.53	peak
4882.175	46.07	-3.68	42.39	54	-11.61	AVG
7323.133	54.43	-0.82	53.61	74	-20.39	peak
7323.133	40.96	-0.82	40.14	54	-13.86	AVG

Remark:
 Factor = Antenna Factor + Cable Loss – Pre-amplifier.
 No emission above 18GHz

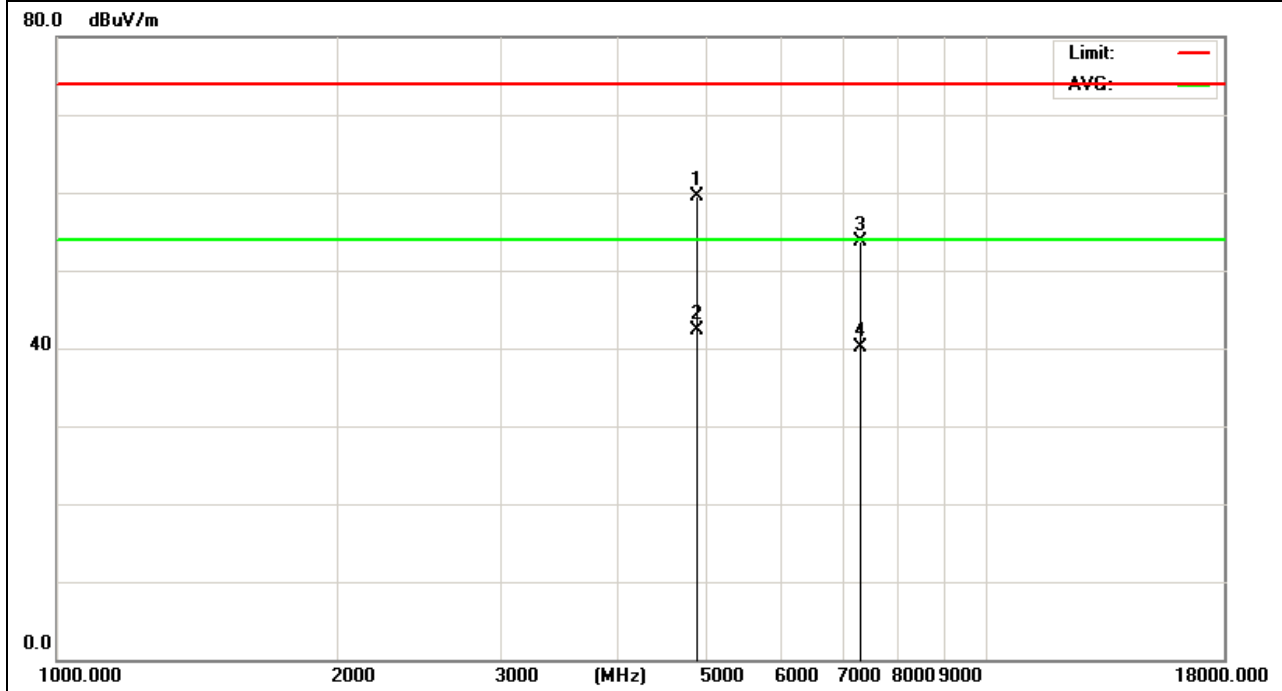

EUT :	SUBARU 13 Forester	Model Name :	75342
Temperature :	20 °C	Relative Humidity :	48%
Pressure :	1010 hPa	Test Voltage :	DC 12V
Test Mode :	TX 2480MHz – CH 80(2Mbps)	Polarization :	Horizontal

Frequency (MHz)	Meter Reading (dBµV)	Factor (dB)	Emission Level (dBµV/m)	Limits (dBµV/m)	Margin (dB)	Detector Type
4960.124	63.04	-3.59	59.45	74	-14.55	peak
4960.124	45.06	-3.59	41.47	54	-12.53	AVG
7440.367	53.24	-0.68	52.56	74	-21.44	peak
7440.367	40.76	-0.68	40.08	54	-13.92	AVG

Remark:
 Factor = Antenna Factor + Cable Loss – Pre-amplifier.
 No emission above 18GHz

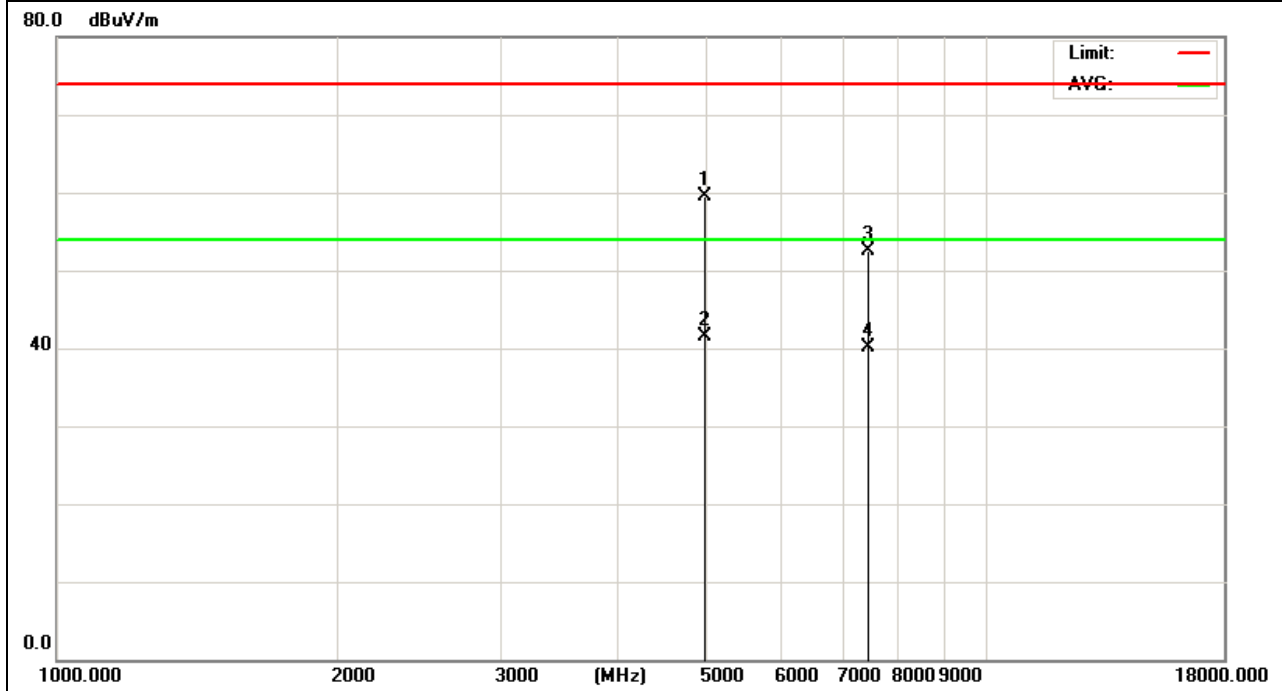

EUT :	SUBARU 13 Forester	Model Name :	75342
Temperature :	20 °C	Relative Humidity :	48%
Pressure :	1010 hPa	Test Voltage :	DC 12V
Test Mode :	TX 2480MHz – CH 78(2Mbps)	Polarization :	Vertical

Frequency (MHz)	Meter Reading (dBµV)	Factor (dB)	Emission Level (dBµV/m)	Limits (dBµV/m)	Margin (dB)	Detector Type
4960.216	61.02	-3.59	57.43	74	-16.57	peak
4960.216	45.75	-3.59	42.16	54	-11.84	AVG
7440.083	53.02	-0.69	52.33	74	-21.67	peak
7440.083	41.05	-0.69	40.36	54	-13.64	AVG

Remark:
 Factor = Antenna Factor + Cable Loss – Pre-amplifier.
 No emission above 18GHz

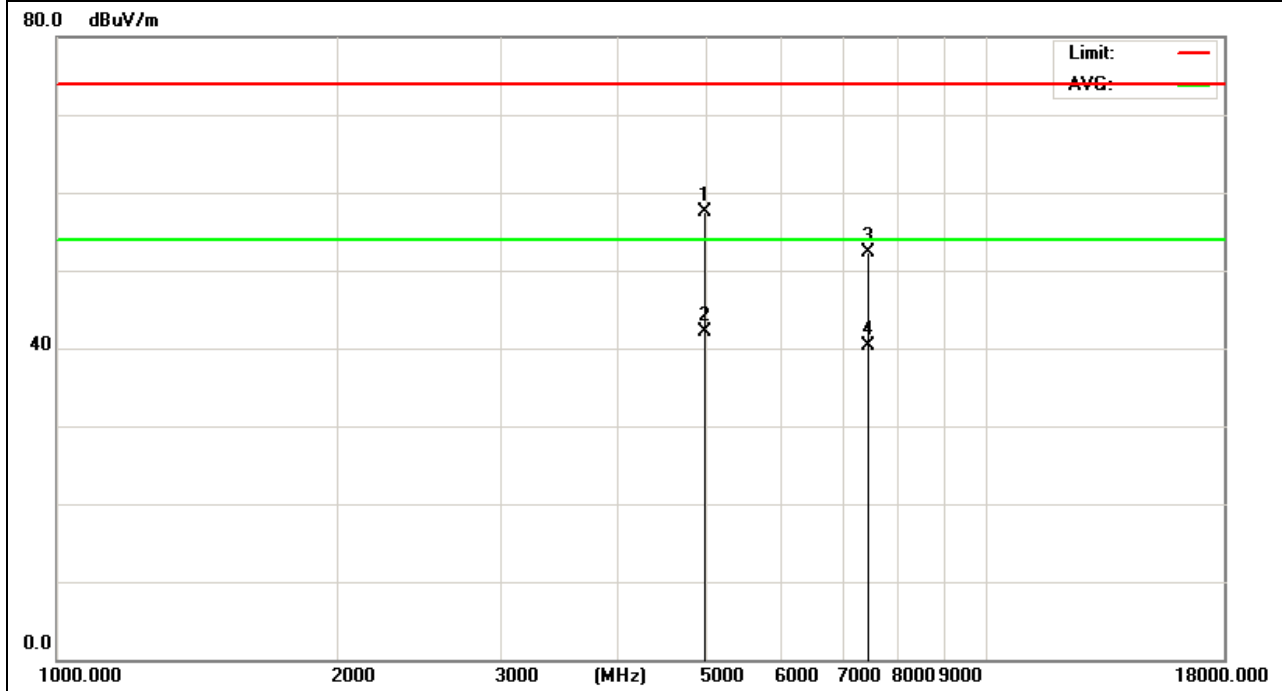

EUT :	SUBARU 13 Forester	Model Name :	75342
Temperature :	20 °C	Relative Humidity :	48%
Pressure :	1010 hPa	Test Voltage :	DC 12V
Test Mode :	TX 2402MHz – CH00 (3Mbps)	Polarization :	Horizontal

Frequency (MHz)	Meter Reading (dBµV)	Factor (dB)	Emission Level (dBµV/m)	Limits (dBµV/m)	Margin (dB)	Detector Type
4804.128	61.97	-3.64	58.33	74	-15.67	peak
4804.128	46.06	-3.64	42.42	54	-11.58	AVG
7206.232	54.63	-0.95	53.68	74	-20.32	peak
7206.232	41.37	-0.95	40.42	54	-13.58	AVG

Remark:
 Factor = Antenna Factor + Cable Loss – Pre-amplifier.
 No emission above 18GHz

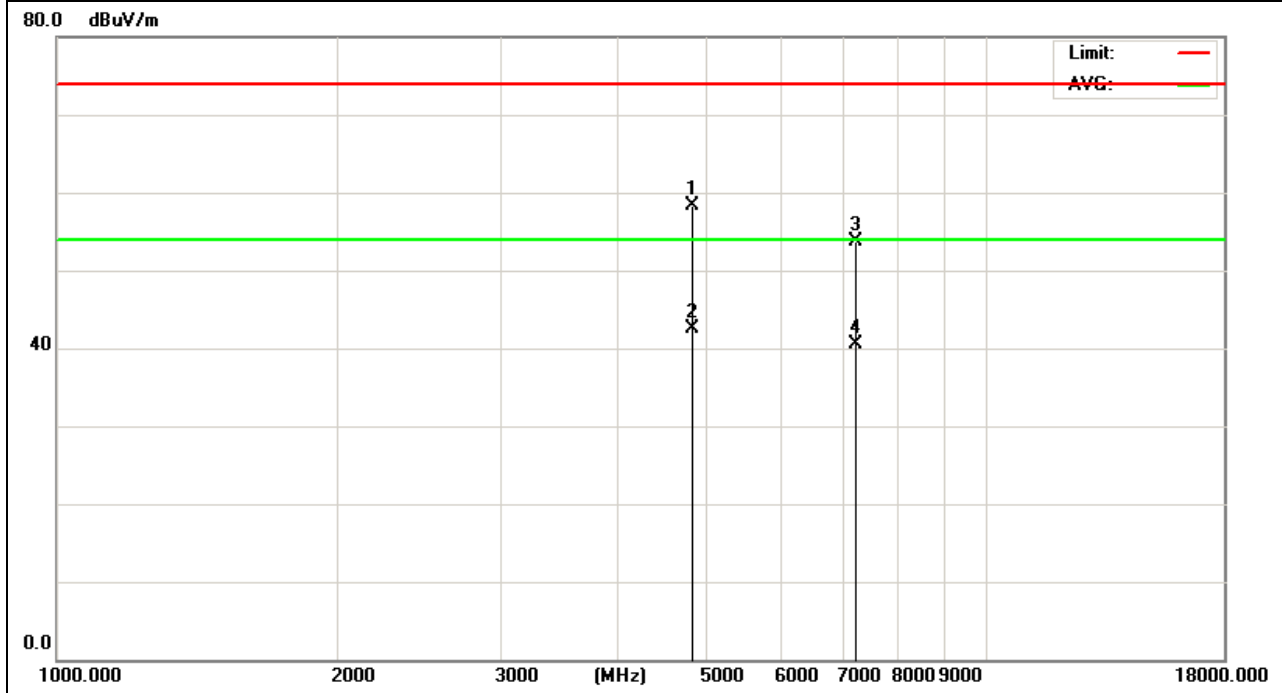

EUT :	SUBARU 13 Forester	Model Name :	75342
Temperature :	20 °C	Relative Humidity :	48%
Pressure :	1010 hPa	Test Voltage :	DC 12V
Test Mode :	TX 2402MHz – CH00 (3Mbps)	Polarization :	Vertical

Frequency (MHz)	Meter Reading (dBµV)	Factor (dB)	Emission Level (dBµV/m)	Limits (dBµV/m)	Margin (dB)	Detector Type
4804.107	63.11	-3.64	59.47	74	-14.53	peak
4804.107	47.02	-3.64	43.38	54	-10.62	AVG
7206.386	54.94	-0.95	53.99	74	-20.01	peak
7206.386	43.44	-0.95	42.49	54	-11.51	AVG

Remark:
 Factor = Antenna Factor + Cable Loss – Pre-amplifier.
 No emission above 18GHz

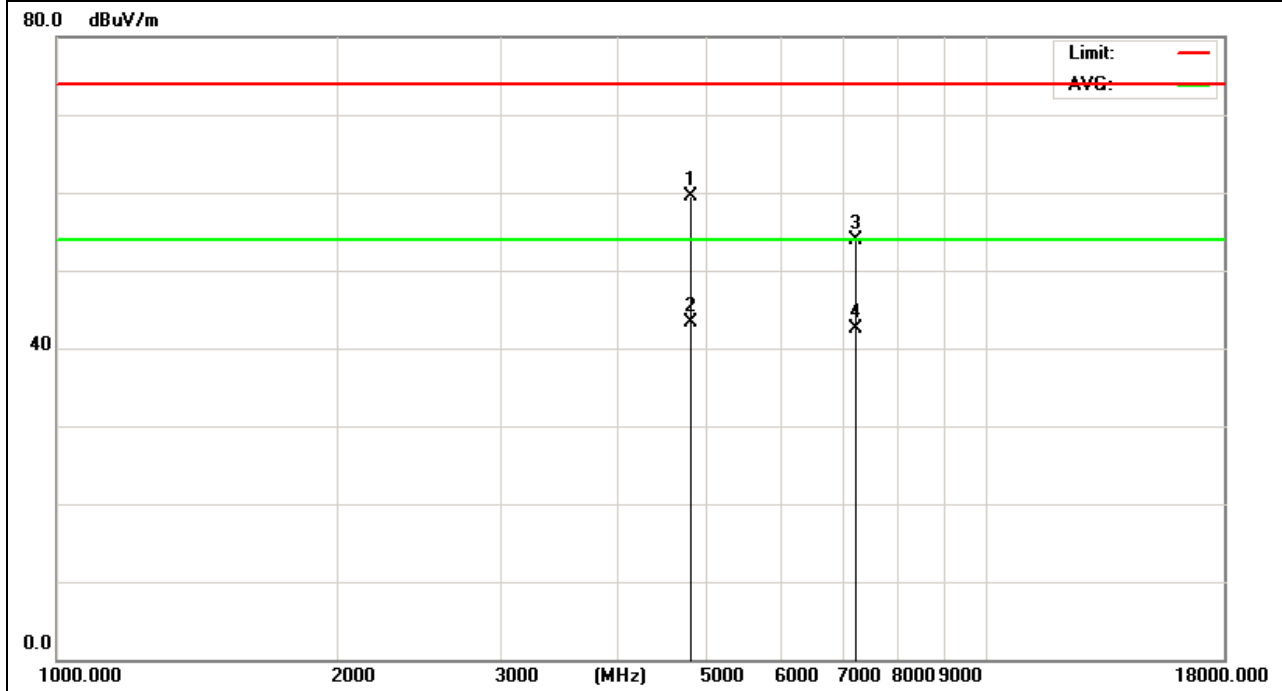

EUT :	SUBARU 13 Forester	Model Name :	75342
Temperature :	20 °C	Relative Humidity :	48%
Pressure :	1010 hPa	Test Voltage :	DC 12V
Test Mode :	TX 2441MHz – CH39(3Mbps)	Polarization :	Horizontal

Frequency (MHz)	Meter Reading (dBµV)	Factor (dB)	Emission Level (dBµV/m)	Limits (dBµV/m)	Margin (dB)	Detector Type
4882.475	62.55	-3.67	58.88	74	-15.12	peak
4882.475	46.19	-3.67	42.52	54	-11.48	AVG
7323.346	55.28	-0.82	54.46	74	-19.54	peak
7323.346	41.69	-0.82	40.87	54	-13.13	AVG

Remark:
 Factor = Antenna Factor + Cable Loss – Pre-amplifier.
 No emission above 18GHz

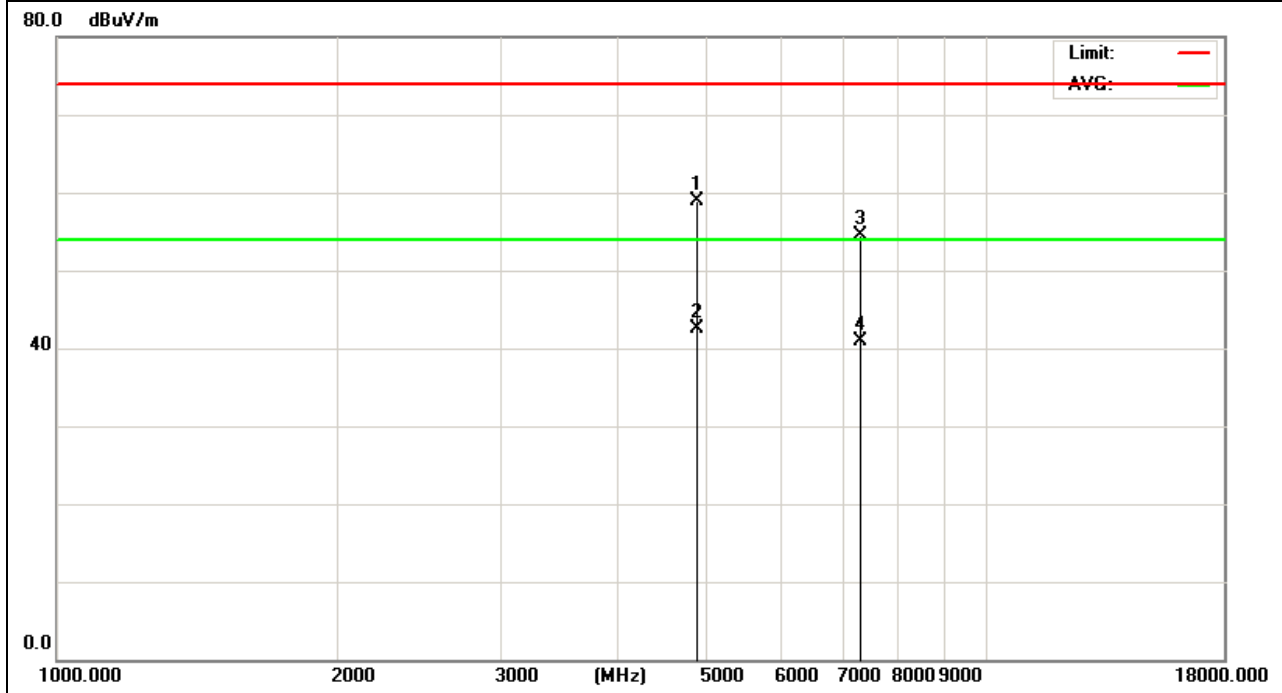

EUT :	SUBARU 13 Forester	Model Name :	75342
Temperature :	20 °C	Relative Humidity :	48%
Pressure :	1010 hPa	Test Voltage :	DC 12V
Test Mode :	TX 2441MHz – CH39 (3Mbps)	Polarization :	Vertical

Frequency (MHz)	Meter Reading (dBµV)	Factor (dB)	Emission Level (dBµV/m)	Limits (dBµV/m)	Margin (dB)	Detector Type
4882.259	63.02	-3.67	59.35	74	-14.65	peak
4882.259	47.09	-3.67	43.42	54	-10.58	AVG
7323.186	56.09	-0.82	55.27	74	-18.73	peak
7323.186	42.69	-0.82	41.87	54	-12.13	AVG

Remark:
 Factor = Antenna Factor + Cable Loss – Pre-amplifier.
 No emission above 18GHz

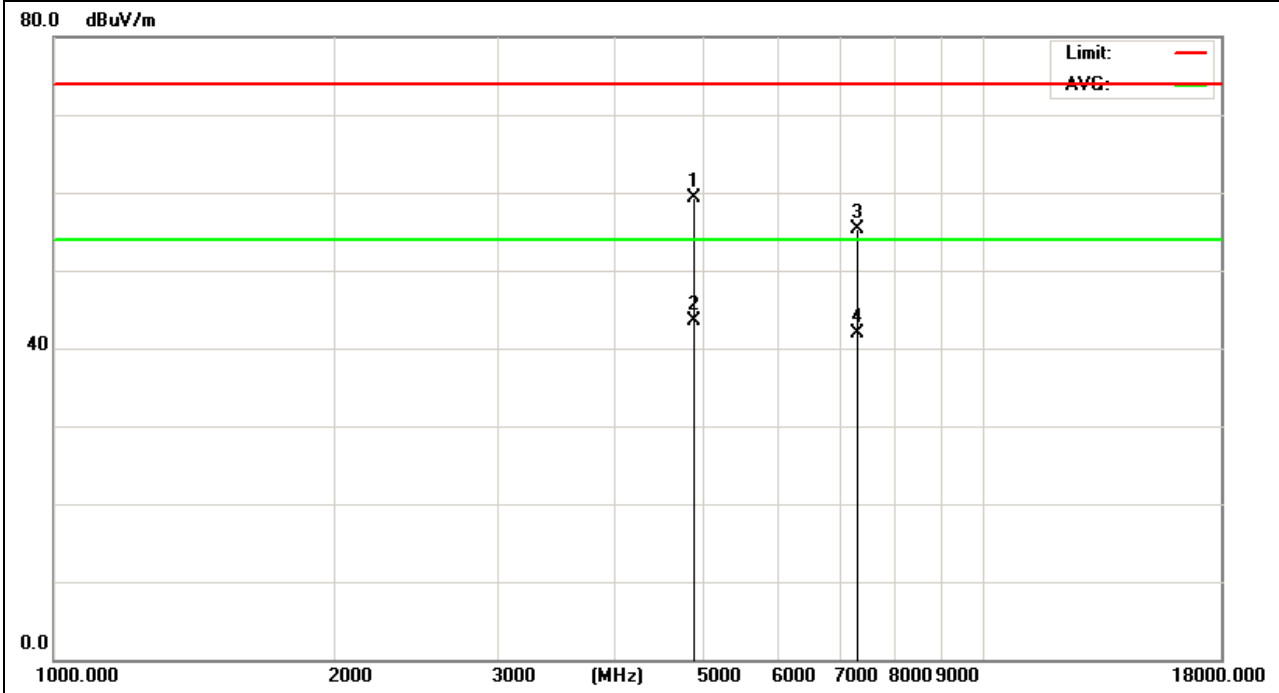

EUT :	SUBARU 13 Forester	Model Name :	75342
Temperature :	20 °C	Relative Humidity :	48%
Pressure :	1010 hPa	Test Voltage :	DC 12V
Test Mode :	TX 2480MHz – CH78 (3Mbps)	Polarization :	Horizontal

Frequency (MHz)	Meter Reading (dBµV)	Factor (dB)	Emission Level (dBµV/m)	Limits (dBµV/m)	Margin (dB)	Detector Type
4960.428	61.05	-3.6	57.45	74	-16.55	peak
4960.428	47.3	-3.6	43.7	54	-10.3	AVG
7440.217	54.66	-0.68	53.98	74	-20.02	peak
7440.217	43.9	-0.68	43.22	54	-10.78	AVG

Remark:
 Factor = Antenna Factor + Cable Loss – Pre-amplifier.
 No emission above 18GHz

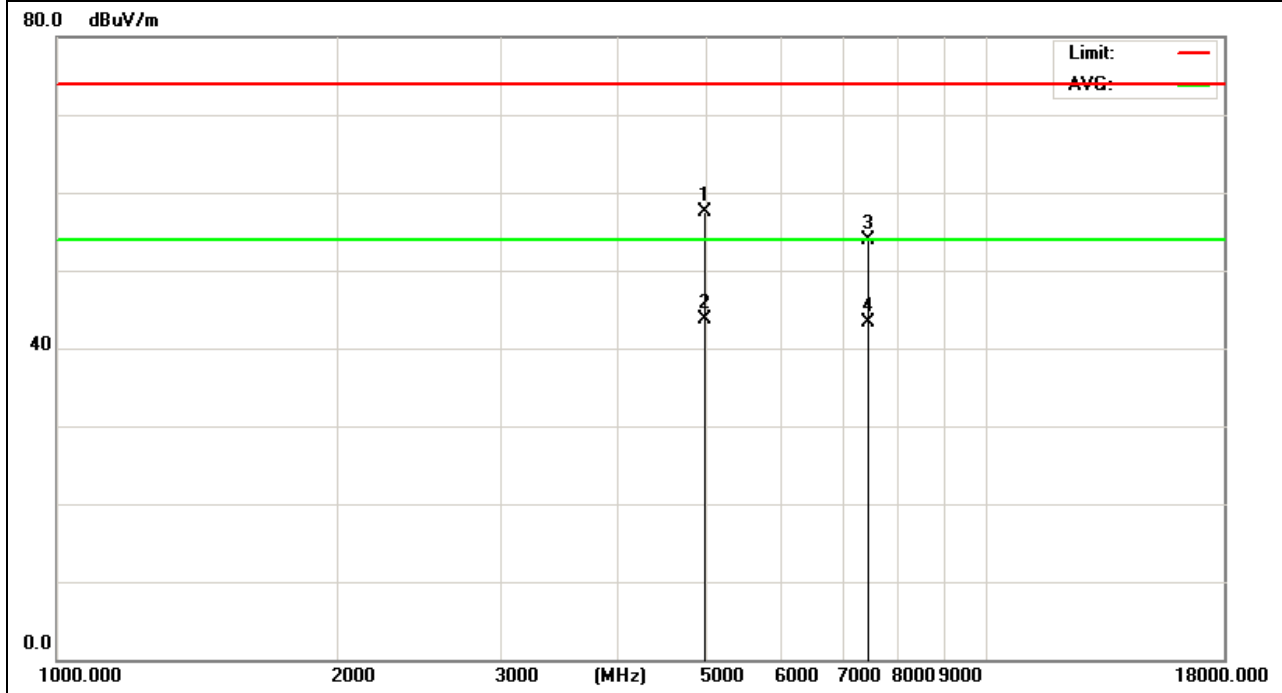

EUT :	SUBARU 13 Forester	Model Name :	75342
Temperature :	20 °C	Relative Humidity :	48%
Pressure :	1010 hPa	Test Voltage :	DC 12V
Test Mode :	TX 2480MHz – CH78 (3Mbps)	Polarization :	Vertical

Frequency (MHz)	Meter Reading (dBµV)	Factor (dB)	Emission Level (dBµV/m)	Limits (dBµV/m)	Margin (dB)	Detector Type
4960.301	62.25	-3.59	58.66	74	-15.34	peak
4960.301	47.89	-3.59	44.3	54	-9.7	AVG
7440.612	55.92	-0.68	55.24	74	-18.76	peak
7440.612	42.84	-0.68	42.16	54	-11.84	AVG

Remark:
 Factor = Antenna Factor + Cable Loss – Pre-amplifier.
 No emission above 18GHz

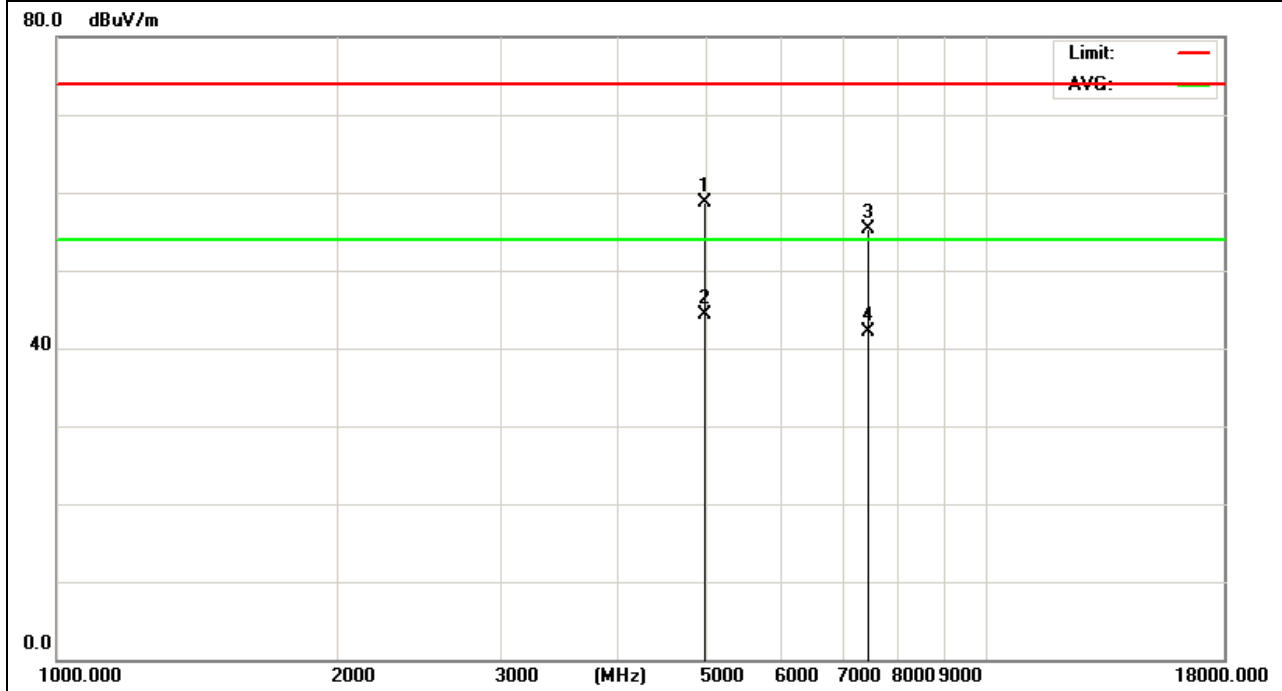

3.2.9 TEST RESULTS (RESTRICTED BANDS REQUIREMENTS)

EUT :	SUBARU 13 Forester	Model Name :	75342
Temperature :	20 °C	Relative Humidity :	48%
Pressure :	1010 hPa	Test Voltage :	DC 12V
Test Mode :	TX /2402MHz-1Mbps	Polarization :	Vertical

Frequency (MHz)	Meter Reading (dBμV)	Factor (dB)	Emission Level (dBμV/m)	Limits (dBμV/m)	Margin (dB)	Detector Type
2400	90.4	-40.5	49.9	74	-24.1	peak

Remark:

Factor = Antenna Factor + Cable Loss – Pre-amplifier.

Hopping enabled and disabled have evaluated, and the worst data was reported

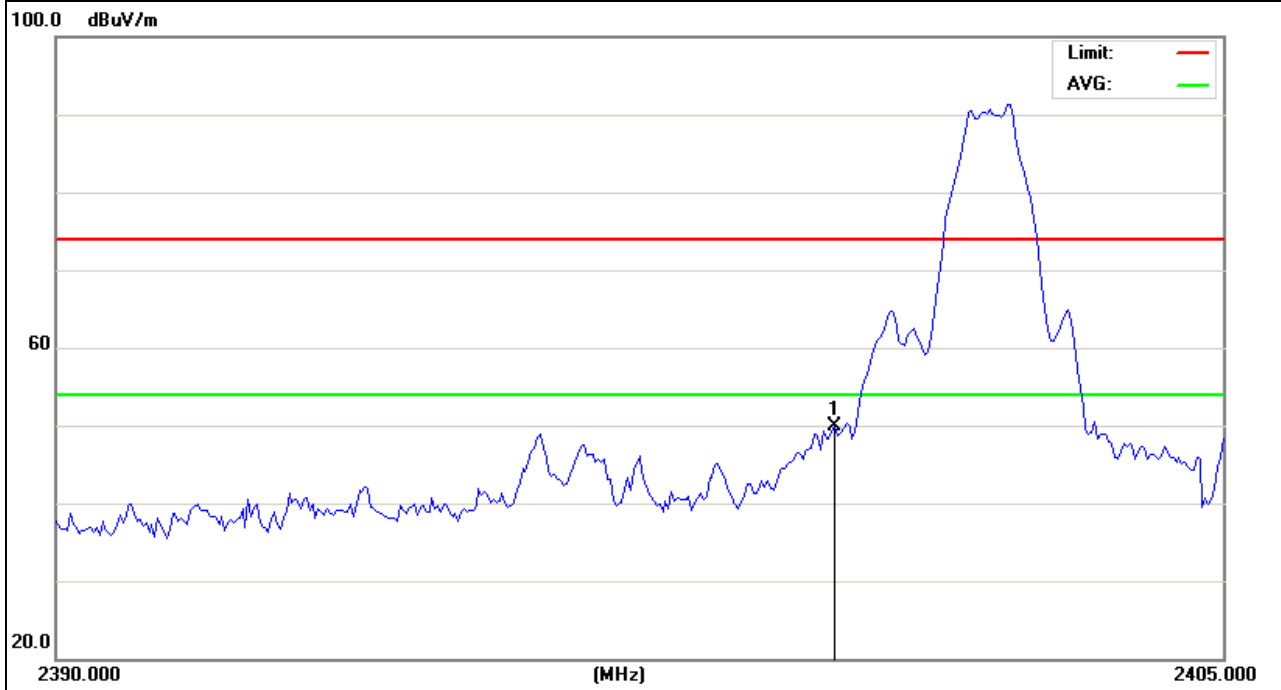

EUT :	SUBARU 13 Forester	Model Name :	75342
Temperature :	20 °C	Relative Humidity :	48%
Pressure :	1010 hPa	Test Voltage :	DC 12V
Test Mode :	TX /2402MHz-1Mbps	Polarization :	Horizontal

Frequency (MHz)	Meter Reading (dBµV)	Factor (dB)	Emission Level (dBµV/m)	Limits (dBµV/m)	Margin (dB)	Detector Type
2400	83.2	-40.5	42.7	74	-31.3	peak

Remark:

Factor = Antenna Factor + Cable Loss – Pre-amplifier.

Hopping enabled and disabled have evaluated, and the worst data was reported

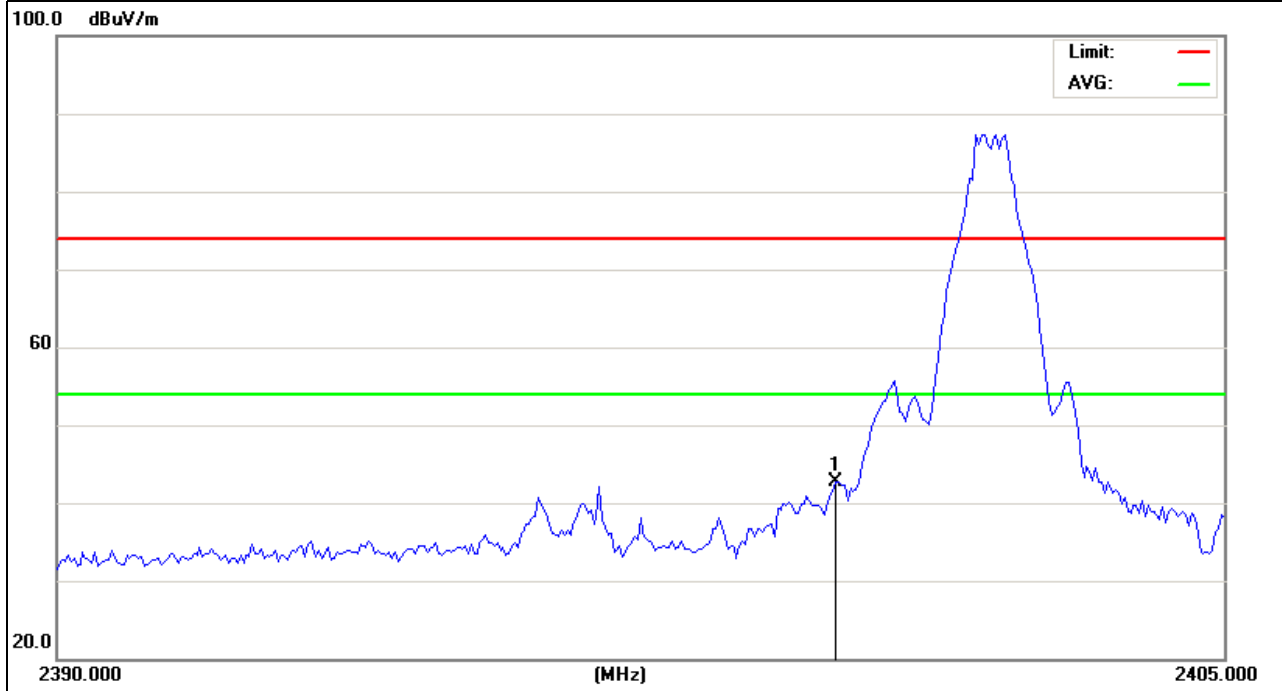

EUT :	SUBARU 13 Forester	Model Name :	75342
Temperature :	20 °C	Relative Humidity :	48%
Pressure :	1010 hPa	Test Voltage :	DC 12V
Test Mode :	TX /2480MHz-1Mbps	Polarization :	Vertical

Frequency (MHz)	Meter Reading (dBμV)	Factor (dB)	Emission Level (dBμV/m)	Limits (dBμV/m)	Margin (dB)	Detector Type
2483.5	87.73	-40.43	47.3	74	-26.7	peak

Remark:

Factor = Antenna Factor + Cable Loss – Pre-amplifier.

Hopping enabled and disabled have evaluated, and the worst data was reported

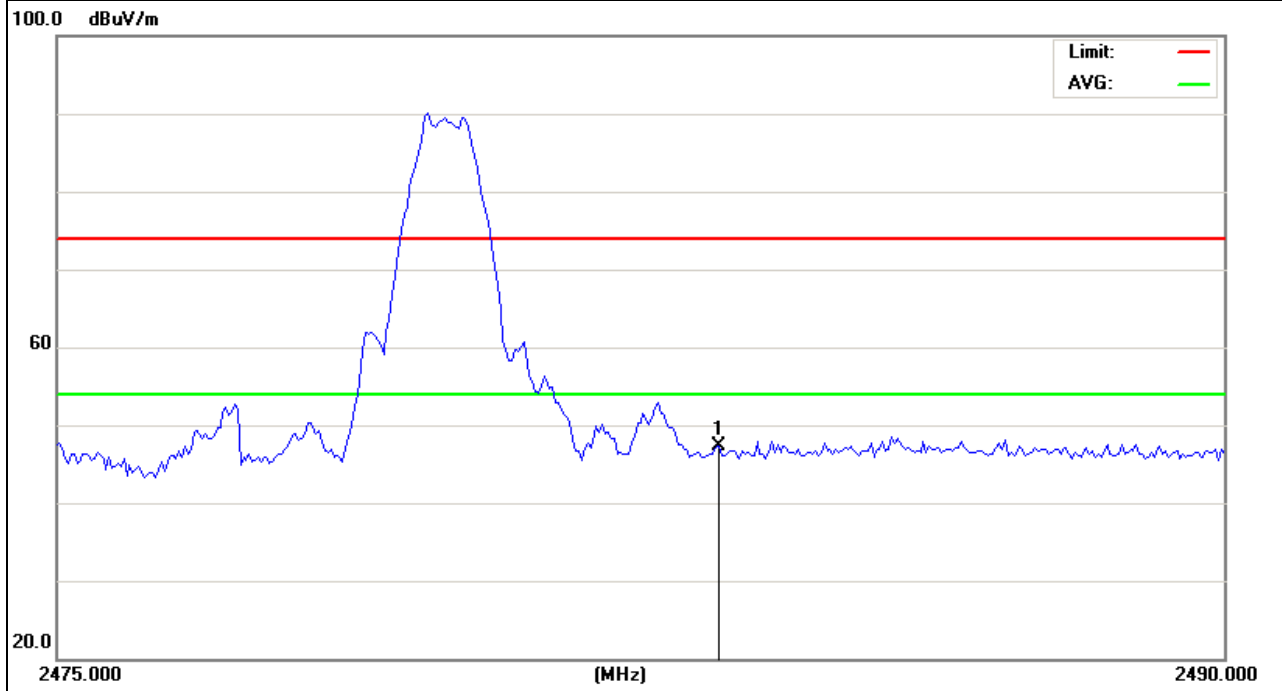

EUT :	SUBARU 13 Forester	Model Name :	75342
Temperature :	20 °C	Relative Humidity :	48%
Pressure :	1010 hPa	Test Voltage :	DC 12V
Test Mode :	TX /2480MHz-1Mbps	Polarization :	Horizontal

Frequency (MHz)	Meter Reading (dBμV)	Factor (dB)	Emission Level (dBμV/m)	Limits (dBμV/m)	Margin (dB)	Detector Type
2483.5	80.22	-40.43	39.79	74	-34.21	peak

Remark:

Factor = Antenna Factor + Cable Loss – Pre-amplifier.

Hopping enabled and disabled have evaluated, and the worst data was reported

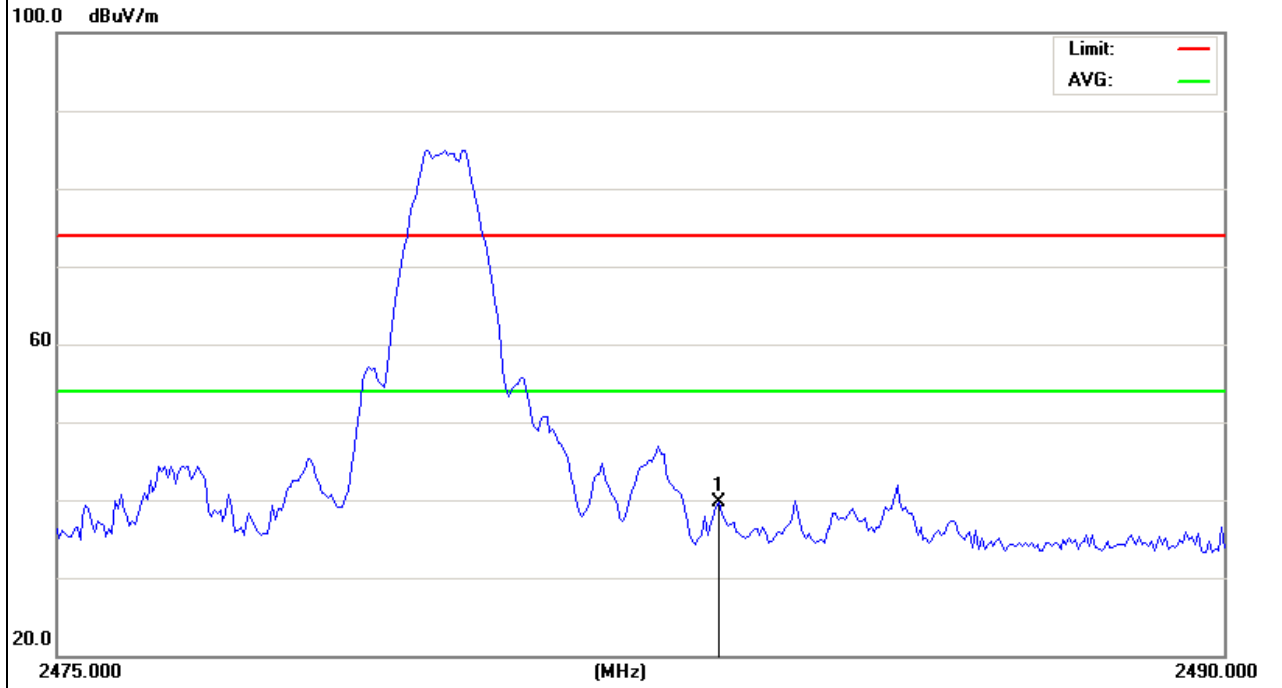

EUT :	SUBARU 13 Forester	Model Name :	75342
Temperature :	20 °C	Relative Humidity :	48%
Pressure :	1010 hPa	Test Voltage :	DC 12V
Test Mode :	TX /2402MHz-2Mbps	Polarization :	Vertical

Frequency (MHz)	Meter Reading (dBµV)	Factor (dB)	Emission Level (dBµV/m)	Limits (dBµV/m)	Margin (dB)	Detector Type
2400	88.5	-40.5	48	74	-26	peak

Remark:

Factor = Antenna Factor + Cable Loss – Pre-amplifier.

Hopping enabled and disabled have evaluated, and the worst data was reported

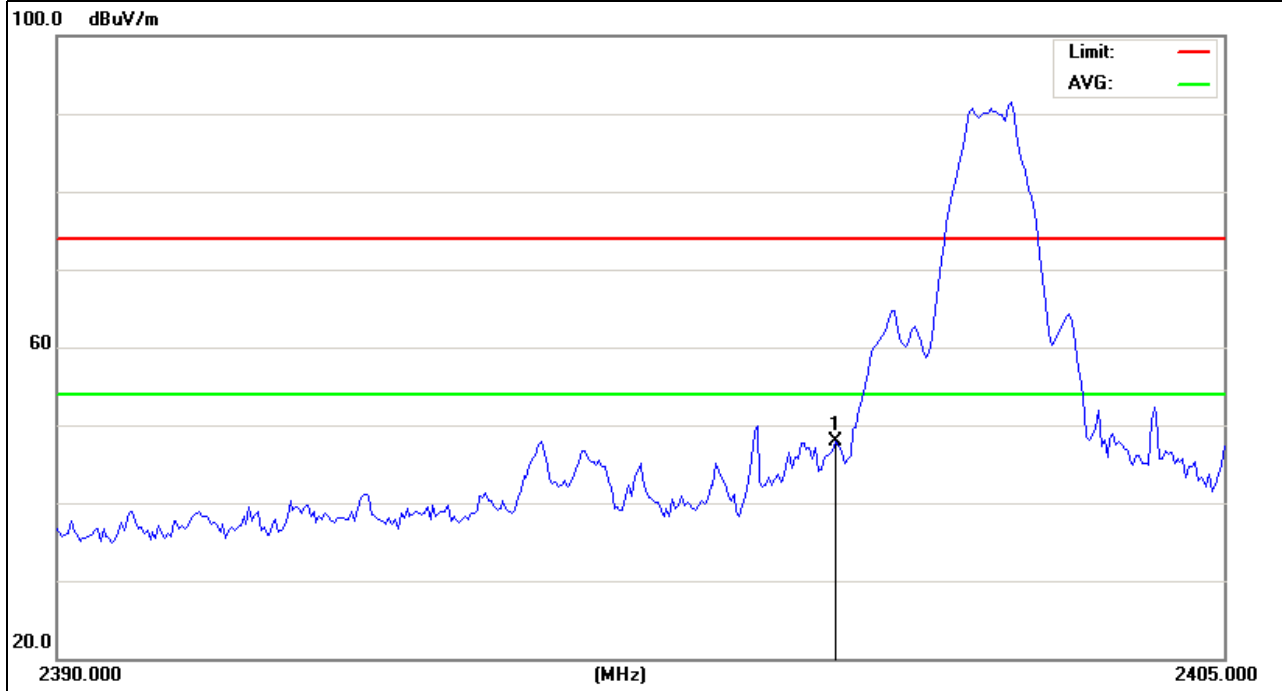

EUT :	SUBARU 13 Forester	Model Name :	75342
Temperature :	20 °C	Relative Humidity :	48%
Pressure :	1010 hPa	Test Voltage :	DC 12V
Test Mode :	TX /2402MHz-2Mbps	Polarization :	Horizontal

Frequency (MHz)	Meter Reading (dBμV)	Factor (dB)	Emission Level (dBμV/m)	Limits (dBμV/m)	Margin (dB)	Detector Type
2400	85.9	-40.5	45.4	74	-28.6	peak

Remark:

Factor = Antenna Factor + Cable Loss – Pre-amplifier.

Hopping enabled and disabled have evaluated, and the worst data was reported

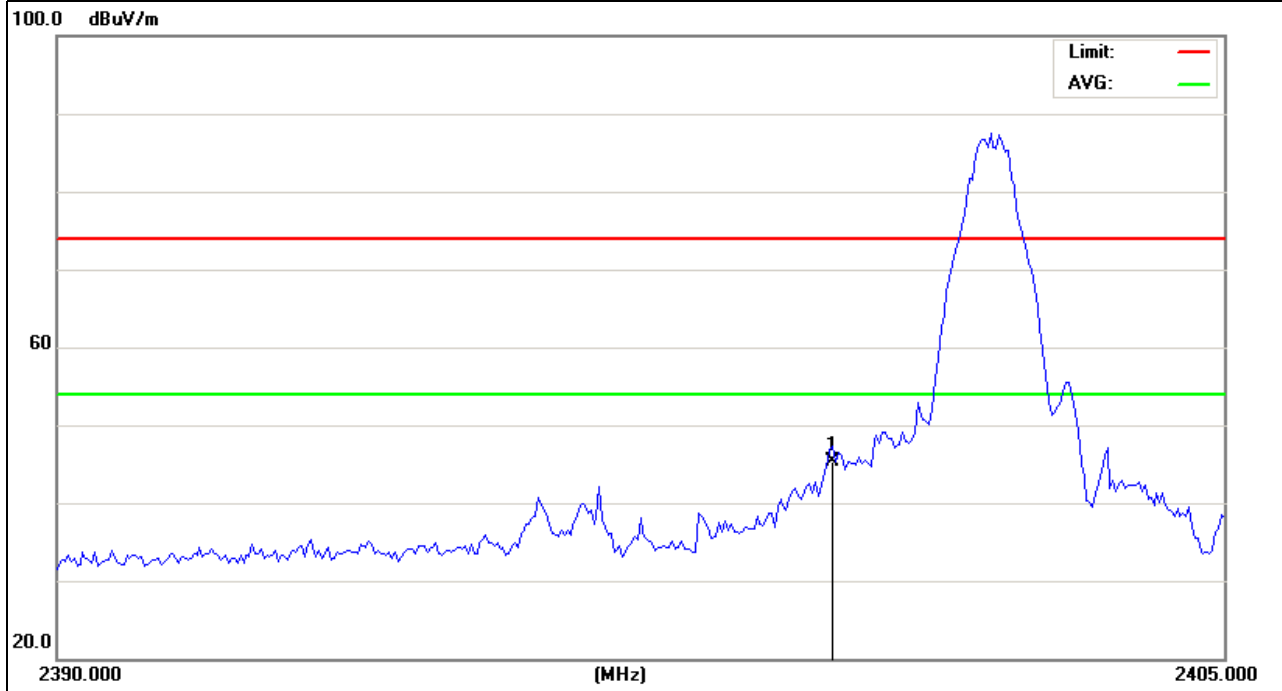

EUT :	SUBARU 13 Forester	Model Name :	75342
Temperature :	20 °C	Relative Humidity :	48%
Pressure :	1010 hPa	Test Voltage :	DC 12V
Test Mode :	TX /2480MHz-2Mbps	Polarization :	Vertical

Frequency (MHz)	Meter Reading (dBμV)	Factor (dB)	Emission Level (dBμV/m)	Limits (dBμV/m)	Margin (dB)	Detector Type
2483.5	86.74	-40.43	46.31	74	-27.69	peak

Remark:

Factor = Antenna Factor + Cable Loss – Pre-amplifier.

Hopping enabled and disabled have evaluated, and the worst data was reported

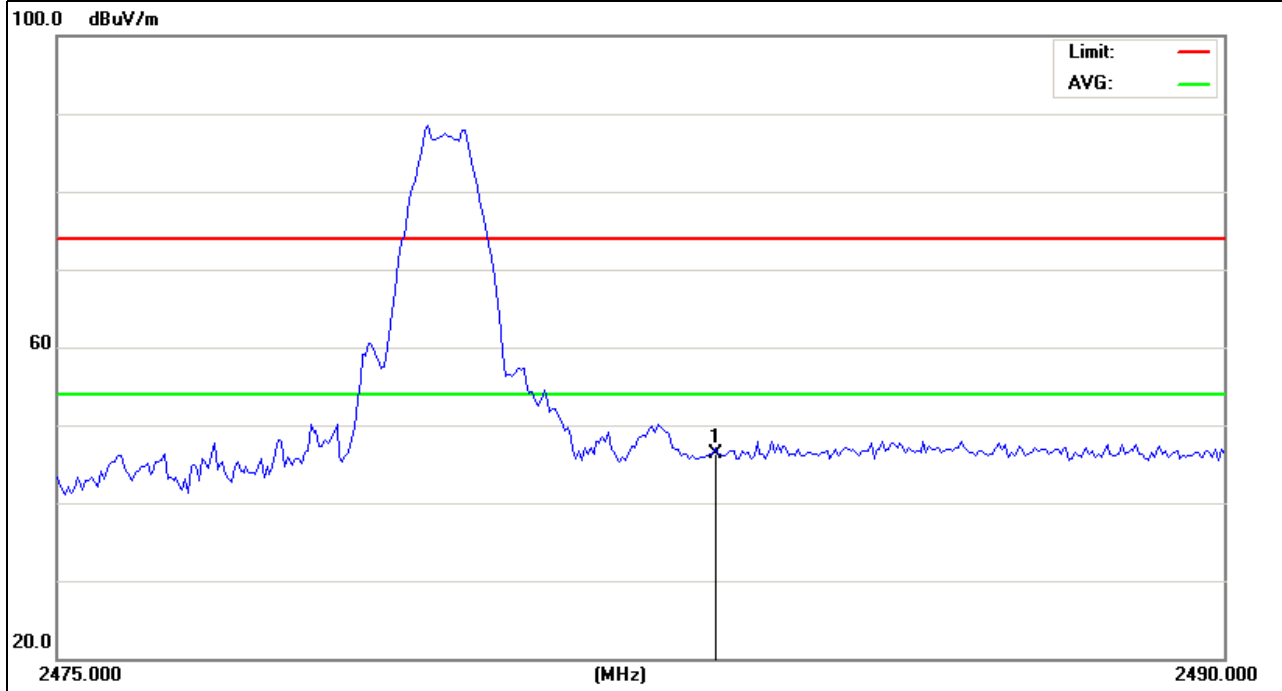

EUT :	SUBARU 13 Forester	Model Name :	75342
Temperature :	20 °C	Relative Humidity :	48%
Pressure :	1010 hPa	Test Voltage :	DC 12V
Test Mode :	TX /2480MHz-2Mbps	Polarization :	Horizontal

Frequency (MHz)	Meter Reading (dBµV)	Factor (dB)	Emission Level (dBµV/m)	Limits (dBµV/m)	Margin (dB)	Detector Type
2483.5	80.22	-40.43	39.79	74	-34.21	peak

Remark:

Factor = Antenna Factor + Cable Loss – Pre-amplifier.

Hopping enabled and disabled have evaluated, and the worst data was reported

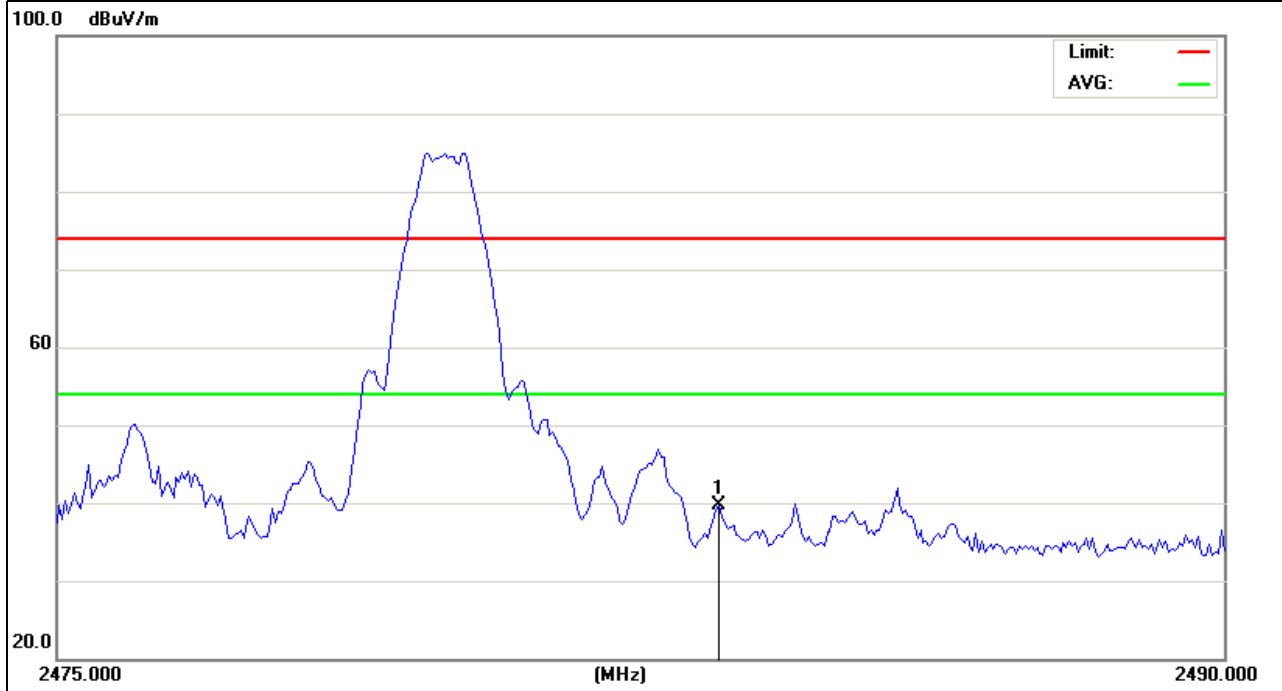

EUT :	SUBARU 13 Forester	Model Name :	75342
Temperature :	20 °C	Relative Humidity :	48%
Pressure :	1010 hPa	Test Voltage :	DC 12V
Test Mode :	TX /2402MHz-3Mbps	Polarization :	Vertical

Frequency (MHz)	Meter Reading (dBµV)	Factor (dB)	Emission Level (dBµV/m)	Limits (dBµV/m)	Margin (dB)	Detector Type
2400	88.1	-40.5	47.6	74	-26.4	peak

Remark:

Factor = Antenna Factor + Cable Loss – Pre-amplifier.

Hopping enabled and disabled have evaluated, and the worst data was reported

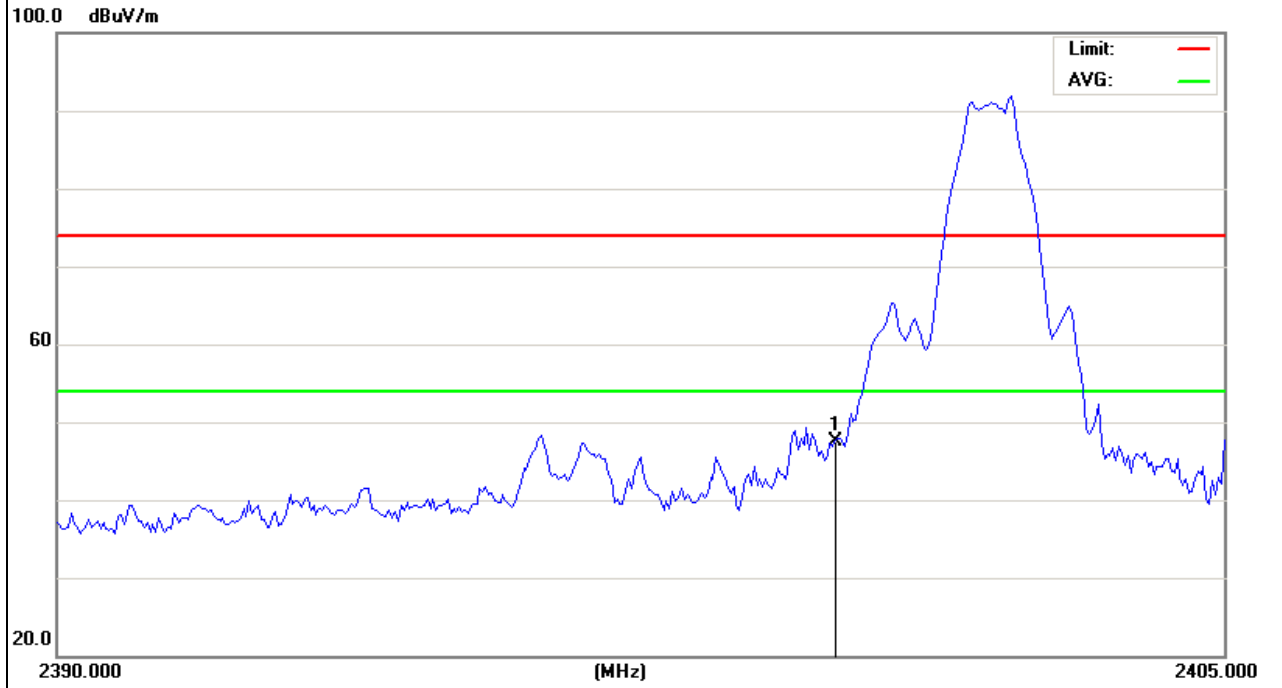

EUT :	SUBARU 13 Forester	Model Name :	75342
Temperature :	20 °C	Relative Humidity :	48%
Pressure :	1010 hPa	Test Voltage :	DC 12V
Test Mode :	TX /2402MHz-3Mbps	Polarization :	Horizontal

Frequency (MHz)	Meter Reading (dBµV)	Factor (dB)	Emission Level (dBµV/m)	Limits (dBµV/m)	Margin (dB)	Detector Type
2400	87.2	-40.5	46.7	74	-27.3	peak

Remark:

Factor = Antenna Factor + Cable Loss – Pre-amplifier.

Hopping enabled and disabled have evaluated, and the worst data was reported

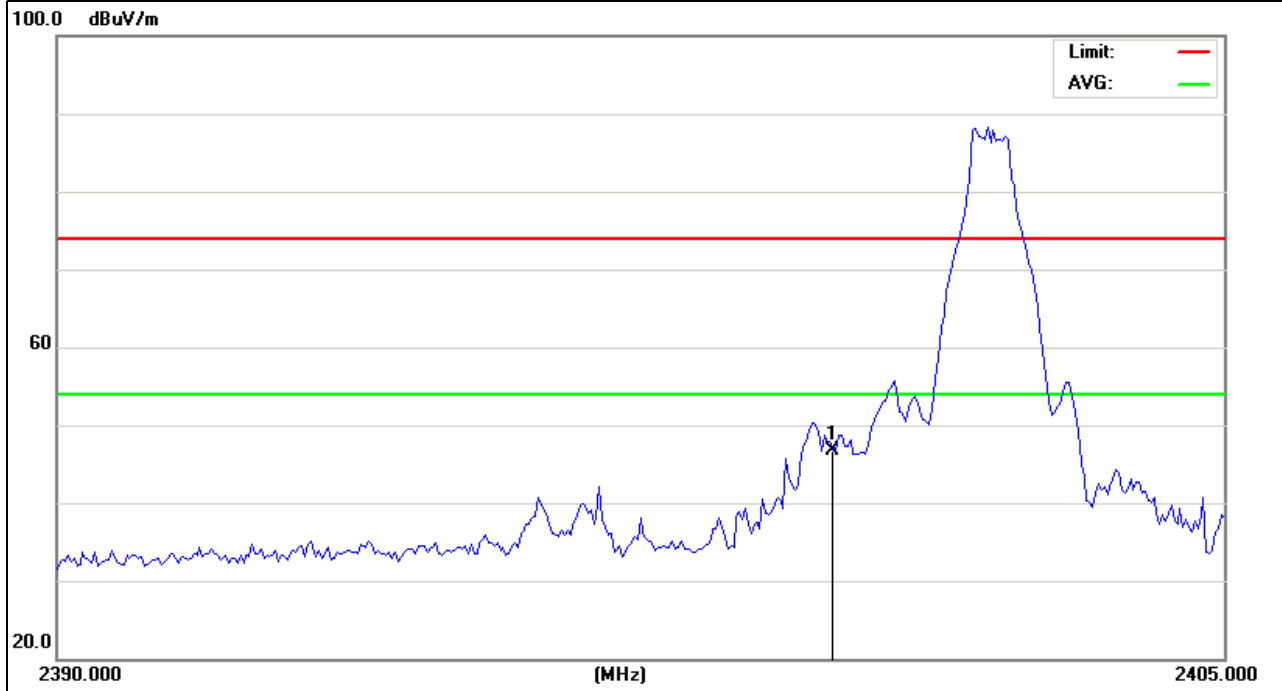

EUT :	SUBARU 13 Forester	Model Name :	75342
Temperature :	20 °C	Relative Humidity :	48%
Pressure :	1010 hPa	Test Voltage :	DC 12V
Test Mode :	TX /2480MHz-3Mbps	Polarization :	Vertical

Frequency (MHz)	Meter Reading (dBμV)	Factor (dB)	Emission Level (dBμV/m)	Limits (dBμV/m)	Margin (dB)	Detector Type
2483.5	86.63	-40.43	46.2	74	-27.8	peak

Remark:

Factor = Antenna Factor + Cable Loss – Pre-amplifier.

Hopping enabled and disabled have evaluated, and the worst data was reported

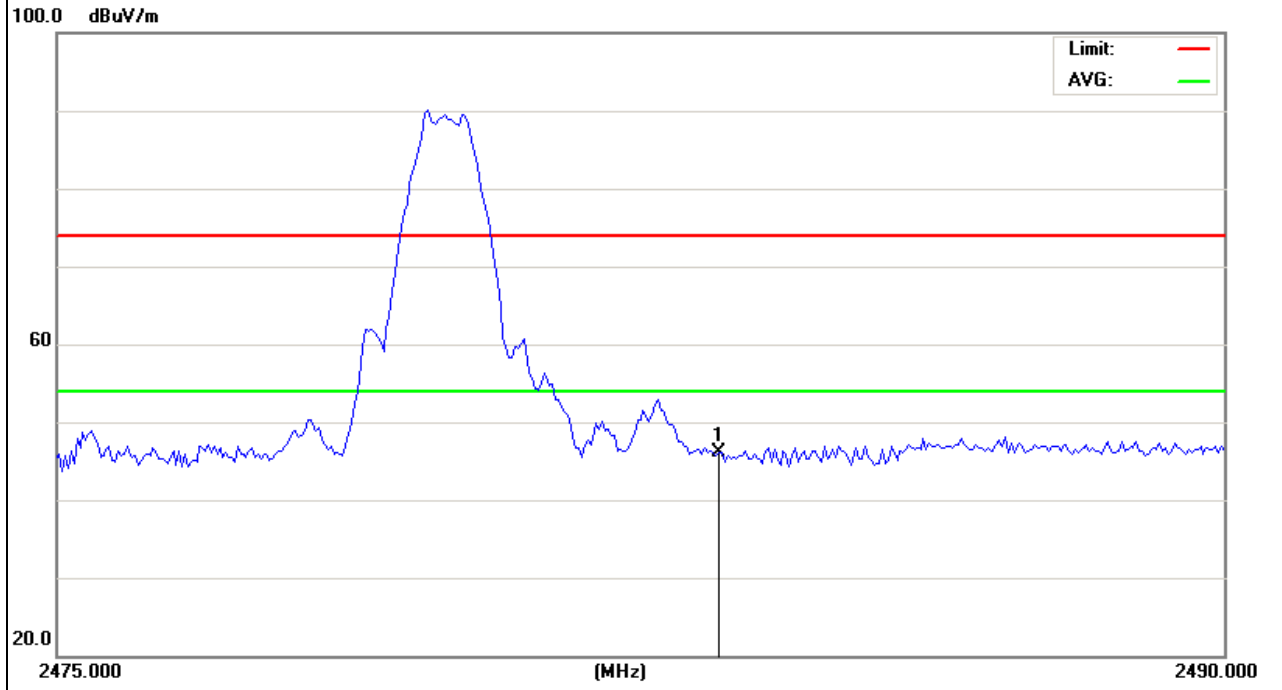

EUT :	SUBARU 13 Forester	Model Name :	75342
Temperature :	20 °C	Relative Humidity :	48%
Pressure :	1010 hPa	Test Voltage :	DC 12V
Test Mode :	TX /2480MHz-3Mbps	Polarization :	Horizontal

Frequency (MHz)	Meter Reading (dBµV)	Factor (dB)	Emission Level (dBµV/m)	Limits (dBµV/m)	Margin (dB)	Detector Type
2483.5	79.33	-40.43	38.9	74	-35.1	peak

Remark:

Factor = Antenna Factor + Cable Loss – Pre-amplifier.

Hopping enabled and disabled have evaluated, and the worst data was reported

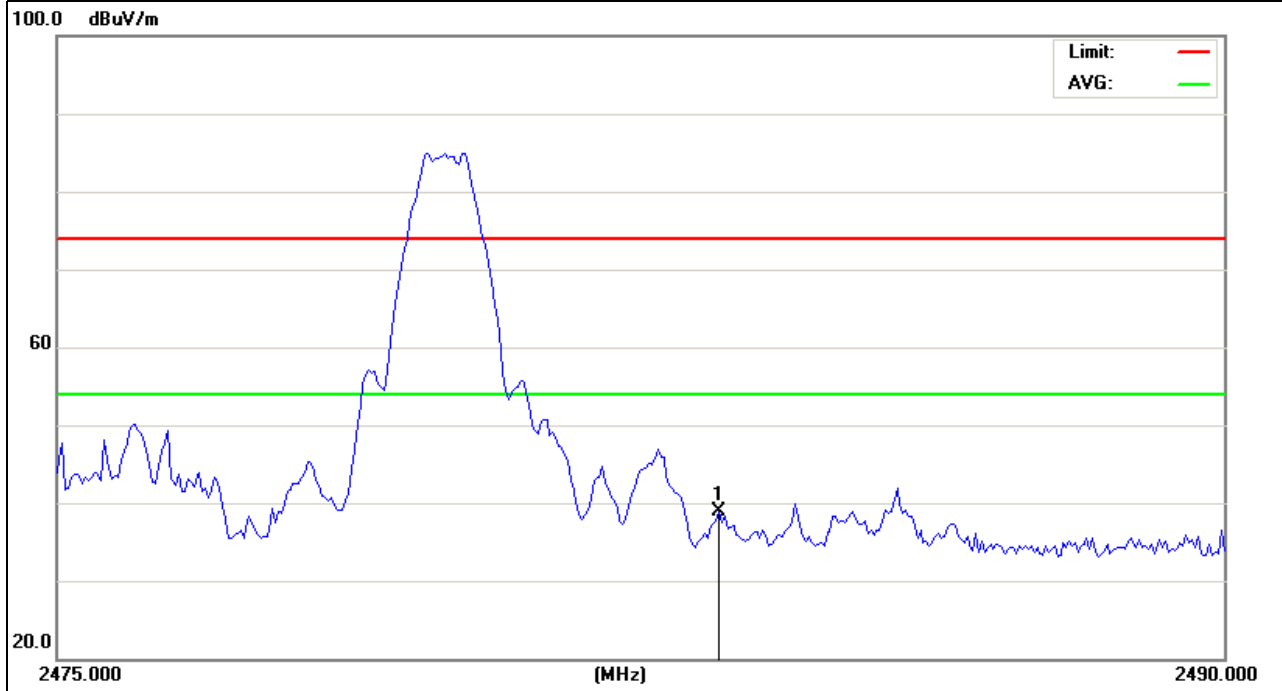

4. NUMBER OF HOPPING CHANNEL

4.1 APPLIED PROCEDURES / LIMIT

FCC Part15 (15.247) , Subpart C				
Section	Test Item	Limit	Frequency Range (MHz)	Result
15.247 (a)(1)(iii)	Number of Hopping Channel	≥15	2400-2483.5	PASS

Spectrum Parameters	Setting
Attenuation	Auto
Span Frequency	> Operating Frequency Range
RB	100 kHz
VB	100 kHz
Detector	Peak
Trace	Max Hold
Sweep Time	Auto

4.1.1 TEST PROCEDURE

- a. The EUT was directly connected to the spectrum analyzer and antenna output port as show in the block diagram below,
- b. Spectrum Setting : RBW= 100KHz, VBW=100KHz, Sweep time = Auto.

4.1.2 DEVIATION FROM STANDARD

No deviation.

4.1.3 TEST SETUP



4.1.4 EUT OPERATION CONDITIONS

The EUT tested system was configured as the statements of 2.4 Unless otherwise a special operating condition is specified in the follows during the testing.

4.1.5 TEST RESULTS

EUT :	SUBARU 13 Forester	Model Name :	75342
Temperature :	25 °C	Relative Humidity :	60%
Pressure :	1015 hPa	Test Voltage :	DC 12V
Test Mode :	Hopping Mode		

Number of Hopping Channel	79
---------------------------	----

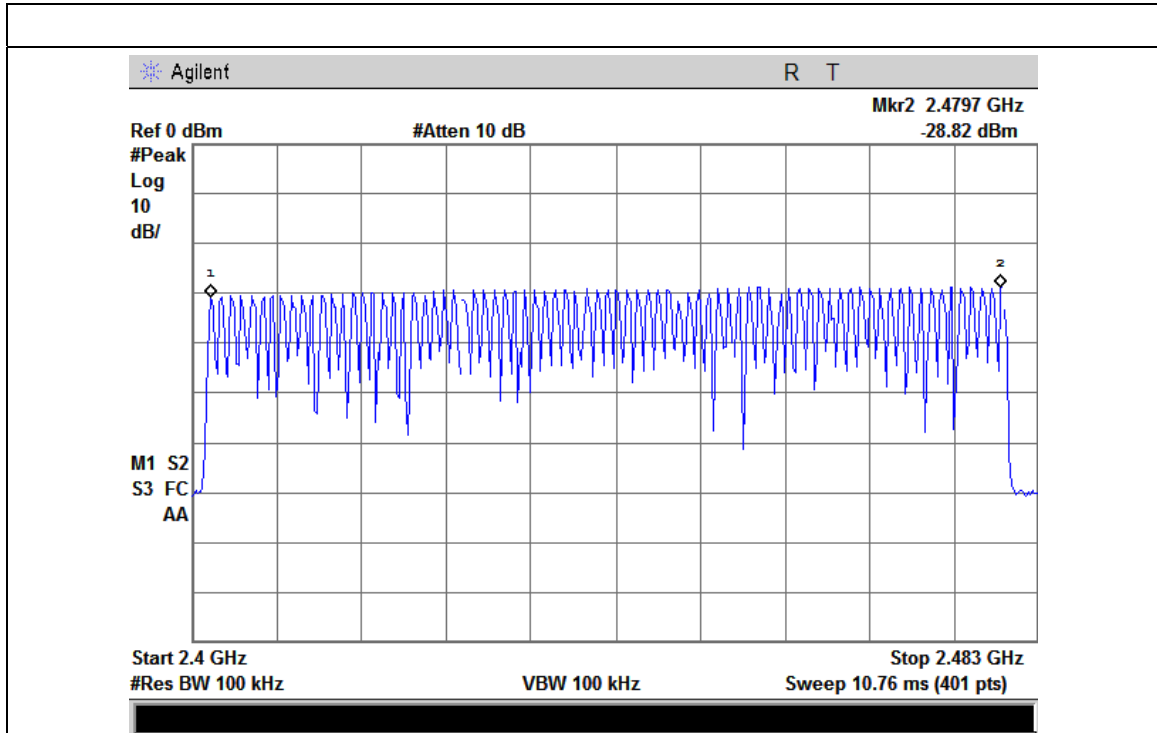

5. AVERAGE TIME OF OCCUPANCY

5.1 APPLIED PROCEDURES / LIMIT

FCC Part15 (15.247) , Subpart C				
Section	Test Item	Limit	Frequency Range (MHz)	Result
15.247 (a)(1)(iii)	Average Time of Occupancy	0.4sec	2400-2483.5	PASS

5.1.1 TEST PROCEDURE

- a. The transmitter output (antenna port) was connected to the spectrum analyzer
- b. Set RBW of spectrum analyzer to 1MHz and VBW to 1MHz.
- c. Use a video trigger with the trigger level set to enable triggering only on full pulses.
- d. Sweep Time is more than once pulse time.
- e. Set the center frequency on any frequency would be measure and set the frequency span to zero span.
- f. Measure the maximum time duration of one single pulse.
- g. Set the EUT for DH5, DH3 and DH1 packet transmitting.
- h. Measure the maximum time duration of one single pulse.
- i. A Period Time = (channel number)*0.4
 DH1 Time Slot: Reading * (1600/2)*31.6/(channel number)
 DH3 Time Slot: Reading * (1600/4)*31.6/(channel number)
 DH5 Time Slot: Reading * (1600/6)*31.6/(channel number)

5.1.2 DEVIATION FROM STANDARD

No deviation.

5.1.3 TEST SETUP

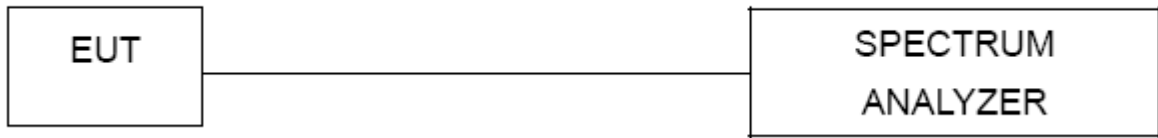

5.1.4 EUT OPERATION CONDITIONS

The EUT tested system was configured as the statements of 2.4 Unless otherwise a special operating condition is specified in the follows during the testing.

5.1.5 TEST RESULTS

EUT :	SUBARU 13 Forester	Model Name :	75342
Temperature :	25 °C	Relative Humidity :	60%
Pressure :	1012 hPa	Test Voltage :	DC 12V
Test Mode :	CH00-DH5 (1M/2M/3Mbps Mode)		

Data Packet	Frequency	Pulse Duration (ms)	Dwell Time (s)	Limits (s)
DH5	2402 MHz	0.52	0.06	0.4
2DH5	2402 MHz	1.83	0.20	0.4
3DH5	2402 MHz	3.04	0.32	0.4

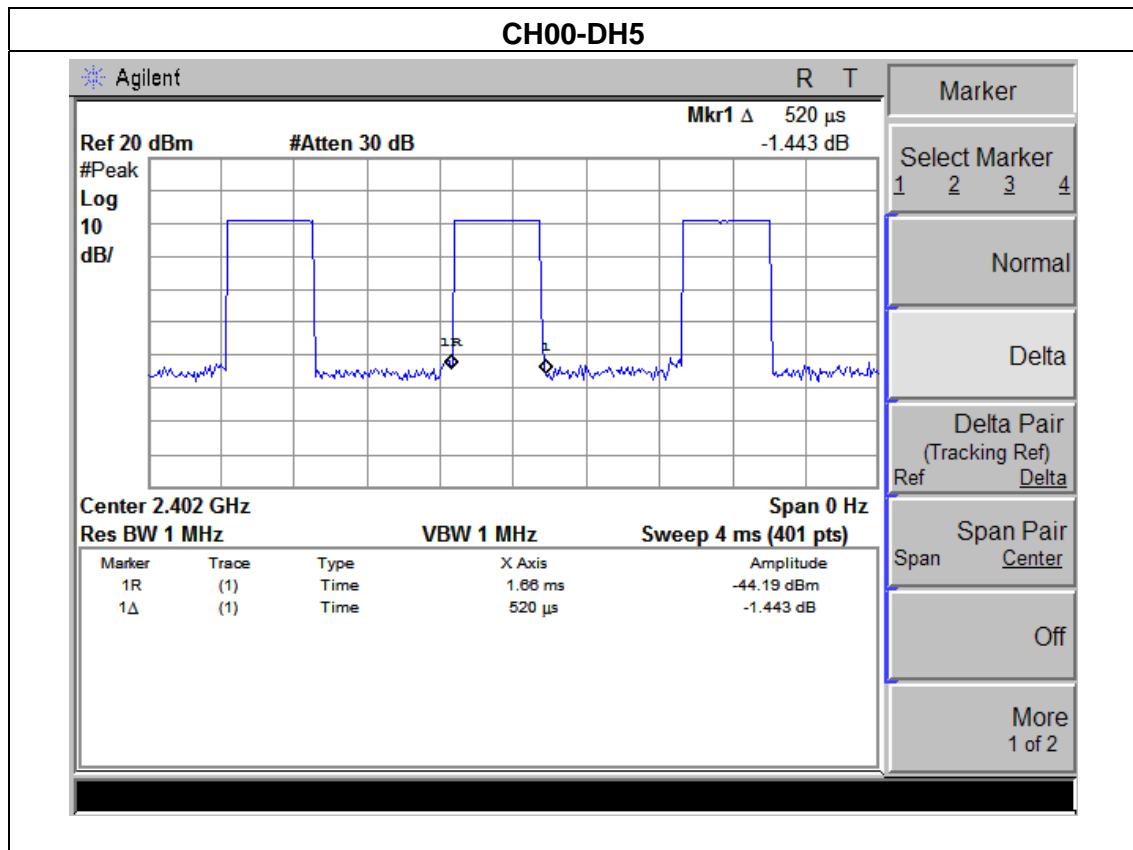

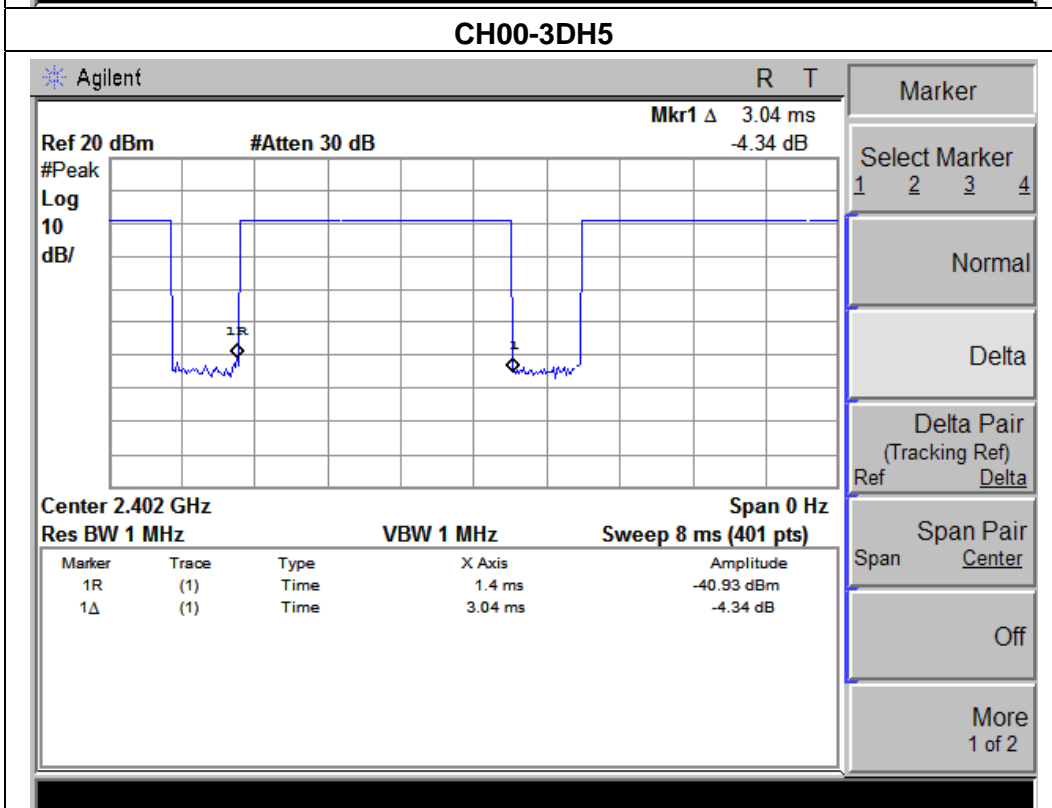
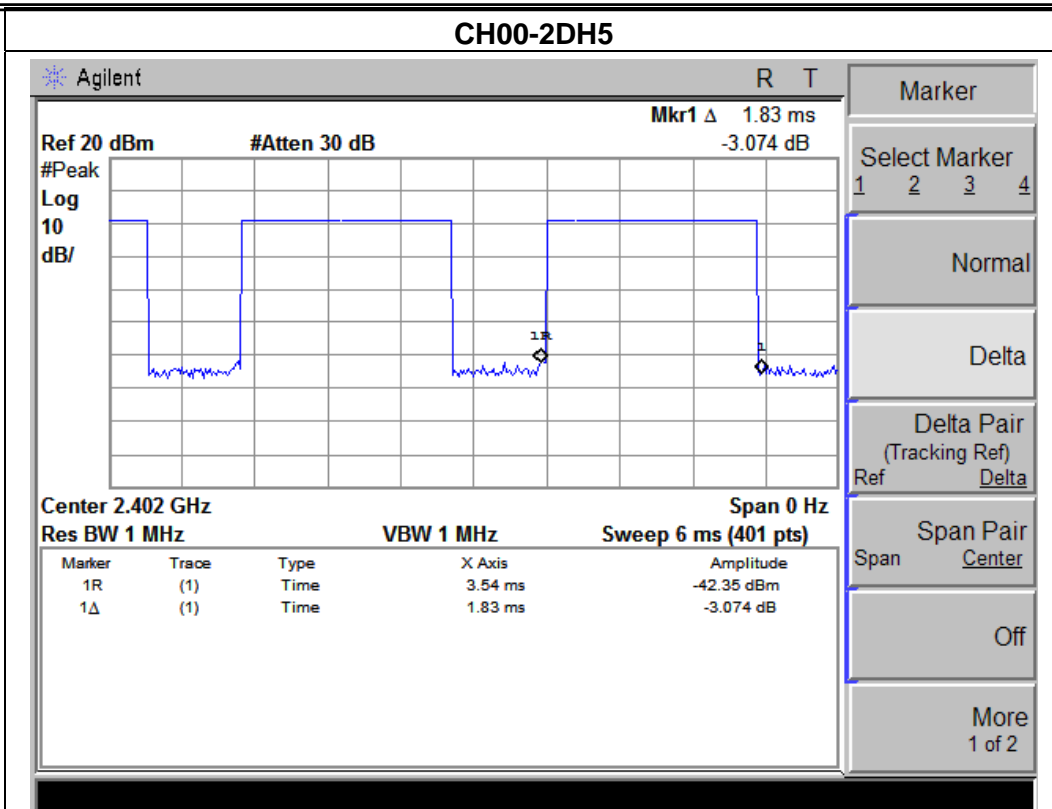

NOTE :The dwell time is showed the maximum data of all data(DH1,2DH1,3DH1, DH3,2DH3,3DH3, DH5,2DH5,3DH5), (DH5,2DH5,3DH5) of mode have the maximum dwell time.

6. HOPPING CHANNEL SEPARATION MEASUREMENT

6.1 APPLIED PROCEDURES / LIMIT

Frequency hopping systems operating in the 2400-2483.5 MHz band may have hopping channel carrier frequencies that are separated by 25 kHz or two-thirds of the 20 dB bandwidth of the hopping channel, whichever is greater.

Spectrum Parameter	Setting
Attenuation	Auto
Span Frequency	> Measurement Bandwidth or Channel Separation
RB	100 kHz (Channel Separation)
VB	300 kHz (Channel Separation)
Detector	Peak
Trace	Max Hold
Sweep Time	Auto

6.1.1 TEST PROCEDURE

- a. The transmitter output (antenna port) was connected to the spectrum analyser in peak hold mode.
- b. The resolution bandwidth of 100 kHz and the video bandwidth of 300 kHz were utilised for channel separation measurement.

6.1.2 DEVIATION FROM STANDARD

No deviation.

6.1.3 TEST SETUP

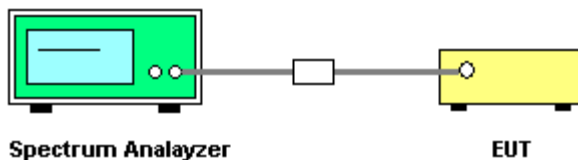

6.1.4 EUT OPERATION CONDITIONS

The EUT was programmed to be in continuously transmitting mode.

6.1.5 TEST RESULTS

EUT :	SUBARU 13 Forester	Model Name :	75342
Temperature :	25 °C	Relative Humidity :	60%
Pressure :	1012 hPa	Test Voltage :	DC 12V
Test Mode :	CH00 / CH39 /CH78 (1Mbps Mode)		

Frequency	Ch. Separation (MHz)	Result
2402 MHz	1.010	Complies
2441 MHz	1.050	Complies
2480 MHz	1.930	Complies

Ch. Separation Limits: > 20dB bandwidth

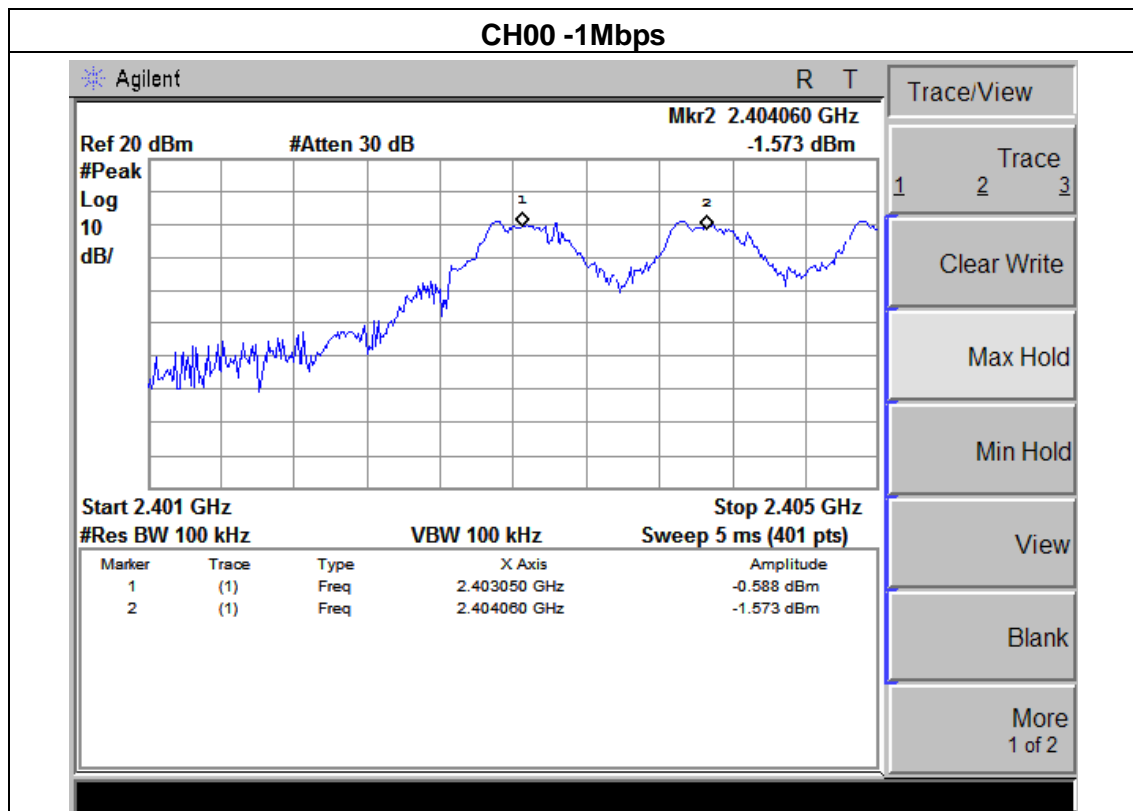

CH39 -1Mbps

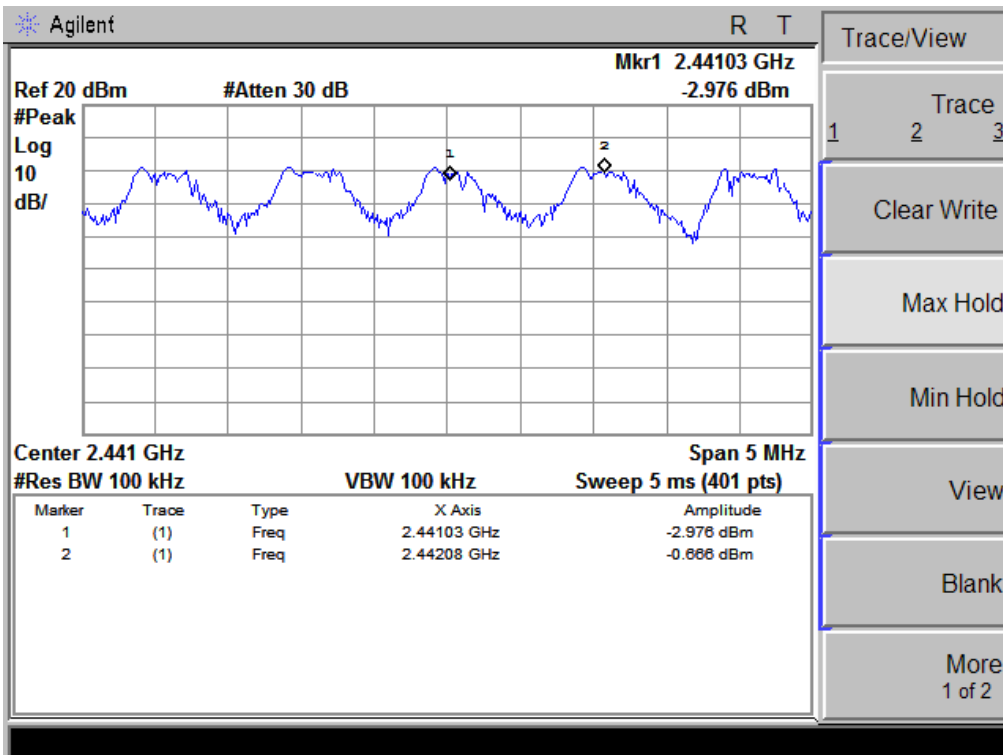

CH78 -1Mbps

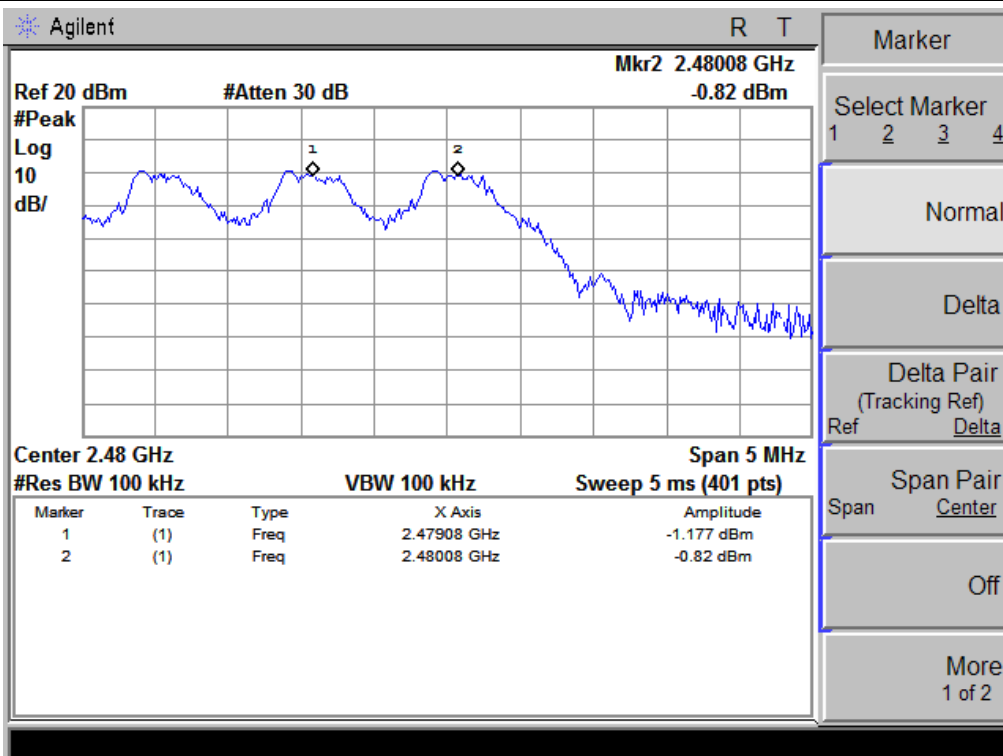

EUT :	SUBARU 13 Forester	Model Name :	75342
Temperature :	25 °C	Relative Humidity :	60%
Pressure :	1012 hPa	Test Voltage :	DC 12V
Test Mode :	CH00 / CH39 /CH78 (2Mbps Mode)		

Frequency	Ch. Separation (MHz)	Result
2402 MHz	0.980	Complies
2441 MHz	1.090	Complies
2480 MHz	0.980	Complies

Ch. Separation Limits: >2/3 of 20dB bandwidth

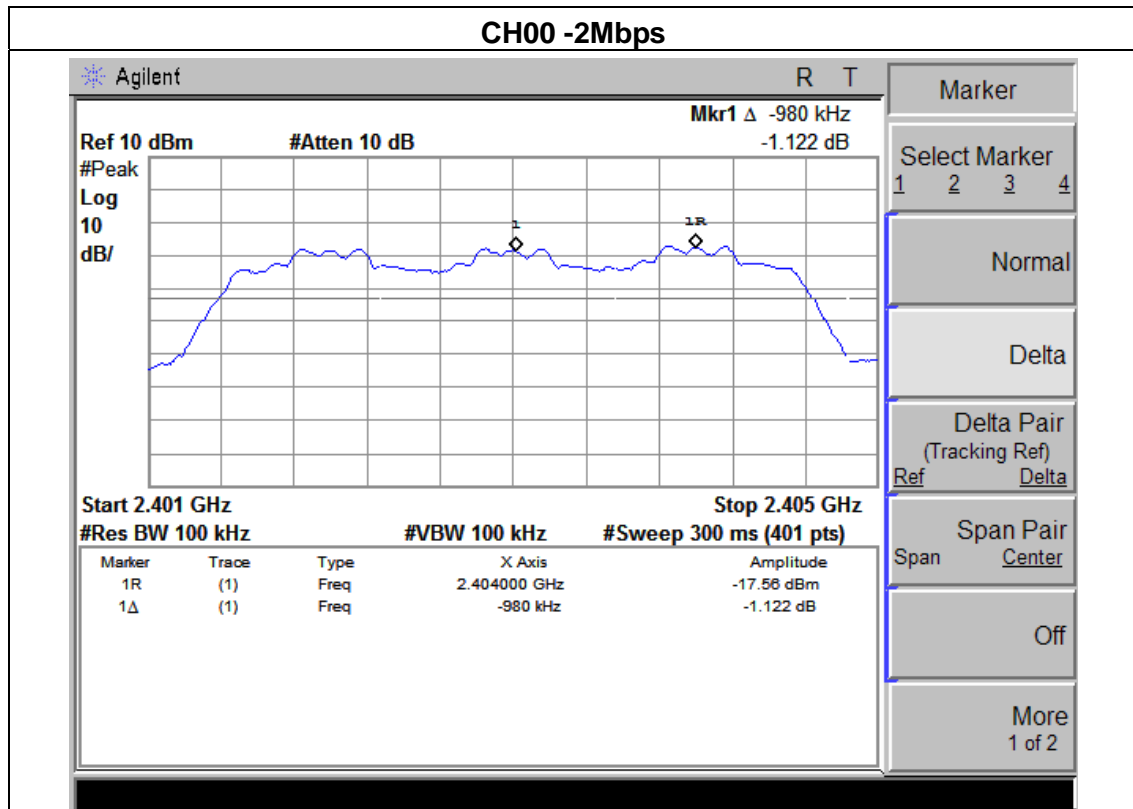

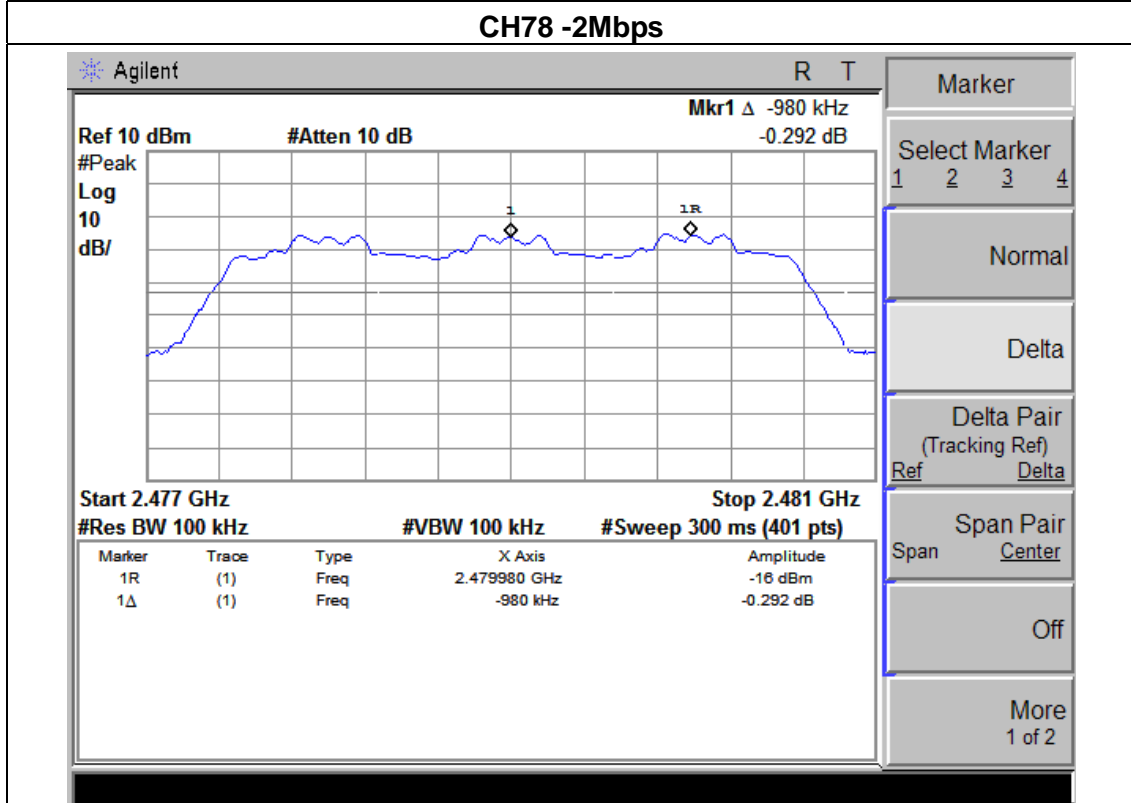
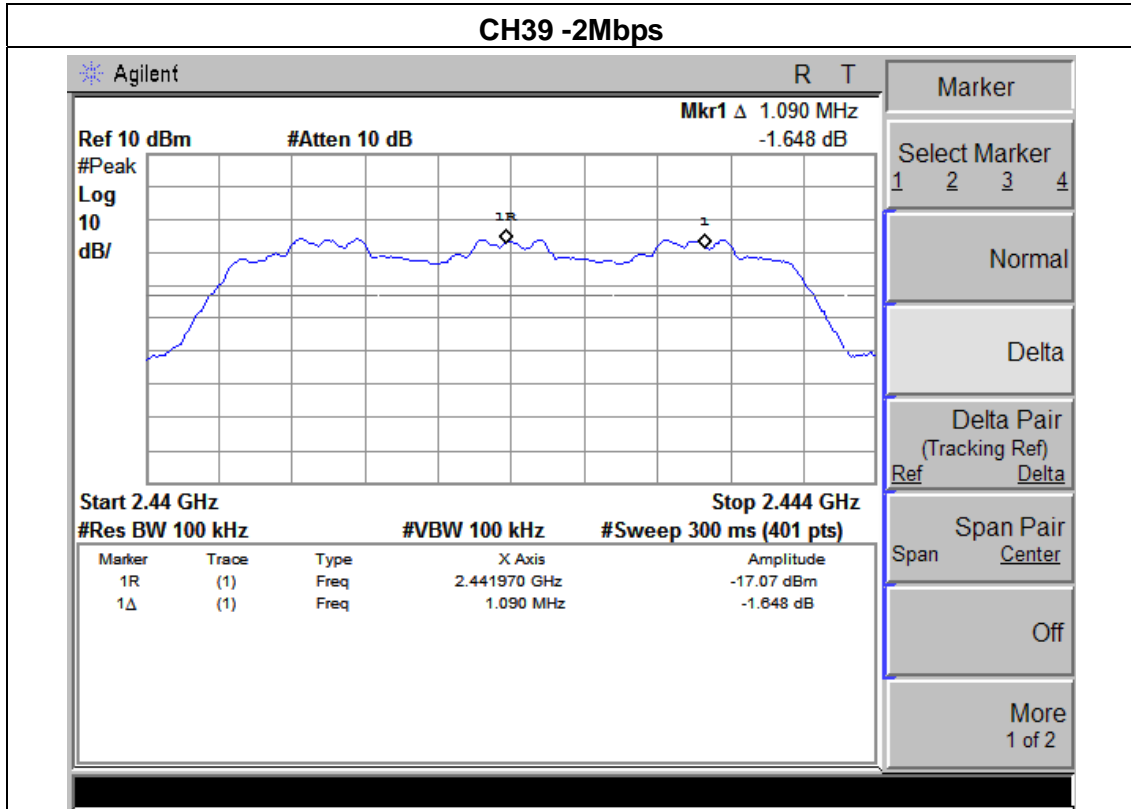

EUT :	SUBARU 13 Forester	Model Name :	75342
Temperature :	25 °C	Relative Humidity :	60%
Pressure :	1012 hPa	Test Voltage :	DC 12V
Test Mode :	CH00 / CH39 /CH78 (3Mbps Mode)		

Frequency	Ch. Separation (MHz)	Result
2402 MHz	0.98	Complies
2441 MHz	0.417	Complies
2480 MHz	1.097	Complies

Ch. Separation Limits:>2/3 of 20dB bandwidth

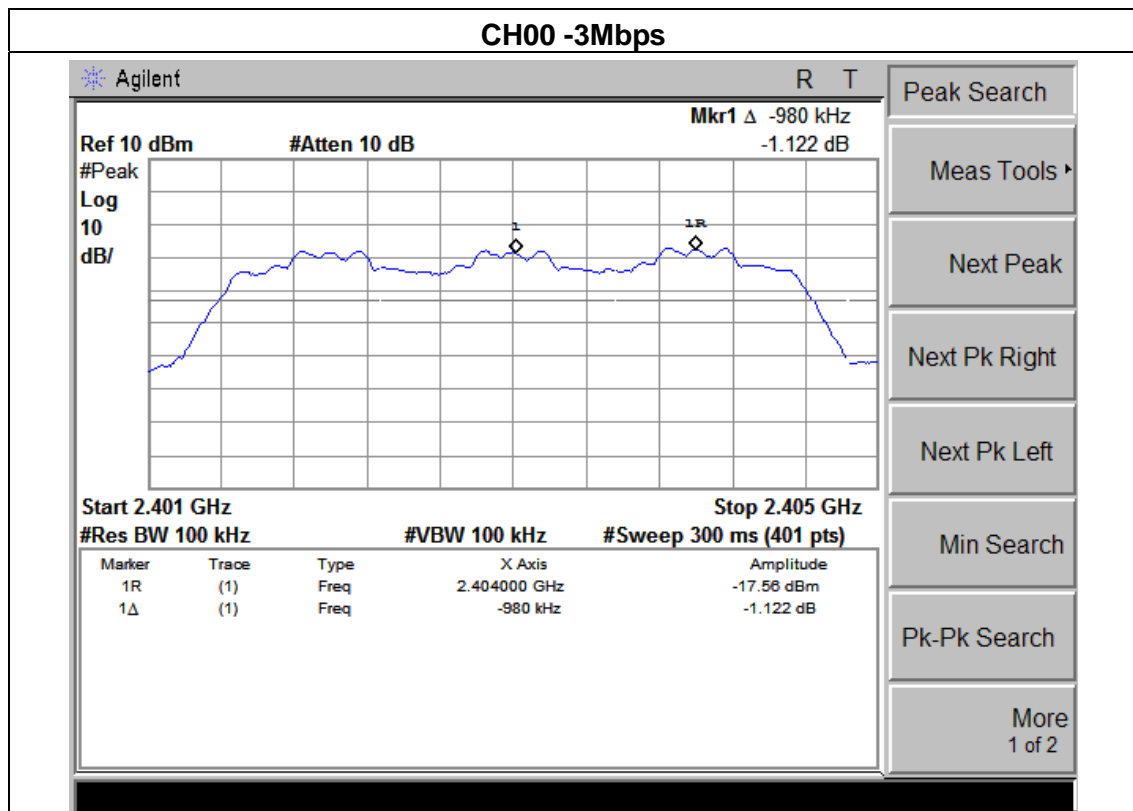

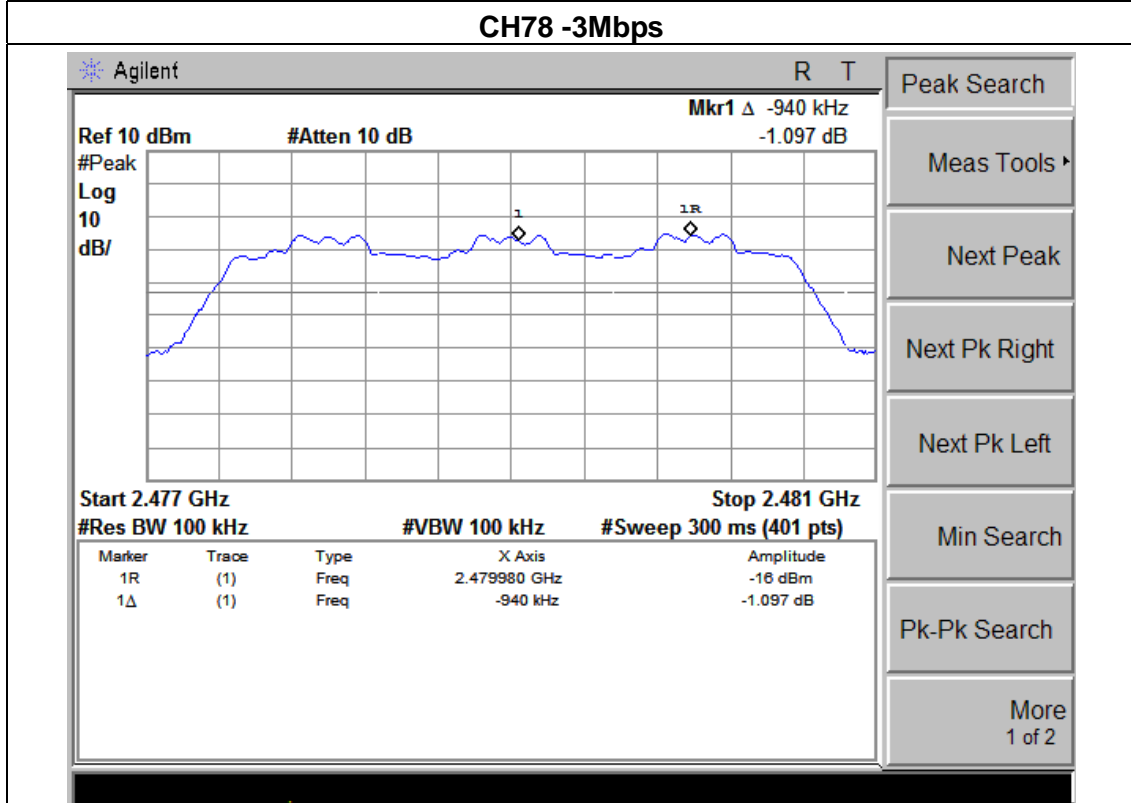
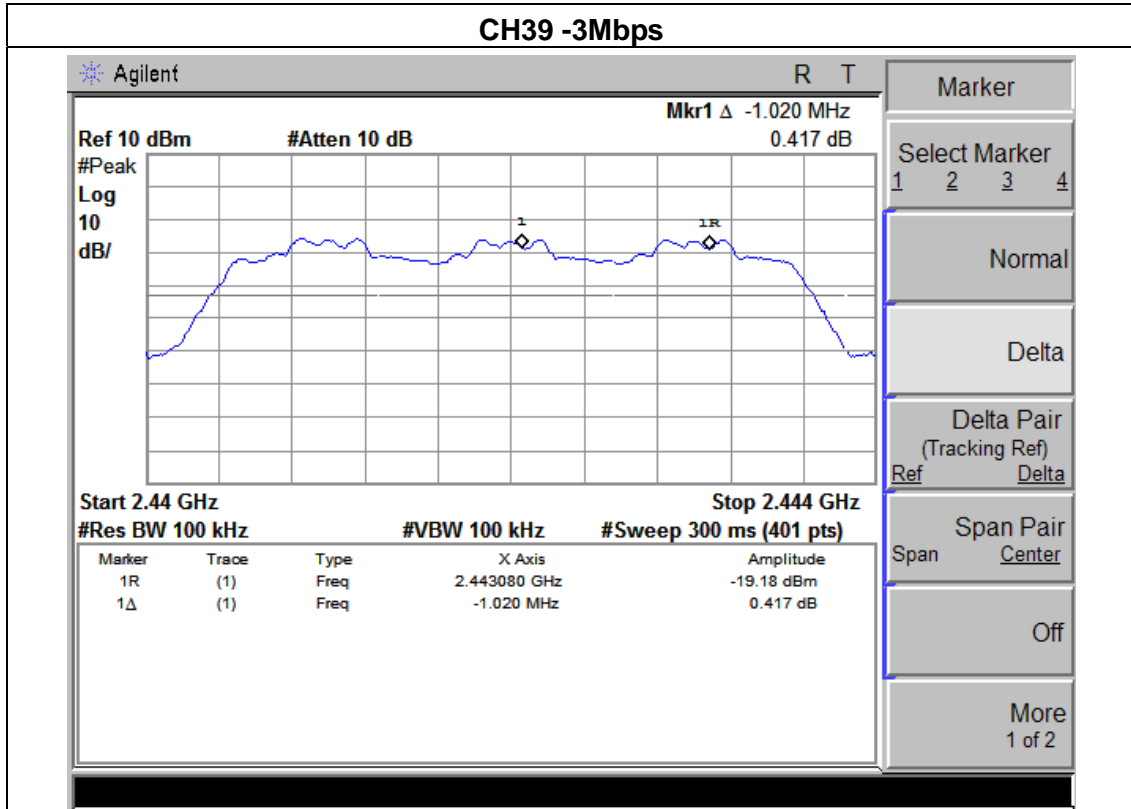

7. BANDWIDTH TEST

7.1 APPLIED PROCEDURES / LIMIT

FCC Part15 (15.247) , Subpart C				
Section	Test Item	Limit	Frequency Range (MHz)	Result
15.247 (a)(1)	Bandwidth	(20dB bandwidth)	2400-2483.5	PASS

Spectrum Parameter	Setting
Attenuation	Auto
Span Frequency	> Measurement Bandwidth or Channel Separation
RB	30 kHz
VB	100 kHz
Detector	Peak
Trace	Max Hold
Sweep Time	Auto

7.1.1 TEST PROCEDURE

- a. The EUT was directly connected to the spectrum analyzer and antenna output port as show in the block diagram below,
- b. Spectrum Setting : RBW= 30KHz, VBW=100KHz, Sweep time = Auto.

7.1.2 DEVIATION FROM STANDARD

No deviation.

7.1.3 TEST SETUP

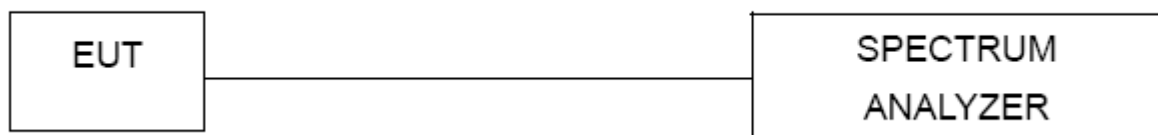

7.1.4 EUT OPERATION CONDITIONS

The EUT tested system was configured as the statements of 2.4 Unless otherwise a special operating condition is specified in the follows during the testing.

7.1.5 TEST RESULTS

EUT :	SUBARU 13 Forester	Model Name :	75342
Temperature :	25 °C	Relative Humidity :	60%
Pressure :	1012 hPa	Test Voltage :	DC 12V
Test Mode :	CH00 / CH39 /C78(1Mbps)		

Frequency	20dB Bandwidth (kHz)	Result
2402 MHz	832.794	PASS
2441 MHz	922.447	PASS
2480 MHz	844.044	PASS

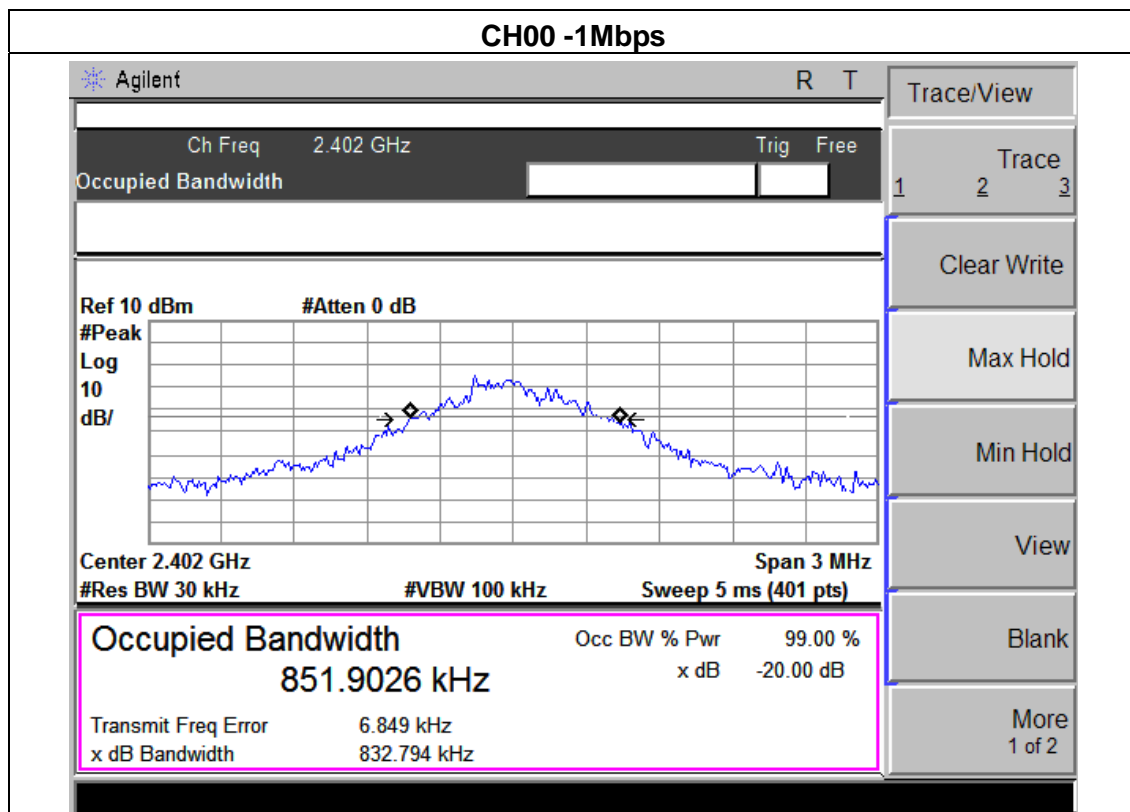

CH39 -1Mbps

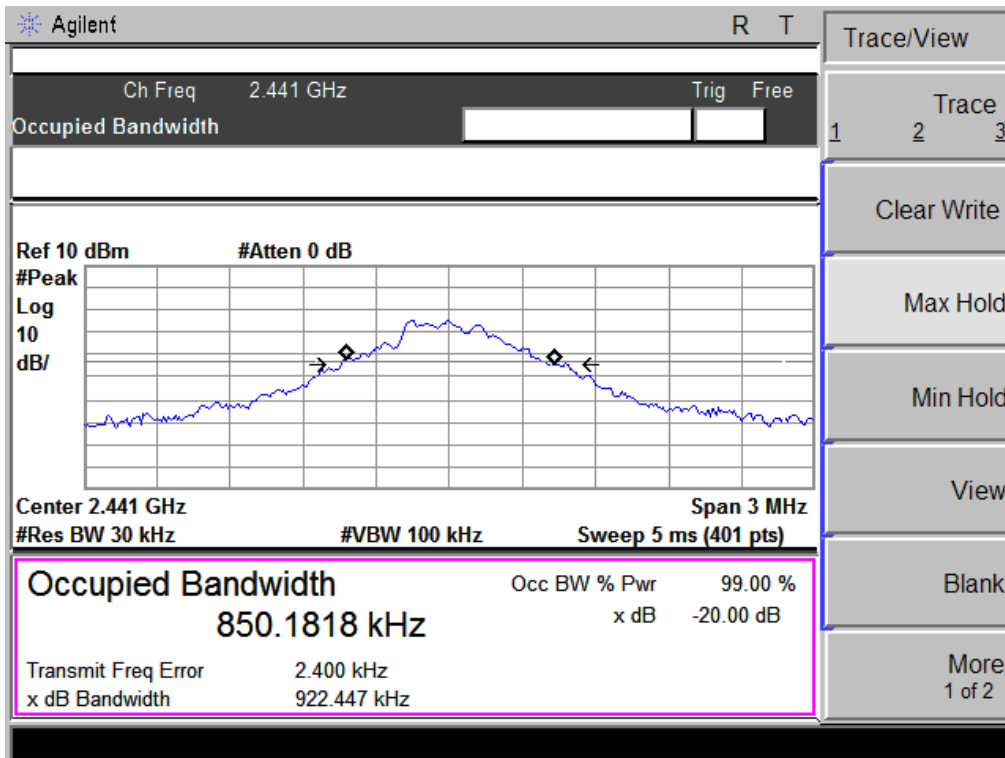

CH78 -1Mbps

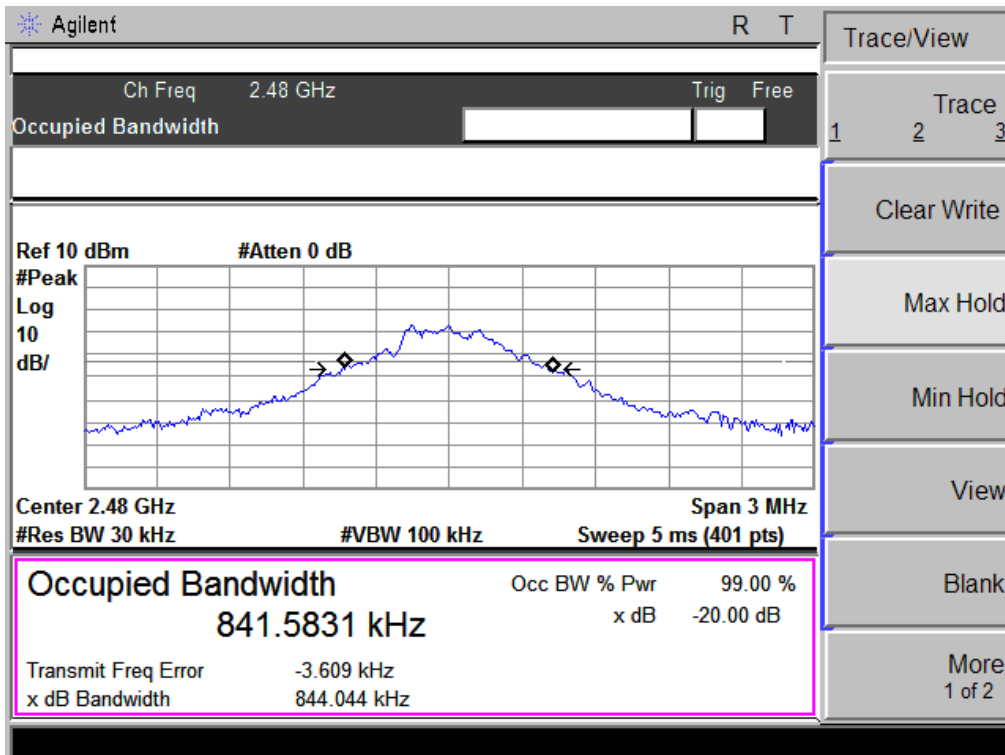

EUT :	SUBARU 13 Forester	Model Name :	75342
Temperature :	25 °C	Relative Humidity :	60%
Pressure :	1012 hPa	Test Voltage :	DC 12V
Test Mode :	CH00 / CH39 /C78(2Mbps)		

Frequency	20dB Bandwidth (kHz)	Result
2402 MHz	1.244	PASS
2441 MHz	1.259	PASS
2480 MHz	1.232	PASS

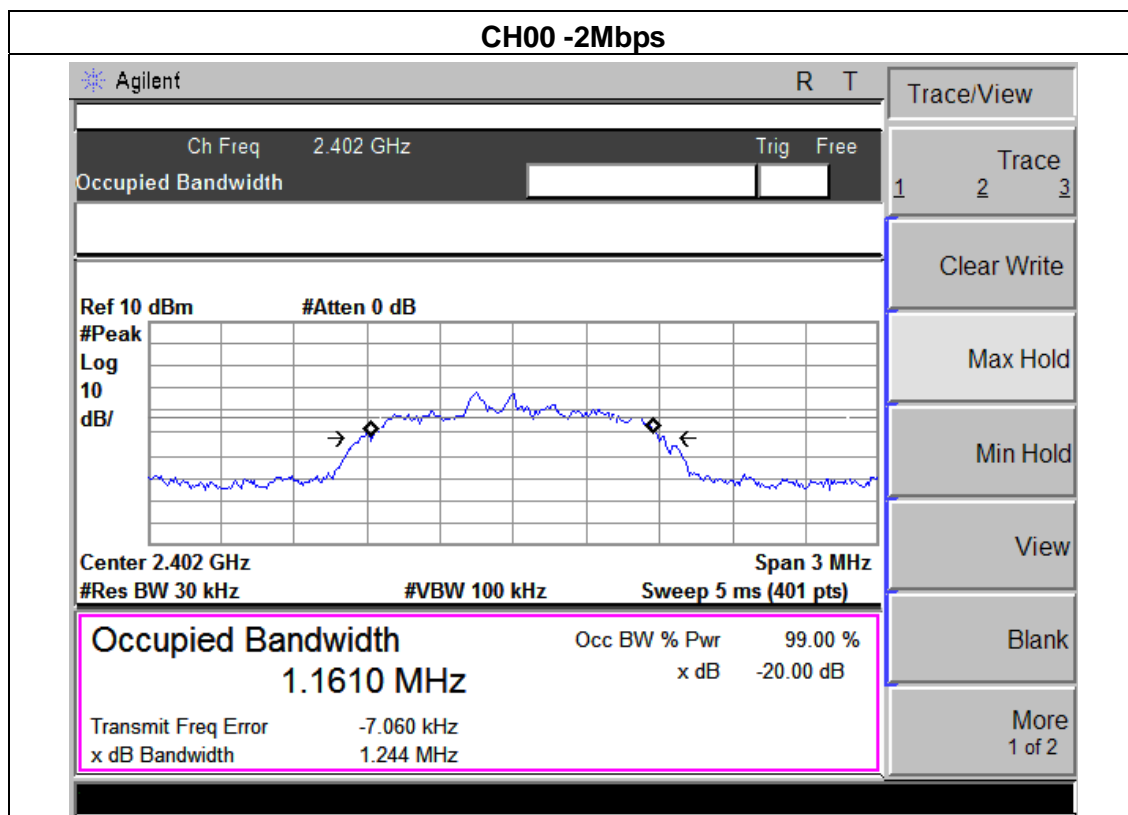

CH39 -2Mbps

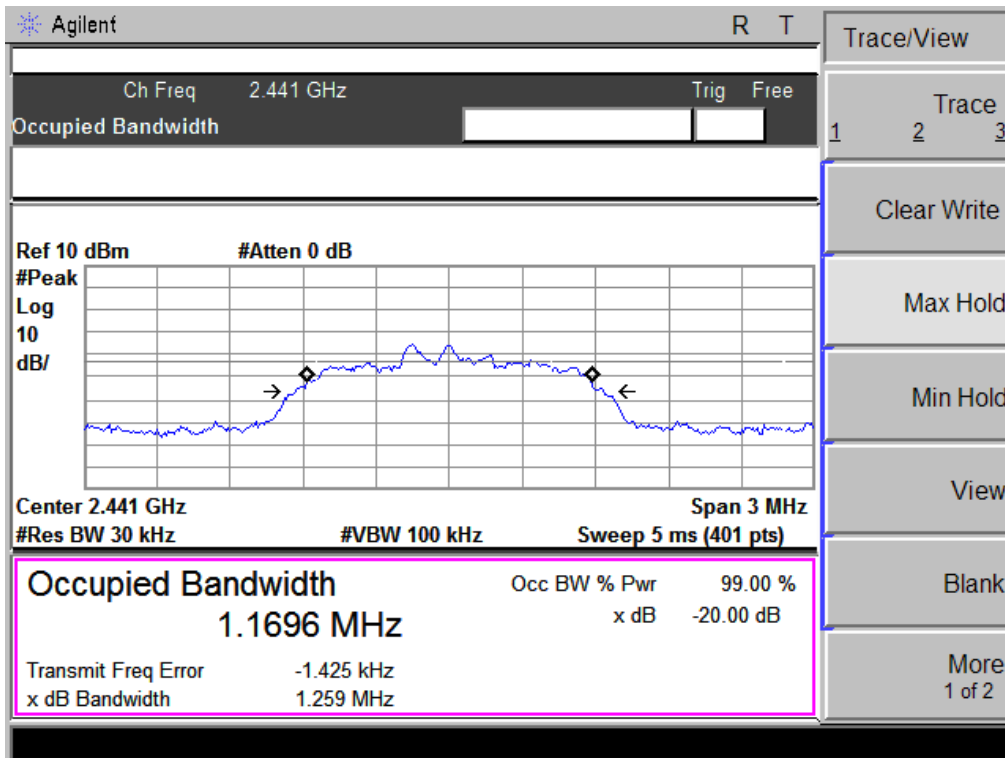

CH78 -2Mbps

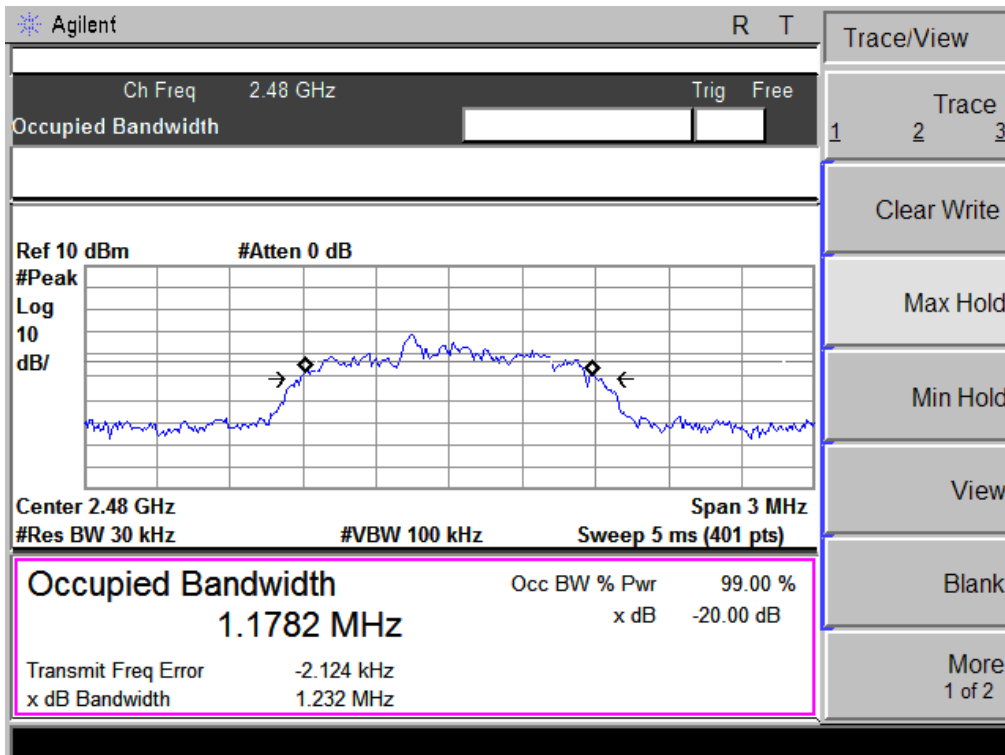

EUT :	SUBARU 13 Forester	Model Name :	75342
Temperature :	25 °C	Relative Humidity :	60%
Pressure :	1012 hPa	Test Voltage :	DC 12V
Test Mode :	CH00 / CH39 /C78(3Mbps)		

Frequency	20dB Bandwidth (kHz)	Result
2402 MHz	1.211	PASS
2441 MHz	1.184	PASS
2480 MHz	1.242	PASS

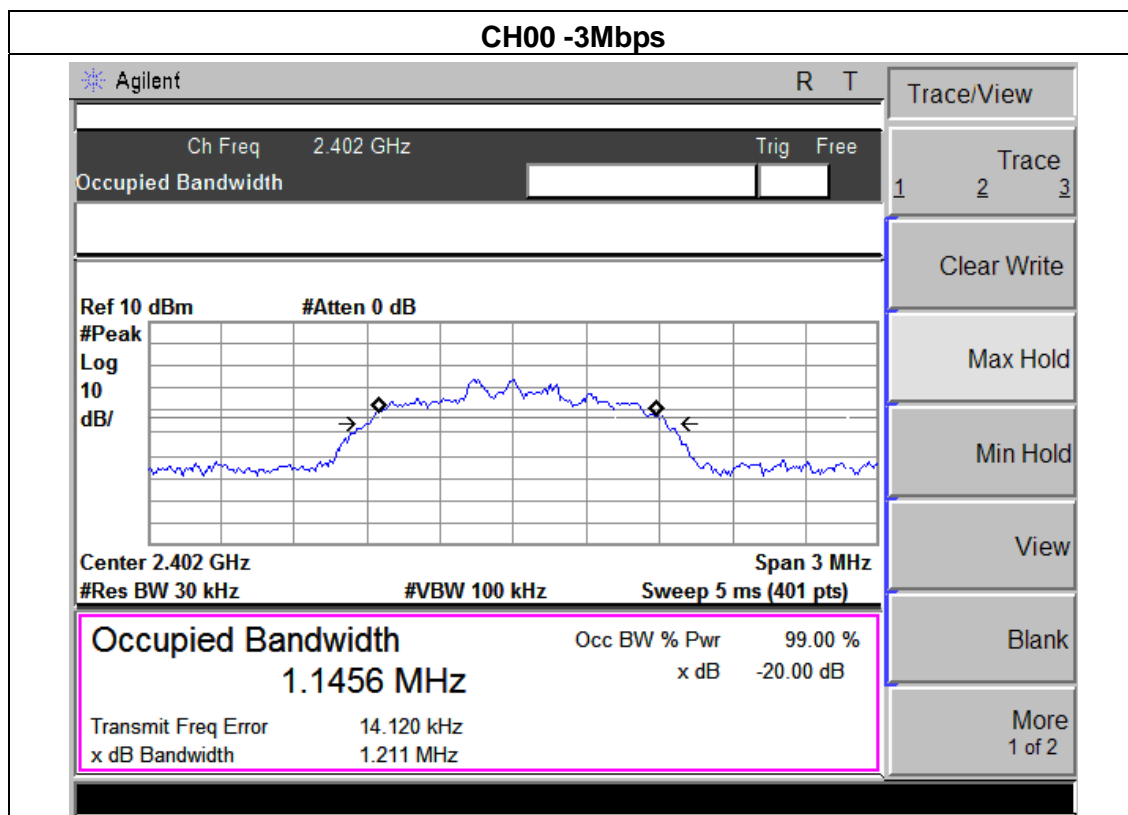

CH39 -3Mbps

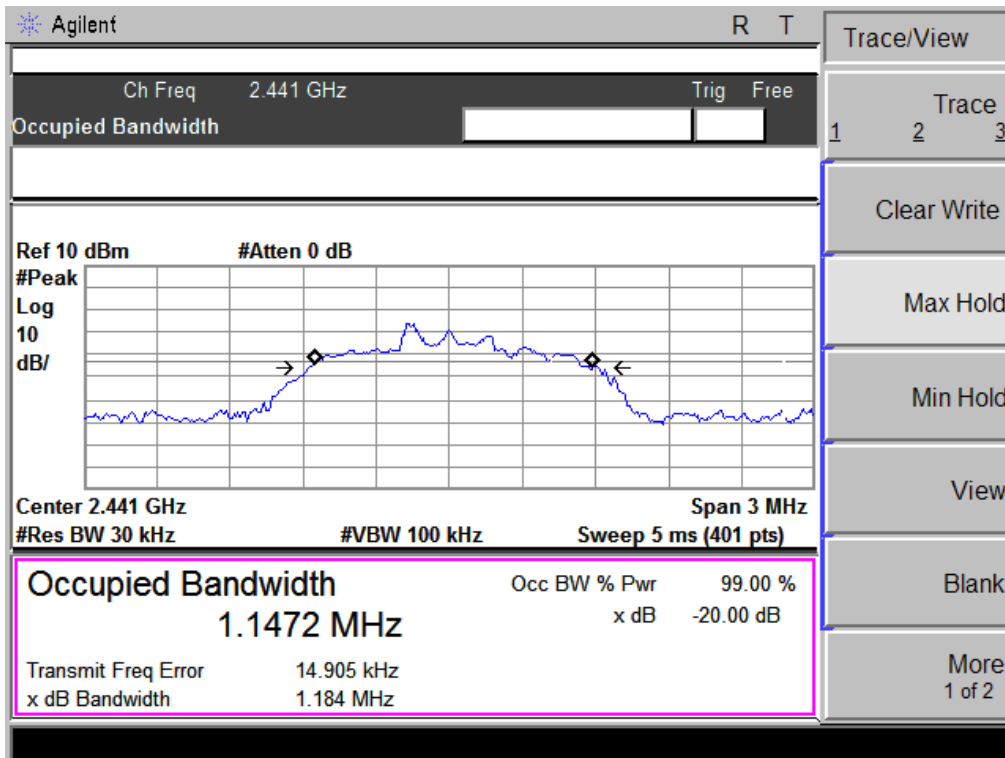

CH78 -3Mbps

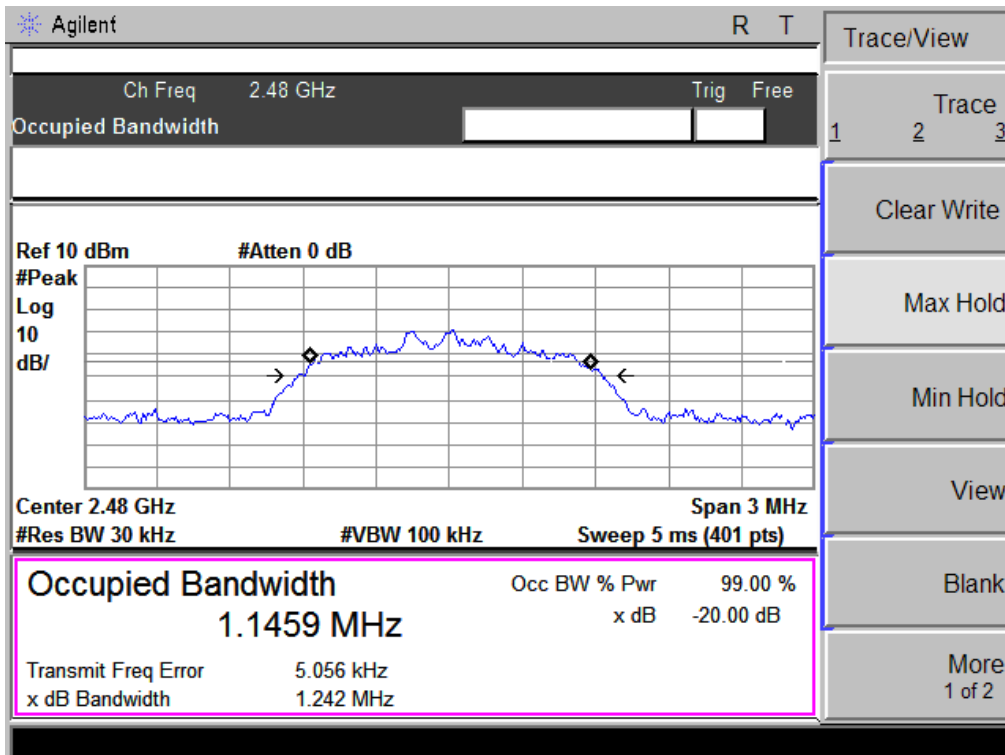

8. PEAK OUTPUT POWER TEST

8.1 APPLIED PROCEDURES / LIMIT

FCC Part15 (15.247) , Subpart C				
Section	Test Item	Limit	Frequency Range (MHz)	Result
15.247 (b)(i)	Peak Output Power	0.125 w or 20.96dBm	2400-2483.5	PASS

8.1.1 TEST PROCEDURE

- a. The EUT was directly connected to the spectrum analyzer and antenna output port as show in the block diagram below,
- b. Spectrum Setting : RBW > the 20 dB bandwidth of the emission being measured
 - Span = approximately 5 times the 20 dB bandwidth, centered on a hopping channel
 - VBW ≥ RBW
 - Sweep = auto
 - Detector function = peak
 - Trace = max hold

8.1.2 DEVIATION FROM STANDARD

No deviation.

8.1.3 TEST SETUP

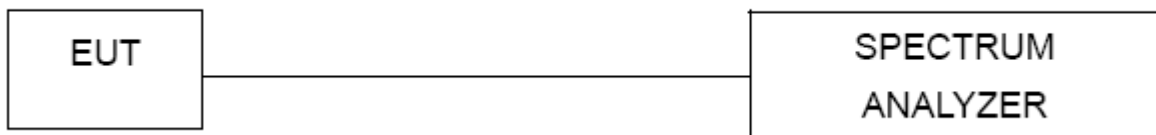

8.1.4 EUT OPERATION CONDITIONS

The EUT tested system was configured as the statements of 2.4 Unless otherwise a special operating condition is specified in the follows during the testing.

8.1.5 TEST RESULTS

EUT :	SUBARU 13 Forester	Model Name :	75342
Temperature :	25 °C	Relative Humidity :	60%
Pressure :	1012 hPa	Test Voltage :	DC 12V
Test Mode :	CH00/ CH39 /CH78 (1M/2M/3Mbps Mode)		

1Mbps			
Test Channel	Frequency (MHz)	Peak Output Power (dBm)	LIMIT (dBm)
CH00	2402	0.768	30
CH39	2441	-0.571	30
CH78	2480	1.011	30
2Mbps			
CH00	2402	-0.393	20.96
CH39	2441	-0.135	20.96
CH78	2480	-0.736	20.96
3Mbps			
CH00	2402	-0.415	20.96
CH39	2441	-0.363	20.96
CH78	2480	-0.591	20.96

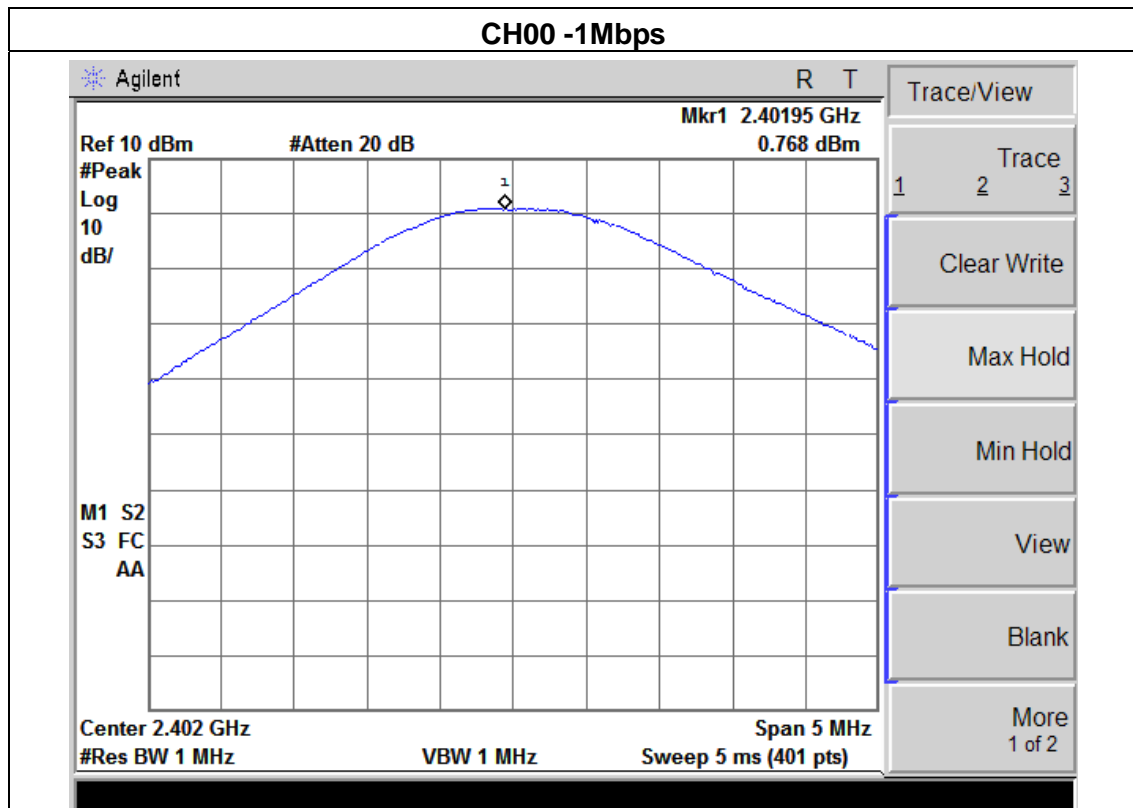

CH39 -1Mbps

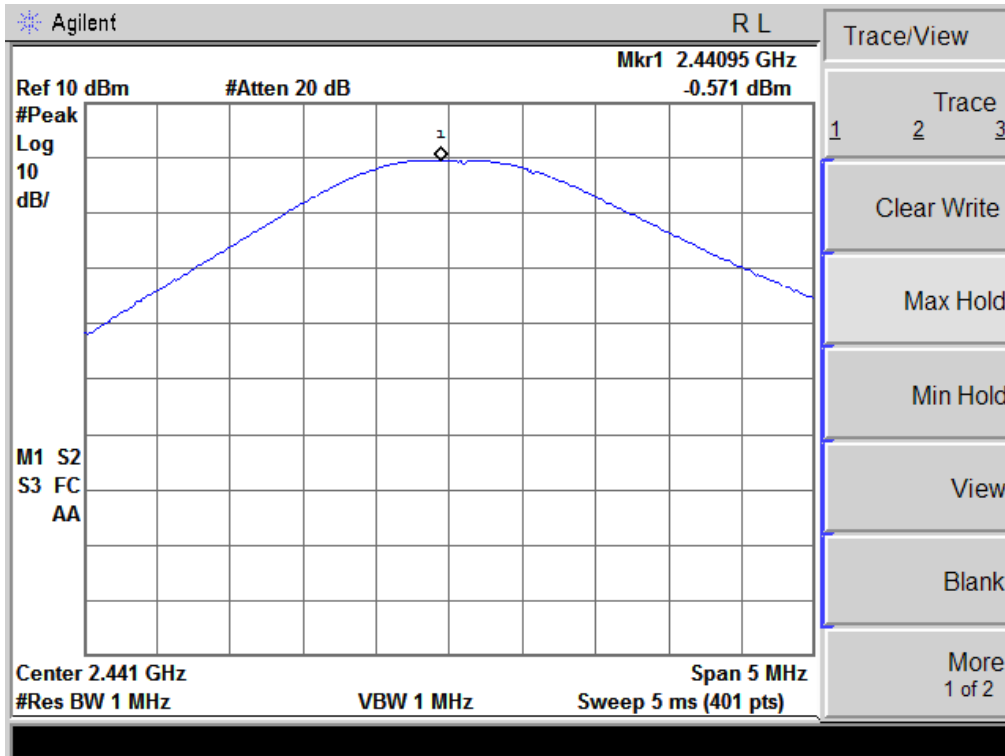

CH78 -1Mbps

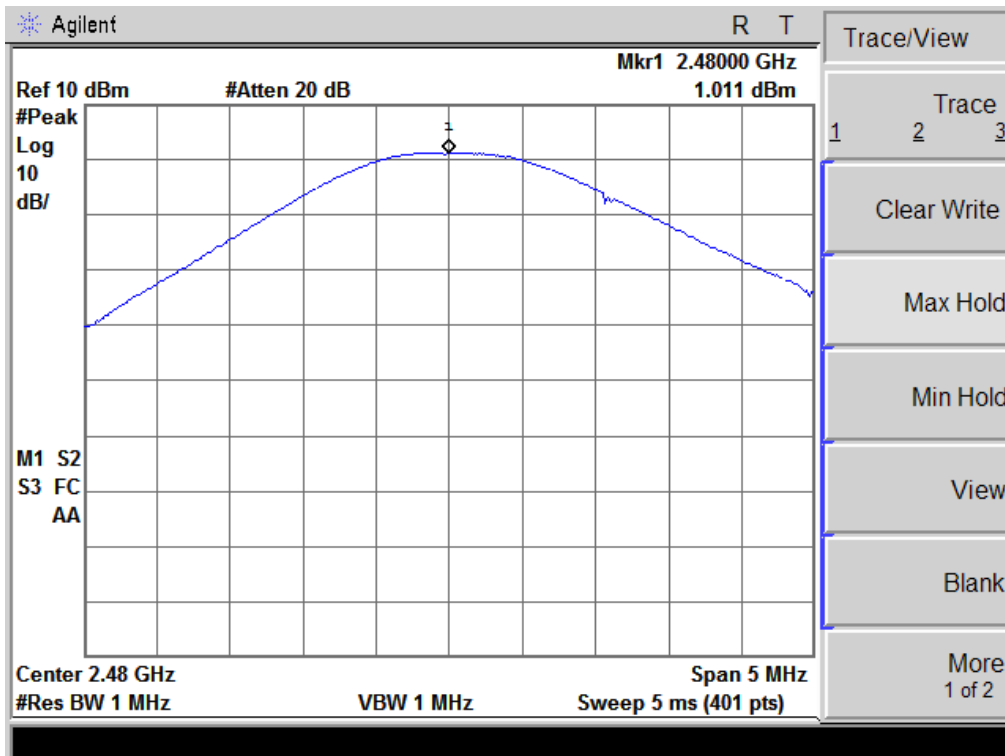

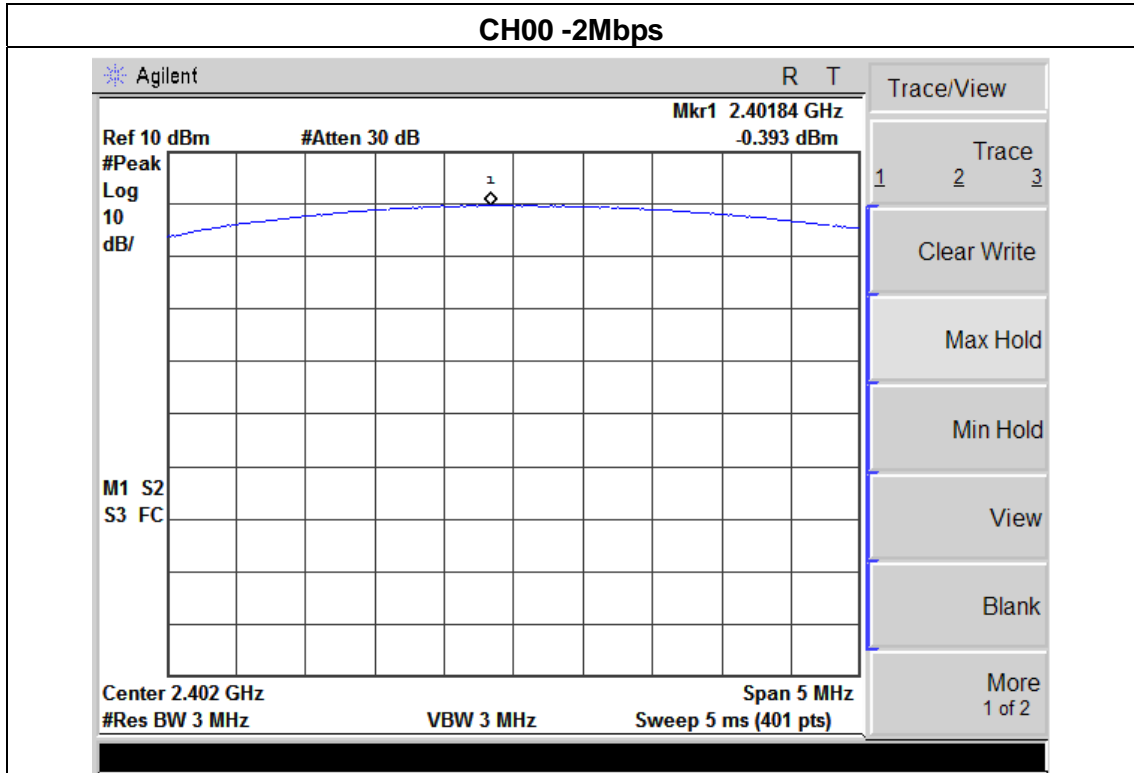

CH39 -2Mbps

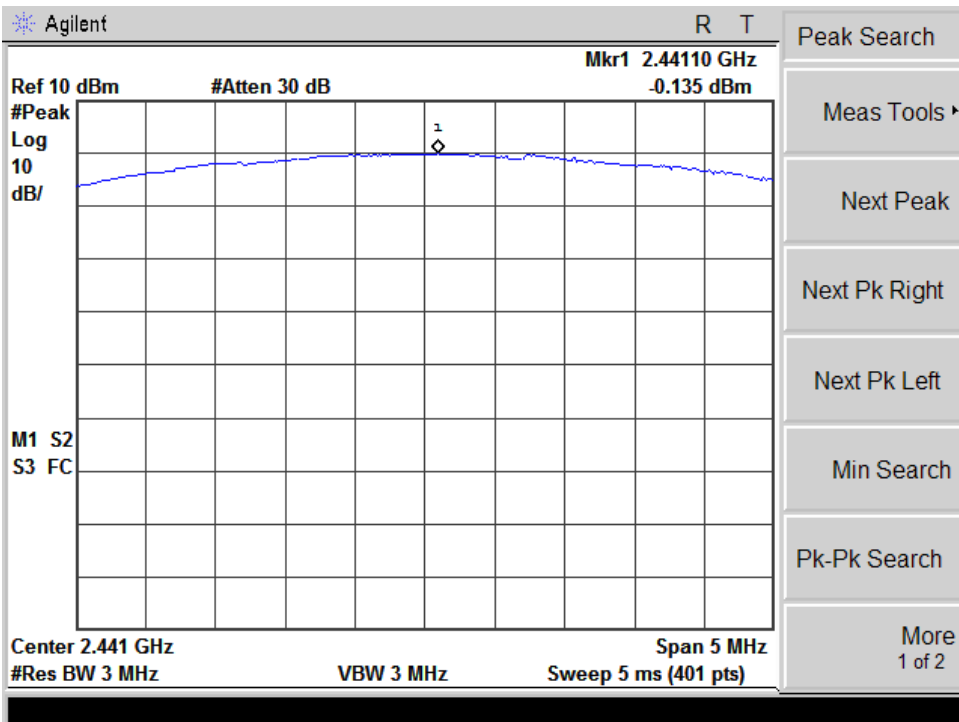

CH78 -2Mbps

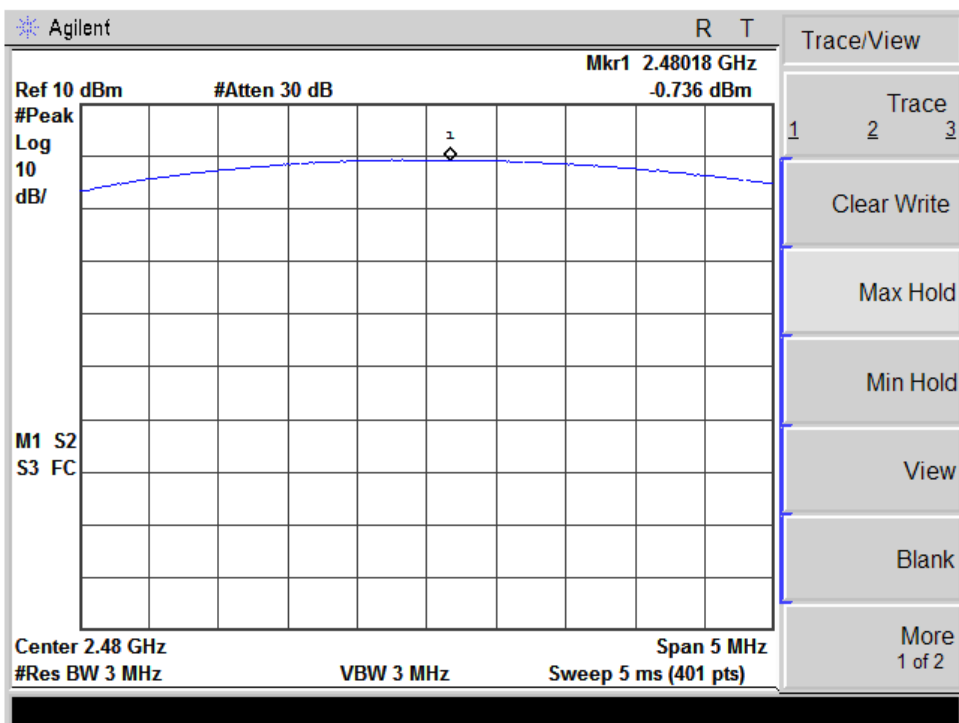

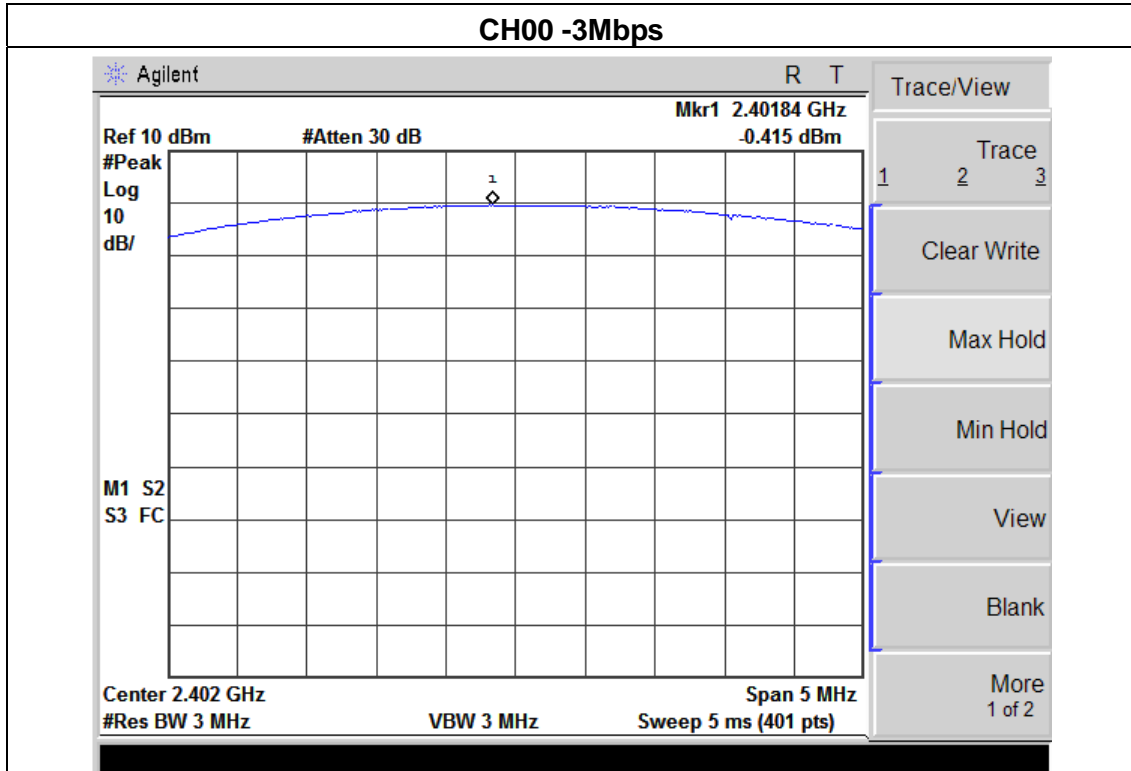

CH39 -3Mbps

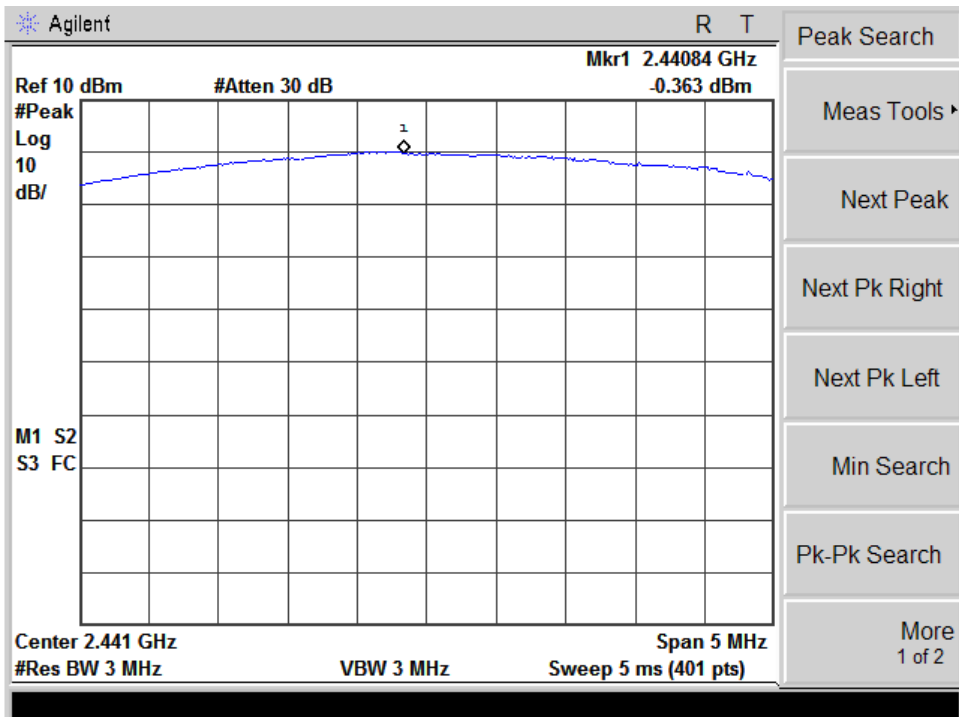

CH78 -3Mbps

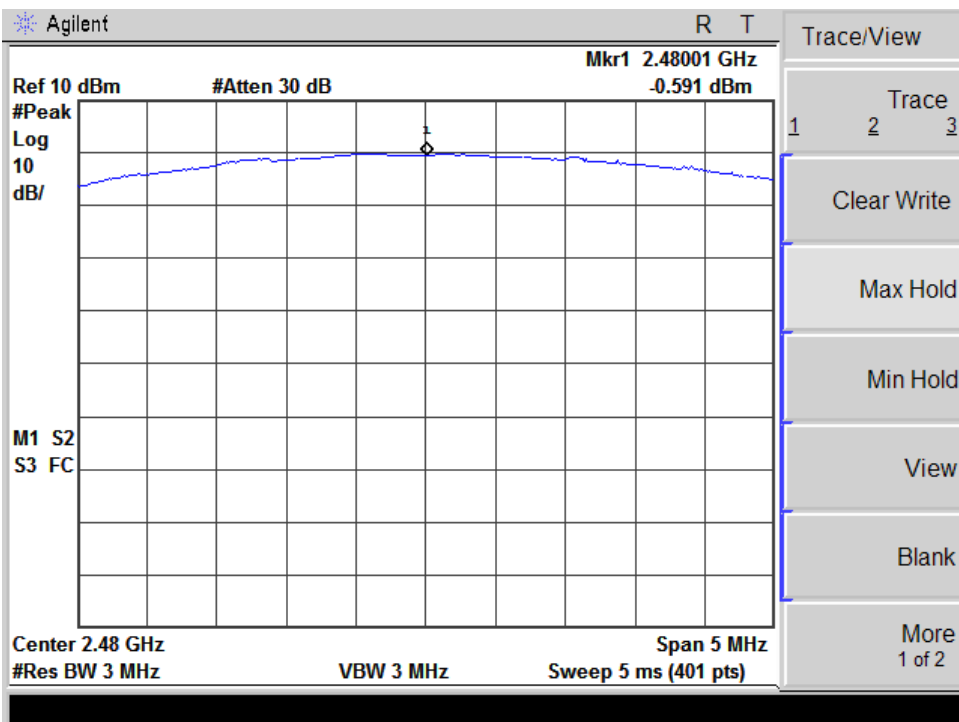

9. ANTENNA REQUIREMENT

9.1 STANDARD REQUIREMENT

15.203 requirement: For intentional device, according to 15.203: an intentional radiator shall be designed to ensure that no antenna other than that furnished by the responsible party shall be used with the device.

9.2 EUT ANTENNA

The EUT antenna is PCB antenna. It comply with the standard requirement.

10. EUT TEST PHOTO

Radiated Measurement Photos

