FCC Test Report

Report No.: AGC01559190708FE03

FCC ID : 2AANZVNYL
APPLICATION PURPOSE : Original Equipment
PRODUCT DESIGNATION : VINYL PRO WIRELESS HEADPHONES
BRAND NAME : HYPE
MODEL NAME : HY-VNYL, HY-VNYL-GLD, HY-VNYL-RSE, HY-VNYL-IRD,
HY-VNYL-SLV, HY-VNYL-ASST, HY-VNYL-XXX
APPLACANT : DGL Group LTD.
DATE OF ISSUE : July 29, 2019
STANDARD(S) : FCC Part 15.247
REPORT VERSION : V1.0

Attestation of Global Compliance (Shenzhen) Co., Ltd

CAUTION:

This report shall not be reproduced except in full without the written permission of the test laboratory and shall not be quoted out of context.

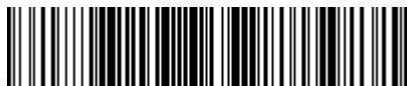

Attestation of Global Compliance(Shenzhen)Co.,Ltd.

Add: 2/F., Building 2, No.1-4, Chaxi Sanwei Technial Industrial Park, Gushu,
Xixiang, Bao'an District, Shenzhen, Guangdong, China

Tel: +86-755 2523 4088

E-mail: agc@agc-cert.com

Service Hotline:400 089 2118

REPORT REVISE RECORD

| Report Version | Revise Time | Issued Date | Valid Version | Notes |
|----------------|-------------|---------------|---------------|-----------------|
| V1.0 | / | July 29, 2019 | Valid | Initial Release |



Attestation of Global Compliance(Shenzhen)Co.,Ltd.

Add: 2/F., Building 2, No.1-4, Chaxi Sanwei Technial Industrial Park, Gushu,
Xixiang, Bao'an District, Shenzhen, Guangdong, China

Tel: +86-755 2523 4088

E-mail: agc@agc-cert.com

Service Hotline:400 089 2118

TABLE OF CONTENTS

| | |
|---|-----------|
| 1. VERIFICATION OF CONFORMITY | 5 |
| 2. GENERAL INFORMATION | 6 |
| 2.1. PRODUCT DESCRIPTION | 6 |
| 2.2. TABLE OF CARRIER FREQUENCIES | 6 |
| 2.3. RECEIVER INPUT BANDWIDTH | 7 |
| 2.4. EXAMPLE OF A HOPPING SEQUENCE IN DATA MODE | 7 |
| 2.5. EQUALLY AVERAGE USE OF FREQUENCIES AND BEHAVIOUR | 7 |
| 2.6. RELATED SUBMITTAL(S) / GRANT (S) | 8 |
| 2.7. TEST METHODOLOGY | 8 |
| 2.8. SPECIAL ACCESSORIES | 8 |
| 2.9. EQUIPMENT MODIFICATIONS | 8 |
| 3. MEASUREMENT UNCERTAINTY | 9 |
| 4. DESCRIPTION OF TEST MODES | 10 |
| 5. SYSTEM TEST CONFIGURATION | 11 |
| 5.1. CONFIGURATION OF EUT SYSTEM | 11 |
| 5.2. EQUIPMENT USED IN TESTED SYSTEM | 11 |
| 5.3. SUMMARY OF TEST RESULTS | 11 |
| 6. TEST FACILITY | 12 |
| 7. PEAK OUTPUT POWER | 13 |
| 7.1. MEASUREMENT PROCEDURE | 13 |
| 7.2. TEST SET-UP (BLOCK DIAGRAM OF CONFIGURATION) | 13 |
| 7.3. LIMITS AND MEASUREMENT RESULT | 14 |
| 8.1. MEASUREMENT PROCEDURE | 18 |
| 8.2. TEST SET-UP (BLOCK DIAGRAM OF CONFIGURATION) | 18 |
| 8.3. LIMITS AND MEASUREMENT RESULTS | 18 |
| 9. CONDUCTED SPURIOUS EMISSION | 23 |
| 9.1. MEASUREMENT PROCEDURE | 23 |
| 9.2. TEST SET-UP (BLOCK DIAGRAM OF CONFIGURATION) | 23 |
| 9.3. MEASUREMENT EQUIPMENT USED | 23 |



9.4. LIMITS AND MEASUREMENT RESULT 23

10. RADIATED EMISSION 31

10.1. MEASUREMENT PROCEDURE 31

10.2. TEST SETUP 33

10.3. LIMITS AND MEASUREMENT RESULT 34

10.4. TEST RESULT 34

11. NUMBER OF HOPPING FREQUENCY 44

11.1. MEASUREMENT PROCEDURE 44

11.2. TEST SETUP (BLOCK DIAGRAM OF CONFIGURATION)..... 44

11.3. MEASUREMENT EQUIPMENT USED 44

11.4. LIMITS AND MEASUREMENT RESULT 44

12. TIME OF OCCUPANCY (DWELL TIME) 45

12.1. MEASUREMENT PROCEDURE 45

12.2. TEST SETUP (BLOCK DIAGRAM OF CONFIGURATION)..... 45

12.3. MEASUREMENT EQUIPMENT USED 45

12.4. LIMITS AND MEASUREMENT RESULT 45

13. FREQUENCY SEPARATION 49

13.1. MEASUREMENT PROCEDURE 49

13.2. TEST SETUP (BLOCK DIAGRAM OF CONFIGURATION)..... 49

13.3. MEASUREMENT EQUIPMENT USED 49

13.4. LIMITS AND MEASUREMENT RESULT 49

14. FCC LINE CONDUCTED EMISSION TEST 50

14.1. LIMITS OF LINE CONDUCTED EMISSION TEST..... 50

14.2. BLOCK DIAGRAM OF LINE CONDUCTED EMISSION TEST 50

14.3. PRELIMINARY PROCEDURE OF LINE CONDUCTED EMISSION TEST..... 51

14.4. FINAL PROCEDURE OF LINE CONDUCTED EMISSION TEST 51

14.5. TEST RESULT OF LINE CONDUCTED EMISSION TEST 52

APPENDIX A: PHOTOGRAPHS OF TEST SETUP 54

APPENDIX B: PHOTOGRAPHS OF EUT 56





1. VERIFICATION OF CONFORMITY

| | |
|---------------------------------|---|
| Applicant | DGL Group LTD. |
| Address | 195 Raritan Center Parkway Edison, New Jersey United States 08837 |
| Manufacturer | DGL Group LTD. |
| Address | 195 Raritan Center Parkway Edison, New Jersey United States 08837 |
| Product Designation | VINYL PRO WIRELESS HEADPHONES |
| Brand Name | HYPE |
| Test Model | HY-VNYL |
| Series Model | HY-VNYL-GLD, HY-VNYL-RSE, HY-VNYL-IRD, HY-VNYL-SLV, HY-VNYL-ASST, HY-VNYL-XXX |
| Difference Description | All the same except for the model name and appearance color |
| Date of test | July 24, 2019 to July 29, 2019 |
| Deviation | None |
| Condition of Test Sample | Normal |
| Test Result | Pass |
| Report Template | AGCRT-US-BR/RF |

We hereby certify that:

The above equipment was tested by Attestation of Global Compliance (Shenzhen) Co., Ltd. The test data, data evaluation, test procedures, and equipment configurations shown in this report were made in accordance with the procedures given in ANSI C63.10 (2013) and the energy emitted by the sample EUT tested as described in this report is in compliance with radiated emission limits of FCC PART 15.247.

Tested By 
Thea Huang(Huang Qianqian) July 29, 2019

Reviewed By 
Max Zhang(Zhang Yi) July 29, 2019

Approved By 
Forrest Lei(Lei Yonggang)
Authorized Officer July 29, 2019



2. GENERAL INFORMATION

2.1. PRODUCT DESCRIPTION

The EUT is designed as “VINYL PRO WIRELESS HEADPHONES”. It is designed by way of utilizing the GFSK, Pi/4 DQPSK technology to achieve the system operation.

A major technical description of EUT is described as following

| | |
|--|--|
| Operation Frequency | 2.402 GHz to 2.480GHz |
| RF Output Power | 7.250dBm(Max) |
| Bluetooth Version | V5.0 |
| Modulation | BR <input checked="" type="checkbox"/> GFSK, EDR <input checked="" type="checkbox"/> π /4-DQPSK, <input type="checkbox"/> 8DPSK BLE <input type="checkbox"/> GFSK 1Mbps <input type="checkbox"/> GFSK 2Mbps |
| Number of channels | 79 |
| Hardware Version | Version.1.1 |
| Software Version | V1.1 |
| Antenna Designation | PCB Antenna(Comply with requirements of the FCC part 15.203) |
| Antenna Gain | 1.2dBi |
| Power Supply | DC 3.7V by battery or DC 5V by adapter |
| Note: 1.The USB port only used for charging and can't be used to transfer data with PC. 2.The EUT doesn't support 8DPSK and BLE. | |

2.2. TABLE OF CARRIER FREQUENCIES

| Frequency Band | Channel Number | Frequency |
|----------------|----------------|-----------|
| 2402~2480MHZ | 0 | 2402MHZ |
| | 1 | 2403MHZ |
| | : | : |
| | 38 | 2440 MHZ |
| | 39 | 2441 MHZ |
| | 40 | 2442 MHZ |
| | : | : |
| | 77 | 2479 MHZ |
| | 78 | 2480 MHZ |



Attestation of Global Compliance(Shenzhen)Co.,Ltd.

Add: 2/F., Building 2, No.1-4, Chaxi Sanwei Technical Industrial Park, Gushu,
Xixiang, Bao'an District, Shenzhen, Guangdong, China

Tel: +86-755 2523 4088

E-mail: agc@agc-cert.com

Service Hotline:400 089 2118

2.3. RECEIVER INPUT BANDWIDTH

The input bandwidth of the receiver is 1.3MHz. In every connection one Bluetooth device is the master and the other one is slave. The master determines the hopping sequence. The slave follows this sequence. Both devices shift between RX and TX time slot according to the clock of the master. Additionally the type of connection (e.g. single or multislot packet) is set up at the beginning of the connection. The master adapts its hopping frequency and its TX/RX timing according to the packet type of the connection. Also the slave of the connection will use these settings.

Repeating of a packet has no influence on the hopping sequence. The hopping sequence generated by the master of the connection will be followed in any case. That means, a repeated packet will not be sent on the same frequency, it is sent on the next frequency of the hopping sequence.

2.4. EXAMPLE OF A HOPPING SEQUENCE IN DATA MODE

Example of a 79 hopping sequence in data mode:

40,21,44,23,42,53,46,55,48,33,52,35,50,65,54,67
56,37,60,39,58,69,62,71,64,25,68,27,66,57,70,59
72,29,76,31,74,61,78,63,01,41,05,43,03,73,07,75
09,45,13,47,11,77,15,00,64,49,66,53,68,02,70,06
01, 51, 03, 55, 05, 04

2.5. EQUALLY AVERAGE USE OF FREQUENCIES AND BEHAVIOUR

The generation of the hopping sequence in connection mode depends essentially on two input values:

1. LAP/UAP of the master of the connection.
2. Internal master clock

The LAP (lower address part) are the 24 LSB's of the 48 BD_ADDRESS. The BD_ADDRESS is an unambiguous number of every Bluetooth unit. The UAP (upper address part) are the 24 MSB's of the 48 BD_ADDRESS.

The internal clock of a Bluetooth unit is derived from a free running clock which is never adjusted and is never turned off. For synchronization with other units only offsets are used. It has no relation to the time of the day. Its resolution is at least half the RX/TX slot length of 312.5us. The clock has a cycle of about one day (23h30). In most cases it is implemented as a 28-bit counter. For the deriving of the hopping sequence the entire LAP (24 bits), 4 LSB's (4 bits) (Input 1) and the 27 MSB's of the clock (Input 2) are used. With these input values different mathematical procedures (permutations, additions, XOR-operations) are performed to generate the sequence. This will be done at the beginning of every new transmission.

Regarding short transmissions the Bluetooth system has the following behavior:

The first connection between the two devices is established, a hopping sequence was generated. For transmitting the wanted data the complete hopping sequence was not used. The connection ended.

The second connection will be established. A new hopping sequence is generated. Due to the fact the Bluetooth clock has a different value, because the period between the two transmissions is longer (and it cannot be shorter) than the minimum resolution of the clock (312.5us). The hopping sequence will always differ from the first one.



2.6. RELATED SUBMITTAL(S) / GRANT (S)

This submittal(s) (test report) is intended for **FCC ID: 2AANZVNYL** filing to comply with the FCC PART 15.247 requirements.

2.7. TEST METHODOLOGY

Both conducted and radiated testing was performed according to the procedures in ANSI C63.10 (2013). Radiated testing was performed at an antenna to EUT distance 3 meters.

2.8. SPECIAL ACCESSORIES

Refer to section 5.2.

2.9. EQUIPMENT MODIFICATIONS

Not available for this EUT intended for grant.



Attestation of Global Compliance(Shenzhen)Co.,Ltd.

Add: 2/F., Building 2, No.1-4, Chaxi Sanwei Technial Industrial Park, Gushu,
Xixiang, Bao'an District, Shenzhen, Guangdong, China

Tel: +86-755 2523 4088

E-mail: agc@agc-cert.com

Service Hotline:400 089 2118

3. MEASUREMENT UNCERTAINTY

The reported uncertainty of measurement $y \pm U$, where expanded uncertainty U is based on a standard uncertainty multiplied by a coverage factor of $k=2$, providing a level of confidence of approximately 95%.

- Uncertainty of Conducted Emission, $U_c = \pm 3.2$ dB
- Uncertainty of Radiated Emission below 1GHz, $U_c = \pm 3.9$ dB
- Uncertainty of Radiated Emission above 1GHz, $U_c = \pm 4.8$ dB
- Uncertainty of total RF power, conducted, $U_c = \pm 0.8$ dB
- Uncertainty of spurious emissions, conducted, $U_c = \pm 2.7$ dB
- Uncertainty of Occupied Channel Bandwidth: $U_c = \pm 2$ %
- Uncertainty of Dwell Time: $U_c = \pm 2$ %
- Uncertainty of Frequency: $U_c = \pm 2$ %



Attestation of Global Compliance(Shenzhen)Co.,Ltd.

Add: 2/F., Building 2, No.1-4, Chaxi Sanwei Technial Industrial Park, Gushu,
Xixiang, Bao'an District, Shenzhen, Guangdong, China

Tel: +86-755 2523 4088

E-mail: agc@agc-cert.com

Service Hotline:400 089 2118

4. DESCRIPTION OF TEST MODES

| NO. | TEST MODE DESCRIPTION |
|-----|-------------------------------|
| 1 | Low channel GFSK |
| 2 | Middle channel GFSK |
| 3 | High channel GFSK |
| 4 | Low channel $\pi/4$ -DQPSK |
| 5 | Middle channel $\pi/4$ -DQPSK |
| 6 | High channel $\pi/4$ -DQPSK |
| 7 | Hopping mode GFSK |
| 8 | Hopping mode $\pi/4$ -DQPSK |

- Note: 1. Only the result of the worst case was recorded in the report, if no other cases.
 2. For Radiated Emission, 3axis were chosen for testing for each applicable mode.
 3. For Conducted Test method, a temporary antenna connector is provided by the manufacture.

Software Setting

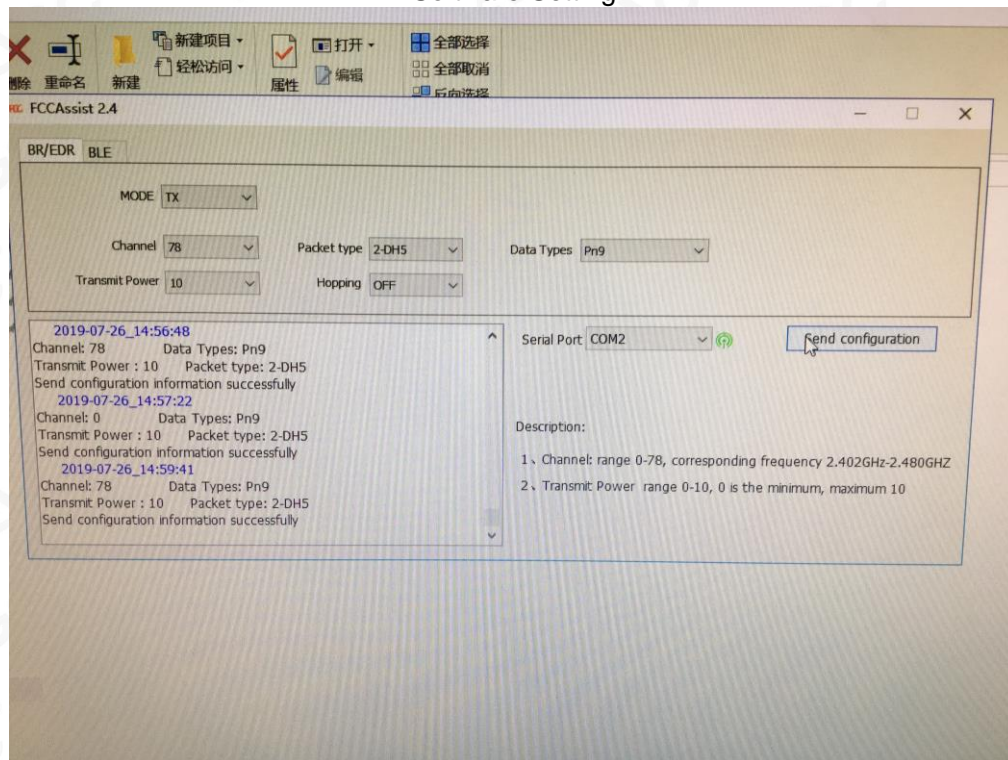

Attestation of Global Compliance(Shenzhen)Co.,Ltd.

Add: 2/F., Building 2, No.1-4, Chaxi Sanwei Technial Industrial Park, Gushu, Xixiang, Bao'an District, Shenzhen, Guangdong, China

Tel: +86-755 2523 4088 E-mail: agc@agc-cert.com Service Hotline:400 089 2118

5. SYSTEM TEST CONFIGURATION

5.1. CONFIGURATION OF EUT SYSTEM

Radiated Emission Configure :

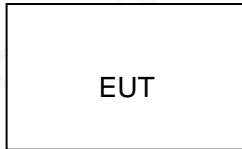

Conducted Emission Configure :

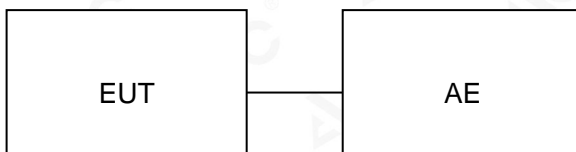

5.2 EQUIPMENT USED IN TESTED SYSTEM

| Item | Equipment | Model No. | ID or Specification | Remark |
|------|-------------------------------|-----------|---------------------|-----------|
| 1 | VINYL PRO WIRELESS HEADPHONES | HY-VNYL | 2AANZVNYL | EUT |
| 2 | Adapter | FY0502000 | DC 5V/2A | AE |
| 3 | USB Cable | N/A | 0.3m unshielded | Accessory |

5.3. SUMMARY OF TEST RESULTS

| FCC RULES | DESCRIPTION OF TEST | RESULT |
|--------------------|-----------------------------|-----------|
| 15.247 (b)(1) | Peak Output Power | Compliant |
| 15.247 (a)(1) | 20 dB Bandwidth | Compliant |
| 15.247 (d) | Conducted Spurious Emission | Compliant |
| 15.209 | Radiated Emission | Compliant |
| 15.247 (a)(1)(iii) | Number of Hopping Frequency | Compliant |
| 15.247 (a)(1)(iii) | Time of Occupancy | Compliant |
| 15.247 (a)(1) | Frequency Separation | Compliant |
| 15.207 | Conducted Emission | Compliant |



Attestation of Global Compliance(Shenzhen)Co.,Ltd.

Add: 2/F., Building 2, No.1-4, Chaxi Sanwei Technial Industrial Park, Gushu, Xixiang, Bao'an District, Shenzhen, Guangdong, China

Tel: +86-755 2523 4088 E-mail: agc@agc-cert.com Service Hotline:400 089 2118

6. TEST FACILITY

| | |
|--|--|
| Test Site | Attestation of Global Compliance (Shenzhen) Co., Ltd |
| Location | 1-2/F, Building 19, Junfeng Industrial Park, Chongqing Road, Heping Community, Fuhai Street, Bao'an District, Shenzhen, Guangdong, China |
| Designation Number | CN1259 |
| FCC Test Firm Registration Number | 975832 |
| A2LA Cert. No. | 5054.02 |
| Description | Attestation of Global Compliance(Shenzhen) Co., Ltd is accredited by A2LA |

TEST EQUIPMENT OF CONDUCTED EMISSION TEST

| Equipment | Manufacturer | Model | S/N | Cal. Date | Cal. Due |
|---------------|--------------|---------|--------|---------------|---------------|
| TEST RECEIVER | R&S | ESPI | 101206 | Jun. 12, 2019 | Jun. 11, 2020 |
| LISN | R&S | ESH2-Z5 | 100086 | Aug. 28, 2018 | Aug. 27, 2019 |

TEST EQUIPMENT OF RADIATED EMISSION TEST

| Equipment | Manufacturer | Model | S/N | Cal. Date | Cal. Due |
|--------------------------------|----------------|--------------|------------|---------------|---------------|
| TEST RECEIVER | R&S | ESCI | 10096 | Jun. 12, 2019 | Jun. 26, 2020 |
| EXA Signal Analyzer | Aglient | N9010A | MY53470504 | Dec. 20, 2018 | Dec. 19, 2019 |
| 2.4GHz Fliter | EM Electronics | 2400-2500MHz | N/A | Feb. 27, 2019 | Feb. 26, 2020 |
| Attenuator | ZHINAN | E-002 | N/A | Aug. 28, 2018 | Aug. 27, 2019 |
| Horn antenna | SCHWARZBECK | BBHA 9170 | #768 | Jun. 12, 2019 | Jun. 26, 2020 |
| Active loop antenna (9K-30MHz) | ZHINAN | ZN30900C | 18051 | Jun. 14, 2018 | Jun. 13, 2020 |
| Double-Ridged Waveguide Horn | ETS LINDGREN | 3117 | 00034609 | May. 26, 2018 | May. 25, 2020 |
| Broadband Preamplifier | ETS LINDGREN | 3117PA | 00225134 | Oct. 25, 2018 | Oct. 24, 2019 |
| ANTENNA | SCHWARZBECK | VULB9168 | D69250 | Sep. 28, 2017 | Sep. 27, 2019 |



7. PEAK OUTPUT POWER

7.1. MEASUREMENT PROCEDURE

For peak power test:

1. Connect EUT RF output port to the Spectrum Analyzer through an RF attenuator
2. Span: Approximately five times the 20 dB bandwidth, centered on a hopping channel.
3. RBW > 20 dB bandwidth of the emission being measured.
4. VBW \geq RBW.
5. Sweep: Auto.
6. Detector function: Peak.
7. Trace: Max hold.

Allow trace to stabilize. Use the marker-to-peak function to set the marker to the peak of the emission. The indicated level is the peak output power, after any corrections for external attenuators and cables.

7.2. TEST SET-UP (BLOCK DIAGRAM OF CONFIGURATION)

PEAK POWER TEST SETUP

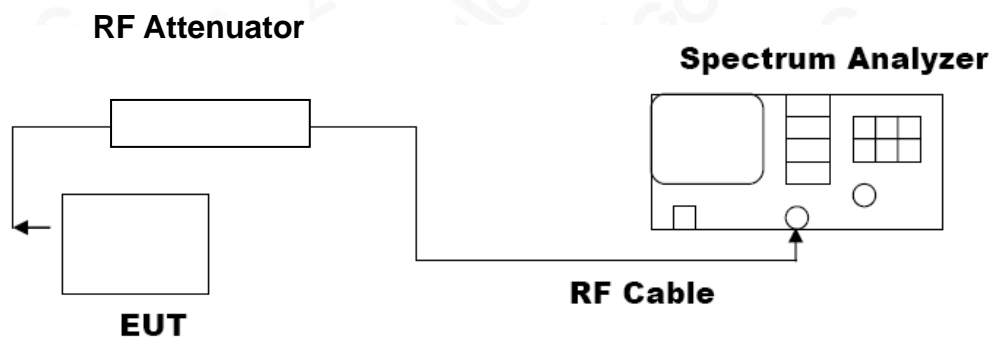

7.3. LIMITS AND MEASUREMENT RESULT

| PEAK OUTPUT POWER MEASUREMENT RESULT FOR GFSK MODULATION | | | |
|--|------------------|-------------------------|--------------|
| Frequency (GHz) | Peak Power (dBm) | Applicable Limits (dBm) | Pass or Fail |
| 2.402 | 6.528 | 30 | Pass |
| 2.441 | 6.730 | 30 | Pass |
| 2.480 | 6.763 | 30 | Pass |

CH0

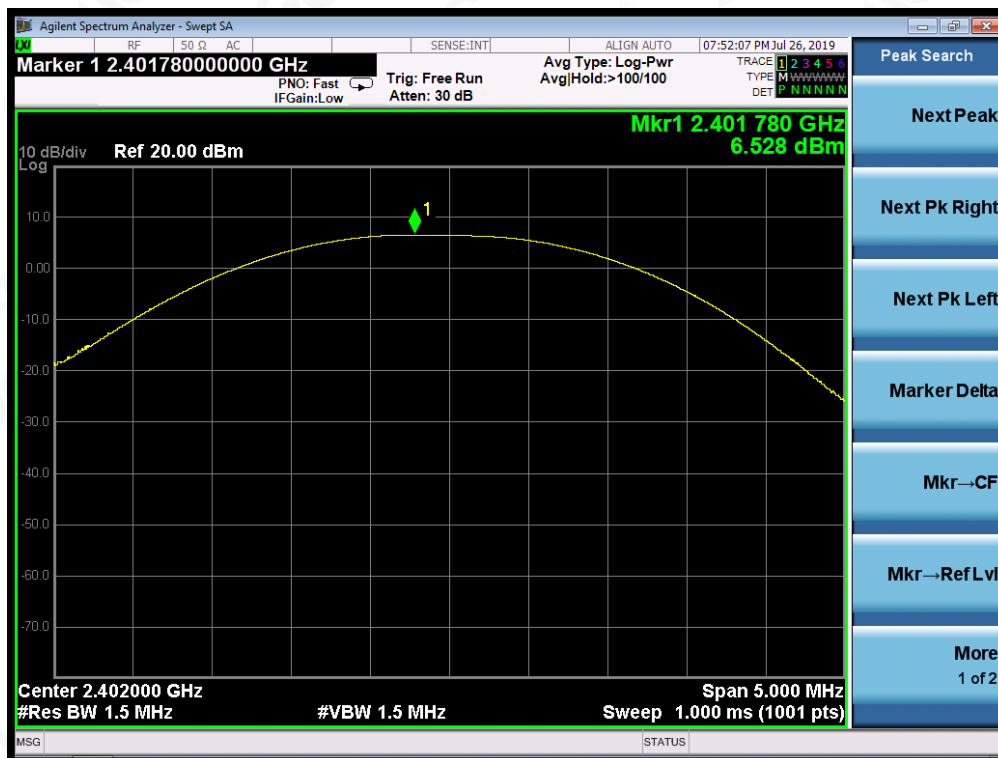

Attestation of Global Compliance(Shenzhen)Co.,Ltd.

Add: 2/F., Building 2, No.1-4, Chaxi Sanwei Technical Industrial Park, Gushu, Xixiang, Bao'an District, Shenzhen, Guangdong, China
Tel: +86-755 2523 4088 E-mail: agc@agc-cert.com Service Hotline:400 089 2118

CH39



CH78

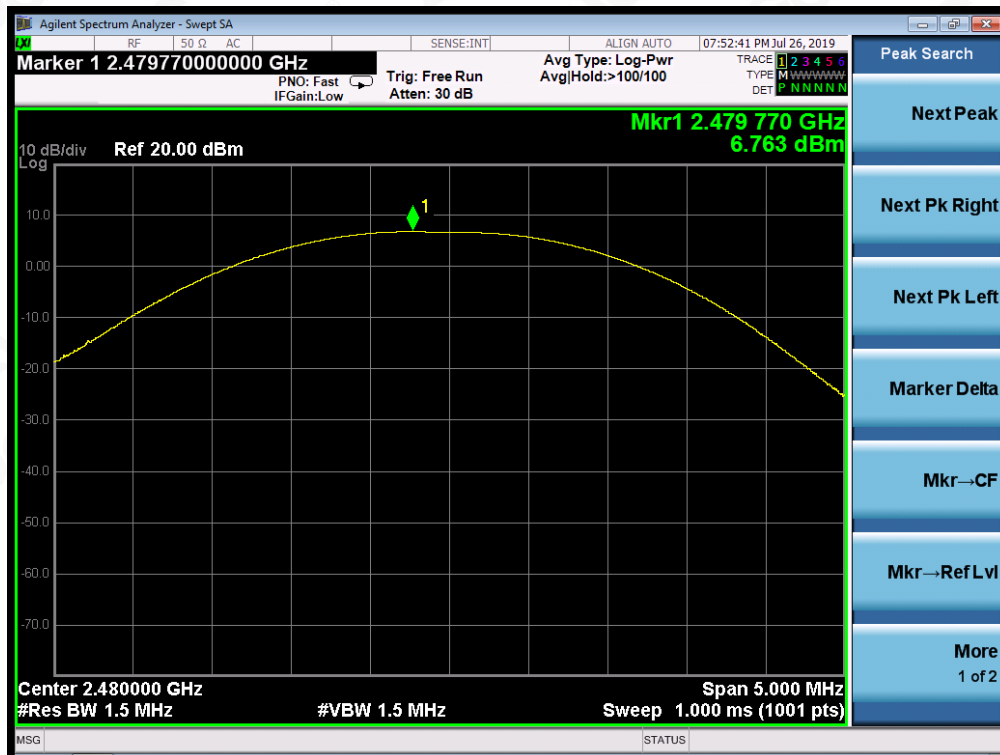

Attestation of Global Compliance(Shenzhen)Co.,Ltd.

Add: 2/F., Building 2, No.1-4, Chaxi Sanwei Technical Industrial Park, Gushu,
Xixiang, Bao'an District, Shenzhen, Guangdong, China

Tel: +86-755 2523 4088

E-mail: agc@agc-cert.com

Service Hotline:400 089 2118

| PEAK OUTPUT POWER MEASUREMENT RESULT FOR $\Pi/4$ -DQPSK MODULATION | | | |
|---|------------------|-------------------------|--------------|
| Frequency (GHz) | Peak Power (dBm) | Applicable Limits (dBm) | Pass or Fail |
| 2.402 | 7.021 | 30 | Pass |
| 2.441 | 7.219 | 30 | Pass |
| 2.480 | 7.250 | 30 | Pass |

CH0

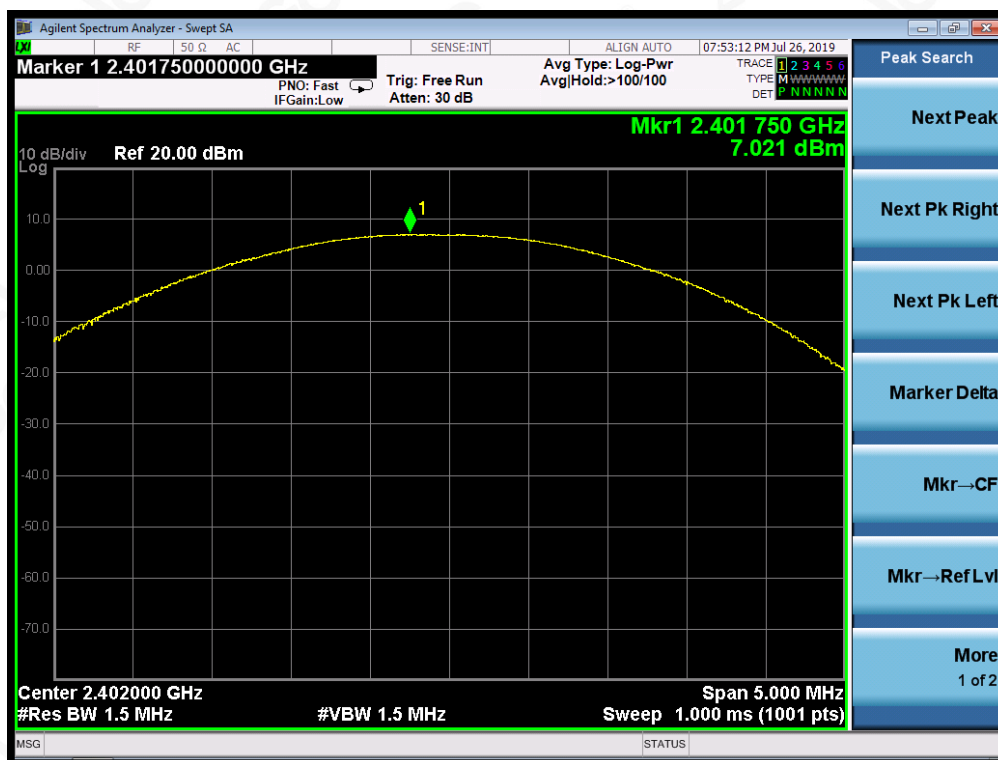

Attestation of Global Compliance(Shenzhen)Co.,Ltd.

Add: 2/F., Building 2, No.1-4, Chaxi Sanwei Technical Industrial Park, Gushu,
Xixiang, Bao'an District, Shenzhen, Guangdong, China
Tel: +86-755 2523 4088 E-mail: agc@agc-cert.com Service Hotline:400 089 2118

CH39

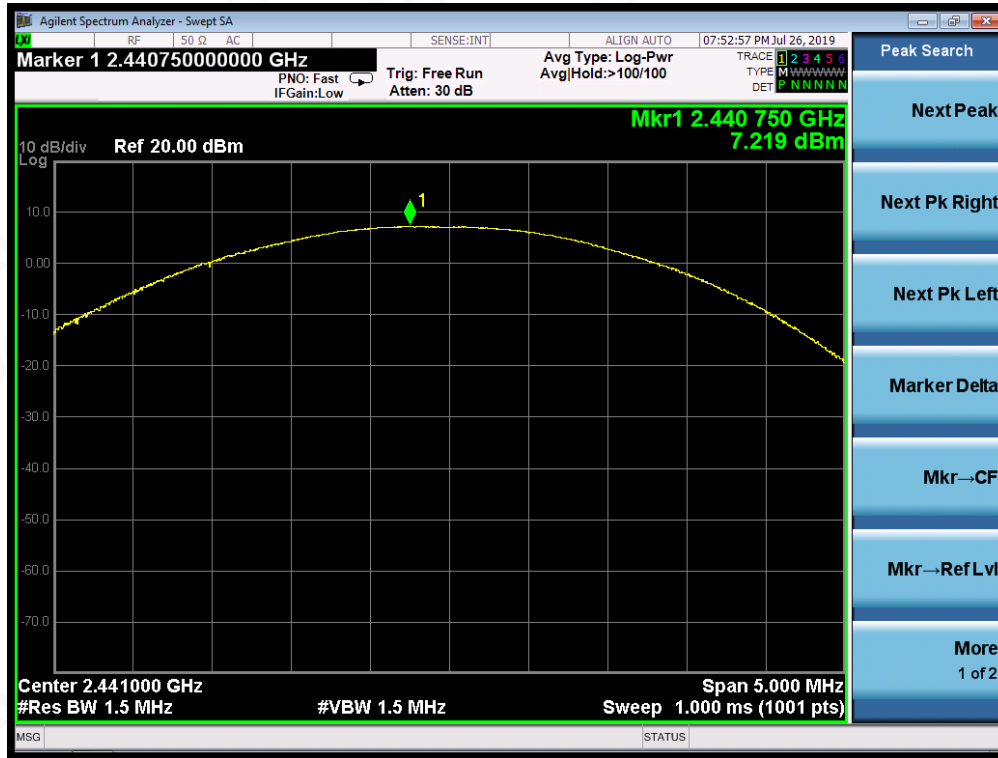

CH78



Attestation of Global Compliance(Shenzhen)Co.,Ltd.

Add: 2/F., Building 2, No.1-4, Chaxi Sanwei Technial Industrial Park, Gushu, Xixiang, Bao'an District, Shenzhen, Guangdong, China

Tel: +86-755 2523 4088

E-mail: agc@agc-cert.com

Service Hotline:400 089 2118

8. 20DB BANDWIDTH

8.1. MEASUREMENT PROCEDURE

1. Connect EUT RF output port to the Spectrum Analyzer through an RF attenuator
2. Set the EUT Work on the top, the middle and the bottom operation frequency individually.
3. Set Span = approximately 2 to 5 times the 20 dB bandwidth, centered on a hopping channel
The nominal IF filter bandwidth (3 dB RBW) shall be in the range of 1% to 5% of the OBW and video bandwidth (VBW) shall be approximately three times RBW; Sweep = auto; Detector function = peak
4. Set SPA Trace 1 Max hold, then View.

8.2. TEST SET-UP (BLOCK DIAGRAM OF CONFIGURATION)

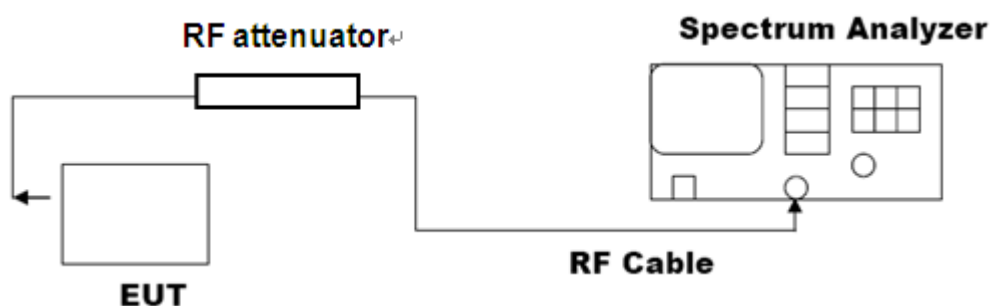

8.3. LIMITS AND MEASUREMENT RESULTS

| MEASUREMENT RESULT FOR GFSK MODULATION | | | |
|--|--------------------|--------|----------|
| Applicable Limits | Measurement Result | | |
| | Test Data (MHz) | | Criteria |
| N/A | Low Channel | 0.9483 | PASS |
| | Middle Channel | 0.9450 | PASS |
| | High Channel | 0.9445 | PASS |



TEST PLOT OF BANDWIDTH FOR LOW CHANNEL

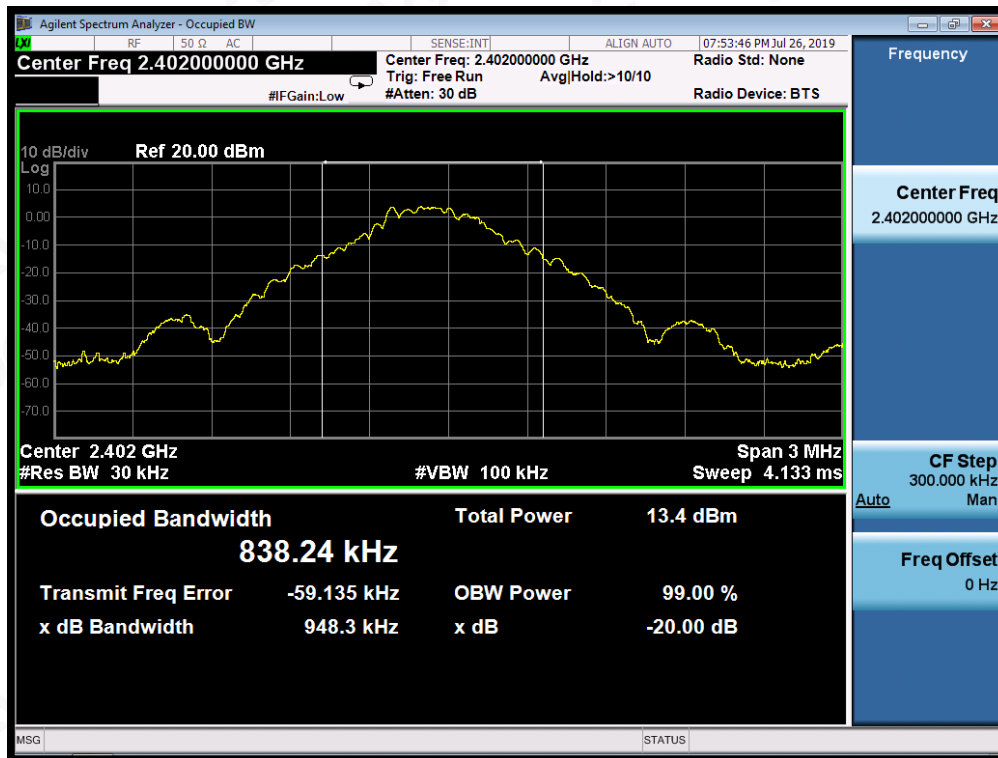

TEST PLOT OF BANDWIDTH FOR MIDDLE CHANNEL

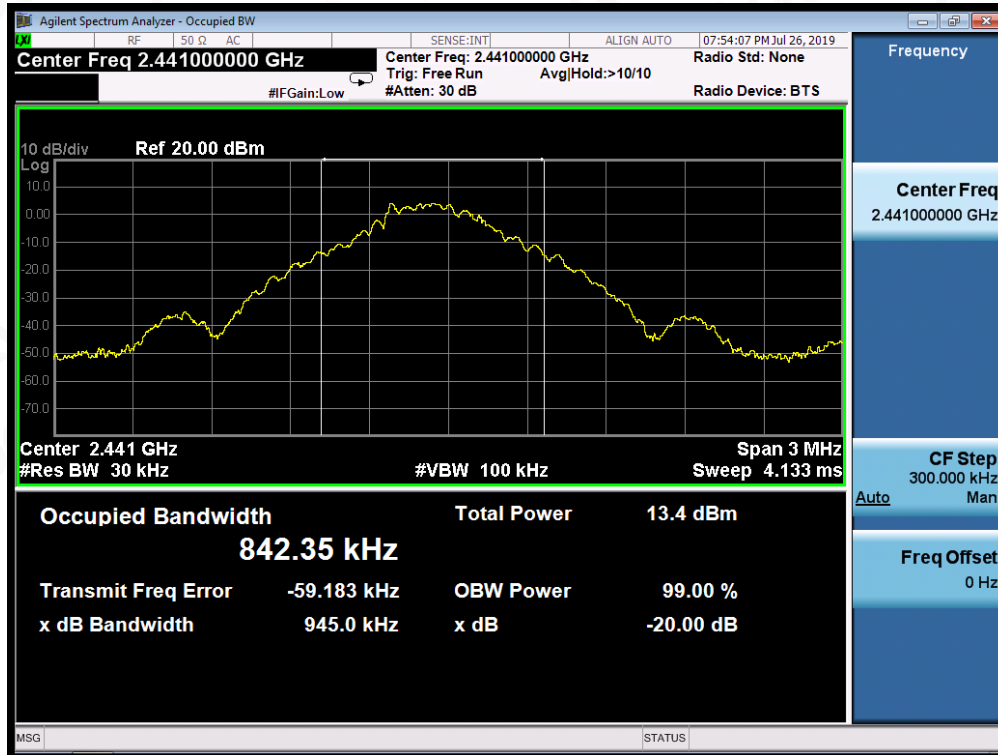

Attestation of Global Compliance(Shenzhen)Co.,Ltd.

Add: 2/F., Building 2, No.1-4, Chaxi Sanwei Technial Industrial Park, Gushu,
Xixiang, Bao'an District, Shenzhen, Guangdong, China
Tel: +86-755 2523 4088 E-mail: agc@agc-cert.com

Service Hotline:400 089 2118

TEST PLOT OF BANDWIDTH FOR HIGH CHANNEL

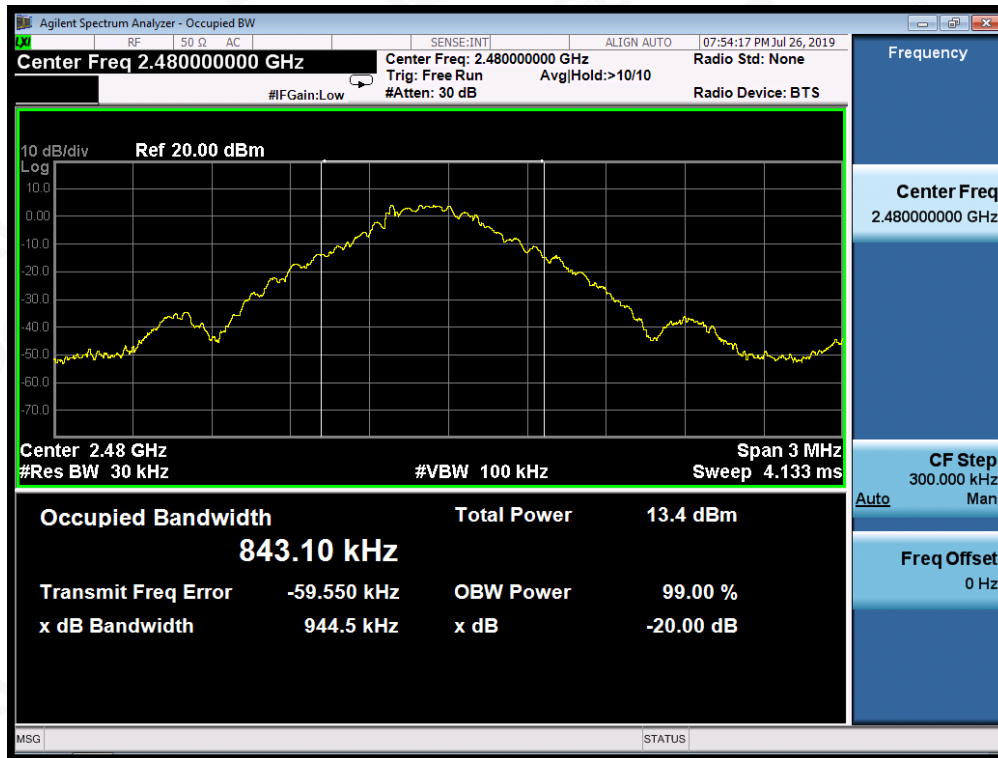

Attestation of Global Compliance(Shenzhen)Co.,Ltd.

Add: 2/F., Building 2, No.1-4, Chaxi Sanwei Technial Industrial Park, Gushu, Xixiang, Bao'an District, Shenzhen, Guangdong, China

Tel: +86-755 2523 4088

E-mail: agc@agc-cert.com

Service Hotline:400 089 2118

| MEASUREMENT RESULT FOR II /4-DQPSK MODULATION | | | |
|---|--------------------|-------|----------|
| Applicable Limits | Measurement Result | | |
| | Test Data (MHz) | | Criteria |
| N/A | Low Channel | 1.314 | PASS |
| | Middle Channel | 1.313 | PASS |
| | High Channel | 1.340 | PASS |

TEST PLOT OF BANDWIDTH FOR LOW CHANNEL

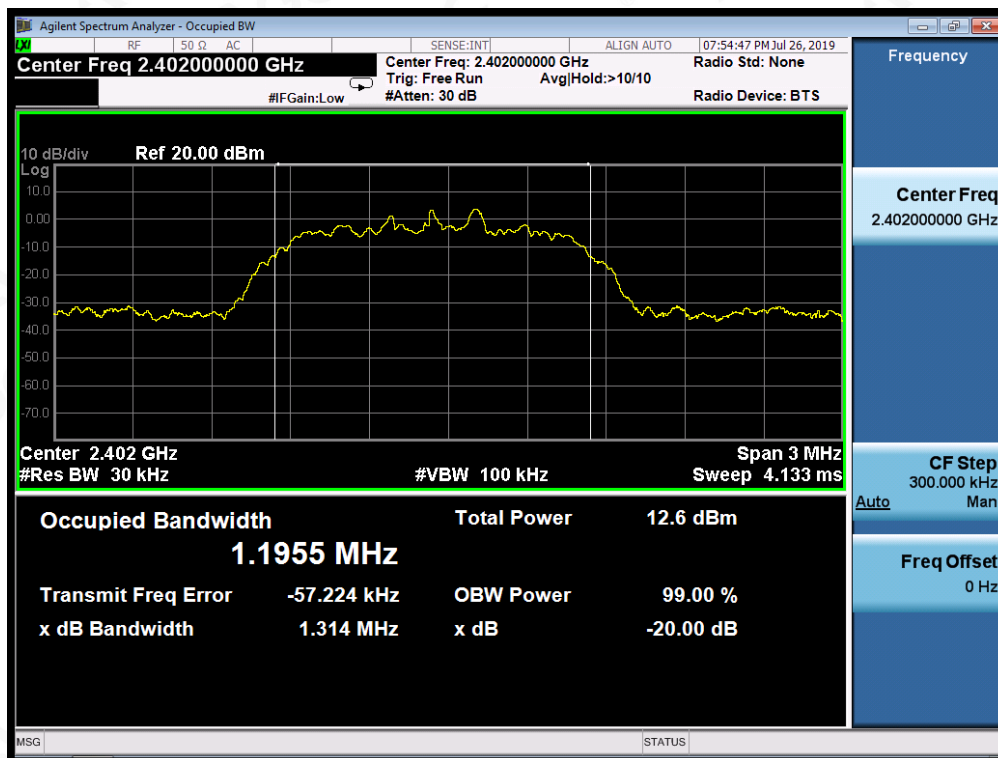

Attestation of Global Compliance(Shenzhen)Co.,Ltd.

Add: 2/F., Building 2, No.1-4, Chaxi Sanwei Technial Industrial Park, Gushu, Xixiang, Bao'an District, Shenzhen, Guangdong, China

Tel: +86-755 2523 4088

E-mail: agc@agc-cert.com

Service Hotline:400 089 2118

TEST PLOT OF BANDWIDTH FOR MIDDLE CHANNEL

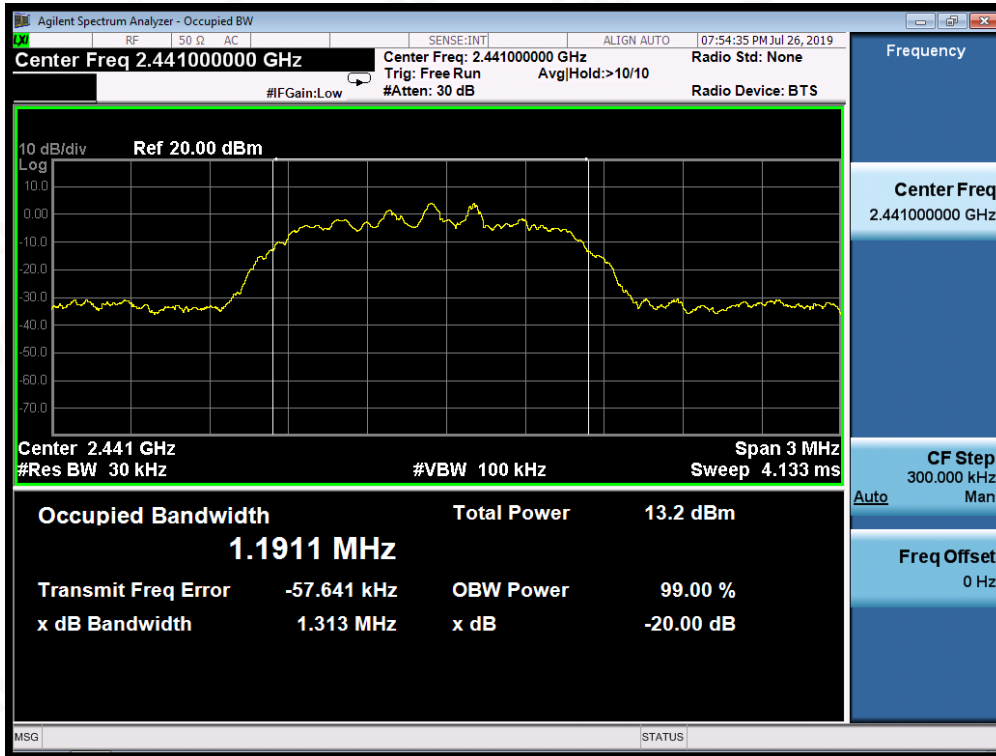

TEST PLOT OF BANDWIDTH FOR HIGH CHANNEL

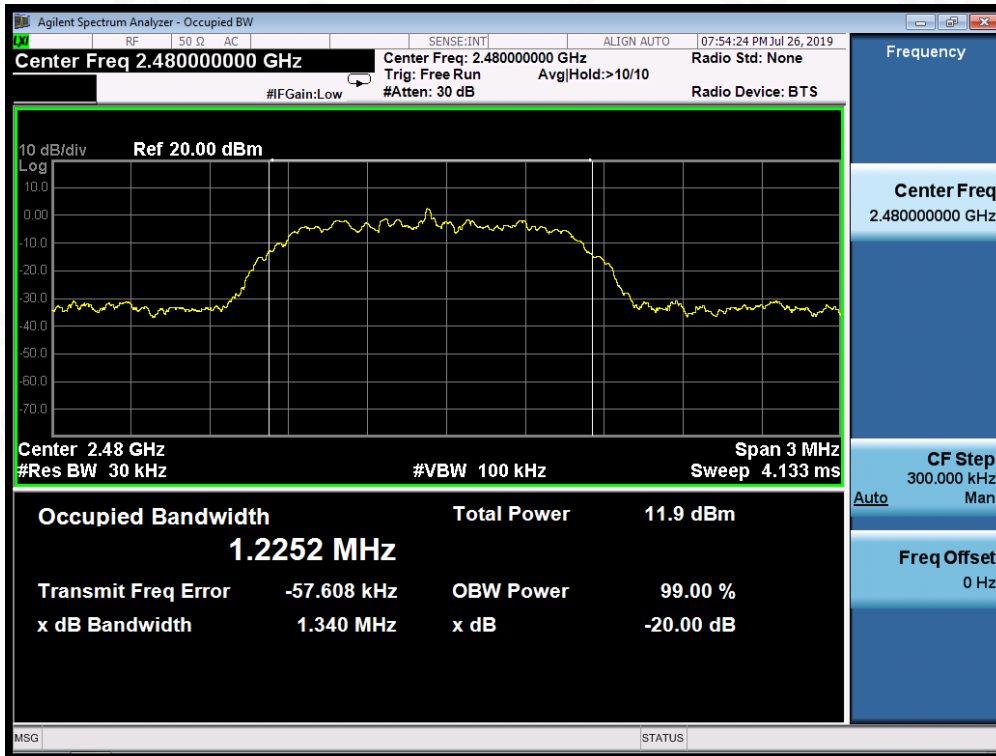

Attestation of Global Compliance(Shenzhen)Co.,Ltd.

Add: 2/F., Building 2, No.1-4, Chaxi Sanwei Technial Industrial Park, Gushu,
 Xixiang, Bao'an District, Shenzhen, Guangdong, China
 Tel: +86-755 2523 4088 E-mail: agc@agc-cert.com Service Hotline:400 089 2118

9. CONDUCTED SPURIOUS EMISSION

9.1. MEASUREMENT PROCEDURE

1. Connect EUT RF output port to the Spectrum Analyzer through an RF attenuator
2. Set the EUT Work on the top, the Middle and the bottom operation frequency individually.
3. Set the Span = wide enough to capture the peak level of the in-band emission and all spurious emissions from the lowest frequency generated in the EUT up through the 10th harmonic.
RBW = 100 kHz; VBW= 300 kHz; Sweep = auto; Detector function = peak.
4. Set SPA Trace 1 Max hold, then View.

9.2. TEST SET-UP (BLOCK DIAGRAM OF CONFIGURATION)

The same as described in section 8.2

9.3. MEASUREMENT EQUIPMENT USED

The same as described in section 6

9.4. LIMITS AND MEASUREMENT RESULT

| LIMITS AND MEASUREMENT RESULT | | |
|--|--|----------|
| Applicable Limits | Measurement Result | |
| | Test Data | Criteria |
| In any 100 KHz Bandwidth Outside the frequency band in which the spread spectrum intentional radiator is operating, the radio frequency power that is produce by the intentional radiator shall be at least 20 dB below that in 100KHz bandwidth within the band that contains the highest level of the desired power. In addition, radiation emissions which fall in the restricted bands, as defined in §15.205(a), must also comply with the radiated emission limits specified in§15.209(a) | At least -20dBc than the limit Specified on the BOTTOM Channel | PASS |
| | At least -20dBc than the limit Specified on the TOP Channel | PASS |



TEST RESULT FOR ENTIRE FREQUENCY RANGE
TEST PLOT OF OUT OF BAND EMISSIONS WITH THE WORST CASE
OF $\pi/4$ -DQPSK MODULATION IN LOW CHANNEL

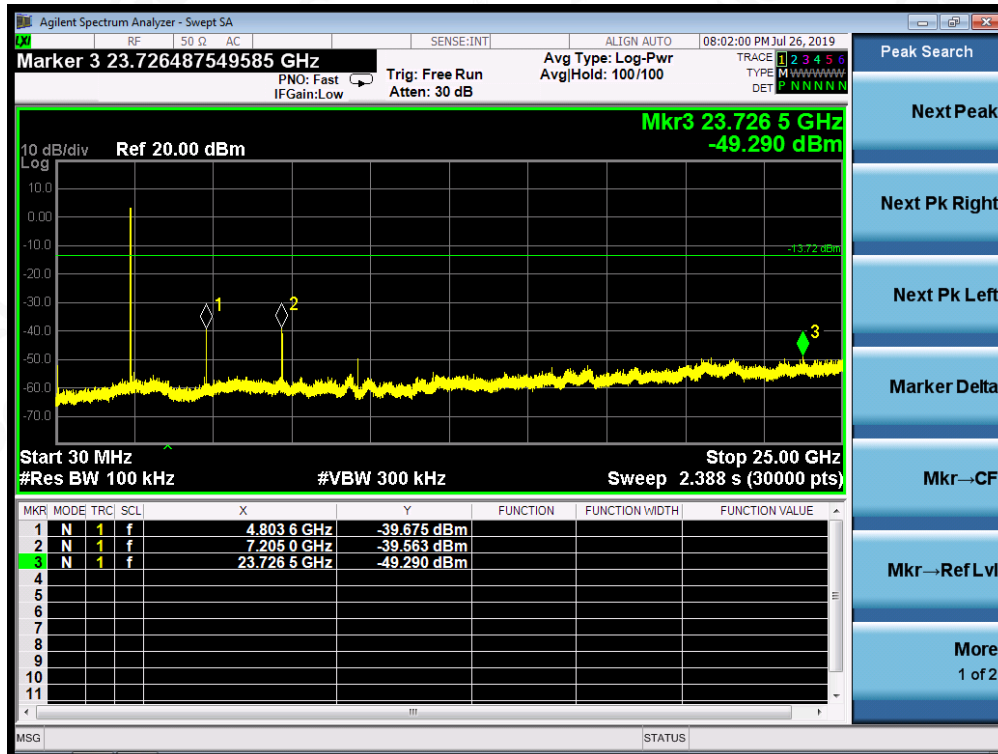

Attestation of Global Compliance(Shenzhen)Co.,Ltd.

Add: 2/F., Building 2, No.1-4, Chaxi Sanwei Technial Industrial Park, Gushu,
Xixiang, Bao'an District, Shenzhen, Guangdong, China
Tel: +86-755 2523 4088 E-mail: agc@agc-cert.com

Service Hotline:400 089 2118

TEST PLOT OF OUT OF BAND EMISSIONS
OF $\pi/4$ -DQPSK MODULATION IN MIDDLE CHANNEL

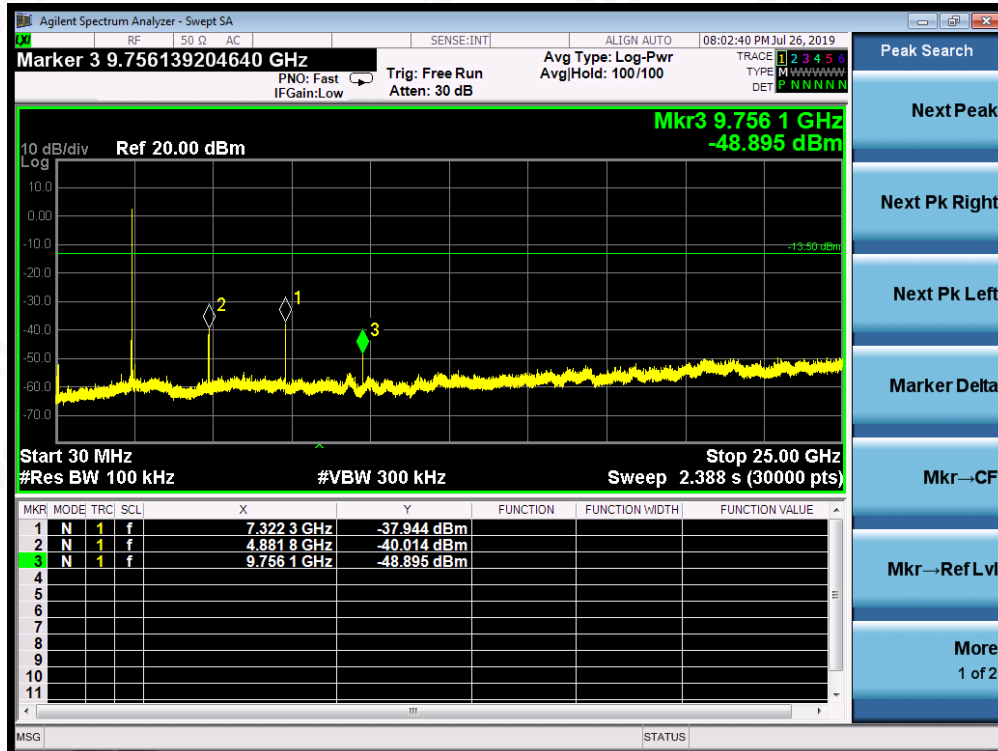

Attestation of Global Compliance(Shenzhen)Co.,Ltd.

Add: 2/F., Building 2, No.1-4, Chaxi Sanwei Technial Industrial Park, Gushu, Xixiang, Bao'an District, Shenzhen, Guangdong, China

Tel: +86-755 2523 4088

E-mail: agc@agc-cert.com

Service Hotline:400 089 2118

TEST PLOT OF OUT OF BAND EMISSIONS
OF $\pi/4$ -DQPSK MODULATION IN HIGH CHANNEL

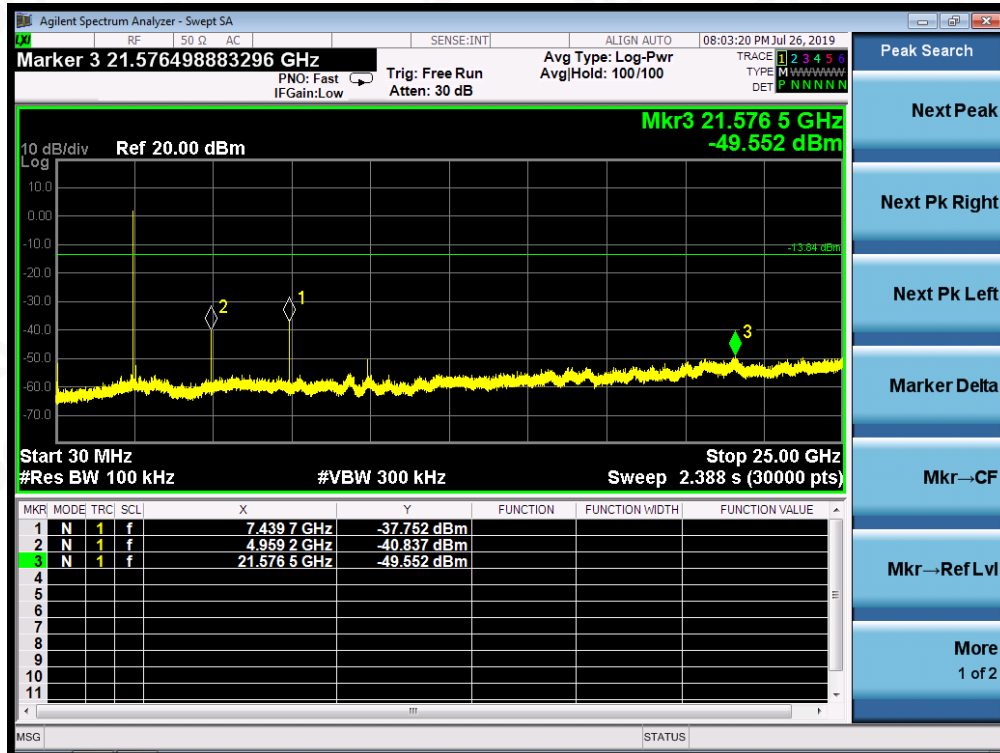

Note: The peak emissions without marker on the above plots are fundamental wave and need not to compare with the limit. The $\pi/4$ -DQPSK modulation is the worst case and only those data recorded in the report.



Attestation of Global Compliance(Shenzhen)Co.,Ltd.

Add: 2/F., Building 2, No.1-4, Chaxi Sanwei Technial Industrial Park, Gushu,
Xixiang, Bao'an District, Shenzhen, Guangdong, China
Tel: +86-755 2523 4088 E-mail: agc@agc-cert.com Service Hotline:400 089 2118

TEST RESULT FOR BAND EDGE
GFSK MODULATION IN LOW CHANNEL
Hopping off

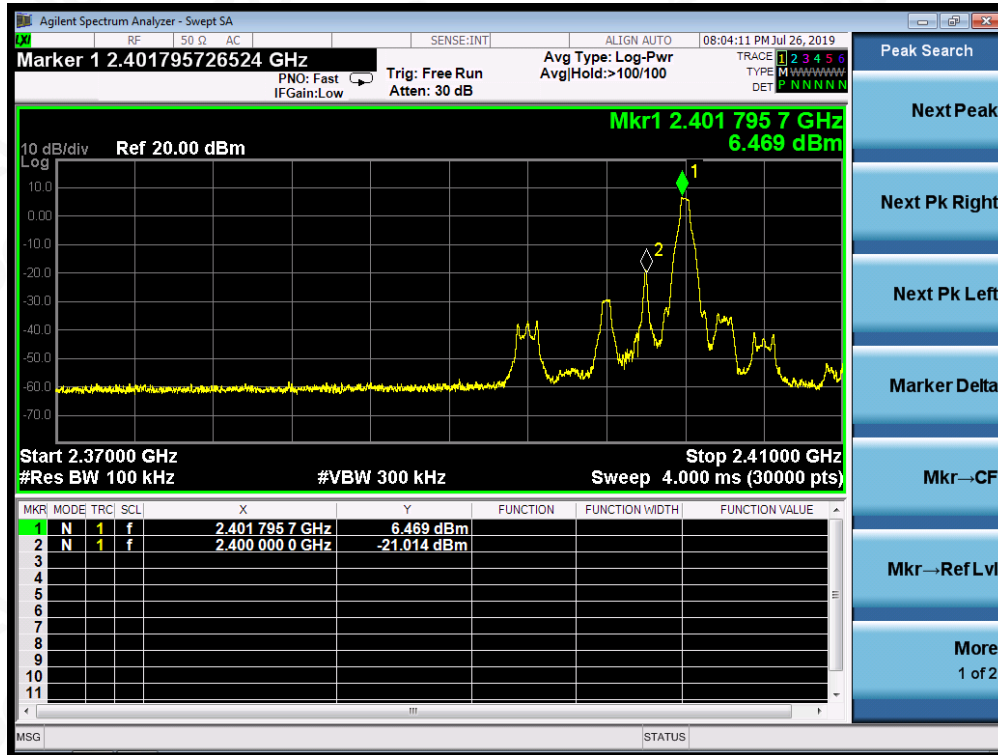

Hopping on

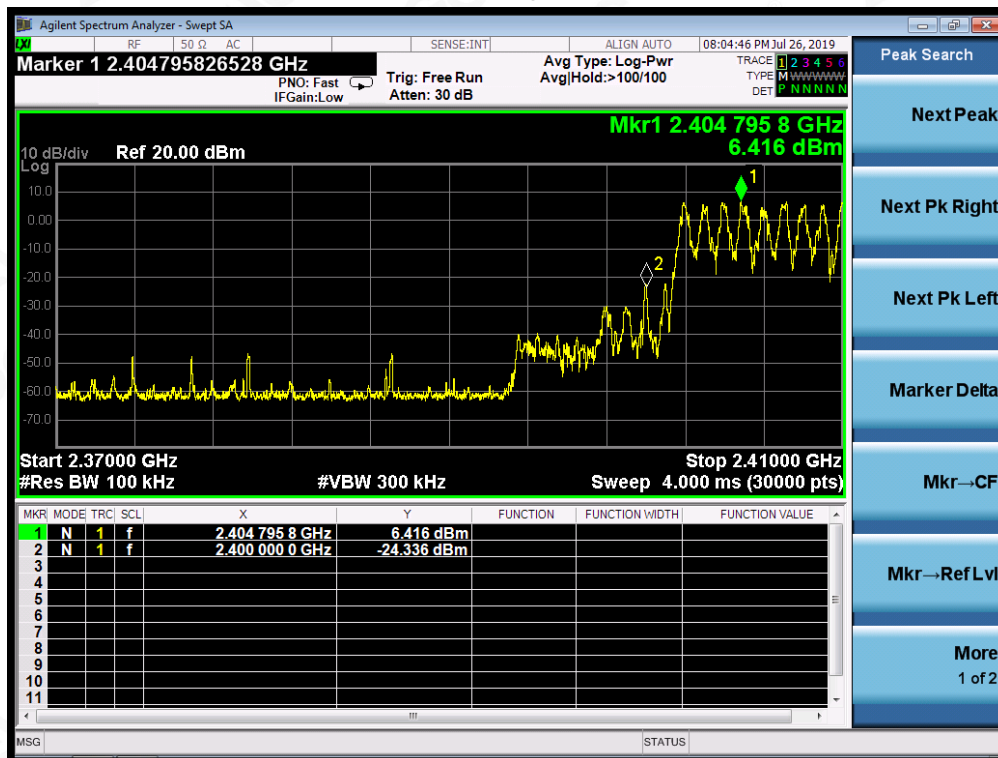

Attestation of Global Compliance(Shenzhen)Co.,Ltd.

Add: 2/F., Building 2, No.1-4, Chaxi Sanwei Technial Industrial Park, Gushu, Xixiang, Bao'an District, Shenzhen, Guangdong, China

Tel: +86-755 2523 4088

E-mail: agc@agc-cert.com

Service Hotline:400 089 2118

GFSK MODULATION IN HIGH CHANNEL Hopping off



Hopping on

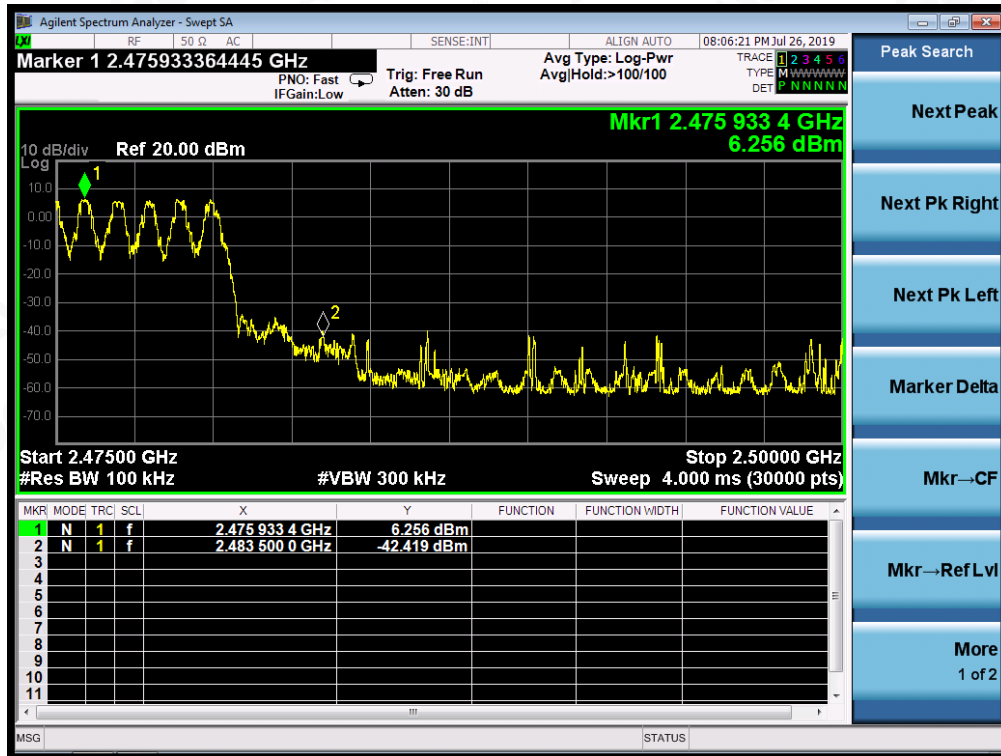

Attestation of Global Compliance(Shenzhen)Co.,Ltd.

Add: 2/F., Building 2, No.1-4, Chaxi Sanwei Technial Industrial Park, Gushu,
Xixiang, Bao'an District, Shenzhen, Guangdong, China
Tel: +86-755 2523 4088 E-mail: agc@agc-cert.com Service Hotline:400 089 2118

π /4-DQPSK MODULATION IN LOW CHANNEL
Hopping off



Hopping on



Attestation of Global Compliance(Shenzhen)Co.,Ltd.

Add: 2/F., Building 2, No.1-4, Chaxi Sanwei Technial Industrial Park, Gushu,
Xixiang, Bao'an District, Shenzhen, Guangdong, China
Tel: +86-755 2523 4088 E-mail: agc@agc-cert.com Service Hotline:400 089 2118

π /4-DQPSK MODULATION IN HIGH CHANNEL
Hopping off



Hopping on



Attestation of Global Compliance(Shenzhen)Co.,Ltd.

Add: 2/F., Building 2, No.1-4, Chaxi Sanwei Technial Industrial Park, Gushu,
Xixiang, Bao'an District, Shenzhen, Guangdong, China
Tel: +86-755 2523 4088 E-mail: agc@agc-cert.com Service Hotline:400 089 2118

10. RADIATED EMISSION

10.1. MEASUREMENT PROCEDURE

1. The EUT was placed on the top of the turntable 0.8 or 1.5 meter above ground. The phase center of the receiving antenna mounted on the top of a height-variable antenna tower was placed 3 meters far away from the turntable.
2. Power on the EUT and all the supporting units. The turntable was rotated by 360 degrees to determine the position of the highest radiation.
3. The height of the broadband receiving antenna was varied between one meter and four meters above ground to find the maximum emissions field strength of both horizontal and vertical polarization.
4. For each suspected emissions, the antenna tower was scan (from 1 M to 4 M) and then the turntable was rotated (from 0 degree to 360 degrees) to find the maximum reading.
5. Set the test-receiver system to Peak or CISPR quasi-peak Detect Function with specified bandwidth under Maximum Hold Mode.
6. For emissions above 1GHz, use 1MHz RBW and 3MHz VBW for peak reading. Place the measurement antenna away from each area of the EUT determined to be a source of emissions at the specified measurement distance, while keeping the measurement antenna aimed at the source of emissions at each frequency of significant emissions, with polarization oriented for maximum response. The measurement antenna may have to be higher or lower than the EUT, depending on the radiation pattern of the emission and staying aimed at the emission source for receiving the maximum signal. The final measurement antenna elevation shall be that which maximizes the emissions. The measurement antenna elevation for maximum emissions shall be restricted to a range of heights of from 1 m to 4 m above the ground or reference ground plane.
7. When the radiated emissions limits are expressed in terms of the average value of the emissions, and pulsed operation is employed, the measurement field strength shall be determined by averaging over one complete pulse train, including blanking intervals, as long as the pulse train does not exceed 0.1 seconds. As an alternative (provided the transmitter operates for longer than 0.1 seconds) or in cases where the pulse train exceeds 0.1 seconds, the measured field strength shall be determined from the average absolute voltage during a 0.1 second interval during which the field strength is at its maximum values.
8. If the emissions level of the EUT in peak mode was 3 dB lower than the average limit specified, then testing will be stopped and peak values of EUT will be reported, otherwise, the emissions which do not have 3 dB margin will be repeated one by one using the quasi-peak method for below 1GHz.
9. For testing above 1GHz, the emissions level of the EUT in peak mode was lower than average limit (that means the emissions level in peak mode also complies with the limit in average mode), then testing will be stopped and peak values of EUT will be reported, otherwise, the emissions will be measured in average mode again and reported.
10. In case the emission is lower than 30MHz, loop antenna has to be used for measurement and the recorded data should be QP measured by receiver. High - Low scan is not required in this case.



The following table is the setting of spectrum analyzer and receiver.

| Spectrum Parameter | Setting |
|-----------------------|---|
| Start ~Stop Frequency | 9KHz~150KHz/RB 200Hz for QP |
| Start ~Stop Frequency | 150KHz~30MHz/RB 9KHz for QP |
| Start ~Stop Frequency | 30MHz~1000MHz/RB 120KHz for QP |
| Start ~Stop Frequency | 1GHz~26.5GHz 1MHz/3MHz for Peak, 1MHz/3MHz for Average |

| Receiver Parameter | Setting |
|-----------------------|--------------------------------|
| Start ~Stop Frequency | 9KHz~150KHz/RB 200Hz for QP |
| Start ~Stop Frequency | 150KHz~30MHz/RB 9KHz for QP |
| Start ~Stop Frequency | 30MHz~1000MHz/RB 120KHz for QP |



Attestation of Global Compliance(Shenzhen)Co.,Ltd.

Add: 2/F., Building 2, No.1-4, Chaxi Sanwei Technial Industrial Park, Gushu,
Xixiang, Bao'an District, Shenzhen, Guangdong, China

Tel: +86-755 2523 4088

E-mail: agc@agc-cert.com

Service Hotline:400 089 2118

10.2. TEST SETUP

Radiated Emission Test-Setup Frequency Below 30MHz

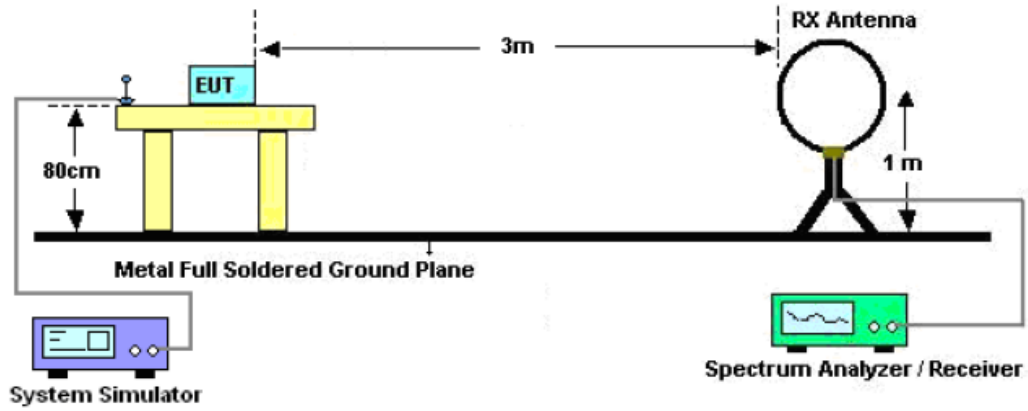

RADIATED EMISSION TEST SETUP 30MHz-1000MHz

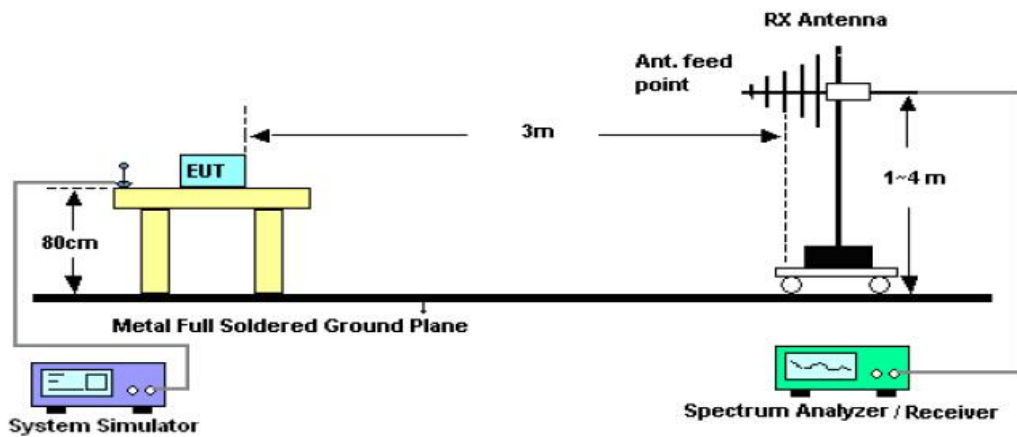

RADIATED EMISSION TEST SETUP ABOVE 1000MHz

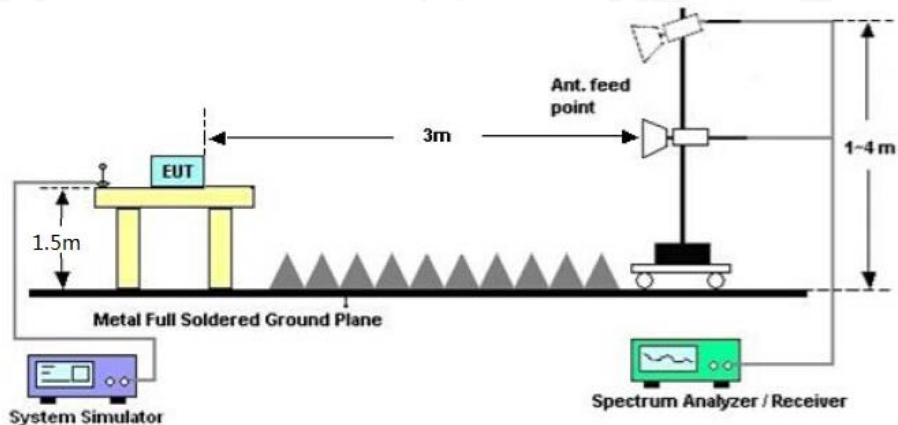

10.3. LIMITS AND MEASUREMENT RESULT

15.209 Limit in the below table has to be followed

| Frequencies (MHz) | Field Strength (micorvolts/meter) | Measurement Distance (meters) |
|-------------------|-----------------------------------|-------------------------------|
| 0.009~0.490 | 2400/F(KHz) | 300 |
| 0.490~1.705 | 24000/F(KHz) | 30 |
| 1.705~30.0 | 30 | 30 |
| 30~88 | 100 | 3 |
| 88~216 | 150 | 3 |
| 216~960 | 200 | 3 |
| Above 960 | 500 | 3 |

Note: 1. All modes were tested For restricted band radiated emission,
2.The test records reported below are the worst result compared to other modes.

10.4. TEST RESULT

RADIATED EMISSION BELOW 30MHZ

No emission found between lowest internal used/generated frequencies to 30MHz.



Attestation of Global Compliance(Shenzhen)Co.,Ltd.

Add: 2/F., Building 2, No.1-4, Chaxi Sanwei Technial Industrial Park, Gushu, Xixiang, Bao'an District, Shenzhen, Guangdong, China

Tel: +86-755 2523 4088 E-mail: agc@agc-cert.com Service Hotline:400 089 2118

RADIATED EMISSION BELOW 1GHZ

| | | | |
|--------------------|-------------------------------|--------------------------|----------------|
| EUT | VINYL PRO WIRELESS HEADPHONES | Model Name | HY-VNYL |
| Temperature | 25°C | Relative Humidity | 55.4% |
| Pressure | 960hPa | Test Voltage | Normal Voltage |
| Test Mode | Mode 6 | Antenna | Horizontal |

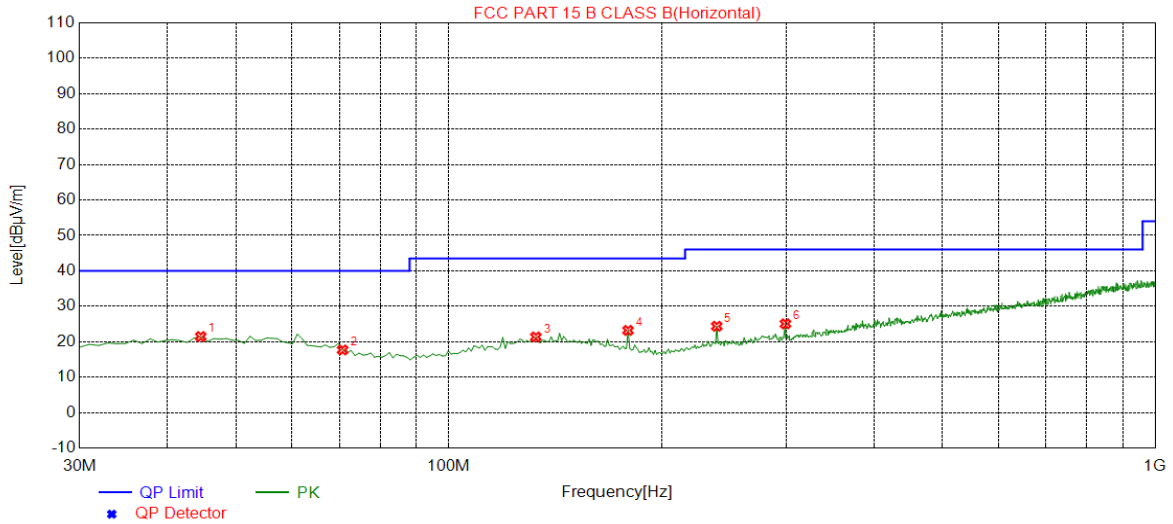

| NO. | Freq. [MHz] | Level [dBuV/m] | Factor [dB] | Limit [dBuV/m] | Margin [dB] | Height [cm] | Angle [°] | Polarity |
|-----|-------------|----------------|-------------|----------------|-------------|-------------|-----------|------------|
| 1 | 44.5500 | 21.46 | 14.82 | 40.00 | 18.54 | 150 | 328 | Horizontal |
| 2 | 70.7400 | 17.68 | 12.07 | 40.00 | 22.32 | 150 | 123 | Horizontal |
| 3 | 132.8200 | 21.35 | 14.35 | 43.50 | 22.15 | 150 | 105 | Horizontal |
| 4 | 179.3800 | 23.20 | 13.06 | 43.50 | 20.30 | 150 | 358 | Horizontal |
| 5 | 239.5200 | 24.36 | 14.81 | 46.00 | 21.64 | 100 | 234 | Horizontal |
| 6 | 299.6600 | 25.06 | 15.91 | 46.00 | 20.94 | 150 | 263 | Horizontal |

RESULT: PASS



Attestation of Global Compliance(Shenzhen)Co.,Ltd.

Add: 2/F., Building 2, No.1-4, Chaxi Sanwei Technial Industrial Park, Gushu, Xixiang, Bao'an District, Shenzhen, Guangdong, China

Tel: +86-755 2523 4088

E-mail: agc@agc-cert.com

Service Hotline:400 089 2118

| | | | |
|--------------------|--------------------------------|--------------------------|----------------|
| EUT | VINYL PRO WIRELESS HEADP HONES | Model Name | HY-VNYL |
| Temperature | 25°C | Relative Humidity | 55.4% |
| Pressure | 960hPa | Test Voltage | Normal Voltage |
| Test Mode | Mode 6 | Antenna | Vertical |

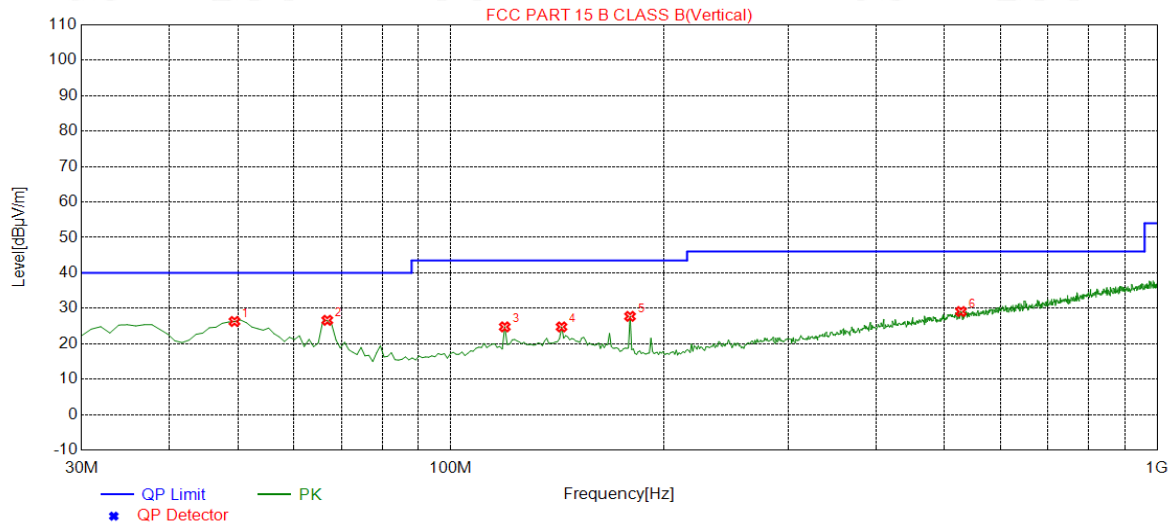

| NO. | Freq. [MHz] | Level [dBµV/m] | Factor [dB] | Limit [dBµV/m] | Margin [dB] | Height [cm] | Angle [°] | Polarity |
|-----|-------------|----------------|-------------|----------------|-------------|-------------|-----------|----------|
| 1 | 49.4000 | 26.28 | 14.69 | 40.00 | 13.72 | 100 | 76 | Vertical |
| 2 | 66.8600 | 26.61 | 12.76 | 40.00 | 13.39 | 100 | 134 | Vertical |
| 3 | 119.2400 | 24.76 | 13.39 | 43.50 | 18.74 | 150 | 105 | Vertical |
| 4 | 143.4900 | 24.75 | 14.88 | 43.50 | 18.75 | 100 | 165 | Vertical |
| 5 | 179.3800 | 27.73 | 13.06 | 43.50 | 15.77 | 100 | 69 | Vertical |
| 6 | 527.6100 | 29.09 | 22.80 | 46.00 | 16.91 | 150 | 266 | Vertical |

RESULT: PASS

Note: 1. Factor=Antenna Factor + Cable loss, Margin=Measurement-Limit.

2. All test modes had been pre-tested. The mode 6 is the worst case and recorded in the report.



Attestation of Global Compliance(Shenzhen)Co.,Ltd.

Add: 2/F., Building 2, No.1-4, Chaxi Sanwei Technial Industrial Park, Gushu, Xixiang, Bao'an District, Shenzhen, Guangdong, China

Tel: +86-755 2523 4088

E-mail: agc@agc-cert.com

Service Hotline:400 089 2118

RADIATED EMISSION ABOVE 1GHZ

| | | | |
|--------------------|--------------------------------|--------------------------|----------------|
| EUT | VINYL PRO WIRELESS HEADP HONES | Model Name | HY-VNYL |
| Temperature | 25°C | Relative Humidity | 55.4% |
| Pressure | 960hPa | Test Voltage | Normal Voltage |
| Test Mode | Mode 4 | Antenna | Horizontal |

| Frequency (MHz) | Meter Reading (dBμV) | Factor (dB) | Emission Level (dBμV/m) | Limits (dBμV/m) | Margin (dB) | Value Type |
|-----------------|----------------------|-------------|-------------------------|-----------------|-------------|------------|
| 4804.000 | 53.87 | 0.08 | 53.95 | 74 | -20.05 | peak |
| 4804.000 | 51.73 | 0.08 | 51.81 | 54 | -2.19 | AVG |
| 7206.000 | 48.68 | 2.21 | 50.89 | 74 | -23.11 | peak |
| 7206.000 | 44.52 | 2.21 | 46.73 | 54 | -7.27 | AVG |
| | | | | | | |
| | | | | | | |

Remark:
Factor = Antenna Factor + Cable Loss – Pre-amplifier.

| | | | |
|--------------------|--------------------------------|--------------------------|----------------|
| EUT | VINYL PRO WIRELESS HEADP HONES | Model Name | HY-VNYL |
| Temperature | 25°C | Relative Humidity | 55.4% |
| Pressure | 960hPa | Test Voltage | Normal Voltage |
| Test Mode | Mode 4 | Antenna | Vertical |

| Frequency (MHz) | Meter Reading (dBμV) | Factor (dB) | Emission Level (dBμV/m) | Limits (dBμV/m) | Margin (dB) | Value Type |
|-----------------|----------------------|-------------|-------------------------|-----------------|-------------|------------|
| 4804.000 | 54.65 | 0.08 | 54.73 | 74 | -19.27 | peak |
| 4804.000 | 50.42 | 0.08 | 50.5 | 54 | -3.5 | AVG |
| 7206.000 | 49.92 | 2.21 | 52.13 | 74 | -21.87 | peak |
| 7206.000 | 46.57 | 2.21 | 48.78 | 54 | -5.22 | AVG |
| | | | | | | |
| | | | | | | |

Remark:
Factor = Antenna Factor + Cable Loss – Pre-amplifier.



Attestation of Global Compliance(Shenzhen)Co.,Ltd.

Add: 2/F., Building 2, No.1-4, Chaxi Sanwei Technial Industrial Park, Gushu, Xixiang, Bao'an District, Shenzhen, Guangdong, China

Tel: +86-755 2523 4088 E-mail: agc@agc-cert.com Service Hotline:400 089 2118

| | | | |
|--------------------|-------------------------------|--------------------------|----------------|
| EUT | VINYL PRO WIRELESS HEADPHONES | Model Name | HY-VNYL |
| Temperature | 25°C | Relative Humidity | 55.4% |
| Pressure | 960hPa | Test Voltage | Normal Voltage |
| Test Mode | Mode 5 | Antenna | Horizontal |

| Frequency (MHz) | Meter Reading (dBμV) | Factor (dB) | Emission Level (dBμV/m) | Limits (dBμV/m) | Margin (dB) | Value Type |
|-----------------|----------------------|-------------|-------------------------|-----------------|-------------|------------|
| 4882.000 | 52.85 | 0.14 | 52.99 | 74 | -21.01 | peak |
| 4882.000 | 49.77 | 0.14 | 49.91 | 54 | -4.09 | AVG |
| 7323.000 | 50.12 | 2.36 | 52.48 | 74 | -21.52 | peak |
| 7323.000 | 43.65 | 2.36 | 46.01 | 54 | -7.99 | AVG |
| | | | | | | |
| | | | | | | |

Remark:
Factor = Antenna Factor + Cable Loss – Pre-amplifier.

| | | | |
|--------------------|-------------------------------|--------------------------|----------------|
| EUT | VINYL PRO WIRELESS HEADPHONES | Model Name | HY-VNYL |
| Temperature | 25°C | Relative Humidity | 55.4% |
| Pressure | 960hPa | Test Voltage | Normal Voltage |
| Test Mode | Mode 5 | Antenna | Vertical |

| Frequency (MHz) | Meter Reading (dBμV) | Factor (dB) | Emission Level (dBμV/m) | Limits (dBμV/m) | Margin (dB) | Value Type |
|-----------------|----------------------|-------------|-------------------------|-----------------|-------------|------------|
| 4882.000 | 50.84 | 0.14 | 50.98 | 74 | -23.02 | peak |
| 4882.000 | 48.63 | 0.14 | 48.77 | 54 | -5.23 | AVG |
| 7323.000 | 43.97 | 2.36 | 46.33 | 74 | -27.67 | peak |
| 7323.000 | 40.43 | 2.36 | 42.79 | 54 | -11.21 | AVG |
| | | | | | | |
| | | | | | | |

Remark:
Factor = Antenna Factor + Cable Loss – Pre-amplifier.



Attestation of Global Compliance(Shenzhen)Co.,Ltd.

Add: 2/F., Building 2, No.1-4, Chaxi Sanwei Technial Industrial Park, Gushu, Xixiang, Bao'an District, Shenzhen, Guangdong, China

Tel: +86-755 2523 4088 E-mail: agc@agc-cert.com Service Hotline:400 089 2118

| | | | |
|--------------------|-------------------------------|--------------------------|----------------|
| EUT | VINYL PRO WIRELESS HEADPHONES | Model Name | HY-VNYL |
| Temperature | 25°C | Relative Humidity | 55.4% |
| Pressure | 960hPa | Test Voltage | Normal Voltage |
| Test Mode | Mode 6 | Antenna | Horizontal |

| Frequency (MHz) | Meter Reading (dBμV) | Factor (dB) | Emission Level (dBμV/m) | Limits (dBμV/m) | Margin (dB) | Value Type |
|-----------------|----------------------|-------------|-------------------------|-----------------|-------------|------------|
| 4960.000 | 50.08 | 0.22 | 50.3 | 74 | -23.7 | peak |
| 4960.000 | 47.61 | 0.22 | 47.83 | 54 | -6.17 | AVG |
| 7440.000 | 42.48 | 2.64 | 45.12 | 74 | -28.88 | peak |
| 7440.000 | 39.97 | 2.64 | 42.61 | 54 | -11.39 | AVG |
| | | | | | | |
| | | | | | | |

Remark:
Factor = Antenna Factor + Cable Loss – Pre-amplifier.

| | | | |
|--------------------|-------------------------------|--------------------------|----------------|
| EUT | VINYL PRO WIRELESS HEADPHONES | Model Name | HY-VNYL |
| Temperature | 25°C | Relative Humidity | 55.4% |
| Pressure | 960hPa | Test Voltage | Normal Voltage |
| Test Mode | Mode 6 | Antenna | Vertical |

| Frequency (MHz) | Meter Reading (dBμV) | Factor (dB) | Emission Level (dBμV/m) | Limits (dBμV/m) | Margin (dB) | Value Type |
|-----------------|----------------------|-------------|-------------------------|-----------------|-------------|------------|
| 4960.000 | 49.95 | 0.22 | 50.17 | 74 | -23.83 | peak |
| 4960.000 | 46.87 | 0.22 | 47.09 | 54 | -6.91 | AVG |
| 7440.000 | 43.52 | 2.64 | 46.16 | 74 | -27.84 | peak |
| 7440.000 | 38.66 | 2.64 | 41.3 | 54 | -12.7 | AVG |
| | | | | | | |
| | | | | | | |

Remark:
Factor = Antenna Factor + Cable Loss – Pre-amplifier.

RESULT: PASS

Note: Other emissions from 1G to 25 GHz are considered as ambient noise. No recording in the test report.

Factor = Antenna Factor + Cable loss - Amplifier gain, Over=Measure-Limit.

The “Factor” value can be calculated automatically by software of measurement system.

All test modes had been tested. The π/4-DQPSK modulation is the worst case and recorded in the report.



Attestation of Global Compliance(Shenzhen)Co.,Ltd.

Add: 2/F., Building 2, No.1-4, Chaxi Sanwei Technial Industrial Park, Gushu, Xixiang, Bao'an District, Shenzhen, Guangdong, China

Tel: +86-755 2523 4088 E-mail: agc@agc-cert.com Service Hotline:400 089 2118

TEST RESULT FOR RESTRICTED BANDS REQUIREMENTS

| | | | |
|-------------|-------------------------------|-------------------|----------------|
| EUT | VINYL PRO WIRELESS HEADPHONES | Model Name | HY-VNYL |
| Temperature | 25°C | Relative Humidity | 55.4% |
| Pressure | 960hPa | Test Voltage | Normal Voltage |
| Test Mode | Mode 4 | Antenna | Horizontal |

PK

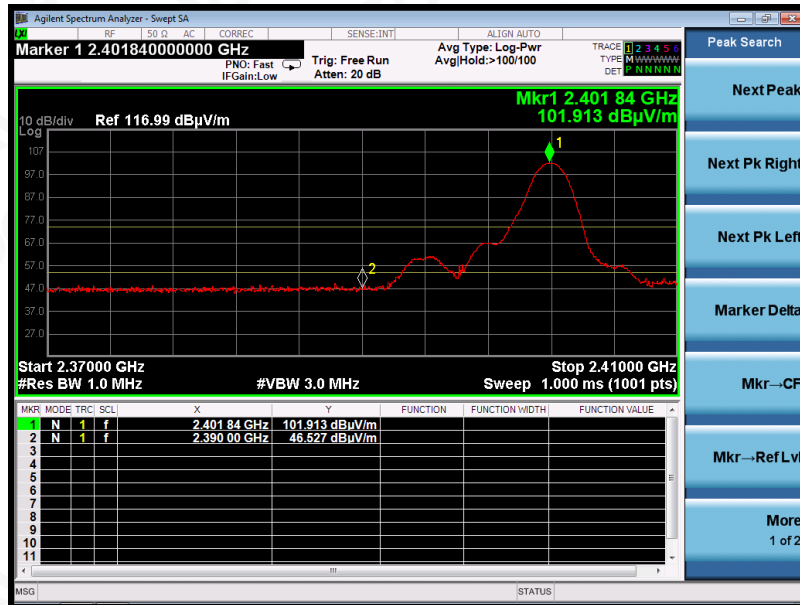

AV



RESULT: PASS



Attestation of Global Compliance(Shenzhen)Co.,Ltd.

Add: 2/F., Building 2, No.1-4, Chaxi Sanwei Technial Industrial Park, Gushu, Xixiang, Bao'an District, Shenzhen, Guangdong, China

Tel: +86-755 2523 4088

E-mail: agc@agc-cert.com

Service Hotline:400 089 2118

| | | | |
|-------------|-------------------------------|-------------------|----------------|
| EUT | VINYL PRO WIRELESS HEADPHONES | Model Name | HY-VNYL |
| Temperature | 25°C | Relative Humidity | 55.4% |
| Pressure | 960hPa | Test Voltage | Normal Voltage |
| Test Mode | Mode 4 | Antenna | Vertical |

PK

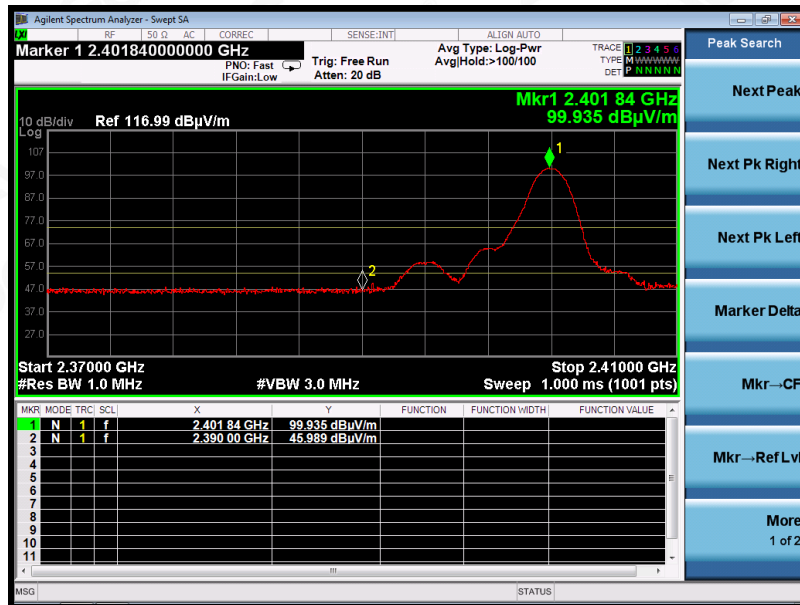

AV



RESULT: PASS



Attestation of Global Compliance(Shenzhen)Co.,Ltd.

Add: 2/F., Building 2, No.1-4, Chaxi Sanwei Technial Industrial Park, Gushu, Xixiang, Bao'an District, Shenzhen, Guangdong, China

Tel: +86-755 2523 4088

E-mail: agc@agc-cert.com

Service Hotline:400 089 2118

| | | | |
|-------------|-------------------------------|-------------------|----------------|
| EUT | VINYL PRO WIRELESS HEADPHONES | Model Name | HY-VNYL |
| Temperature | 25°C | Relative Humidity | 55.4% |
| Pressure | 960hPa | Test Voltage | Normal Voltage |
| Test Mode | Mode 6 | Antenna | Horizontal |

PK

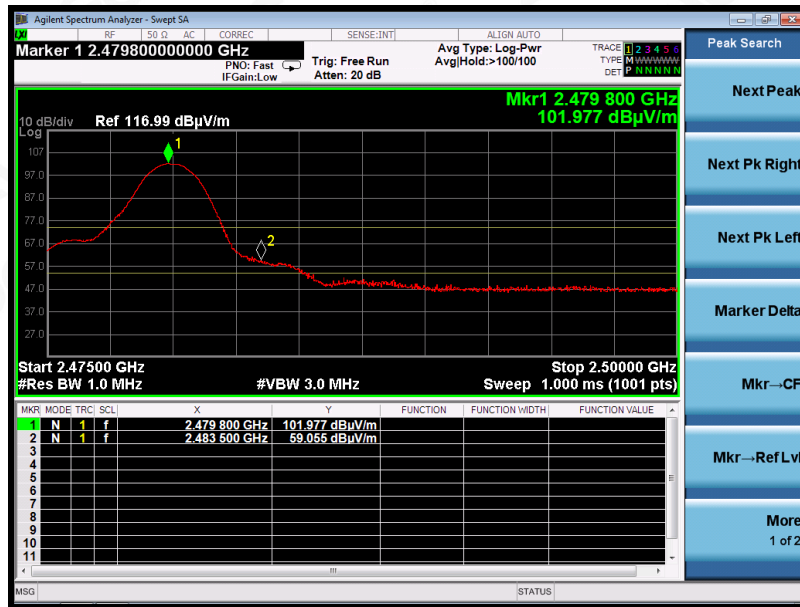

AV

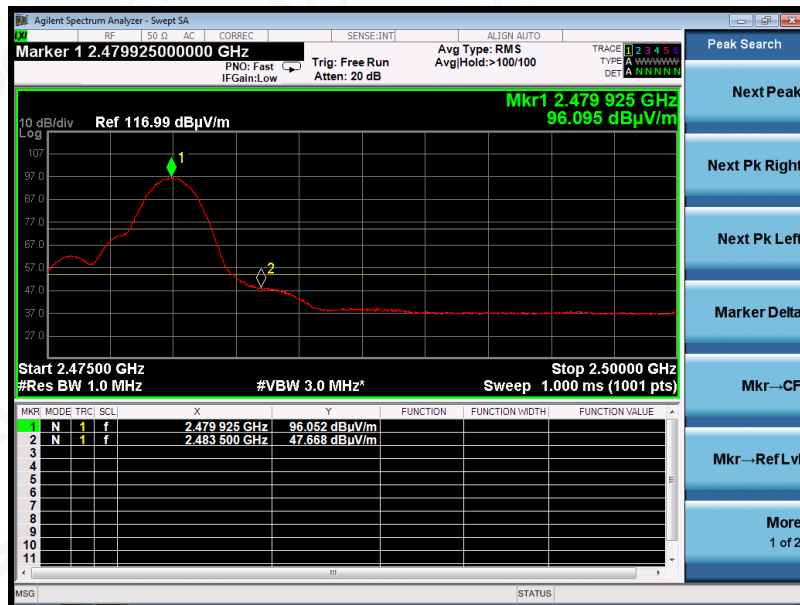

RESULT: PASS



Attestation of Global Compliance(Shenzhen)Co.,Ltd.

Add: 2/F., Building 2, No.1-4, Chaxi Sanwei Technical Industrial Park, Gushu, Xixiang, Bao'an District, Shenzhen, Guangdong, China

Tel: +86-755 2523 4088

E-mail: agc@agc-cert.com

Service Hotline:400 089 2118

| | | | |
|-------------|-------------------------------|-------------------|----------------|
| EUT | VINYL PRO WIRELESS HEADPHONES | Model Name | HY-VNYL |
| Temperature | 25°C | Relative Humidity | 55.4% |
| Pressure | 960hPa | Test Voltage | Normal Voltage |
| Test Mode | Mode 6 | Antenna | Vertical |

PK

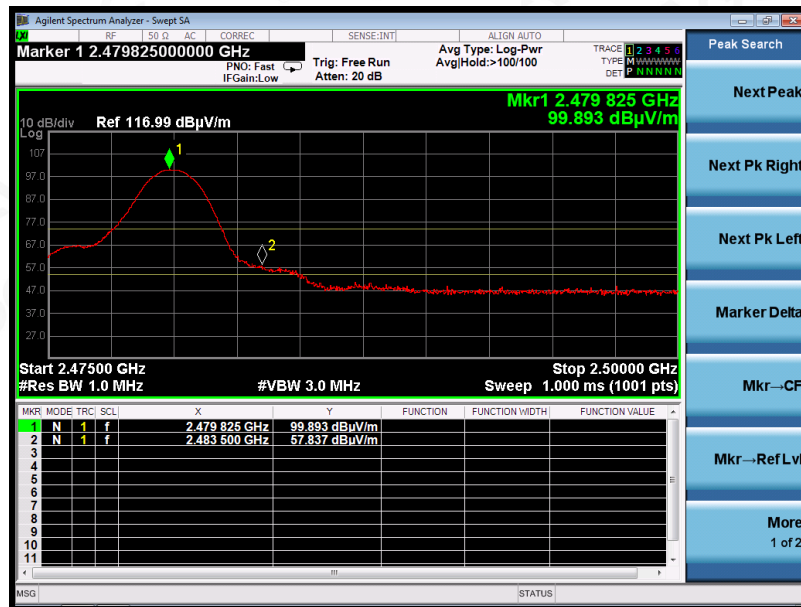

AV

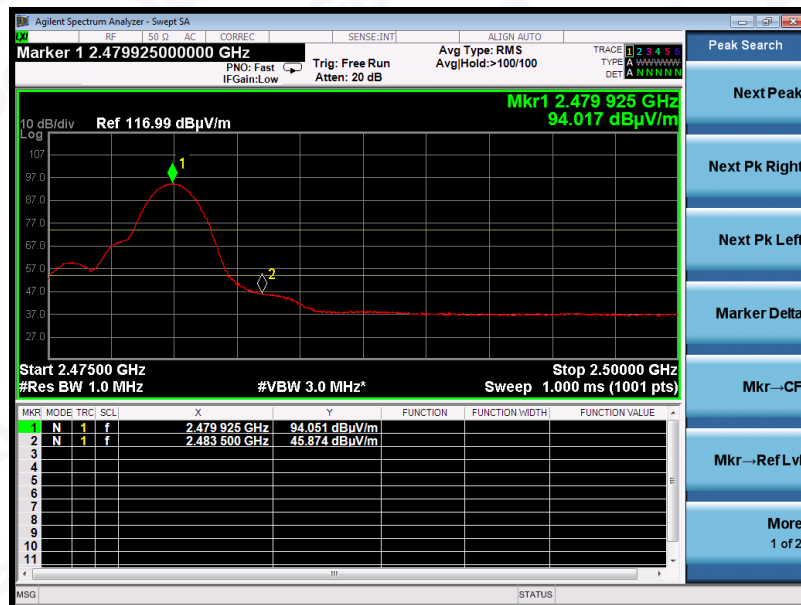

RESULT: PASS

Note: The factor had been edited in the "Input Correction" of the Spectrum Analyzer. So the Amplitude of test plots is equal to Reading level plus the Factor in dB. Use the A dB(µV) to represent the Amplitude. Use the F dB(µV/m) to represent the Field Strength. So A=F. All test modes had been pre-tested. The π/4-DQPSK modulation is the worst case and recorded in the report.



Attestation of Global Compliance(Shenzhen)Co.,Ltd.

Add: 2/F., Building 2, No.1-4, Chaxi Sanwei Technial Industrial Park, Gushu, Xixiang, Bao'an District, Shenzhen, Guangdong, China

Tel: +86-755 2523 4088

E-mail: agc@agc-cert.com

Service Hotline:400 089 2118

11. NUMBER OF HOPPING FREQUENCY

11.1. MEASUREMENT PROCEDURE

The EUT shall have its hopping function enabled. Use the following spectrum analyzer settings:

1. Span: The frequency band of operation. Depending on the number of channels the device supports, it may be necessary to divide the frequency range of operation across multiple spans, to allow the individual channels to be clearly seen.
2. RBW: To identify clearly the individual channels, set the RBW to less than 30% of the channel spacing or the 20 dB bandwidth, whichever is smaller.
3. VBW \geq RBW. Sweep: Auto. Detector function: Peak. Trace: Max hold.
4. Allow the trace to stabilize

11.2. TEST SETUP (BLOCK DIAGRAM OF CONFIGURATION)

Same as described in section 8.2

11.3. MEASUREMENT EQUIPMENT USED

The same as described in section 6

11.4. LIMITS AND MEASUREMENT RESULT

| TOTAL NO. OF HOPPING CHANNEL | LIMIT (NO. OF CH) | MEASUREMENT (NO. OF CH) | RESULT |
|------------------------------|-------------------|-------------------------|--------|
| | ≥ 15 | 79 | PASS |

TEST PLOT FOR NO. OF TOTAL CHANNELS

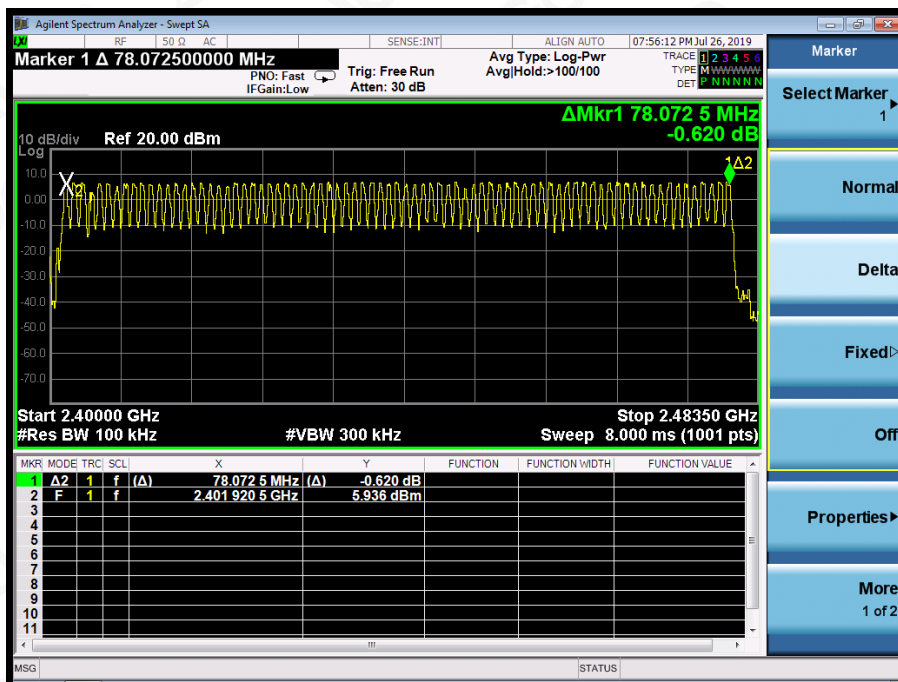

Note: The GFSK modulation is the worst case and recorded in the report.



Attestation of Global Compliance(Shenzhen)Co.,Ltd.

Add: 2/F., Building 2, No.1-4, Chaxi Sanwei Technial Industrial Park, Gushu, Xixiang, Bao'an District, Shenzhen, Guangdong, China

Tel: +86-755 2523 4088 E-mail: agc@agc-cert.com Service Hotline:400 089 2118