



FCC 47 CFR PART 15 SUBPART C

CERTIFICATION TEST REPORT

For

**“EverPlay” Wireless Portable Speaker
MODEL NUMBER: BT7900*/##**

FCC ID: 2AANUBT7900

REPORT NUMBER: 4787816190.2-1-1

ISSUE DATE: January 25, 2017

Prepared for

**Gibson Innovations Limited
5/F., Philips Electronics Building, 5 Science Park East Avenue, Hong Kong Science
Park, Shatin, New Territories, Hong Kong**

Prepared by

**UL Verification Services (Guangzhou) Co., Ltd, Song Shan Lake Branch
Room 101, Building 10, Innovation Technology Park,
Song Shan Lake Hi tech Development Zone, Dongguan, 523808, China
Tel: +86 769 33817100
Fax: +86 769 33244054
Website: www.ul.com**

The results reported herein have been performed in accordance with the laboratory's terms of accreditation. This report shall not be reproduced except in full without the written approval of the Laboratory. The results in this report apply to the test sample(s) mentioned above at the time of the testing period only and are not to be used to indicate applicability to other similar products. This report does not imply that the product(s) has met the criteria for certification.

Revision History

<u>Rev.</u>	<u>Issue Date</u>	<u>Revisions</u>	<u>Revised By</u>
--	01/25/2017	Initial Issue	

Summary of Test Results			
Clause	Test Items	FCC/IC Rules	Test Results
1	20dB Bandwidth	FCC 15.247 (a) (1)	Complied
2	Peak Conducted Output Power	FCC 15.247 (b) (1)	Complied
3	Carrier Hopping Channel Separation	FCC 15.247 (a) (1)	Complied
4	Number of Hopping Frequency	15.247 (a) (1) III	Complied
5	Time of Occupancy (Dwell Time)	15.247 (a) (1) III	Complied
6	Conducted Bandedge	FCC 15.247 (d)	Complied
7	Radiated Bandedge and Spurious	FCC 15.247 (d) FCC 15.209 FCC 15.205	Complied
8	Conducted Emission Test For AC Power Port	FCC 15.207	Complied
9	Antenna Requirement	FCC 15.203	Complied

TABLE OF CONTENTS

1. ATTESTATION OF TEST RESULTS	6
2. TEST METHODOLOGY	7
3. FACILITIES AND ACCREDITATION	7
4. CALIBRATION AND UNCERTAINTY	8
4.1. MEASURING INSTRUMENT CALIBRATION	8
4.2. MEASUREMENT UNCERTAINTY	8
5. EQUIPMENT UNDER TEST	9
5.1. DESCRIPTION OF EUT	9
5.2. MAXIMUM OUTPUT POWER.....	9
5.3. PACKET TYPE CONFIGURATION.....	9
5.4. CHANNEL LIST	10
5.5. TEST CHANNEL CONFIGURATION	10
5.6. THE WORSE CASE POWER SETTING PARAMETER.....	10
5.7. DESCRIPTION OF AVAILABLE ANTENNAS	11
5.8. WORST-CASE CONFIGURATIONS.....	11
5.9. TEST ENVIRONMENT	11
5.10. DESCRIPTION OF TEST SETUP	12
5.11. MEASURING INSTRUMENT AND SOFTWARE USED.....	13
6. ANTENNA PORT TEST RESULTS	14
6.1. ON TIME AND DUTY CYCLE	14
6.2. 20 dB BANDWIDTH & 99% DTS BANDWIDTH	16
6.2.1. GFSK MODE.....	17
6.2.2. 8-DPSK MODE.....	19
6.3. PEAK CONDUCTED OUTPUT POWER.....	21
6.3.1. GFSK MODE.....	22
6.3.2. 8-DPSK MODE.....	24
6.4. CARRIER HOPPING CHANNEL SEPARATION.....	26
6.4.1. GFSK MODE.....	27
6.4.2. 8-DPSK MODE.....	28
6.5. NUMBER OF HOPPING FREQUENCY	29
6.5.1. GFSK MODE.....	30
6.5.2. 8-DPSK MODE.....	31
6.6. TIME OF OCCUPANCY (DWELL TIME).....	32
6.6.1. GFSK MODE.....	33
6.6.2. 8-DPSK MODE.....	35

6.7.	CONDUCTED BANDEDGE	37
6.7.1.	GFSK MODE.....	38
6.7.1.	8-DPSK MODE.....	40
7.	RADIATED TEST RESULTS	43
7.1.	LIMITS AND PROCEDURE	43
7.2.	RESTRICTED BANDEDGE	47
7.2.1.	GFSK MODE.....	47
7.2.2.	8-DPSK MODE.....	51
7.3.	SPURIOUS EMISSIONS (1~25GHz)	55
7.3.1.	GFSK MODE.....	55
7.4.	SPURIOUS EMISSIONS 30M ~ 1 GHz.....	61
7.4.1.	GFSK MODE.....	61
7.5.	SPURIOUS EMISSIONS BELOW 30M.....	63
8.	AC POWER LINE CONDUCTED EMISSIONS	64
9.	ANTENNA REQUIREMENTS	67

1. ATTESTATION OF TEST RESULTS

Applicant Information

Company Name: Gibson Innovations Limited
Address: 5/F., Philips Electronics Building, 5 Science Park East Avenue, Hong Kong Science Park, Shatin, New Territories, Hong Kong

Manufacturer Information

Company Name: Gibson Innovations Limited
Address: 5/F., Philips Electronics Building, 5 Science Park East Avenue, Hong Kong Science Park, Shatin, New Territories, Hong Kong

Factory Information

Company Name: WKK Technology Ltd.
Address: 33 Gangjian Lu, Tutang, Changping, Dongguan, Guangdong Province, P.R. China
Brand Name: PHILIPS
Model Name: BT7900*/##
Model Difference: "*" denoted can be A-Z consist of the different cabinet colour. "##" denoted can be /07, /17, /27 and /37 consist of the various accessories/feature by-packed.
Date Tested: January 05, 2017 ~ January 11, 2017

APPLICABLE STANDARDS	
STANDARD	TEST RESULTS
CFR 47 Part 15 Subpart C	PASS

Tested By:

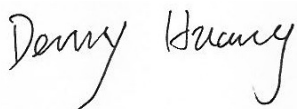

Denny Huang
Engineer Project Associate

Checked By:



Shawn Wen
Laboratory Leader

Approved By:



Stephen Guo
Laboratory Manager

2. TEST METHODOLOGY

The tests documented in this report were performed in accordance with FCC CFR 47 Part 2, FCC CFR 47 Part 15, ANSI C63.10-2013.

3. FACILITIES AND ACCREDITATION

Test Location	Dongguan Dongdian Testing Service Co., Ltd
Address	No. 17, Zongbu Road 2, Songshan Lake Sci&Tech Park, Dongguan City, Guangdong Province, 523808, China
Accreditation Certificate	<p>Dongguan Dongdian Testing Service Co., Ltd. EMC Laboratory has been accredited by A2LA for technical competence in the field of electrical testing, and proved to be in compliance with ISO/IEC 17025: 2005 General Requirements for the Competence of Testing and Calibration Laboratories and any additional program requirements in the identified field of testing. Valid time is until January 31, 2018.</p> <p>Dongguan Dongdian Testing Service Co., Ltd. EMC Laboratory has been registered and fully described in a report filed with the FCC (Federal Communications Commission). The acceptance letter from the FCC is maintained in our files. Registration 270092, Renewal date March 11, 2015, valid time is until March 11, 2018.</p> <p>The 3m Alternate Test Site of Dongguan Dongdian Testing Service Co., Ltd. has been registered by Certification and Engineering Bureau of Industry Canada for the performance of radiated measurements with Registration No. 10288A on April 23, 2015, valid time is until April 23, 2018.</p>

4. CALIBRATION AND UNCERTAINTY

4.1. MEASURING INSTRUMENT CALIBRATION

The measuring equipment utilized to perform the tests documented in this report has been calibrated in accordance with the manufacturer's recommendations, and is traceable to recognized national standards.

4.2. MEASUREMENT UNCERTAINTY

Where relevant, the following measurement uncertainty levels have been estimated for tests performed on the apparatus:

Test Item	Uncertainty
Uncertainty for Conduction emission test	3.32dB (150KHz-30MHz)
	3.72dB (9KHz-150KHz)
Uncertainty for Radiation Emission test(include Fundamental emission) (30MHz-1GHz)	4.70 dB (Antenna Polarize: V)
	4.84 dB (Antenna Polarize: H)
Uncertainty for Radiation Emission test (1GHz to 26GHz)(include Fundamental emission)	4.10dB(1-6GHz)
	4.40dB (6GHz-18Gz)
	3.54dB (18GHz-26Gz)
Bandwidth	1.1%
Stop Transmitting Time Test	0.6%
Note: This uncertainty represents an expanded uncertainty expressed at approximately the 95% confidence level using a coverage factor of k=2.	

5. EQUIPMENT UNDER TEST

5.1. DESCRIPTION OF EUT

Equipment	"EverPlay" Wireless Portable Speaker	
Model Name	BT7900*/##	
Product Description	Operation Frequency	2402 MHz ~ 2480 MHz
	Modulation Type	Data Rate
	GFSK	1Mbps
	π/4-DQPSK	2Mbps
	8-DPSK	3Mbps
Battery	3.6V, 4000mAh	
Bluetooth Version	BT 2.1+EDR	
Rated Input	5~9V, Max 2A	

5.2. MAXIMUM OUTPUT POWER

Frequency Range (MHz)	Number of Transmit Chains (NTX)	Bluetooth Mode	Frequency (MHz)	Channel Number	Max EIRP (dBm)
2400-2483.5	1	GFSK	2402-2480	0-78[79]	-8.00
2400-2483.5	1	8-DPSK	2402-2480	0-78[79]	-7.87

5.3. PACKET TYPE CONFIGURATION

Test Mode	Packet Type	Setting
GFSK	DH1	27
	DH3	183
	DH5	339
π/4-DQPSK	2-DH1	54
	2-DH3	367
	2-DH5	679
8-DPSK	3-DH1	83
	3-DH3	552
	3-DH5	1021

5.4. CHANNEL LIST

Channel	Frequency (MHz)	Channel	Frequency (MHz)	Channel	Frequency (MHz)	Channel	Frequency (MHz)
00	2402	20	2422	40	2442	60	2462
01	2403	21	2423	41	2443	61	2463
02	2404	22	2424	42	2444	62	2464
03	2405	23	2425	43	2445	63	2465
04	2406	24	2426	44	2446	64	2466
05	2407	25	2427	45	2447	65	2467
06	2408	26	2428	46	2448	66	2468
07	2409	27	2429	47	2449	67	2469
08	2410	28	2430	48	2450	68	2470
09	2411	29	2431	49	2451	69	2471
10	2412	30	2432	50	2452	70	2472
11	2413	31	2433	51	2453	71	2473
12	2414	32	2434	52	2454	72	2474
13	2415	33	2435	53	2455	73	2475
14	2416	34	2436	54	2456	74	2476
15	2417	35	2437	55	2457	75	2477
16	2418	36	2438	56	2458	76	2478
17	2419	37	2439	57	2459	77	2479
18	2420	38	2440	58	2460	78	2480
19	2421	39	2441	59	2461		

5.5. TEST CHANNEL CONFIGURATION

Test Mode	Test Channel Number	Test Channel
GFSK	CH 00, CH 39, CH 78	Low, Middle, High
8-DPSK	CH 00, CH 39, CH 78	Low, Middle, High

5.6. THE WORSE CASE POWER SETTING PARAMETER

The Worst Case Power Setting Parameter under 2400 ~ 2483.5MHz Band				
Test Software		RDA_BT_Tester		
Modulation Type	Transmit Antenna Number	Test Channel		
		CH 00	CH 39	CH 78
GFSK	1	10	10	10
8-DPSK	1	10	10	10

5.7. DESCRIPTION OF AVAILABLE ANTENNAS

Ant.	Frequency (MHz)	Antenna Type	Antenna Gain (dBi)
1	2402-2480	PCB Antenna	4.56

Test Mode	Transmit and Receive Mode	Description
GFSK	<input checked="" type="checkbox"/> 1TX, 1RX	Chain 1 can be used as transmitting/receiving antenna.
8-DPSK	<input checked="" type="checkbox"/> 1TX, 1RX	Chain 1 can be used as transmitting/receiving antenna.

5.8. WORST-CASE CONFIGURATIONS

Bluetooth Mode	Modulation Technology	Modulation Type	Data Rate (Mbps)
BR	FHSS	GFSK	1Mbit/s
EDR	FHSS	8-DPSK	3Mbit/s

Note: Pre-Scan has been conducted to determine the worst-case mode from all possible combinations between available modulations, data rates.

5.9. TEST ENVIRONMENT

Environment Parameter	Selected Values During Tests	
Relative Humidity	55 ~ 65%	
Atmospheric Pressure:	1025Pa	
Temperature	TN	23 ~ 28°C
Voltage :	VL	N/A
	VN	DC 3.6V/DC 5V
	VH	N/A

Note: VL= Lower Extreme Test Voltage
 VN= Nominal Voltage, DC 5V from USB port, DC 3.6V from battery.
 VH= Upper Extreme Test Voltage
 TN= Normal Temperature

5.10. DESCRIPTION OF TEST SETUP

SUPPORT EQUIPMENT

Item	Equipment	Brand Name	Model Name	FCC ID
1	Notebook	DELL	Latitude D610	N/A
2	USB to TTL Serial Cable	N/A	N/A	N/A

I/O CABLES

Cable No	Port	Connector Type	Cable Type	Cable Length(m)	Remarks
1	DC In	DC	Unshielded	1.0	N/A
2	Aux in	AUX	Unshielded	1.0	N/A

ACCESSORY

Item	Accessory	Brand Name	Model Name	Description
1	Power Adapter	N/A	N/A	N/A

TEST SETUP

The EUT can work in an engineer mode with a software through a Laptop.

SETUP DIAGRAM FOR TESTS

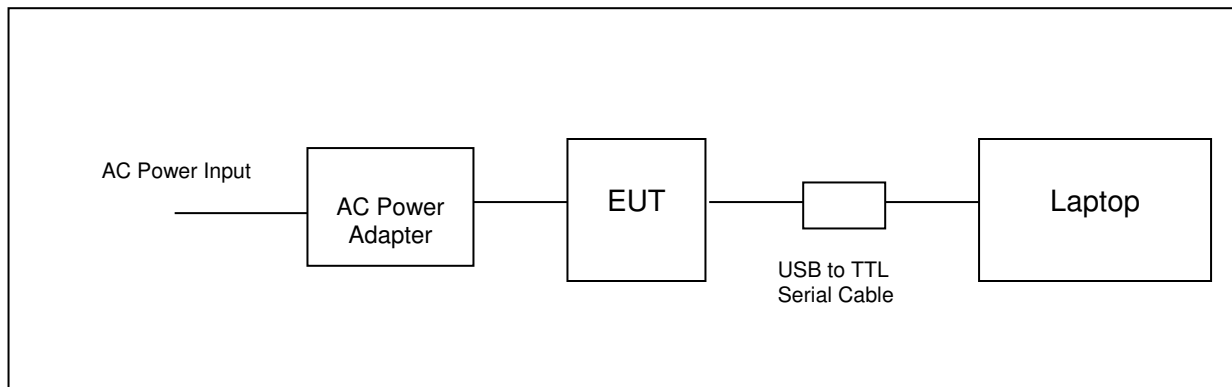

5.11. MEASURING INSTRUMENT AND SOFTWARE USED

Instrument (Conducted for RF Port)						
Used	Equipment	Manufacturer	Model No.	Serial No.	Last Cal.	Cal. Interval
<input checked="" type="checkbox"/>	Spectrum Analyzer	R&S	FSU26	1166.1660.26	2016/10/16	1 Year
Instrument (Radiated Tests)						
Used	Equipment	Manufacturer	Model No.	Serial No.	Last Cal.	Expired date
<input checked="" type="checkbox"/>	EMI Test Receiver	R&S	ESU8	100316	2016/10/16	1 Year
<input checked="" type="checkbox"/>	Spectrum analyzer	R&S	FSU26	1166.1660.26	2016/10/16	1 Year
<input checked="" type="checkbox"/>	Trilog Broadband Antenna	Schwarzbeck	VULB9163	9163-462	2016/10/27	1 Year
<input checked="" type="checkbox"/>	Active Loop antenna	Schwarzbeck	FMZB-1519	1519-038	2016/10/27	1 Year
<input checked="" type="checkbox"/>	Double Ridged Horn Antenna	R&S	HF907	100276	2016/10/12	1 Year
<input checked="" type="checkbox"/>	High Gain Horn Antenna	ETS-LINDGERN	3160-09	SEL0076	2016/10/16	1 Year
<input checked="" type="checkbox"/>	Pre-amplifier	A.H.	PAM-0118	360	2016/10/16	1 Year
<input checked="" type="checkbox"/>	Pre-amplifier	Compliance Directions Systems Inc.	PAP-1G26-48	6279.628	2016/01/06	1 Year
<input checked="" type="checkbox"/>	RF Cable	HUBSER	CP-X2	W11.03	2016/10/16	1 Year
<input checked="" type="checkbox"/>	RF Cable	HUBSER	CP-X1	W12.02	2016/10/16	1 Year
<input checked="" type="checkbox"/>	MI Cable	HUBSER	C10-01-01-1M	1091629	2016/10/16	1 Year
<input checked="" type="checkbox"/>	Test software	Audix	E3	V 6.11111b	N/A	N/A
Instrument (Line Conducted Emission (AC Main))						
Used	Equipment	Manufacturer	Model No.	Serial No.	Last Cal.	Expired date
<input checked="" type="checkbox"/>	Test Receiver	R&S	ESU8	100316	2016/10/16	1 Year
<input checked="" type="checkbox"/>	LISN 1	R&S	ENV216	101109	2016/10/16	1 Year
<input checked="" type="checkbox"/>	LISN 2	R&S	ESH2-Z5	100309	2016/10/16	1 Year
<input checked="" type="checkbox"/>	Pulse Limiter	R&S	ESH3-Z2	101242	2016/10/16	1 Year
<input checked="" type="checkbox"/>	CE Cable 1	HUBSER	ESU8/RF2	W10.01	2016/10/16	1 Year
<input checked="" type="checkbox"/>	Test software	Audix	E3	V 6.11111b	N/A	N/A

6. ANTENNA PORT TEST RESULTS

6.1. ON TIME AND DUTY CYCLE

LIMITS

None; for reporting purposes only

PROCEDURE

KDB 558074 Zero-Span Spectrum Analyzer Method

TEST SETUP

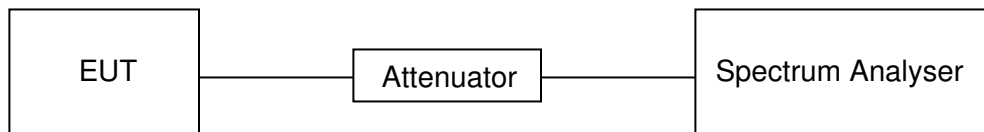

RESULTS

Mode	On Time (msec)	Period (msec)	Duty Cycle x (Linear)	Duty Cycle (%)	Duty Cycle Correction Factor (db)	1/B Minimum VBW (KHz)
GFSK	2.93	3.76	0.779	77.7	1.08	0.341
8-DPSK	2.92	3.76	0.777	77.7	1.10	0.342

Note: Duty Cycle Correction Factor= $10\log(1/x)$.
Where: x is Duty Cycle(Linear)

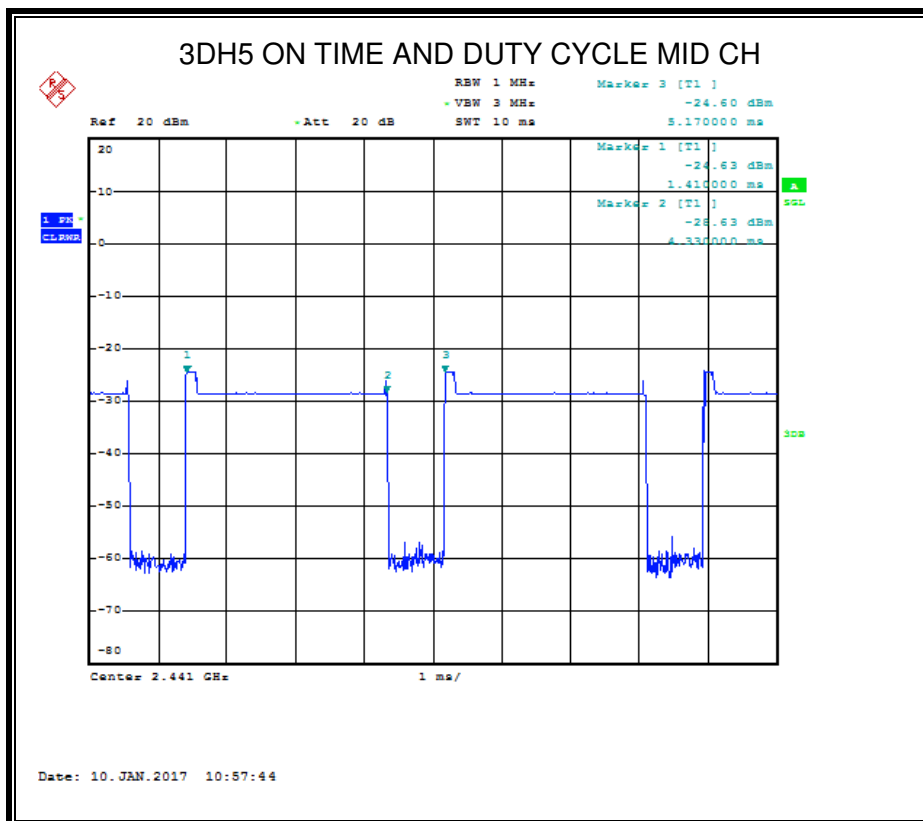
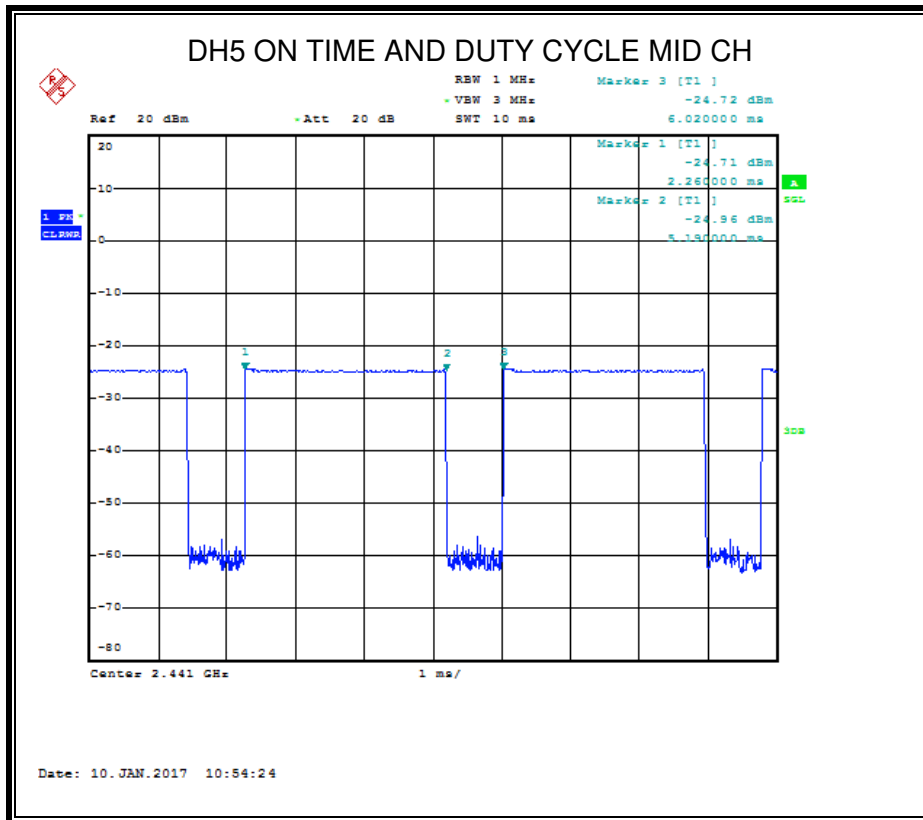

6.2. 20 dB BANDWIDTH & 99% DTS BANDWIDTH

LIMITS

FCC Part15 (15.247) , Subpart C			
Section	Test Item	Limit	Frequency Range (MHz)
FCC 15.247 (a) (1)	20dB Bandwidth	/	2400-2483.5

TEST PROCEDURE

Connect the UUT to the spectrum analyser and use the following settings:

Center Frequency	The centre frequency of the channel under test
Detector	Peak
RBW	$\geq 1\%$ of the 20 dB bandwidth
VBW	\geq RBW
Span	Approximately 2 to 3 times the 20 dB bandwidth, centered on a hopping channel
Trace	Max hold
Sweep	Auto couple

Allow the trace to stabilize and measure the maximum width of the emission that is constrained by the frequencies associated with the two outermost amplitude points (upper and lower frequencies) that are attenuated by 20 dB relative to the maximum level measured in the fundamental emission.

Use the 99% bandwidth function in the spectrum analyser and allow the trace to stabilize, then recorded the measurement data.

TEST SETUP

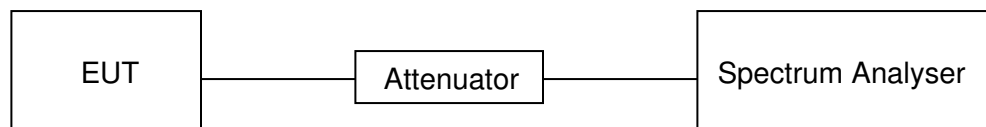

RESULTS

6.2.1. GFSK MODE

Channel	Frequency (MHz)	20dB bandwidth (MHz)	99% Bandwidth (MHz)	Result
Low	2402	1.084	0.928	Pass
Middle	2441	1.094	0.932	Pass
High	2480	1.088	0.928	Pass

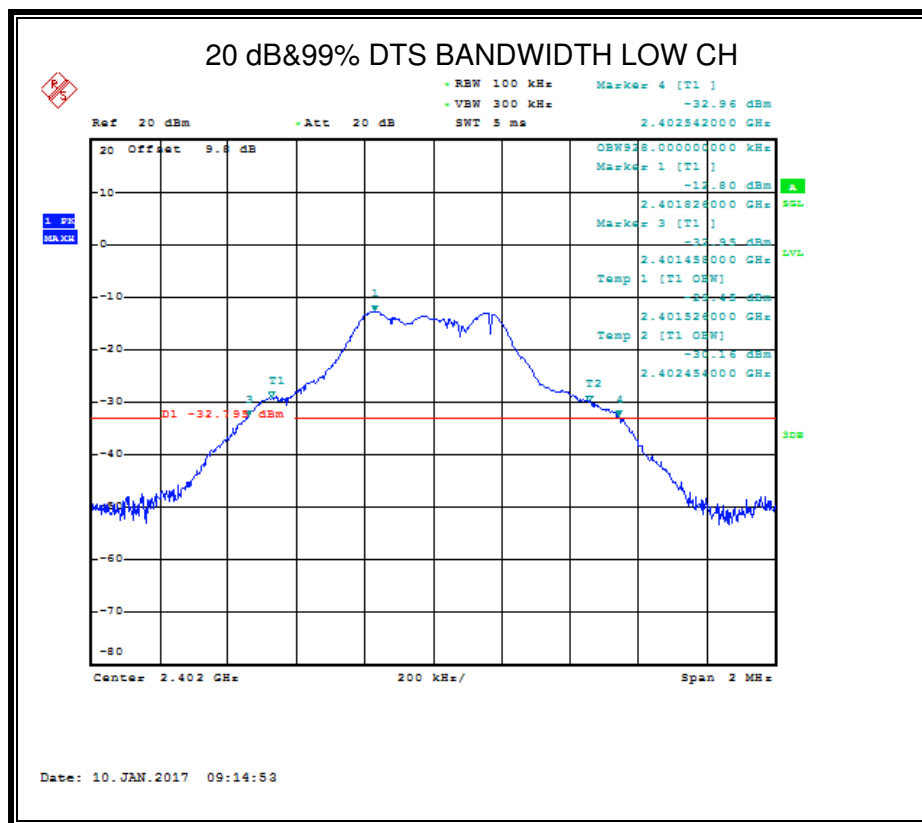

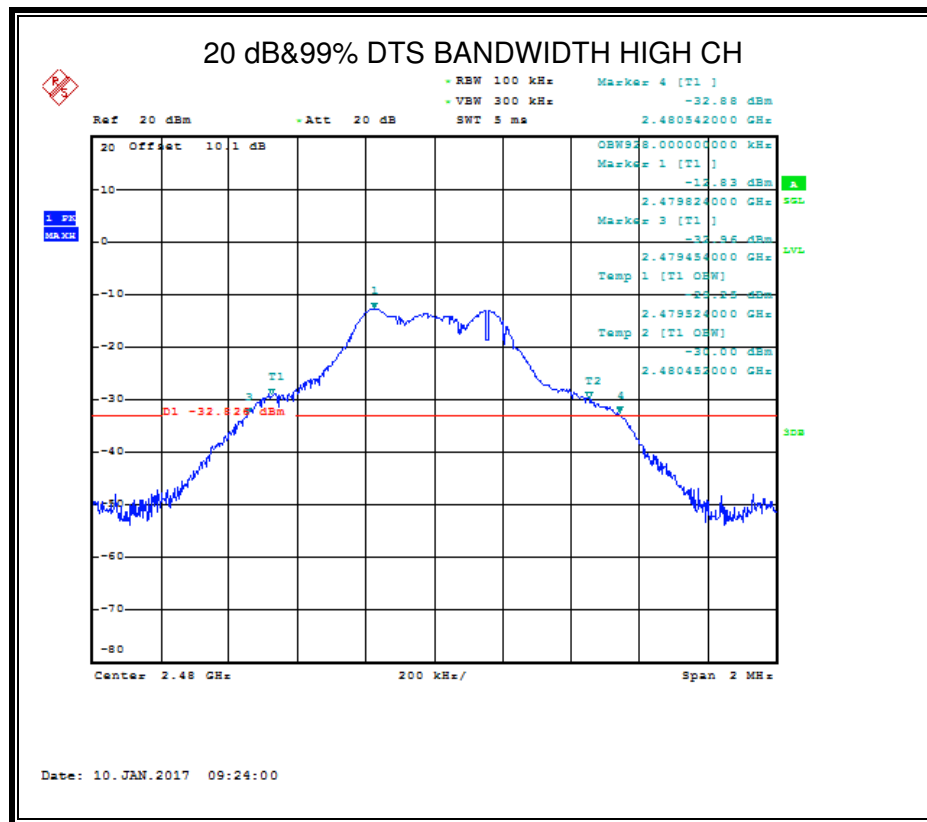
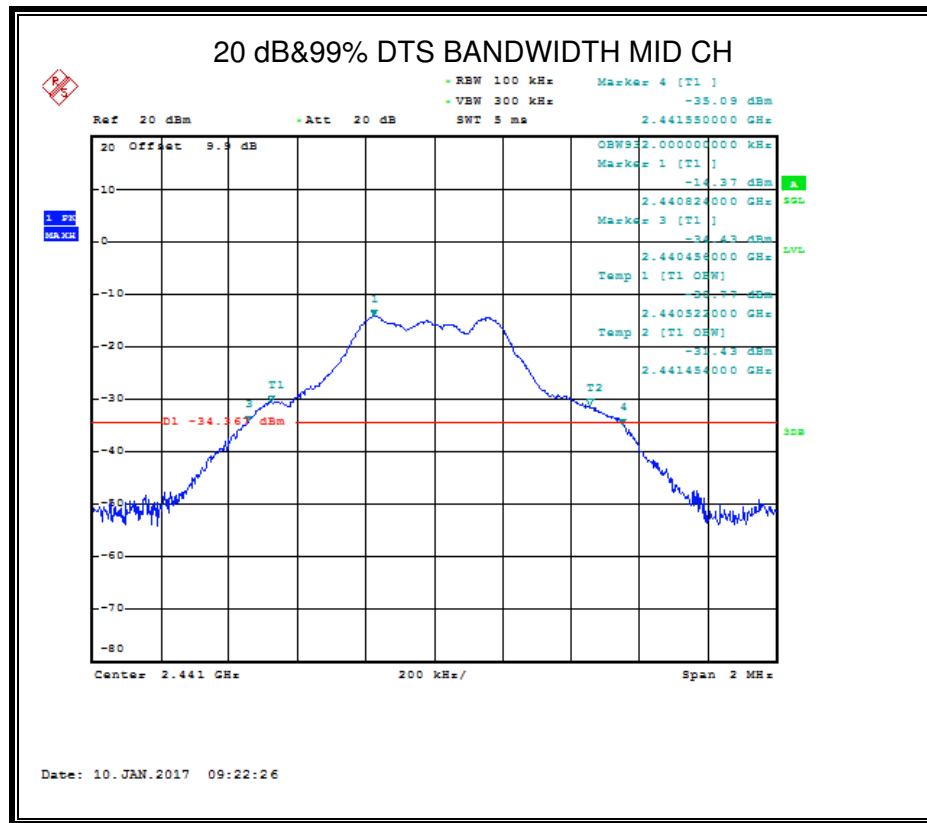

6.2.2. 8-DPSK MODE

Channel	Frequency (MHz)	20dB bandwidth (MHz)	99% Bandwidth (MHz)	Result
Low	2402	1.266	1.152	Pass
Middle	2441	1.266	1.152	Pass
High	2480	1.266	1.150	Pass

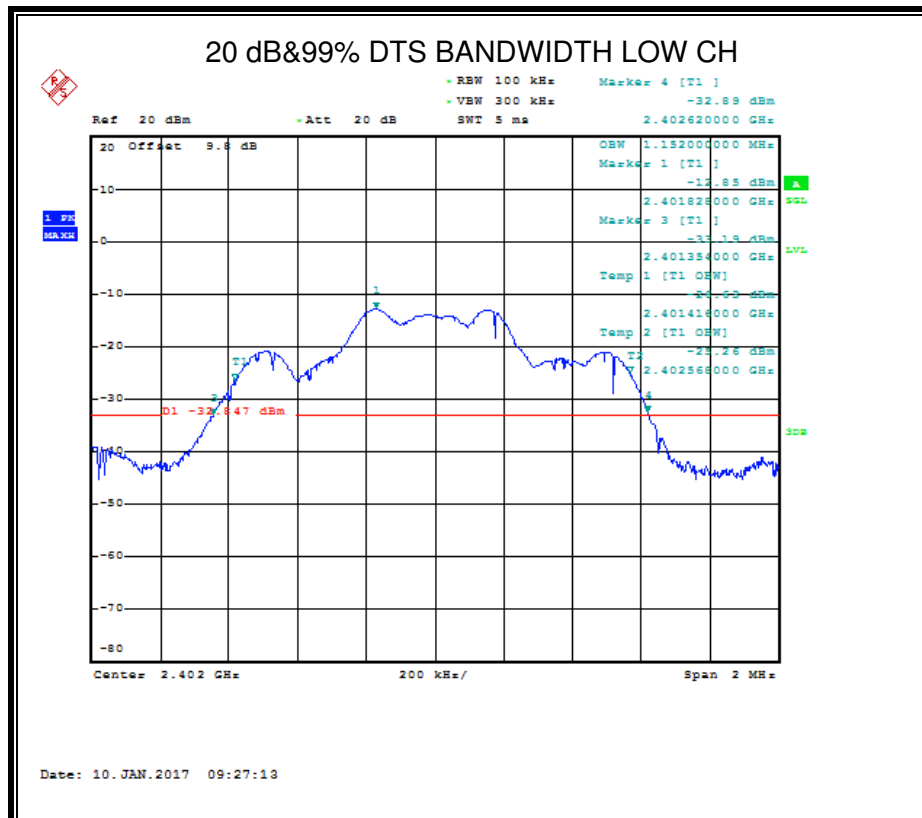

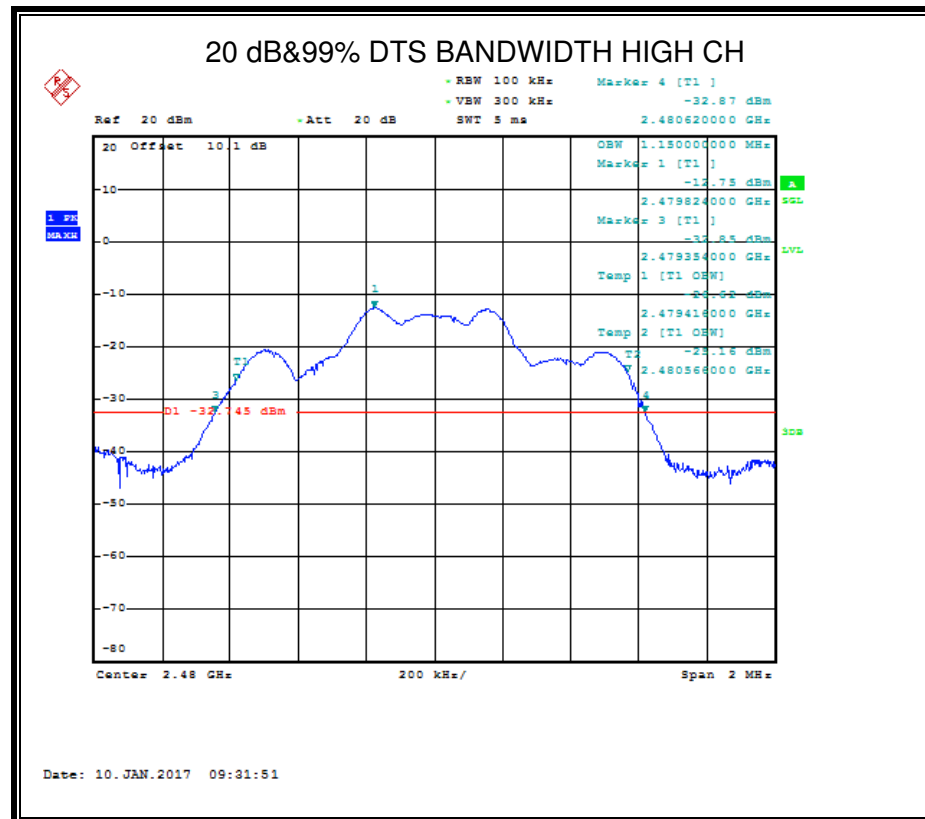
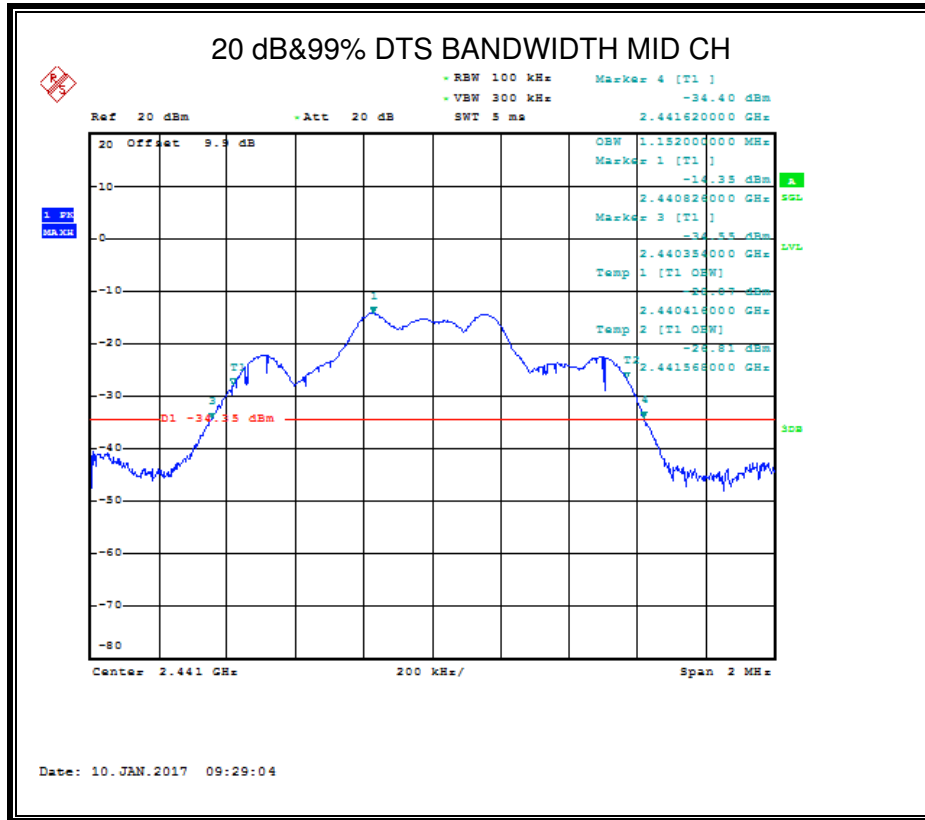

6.3. PEAK CONDUCTED OUTPUT POWER

LIMITS

FCC Part15 (15.247) , Subpart C			
Section	Test Item	Limit	Frequency Range (MHz)
FCC 15.247 (b) (1)	Peak Conducted Output Power	1 watt or 30dBm	2400-2483.5

TEST PROCEDURE

Connect the UUT to the spectrum analyser and use the following settings:

Center Frequency	The centre frequency of the channel under test
Detector	Peak
RBW	> the 20 dB bandwidth of the emission being measured (e.g. 1 MHz for BT)
VBW	≥RBW
Span	approximately 5 times the 20 dB bandwidth, centered on a hopping channel
Trace	Max hold
Sweep time	Auto couple

Allow trace to fully stabilize and use peak marker function to determine the peak amplitude level.

TEST SETUP

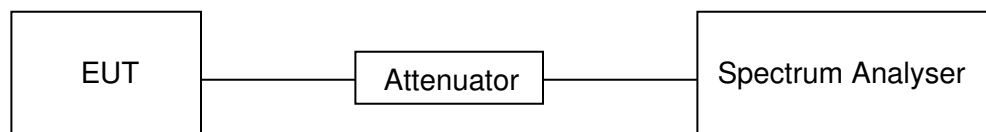

RESULTS

6.3.1. GFSK MODE

Channel	Frequency	Maximum Conducted Output Power(PK)	EIRP	Result
	(MHz)	(dBm)	(dBm)	
Low	2402	-12.560	-8.00	Pass
Middle	2441	-14.110	-9.55	Pass
High	2480	-12.560	-8.00	Pass

Note: EIRP = Maximum Conducted Output Power (PK) + Antenna Gain

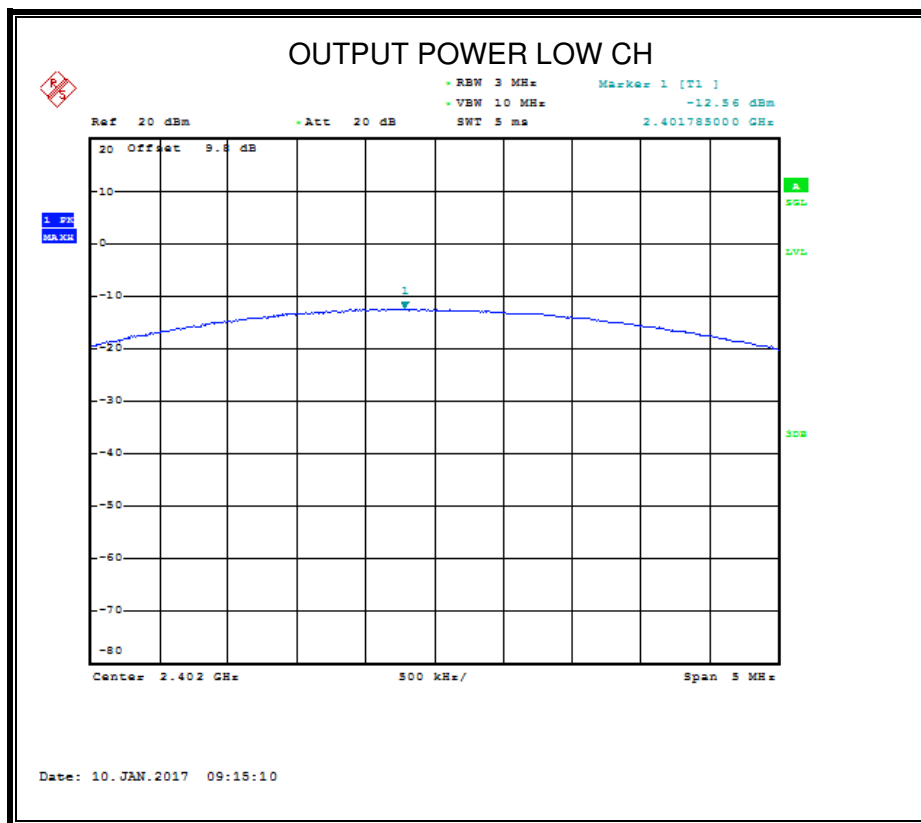

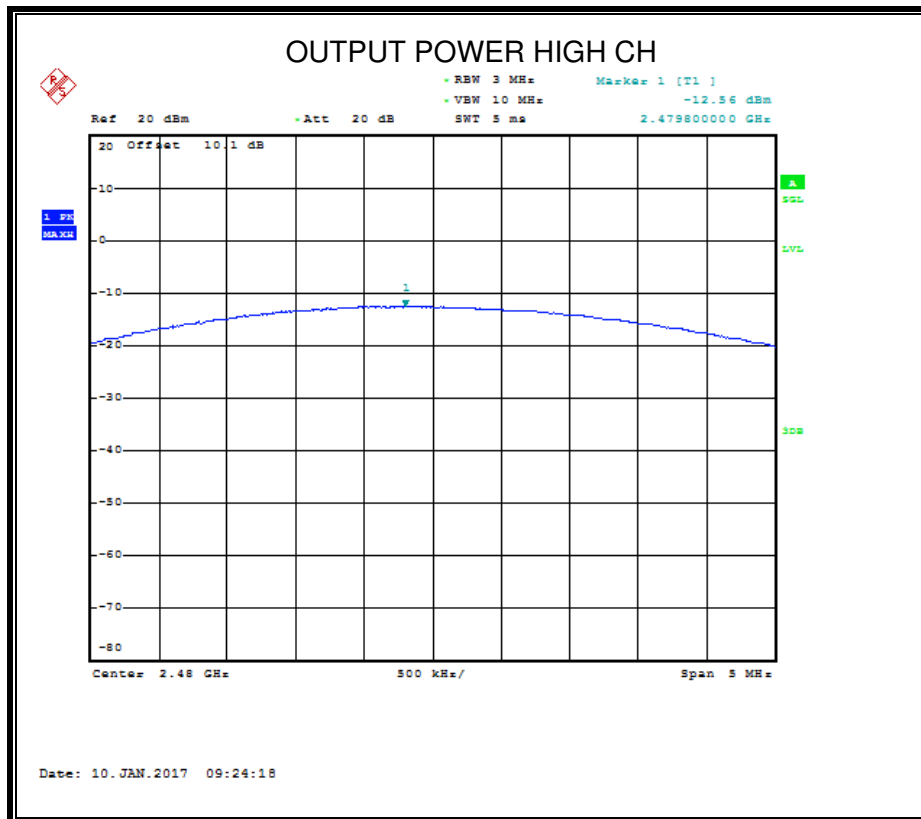
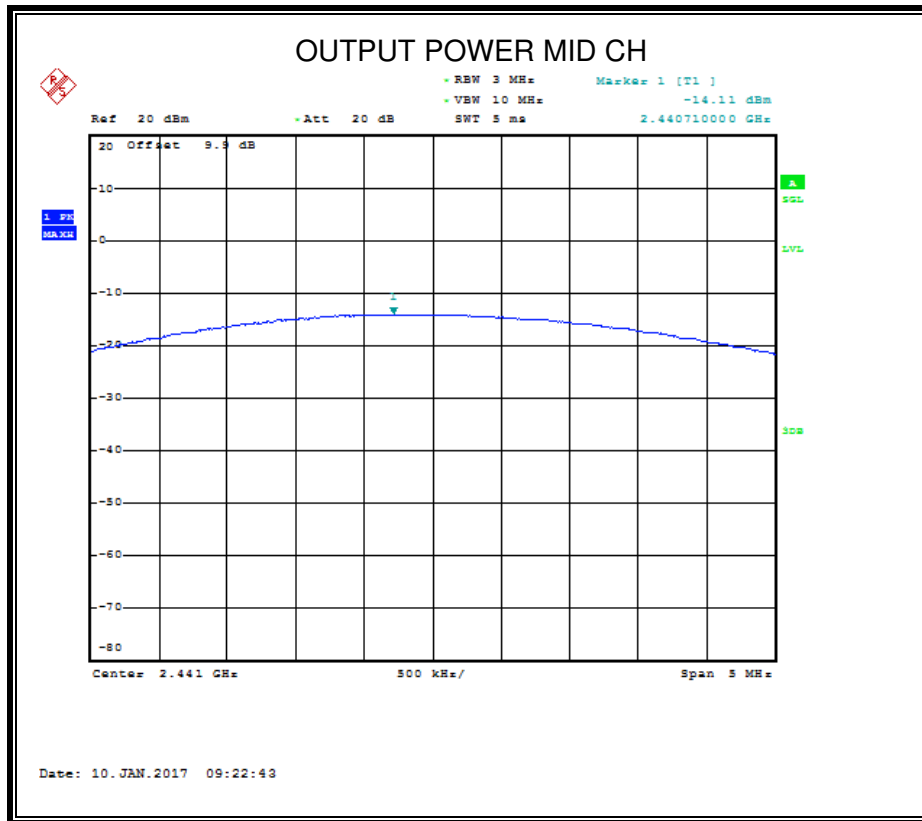

6.3.2. 8-DPSK MODE

Channel	Frequency	Maximum Conducted Output Power(PK)	EIRP	Result
	(MHz)	(dBm)	(dBm)	
Low	2402	-12.600	-8.04	Pass
Middle	2441	-13.960	-9.40	Pass
High	2480	-12.430	-7.87	Pass

Note: EIRP = Maximum Conducted Output Power (PK) + Antenna Gain

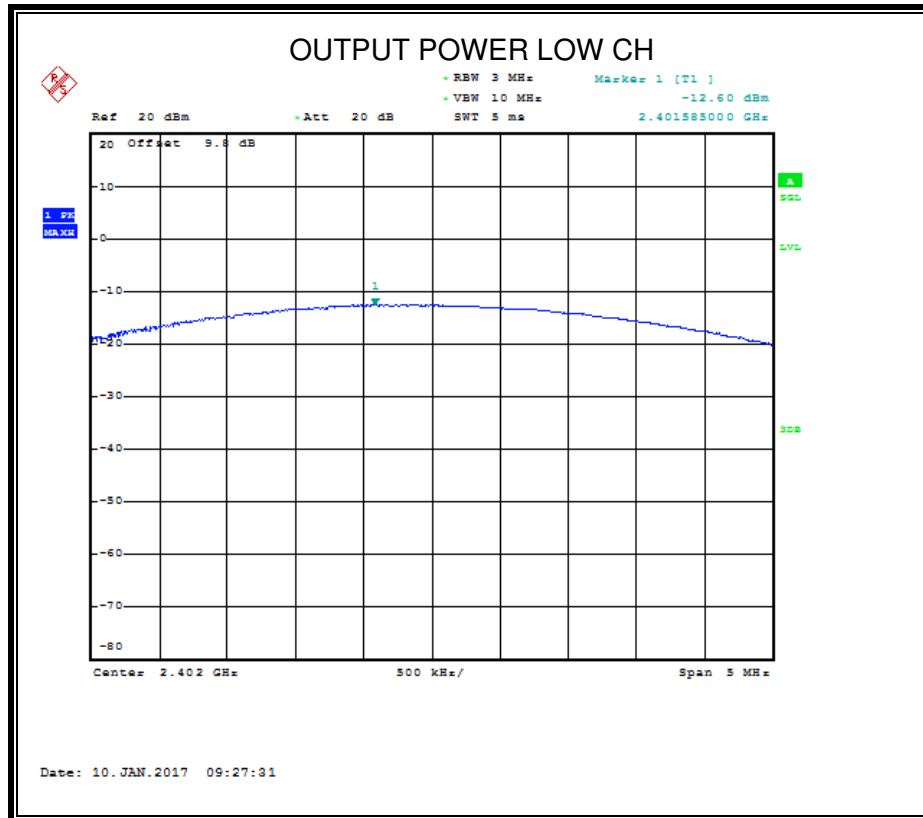

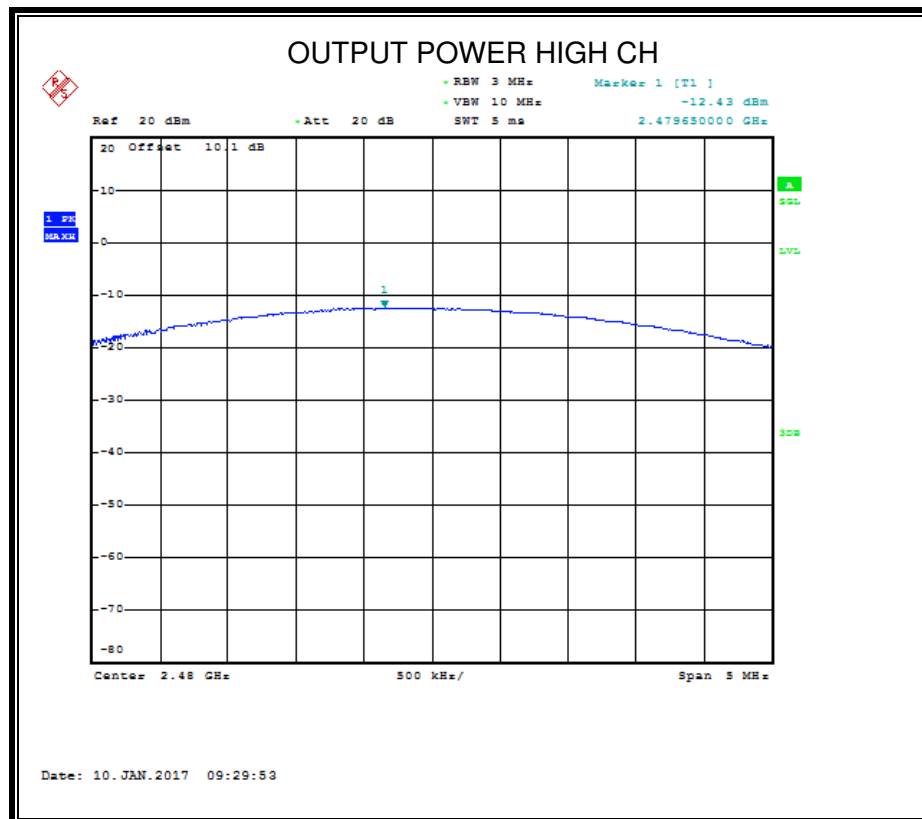
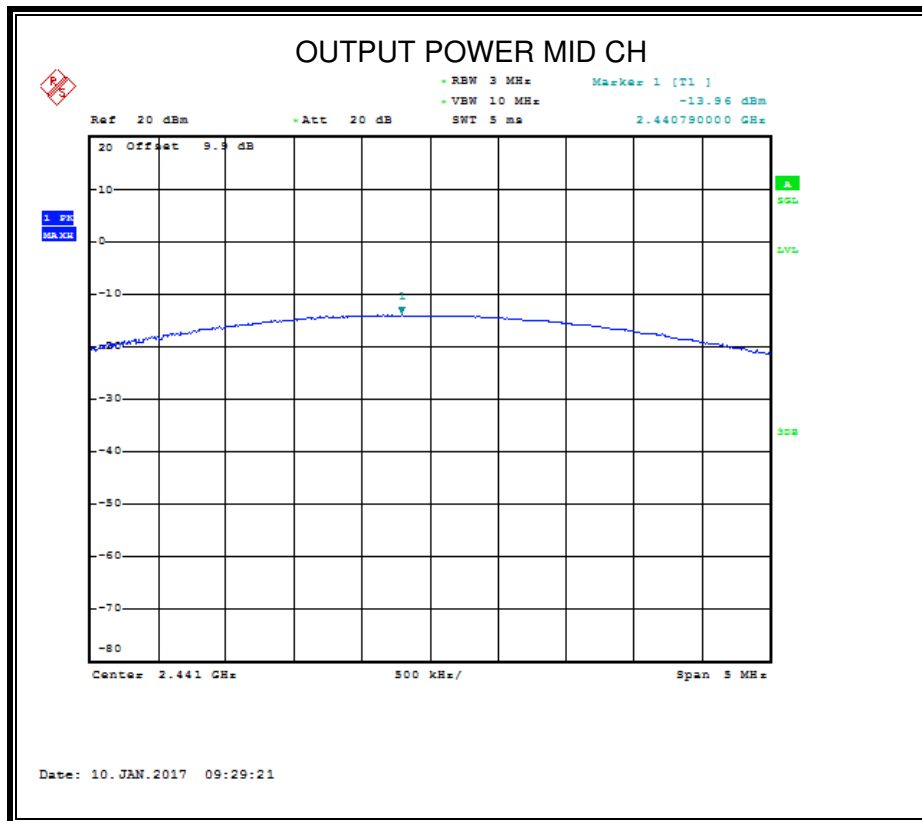

6.4. CARRIER HOPPING CHANNEL SEPARATION

LIMITS

FCC Part15 (15.247) , Subpart C			
Section	Test Item	Limit	Frequency Range (MHz)
FCC 15.247 (a) (1)	Carrier Hopping Channel Separation	25 kHz or two-thirds of the 20 dB bandwidth of the hopping channel, whichever is greater.	2400-2483.5

TEST PROCEDURE

Connect the UUT to the spectrum analyser and use the following settings:

Center Frequency	The centre frequency of the channel under test
Span	wide enough to capture the peaks of two adjacent channels
Detector	Peak
RBW	$\geq 1\%$ of the span
VBW	\geq RBW
Trace	Max hold
Sweep time	Auto couple

Allow the trace to stabilize. Use the marker-delta function to determine the separation between the peaks of the adjacent channels. The limit is specified in one of the subparagraphs of this Section. Submit this plot.

TEST SETUP

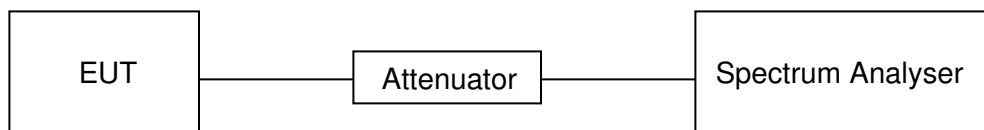

RESULTS

6.4.1. GFSK MODE

Channel	Carrier Hopping Channel Separation (MHz)	Limit (MHz)	Result
Middle	1.004	≥ two-thirds of the 20 dB Bandwidth Of The Hopping Channel	PASS

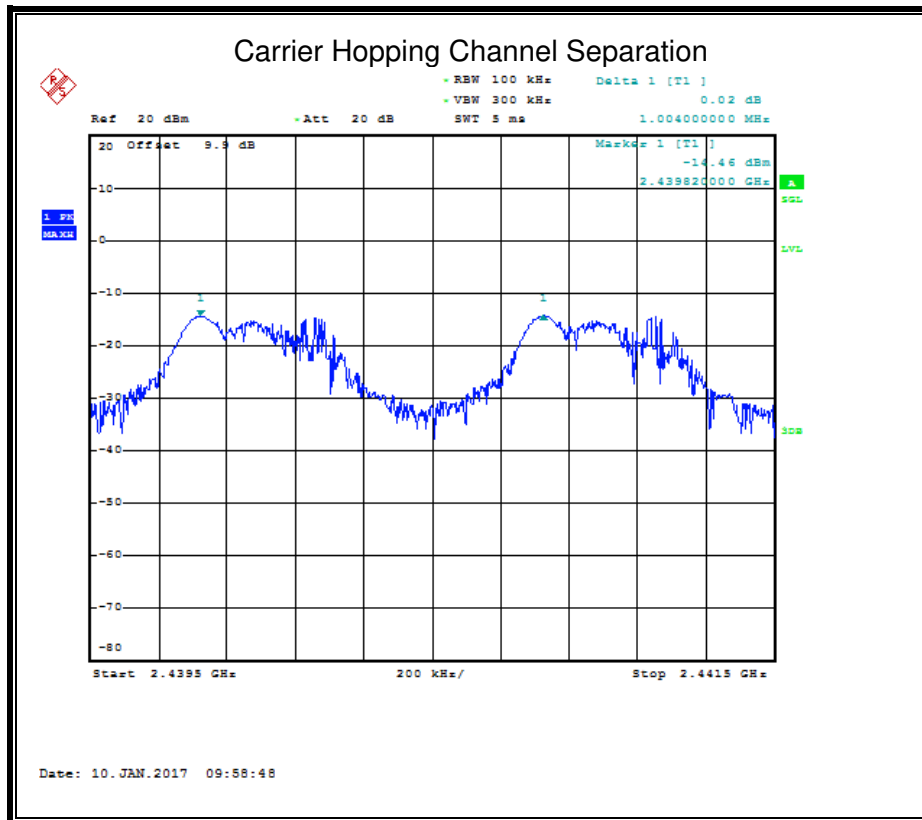

Note: For 20 dB Bandwidth of The Hopping Channel, please refer to clause 6.2.1.

6.4.2. 8-DPSK MODE

Channel	Carrier Hopping Channel Separation (MHz)	Limit (MHz)	Result
Middle	1.004	≥ two-thirds of the 20 dB Bandwidth Of The Hopping Channel	PASS

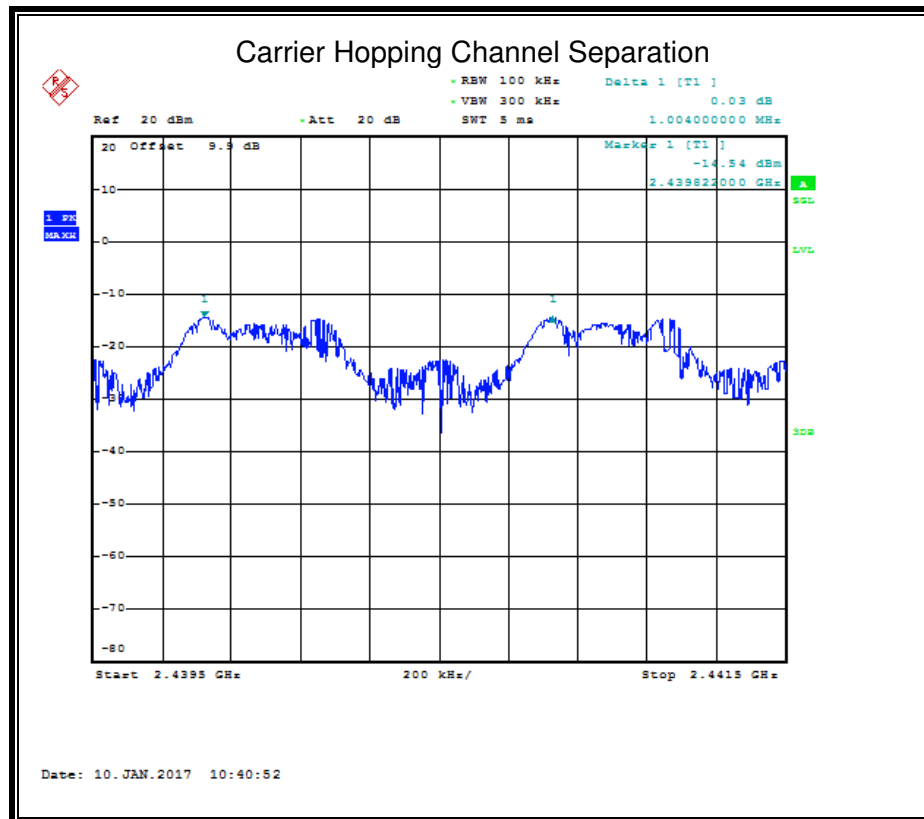

Note: For 20 dB Bandwidth of The Hopping Channel, please refer to clause 6.2.2.

6.5. NUMBER OF HOPPING FREQUENCY

LIMITS

FCC Part15 (15.247) , Subpart C		
Section	Test Item	Limit
15.247 (a) (1) III	Number of Hopping Frequency	at least 15 hopping channels

TEST PROCEDURE

Connect the EUT to the spectrum analyser and use the following settings:

Detector	Peak
RBW	1% of the span
VBW	≥RBW
Span	The frequency band of operation
Trace	Max hold
Sweep time	Auto couple

Set EUT to transmit maximum output power and switch on frequency hopping function. then set enough count time (larger than 5000 times) to get all the hopping frequency channel displayed on the screen of spectrum analyzer.

Count the quantity of peaks to get the number of hopping channels.

Normal Mode: 79 Channels observed.

AFH Mode: 20 Channels declared.

TEST SETUP

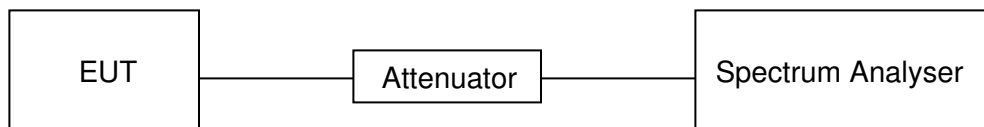

RESULTS

6.5.1. GFSK MODE

Hopping numbers	Limit	Results
79	>15	Pass

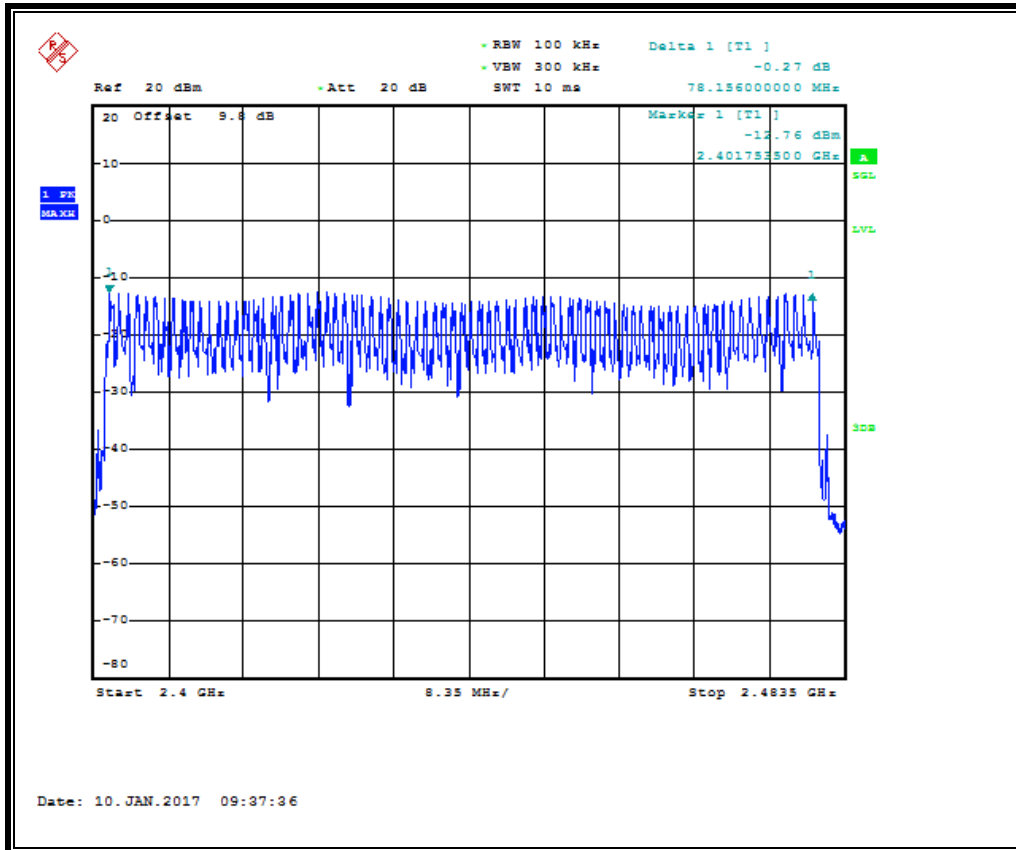

6.5.2. 8-DPSK MODE

Hopping numbers	Limit	Results
79	>15	Pass

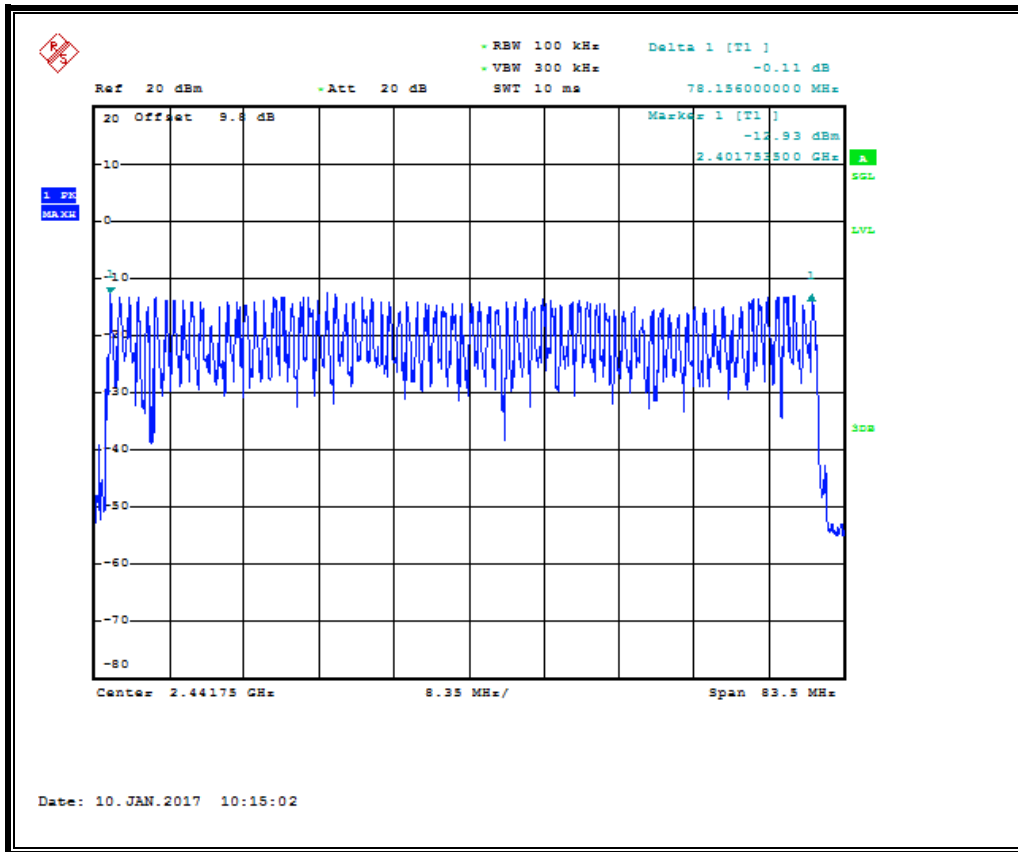

6.6. TIME OF OCCUPANCY (DWELL TIME)

LIMITS

FCC Part15 (15.247) , Subpart C		
Section	Test Item	Limit
15.247 (a) (1) III	Time of Occupancy (Dwell Time)	The average time of occupancy on any channel shall not be greater than 0.4 seconds within a period of 0.4 seconds, multiplied by the number of hopping channels employed.

TEST PROCEDURE

Connect the UUT to the spectrum analyser and use the following settings:

Center Frequency	The centre frequency of the channel under test
Detector	Peak
RBW	1 MHz
VBW	≥RBW
Span	zero span
Trace	Max hold
Sweep time	As necessary to capture the entire dwell time per hopping channel

- a. The transmitter output (antenna port) was connected to the spectrum analyzer
- b. Set RBW of spectrum analyzer to 1MHz and VBW to 1MHz.
- c. Use a video trigger with the trigger level set to enable triggering only on full pulses.
- d. Sweep Time is more than once pulse time.
- e. Set the center frequency on any frequency would be measure and set the frequency span to zero span.
- f. Measure the maximum time duration of one single pulse.
- g. Set the EUT for DH5, DH3 and DH1 packet transmitting.
- h. Measure the maximum time duration of one single pulse.
 $A \text{ Period Time} = (\text{channel number}) * 0.4$

For Normal Mode (79 Channel):

DH1 Time Slot: Reading * (1600/2)*31.6/(channel number)

DH3 Time Slot: Reading * (1600/4)*31.6/(channel number)

DH5 Time Slot: Reading * (1600/6)*31.6/(channel number)

For AFH Mode (20 Channel):

DH1 Time Slot: Reading * (1600/2)*8/(channel number)

DH3 Time Slot: Reading * (1600/4)*8/(channel number)

DH5 Time Slot: Reading * (1600/6)*8/(channel number)

TEST SETUP

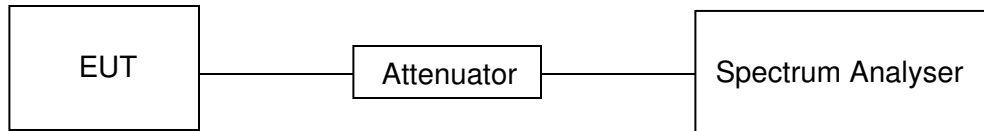

RESULTS

6.6.1. GFSK MODE

Normal Mode					
Packet	Channel	Burst Width [ms/hop/ch]	Dwell Time [ms]	Duty Cycle [%]	Results
DH1	MCH	0.40	128.00	0.32	PASS
DH3	MCH	1.68	268.80	0.67	PASS
DH5	MCH	2.93	312.53	0.78	PASS
AFH Mode					
DH1	MCH	0.40	128.00	0.32	PASS
DH3	MCH	1.68	268.80	0.67	PASS
DH5	MCH	2.93	312.53	0.78	PASS

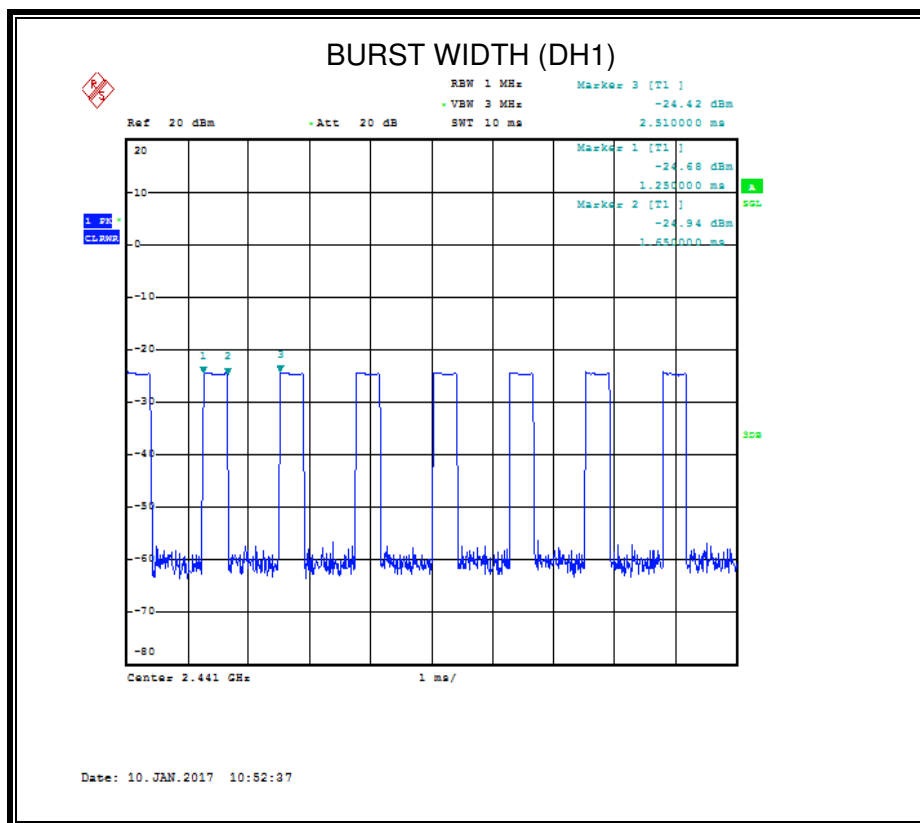

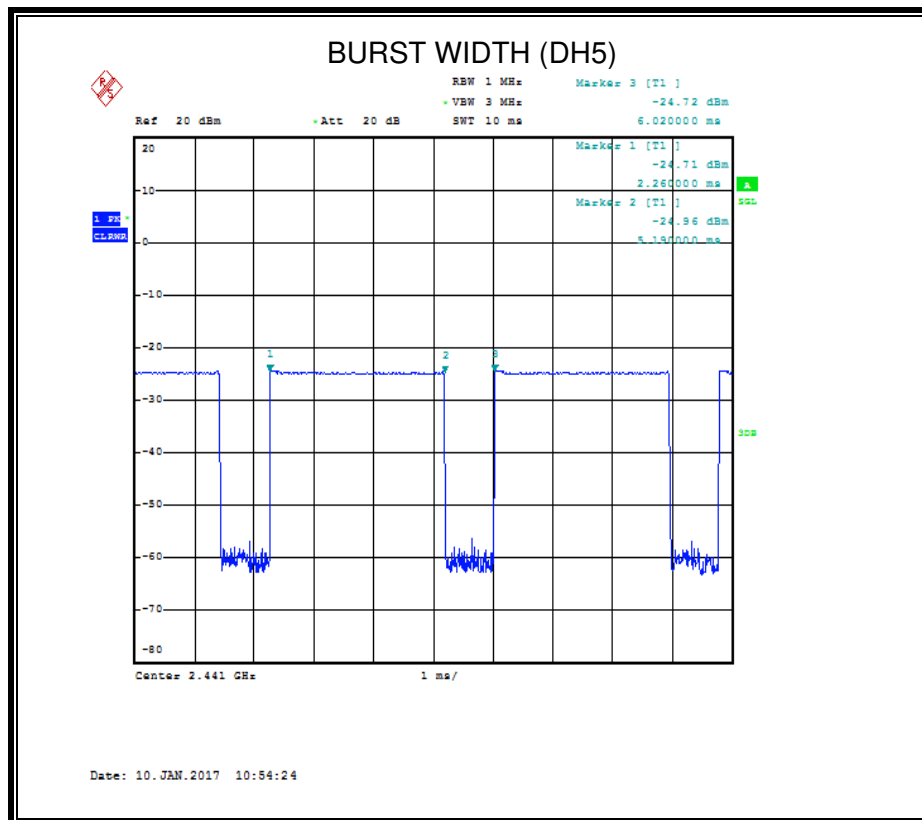
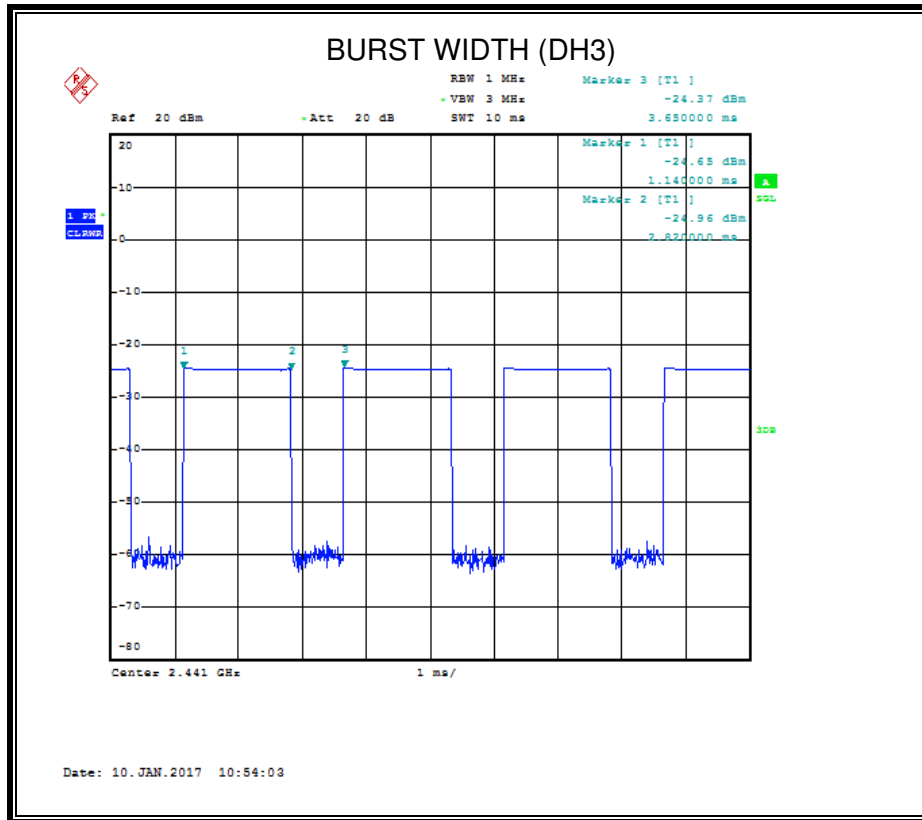

6.6.2. 8-DPSK MODE

Normal Mode					
Packet	Channel	Burst Width [ms/hop/ch]	Dwell Time [ms]	Duty Cycle [%]	Results
DH1	MCH	0.40	128.00	0.32	PASS
DH3	MCH	1.67	267.20	0.67	PASS
DH5	MCH	2.92	311.47	0.78	PASS
AFH Mode					
DH1	MCH	0.40	128.00	0.32	PASS
DH3	MCH	1.67	267.20	0.67	PASS
DH5	MCH	2.92	311.47	0.78	PASS

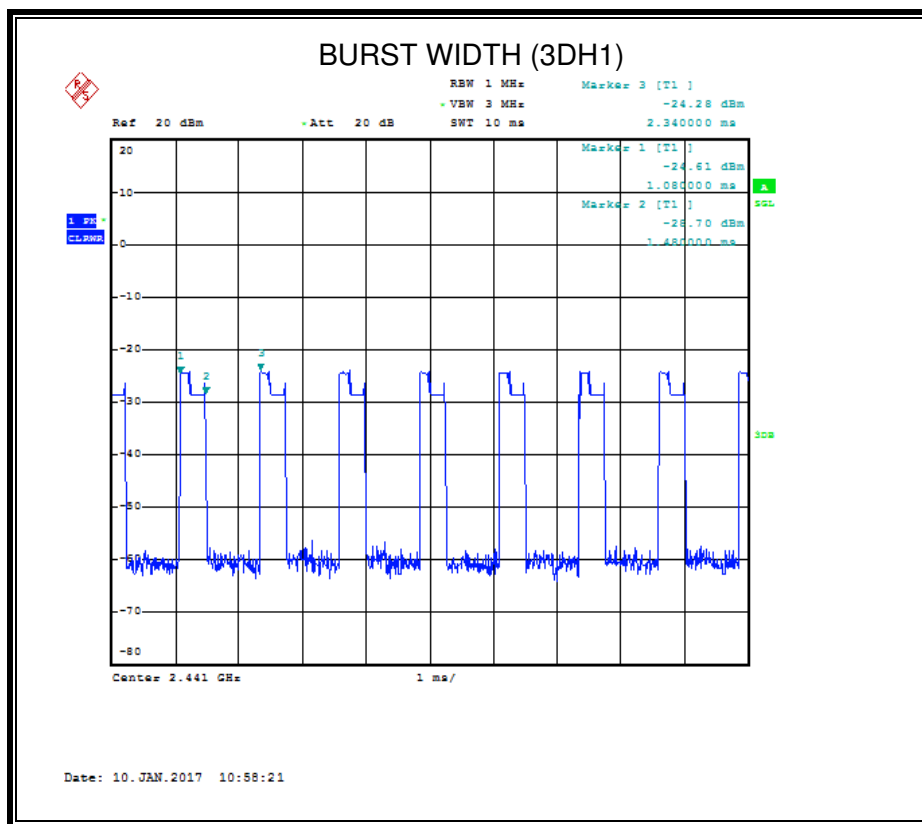

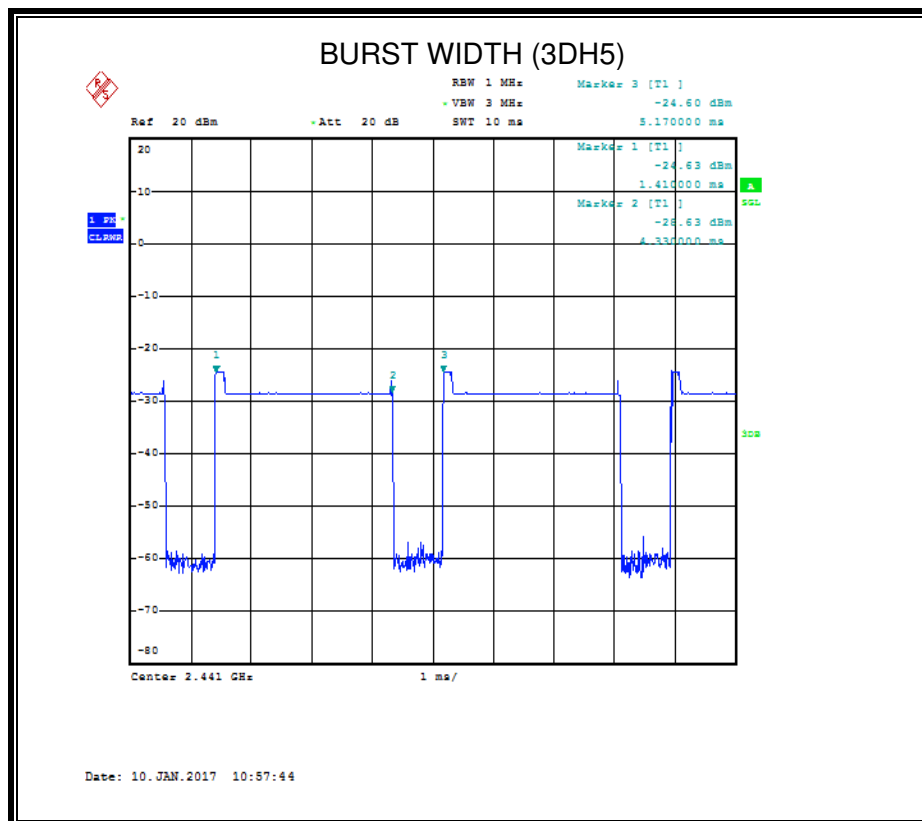
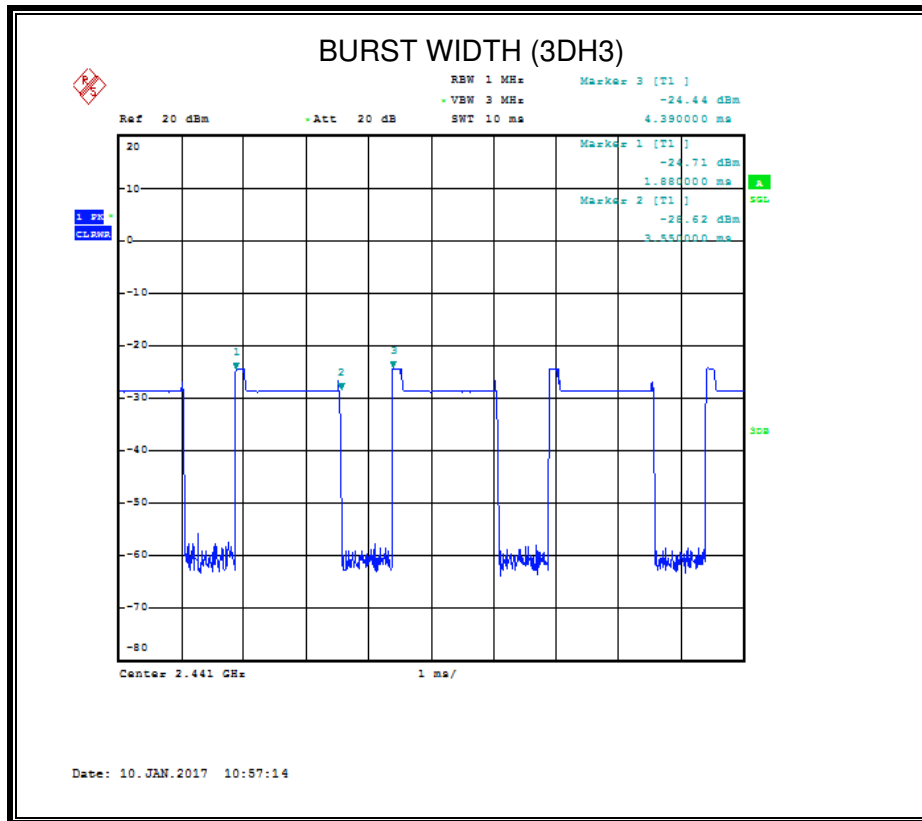

6.7. CONDUCTED BANDEDGE

LIMITS

FCC Part15 (15.247) , Subpart C		
Section	Test Item	Limit
FCC §15.247 (d)	Conducted Bandedge	at least 20 dB below that in the 100 kHz bandwidth within the band that contains the highest level of the desired power

TEST PROCEDURE

Connect the UUT to the spectrum analyser and use the following settings:

Span	Set the center frequency and span to encompass frequency range to be measured
Detector	Peak
RBW	100K
VBW	$\geq 3 \times \text{RBW}$
measurement points	$\geq \text{span}/\text{RBW}$
Trace	Max hold
Sweep time	Auto couple.

Use the peak marker function to determine the maximum amplitude level.

TEST SETUP

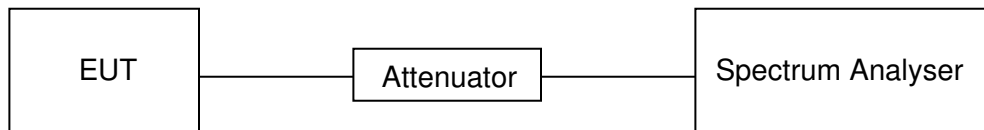

RESULTS

6.7.1. GFSK MODE

Channel	Carrier Frequency [MHz]	Carrier Power [dBm]	Frequency Hopping	Max Spurious Level [dBm]	Limit [dBm]	Results
LCH	2402	-12.830	Off	-51.47	-32.83	PASS
		-12.840	On	-52.02	-32.84	PASS
HCH	2480	-12.830	Off	-52.80	-32.83	PASS
		-12.850	On	-52.81	-32.85	PASS

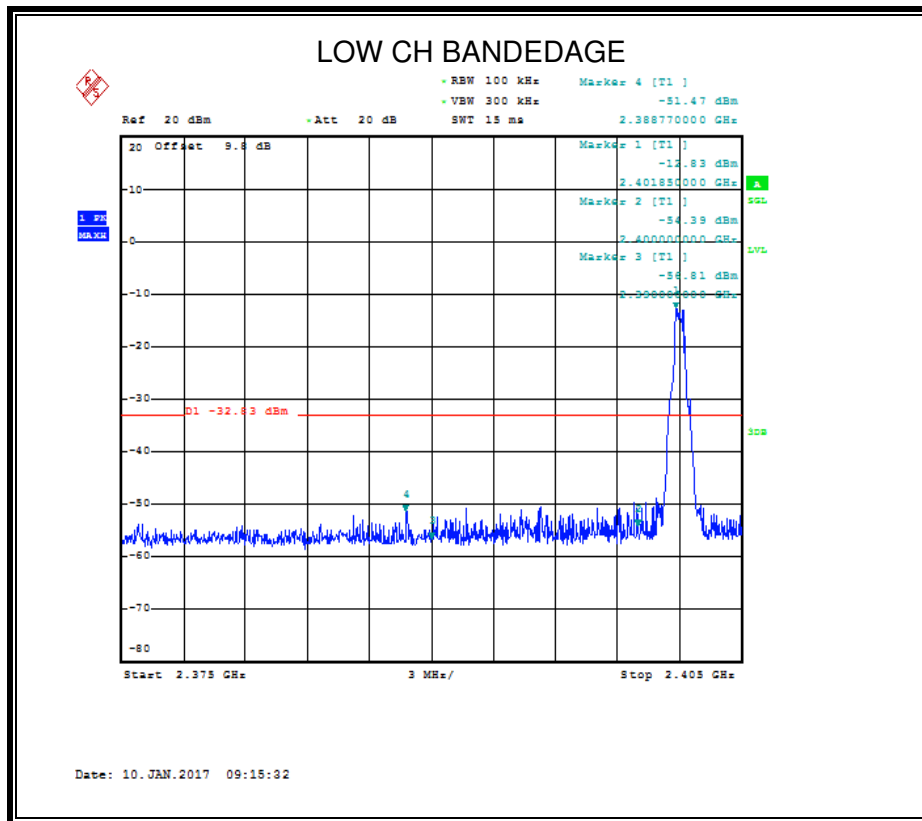

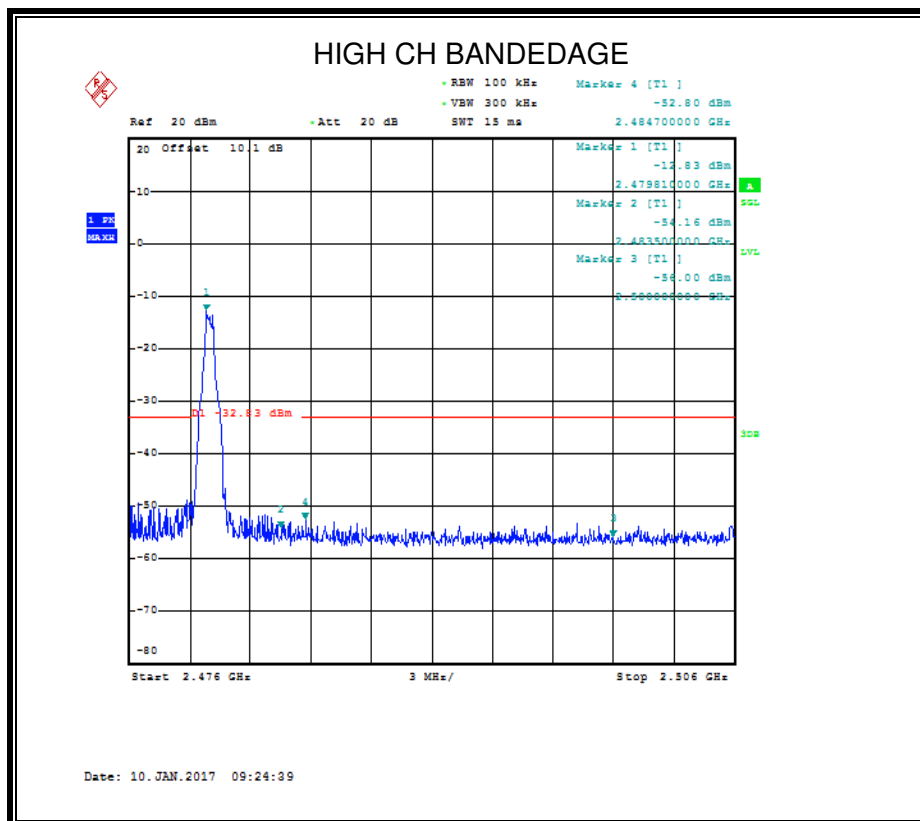
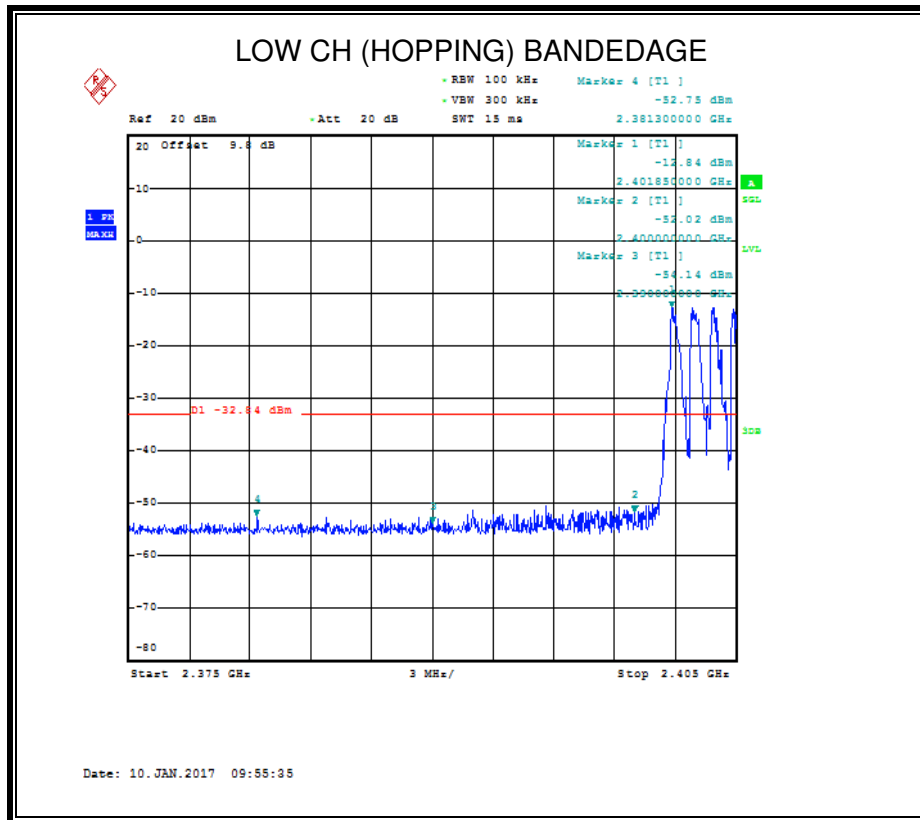

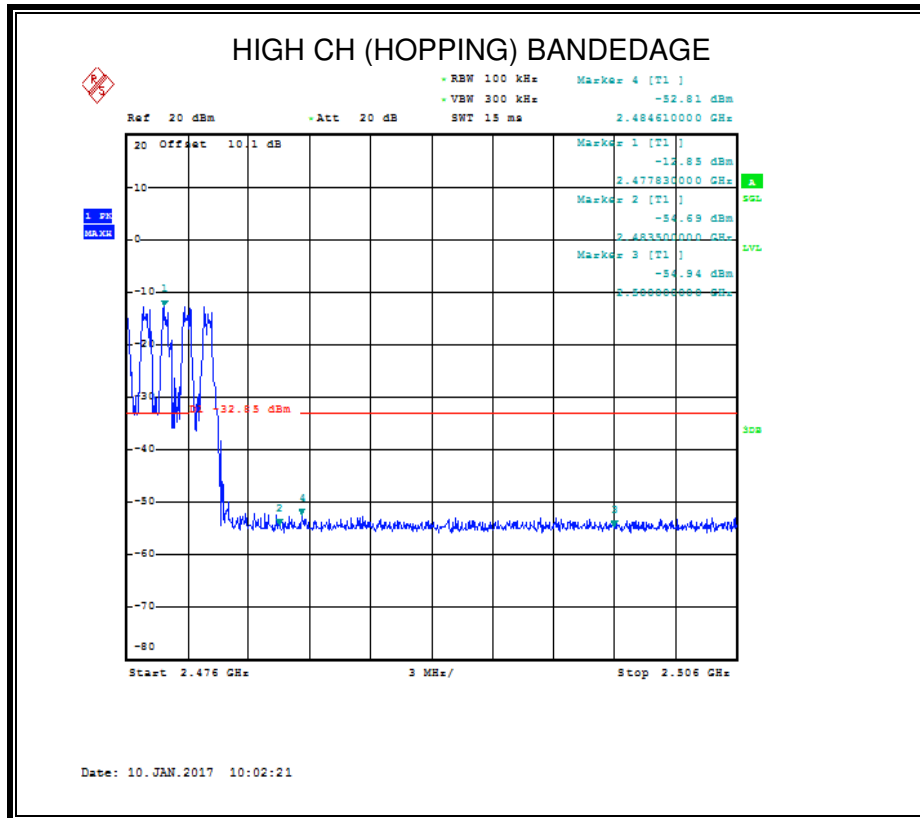

6.7.1. 8-DPSK MODE

Channel	Carrier Frequency [MHz]	Carrier Power [dBm]	Frequency Hopping	Max Spurious Level [dBm]	Limit [dBm]	Results
LCH	LCH	-13.070	Off	-49.34	-33.07	PASS
		-12.930	On	-51.56	-32.93	PASS
HCH	HCH	-12.830	Off	-52.37	-32.83	PASS
		-13.100	On	-52.02	-33.10	PASS

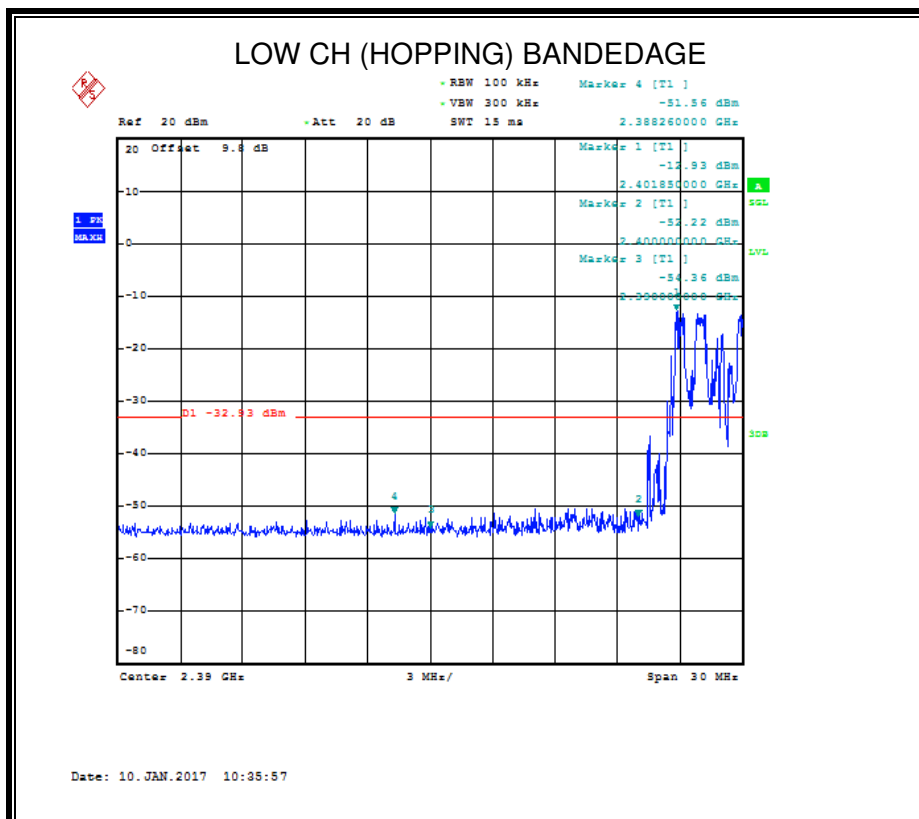
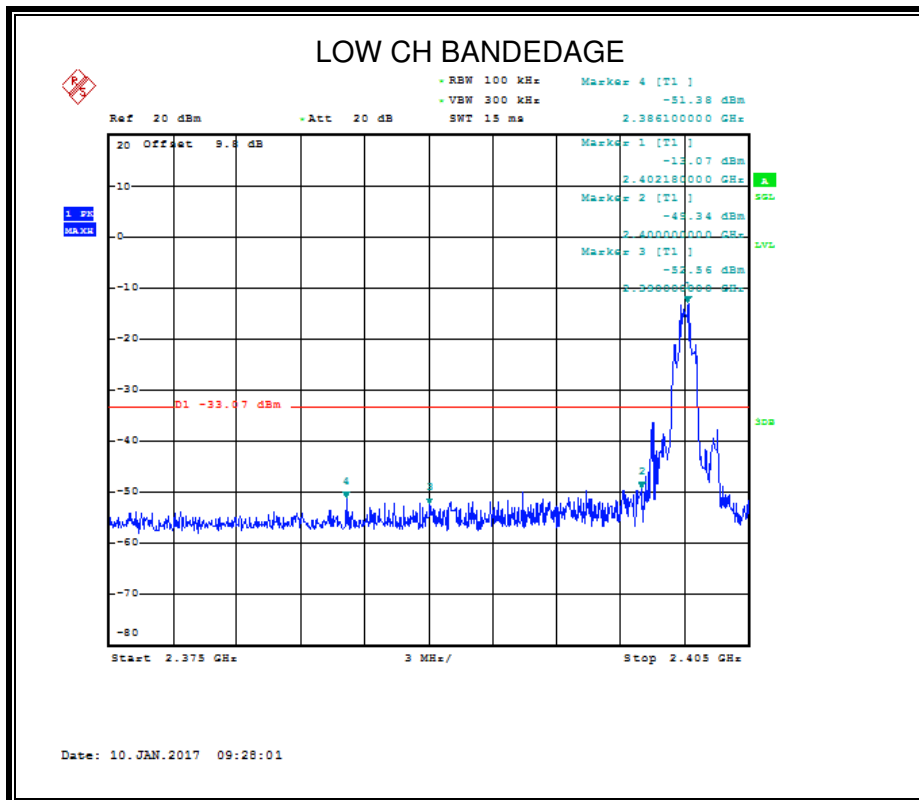

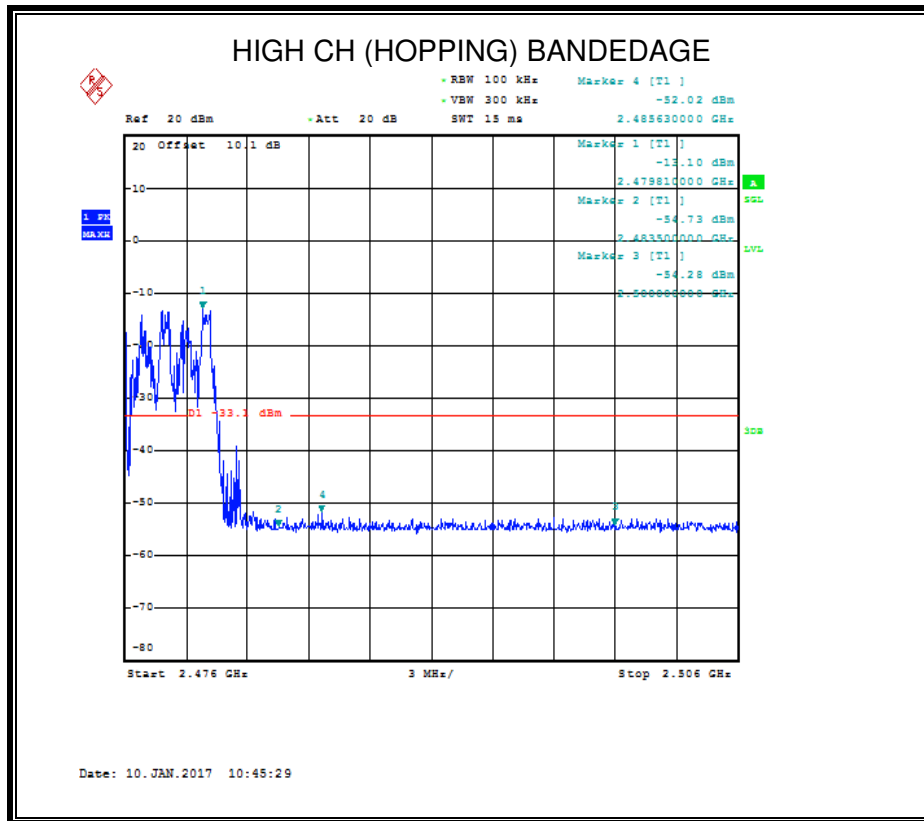
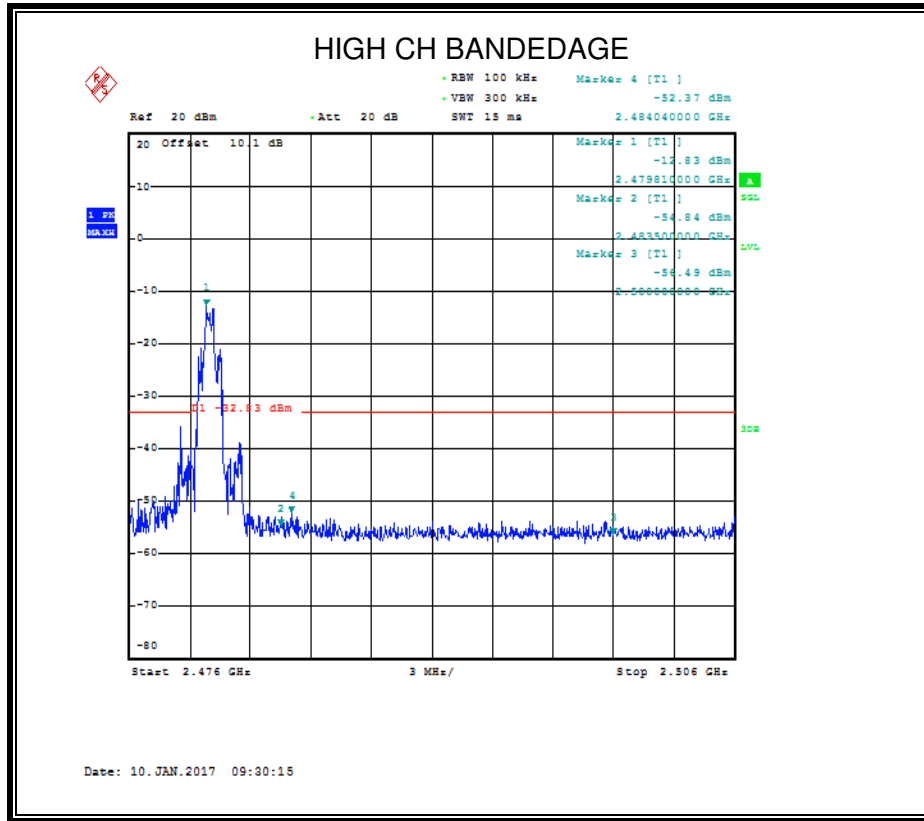

7. RADIATED TEST RESULTS

7.1. LIMITS AND PROCEDURE

LIMITS

Please refer to FCC §15.205 and §15.209

Radiation Disturbance Test Limit for FCC (Class B)(9KHz-1GHz)

Frequency (MHz)	Field Strength (microvolts/meter)	Measurement Distance (meters)
0.009~0.490	2400/F(KHz)	300
0.490~1.705	24000/F(KHz)	30
1.705~30.0	30	30
30~88	100	3
88~216	150	3
216~960	200	3
960~1000	500	3

Radiation Disturbance Test Limit for FCC (Above 1G)

Frequency (MHz)	dB(uV/m) (at 3 meters)	
	Peak	Average
Above 1000	74	54

Restricted bands of operation

MHz	MHz	MHz	GHz
0.090-0.110	16.42-16.423	399.9-410	4.5-5.15
¹ 0.495-0.505	16.69475-16.69525	608-614	5.35-5.46
2.1735-2.1905	16.80425-16.80475	960-1240	7.25-7.75
4.125-4.128	25.5-25.67	1300-1427	8.025-8.5
4.17725-4.17775	37.5-38.25	1435-1626.5	9.0-9.2
4.20725-4.20775	73-74.6	1645.5-1646.5	9.3-9.5
6.215-6.218	74.8-75.2	1660-1710	10.6-12.7
6.26775-6.26825	108-121.94	1718.8-1722.2	13.25-13.4
6.31175-6.31225	123-138	2200-2300	14.47-14.5
8.291-8.294	149.9-150.05	2310-2390	15.35-16.2
8.362-8.366	156.52475-156.52525	2483.5-2500	17.7-21.4
8.37625-8.38675	156.7-156.9	2690-2900	22.01-23.12
8.41425-8.41475	162.0125-167.17	3260-3267	23.6-24.0
12.29-12.293	167.72-173.2	3332-3339	31.2-31.8
12.51975-12.52025	240-285	3345.8-3358	36.43-36.5
12.57675-12.57725	322-335.4	3600-4400	(²)
13.36-13.41			

Note: ¹Until February 1, 1999, this restricted band shall be 0.490-0.510 MHz.

²Above 38.6

TEST SETUP AND PROCEDURE

Below 30MHz

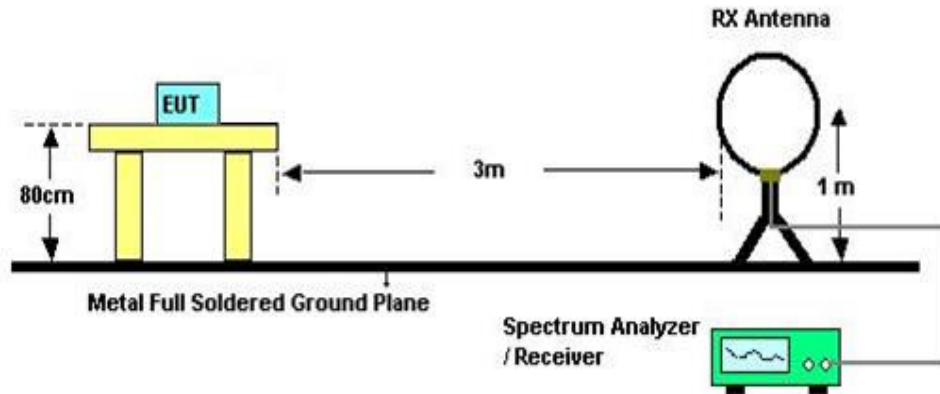

The setting of the spectrum analyser

RBW	200Hz (From 9kHz to 0.15MHz)/ 9KHz (From 0.15MHz to 30MHz)
VBW	200Hz (From 9kHz to 0.15MHz)/ 9KHz (From 0.15MHz to 30MHz)
Sweep	Auto
Trace	Max hold

1. The testing follows the guidelines in ANSI C63.10-2013
2. The EUT was arranged to its worst case and then turntable (from 0 degree to 360 degrees) to find the maximum reading. A pre-amp and a high pass filter are used for the test in order to get better signal level. Both horizontal and vertical polarizations of the antenna are set to make the measurement.
3. The EUT was placed on a turntable with 0.8m meter above ground.
4. The EUT was set 3 meters from the interference receiving antenna, which was mounted on the top of a variable height antenna tower.
5. Corrected Reading: Antenna Factor + Cable Loss + Read Level - Preamp Factor = Level
6. For measurement below 1GHz, the initial step in collecting conducted emission data is a spectrum analyzer peak detector mode pre-scanning the measurement frequency range. Significant peaks are then marked and then Quasi Peak detector mode re-measured. If the emission level of the EUT measured by the peak detector is 3 dB lower than the applicable limit, the peak emission level will be reported. Otherwise, the emission measurement will be repeated using the quasi-peak detector and reported.
7. For the actual test configuration, please refer to the related item in this test report (Photographs of the Test Configuration)

Below 1G

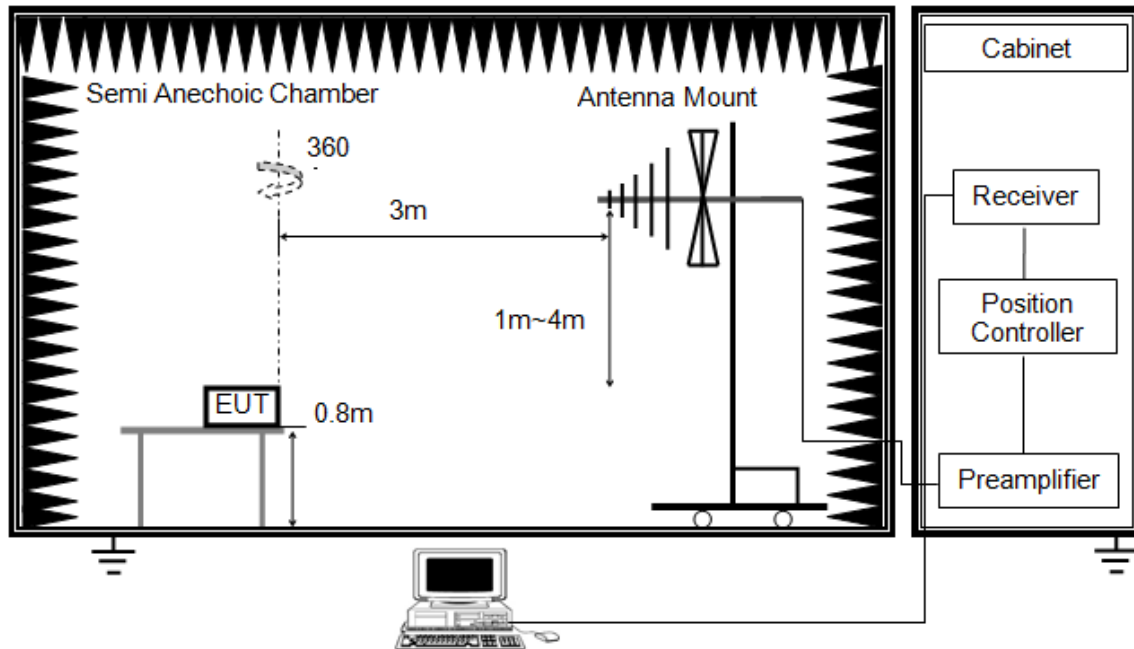

The setting of the spectrum analyser

RBW	120K
VBW	300K
Sweep	Auto
Trace	Max hold

1. The testing follows the guidelines in ANSI C63.10-2013.
2. The EUT was arranged to its worst case and then tune the antenna tower (from 1 m to 4 m) and turntable (from 0 degree to 360 degrees) to find the maximum reading. A pre-amp and a high pass filter are used for the test in order to get better signal level. Both horizontal and vertical polarizations of the antenna are set to make the measurement.
3. The EUT was placed on a turntable with 0.8m above ground.
4. The EUT was set 3 meters from the interference receiving antenna, which was mounted on the top of a variable height antenna tower.
5. Corrected Reading: $\text{Antenna Factor} + \text{Cable Loss} + \text{Read Level} - \text{Preamp Factor} = \text{Level}$
6. For measurement below 1GHz, the initial step in collecting conducted emission data is a spectrum analyzer peak detector mode pre-scanning the measurement frequency range. Significant peaks are then marked and then Quasi Peak detector mode re-measured. If the emission level of the EUT measured by the peak detector is 3 dB lower than the applicable limit, the peak emission level will be reported. Otherwise, the emission measurement will be repeated using the quasi-peak detector and reported.
7. For the actual test configuration, please refer to the related Item in this test report The setting of the spectrum analyser

Above 1G

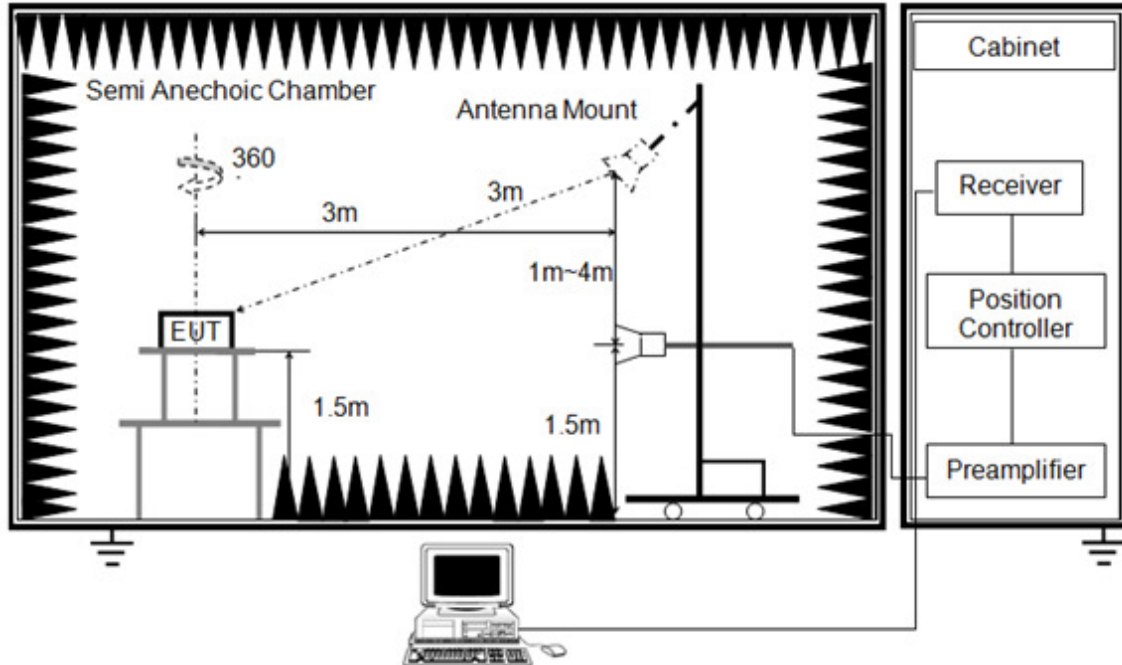

RBW	1M
VBW	3M
Sweep	Auto
Detector	Peak
Trace	Max hold

1. The testing follows the guidelines in ANSI C63.10-2013.
2. The EUT was arranged to its worst case and then tune the antenna tower (from 1 m to 4 m) and turntable (from 0 degree to 360 degrees) to find the maximum reading. A pre-amp and a high pass filter are used for the test in order to get better signal level. Both horizontal and vertical polarizations of the antenna are set to make the measurement.
3. The EUT was placed on a turntable with 1.5m above ground.
4. The EUT was set 3 meters from the interference receiving antenna, which was mounted on the top of a variable height antenna tower.
5. For measurement above 1GHz, the emission measurement will be measured by the peak detector. This peak level, once corrected, must comply with the limit specified in Section 15.209.
6. For average power measurement, set the VBW to 10 Hz, while maintaining all of the other instrument settings, if the duty cycle of the EUT is less than 98%, the Duty Cycle Correction Factor shall be added to the measured emission levels. For the Duty Cycle and Correction Factor please refer to clause 7.1.ON TIME AND DUTY CYCLE.
8. For the actual test configuration, please refer to the related item in this test report (Photographs of the Test Configuration)

7.2. RESTRICTED BANDEDGE

7.2.1. GFSK MODE

RESTRICTED BANDEDGE (LOW CHANNEL, HORIZONTAL)

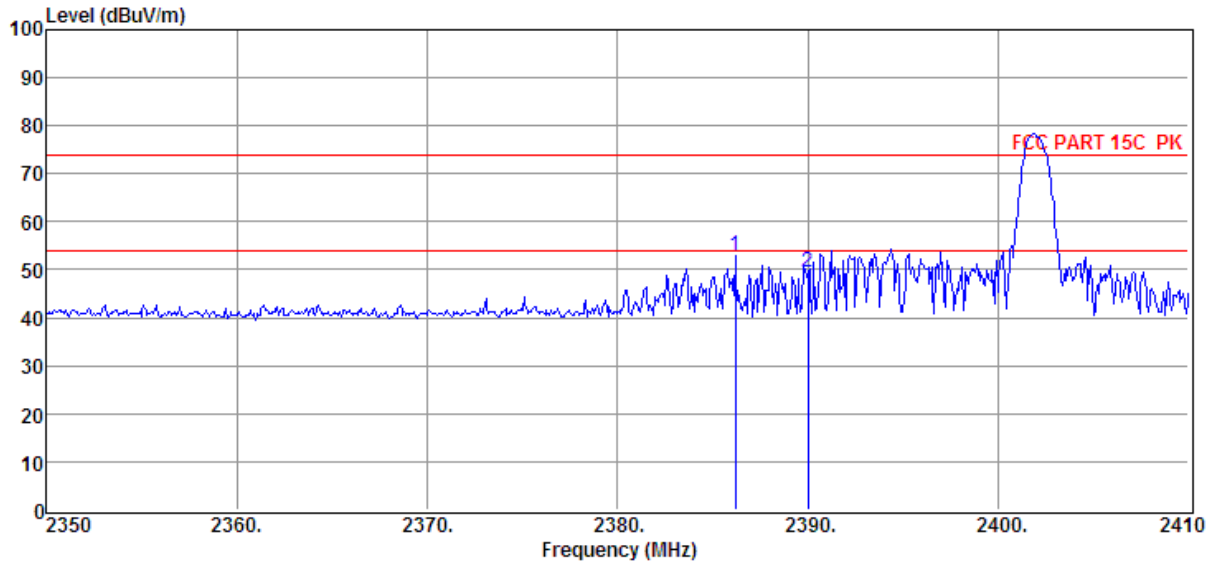

Item (Mark)	Freq. (MHz)	Read Level (dBμV)	Antenna Factor (dB/m)	PRM Factor dB	Cable Loss dB	Result Level (dBμV/m)	Limit Line (dBμV/m)	Over Limit (dB)	Detector
1	2386.18	46.60	29.76	29.41	6.01	52.96	74.00	-21.04	Peak
2	2390.00	43.23	29.78	29.41	6.01	49.61	74.00	-24.39	Peak

- Note: 1. Result Level = Read Level + Antenna Factor + Cable loss - PRM Factor.
 2. If Peak Result complies with AV limit, AV Result is deemed to comply with AV limit.
 3. Test setup: RBW: 1 MHz, VBW: 3 MHz, Sweep time: auto.

RESTRICTED BANDEDGE (LOW CHANNEL, VERTICAL)

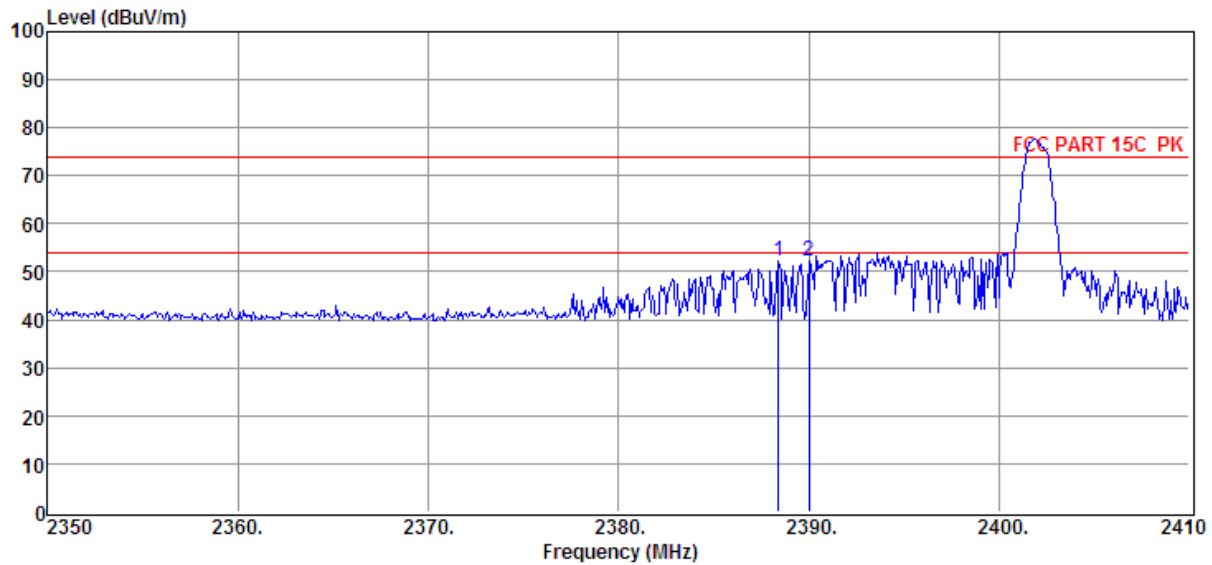

Item (Mark)	Freq. (MHz)	Read Level (dBμV)	Antenna Factor (dB/m)	PRM Factor (dB)	Cable Loss (dB)	Result Level (dBμV/m)	Limit Line (dBμV/m)	Over Limit (dB)	Detector
1	2388.40	45.73	29.77	29.41	6.01	52.10	74.00	-21.90	Peak
2	2390.00	46.02	29.78	29.41	6.01	52.40	74.00	-21.60	Peak

Note: 1. Result Level = Read Level + Antenna Factor + Cable loss - PRM Factor.
 2. If Peak Result complies with AV limit, AV Result is deemed to comply with AV limit.
 3. Test setup: RBW: 1 MHz, VBW: 3 MHz, Sweep time: auto.

RESTRICTED BANDEDGE (HIGH CHANNEL, HORIZONTAL)

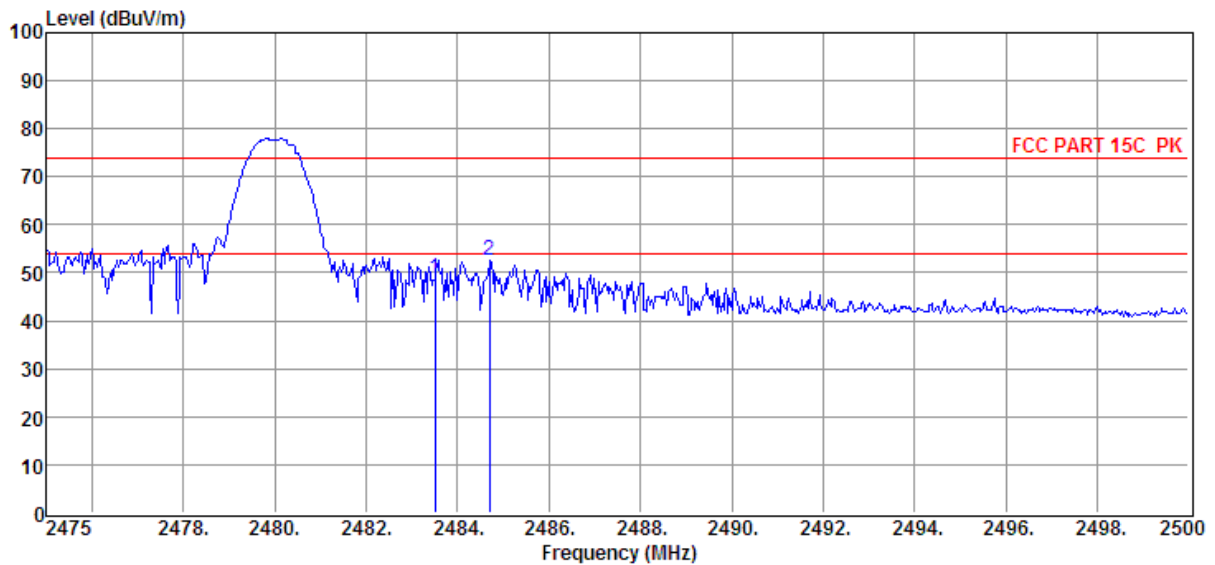

Item (Mark)	Freq. (MHz)	Read Level (dBμV)	Antenna Factor (dB/m)	PRM Factor (dB)	Cable Loss (dB)	Result Level (dBμV/m)	Limit Line (dBμV/m)	Over Limit (dB)	Detector
1	2483.50	42.19	30.14	29.71	6.15	48.77	74.00	-25.23	Peak
2	2484.70	45.91	30.14	29.71	6.15	52.49	74.00	-21.51	Peak

Note: 1. Result Level = Read Level + Antenna Factor + Cable loss - PRM Factor.
 2. If Peak Result complies with AV limit, AV Result is deemed to comply with AV limit.
 3. Test setup: RBW: 1 MHz, VBW: 3 MHz, Sweep time: auto.

RESTRICTED BANDEDGE (HIGH CHANNEL, VERTICAL)

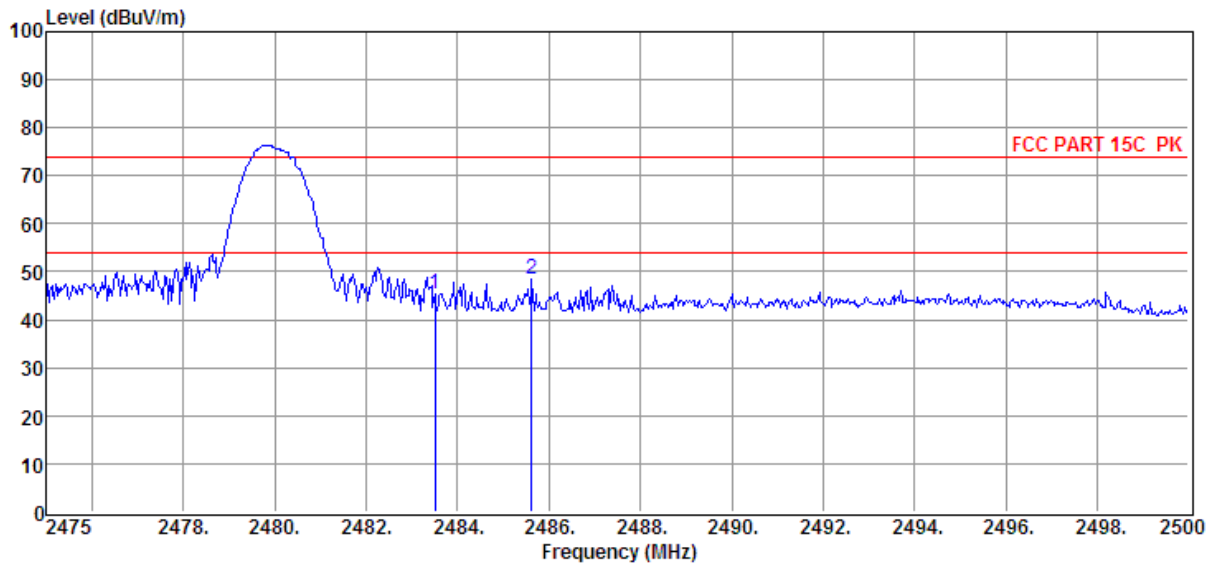

Item (Mark)	Freq. (MHz)	Read Level (dBμV)	Antenna Factor (dB/m)	PRM Factor (dB)	Cable Loss (dB)	Result Level (dBUV/m)	Limit Line (dBμV/m)	Over Limit (dB)	Detector
1	2483.50	38.78	30.14	29.71	6.15	45.36	74.00	-28.64	Peak
2	2485.63	41.71	30.15	29.71	6.15	48.30	74.00	-25.70	Peak

Note: 1. Result Level = Read Level + Antenna Factor + Cable loss - PRM Factor.
 2. If Peak Result complies with AV limit, AV Result is deemed to comply with AV limit.
 3. Test setup: RBW: 1 MHz, VBW: 3 MHz, Sweep time: auto.

Note: EUT in each of three orthogonal axis emissions had been tested, but only the worst case (X axis) data recorded in the report.

7.2.2. 8-DPSK MODE

RESTRICTED BANDEDGE (LOW CHANNEL, HORIZONTAL)

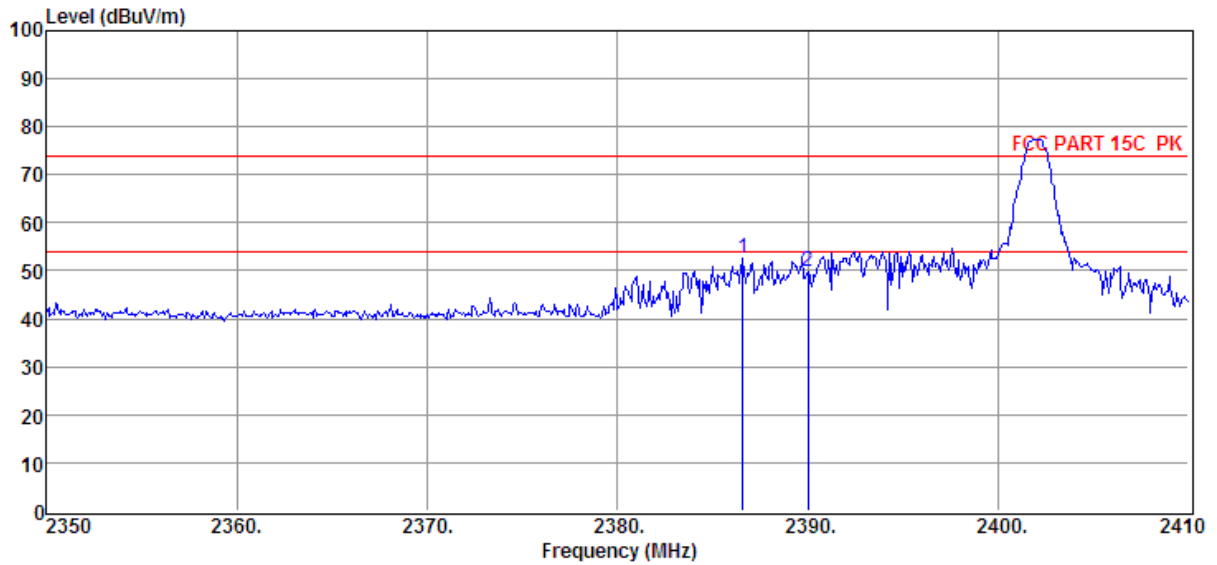

Item (Mark)	Freq. (MHz)	Read Level (dB μ V)	Antenna Factor (dB/m)	PRM Factor dB	Cable Loss dB	Result Level (dB μ V/m)	Limit Line (dB μ V/m)	Over Limit (dB)	Detector
1	2386.60	46.10	29.76	29.41	6.01	52.46	74.00	-21.54	Peak
2	2390.00	43.58	29.78	29.41	6.01	49.96	74.00	-24.04	Peak

- Note: 1. Result Level = Read Level + Antenna Factor + Cable loss - PRM Factor.
 2. If Peak Result complies with AV limit, AV Result is deemed to comply with AV limit.
 3. Test setup: RBW: 1 MHz, VBW: 3 MHz, Sweep time: auto.

RESTRICTED BANDEDGE (LOW CHANNEL, VERTICAL)

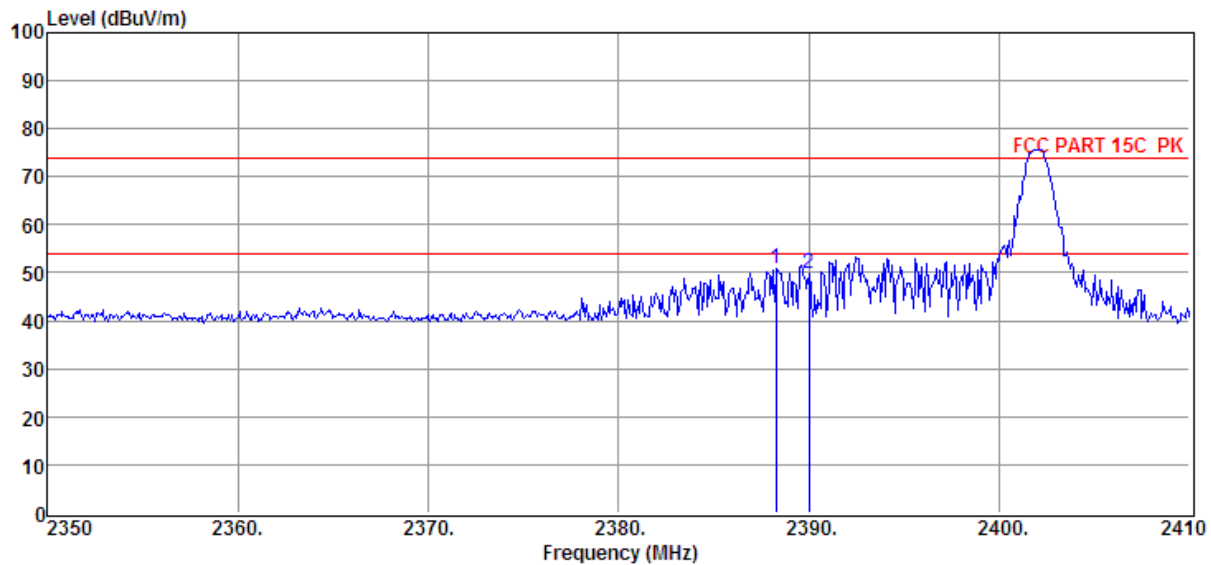

Item (Mark)	Freq. (MHz)	Read Level (dBμV)	Antenna Factor (dB/m)	PRM Factor dB	Cable Loss dB	Result Level (dBμV/m)	Limit Line (dBμV/m)	Over Limit (dB)	Detector
1	2388.28	44.49	29.77	29.41	6.01	50.86	74.00	-23.14	Peak
2	2390.00	43.37	29.78	29.41	6.01	49.75	74.00	-24.25	Peak

- Note: 1. Result Level = Read Level + Antenna Factor + Cable loss - PRM Factor.
 2. If Peak Result complies with AV limit, AV Result is deemed to comply with AV limit.
 3. Test setup: RBW: 1 MHz, VBW: 3 MHz, Sweep time: auto.

RESTRICTED BANDEDGE (HIGH CHANNEL, HORIZONTAL)

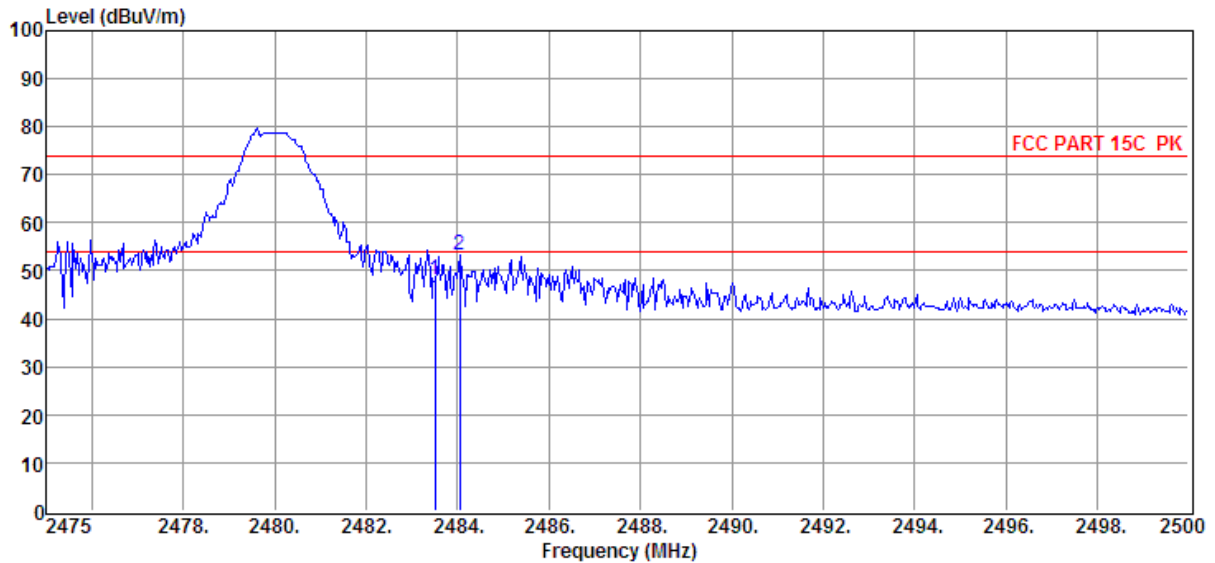

Item (Mark)	Freq. (MHz)	Read Level (dBμV)	Antenna Factor (dB/m)	PRM Factor (dB)	Cable Loss (dB)	Result Level (dBμV/m)	Limit Line (dBμV/m)	Over Limit (dB)	Detector
1	2483.50	41.52	30.14	29.71	6.15	48.10	74.00	-25.90	Peak
2	2484.05	46.72	30.14	29.71	6.15	53.30	74.00	-20.70	Peak

Note: 1. Result Level = Read Level + Antenna Factor + Cable loss - PRM Factor.
 2. If Peak Result complies with AV limit, AV Result is deemed to comply with AV limit.
 3. Test setup: RBW: 1 MHz, VBW: 3 MHz, Sweep time: auto.

RESTRICTED BANDEDGE (HIGH CHANNEL, VERTICAL)

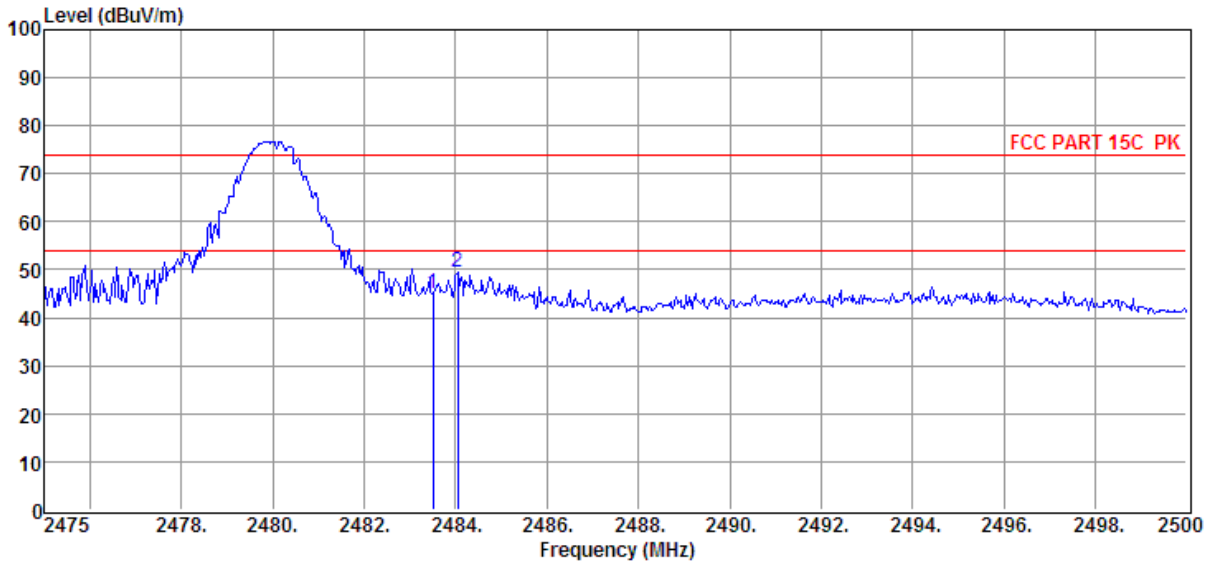

Item (Mark)	Freq. (MHz)	Read Level (dBμV)	Antenna Factor (dB/m)	PRM Factor dB	Cable Loss dB	Result Level (dBμV/m)	Limit Line (dBμV/m)	Over Limit (dB)	Detector
1	2483.50	38.40	30.14	29.71	6.15	44.98	74.00	-29.02	Peak
2	2484.05	42.91	30.14	29.71	6.15	49.49	74.00	-24.51	Peak

- Note: 1. Result Level = Read Level + Antenna Factor + Cable loss - PRM Factor.
 2. If Peak Result complies with AV limit, AV Result is deemed to comply with AV limit.
 3. Test setup: RBW: 1 MHz, VBW: 3 MHz, Sweep time: auto.

Note: EUT in each of three orthogonal axis emissions had been tested, but only the worst case (X axis) data recorded in the report.

7.3. SPURIOUS EMISSIONS (1~25GHz)

7.3.1. GFSK MODE

HARMONICS AND SPURIOUS EMISSIONS

EUT:	“EverPlay” Wireless Portable Speaker	Polarization :	Horizontal
Test Mode:	GFSK(DH5) Mode Low Chanel		

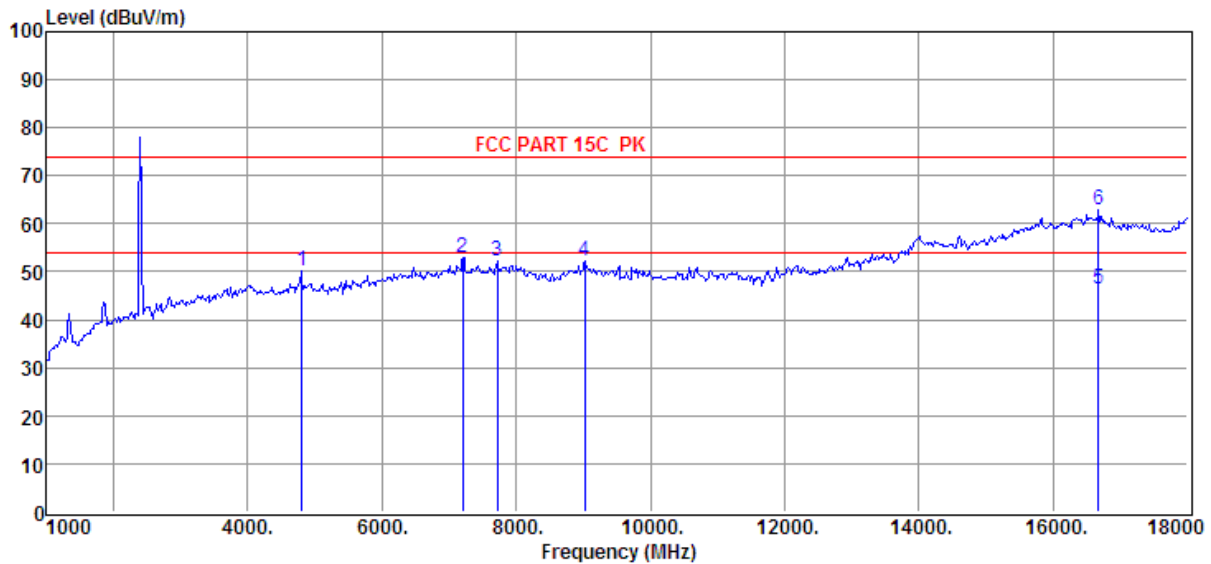

Item (Mark)	Freq. (MHz)	PK Read Level (dBuV)	VA1T Read Level (dBuV)	Antenna Factor (dB/m)	PRM Factor (dB)	Cable Loss (dB)	PK Result Level (dBuV/m)	DCCF (dB)	AV Result Level (dBuV/m)	Limit Line (dBuV/m)	Over Limit (dB)
1	4804.00	37.36		33.74	29.32	8.48	50.26			74.00	-23.74
2	7206.00	36.60		36.37	30.49	10.60	53.08			74.00	-20.92
3	7715.00	35.66		36.64	30.99	10.98	52.29			74.00	-21.71
4	9024.00	35.37		37.45	32.33	11.85	52.34			74.00	-21.66
6	16674.00	37.00		44.42	36.34	17.81	62.89			74.00	-11.11
5	16674.00		20.59	44.42	36.34	17.81		1.08	47.56	54.00	-6.44

- Note: 1. Test setup: RBW: 1 MHz, VBW: 3 MHz, Sweep time: auto.
 2. PK: Peak Detector; VA1T: Linear Voltage Average VBW=10Hz
 3. PK Result Level = PK Read Level + Antenna Factor + Cable loss - PRM Factor.
 4. DCCF: Duty Cycle Correction Factor=1.14(Please refer to clause 7.1.ON TIME AND DUTY CYCLE).
 5. AV Result Level: Average value = VA1T Reading + Antenna Factor + Cable loss - PRM Factor + DCCF
 6. If Peak Result complies with AV limit, AV Result is deemed to comply with AV limit.
 7. The higher frequency, which started from 18GHz to 25GHz, was pre-scanned and the result which was 20dB lower than the limit line and was not reported.

EUT:	“EverPlay” Wireless Portable Speaker	Polarization :	Vertical
Test Mode:	GFSK(DH5) Mode Low Channel		

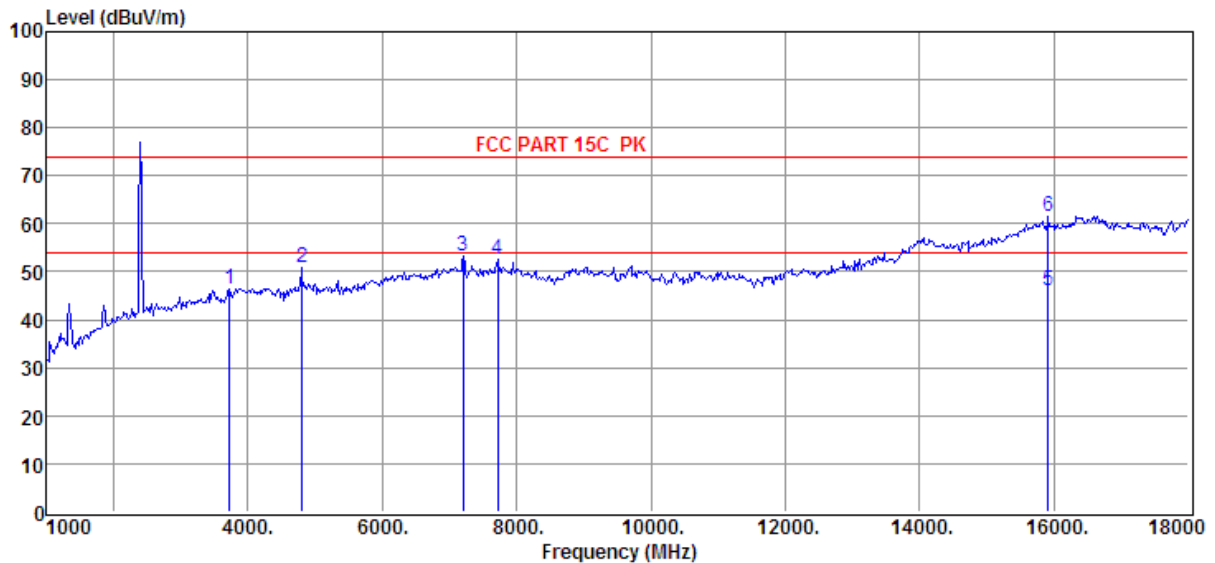

Item (Mark)	Freq. (MHz)	PK Read Level (dBμV)	VA1T Read Level (dBμV)	Antenna Factor (dB/m)	PRM Factor dB	Cable Loss dB	PK Result Level (dBμV/m)	DCCF dB	AV Result Level (dBμV/m)	Limit Line (dBμV/m)	Over Limit (dB)
1	4808.00	35.10		33.74	29.32	8.48	48.00			74.00	-26.00
2	6236.00	34.07		35.39	29.40	9.80	49.86			74.00	-24.14
3	7205.00	36.48		36.37	30.49	10.60	52.96			74.00	-21.04
4	7970.00	34.83		36.69	31.12	11.12	51.52			74.00	-22.48
6	16504.00	35.12		44.69	36.06	17.51	61.26			74.00	-12.74
5	16504.00		20.75	44.69	36.06	17.51		1.08	47.97	54.00	-6.03

- Note: 1. Test setup: RBW: 1 MHz, VBW: 3 MHz, Sweep time: auto.
 2. PK: Peak Detector; VA1T: Linear Voltage Average VBW=10Hz
 3. PK Result Level = PK Read Level + Antenna Factor + Cable loss - PRM Factor.
 4. DCCF: Duty Cycle Correction Factor=1.14(Please refer to clause 7.1.ON TIME AND DUTY CYCLE).
 5. AV Result Level: Average value = VA1T Reading + Antenna Factor + Cable loss - PRM Factor + DCCF
 6. If Peak Result complies with AV limit, AV Result is deemed to comply with AV limit.
 7. The higher frequency, which started from 18GHz to 25GHz, was pre-scanned and the result which was 20dB lower than the limit line and was not reported.

EUT:	“EverPlay” Wireless Portable Speaker	Polarization :	Horizontal
Test Mode:	GFSK(DH5) Mode Middle Chanel		

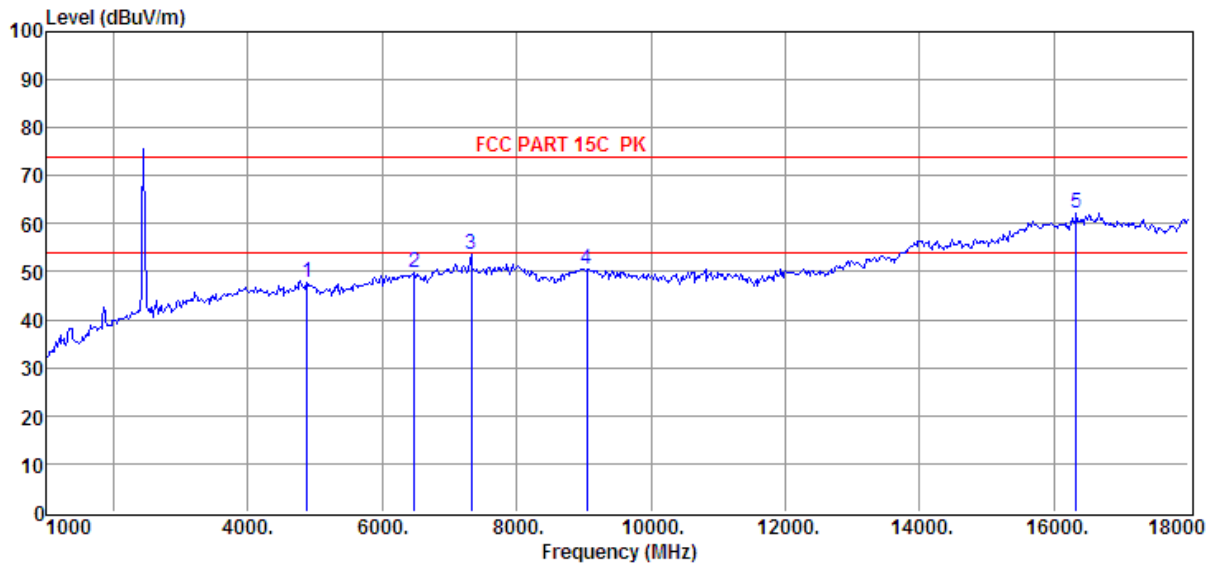

Item (Mark)	Freq. (MHz)	PK Read Level (dBμV)	VA1T Read Level (dBμV)	Antenna Factor (dB/m)	PRM Factor (dB)	Cable Loss (dB)	PK Result Level (dBμV/m)	DCCF (dB)	AV Result Level (dBμV/m)	Limit Line (dBμV/m)	Over Limit (dB)
1	4876.00	34.88		33.72	29.33	8.56	47.83			74.00	-26.17
2	6474.00	33.94		35.76	29.78	9.93	49.85			74.00	-24.15
3	7324.00	37.04		36.46	30.59	10.71	53.62			74.00	-20.38
4	9041.00	33.66		37.41	32.34	11.85	50.58			74.00	-23.42
6	16334.00	36.30		44.44	35.80	17.35	62.29			74.00	-11.71
5	16334.00		20.76	44.43	35.85	17.36		1.08	47.78	54.00	-6.22

- Note: 1. Test setup: RBW: 1 MHz, VBW: 3 MHz, Sweep time: auto.
 2. PK: Peak Detector; VA1T: Linear Voltage Average VBW=10Hz
 3. PK Result Level = PK Read Level + Antenna Factor + Cable loss - PRM Factor.
 4. DCCF: Duty Cycle Correction Factor=1.14(Please refer to clause 7.1.ON TIME AND DUTY CYCLE).
 5. AV Result Level: Average value = VA1T Reading + Antenna Factor + Cable loss - PRM Factor + DCCF
 6. If Peak Result complies with AV limit, AV Result is deemed to comply with AV limit.
 7. The higher frequency, which started from 18GHz to 25GHz, was pre-scanned and the result which was 20dB lower than the limit line and was not reported.

EUT:	“EverPlay” Wireless Portable Speaker	Polarization :	Vertical
Test Mode:	GFSK(DH5) Mode Middle Chanel		

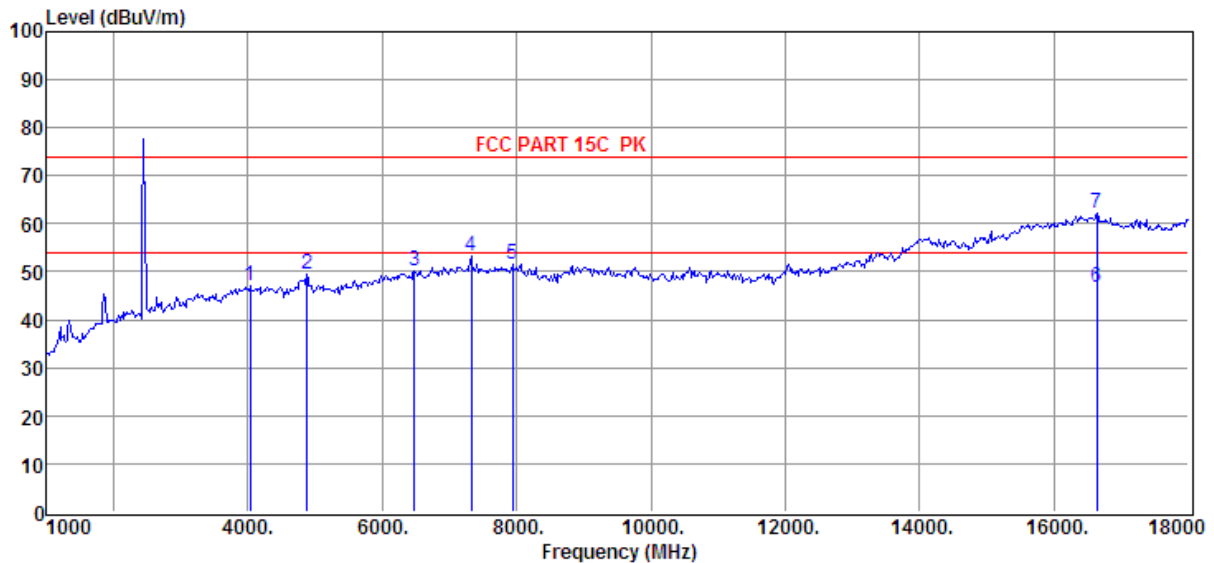

Item (Mark)	Freq. (MHz)	PK Read Level (dBμV)	VA1T Read Level (dBμV)	Antenna Factor (dB/m)	PRM Factor dB	Cable Loss dB	PK Result Level (dBμV/m)	DCCF dB	AV Result Level (dBμV/m)	Limit Line (dBμV/m)	Over Limit (dB)
1	4026.00	35.05		33.42	29.04	7.63	47.06			74.00	-26.94
2	4882.00	36.68		33.72	29.33	8.56	49.63			74.00	-24.37
3	6474.00	34.42		35.76	29.78	9.93	50.33			74.00	-23.67
4	7323.00	36.54		36.46	30.59	10.71	53.12			74.00	-20.88
5	7936.00	34.89		36.69	31.11	11.10	51.57			74.00	-22.43
7	16640.00	36.16		44.47	36.28	17.74	62.09			74.00	-11.91
6	16640.00		20.66	44.47	36.28	17.74		1.08	47.69	54.00	-6.31

- Note: 1. Test setup: RBW: 1 MHz, VBW: 3 MHz, Sweep time: auto.
 2. PK: Peak Detector; VA1T: Linear Voltage Average VBW=10Hz
 3. PK Result Level = PK Read Level + Antenna Factor + Cable loss - PRM Factor.
 4. DCCF: Duty Cycle Correction Factor=1.14(Please refer to clause 7.1.ON TIME AND DUTY CYCLE).
 5. AV Result Level: Average value = VA1T Reading + Antenna Factor + Cable loss - PRM Factor + DCCF
 6. If Peak Result complies with AV limit, AV Result is deemed to comply with AV limit.
 7. The higher frequency, which started from 18GHz to 25GHz, was pre-scanned and the result which was 20dB lower than the limit line and was not reported.

EUT:	“EverPlay” Wireless Portable Speaker	Polarization :	Horizontal
Test Mode:	GFSK(DH5) Mode High Chanel		

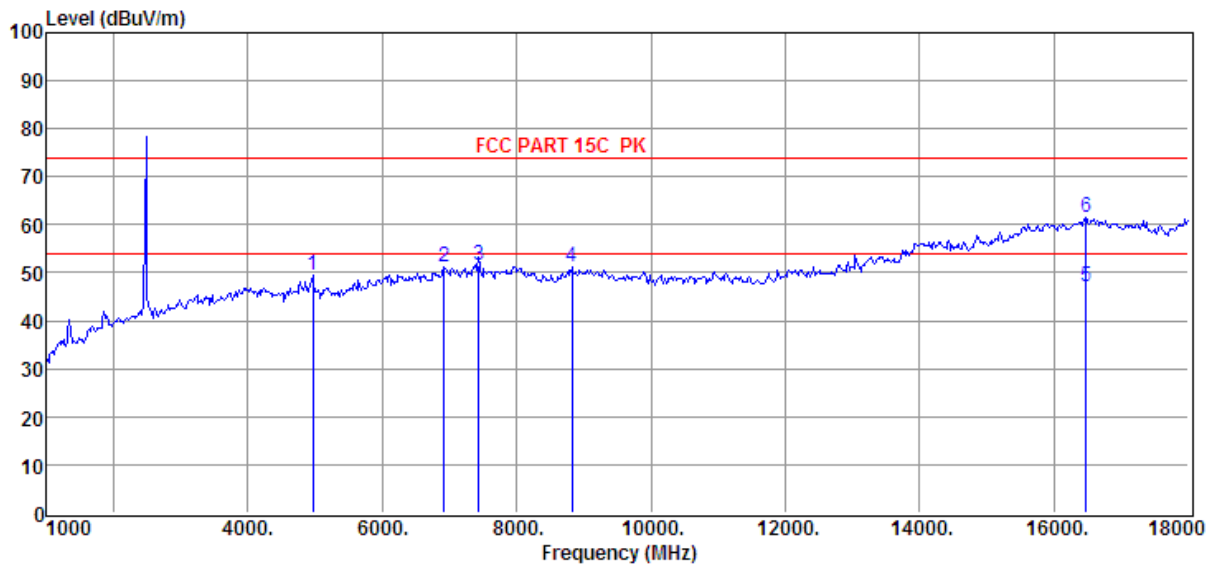

Item (Mark)	Freq. (MHz)	PK Read Level (dBUV)	VA1T Read Level (dBUV)	Antenna Factor (dB/m)	PRM Factor (dB)	Cable Loss (dB)	PK Result Level (dBUV/m)	DCCF (dB)	AV Result Level (dBUV/m)	Limit Line (dBUV/m)	Over Limit (dB)
1	4960.00	36.35		33.71	29.34	8.63	49.35			74.00	-24.65
2	6916.00	35.12		36.13	30.33	10.35	51.27			74.00	-22.73
3	7440.00	35.01		36.55	30.70	10.80	51.66			74.00	-22.34
4	8820.00	34.97		36.72	32.18	11.75	51.26			74.00	-22.74
6	16470.00	35.30		44.65	35.99	17.48	61.44			74.00	-12.56
5	16470.00		21.00	44.65	35.99	17.48		1.08	48.22	54.00	-5.78

- Note: 1. Test setup: RBW: 1 MHz, VBW: 3 MHz, Sweep time: auto.
 2. PK: Peak Detector; VA1T: Linear Voltage Average VBW=10Hz
 3. PK Result Level = PK Read Level + Antenna Factor + Cable loss - PRM Factor.
 4. DCCF: Duty Cycle Correction Factor=1.14(Please refer to clause 7.1.ON TIME AND DUTY CYCLE).
 5. AV Result Level: Average value = VA1T Reading + Antenna Factor + Cable loss - PRM Factor + DCCF
 6. If Peak Result complies with AV limit, AV Result is deemed to comply with AV limit.
 7. The higher frequency, which started from 18GHz to 25GHz, was pre-scanned and the result which was 20dB lower than the limit line and was not reported.

EUT:	“EverPlay” Wireless Portable Speaker	Polarization :	Vertical
Test Mode:	GFSK(DH5) Mode High Chanel		

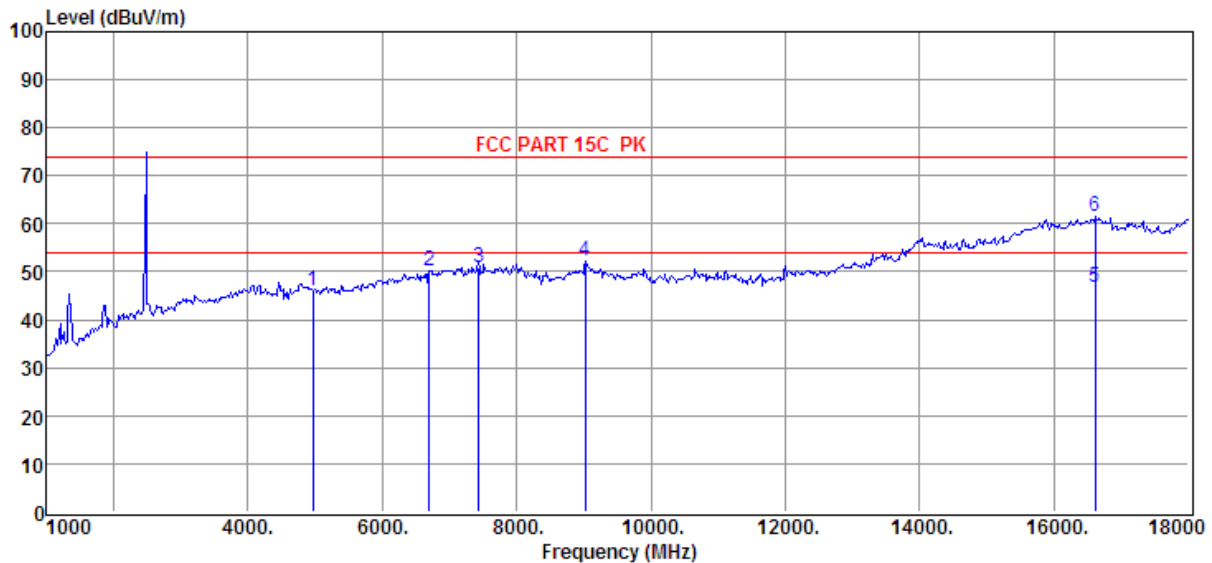

Item (Mark)	Freq. (MHz)	PK Read Level (dBμV)	VA1T Read Level (dBμV)	Antenna Factor (dB/m)	PRM Factor dB	Cable Loss dB	PK Result Level (dBμV/m)	DCCF dB	AV Result Level (dBμV/m)	Limit Line (dBμV/m)	Over Limit (dB)
1	4960.00	33.12		33.71	29.34	8.63	46.12			74.00	-27.88
2	6695.00	34.21		35.96	30.14	10.14	50.17			74.00	-23.83
3	7440.00	34.28		36.55	30.70	10.80	50.93			74.00	-23.07
4	9024.00	35.19		37.45	32.33	11.85	52.16			74.00	-21.84
6	16606.00	35.41		44.53	36.21	17.67	61.40			74.00	-12.60
5	16606.00		20.74	44.53	36.21	17.67		1.08	47.81	54.00	-6.19

- Note: 1. Test setup: RBW: 1 MHz, VBW: 3 MHz, Sweep time: auto.
 2. PK: Peak Detector; VA1T: Linear Voltage Average VBW=10Hz
 3. PK Result Level = PK Read Level + Antenna Factor + Cable loss - PRM Factor.
 4. DCCF: Duty Cycle Correction Factor=1.14(Please refer to clause 7.1.ON TIME AND DUTY CYCLE).
 5. AV Result Level: Average value = VA1T Reading + Antenna Factor + Cable loss - PRM Factor + DCCF
 6. If Peak Result complies with AV limit, AV Result is deemed to comply with AV limit.
 7. The higher frequency, which started from 18GHz to 25GHz, was pre-scanned and the result which was 20dB lower than the limit line and was not reported.

Note 1: All the modulation and channels had been tested, but only the worst data recorded in the report.

Note 2: EUT in each of three orthogonal axis emissions had been tested, but only the worst case (X axis) data recorded in the report.

7.4. SPURIOUS EMISSIONS 30M ~ 1 GHz

7.4.1. GFSK MODE

SPURIOUS EMISSIONS 30 TO 1000 MHz (WORST-CASE CONFIGURATION)

EUT:	"EverPlay" Wireless Portable Speaker	Polarization :	Horizontal
Test Mode:	GFSK Mode Middle Channel		

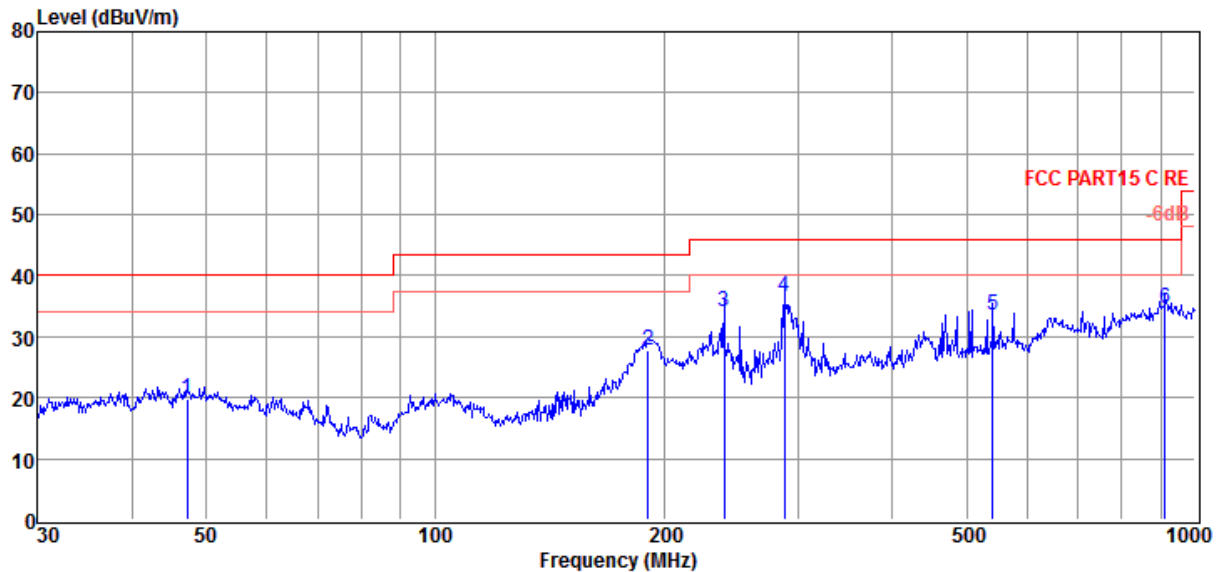

Item	Freq.	Read Level	Antenna Factor	Cable Loss	Result Level	Limit Line	Over Limit	Detector
(Mark)	(MHz)	(dBμV)	(dB/m)	dB	(dBμV/m)	(dBμV/m)	(dB)	
1	47.160	3.07	13.25	3.59	19.91	40.00	-20.09	QP
2	190.405	13.35	10.04	4.37	27.76	43.50	-15.74	QP
3	239.987	17.63	11.93	4.60	34.16	46.00	-11.84	QP
4	287.990	18.89	12.97	4.80	36.66	46.00	-9.34	QP
5	541.373	10.18	17.69	5.63	33.50	46.00	-12.50	QP
6	912.862	5.64	22.41	6.70	34.75	46.00	-11.25	QP

Note: 1. Result Level = Read Level + Antenna Factor + Cable loss.
 2. If Peak Result complies with QP limit, QP Result is deemed to comply with QP limit.
 3. Test setup: RBW: 120 kHz, VBW: 300 kHz, Sweep time: auto.

EUT:	“EverPlay” Wireless Portable Speaker	Polarization :	Vertical
Test Mode:	GFSK Mode Middle Channel		

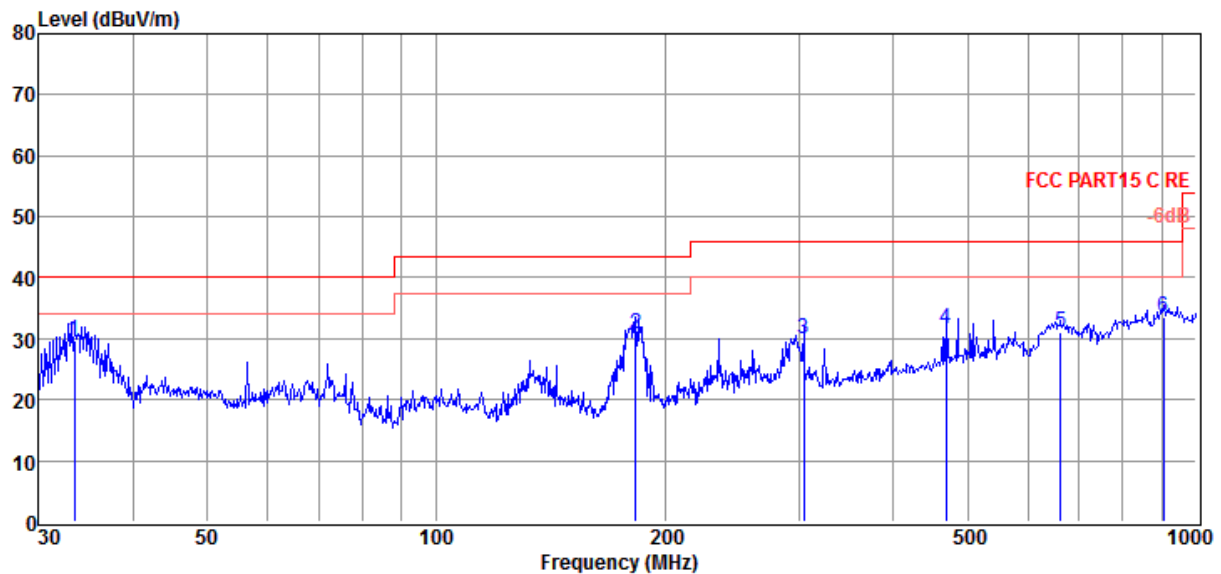

Item	Freq.	Read Level	Antenna Factor	Cable Loss	Result Level	Limit Line	Over Limit	Detector
(Mark)	(MHz)	(dBμV)	(dB/m)	dB	(dBμV/m)	(dBμV/m)	(dB)	
1	33.445	16.03	10.33	3.42	29.78	40.00	-10.22	QP
2	183.201	17.43	8.89	4.35	30.67	43.50	-12.83	QP
3	304.610	12.91	12.20	4.87	29.98	46.00	-16.02	QP
4	468.876	9.75	16.39	5.40	31.54	46.00	-14.46	QP
5	663.473	3.94	21.16	6.02	31.12	46.00	-14.88	QP
6	906.482	4.12	22.73	6.68	33.53	46.00	-12.47	QP

- Note: 1. Result Level = Read Level + Antenna Factor + Cable loss.
 2. If Peak Result complies with QP limit, QP Result is deemed to comply with QP limit.
 3. Test setup: RBW: 120 kHz, VBW: 300 kHz, Sweep time: auto.

Note 1: All the modulation and channels had been tested, but only the worst data recorded in the report.

Note 2: EUT in each of three orthogonal axis emissions had been tested, but only the worst case (X axis) data recorded in the report.

7.5. SPURIOUS EMISSIONS BELOW 30M

Note 1: The low frequency, which started from 9 kHz to 30MHz, was pre-scanned and the result which was 20dB lower than the limit line per 15.31(o) was not reported.

Note 2: EUT in each of three orthogonal axis emissions had been tested, but only the worst case (X axis) data recorded in the report.

8. AC POWER LINE CONDUCTED EMISSIONS

LIMITS

Please refer to FCC §15.207 (a)

FREQUENCY (MHz)	Class A (dBuV)		Class B (dBuV)	
	Quasi-peak	Average	Quasi-peak	Average
0.15 -0.5	79.00	66.00	66 - 56 *	56 - 46 *
0.50 -5.0	73.00	60.00	56.00	46.00
5.0 -30.0	73.00	60.00	60.00	50.00

TEST SETUP AND PROCEDURE

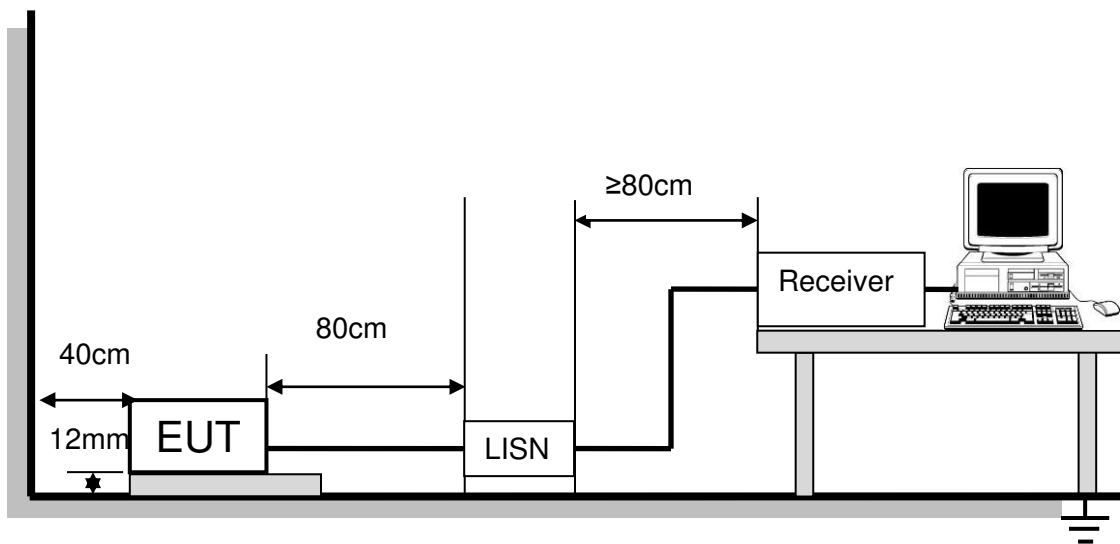

The EUT is put on a table of non-conducting material that is 80cm high. The vertical conducting wall of shielding is located 40cm to the rear of the EUT. The power line of the EUT is connected to the AC mains through a Artificial Mains Network (A.M.N.). A EMI Measurement Receiver (R&S Test Receiver ESR3) is used to test the emissions from both sides of AC line. According to the requirements in Section 7 and 13 of ANSI C63.4-2014. Conducted emissions from the EUT measured in the frequency range between 0.15 MHz and 30MHz using CISPR Quasi-Peak and average detector mode. The bandwidth of EMI test receiver is set at 9kHz.

The arrangement of the equipment is installed to meet the standards and operating in a manner, which tends to maximize its emission characteristics in a normal application.

TEST RESULTS (WORST-CASE CONFIGURATION)

EUT:	“EverPlay” Wireless Portable Speaker	Phase :	L1
Test Mode:	GFSK Mode Middle Channel		

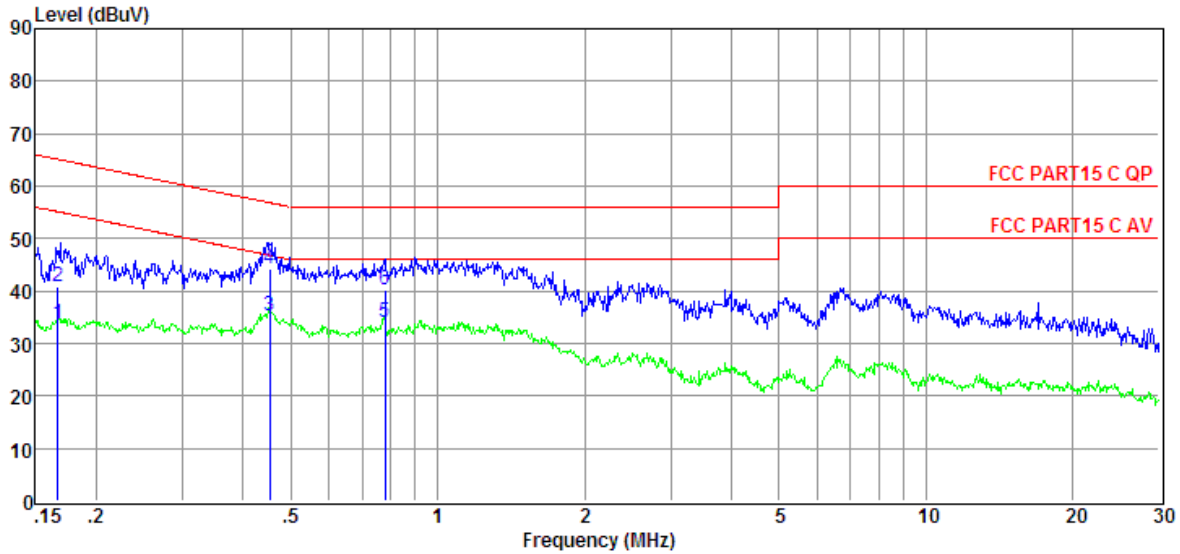

Item	Freq	Read Level	LISN Factor	Cable Loss	Pulse Limiter Factor	Result Level	Limit Line	Over Limit	Detector
(Mark)	(MHz)	(dBμV)	(dB)	(dB)	(dB)	(dBμV)	(dBμV)	(dB)	
1	0.167	14.31	9.61	0.02	9.86	33.80	55.12	-21.32	Average
2	0.167	21.26	9.61	0.02	9.86	40.75	65.12	-24.37	QP
3	0.454	15.92	9.61	0.02	9.86	35.41	46.80	-11.39	Average
4	0.454	24.84	9.61	0.02	9.86	44.33	56.80	-12.47	QP
5	0.779	14.45	9.61	0.03	9.86	33.95	46.00	-12.05	Average
6	0.779	20.74	9.61	0.03	9.86	40.24	56.00	-15.76	QP

- Note: 1. Result Level = Read Level + LISN Factor + Pulse Limiter Factor + Cable loss.
 2. If QP Result complies with AV limit, AV Result is deemed to comply with AV limit.
 3. Test setup: RBW: 200 Hz (9 kHz—150 kHz), 9 kHz (150 kHz—30 MHz).
 4. Step size: 80Hz (0.009MHz-0.15MHz), 4 kHz (0.15MHz-30MHz), Scan time: auto.

EUT:	“EverPlay” Wireless Portable Speaker	Phase :	N
Test Mode:	GFSK Mode Middle Channel		

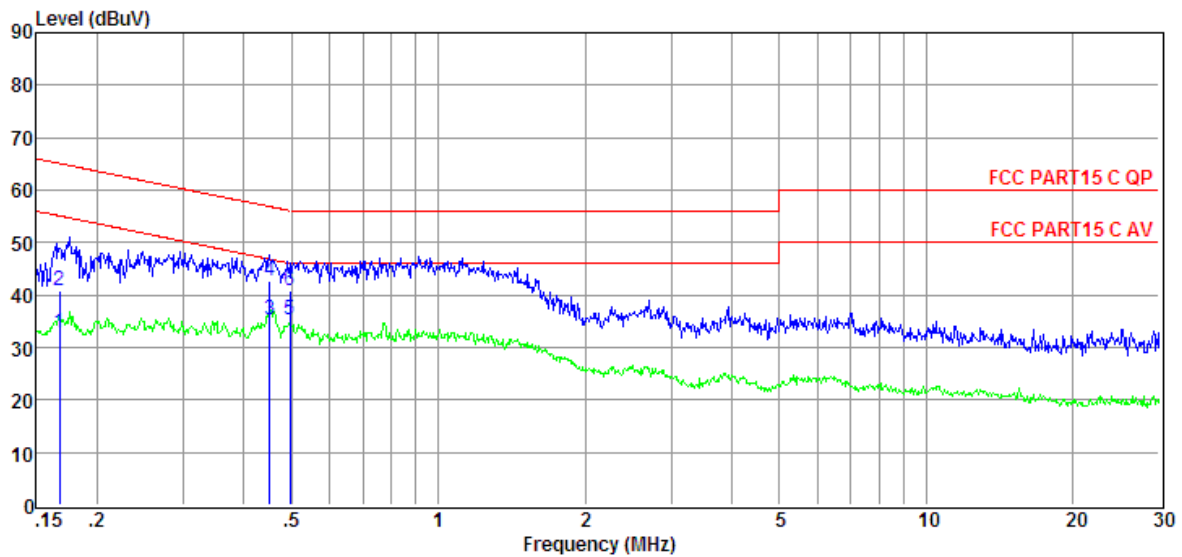

Item	Freq	Read Level	LISN Factor	Cable Loss	Pulse Limiter Factor	Result Level	Limit Line	Over Limit	Detector
(Mark)	(MHz)	(dBμV)	(dB)	(dB)	(dB)	(dBμV)	(dBμV)	(dB)	
1	0.168	13.42	9.61	0.02	9.86	32.91	55.08	-22.17	Average
2	0.168	21.47	9.61	0.02	9.86	40.96	65.08	-24.12	QP
3	0.452	15.66	9.61	0.02	9.86	35.15	46.85	-11.70	Average
4	0.452	23.05	9.61	0.02	9.86	42.54	56.85	-14.31	QP
5	0.497	15.62	9.61	0.02	9.86	35.11	46.05	-10.94	Average
6	0.497	21.48	9.61	0.02	9.86	40.97	56.05	-15.08	QP

- Note: 1. Result Level = Read Level + LISN Factor + Pulse Limiter Factor + Cable loss.
 2. If QP Result complies with AV limit, AV Result is deemed to comply with AV limit.
 3. Test setup: RBW: 200 Hz (9 kHz—150 kHz), 9 kHz (150 kHz—30 MHz).
 4. Step size: 80Hz (0.009MHz-0.15MHz), 4 kHz (0.15MHz-30MHz), Scan time: auto.

Note: All the modulation and channels had been tested, but only the worst data recorded in the report.

9. ANTENNA REQUIREMENTS

APPLICABLE REQUIREMENTS

Please refer to FCC §15.203

If directional gain of transmitting antennas is greater than 6dBi, the power shall be reduced by the same level in dB comparing to gain minus 6dBi. For the fixed point-to-point operation, the power shall be reduced by one dB for every 3 dB that the directional gain of the antenna exceeds 6 dBi. The use of a permanently attached antenna or of an antenna that uses a unique coupling to the intentional radiator shall be considered sufficient to comply with the FCC rule.

ANTENNA CONNECTOR

EUT has a PCB antenna without antenna connector.

ANTENNA GAIN

The antenna gain of EUT is less than 6 dBi.

END OF REPORT

Page 67 of 67