

VERS	CREATED BY	SUMMARY OF UPDATES	APPROVED FOR USE BY	DATE	PROJECT TEAM	GENERAL
0.3	Bazil Tung	0.3: translating from previous PGD template, adding pouch graphic	Bazil Tung	2014 03 05	Product Design Project Lead: Bazil Tung Trends, material and finishing: - - Product Manager: Jessica Lee I&D Project Manager: Calvin Lee	SCALE: 100% UNITS: mm
1.0	Bazil Tung	1.0: PPC passed 2014 03 07, PGD finalised for production	Bazil Tung	2014 03 11		

[01] Headband outer

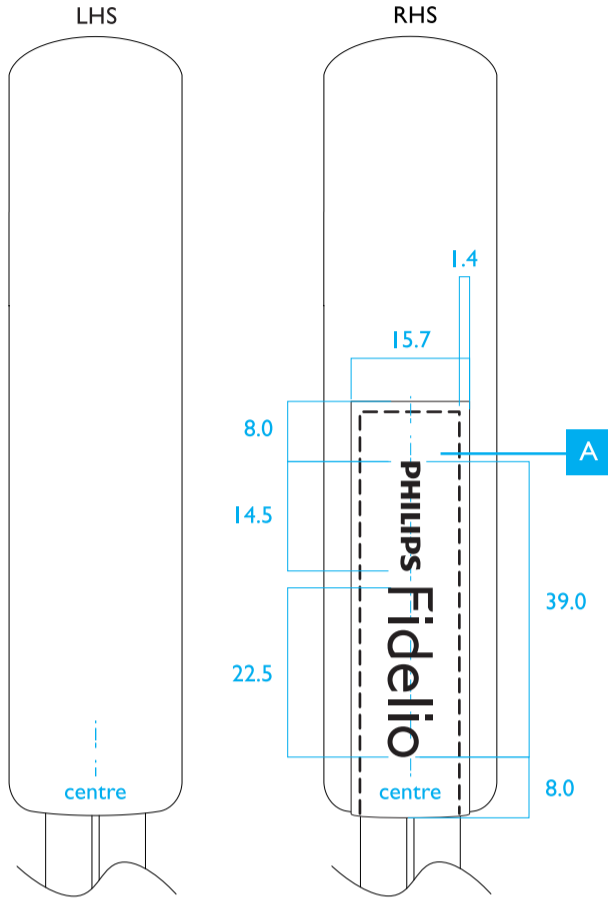

[06] Extension arm

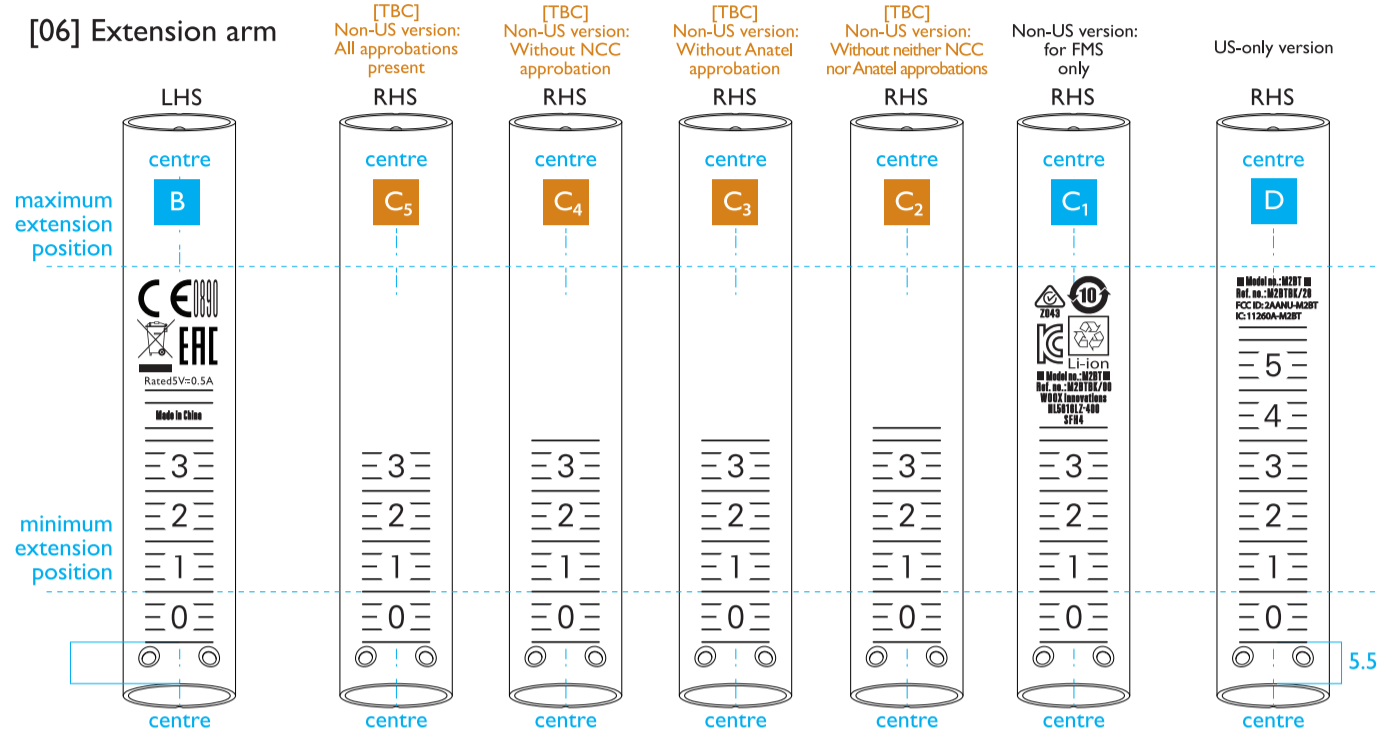

[04] Headband\_inner end cap

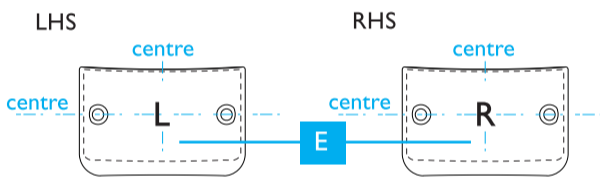

Device side audio jack

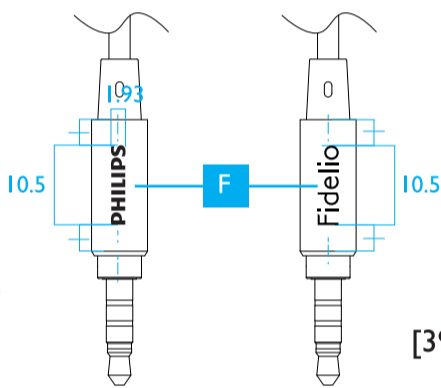

[34] Charging cable\_ charging device side\_ standard USB sleeve

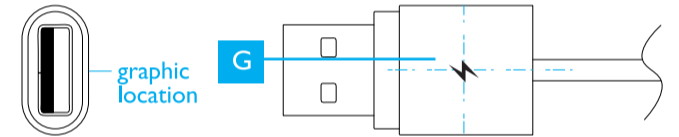

[32] Charging cable\_ headphone side\_ micro USB sleeve

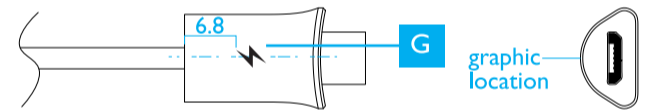

[39] Ear shell\_ hinge seal

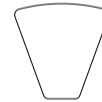

[3:45:18 PM] Wind Lin: FCC ID: 2AANU-M2BT  
IC: 11260A-M2BT

Graphic artwrok (scaled 1:1)

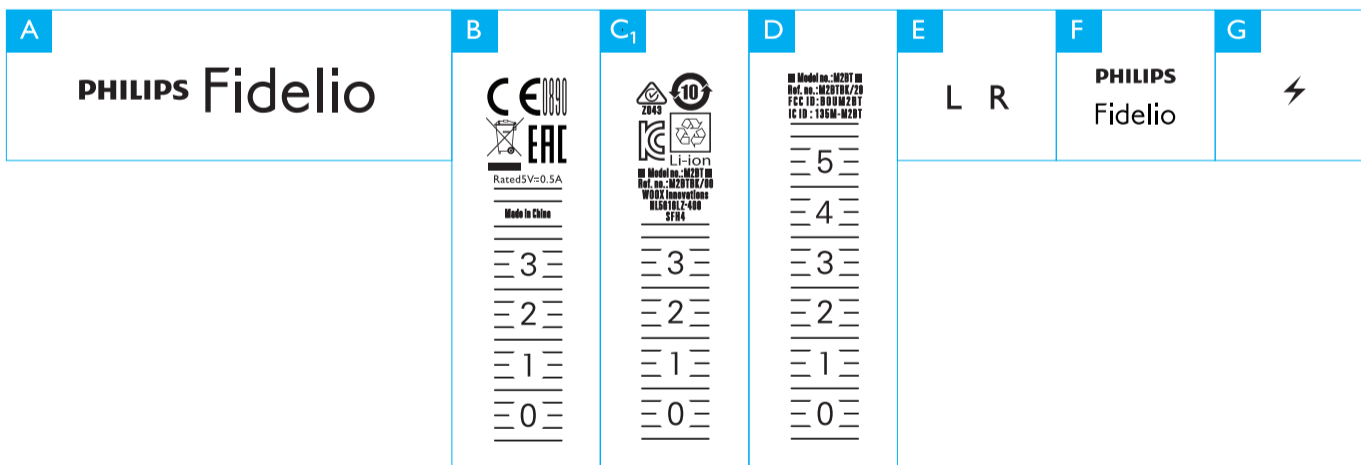

PART	COLOUR	TECHNIQUE	CHANGES / REMARKS	VER.
A PHILIPS FIDELIO maker's mark on headband	PMS Black 7C	Thick printing on small piece of genuine leather, satin finish, same leather material from L2	Same printing effect as L2	0.1
B Adjustment markings, WEEE, CE, EAC logos, CoO	Anodizing color	Laser etched BEFORE anodizing	Same effect as M1BT	0.1
C Adjustment markings, non-US approbation data	Anodizing color	Laser etched BEFORE anodizing	Same effect as M1BT	0.1
D Adjustment markings, US-only approbation data	Anodizing color	Laser etched BEFORE anodizing	Same effect as M1BT	0.1
E "L" & "R"	As per material color	Recess engraving, 0.15, high gloss finish	Same effect as M1BT	0.1
F PHILIPS and FIDELIO marks on audio jack sleeve (audio device side)	As per material color	Recess engraving, 0.15, high gloss finish (Rubber)	Same effect as M1BT	0.1
G Charging symbol	As per material color	Recess engraving, 0.15, high gloss finish (Rubber)	Same effect as M1BT	0.1

VERS	CREATED BY	SUMMARY OF UPDATES	APPROVED FOR USE BY	DATE	PROJECT TEAM	GENERAL
0.3	Bazil Tung	0.3: translating from previous PGD template, adding pouch graphic	Bazil Tung	2014 03 05	Product Design Project Lead: Bazil Tung Trends, material and finishing: - - Product Manager: Jessica Lee I&D Project Manager: Calvin Lee	SCALE: 100% UNITS: mm
1.0	Bazil Tung	1.0: PPC passed 2014 03 07, PGD finalised for production	Bazil Tung	2014 03 11		

[46] Speaker driver\_ sealing plate

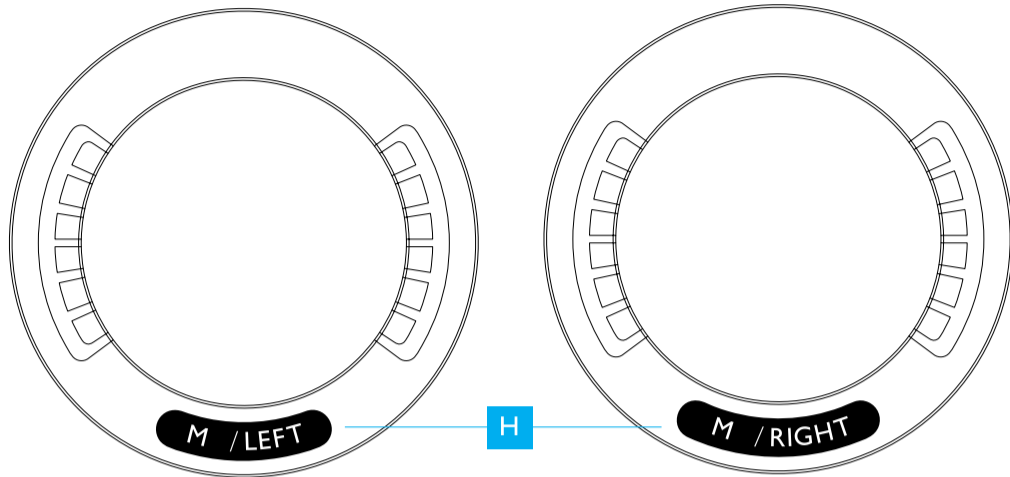

[08L] Ear shell LEFT\_ O-ring

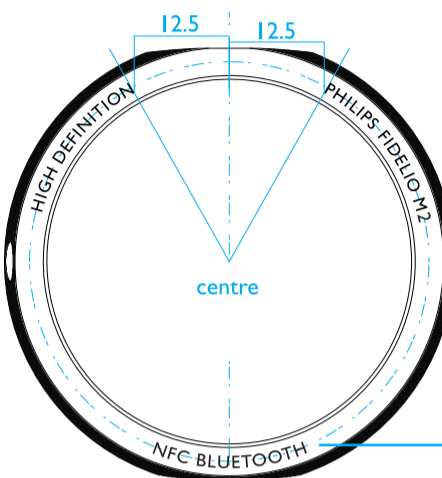

[08R] Ear shell RIGHT\_ O-ring

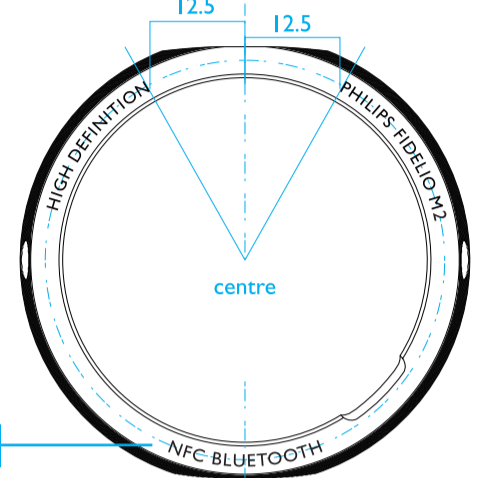

[44] Speaker driver\_ housing

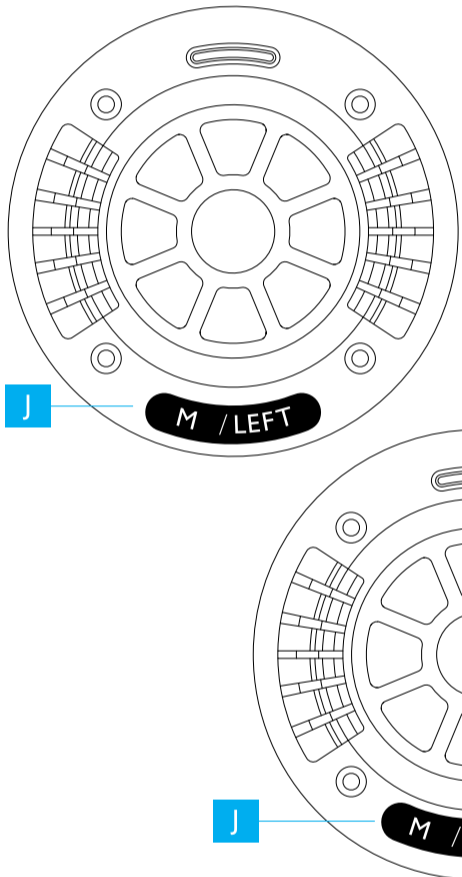

[10L] Ear shell LEFT\_ back housing

Serial no. label size  
(for US-only version):  
12.0 x 3.0 x R0.5(x4)

Serial no. label size  
(for non-US version):  
12.0 x 2.5 x R0.5(x4)

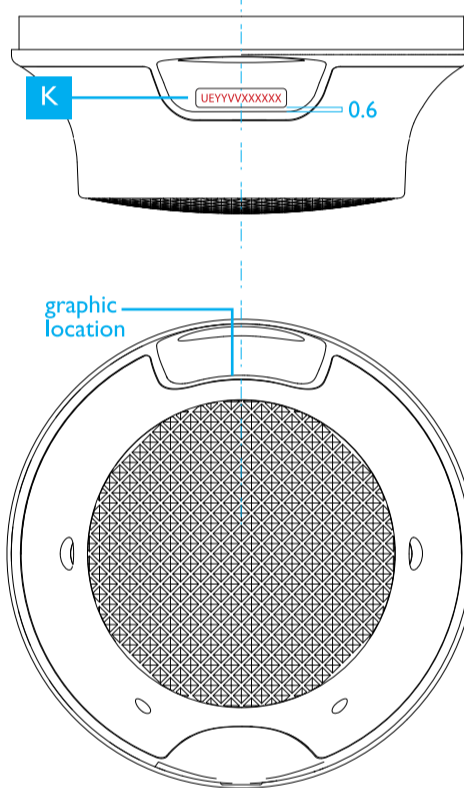

[09R] Ear shell RIGHT\_ front housing

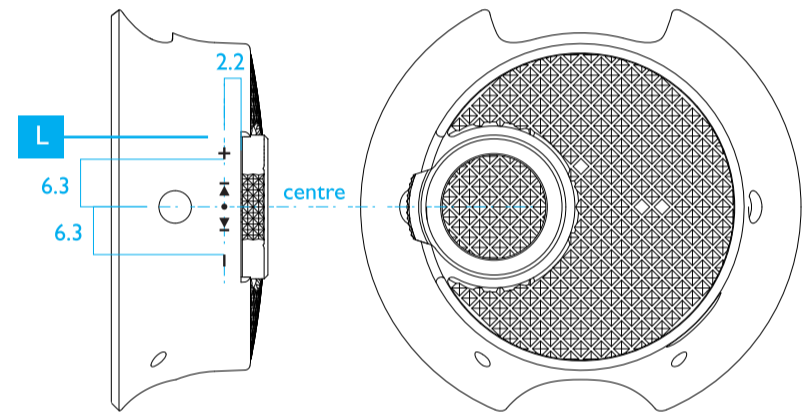

Graphic artwrok (scaled 1:1)

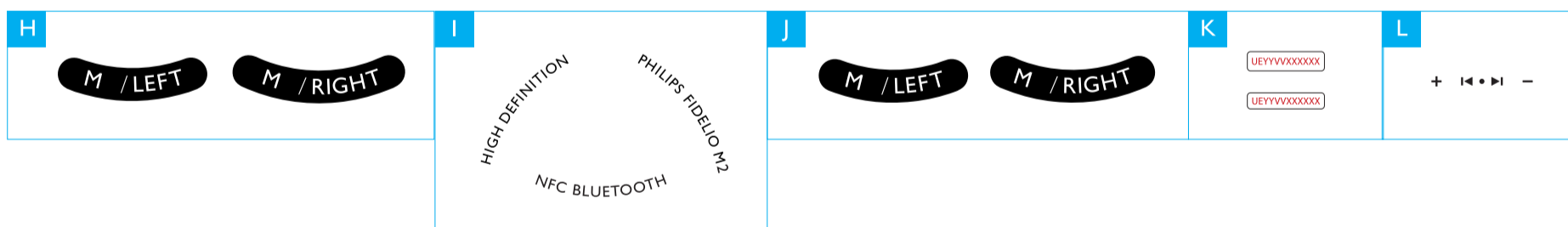

PART	COLOUR	TECHNIQUE	CHANGES / REMARKS	VER.
H	As per material color	Shape: recess engraving, 0.35, high gloss finish Texts: raised embossing, 0.35, matte finish	Graphic update (remove "1" from "M1"), same effect as M1BT	0.2
I	As per material color	Laser etched AFTER anodizing	Same effect as M1BT	0.1
J	As per material color	Shape: recess engraving, 0.35, high gloss finish Texts: raised embossing, 0.35, matte finish	Graphic update (remove "1" from "M1"), same effect as M1BT	0.1
K	Texts: White Label: Black	Printed sticker	Same effect as M1BT	0.1
L	PMS 8403 mid silver	Silk-screen	Same effect as M1BT	0.1

VERS	CREATED BY	SUMMARY OF UPDATES	APPROVED FOR USE BY	DATE	PROJECT TEAM	GENERAL
0.3	Bazil Tung	0.3: translating from previous PGD template, adding pouch graphic	Bazil Tung	2014 03 05	Product Design Project Lead: Bazil Tung Trends, material and finishing: - - Product Manager: Jessica Lee I&D Project Manager: Calvin Lee	SCALE: 100% UNITS: mm
1.0	Bazil Tung	1.0: PPC passed 2014 03 07, PGD finalised for production	Bazil Tung	2014 03 11		

[45] Protective pouch

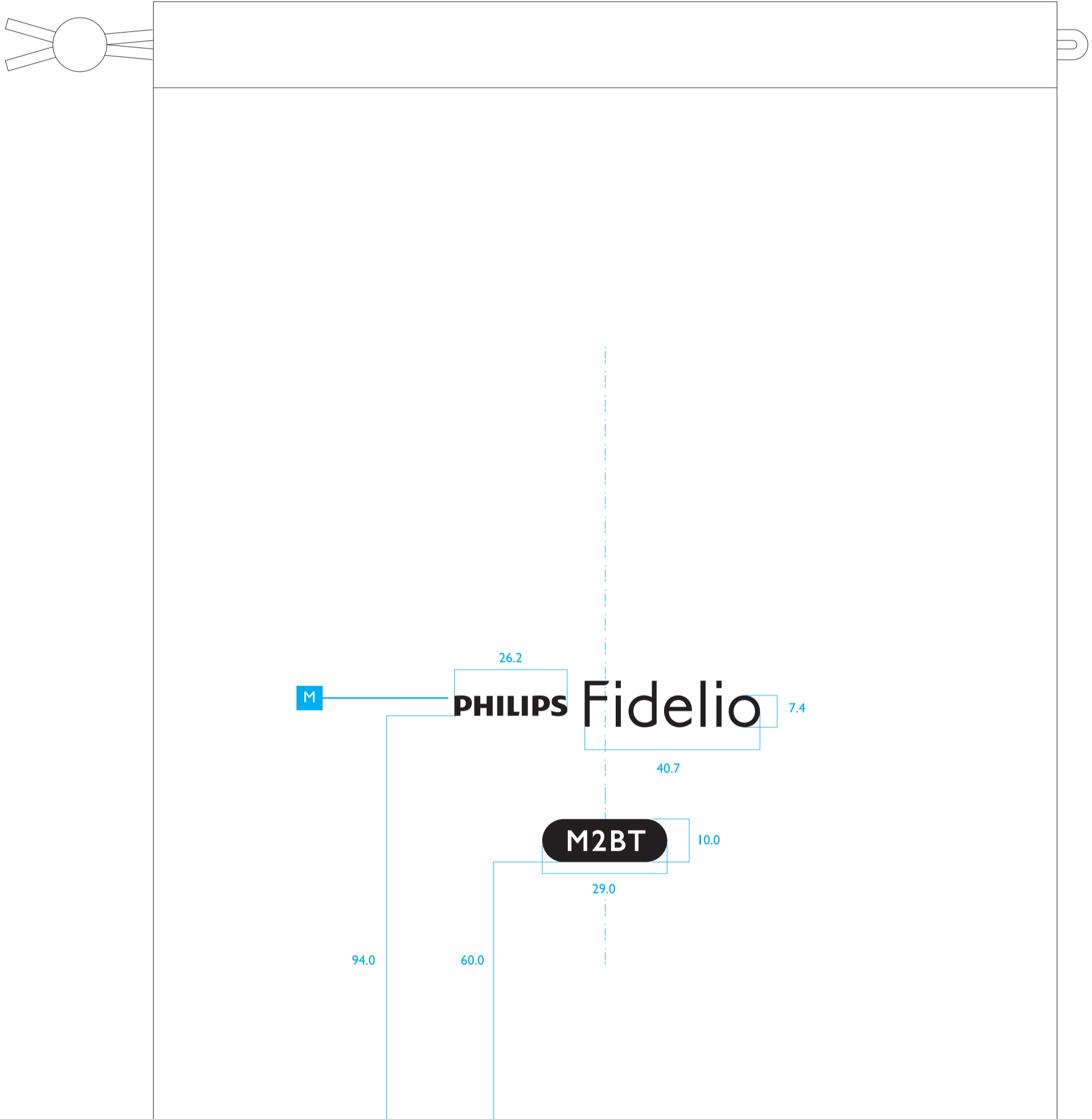

Graphic artwrok (scaled 1:1)



PART	COLOUR	TECHNIQUE	CHANGES / REMARKS	VER.
M "Philips Fidelio" maker's mark and shape with "M2BT"	As per material color	Heat press on suede material (heat press on one side of pouch only)	"Philips Fidelio" graphic same dimensions as M1BT, overall same effect as M1BT	0.3