

TEST REPORT

Report No.: BCTC2211266692-3E

Applicant: SHEN ZHEN NST INDUSTRY AND TRADE CO.,LTD

Product Name: 10.1inch tablet pc

Model/Type Ref.: M107FT

Tested Date: 2022-11-29 to 2022-12-13

Issued Date: 2022-12-13

Shenzhen BCTC Testing Co., Ltd.



FCC ID:2AAMS-M107FT

Product Name: 10.1inch tablet pc
Trademark: N/A
Model/Type Ref.: M107FT
M107FA,M107FB,M107FC,M107FD,M107FE
Prepared For: SHEN ZHEN NST INDUSTRY AND TRADE CO.,LTD
Address: 3-4/F, Bldg 1, Hongbang Intelligent Technology Park, No.30 Cuibao Road, Baolong Street, Longgang District, Shenzhen, China
Manufacturer: SHEN ZHEN NST INDUSTRY AND TRADE CO.,LTD
Address: 3-4/F, Bldg 1, Hongbang Intelligent Technology Park, No.30 Cuibao Road, Baolong Street, Longgang District, Shenzhen, China
Prepared By: Shenzhen BCTC Testing Co., Ltd.
Address: 1-2/F., Building B, Pengzhou Industrial Park, No.158, Fuyuan 1st Road, Zhancheng, Fuhai Subdistrict, Bao'an District, Shenzhen, Guangdong, China
Sample Received Date: 2022-11-29
Sample tested Date: 2022-11-29 to 2022-12-13
Issue Date: 2022-12-13
Report No.: BCTC2211266692-3E
Test Standards: FCC Part15.247
ANSI C63.10-2013
Test Results: PASS
Remark: This is WIFI-2.4GHz band radio test report.

Tested by:



Jeff.Fu/Project Handler

Approved by:



Zero Zhou/Reviewer

The test report is effective only with both signature and specialized stamp. This result(s) shown in this report refer only to the sample(s) tested. Without written approval of Shenzhen BCTC Testing Co., Ltd, this report can't be reproduced except in full. The tested sample(s) and the sample information are provided by the client.

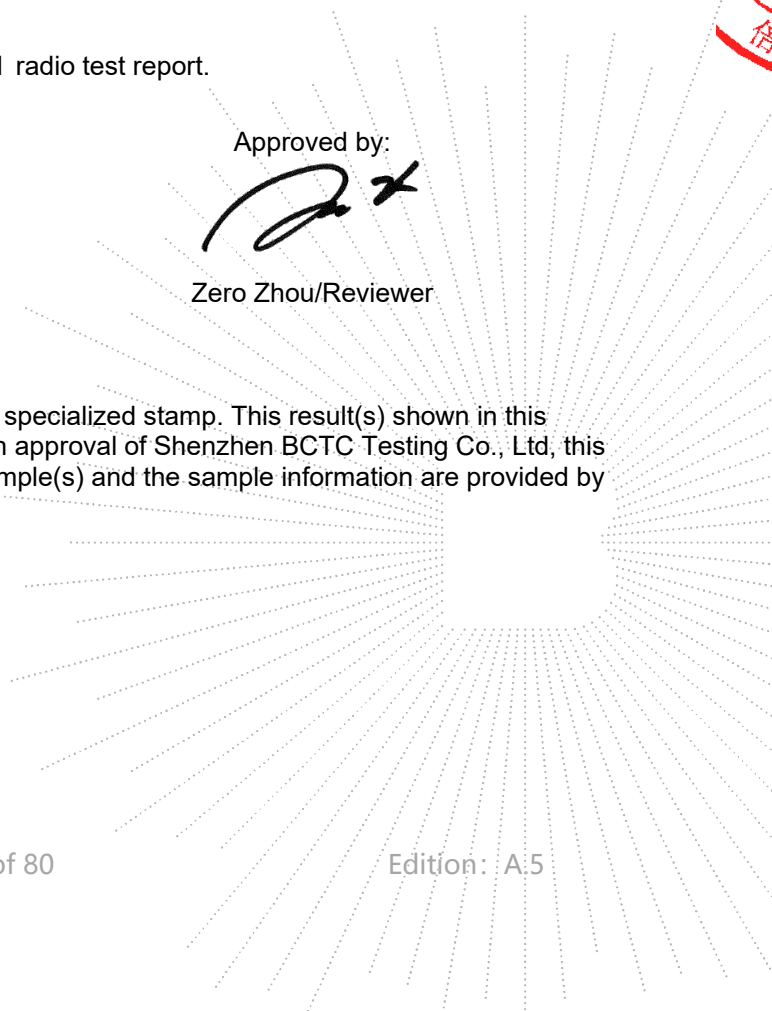

Table Of Content

Test Report Declaration	Page
1. Version	5
2. Test Summary	6
3. Measurement Uncertainty	7
4. Product Information And Test Setup	8
4.1 Product Information	8
4.2 Test Setup Configuration	8
4.3 Support Equipment	9
4.4 Channel List	9
4.5 Test Mode	10
4.6 Table Of Parameters Of Text Software Setting	10
5. Test Facility And Test Instrument Used	11
5.1 Test Facility	11
5.2 Test Instrument Used	11
6. Conducted Emissions	13
6.1 Block Diagram Of Test Setup	13
6.2 Limit	13
6.3 Test Procedure	13
6.4 EUT Operating Conditions	13
6.5 Test Result	14
7. Radiated Emissions	16
7.1 Block Diagram Of Test Setup	16
7.2 Limit	17
7.3 Test Procedure	18
7.4 EUT Operating Conditions	19
7.5 Test Result	19
8. Radiated Band Emission Measurement And Restricted Bands Of Operation	26
8.1 Block Diagram Of Test Setup	26
8.2 Limit	26
8.3 Test Procedure	27
8.4 EUT operating Conditions	27
8.5 Test Result	28
9. Power Spectral Density Test	30
9.1 Block Diagram Of Test Setup	30
9.2 Limit	30
9.3 Test Procedure	30
9.4 EUT Operating Conditions	30
9.5 Test Result	31
10. Bandwidth Test	38
10.1 Block Diagram Of Test Setup	38
10.2 Limit	38
10.3 Test Procedure	38
10.4 EUT Operating Conditions	38

BCTC
 BCTC
 PPR
 检测

10.5	Test Result	39
11.	Peak Output Power Test	46
11.1	Block Diagram Of Test Setup.....	46
11.2	Limit	46
11.3	Test Procedure	46
11.4	EUT Operating Conditions	46
11.5	Test Result	47
12.	100 KHz Bandwidth Of Frequency Band Edge.....	48
12.1	Block Diagram Of Test Setup.....	48
12.2	Limit	48
12.3	Test Procedure	48
12.4	EUT Operating Conditions	48
12.5	Test Result	49
13.	Duty Cycle Of Test Signal	69
13.1	Standard Requirement	69
13.2	Formula.....	69
13.3	Test Procedure	69
13.4	Test Result	69
14.	Antenna Requirement	76
14.1	Limit	76
14.2	Test Result.....	76
15.	EUT Photographs.....	77
16.	EUT Test Setup Photographs.....	78

(Note: N/A means not applicable)

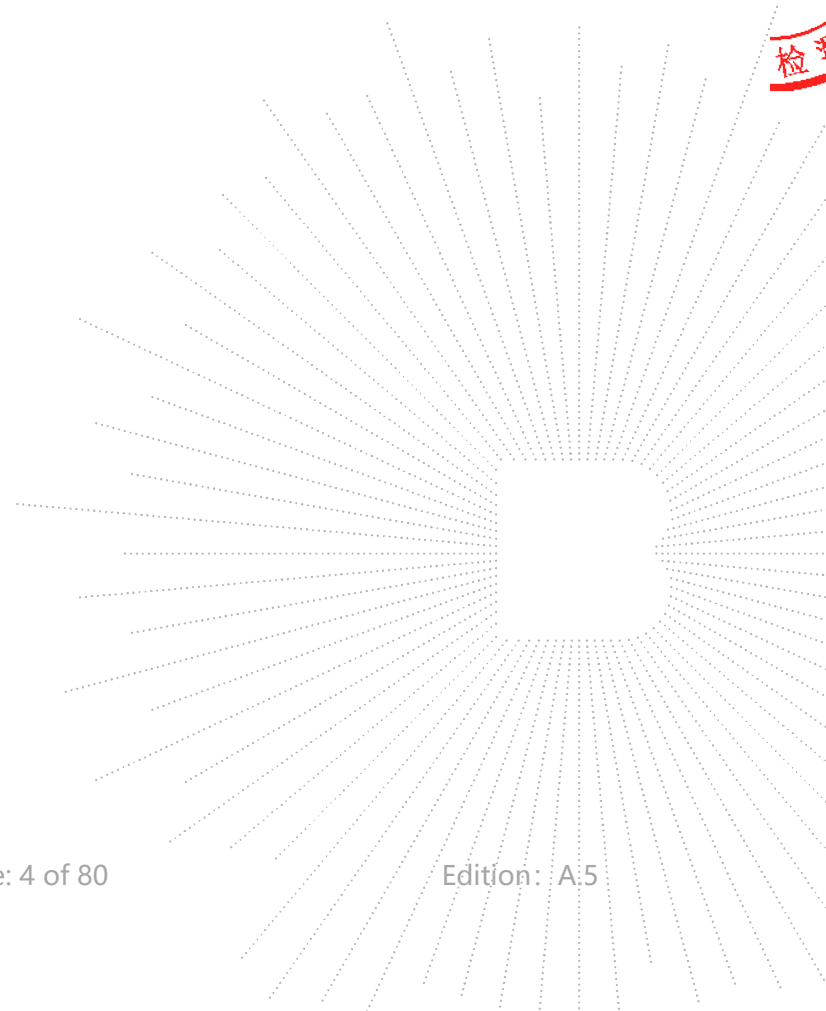

TE
TC
OVB
檢

1. Version

Report No.	Issue Date	Description	Approved
BCTC2211266692-3E	2022-12-13	Original	Valid

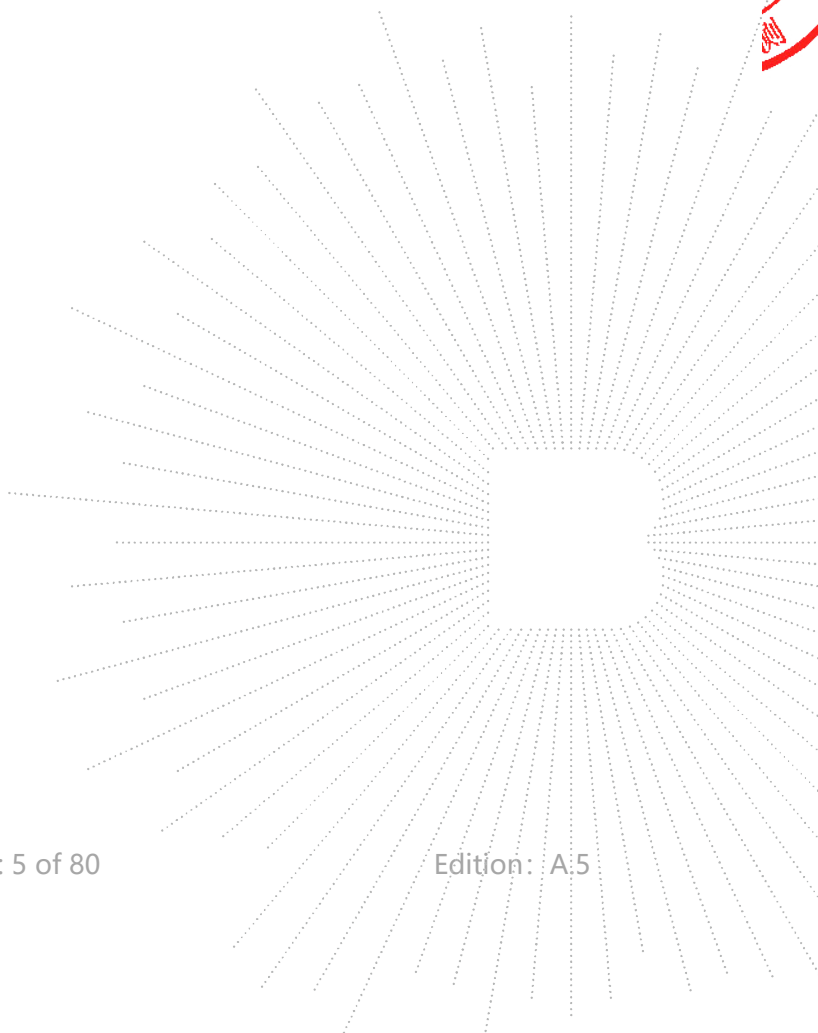

2. Test Summary

The Product has been tested according to the following specifications:

No.	Test Parameter	Clause No	Results
1	Conducted Emission	15.207	PASS
2	6dB Bandwidth	15.247 (a)(2)	PASS
3	Peak Output Power	15.247 (b)	PASS
4	Radiated Spurious Emission	15.247 (d)	PASS
5	Power Spectral Density	15.247 (e)	PASS
6	Restricted Band of Operation	15.205	PASS
7	Band Edge (Out of Band Emissions)	15.247 (d)	PASS
8	Antenna Requirement	15.203	PASS

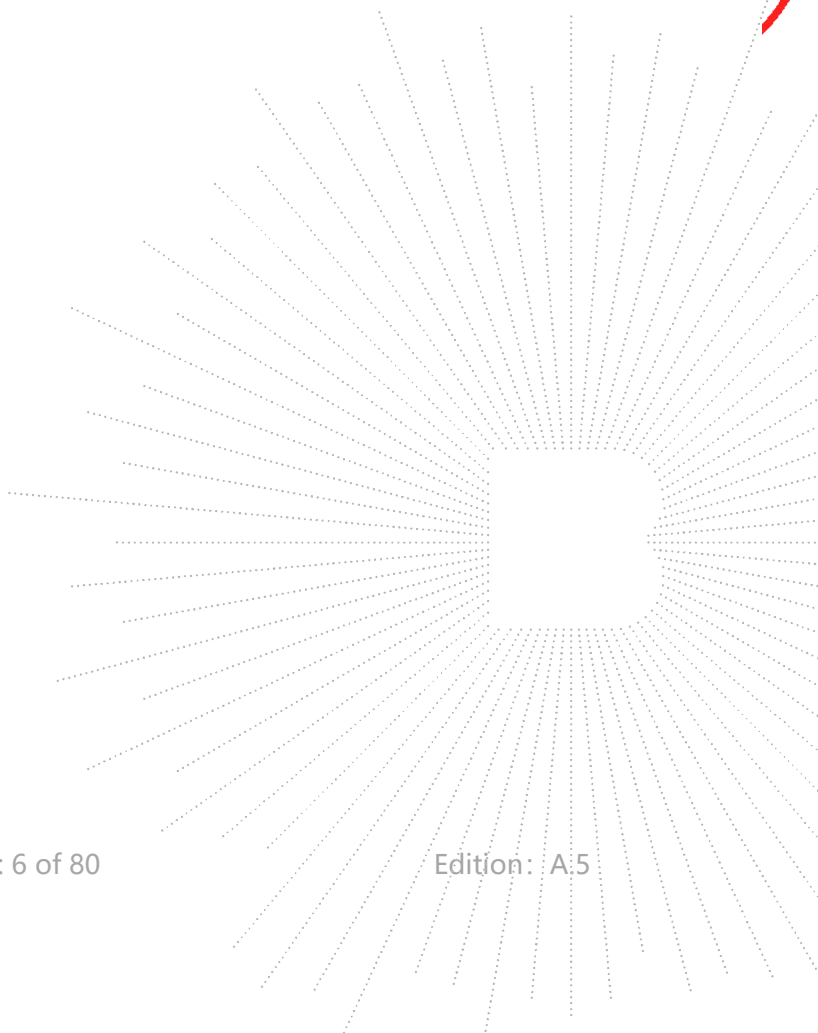
3. Measurement Uncertainty

Where relevant, the following measurement uncertainty levels have been estimated for tests performed on the Product as specified in CISPR 16-4-2. This uncertainty represents an expanded uncertainty expressed at approximately the 95% confidence level using a coverage factor of $k=2$.

No.	Item	Uncertainty
1	3m chamber Radiated spurious emission(9kHz-30MHz)	U=3.7dB
2	3m chamber Radiated spurious emission(30MHz-1GHz)	U=4.3dB
3	3m chamber Radiated spurious emission(1GHz-18GHz)	U=4.5dB
4	3m chamber Radiated spurious emission(18GHz-40GHz)	U=3.34dB
5	Conducted Emission(150kHz-30MHz)	U=3.20dB
6	Conducted Adjacent channel power	U=1.38dB
7	Conducted output power uncertainty Above 1G	U=1.576dB
8	Conducted output power uncertainty below 1G	U=1.28dB
9	humidity uncertainty	U=5.3%
10	Temperature uncertainty	U=0.59°C

4. Product Information And Test Setup

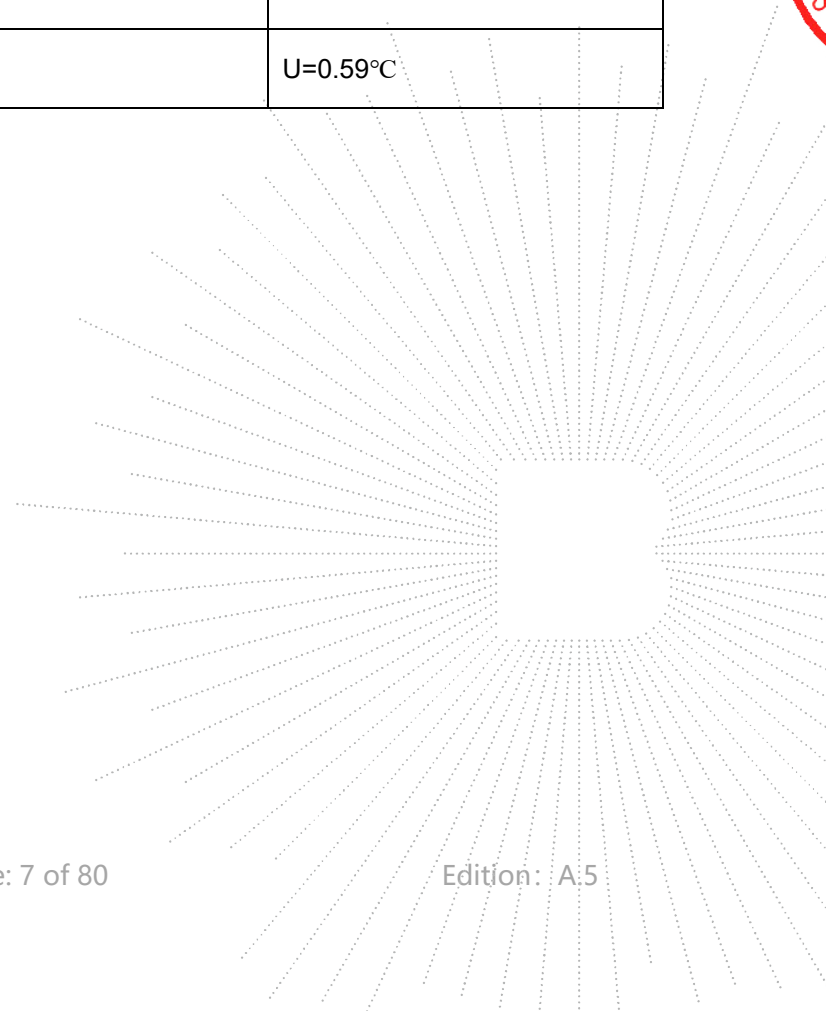
4.1 Product Information

Model/Type Ref.:	M107FT M107FA,M107FB,M107FC,M107FD,M107FE
Model differences:	All the model are the same circuit and RF module, except model names and appearance color.
Hardware Version:	N/A
Software Version:	N/A
Operation Frequency:	802.11b/g/n20MHz:2412~2462 MHz 802.11n40MHz:2422~2452 MHz
Bit Rate of Transmitter	802.11b:11/5.5/2/1 Mbps 802.11g:54/48/36/24/18/12/9/6Mbps 802.11n Up to 150Mbps
Type of Modulation:	OFDM/DSSS
Number Of Channel:	802.11b/g/n20MHz:11 CH 802.11n40MHz: 7 CH
Antenna installation:	FPCB antenna
Antenna Gain:	3.95 dBi
Ratings:	DC 5V From Adapter, DC 3.8V From Battery Manufacture: Shenzhen Jiuzhou Power Technology Co., Ltd.
Adapter:	Model No.:J121L-0502000IU Input:100-240~ 50/60Hz 0.6A Output: DC 5V 2A

4.2 Test Setup Configuration

See test photographs attached in *EUT TEST SETUP PHOTOGRAPHS* for the actual connections between Product and support equipment.

Conducted Emission:

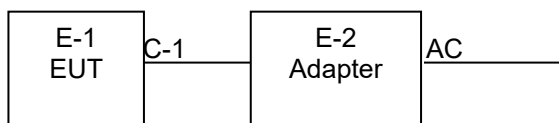

Radiated Spurious Emission

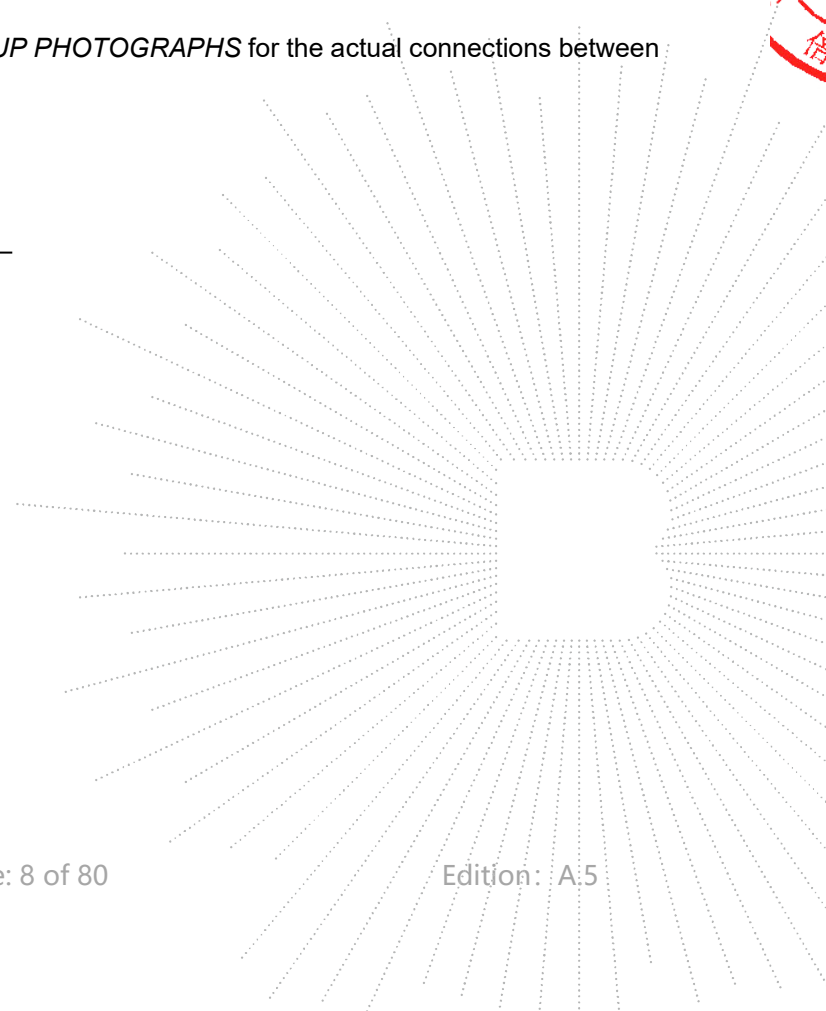
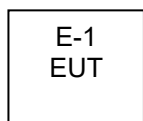

4.3 Support Equipment

No.	Device Type	Brand	Model	Series No.	Note
E-1	10.1inch tablet pc	N/A	M107FT	N/A	EUT
E-2	Adapter	N/A	J121L-0502000IU	N/A	EUT

Item	Shielded Type	Ferrite Core	Length	Note
C-1	NO	NO	0.5M	DC cable unshielded

Notes:

1. All the equipment/cables were placed in the worst-case configuration to maximize the emission during the test.
2. Grounding was established in accordance with the manufacturer's requirements and conditions for the intended use.

4.4 Channel List

Channel List for 802.11b/g/n(20)					
Channel	Frequency (MHz)	Channel	Frequency (MHz)	Channel	Frequency (MHz)
01	2412	02	2417	03	2422
04	2427	05	2432	06	2437
07	2442	08	2447	09	2452
10	2457	11	2462		

Channel List for 802.11n(40)					
Channel	Frequency (MHz)	Channel	Frequency (MHz)	Channel	Frequency (MHz)
03	2422	04	2427	05	2432
06	2437	07	2442	08	2447
09	2452				

BCTC
 3C
 PPR
 检测

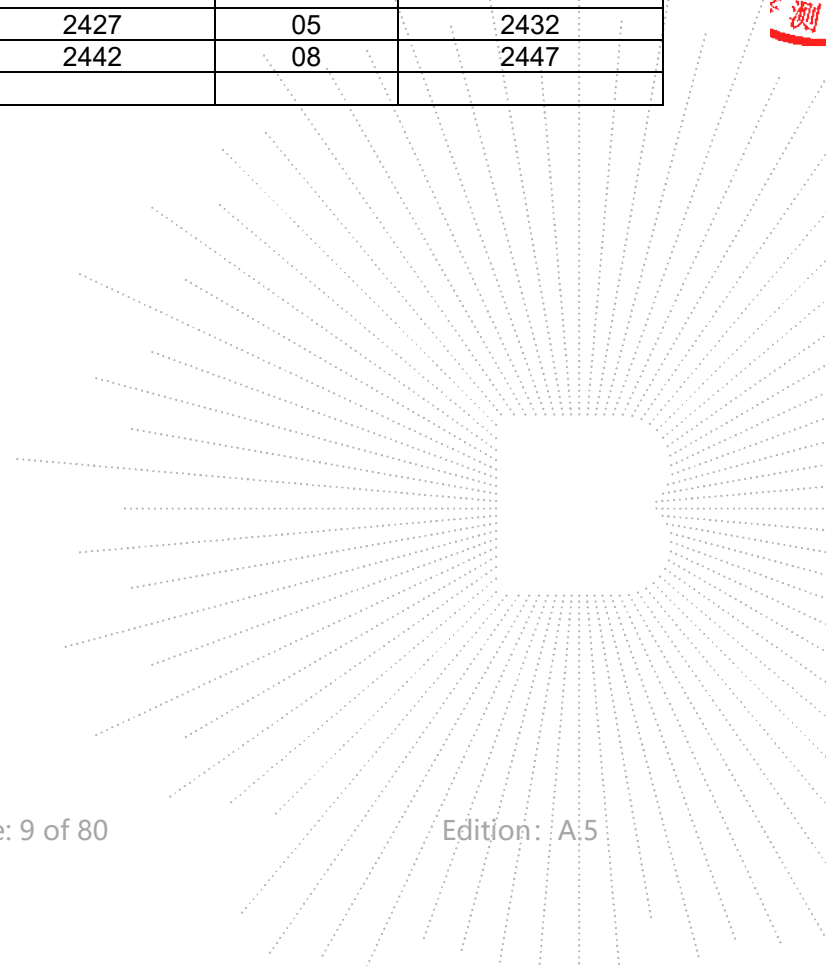

4.5 Test Mode

To investigate the maximum EMI emission characteristics generates from EUT, the test system was pre-scanning tested base on the consideration of following EUT operation mode or test configuration mode which possible have effect on EMI emission level. Each of these EUT operation mode(s) or test configuration mode(s) mentioned above was evaluated respectively.

Pretest Mode	Description
Mode 1	802.11b CH1/ CH6/ CH11
Mode 2	802.11g CH1/ CH6/ CH11
Mode 3	802.11n20 CH1/ CH6/ CH11
Mode 4	802.11n40 CH3/ CH6/ CH9
Mode 5	Link Mode

Radiated Emission	
Final Test Mode	Description
Mode 5	Link Mode

For Radiated Emission	
Final Test Mode	Description
Mode 1	802.11b CH1/ CH6/ CH11
Mode 2	802.11g CH1/ CH6/ CH11
Mode 3	802.11n20 CH1/ CH6/ CH11
Mode 4	802.11n40 CH3/ CH6/ CH9

Note:

(1) The measurements are performed at all Bit Rate of Transmitter, the worst data was reported.

4.6 Table Of Parameters Of Text Software Setting

During testing channel & power controlling software provided by the customer was used to control the operating channel as well as the output power level. The RF output power selection is for the setting of RF output power expected by the customer and is going to be fixed on the firmware of the final end product power parameters

Test software Version	CMD		
Frequency	2412 MHz	2437 MHz	2462 MHz
Parameters	DEF	DEF	DEF
Frequency	2422MHz	2437MHz	2452MHz
Parameters	DEF	DEF	DEF

TEST
 TO
 OVER
 検査

5. Test Facility And Test Instrument Used

5.1 Test Facility

All measurement facilities used to collect the measurement data are located at Shenzhen BCTC Testing Co., Ltd. Address: 1-2/F., Building B, Pengzhou Industrial Park, No.158, Fuyuan 1st Road, Zhancheng, Fuhai Subdistrict, Bao'an District, Shenzhen, Guangdong, China. The site and apparatus are constructed in conformance with the requirements of ANSI C63.4 and CISPR 16-1-1 other equivalent standards. FCC Test Firm Registration Number: 712850
IC Registered No.: 23583

5.2 Test Instrument Used

Conducted emissions Test					
Equipment	Manufacturer	Model#	Serial#	Last Cal.	Next Cal.
Receiver	R&S	ESR3	102075	May 24, 2022	May 23, 2023
LISN	R&S	ENV216	101375	May 24, 2022	May 23, 2023
Software	Frad	EZ-EMC	EMC-CON 3A1	\	\
Attenuator	\	10dB DC-6GHz	1650	May 24, 2022	May 23, 2023

RF Conducted Test					
Equipment	Manufacturer	Model#	Serial#	Last Cal.	Next Cal.
Power Metter	Keysight	E4419	\	May 24, 2022	May 23, 2023
Power Sensor (AV)	Keysight	E9300A	\	May 24, 2022	May 23, 2023
Signal Analyzer20kH z-26.5GHz	Keysight	N9020A	MY49100060	May 24, 2022	May 23, 2023
Spectrum Analyzer9kHz- 40GHz	R&S	FSP40	100363	May 24, 2022	May 23, 2023
Radio frequency control box	MAIWEI	MW100-RF CB	\	\	\
Software	MAIWEI	MTS 8310	\	\	\

Radiated Emissions Test (966 Chamber01)					
Equipment	Manufacturer	Model#	Serial#	Last Cal.	Next Cal.
966 chamber	ChengYu	966 Room	966	Jun. 06. 2020	Jun. 05, 2023
Receiver	R&S	ESR3	102075	May 24, 2022	May 23, 2023
Receiver	R&S	ESRP	101154	May 24, 2022	May 23, 2023
Amplifier	Schwarzbeck	BBV9744	9744-0037	May 24, 2022	May 23, 2023
TRILOG Broadband Antenna	Schwarzbeck	VULB9163	942	May 26, 2022	May 25, 2023
Loop Antenna(9KHz -30MHz)	Schwarzbeck	FMZB1519B	00014	May 26, 2022	May 25, 2023
Amplifier	SKET	LAPA_01G18 G-45dB	\	May 24, 2022	May 23, 2023
Horn Antenna	Schwarzbeck	BBHA9120D	1541	Jun. 06, 2022	Jun. 05, 2023
Amplifier(18G Hz-40GHz)	MITEQ	TTA1840-35- HG	2034381	May 26, 2022	May 25, 2023
Horn Antenna(18G Hz-40GHz)	Schwarzbeck	BBHA9170	00822	Jun. 06, 2022	Jun. 05, 2023
Spectrum Analyzer9kHz- 40GHz	R&S	FSP40	100363	May 24, 2022	May 23, 2023
Software	Frad	EZ-EMC	FA-03A2 RE	\	\

CO., LTD.

6. Conducted Emissions

6.1 Block Diagram Of Test Setup

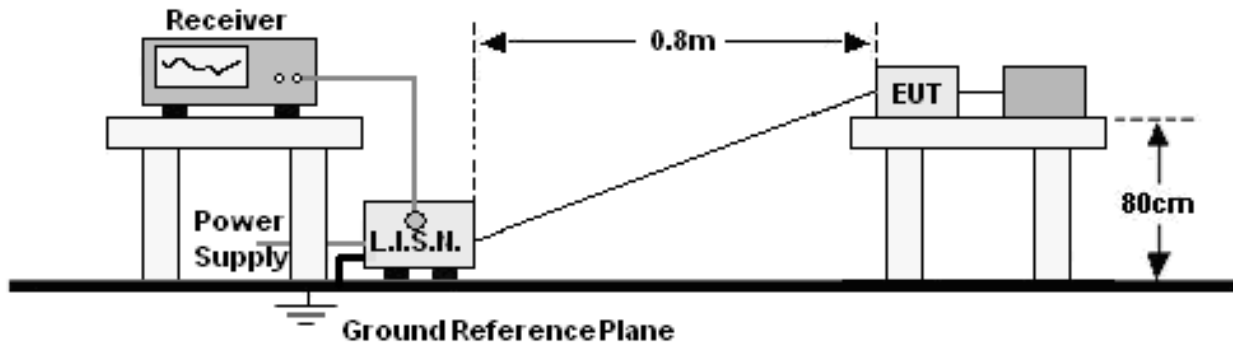

6.2 Limit

FREQUENCY (MHz)	Limit (dBuV)	
	Quas-peak	Average
0.15 -0.5	66 - 56 *	56 - 46 *
0.50 -5.0	56.00	46.00
5.0 -30.0	60.00	50.00

Notes:
 1. *Decreasing linearly with logarithm of frequency.
 2. The lower limit shall apply at the transition frequencies.

6.3 Test Procedure

Receiver Parameters	Setting
Attenuation	10 dB
Start Frequency	0.15 MHz
Stop Frequency	30 MHz
IF Bandwidth	9 kHz

- The Product was placed on a nonconductive table 0.8 m above the horizontal ground reference plane, and 0.4 m from the vertical ground reference plane, and connected to the main through Line Impedance Stability Network (L.I.S.N).
- The RBW of the receiver was set at 9 kHz in 150 kHz ~ 30MHz with Peak and AVG detector in Max Hold mode. Run the receiver's pre-scan to record the maximum disturbance generated from Product in all power lines in the full band.
- For each frequency whose maximum record was higher or close to limit, measure its QP and AVG values and record.

6.4 EUT Operating Conditions

The EUT was configured for testing in a typical fashion (as a customer would normally use it). The EUT has been programmed to continuously transmit during test. This operating condition was tested and used to collect the included data.

6.5 Test Result

Temperature :	26 °C	Relative Humidity :	54%
Pressure:	101kPa	Phase :	Line
Test Voltage :	AC 120V/60Hz	Test Mode:	Mode 5

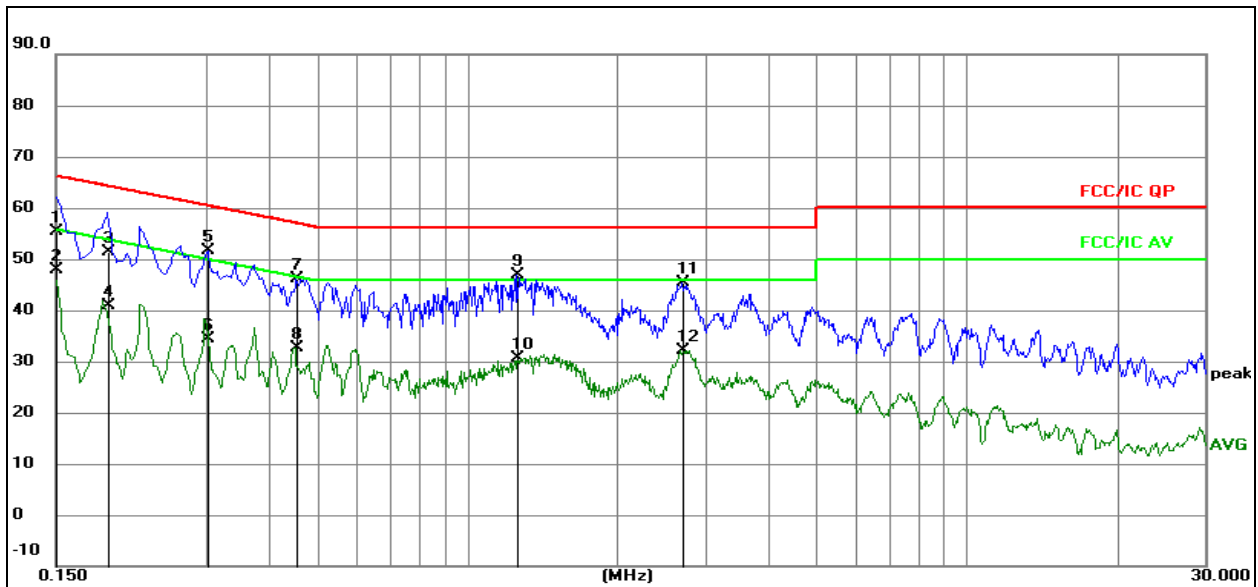

Remark:

1. All readings are Quasi-Peak and Average values.
2. Factor = Insertion Loss + Cable Loss.
3. Measurement=Reading Level+ Correct Factor
4. Over=Measurement-Limit

No. Mk.	Freq. MHz	Reading Level	Correct Factor dB	Measure- ment dBuV	Limit dBuV	Over dB	Detector
1	0.1500	35.79	19.67	55.46	66.00	-10.54	QP
2 *	0.1500	28.25	19.67	47.92	56.00	-8.08	AVG
3	0.1910	31.63	19.78	51.41	63.99	-12.58	QP
4	0.1910	21.21	19.78	40.99	53.99	-13.00	AVG
5	0.3030	31.80	19.77	51.57	60.16	-8.59	QP
6	0.3030	14.56	19.77	34.33	50.16	-15.83	AVG
7	0.4560	26.38	19.73	46.11	56.77	-10.66	QP
8	0.4560	12.93	19.73	32.66	46.77	-14.11	AVG
9	1.2570	27.14	19.79	46.93	56.00	-9.07	QP
10	1.2570	10.90	19.79	30.69	46.00	-15.31	AVG
11	2.7015	25.42	19.96	45.38	56.00	-10.62	QP
12	2.7015	12.27	19.96	32.23	46.00	-13.77	AVG

Temperature :	26 °C	Relative Humidity :	54%
Pressure:	101kPa	Phase :	Neutral
Test Voltage :	AC 120V/60Hz	Test Mode:	Mode 5

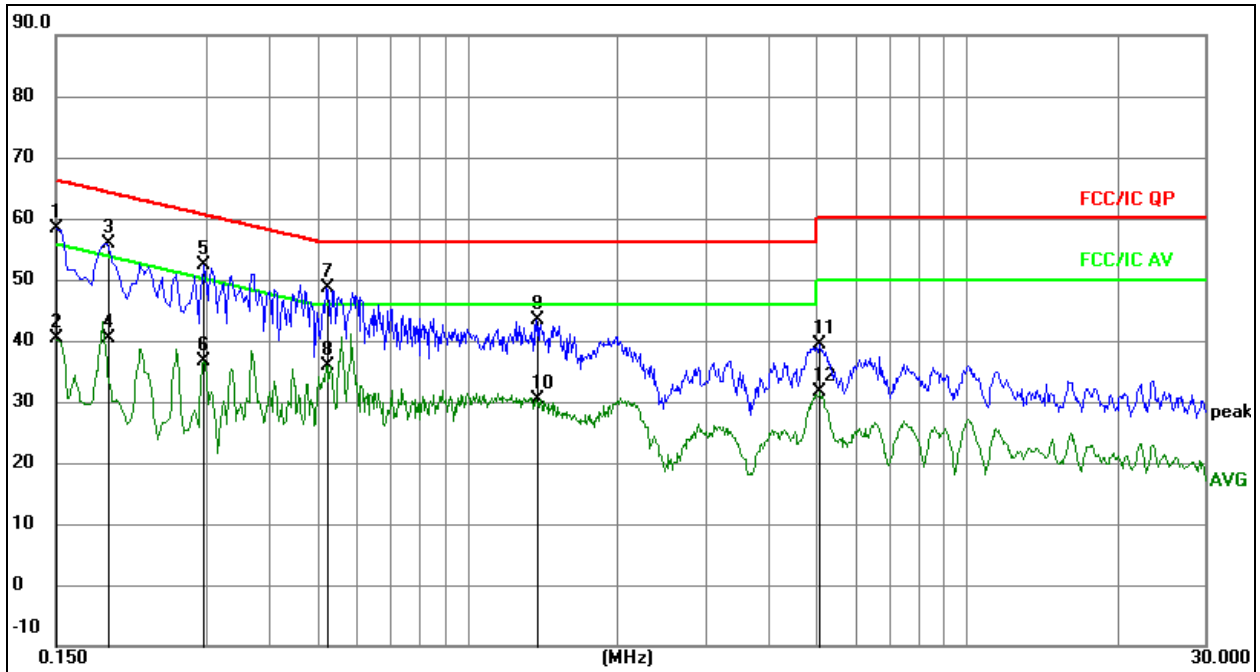
Remark:

1. All readings are Quasi-Peak and Average values.
2. Factor = Insertion Loss + Cable Loss.
3. Measurement=Reading Level+ Correct Factor
4. Over=Measurement-Limit

No.	Mk.	Freq. MHz	Reading Level	Correct Factor dB	Measure- ment dBuV	Limit dBuV	Over dB	Detector
1		0.1500	38.61	19.67	58.28	66.00	-7.72	QP
2		0.1500	20.70	19.67	40.37	56.00	-15.63	AVG
3		0.1904	36.17	19.78	55.95	64.02	-8.07	QP
4		0.1904	20.66	19.78	40.44	54.02	-13.58	AVG
5		0.2971	32.62	19.77	52.39	60.32	-7.93	QP
6		0.2971	16.81	19.77	36.58	50.32	-13.74	AVG
7	*	0.5210	28.92	19.72	48.64	56.00	-7.36	QP
8		0.5210	16.27	19.72	35.99	46.00	-10.01	AVG
9		1.3738	23.52	19.80	43.32	56.00	-12.68	QP
10		1.3738	10.67	19.80	30.47	46.00	-15.53	AVG
11		5.0580	19.14	20.13	39.27	60.00	-20.73	QP
12		5.0580	11.38	20.13	31.51	50.00	-18.49	AVG

BCTC
 3C
 PPR
 检测

7. Radiated Emissions

7.1 Block Diagram Of Test Setup

(A) Radiated Emission Test-Up Frequency Below 30MHz

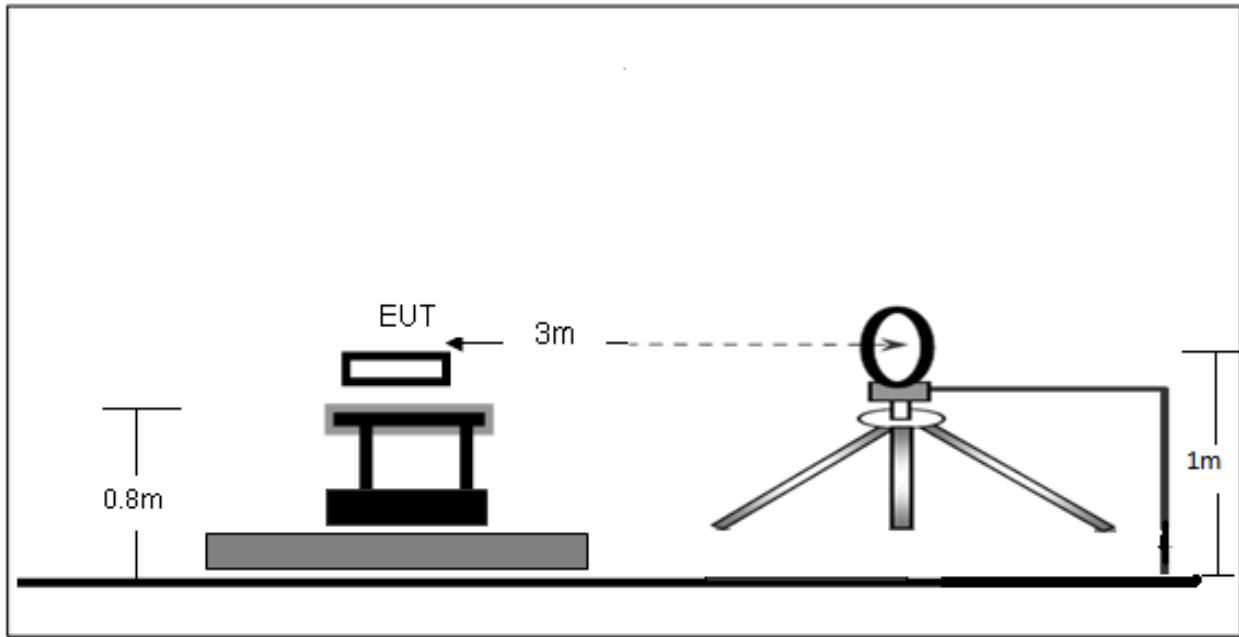

(B) Radiated Emission Test-Up Frequency 30MHz~1GHz

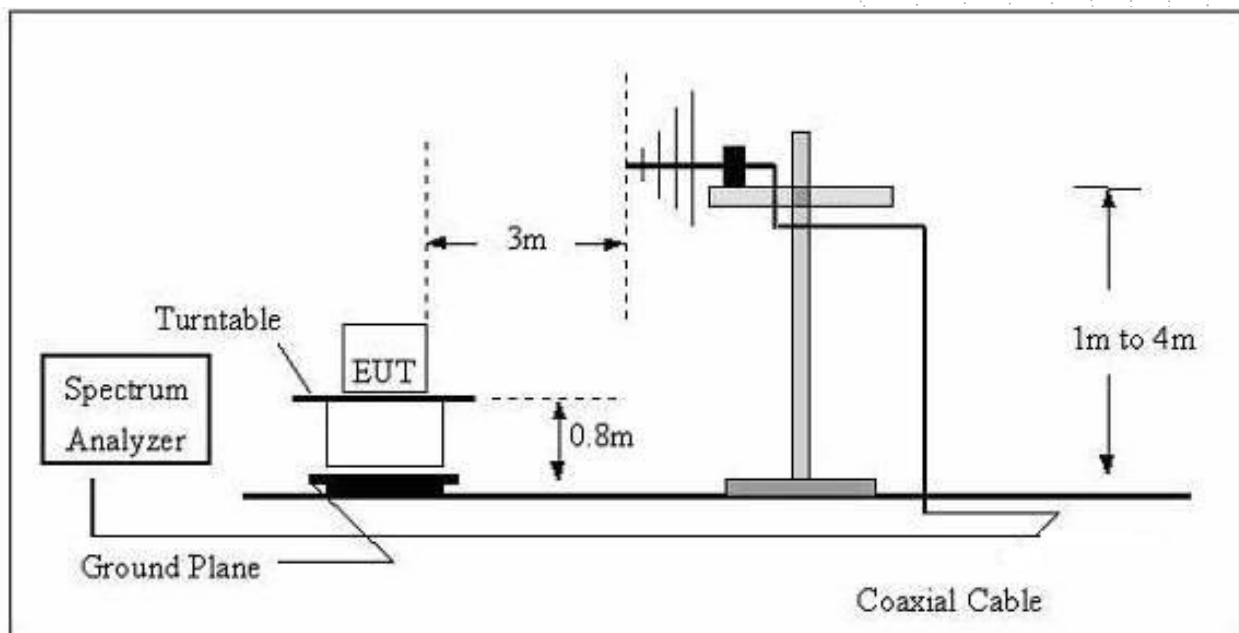

TEC
TC
OVB
检

(C) Radiated Emission Test-Up Frequency Above 1GHz

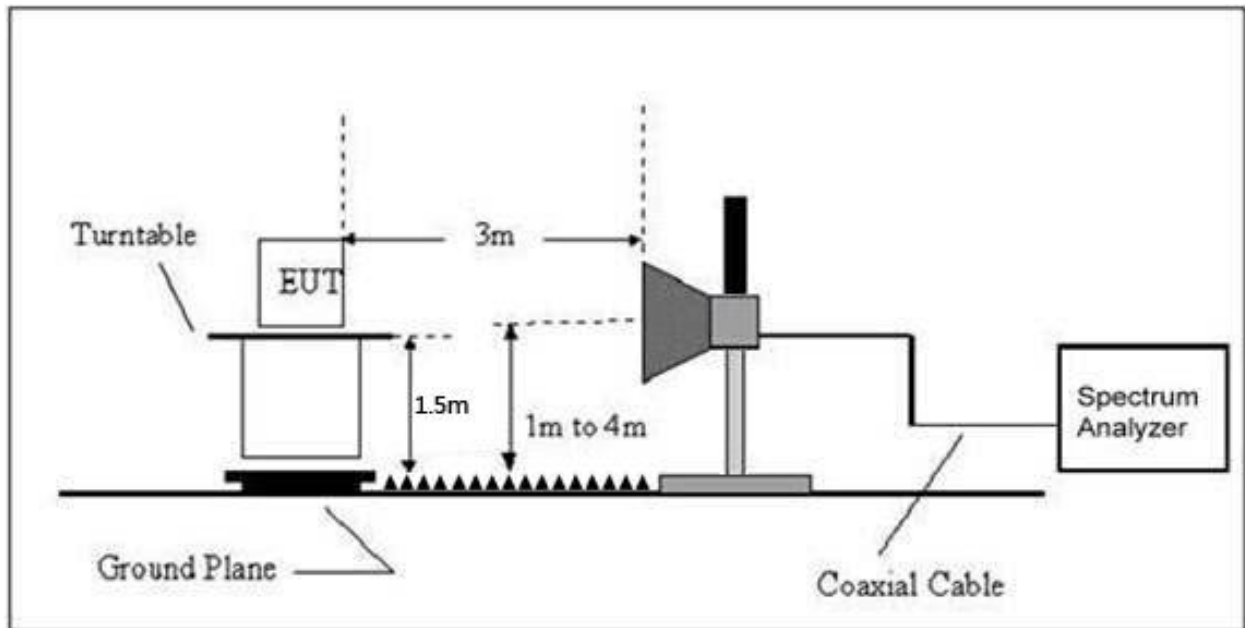

7.2 Limit

20dBc in any 100 kHz bandwidth outside the operating frequency band. In case the emission fall within the restricted band specified on 15.205(a), then the 15.209(a) limit in the table below has to be followed.

Frequency (MHz)	Field Strength uV/m	Distance (m)	Field Strength Limit at 3m Distance	
			uV/m	dBuV/m
0.009 ~ 0.490	2400/F(kHz)	300	10000 * 2400/F(kHz)	$20\log^{(2400/F(kHz))} + 80$
0.490 ~ 1.705	24000/F(kHz)	30	100 * 24000/F(kHz)	$20\log^{(24000/F(kHz))} + 40$
1.705 ~ 30	30	30	100 * 30	$20\log^{(30)} + 40$
30 ~ 88	100	3	100	$20\log^{(100)}$
88 ~ 216	150	3	150	$20\log^{(150)}$
216 ~ 960	200	3	200	$20\log^{(200)}$
Above 960	500	3	500	$20\log^{(500)}$

LIMITS OF RADIATED EMISSION MEASUREMENT (Above 1000MHz)

FREQUENCY (MHz)	Limit (dBuV/m) (at 3M)	
	PEAK	AVERAGE
Above 1000	74	54

Notes:

- (1) The limit for radiated test was performed according to FCC PART 15C.
- (2) The tighter limit applies at the band edges.
- (3) Emission level (dBuV/m) = $20\log$ Emission level (uV/m).

FREQUENCY RANGE OF RADIATED MEASUREMENT (For unintentional radiators)

Highest frequency generated or Upper frequency of measurement used in the device or on which the device operates or tunes (MHz)	Range (MHz)
Below 1.705	30
1.705 – 108	1000
108 – 500	2000
500 – 1000	5000
Above 1000	5 th harmonic of the highest frequency or 40 GHz, whichever is lower

7.3 Test Procedure

Receiver Parameter	Setting
Attenuation	Auto
9kHz~150kHz	RBW 200Hz for QP
150kHz~30MHz	RBW 9kHz for QP
30MHz~1000MHz	RBW 120kHz for QP

Spectrum Parameter	Setting
1-25GHz	RBW 1 MHz /VBW 1 MHz for Peak, RBW 1 MHz / VBW 10Hz for Average

Below 1GHz test procedure as below:

- a. The EUT was placed on the top of a rotating table 0.8 meters above the ground at a 3 meter semi-anechoic chamber. The table was rotated 360 degrees to determine the position of the highest radiation.
- b. The EUT was set 3 meters away from the interference-receiving antenna, which was mounted on the top of a variable-height antenna tower.
- c. The antenna height is varied from one meter to four meters above the ground to determine the maximum value of the field strength. Both horizontal and vertical polarizations of the antenna are set to make the measurement.
- d. For each suspected emission, the EUT was arranged to its worst case and then the antenna was tuned to heights from 1 meter to 4 meters (for the test frequency of below 30MHz, the antenna was tuned to heights 1 meter) and the rotatable table was turned from 0 degrees to 360 degrees to find the maximum reading.
- e. The test-receiver system was set to Peak Detect Function and Specified Bandwidth with Maximum Hold Mode.
- f. If the emission level of the EUT in peak mode was 10dB lower than the limit specified, then testing could be stopped and the peak values of the EUT would be reported. Otherwise the emissions that did not have 10dB margin would be re-tested one by one using peak, quasi-peak or average method as specified and then reported in a data sheet.

Above 1GHz test procedure as below:

- g. Different between above is the test site, change from Semi- Anechoic Chamber to fully Anechoic Chamber and change form table 0.8 metre to 1.5 metre(Above 18GHz the distance is 1 meter and table is 1.5 metre).
- h. Test the EUT in the lowest channel ,the middle channel ,the Highest channel.

Note:

Both horizontal and vertical antenna polarities were tested and performed pretest to three orthogonal axis. The worst case emissions were reported.

Above 1GHz test procedure as below:

- a. The EUT was placed on the top of a rotating table 1.5 meters above the ground at a 3 meter chamber. The table was rotated 360 degrees to determine the position of the highest radiation.
- b. The EUT was set 3 meters away from the interference-receiving antenna, which was mounted on the top of a variable-height antenna tower.
- c. The antenna height is varied from one meter to four meters above the ground to determine the maximum value of the field strength. Both horizontal and vertical polarizations of the antenna are set to make the measurement.
- d. For each suspected emission, the EUT was arranged to its worst case and then the antenna was tuned to heights from 1 meter to 4 meters and the rota table was turned from 0 degrees to 360 degrees to find the maximum reading.
- e. The test-receiver system was set to Peak Detect Function and Specified Bandwidth with Maximum Hold Mode.
- f. If the emission level of the EUT in peak mode was 10dB lower than the limit specified, then testing could be stopped and the peak values of the EUT would be reported. Otherwise the emissions that did not have 10dB margin would be re-tested one by one using peak, quasi-peak or average method as specified and then reported in a data sheet.
- g. Test the EUT in the lowest channel, the Highest channel.

Note:

Both horizontal and vertical antenna polarities were tested and performed pretest to three orthogonal axis. The worst case emissions were reported.

7.4 EUT Operating Conditions

The EUT was configured for testing in a typical fashion (as a customer would normally use it). The EUT has been programmed to continuously transmit during test. This operating condition was tested and used to collect the included data.

7.5 Test Result

Below 30MHz

Temperature:	26°C	Relative Humidity:	24%
Pressure:	101 kPa	Test Voltage :	DC 3.8V
Test Mode :	Mode 5	Polarization :	--

Freq. (MHz)	Reading (dBuV/m)	Limit (dBuV/m)	Margin (dB)	State P/F
--	--	--	--	PASS
--	--	--	--	PASS

Note:

The amplitude of spurious emissions which are attenuated by more than 20dB below the permissible value has no need to be reported.

Distance extrapolation factor = $40 \log(\text{specific distance/test distance})(\text{dB})$;

Limit line = specific limits(dBuv) + distance extrapolation factor.

Between 30MHz – 1GHz

Temperature:	26°C	Relative Humidity:	54%
Pressure:	101 kPa	Test Voltage :	DC 3.8V
Test Mode:	Mode 5	Polarization :	Horizontal

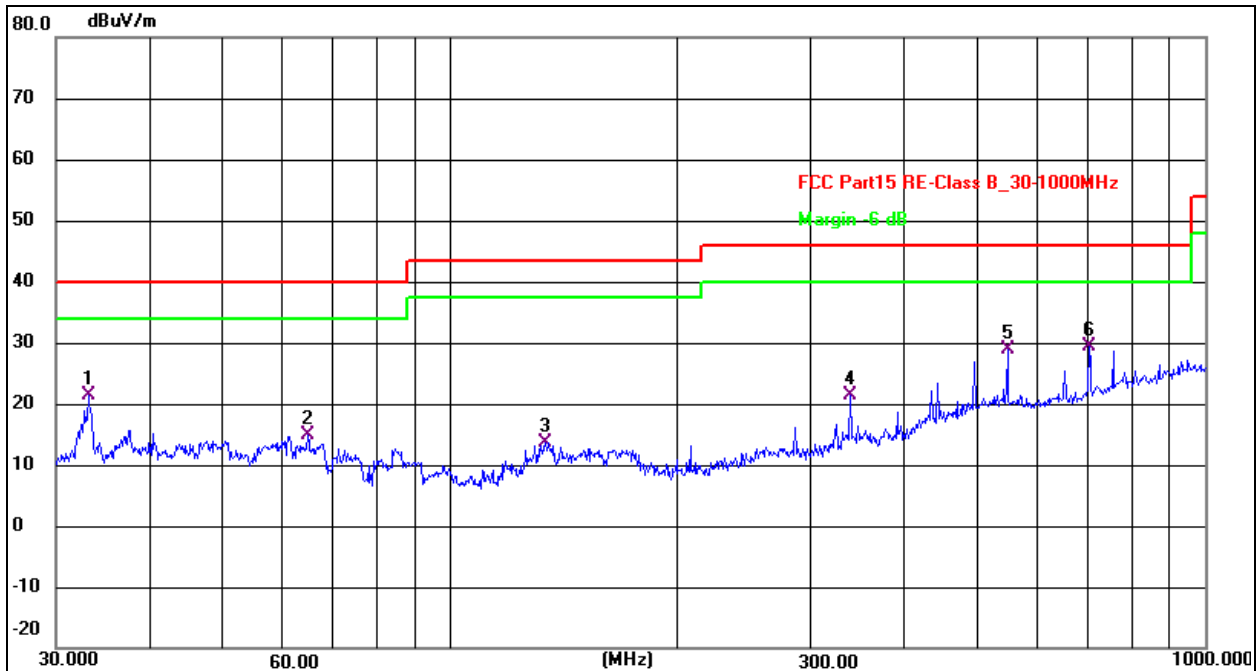
Remark:

1. Factor = Antenna Factor + Cable Loss – Pre-amplifier.
2. Measurement=Reading Level+ Correct Factor
3. Over=Measurement-Limit

No.	Frequency (MHz)	Reading (dBuV)	Factor (dB/m)	Level (dBuV/m)	Limit (dBuV/m)	Margin (dB)	Detector
1	33.0950	36.07	-14.58	21.49	40.00	-18.51	QP
2	64.6594	30.60	-15.71	14.89	40.00	-25.11	QP
3	133.6188	29.42	-15.75	13.67	43.50	-29.83	QP
4	338.4001	33.70	-12.32	21.38	46.00	-24.62	QP
5	547.0977	33.97	-5.16	28.81	46.00	-17.19	QP
6 *	701.7610	32.80	-3.36	29.44	46.00	-16.56	QP

Temperature:	26°C	Relative Humidity:	54%
Pressure:	101 kpa	Test Voltage :	DC 3.8V
Test Mode :	Mode 5	Polarization :	Vertical

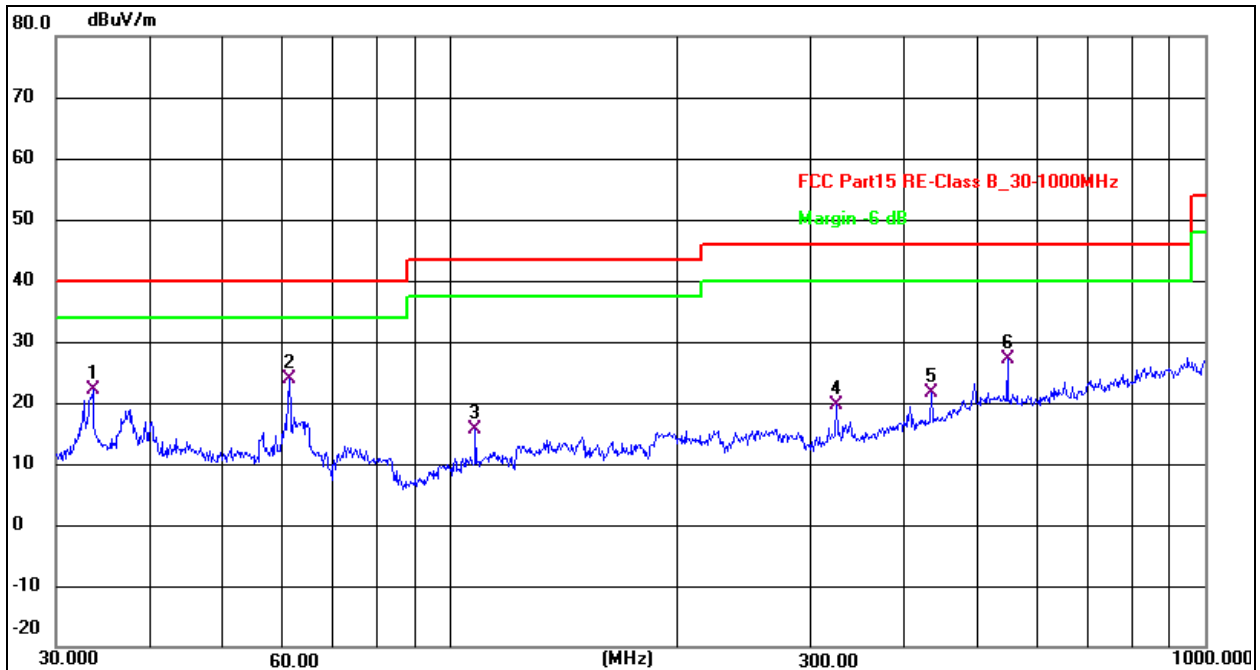
Remark:

1. Factor = Antenna Factor + Cable Loss – Pre-amplifier.
2. Measurement=Reading Level+ Correct Factor
3. Over=Measurement-Limit

No.	Frequency (MHz)	Reading (dBuV)	Factor (dB/m)	Level (dBuV/m)	Limit (dBuV/m)	Margin (dB)	Detector
1	33.5624	36.70	-14.51	22.19	40.00	-17.81	QP
2 *	61.1316	39.23	-15.36	23.87	40.00	-16.13	QP
3	107.8877	33.40	-17.86	15.54	43.50	-27.96	QP
4	324.4561	32.19	-12.56	19.63	46.00	-26.37	QP
5	434.0651	30.87	-9.24	21.63	46.00	-24.37	QP
6	547.0977	32.32	-5.16	27.16	46.00	-18.84	QP

BCTC
 3C
 PPR
 检测

Between 1GHz – 25GHz
802.11b

Polar (H/V)	Frequency	Reading Level	Correct Factor	Measure- ment	Limits	Over	Detector Type
	(MHz)	(dBuV/m)	(dB)	(dBuV/m)	(dBuV/ m)	(dB)	
Low channel:2412MHz							
V	4824.00	52.92	-0.43	52.49	74.00	-21.51	PK
V	4824.00	42.84	-0.43	42.41	54.00	-11.59	AV
V	7236.00	43.35	8.31	51.66	74.00	-22.34	PK
V	7236.00	33.66	8.31	41.97	54.00	-12.03	AV
H	4824.00	51.54	-0.43	51.11	74.00	-22.89	PK
H	4824.00	42.40	-0.43	41.97	54.00	-12.03	AV
H	7236.00	41.74	8.31	50.05	74.00	-23.95	PK
H	7236.00	34.16	8.31	42.47	54.00	-11.53	AV
Middle channel:2437MHz							
V	4874.00	49.14	-0.38	48.76	74.00	-25.24	PK
V	4874.00	40.80	-0.38	40.42	54.00	-13.58	AV
V	7311.00	41.58	8.83	50.41	74.00	-23.59	PK
V	7311.00	32.26	8.83	41.09	54.00	-12.91	AV
H	4874.00	45.86	-0.38	45.48	74.00	-28.52	PK
H	4874.00	36.20	-0.38	35.82	54.00	-18.18	AV
H	7311.00	39.86	8.83	48.69	74.00	-25.31	PK
H	7311.00	31.84	8.83	40.67	54.00	-13.33	AV
High channel:2462MHz							
V	4924.00	51.96	-0.32	51.64	74.00	-22.36	PK
V	4924.00	43.38	-0.32	43.06	54.00	-10.94	AV
V	7386.00	43.29	9.35	52.64	74.00	-21.36	PK
V	7386.00	33.89	9.35	43.24	54.00	-10.76	AV
H	4924.00	50.22	-0.32	49.90	74.00	-24.10	PK
H	4924.00	40.24	-0.32	39.92	54.00	-14.08	AV
H	7386.00	42.22	9.35	51.57	74.00	-22.43	PK
H	7386.00	34.07	9.35	43.42	54.00	-10.58	AV

Remark:

1. Emission Level = Meter Reading + Factor,
Factor = Antenna Factor + Cable Loss – Pre-amplifier.
Over = Emission Level - Limit
2. If peak below the average limit, the average emission was no test.
3. In restricted bands of operation, The spurious emissions below the permissible value more than 20dB
4. The amplitude of spurious emissions which are attenuated by more than 20dB below the permissible value has no need to be reported.
5. All the Modulation are test, the worst mode is 802.11b, the data recording in the report.

 TE
 TC
 OV
 检

802.11g

Polar (H/V)	Frequency	Reading Level	Correct Factor	Measurement	Limits	Over	Detector Type
	(MHz)	(dBuV/m)	(dB)	(dBuV/m)	(dBuV/m)	(dB)	
Low channel:2412MHz							
V	4824.00	53.51	-0.43	53.08	74.00	-20.92	PK
V	4824.00	44.24	-0.43	43.81	54.00	-10.19	AV
V	7236.00	43.51	8.31	51.82	74.00	-22.18	PK
V	7236.00	33.77	8.31	42.08	54.00	-11.92	AV
H	4824.00	48.75	-0.43	48.32	74.00	-25.68	PK
H	4824.00	39.19	-0.43	38.76	54.00	-15.24	AV
H	7236.00	41.14	8.31	49.45	74.00	-24.55	PK
H	7236.00	32.58	8.31	40.89	54.00	-13.11	AV
Middle channel:2437MHz							
V	4874.00	49.72	-0.38	49.34	74.00	-24.66	PK
V	4874.00	43.14	-0.38	42.76	54.00	-11.24	AV
V	7311.00	39.15	8.83	47.98	74.00	-26.02	PK
V	7311.00	29.22	8.83	38.05	54.00	-15.95	AV
H	4874.00	46.72	-0.38	46.34	74.00	-27.66	PK
H	4874.00	36.16	-0.38	35.78	54.00	-18.22	AV
H	7311.00	38.12	8.83	46.95	74.00	-27.05	PK
H	7311.00	29.74	8.83	38.57	54.00	-15.43	AV
High channel:2462MHz							
V	4924.00	52.17	-0.32	51.85	74.00	-22.15	PK
V	4924.00	43.39	-0.32	43.07	54.00	-10.93	AV
V	7386.00	45.40	9.35	54.75	74.00	-19.25	PK
V	7386.00	35.14	9.35	44.49	54.00	-9.51	AV
H	4924.00	49.29	-0.32	48.97	74.00	-25.03	PK
H	4924.00	39.61	-0.32	39.29	54.00	-14.71	AV
H	7386.00	43.95	9.35	53.30	74.00	-20.70	PK
H	7386.00	36.18	9.35	45.53	54.00	-8.47	AV

Remark:

1. Emission Level = Meter Reading + Factor,
Factor = Antenna Factor + Cable Loss – Pre-amplifier.
Over = Emission Level - Limit
2. If peak below the average limit, the average emission was no test.
3. In restricted bands of operation, The spurious emissions below the permissible value more than 20dB
4. The amplitude of spurious emissions which are attenuated by more than 20dB below the permissible value has no need to be reported.
5. All the Modulation are test, the worst mode is 802.11b; the data recording in the report.



802.11n20

Polar (H/V)	Frequency	Reading Level	Correct Factor	Measure- ment	Limits	Over	Detector Type
	(MHz)	(dBuV/m)	(dB)	(dBuV/m)	(dBuV/ m)	(dB)	
Low channel:2412MHz							
V	4824.00	53.80	-0.43	53.37	74.00	-20.63	PK
V	4824.00	44.72	-0.43	44.29	54.00	-9.71	AV
V	7236.00	45.76	8.31	54.07	74.00	-19.93	PK
V	7236.00	35.59	8.31	43.90	54.00	-10.10	AV
H	4824.00	52.54	-0.43	52.11	74.00	-21.89	PK
H	4824.00	42.92	-0.43	42.49	54.00	-11.51	AV
H	7236.00	42.77	8.31	51.08	74.00	-22.92	PK
H	7236.00	34.25	8.31	42.56	54.00	-11.44	AV
Middle channel:2437MHz							
V	4874.00	50.32	-0.38	49.94	74.00	-24.06	PK
V	4874.00	42.31	-0.38	41.93	54.00	-12.07	AV
V	7311.00	42.66	8.83	51.49	74.00	-22.51	PK
V	7311.00	34.62	8.83	43.45	54.00	-10.55	AV
H	4874.00	45.62	-0.38	45.24	74.00	-28.76	PK
H	4874.00	35.60	-0.38	35.22	54.00	-18.78	AV
H	7311.00	40.71	8.83	49.54	74.00	-24.46	PK
H	7311.00	32.69	8.83	41.52	54.00	-12.48	AV
High channel:2462MHz							
V	4924.00	52.25	-0.32	51.93	74.00	-22.07	PK
V	4924.00	42.48	-0.32	42.16	54.00	-11.84	AV
V	7386.00	45.90	9.35	55.25	74.00	-18.75	PK
V	7386.00	35.08	9.35	44.43	54.00	-9.57	AV
H	4924.00	50.47	-0.32	50.15	74.00	-23.85	PK
H	4924.00	40.83	-0.32	40.51	54.00	-13.49	AV
H	7386.00	43.34	9.35	52.69	74.00	-21.31	PK
H	7386.00	34.83	9.35	44.18	54.00	-9.82	AV

Remark:

1. Emission Level = Meter Reading + Factor,
Factor = Antenna Factor + Cable Loss – Pre-amplifier.
Over = Emission Level - Limit
2. If peak below the average limit, the average emission was no test.
3. In restricted bands of operation, The spurious emissions below the permissible value more than 20dB
4. The amplitude of spurious emissions which are attenuated by more than 20dB below the permissible value has no need to be reported.
5. All the Modulation are test, the worst mode is 802.11b; the data recording in the report.

802.11n40

Polar (H/V)	Frequency	Reading Level	Correct Factor	Measure- ment	Limits	Over	Detector Type
	(MHz)	(dBuV/m)	(dB)	(dBuV/m)	(dBuV/ m)	(dB)	
Low channel:2422MHz							
V	4844.00	54.77	-0.43	54.34	74.00	-19.66	PK
V	4844.00	45.81	-0.43	45.38	54.00	-8.62	AV
V	7266.00	45.41	8.31	53.72	74.00	-20.28	PK
V	7266.00	35.04	8.31	43.35	54.00	-10.65	AV
H	4844.00	50.85	-0.43	50.42	74.00	-23.58	PK
H	4844.00	40.84	-0.43	40.41	54.00	-13.59	AV
H	7266.00	43.70	8.31	52.01	74.00	-21.99	PK
H	7266.00	36.37	8.31	44.68	54.00	-9.32	AV
Middle channel:2437MHz							
V	4874.00	53.41	-0.38	53.03	74.00	-20.97	PK
V	4874.00	46.34	-0.38	45.96	54.00	-8.04	AV
V	7311.00	45.81	8.83	54.64	74.00	-19.36	PK
V	7311.00	36.56	8.83	45.39	54.00	-8.61	AV
H	4874.00	49.45	-0.38	49.07	74.00	-24.93	PK
H	4874.00	40.28	-0.38	39.90	54.00	-14.10	AV
H	7311.00	43.12	8.83	51.95	74.00	-22.05	PK
H	7311.00	35.86	8.83	44.69	54.00	-9.31	AV
High channel:2452MHz							
V	4904.00	55.44	-0.32	55.12	74.00	-18.88	PK
V	4904.00	45.20	-0.32	44.88	54.00	-9.12	AV
V	7356.00	49.10	9.35	58.45	74.00	-15.55	PK
V	7356.00	38.22	9.35	47.57	54.00	-6.43	AV
H	4904.00	52.77	-0.32	52.45	74.00	-21.55	PK
H	4904.00	42.14	-0.32	41.82	54.00	-12.18	AV
H	7356.00	47.56	9.35	56.91	74.00	-17.09	PK
H	7356.00	38.72	9.35	48.07	54.00	-5.93	AV

Remark:

1. Emission Level = Meter Reading + Factor,
Factor = Antenna Factor + Cable Loss – Pre-amplifier.
Over = Emission Level - Limit
2. If peak below the average limit, the average emission was no test.
3. In restricted bands of operation, The spurious emissions below the permissible value more than 20dB
4. The amplitude of spurious emissions which are attenuated by more than 20dB below the permissible value has no need to be reported.
5. All the Modulation are test, the worst mode is 802.11b; the data recording in the report.

SHENZHEN

8. Radiated Band Emission Measurement And Restricted Bands Of Operation

8.1 Block Diagram Of Test Setup

Radiated Emission Test-Up Frequency Above 1GHz

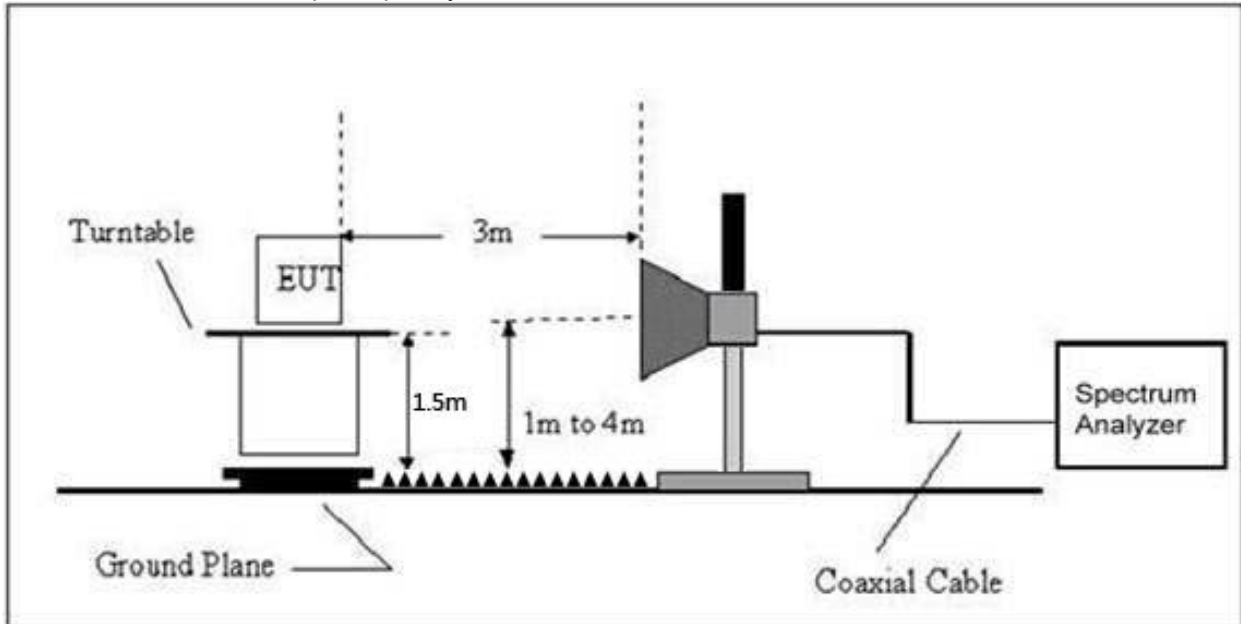

8.2 Limit

FCC Part15 C Section 15.209 and 15.205

(a) Except as shown in paragraph (d) of this section, only spurious emissions are permitted in any of the frequency bands listed below:

MHz	MHz	MHz	GHz
0.090-0.110	16.42-16.423	399.9-410	4.5-5.15
0.495-0.505	16.69475-16.69525	608-614	5.35-5.46
2.1735-2.1905	16.80425-16.80475	960-1240	7.25-7.75
4.125-4.128	25.5-25.67	1300-1427	8.025-8.5
4.17725-4.17775	37.5-38.25	1435-1626.5	9.0-9.2
4.20725-4.20775	73-74.6	1645.5-1646.5	9.3-9.5
6.215-6.218	74.8-75.2	1660-1710	10.6-12.7
6.26775-6.26825	108-121.94	1718.8-1722.2	13.25-13.4
6.31175-6.31225	123-138	2200-2300	14.47-14.5
8.291-8.294	149.9-150.05	2310-2390	15.35-16.2
8.362-8.366	156.52475-156.52525	2483.5-2500	17.7-21.4
8.37625-8.38675	156.7-156.9	2690-2900	22.01-23.12
8.41425-8.41475	162.0125-167.17	3260-3267	23.6-24.0
12.29-12.293	167.72-173.2	3332-3339	31.2-31.8
12.51975-12.52025	240-285	3345.8-3358	36.43-36.5
12.57675-12.57725	322-335.4	3600-4400	(²)
13.36-13.41			

LIMITS OF RADIATED EMISSION MEASUREMENT (Above 1000MHz)

FREQUENCY (MHz)	Limit (dBuV/m) (at 3M)	
	PEAK	AVERAGE
Above 1000	74	54

Notes:

- (1)The limit for radiated test was performed according to FCC PART 15C.
- (2)The tighter limit applies at the band edges.
- (3)Emission level (dBuV/m)=20log Emission level (uV/m).

8.3 Test Procedure

Receiver Parameter	Setting
Attenuation	Auto
Start Frequency	2300MHz
Stop Frequency	2520
RB / VB (emission in restricted band)	1 MHz / 1 MHz for Peak, 1 MHz / 10Hz for Average

Above 1GHz test procedure as below:

- a. The EUT was placed on the top of a rotating table 1.5 meters above the ground at a 3 meter chamber. The table was rotated 360 degrees to determine the position of the highest radiation.
- b. The EUT was set 3 meters away from the interference-receiving antenna, which was mounted on the top of a variable-height antenna tower.
- c. The antenna height is varied from one meter to four meters above the ground to determine the maximum value of the field strength. Both horizontal and vertical polarizations of the antenna are set to make the measurement.
- d. For each suspected emission, the EUT was arranged to its worst case and then the antenna was tuned to heights from 1 meter to 4 meters and the rota table was turned from 0 degrees to 360 degrees to find the maximum reading.
- e. The test-receiver system was set to Peak Detect Function and Specified Bandwidth with Maximum Hold Mode.
- f. If the emission level of the EUT in peak mode was 10dB lower than the limit specified, then testing could be stopped and the peak values of the EUT would be reported. Otherwise the emissions that did not have 10dB margin would be re-tested one by one using peak, quasi-peak or average method as specified and then reported in a data sheet.
- g. Test the EUT in the lowest channel, the Highest channel.

Note:

Both horizontal and vertical antenna polarities were tested and performed pretest to three orthogonal axis. The worst case emissions were reported.

8.4 EUT operating Conditions

The EUT was configured for testing in a typical fashion (as a customer would normally use it). The EUT has been programmed to continuously transmit during test. This operating condition was tested and used to collect the included data.

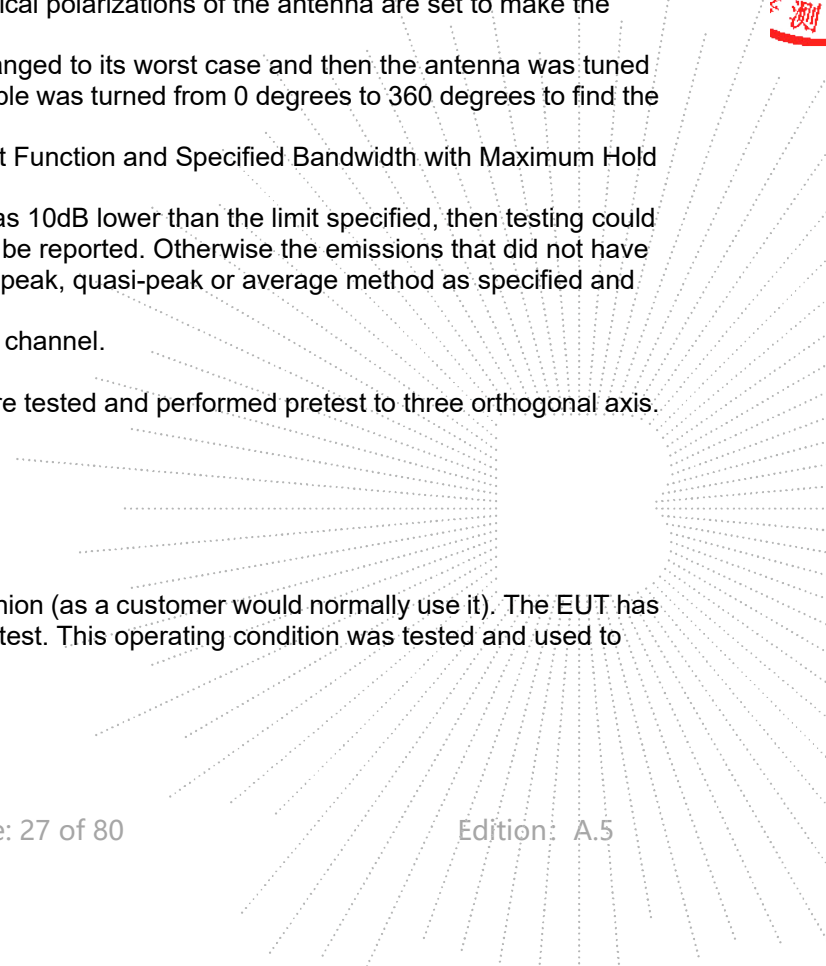

8.5 Test Result

	Polar (H/V)	Frequency (MHz)	Reading Level (dBuV/m)	Correct Factor (dB)	Measurement (dBuV/m)	Limits (dBuV/m)		Result	
					PK	□PK	AV		
802.11b	Low Channel 2412MHz								
	H	2390.00	54.96	-6.70	48.26	74.00	54.00	PASS	
	H	2400.00	58.56	-6.71	51.85	74.00	54.00	PASS	
	V	2390.00	55.22	-6.70	48.52	74.00	54.00	PASS	
	V	2400.00	58.41	-6.71	51.70	74.00	54.00	PASS	
	High Channel 2462MHz								
	H	2483.50	59.38	-6.79	52.59	74.00	54.00	PASS	
	H	2500.00	53.13	-6.81	46.32	74.00	54.00	PASS	
	V	2483.50	58.25	-6.79	51.46	74.00	54.00	PASS	
	V	2500.00	55.00	-6.81	48.19	74.00	54.00	PASS	
	802.11g	Low Channel 2412MHz							
		H	2390.00	53.74	-6.70	47.04	74.00	54.00	PASS
H		2400.00	58.21	-6.71	51.50	74.00	54.00	PASS	
V		2390.00	53.37	-6.70	46.67	74.00	54.00	PASS	
V		2400.00	57.01	-6.71	50.30	74.00	54.00	PASS	
High Channel 2462MHz									
H		2483.50	57.85	-6.79	51.06	74.00	54.00	PASS	
H		2500.00	51.75	-6.81	44.94	74.00	54.00	PASS	
V		2483.50	55.47	-6.79	48.68	74.00	54.00	PASS	
V		2500.00	50.54	-6.81	43.73	74.00	54.00	PASS	

Remark:

- Emission Level = Meter Reading + Factor,
Factor = Antenna Factor + Cable Loss – Pre-amplifier.
Over= Emission Level – Limit
- If the PK measured levels comply with average limit, then the average level were deemed to comply with average limit.
- In restricted bands of operation, The spurious emissions below the permissible value more than 20dB
- The amplitude of spurious emissions which are attenuated by more than 20dB below the permissible value has no need to be reported.

 TEST
 TO
 OVER
 检

	Polar (H/V)	Frequency (MHz)	Reading Level (dBuV/m)	Correct Factor (dB)	Measurement (dBuV/m)	Limits (dBuV/m)		Result
					PK	□PK	AV	
802.11 n20	Low Channel 2412MHz							
	H	2390.00	54.00	-6.70	47.30	74.00	54.00	PASS
	H	2400.00	58.11	-6.71	51.40	74.00	54.00	PASS
	V	2390.00	53.12	-6.70	46.42	74.00	54.00	PASS
	V	2400.00	57.36	-6.71	50.65	74.00	54.00	PASS
	High Channel 2462MHz							
	H	2483.50	57.68	-6.79	50.89	74.00	54.00	PASS
	H	2500.00	52.94	-6.81	46.13	74.00	54.00	PASS
	V	2483.50	57.48	-6.79	50.69	74.00	54.00	PASS
	V	2500.00	52.55	-6.81	45.74	74.00	54.00	PASS
802.11 n40	Low Channel 2422MHz							
	H	2390.00	53.14	-6.70	46.44	74.00	54.00	PASS
	H	2400.00	57.16	-6.71	50.45	74.00	54.00	PASS
	V	2390.00	52.80	-6.70	46.10	74.00	54.00	PASS
	V	2400.00	57.66	-6.71	50.95	74.00	54.00	PASS
	High Channel 2452MHz							
	H	2483.50	56.12	-6.79	49.33	74.00	54.00	PASS
	H	2500.00	52.56	-6.81	45.75	74.00	54.00	PASS
	V	2483.50	55.77	-6.79	48.98	74.00	54.00	PASS
	V	2500.00	50.94	-6.81	44.13	74.00	54.00	PASS

Remark:

- Emission Level = Meter Reading + Factor,
Factor = Antenna Factor + Cable Loss – Pre-amplifier.
Over= Emission Level – Limit
- If the PK measured levels comply with average limit, then the average level were deemed to comply with average limit.
- In restricted bands of operation, The spurious emissions below the permissible value more than 20dB
- The amplitude of spurious emissions which are attenuated by more than 20dB below the permissible value has no need to be reported.



9. Power Spectral Density Test

9.1 Block Diagram Of Test Setup



9.2 Limit

FCC Part15 (15.247) , Subpart C				
Section	Test Item	Limit	Frequency Range (MHz)	Result
15.247	Power Spectral Density	8 dBm (in any 3KHz)	2400-2483.5	PASS

LIMITS OF RADIATED EMISSION MEASUREMENT (Above 1000MHz)

9.3 Test Procedure

1. Set analyzer center frequency to DTS channel center frequency.
2. Set the span to 1.5 times the DTS bandwidth.
3. Set the RBW to: 3 kHz
4. Set the VBW $\geq 3 \times$ RBW.
5. Detector = peak.
6. Sweep time = auto couple.
7. Trace mode = max hold.
8. Allow trace to fully stabilize.
9. Use the peak marker function to determine the maximum amplitude level within the RBW.
10. If measured value exceeds limit, reduce RBW (no less than 3 kHz) and repeat.

9.4 EUT Operating Conditions

The EUT tested system was configured as the statements of 4.6 Unless otherwise a special operating condition is specified in the follows during the testing.

Note: Power Spectral Density(dBm)=Reading+Cable Loss

9.5 Test Result

Temperature :	26°C	Relative Humidity :	54%
Pressure :	101kPa	Test Voltage :	DC 3.8V

Test Mode	Frequency	Power Spectral Density (dBm/10kHz)	Power Spectral Density (dBm/3kHz)	Limit (dBm/3kHz)	Result
b	2412 MHz	-9.45	-14.68	8	PASS
	2437 MHz	-8.86	-14.09	8	PASS
	2462 MHz	-10.34	-15.57	8	PASS
g	2412 MHz	-12.43	-17.66	8	PASS
	2437 MHz	-11.37	-16.60	8	PASS
	2462 MHz	-12.24	-17.47	8	PASS
N20	2412 MHz	-10.25	-15.48	8	PASS
	2437 MHz	-11.3	-16.53	8	PASS
	2462 MHz	-12.55	-17.78	8	PASS
N40	2422 MHz	-16.88	-22.11	8	PASS
	2437 MHz	-14.91	-20.14	8	PASS
	2452 MHz	-12.51	-17.74	8	PASS

Note: Correction Factor = $10\log(3\text{KHz}/\text{RBW in measurement}) = -5.23$

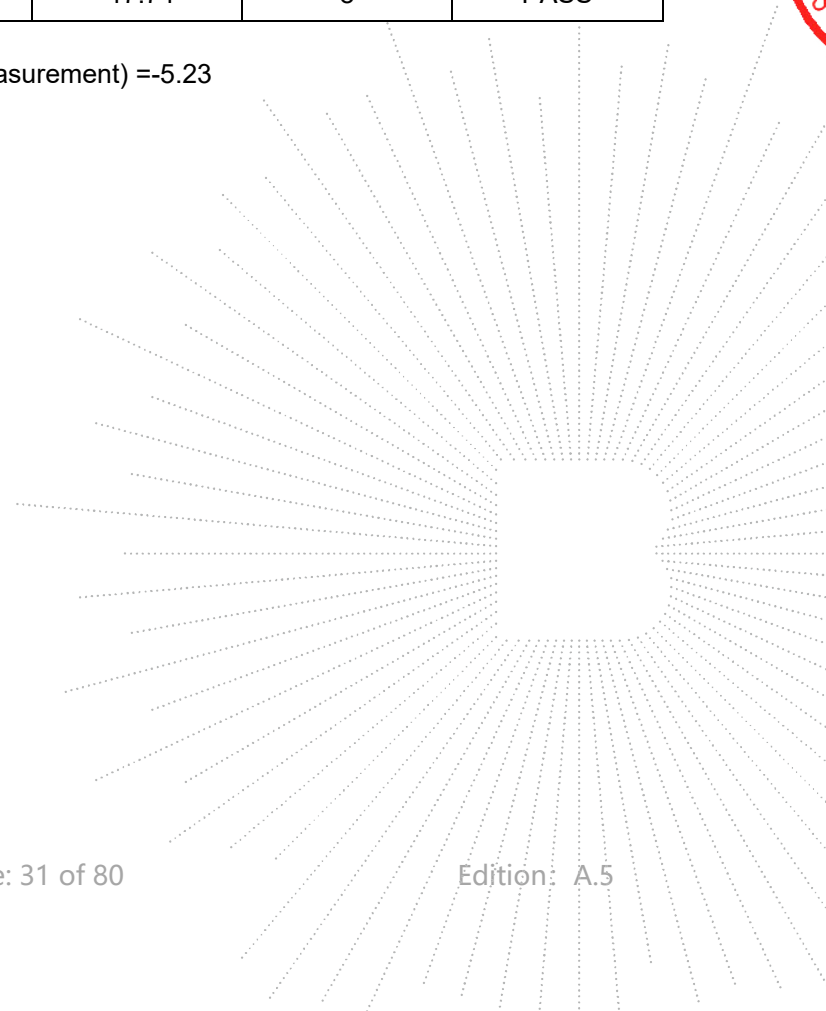

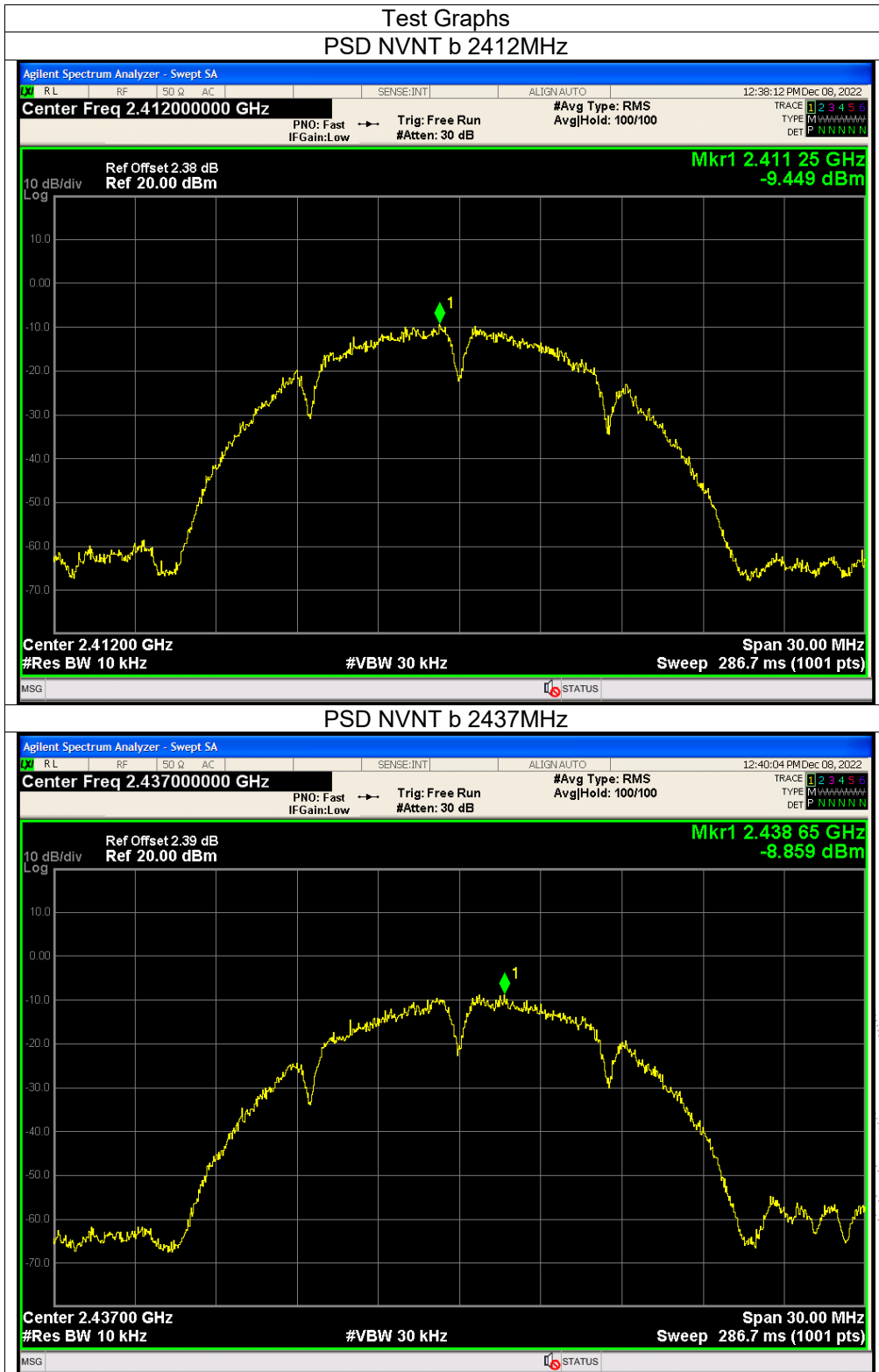

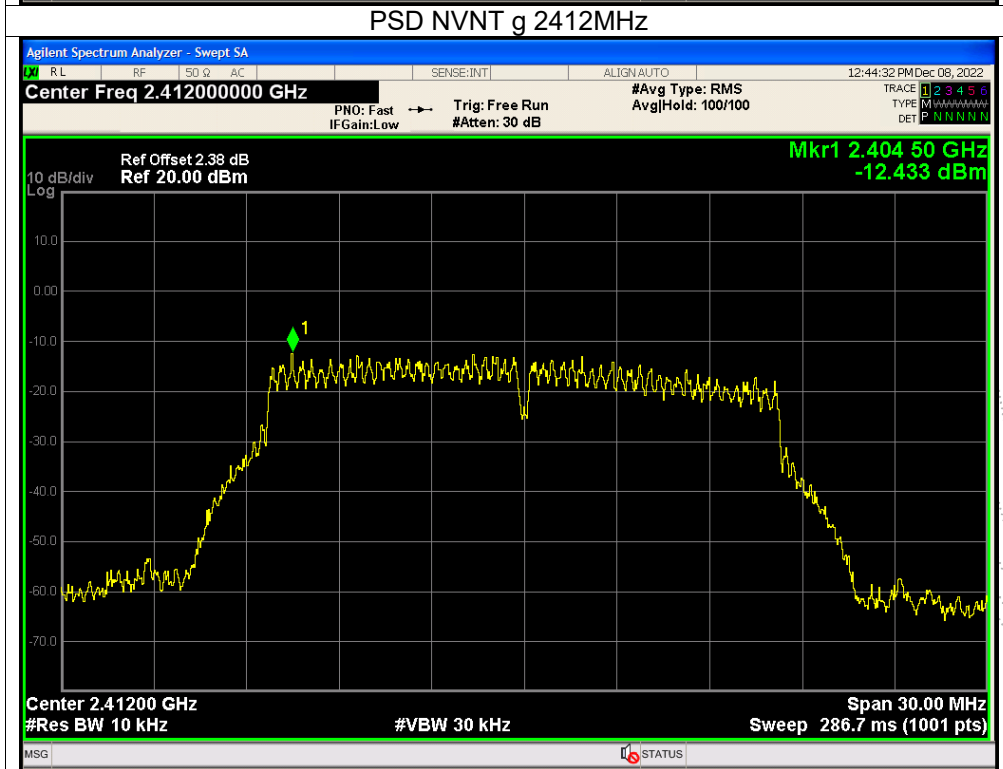
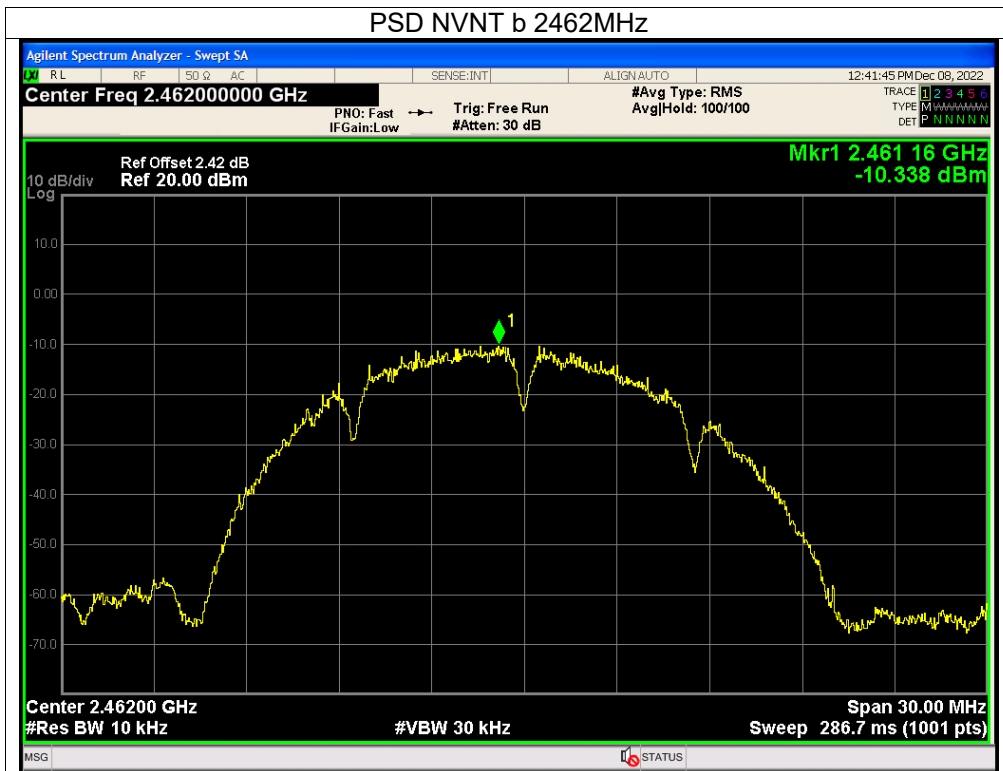

TC
3C
PPR
測

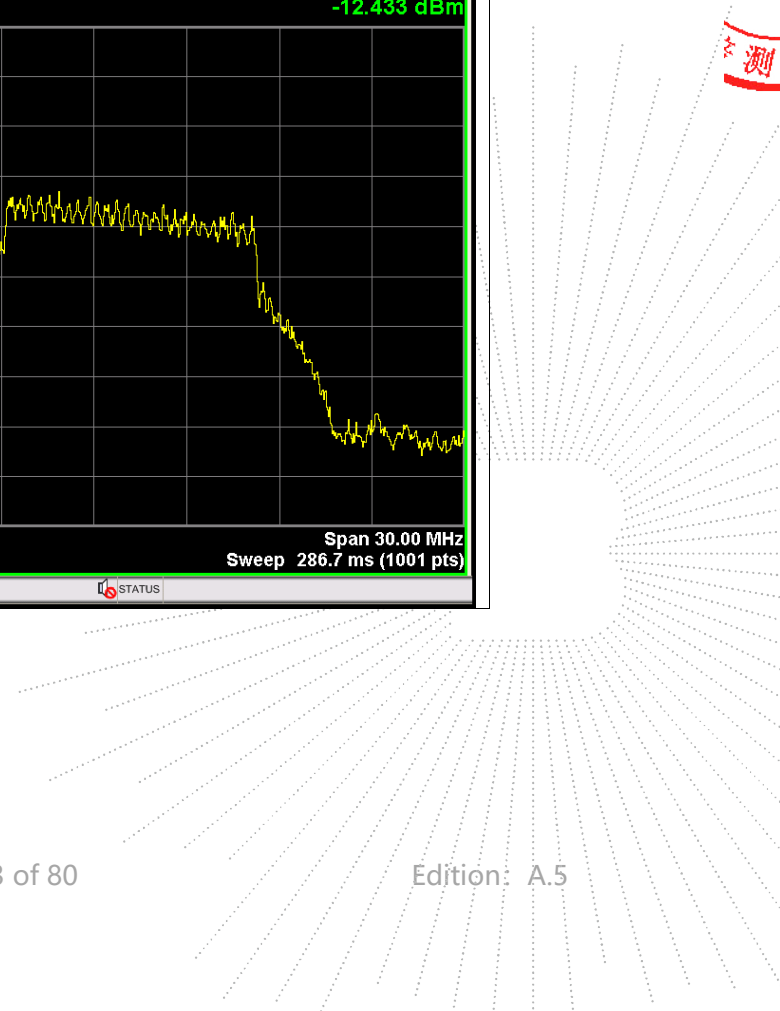

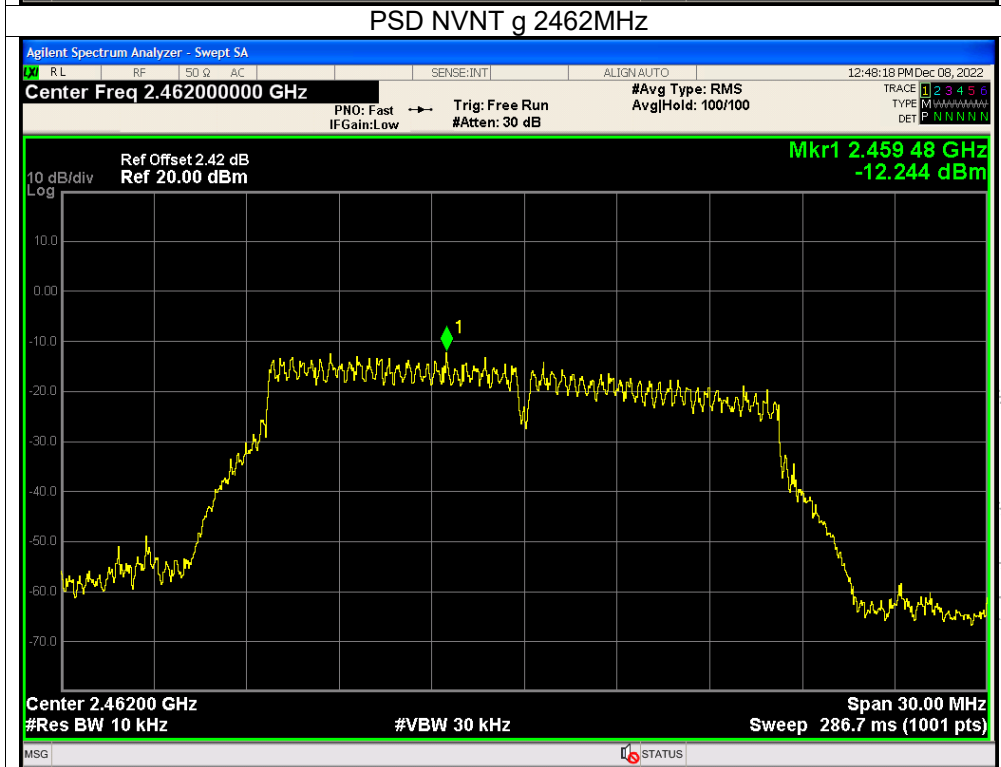
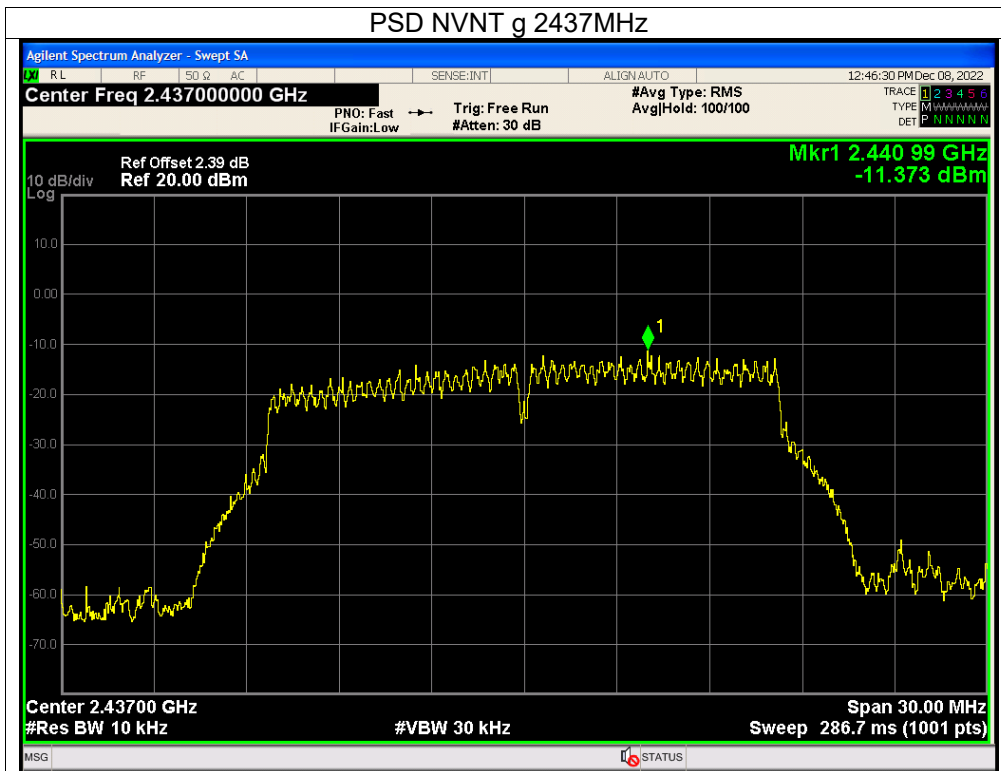

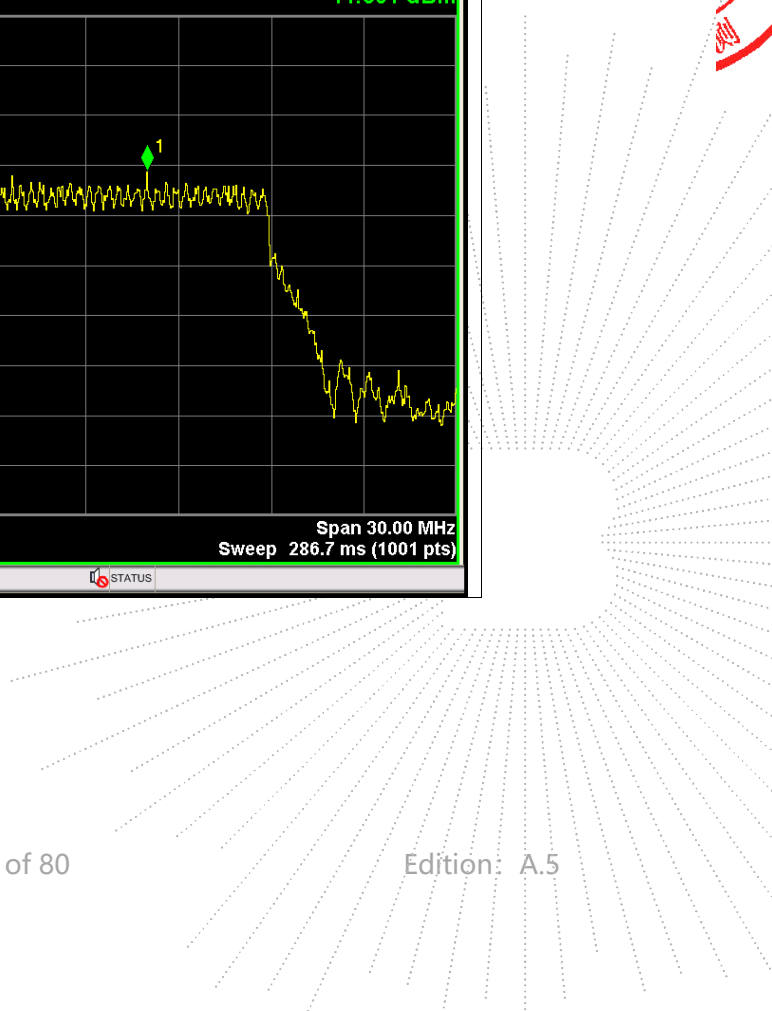
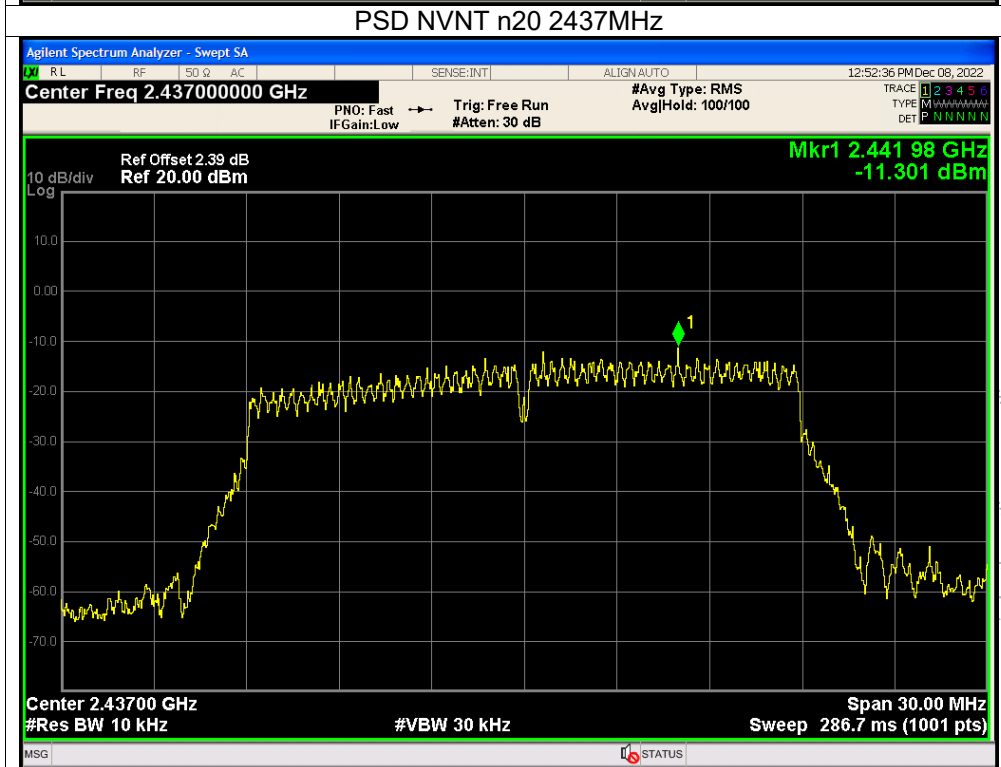
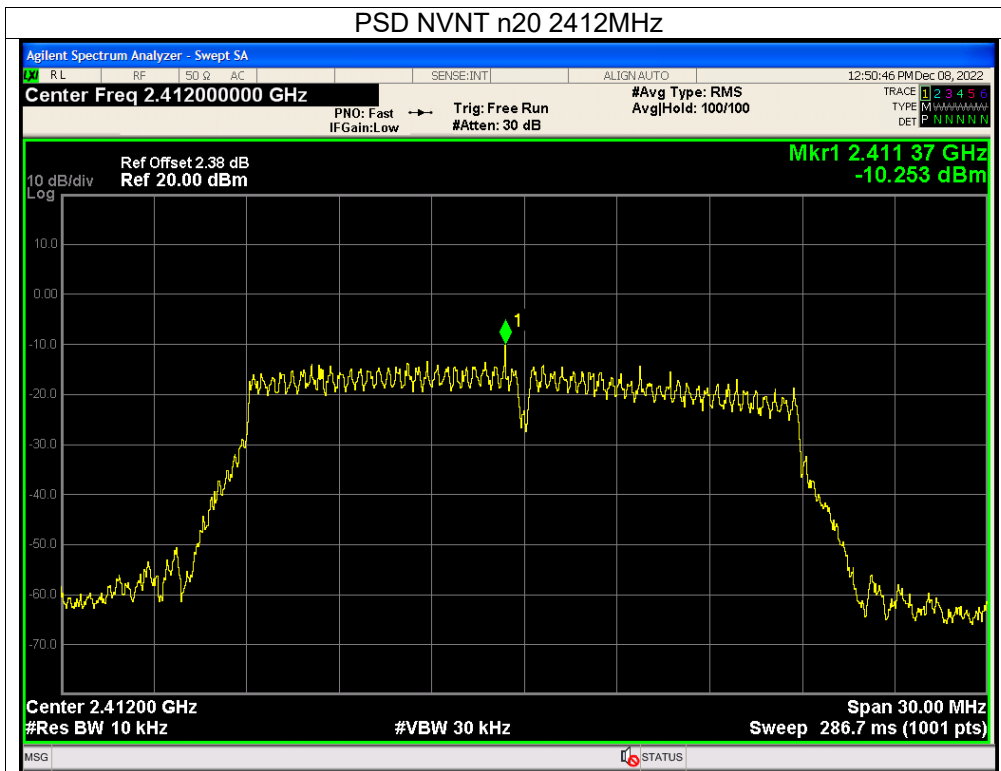

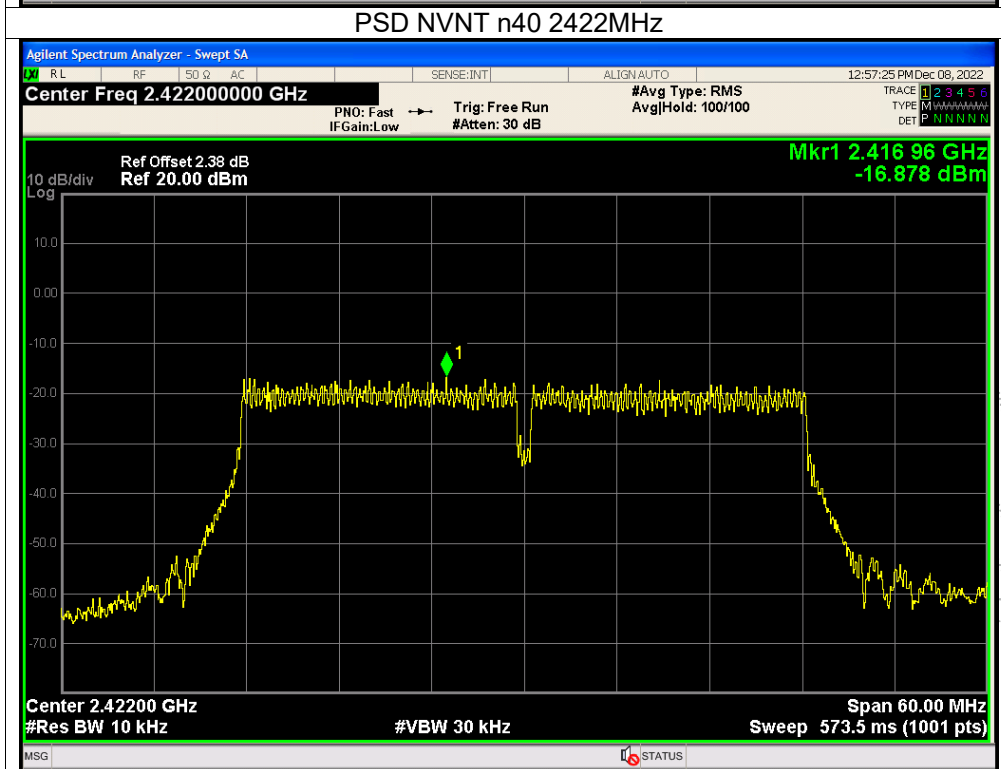
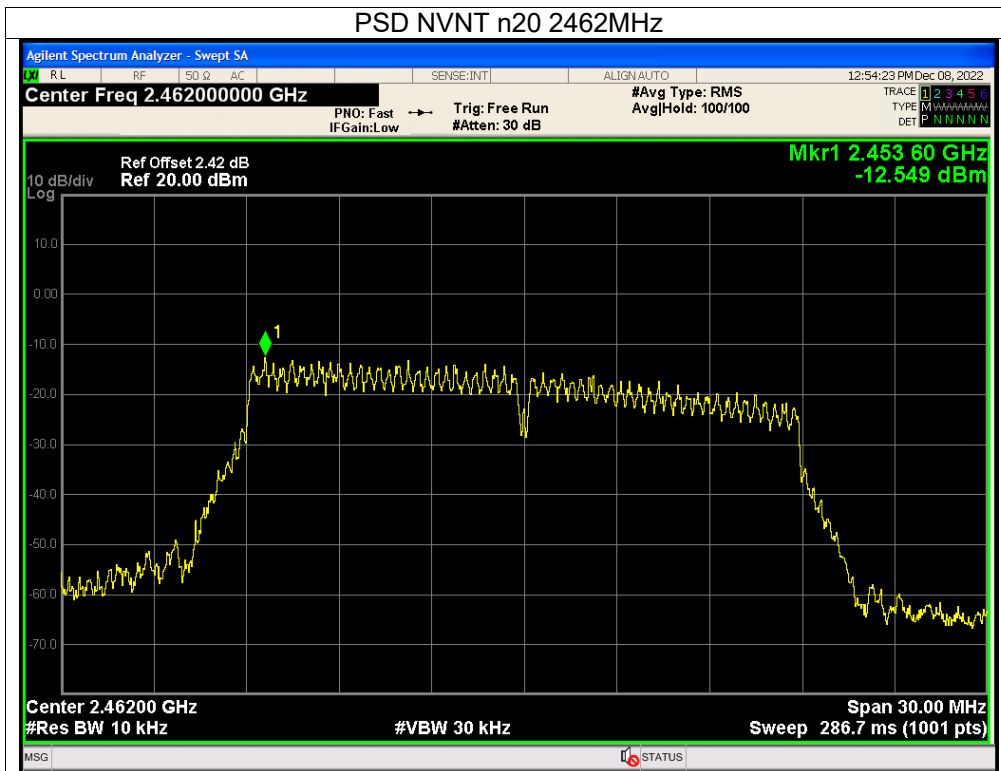

CO. LTD.

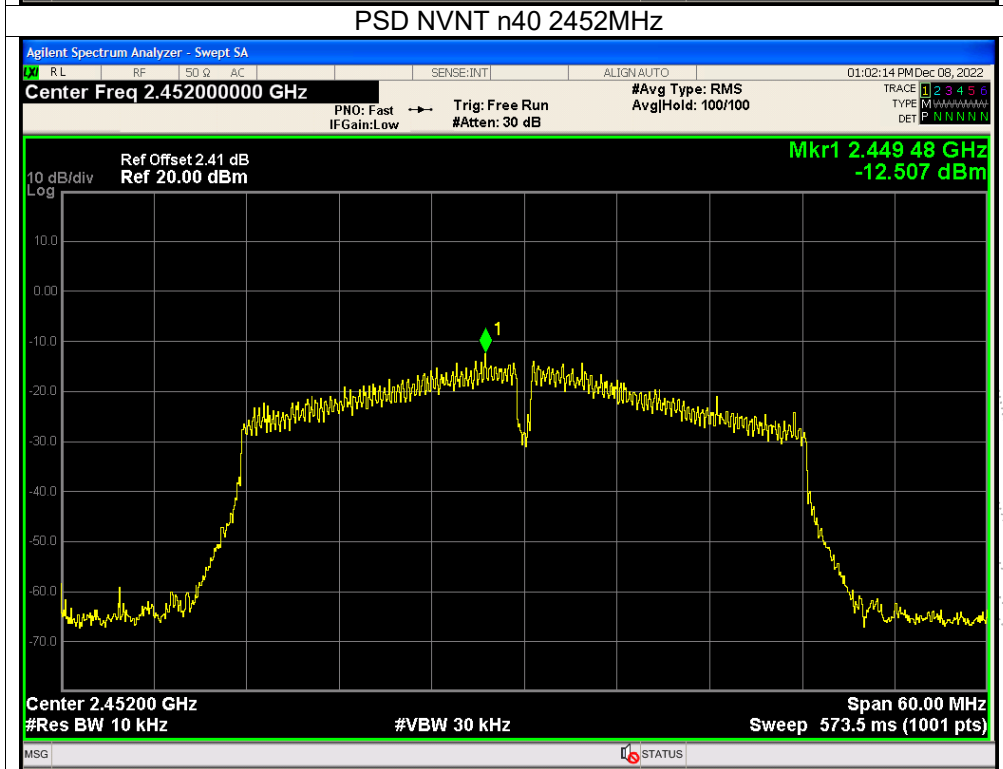
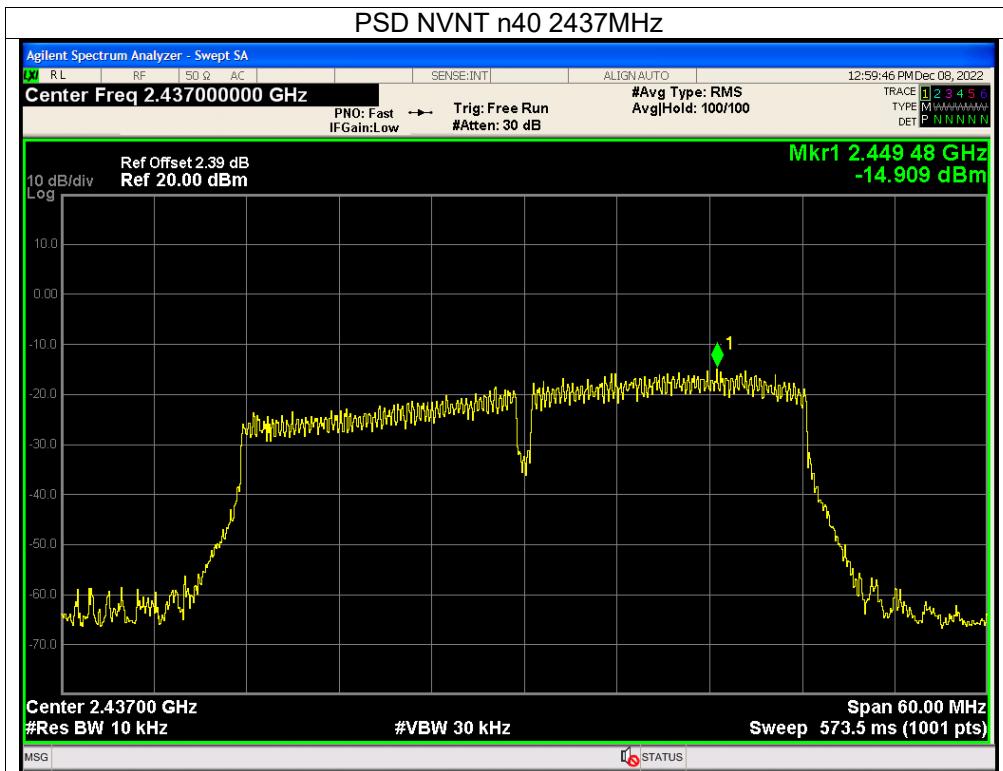

CHENZHEN

10. Bandwidth Test

10.1 Block Diagram Of Test Setup



10.2 Limit

FCC Part15 (15.247) , Subpart C				
Section	Test Item	Limit	Frequency Range (MHz)	Result
15.247(a)(2)	Bandwidth	$\geq 500\text{KHz}$ (6dB bandwidth)	2400-2483.5	PASS

10.3 Test Procedure

1. Set RBW = 100 kHz.
2. Set the video bandwidth (VBW) $\geq 3 \times$ RBW.
3. Detector = Peak.
4. Trace mode = max hold.
5. Sweep = auto couple.
6. Allow the trace to stabilize.
7. Measure the maximum width of the emission that is constrained by the frequencies associated with the two outermost amplitude points (upper and lower frequencies) that are attenuated by 6 dB relative to the maximum level measured in the fundamental emission.

10.4 EUT Operating Conditions

The EUT tested system was configured as the statements of 4.6 Unless otherwise a special operating condition is specified in the follows during the testing.

Note: Power Spectral Density(dBm)=Reading+Cable Loss

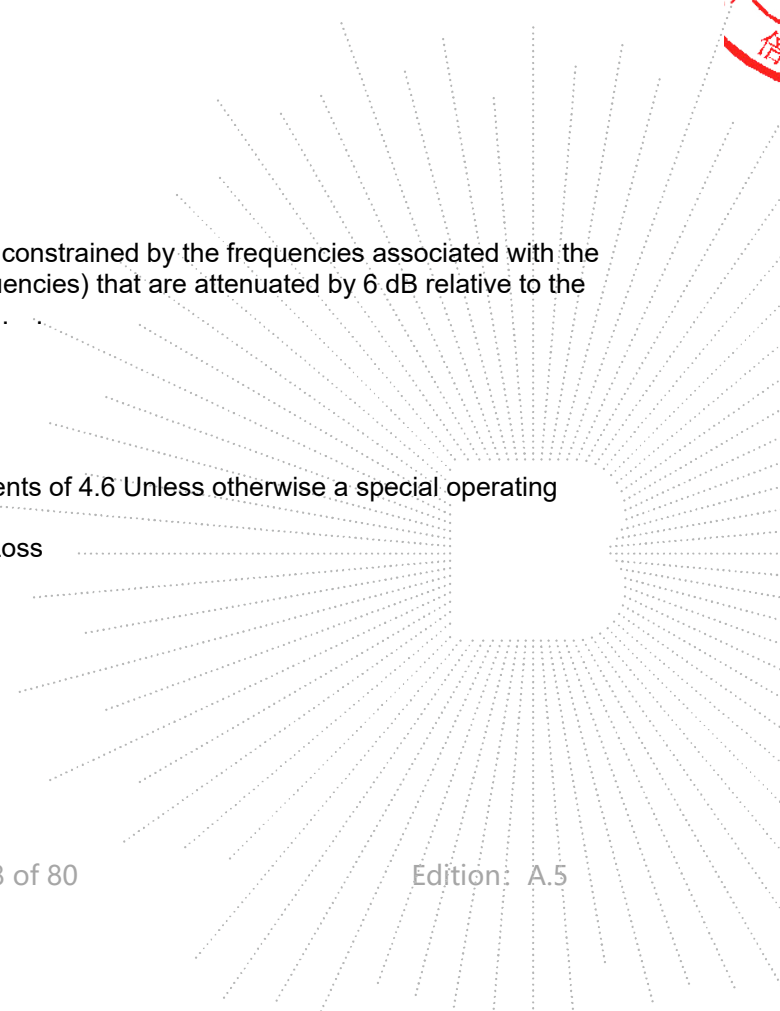

10.5 Test Result

Temperature :	26°C	Relative Humidity :	54%
Pressure :	101kPa	Test Voltage :	DC 3.8V
:	TX b Mode		

Test Mode	Frequency (MHz)	6dB bandwidth (MHz)	Limit (kHz)	Result
b	2412	8.082	500	Pass
	2437	7.559	500	Pass
	2462	8.526	500	Pass
g	2412	15.723	500	Pass
	2437	15.714	500	Pass
	2462	13.288	500	Pass
N 20	2412	16.32	500	Pass
	2437	16.293	500	Pass
	2462	16.363	500	Pass
N40	2422	36.332	500	Pass
	2437	22.611	500	Pass
	2452	16.33	500	Pass

BCTC
 BCTC
 PPR
 检测

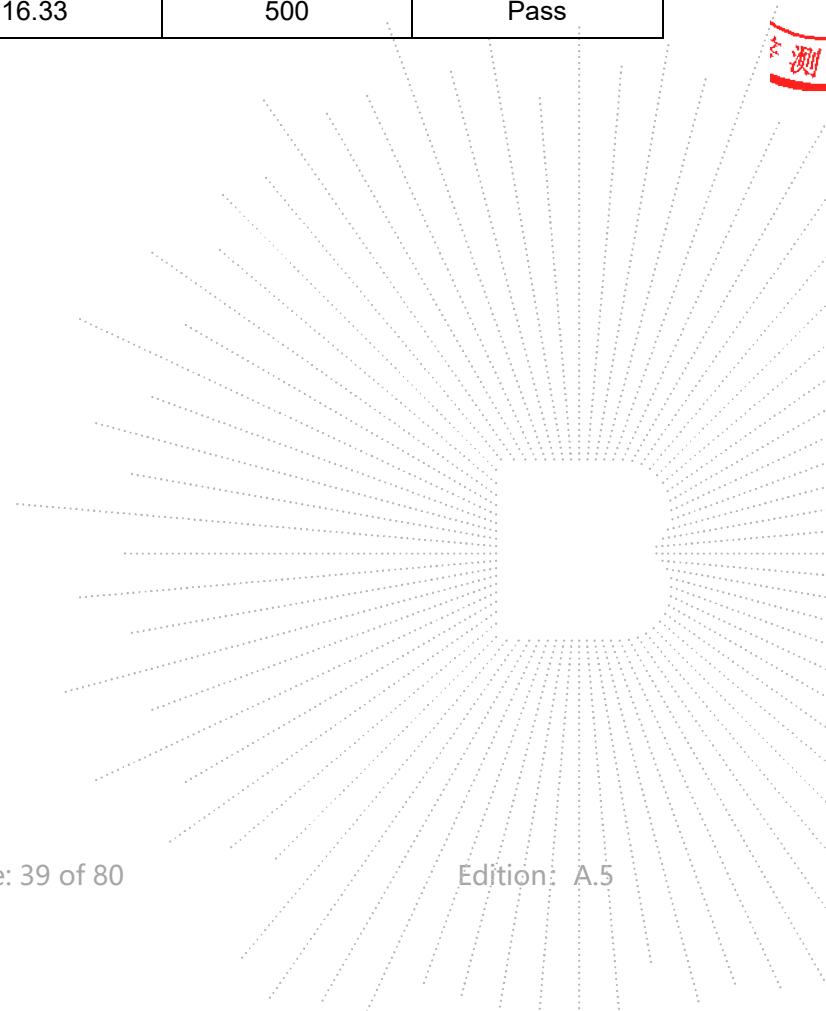

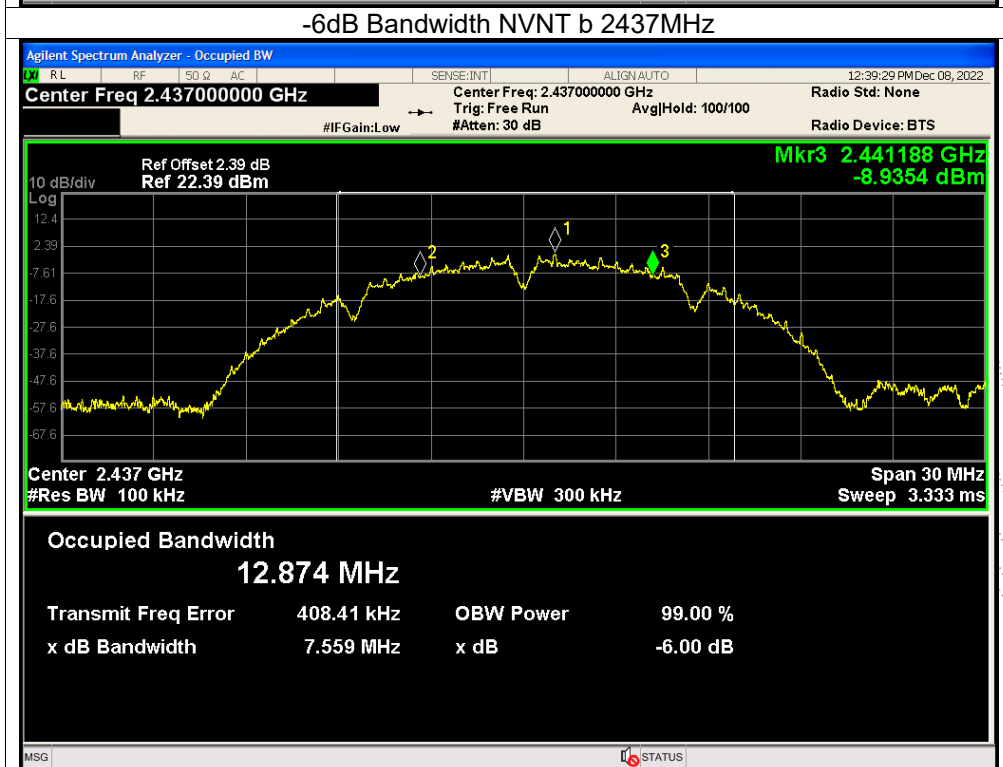
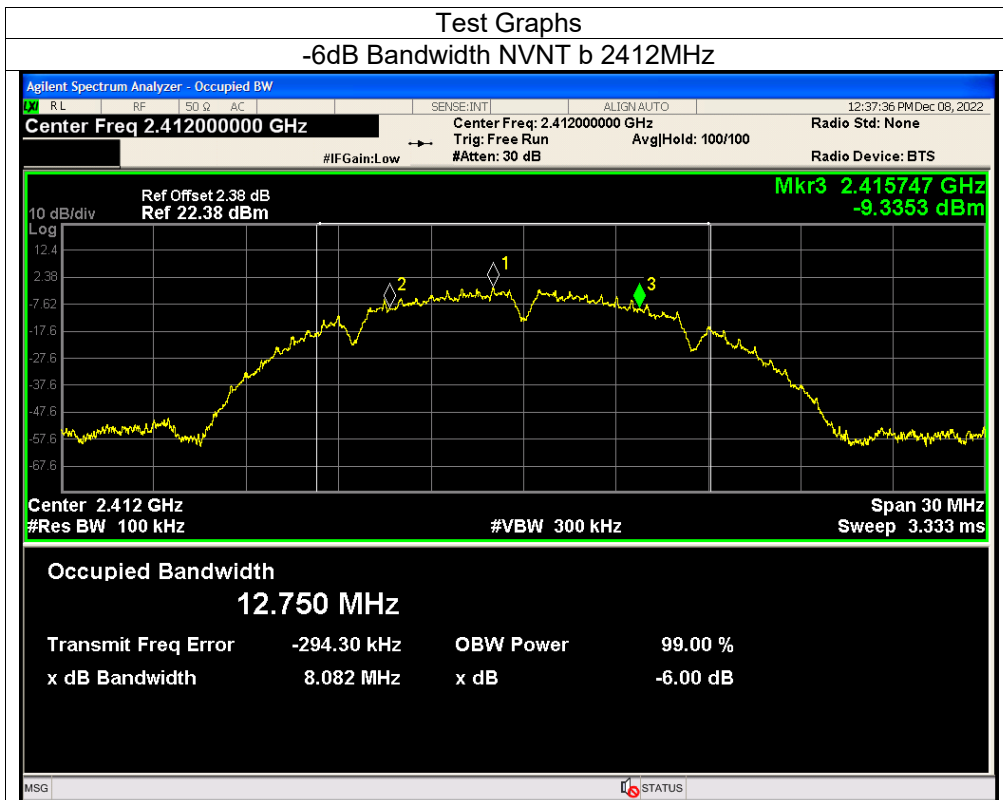

TEC

TC

OVB

检

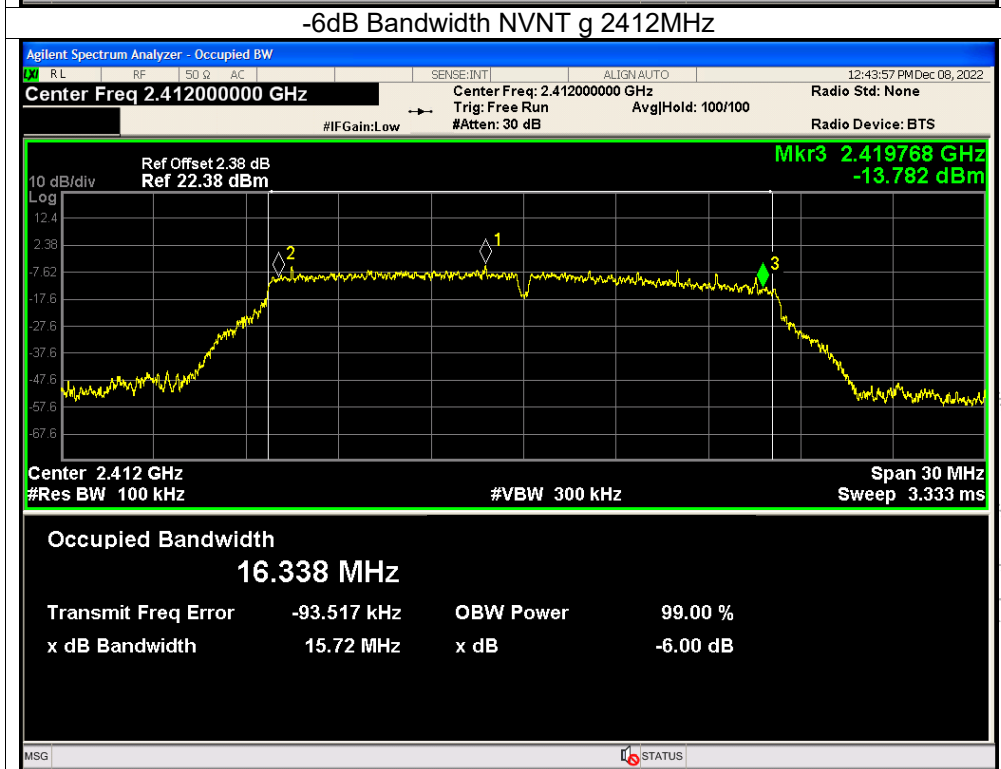
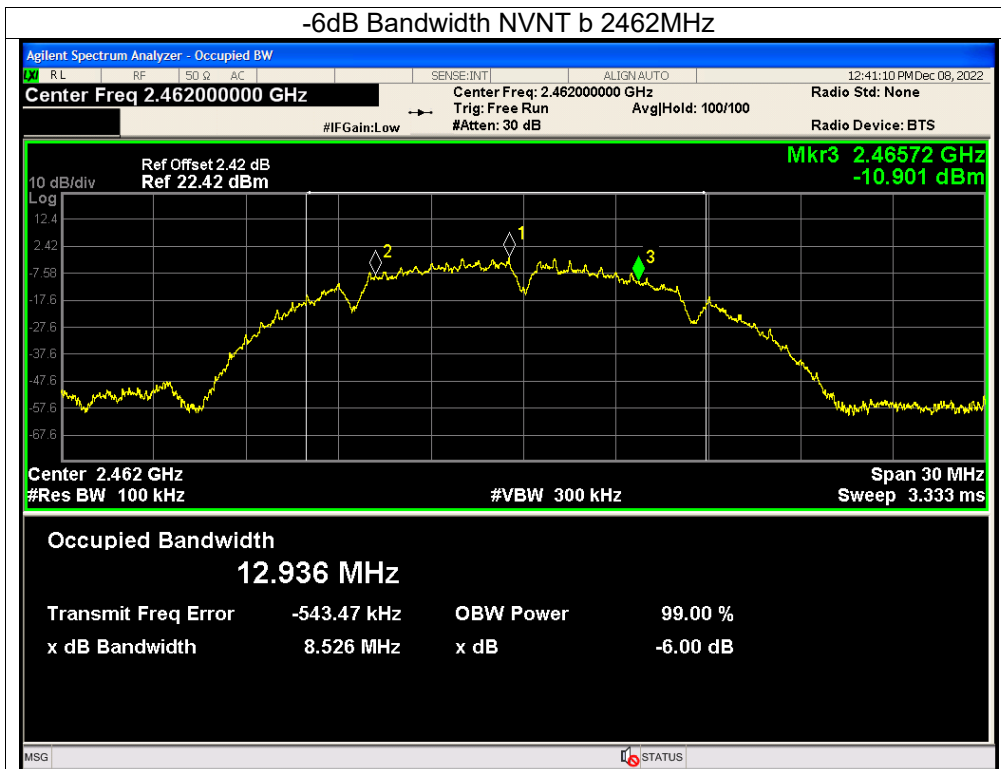

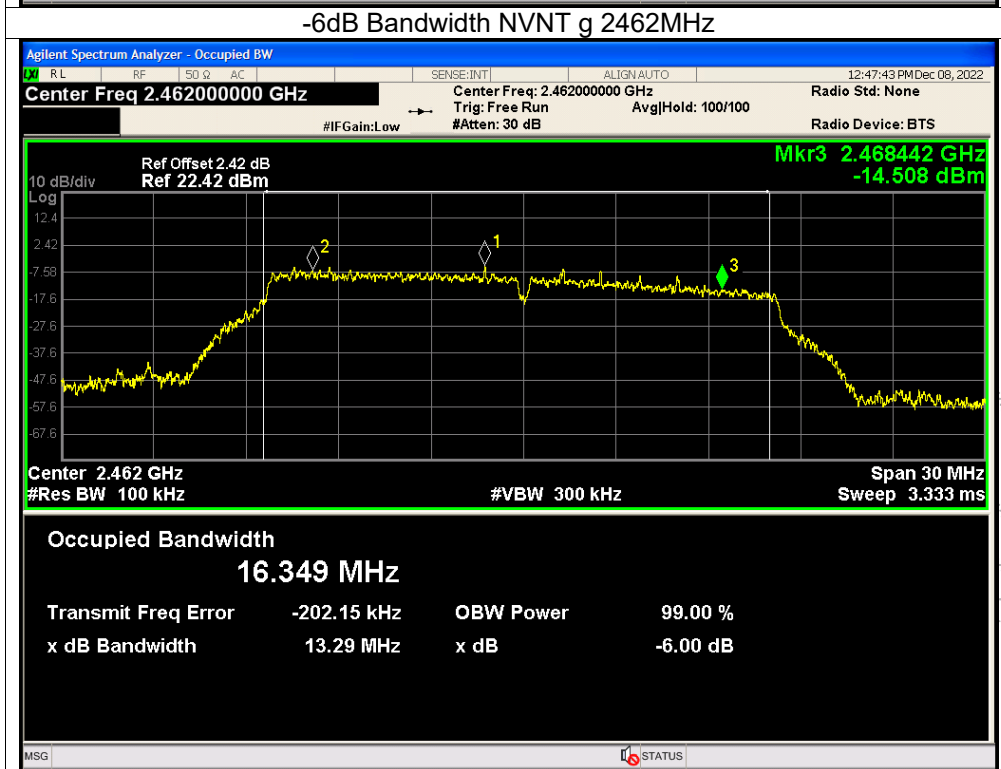
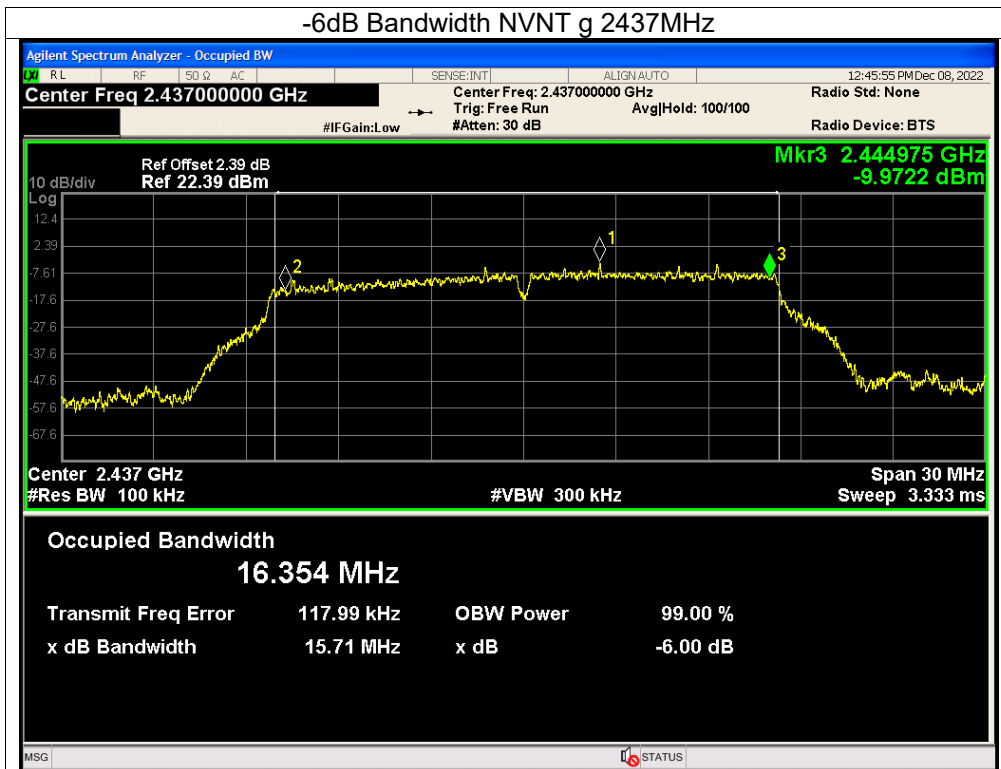

GO.LTD

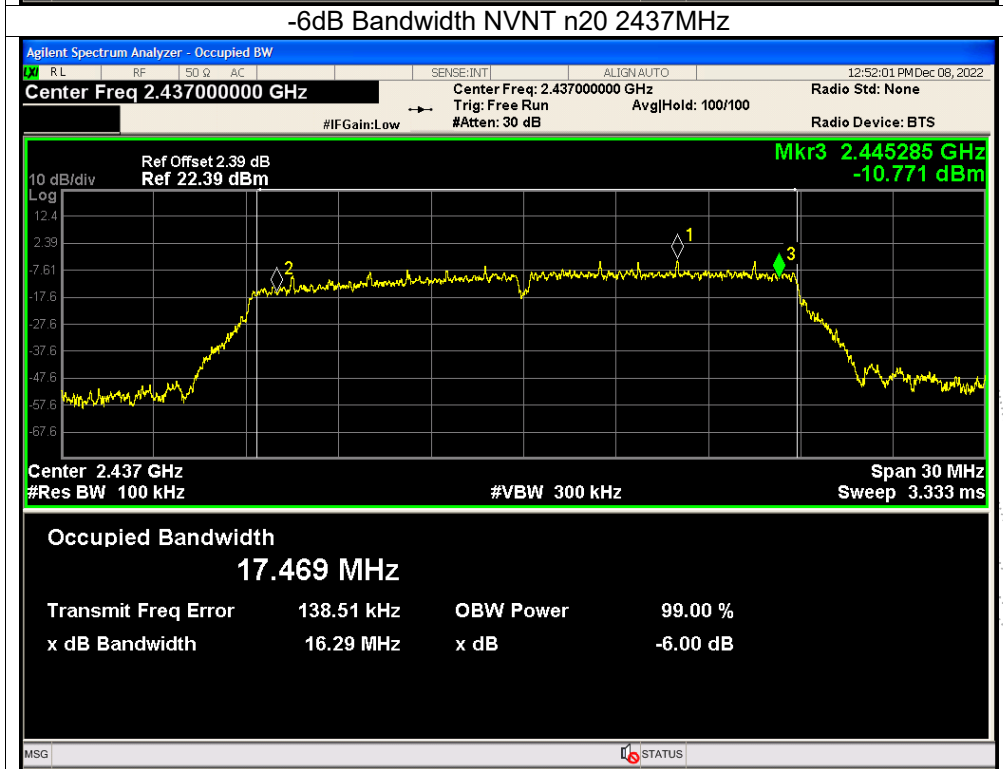
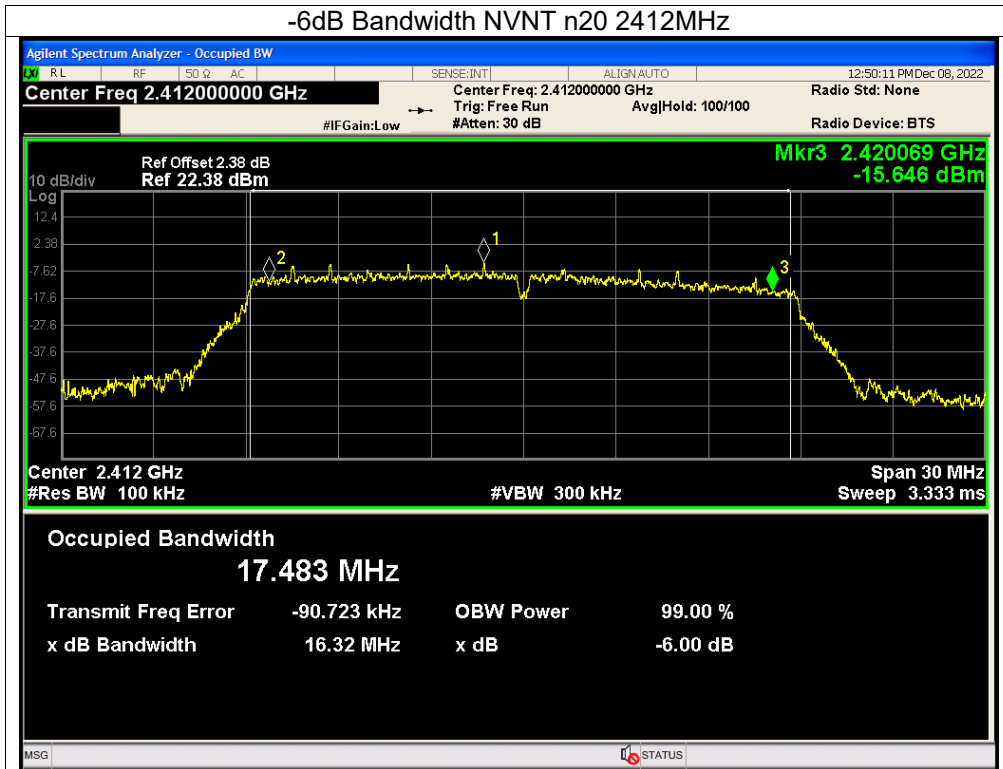

SHENZHEN

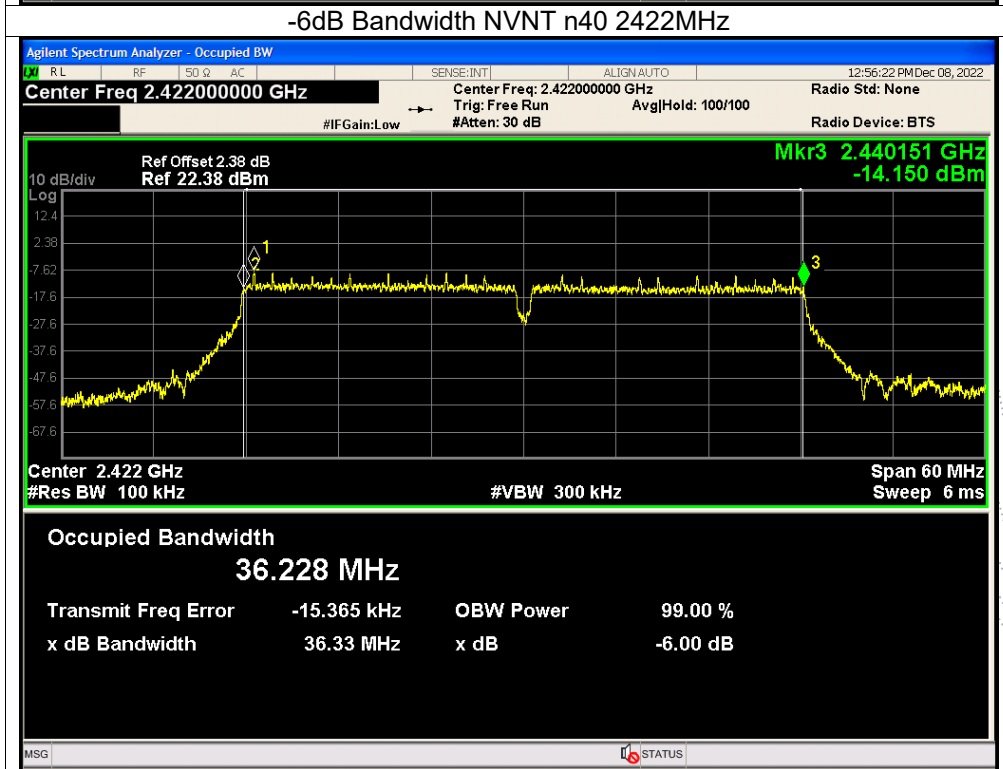
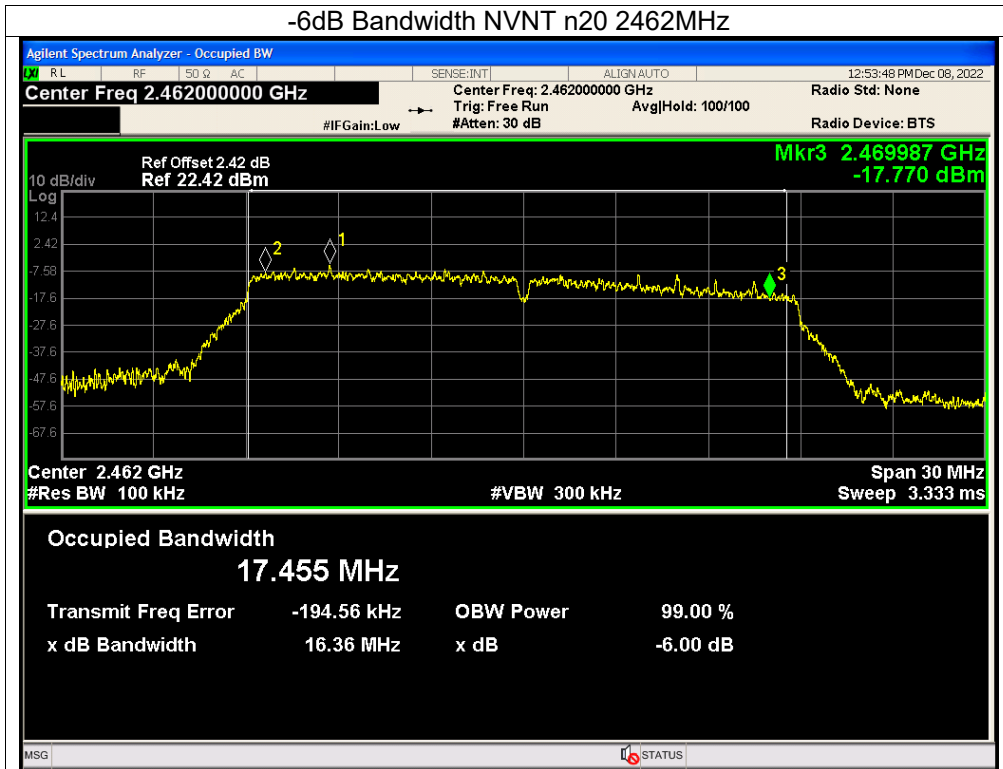

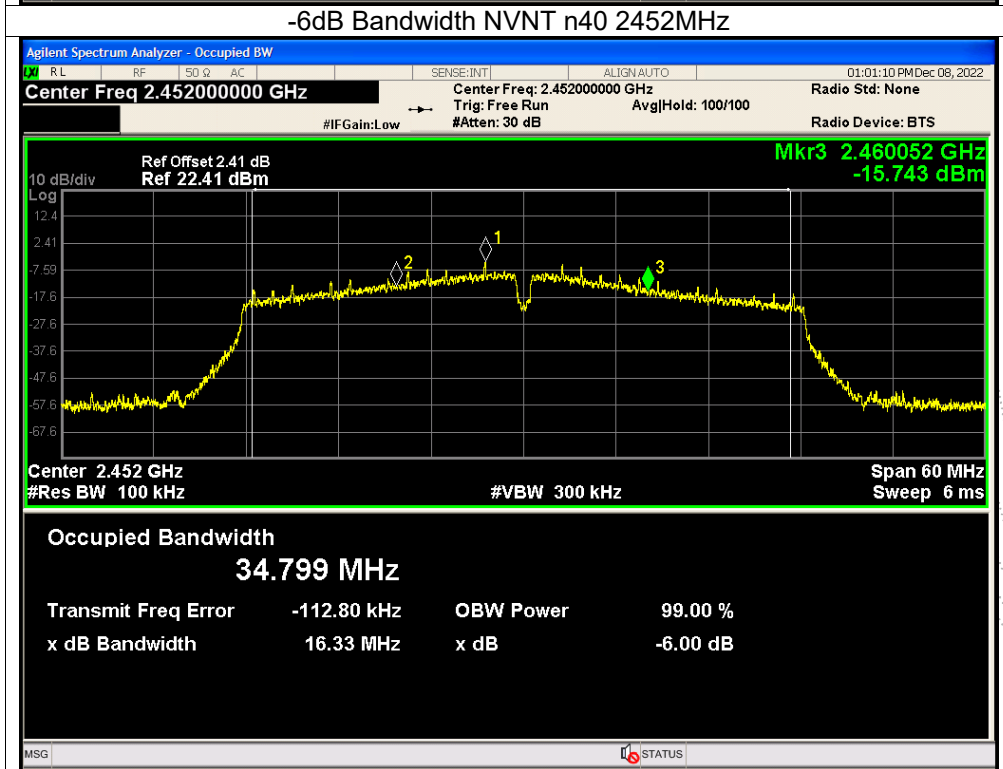
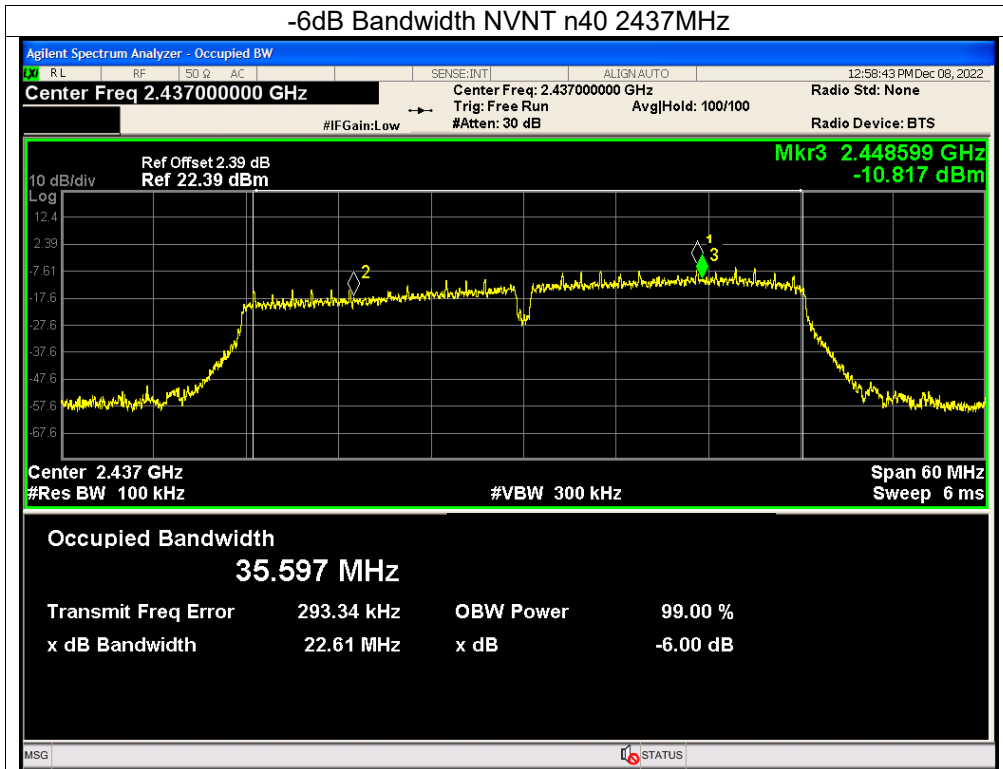

TC
 3C
 PPR
 检测

11. Peak Output Power Test

11.1 Block Diagram Of Test Setup



11.2 Limit

FCC Part15 (15.247) , Subpart C				
Section	Test Item	Limit	Frequency Range (MHz)	Result
15.247(b)(3)	Peak Output Power	1 watt or 30dBm	2400-2483.5	PASS

11.3 Test Procedure

- a. The EUT was directly connected to the Power meter

11.4 EUT Operating Conditions

The EUT tested system was configured as the statements of 4.6 Unless otherwise a special operating condition is specified in the follows during the testing.

Note: Power Spectral Density(dBm)=Reading+Cable Loss

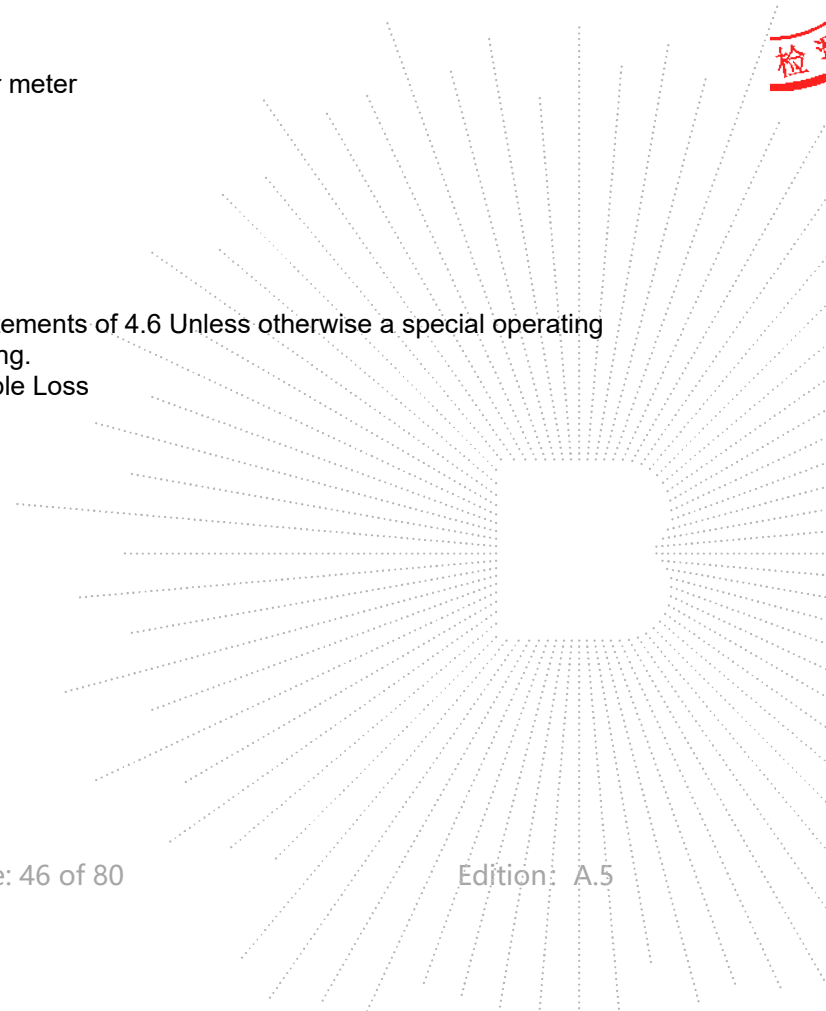

11.5 Test Result

Temperature :	26°C	Relative Humidity :	54%
Pressure :	101kPa	Test Voltage :	DC 3.8V

	Frequency	Maximum Conducted Output Power(PK)	LIMIT
	(MHz)	(dBm)	dBm
802.11b	2412	7.38	30
	2437	7.74	30
	2462	6.77	30
802.11g	2412	6.21	30
	2437	6.54	30
	2462	5.66	30
802.11n20	2412	5.64	30
	2437	5.95	30
	2462	5.1	30
802.11n40	2422	5.22	30
	2437	5.32	30
	2452	5.57	30

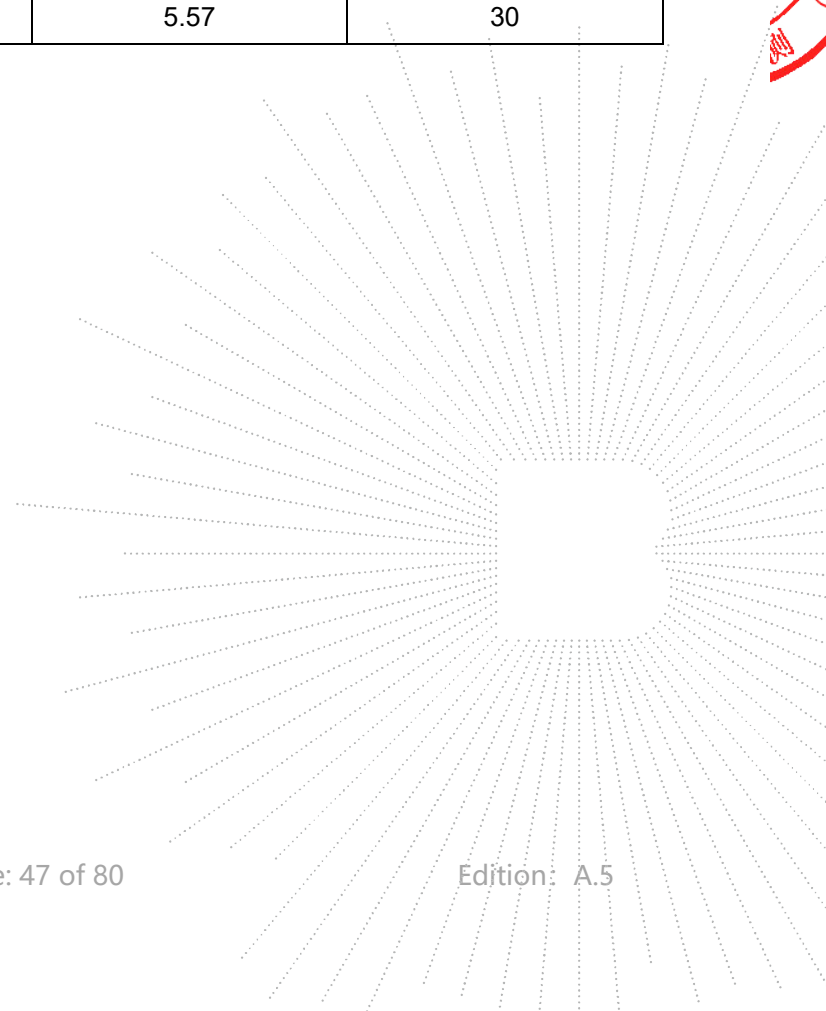

12. 100 KHz Bandwidth Of Frequency Band Edge

12.1 Block Diagram Of Test Setup

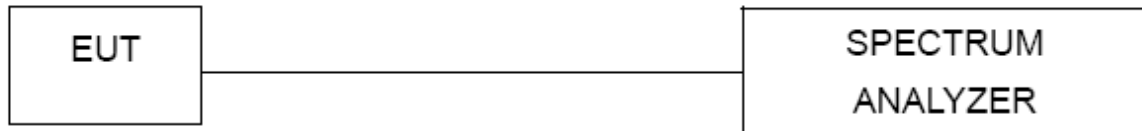

12.2 Limit

In any 100 kHz bandwidth outside the frequency band in which the spread spectrum intentional radiator is operating, the radio frequency power that is produced by the intentional radiator shall be at least 20 dB below that in the 100 kHz bandwidth within the band that contains the highest level of the desired power, based on either an RF conducted or a radiated measurement.

12.3 Test Procedure

Using the following spectrum analyzer setting:

- a) Set the RBW = 100KHz.
- b) Set the VBW = 300KHz.
- c) Sweep time = auto couple.
- d) Detector function = peak.
- e) Trace mode = max hold.
- f) Allow trace to fully stabilize..

12.4 EUT Operating Conditions

The EUT tested system was configured as the statements of 4.6 Unless otherwise a special operating condition is specified in the follows during the testing.

Note: Power Spectral Density(dBm)=Reading+Cable Loss

12.5 Test Result

Temperature :	26°C	Relative Humidity :	54%
Pressure :	101kPa	Test Voltage :	DC 3.8V

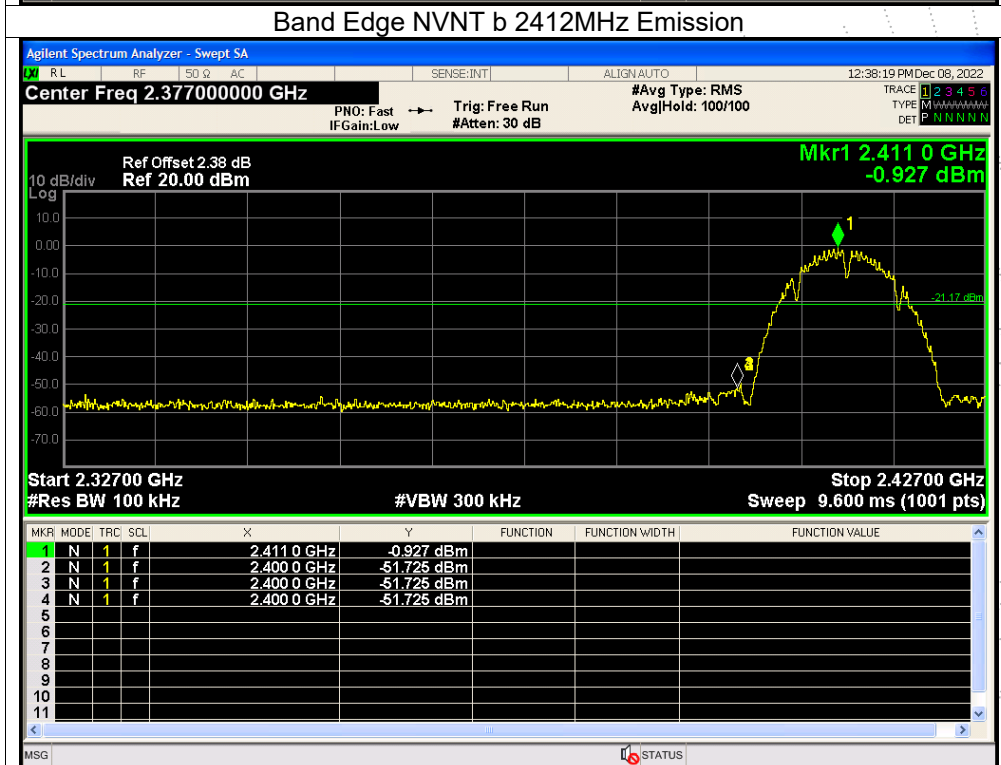
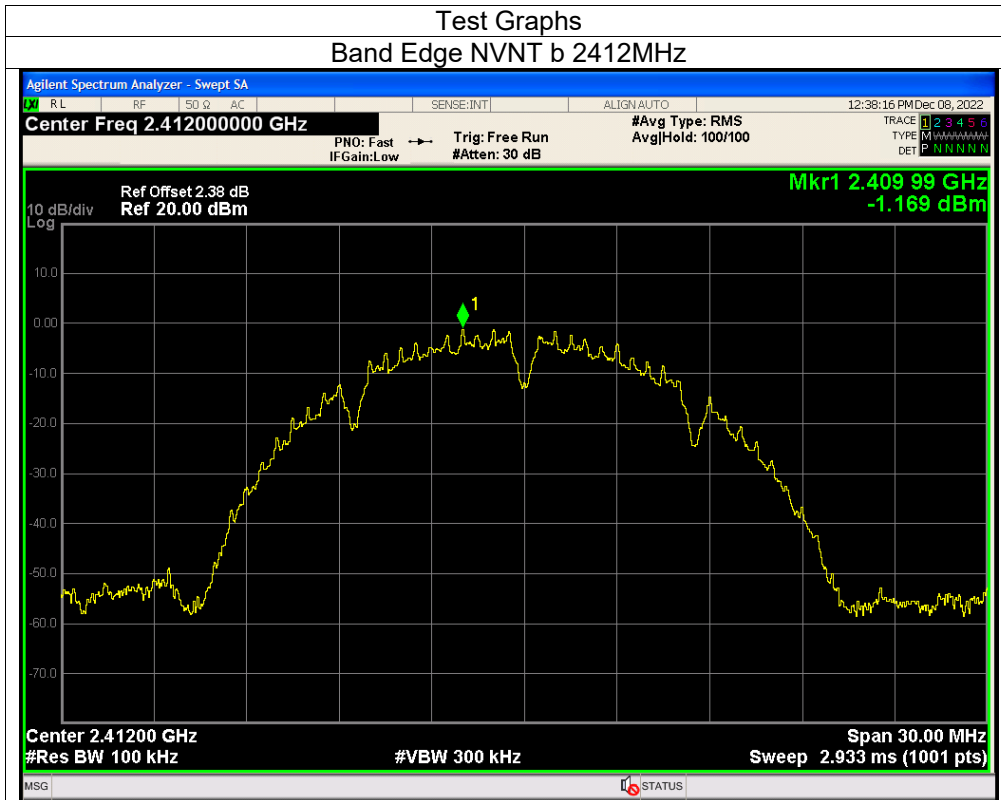

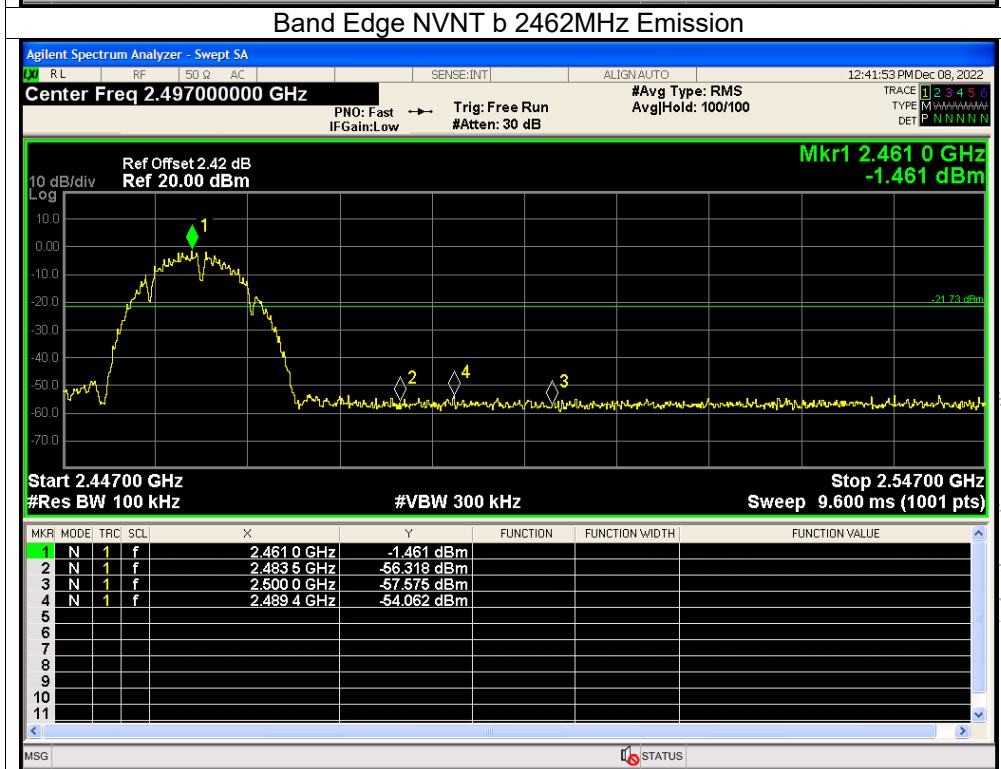
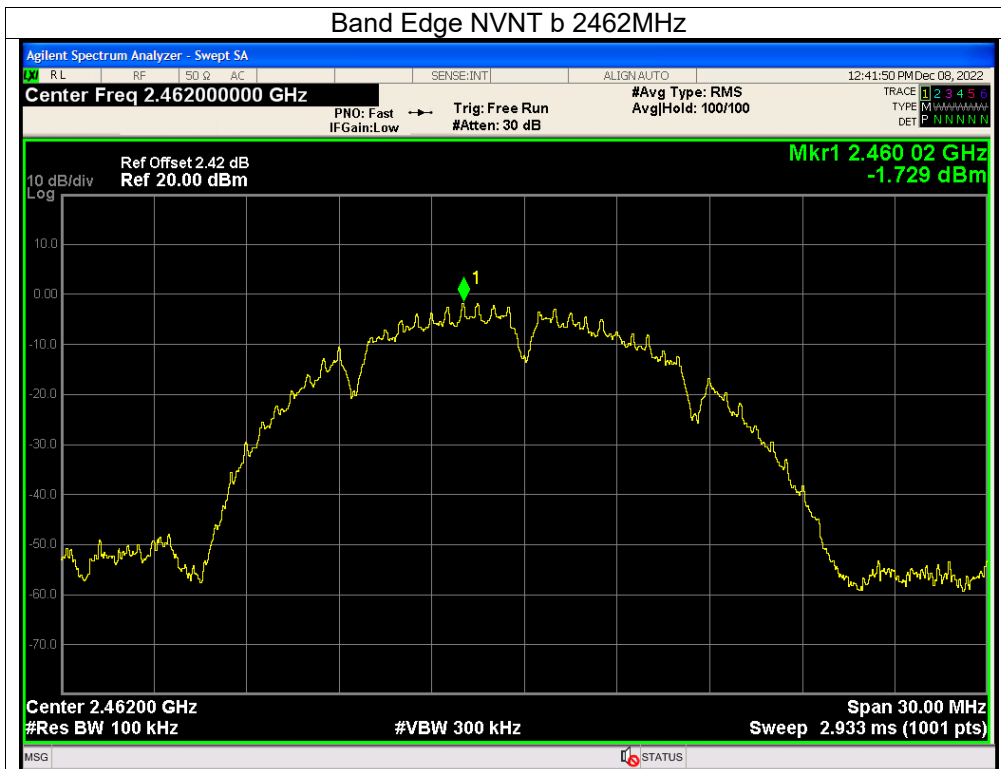

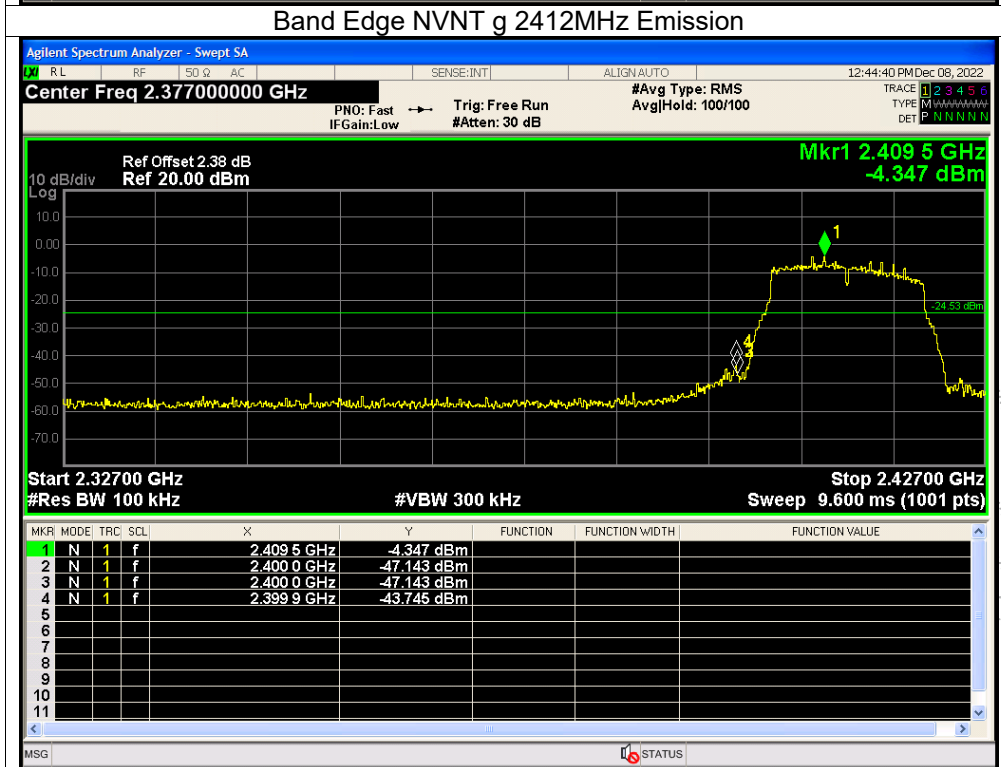
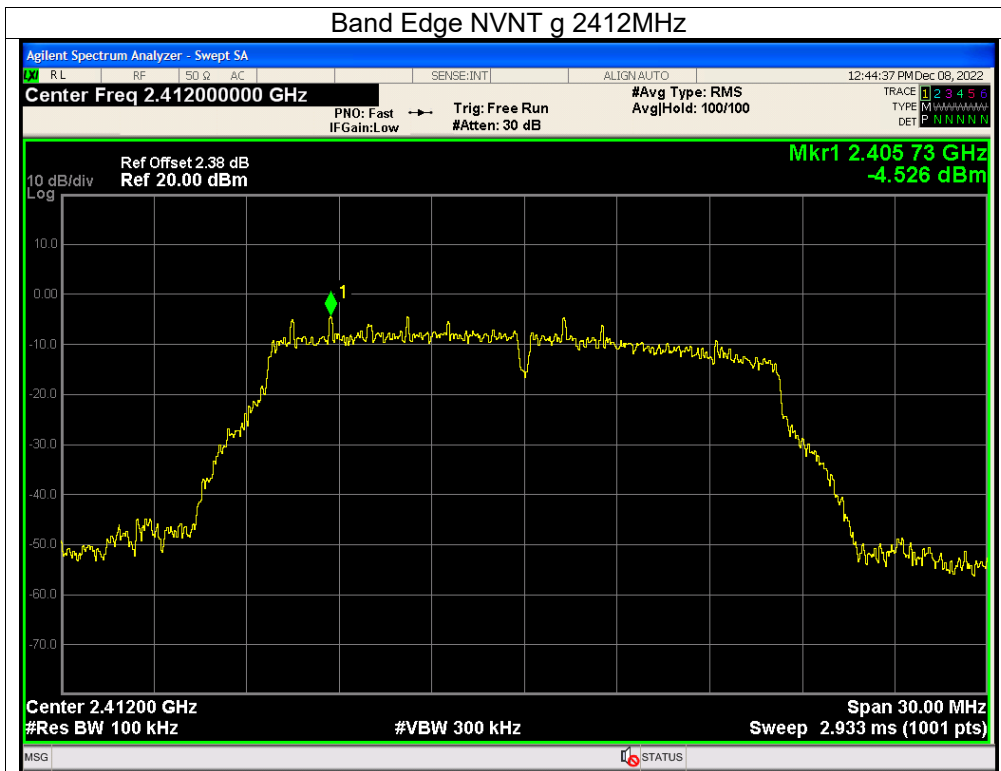

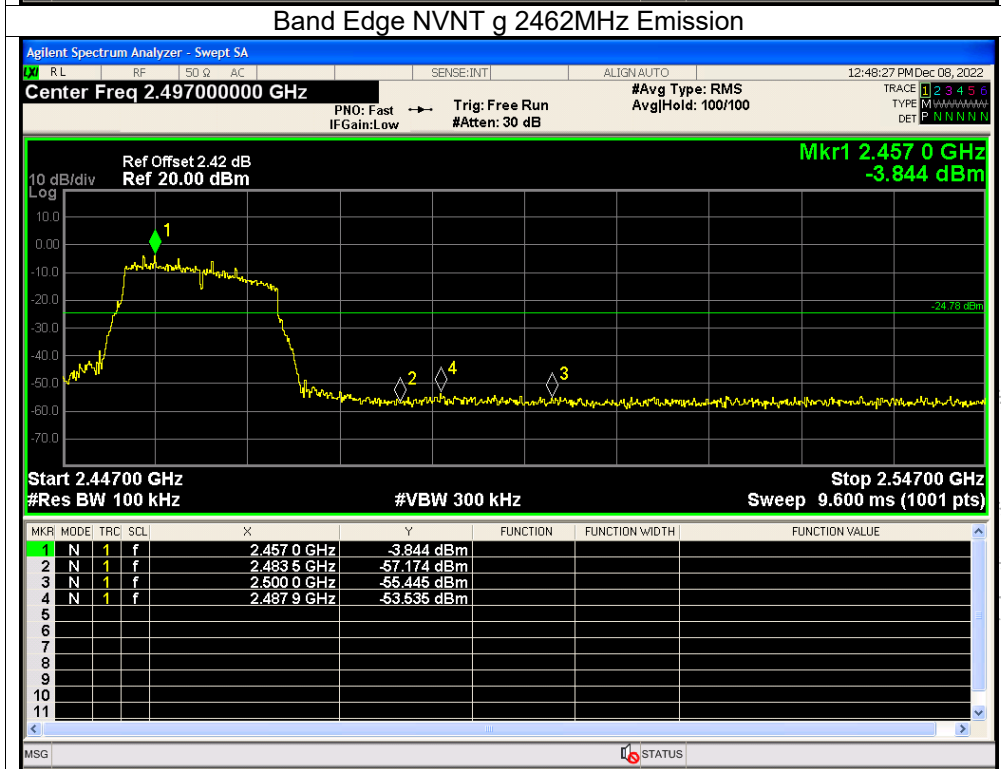
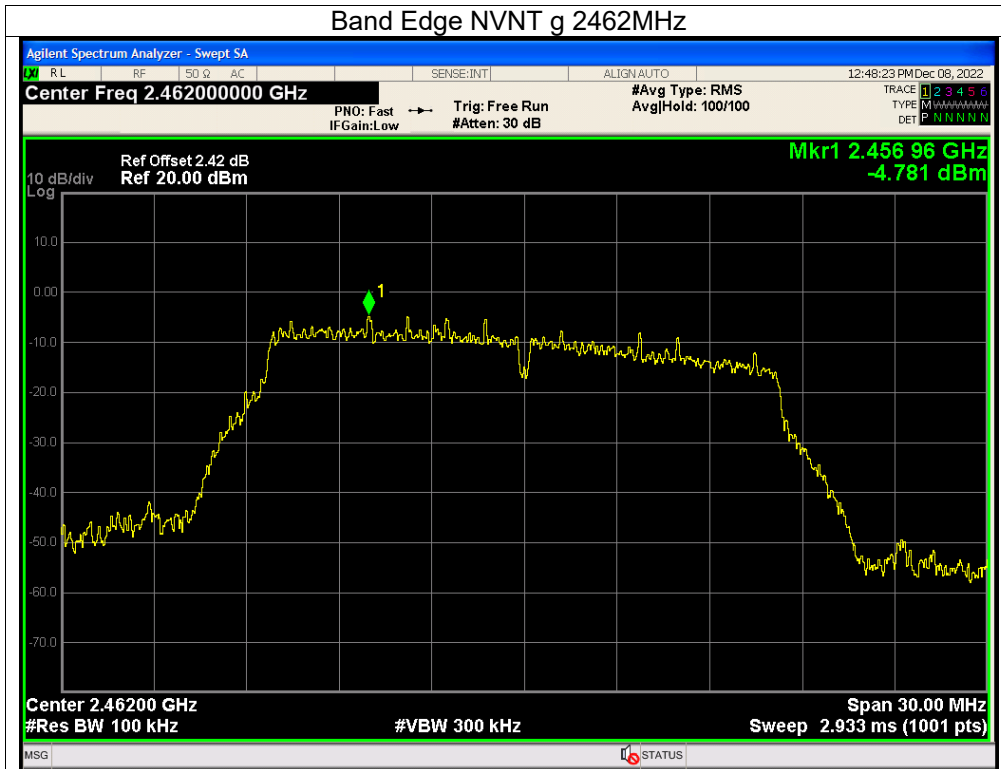

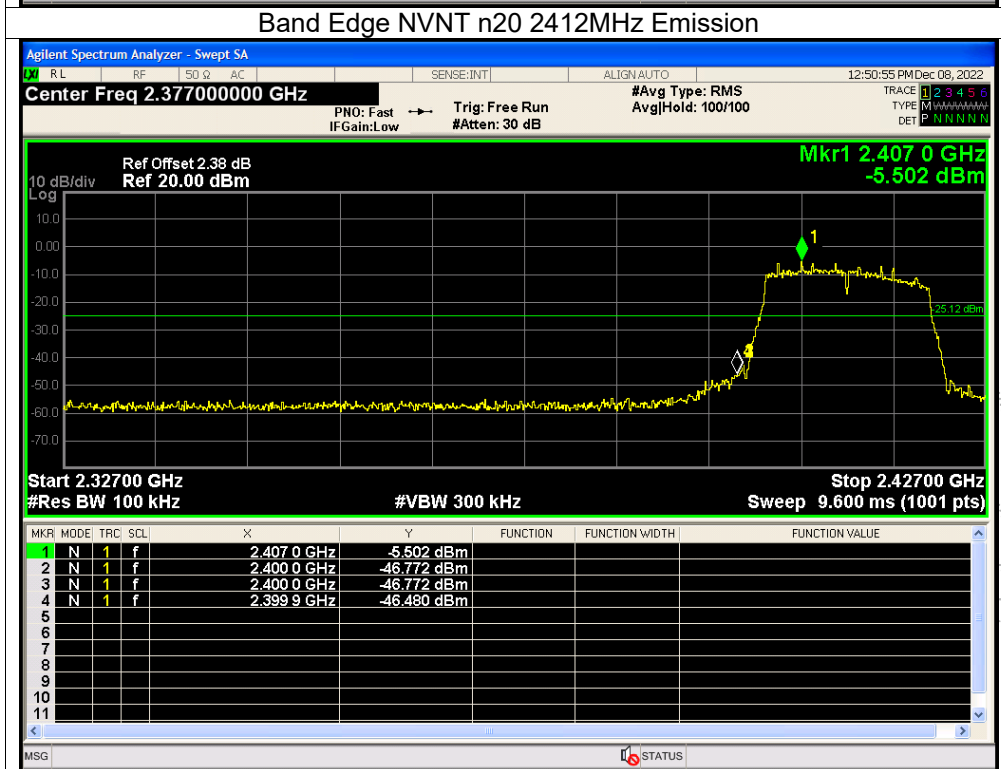
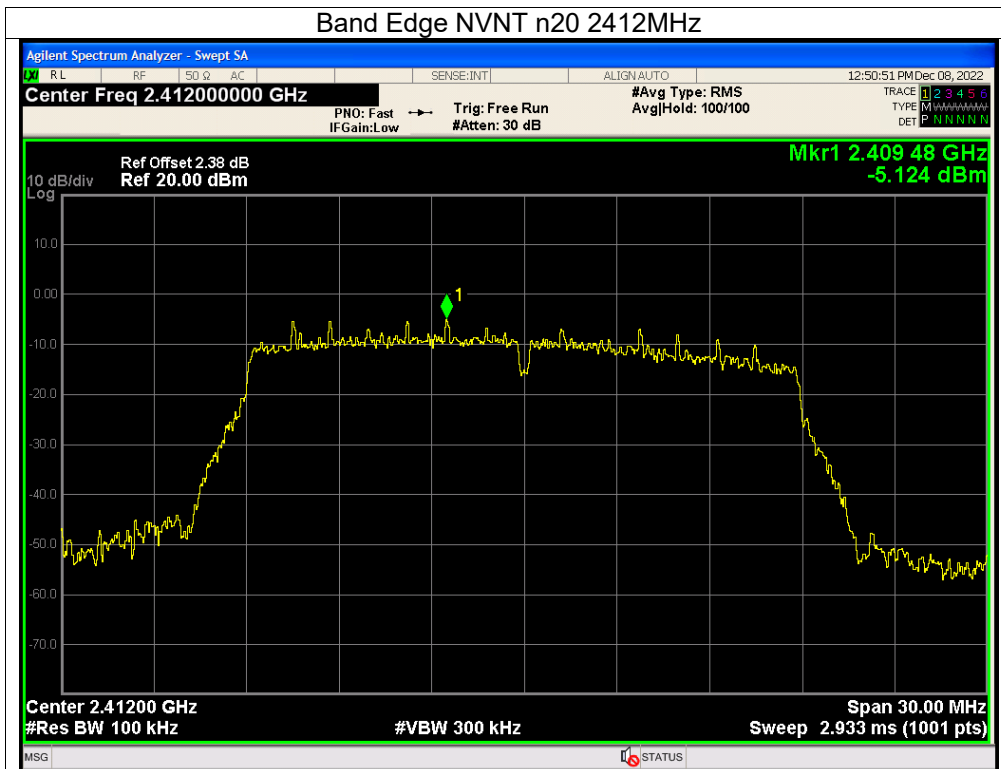

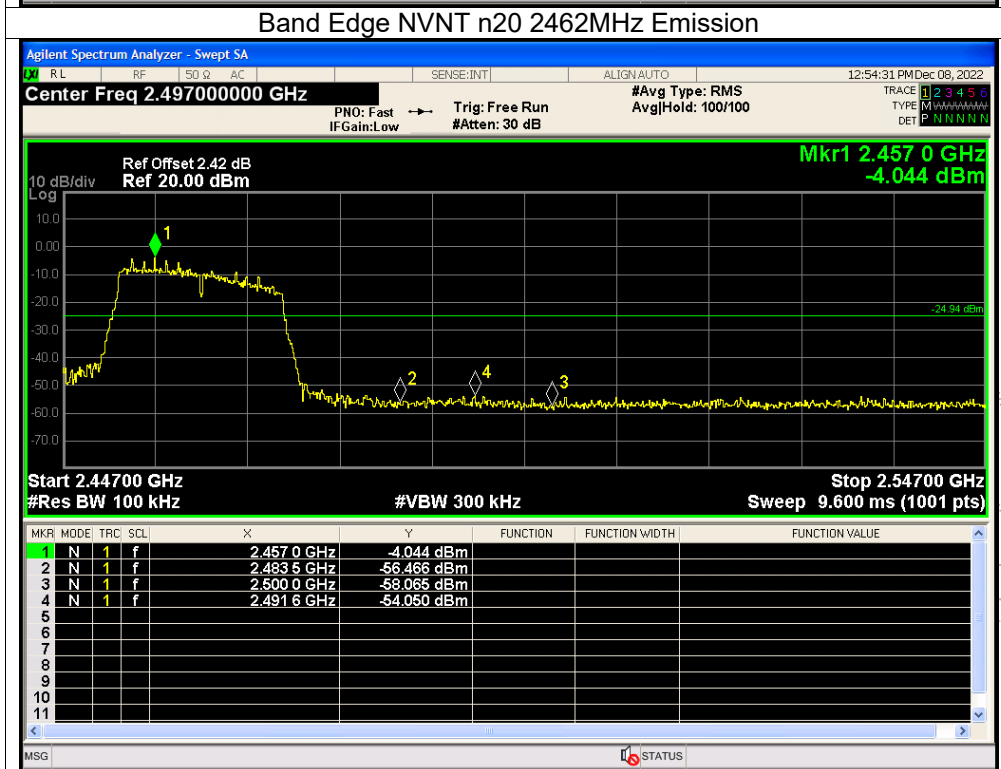
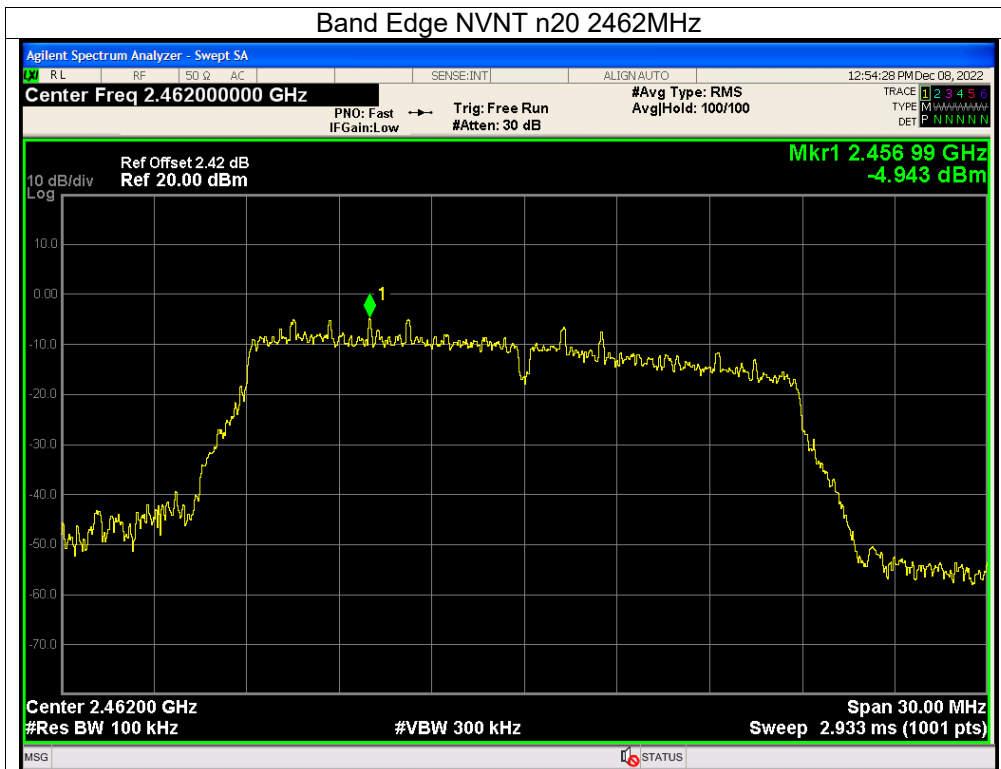

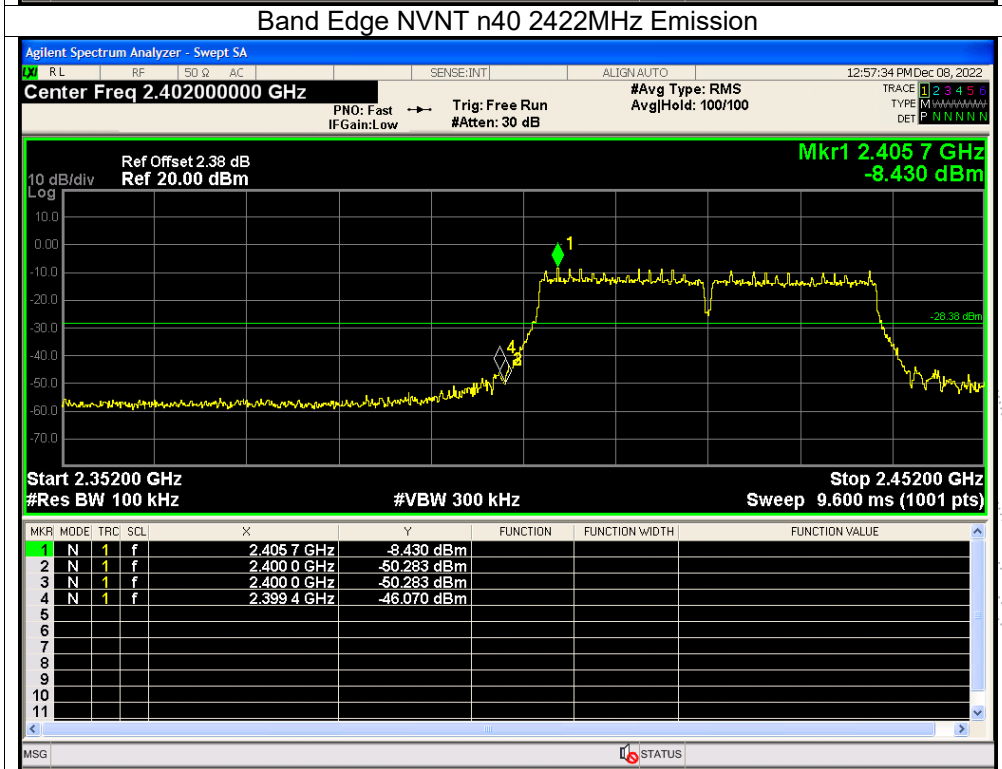
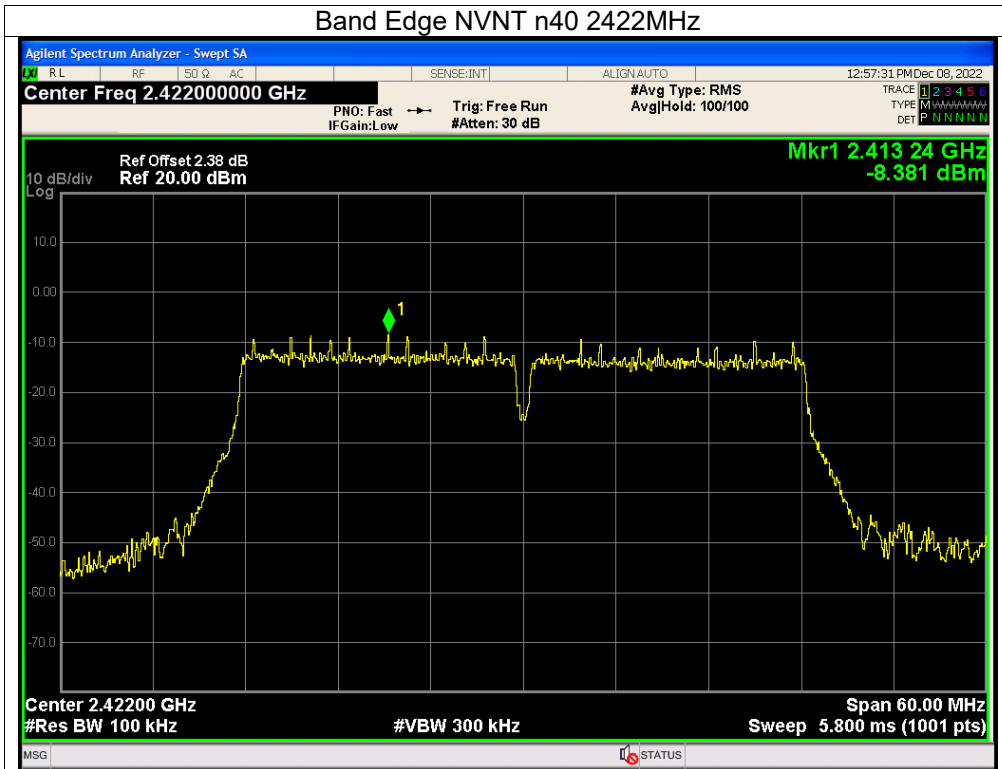

CO.LTD