



MEASUREMENT REPORT

FCC PART 15.247 BLE

FCC ID: 2AAMSHM-9641M
APPLICANT: SHENZHEN NST INDUSTRY AND TRADE CO. LTD

Application Type: Certification
Product: 9.6 Inch Tablet
Model No.: HM-9641M
Brand Name: Stream
FCC Classification: Digital Transmission System (DTS)
FCC Rule Part(s): Part 15.247
Test Procedure(s): ANSI C63.10-2009, KDB 558074 D01v03r02
Test Date: Dec. 11 ~ 17, 2014

Reviewed By : Robin Wu
(Robin Wu)
Approved By : Marlin Chen
(Marlin Chen)

The test results relate only to the samples tested.

This equipment has been shown to be capable of compliance with the applicable technical standards as indicated in the measurement report and was tested in accordance with the measurement procedures specified in KDB 558074 D01v03r02. Test results reported herein relate only to the item(s) tested.

The test report shall not be reproduced except in full without the written approval of MRT Technology (Suzhou) Co., Ltd.

Revision History

| Report No. | Version | Description | Issue Date |
|--------------|---------|----------------|------------|
| 1412RSU00902 | Rev. 01 | Initial report | 12-17-2014 |
| | | | |

CONTENTS

| Description | Page |
|---|-----------|
| 1. INTRODUCTION | 6 |
| 1.1. Scope | 6 |
| 1.2. MRT Test Location | 6 |
| 2. PRODUCT INFORMATION | 7 |
| 2.1. Equipment Description..... | 7 |
| 2.2. Product Specification Subjective to this Report..... | 7 |
| 2.3. Device Capabilities | 8 |
| 2.4. Test Configuration | 9 |
| 2.5. EMI Suppression Device(s)/Modifications..... | 9 |
| 2.6. Labeling Requirements..... | 9 |
| 2.7. Test Software | 9 |
| 2.8. Description of Support Units | 9 |
| 3. DESCRIPTION OF TEST | 10 |
| 3.1. Evaluation Procedure | 10 |
| 3.2. AC Line Conducted Emissions | 10 |
| 3.3. Radiated Emissions..... | 11 |
| 4. ANTENNA REQUIREMENTS..... | 12 |
| 5. TEST EQUIPMENT CALIBRATION DATE | 13 |
| 6. MEASUREMENT UNCERTAINTY..... | 14 |
| 7. TEST RESULT | 15 |
| 7.1. Summary | 15 |
| 7.2. 6dB Bandwidth Measurement..... | 16 |
| 7.2.1. Test Limit | 16 |
| 7.2.2. Test Procedure used..... | 16 |
| 7.2.3. Test Setting..... | 16 |
| 7.2.4. Test Setup..... | 16 |
| 7.2.5. Test Result..... | 17 |
| 7.3. Output Power Measurement..... | 18 |
| 7.3.1. Test Limit | 18 |
| 7.3.2. Test Procedure Used | 18 |
| 7.3.3. Test Setting..... | 18 |
| 7.3.4. Test Setup..... | 18 |
| 7.3.5. Test Result of Output Power | 19 |

| | | |
|-----------|--|-----------|
| 7.4. | Power Spectral Density Measurement | 20 |
| 7.4.1. | Test Limit | 20 |
| 7.4.2. | Test Procedure Used | 20 |
| 7.4.3. | Test Setting..... | 20 |
| 7.4.4. | Test Setup..... | 20 |
| 7.4.5. | Test Result..... | 21 |
| 7.5. | Conducted Band Edge and Out-of-Band Emissions..... | 22 |
| 7.5.1. | Test Limit | 22 |
| 7.5.2. | Test Procedure Used | 22 |
| 7.5.3. | Test Setting..... | 22 |
| 7.5.4. | Test Setup..... | 23 |
| 7.5.5. | Test Result..... | 24 |
| 7.6. | Radiated Spurious Emission Measurement | 26 |
| 7.6.1. | Test Limit | 26 |
| 7.6.2. | Test Procedure Used | 26 |
| 7.6.3. | Test Setting..... | 26 |
| 7.6.4. | Test Setup..... | 28 |
| 7.6.5. | Test Result..... | 30 |
| 7.7. | Radiated Restricted Band Edge Measurement | 37 |
| 7.7.1. | Test Result..... | 37 |
| 7.8. | AC Conducted Emissions Measurement..... | 45 |
| 7.8.1. | Test Limit | 45 |
| 7.8.2. | Test Setup..... | 45 |
| 7.8.3. | Test Result..... | 46 |
| 8. | CONCLUSION..... | 48 |

§2.1033 General Information

| | |
|--------------------------------|---|
| Applicant: | SHENZHEN NST INDUSTRY AND TRADE CO. LTD |
| Applicant Address: | 2/F, Building B, Hongmen Technical Park II, Jihua RD, Buji Town, Longgang District, Shenzhen, China |
| Manufacturer: | SHENZHEN NST INDUSTRY AND TRADE CO. LTD |
| Manufacturer Address: | 2/F, Building B, Hongmen Technical Park II, Jihua RD, Buji Town, Longgang District, Shenzhen, China |
| Test Site: | MRT Technology (Suzhou) Co., Ltd |
| Test Site Address: | D8 Building, Youxin Industrial Park, No.2 Tian'edang Rd., Wuzhong Economic Development Zone, Suzhou, China |
| MRT Registration No.: | 809388 |
| FCC Rule Part(s): | Part 15.247 |
| Model No.: | HM-9641M |
| FCC ID: | 2AAMSHM-9641M |
| Test Device Serial No.: | N/A <input type="checkbox"/> Production <input checked="" type="checkbox"/> Pre-Production <input type="checkbox"/> Engineering |
| FCC Classification: | Digital Transmission System (DTS) |

Test Facility / Accreditations

Measurements were performed at MRT Laboratory located in Tian'edang Rd., Suzhou, China.

- MRT facility is a FCC registered (MRT Reg. No. 809388) test facility with the site description report on file and has met all the requirements specified in Section 2.948 of the FCC Rules.
- MRT facility is an IC registered (MRT Reg. No. 11384A-1) test laboratory with the site description on file at Industry Canada.
- MRT facility is a VCCI registered (R-4179, G-814, C-4664, T-2206) test laboratory with the site description on file at VCCI Council.
- MRT Lab is accredited to ISO 17025 by the American Association for Laboratory Accreditation (A2LA) under the American Association for Laboratory Accreditation Program (A2LA Cert. No. 3628.01) in EMC, Telecommunications and Radio testing for FCC, Industry Canada, EU and TELEC Rules.

1. INTRODUCTION

1.1. Scope

Measurement and determination of electromagnetic emissions (EMC) of radio frequency devices including intentional and/or unintentional radiators for compliance with the technical rules and regulations of the Federal Communications Commission and the Industry Canada Certification and Engineering Bureau.

1.2. MRT Test Location

The map below shows the location of the MRT LABORATORY, its proximity to the Taihu Lake. These measurement tests were conducted at the MRT Technology (Suzhou) Co., Ltd. Facility located at D8 Building, Youxin Industrial Park, No.2 Tian'edang Rd., Wuzhong Economic Development Zone, Suzhou, China. The detailed description of the measurement facility was found to be in compliance with the requirements of § 2.948 according to ANSI C63.4-2009 on September 30, 2013.



2. PRODUCT INFORMATION

2.1. Equipment Description

| | |
|-------------------------|--|
| Product Name | 9.6 Inch Tablet |
| Model No. | HM-9641M |
| Serial Model | STR-9.6-TABLET, MX96XXX, Model Difference Description: e.g. MX96XXX, "XXX" in the last three digits, the first and second "X" represent A to Z, the last "X" represents 1 to 9. |
| Wi-Fi Specification | 802.11b/g/n |
| Bluetooth Specification | v4.0 (single mode) |

Note: The difference of models is for different marketing requirement.

2.2. Product Specification Subjective to this Report

| | |
|--------------------|----------|
| Type of modulation | GFSK |
| Data Rate | 1Mbps |
| Antenna Type | Internal |
| Antenna Gain | 1.2dBi |

Note: For other features of this EUT, test report will be issued separately.

Channel List for BLE

| Channel | Frequency | Channel | Frequency | Channel | Frequency |
|---------|-----------|---------|-----------|---------|-----------|
| 00 | 2402 MHz | 01 | 2404 MHz | 02 | 2406 MHz |
| 03 | 2408 MHz | 04 | 2410 MHz | 05 | 2412 MHz |
| 06 | 2414 MHz | 07 | 2416 MHz | 08 | 2418 MHz |
| 09 | 2420 MHz | 10 | 2422 MHz | 11 | 2424 MHz |
| 12 | 2426 MHz | 13 | 2428 MHz | 14 | 2430 MHz |
| 15 | 2432 MHz | 16 | 2434 MHz | 17 | 2436 MHz |
| 18 | 2438 MHz | 19 | 2440 MHz | 20 | 2442 MHz |
| 21 | 2444 MHz | 22 | 2446 MHz | 23 | 2448 MHz |
| 24 | 2450 MHz | 25 | 2452 MHz | 26 | 2454 MHz |
| 27 | 2456 MHz | 28 | 2458 MHz | 29 | 2460 MHz |
| 30 | 2462 MHz | 31 | 2464 MHz | 32 | 2466 MHz |
| 33 | 2468 MHz | 34 | 2470 MHz | 35 | 2472 MHz |
| 36 | 2474 MHz | 37 | 2476 MHz | 38 | 2478 MHz |
| 39 | 2480 MHz | N/A | N/A | N/A | N/A |

2.3. Device Capabilities

This device contains the following capabilities:

802.11b/g/n WLAN (DTS), Bluetooth (BLE)

Note: The maximum achievable duty cycles for all modes were determined based on measurements performed on a spectrum analyzer in zero-span mode with RBW = 8MHz, VBW = 50MHz, and detector = peak per the guidance of Section 6.0 b) of KDB 558074 D01v03r02. The RBW and VBW were both greater than 50/T, where T is the minimum transmission duration, and the number of sweep points across T was greater than 100. The duty cycle is as follows:

- BLE – 72.1%

2.4. Test Configuration

The **9.6 Inch Tablet FCC ID: 2AAMSHM-9641M** was tested per the guidance of KDB 558074 D01v03r02. ANSI C63.10-2009 was used to reference the appropriate EUT setup for radiated spurious emissions testing and AC line conducted testing.

2.5. EMI Suppression Device(s)/Modifications

No EMI suppression device(s) were added and/or no modifications were made during testing.

2.6. Labeling Requirements

Per 2.1074 & 15.19; Docket 95-19

The label shall be permanently affixed at a conspicuous location on the device; instruction manual or pamphlet supplied to the user and be readily visible to the purchaser at the time of purchase.

However, when the device is so small wherein placement of the label with specified statement is not practical, only the trade name and FCC ID must be displayed on the device per Section 15.19(a)(5). Please see attachment for FCC ID label and label location.

2.7. Test Software

The test utility software used during testing was engineering order directive by applicant.

2.8. Description of Support Units

The EUT has been tested with associated equipment below:

| Description | Manufacturer | Model No. |
|-------------|---------------|-----------|
| Adapter | Supply by MRT | HSU50600F |

3. DESCRIPTION OF TEST

3.1. Evaluation Procedure

The measurement procedures described in the American National Standard for Testing Unlicensed Wireless Devices (ANSI C63.10-2009), and the guidance provided in KDB 558074 D01v03r02 were used in the measurement of the **9.6 Inch Tablet FCC ID: 2AAMSHM-9641M**.

Deviation from measurement procedure.....None

3.2. AC Line Conducted Emissions

The line-conducted facility is located inside an 8'x4'x4' shielded enclosure. A 1m x 2m wooden table 80cm high is placed 40cm away from the vertical wall and 80cm away from the sidewall of the shielded room. Two 10kHz-30MHz, 50Ω/50uH Line-Impedance Stabilization Networks (LISNs) are bonded to the shielded room floor. Power to the LISNs is filtered by external high-current high-insertion loss power line filters. These filters attenuate ambient signal noise from entering the measurement lines. These filters are also bonded to the shielded enclosure.

The EUT is powered from one LISN and the support equipment is powered from the second LISN. All interconnecting cables more than 1 meter were shortened to a 1 meter length by non-inductive bundling (serpentine fashion) and draped over the back edge of the test table. All cables were at least 40cm above the horizontal reference ground-plane. Power cables for support equipment were routed down to the second LISN while ensuring that that cables were not draped over the second LISN.

Sufficient time for the EUT, support equipment, and test equipment was allowed in order for them to warm up to their normal operating condition. The RF output of the LISN was connected to the receiver and exploratory measurements were made to determine the frequencies producing the maximum emission from the EUT. The receiver was scanned from 150kHz to 30MHz. The detector function was set to peak mode for exploratory measurements while the bandwidth of the analyzer was set to 9kHz. The EUT, support equipment, and interconnecting cables were arranged and manipulated to maximize each emission. Each emission was also maximized by varying: power lines, the mode of operation or data exchange speed, or support equipment whichever determined the worst-case emission. Once the worst case emissions have been identified, the one EUT cable configuration/arrangement and mode of operation that produced these emissions were used for final measurements on the same test site. The analyzer is set to CISPR quasi-peak and average detectors with a 9kHz resolution bandwidth for final measurements.

An extension cord was used to connect to a single LISN which powered by EUT. The extension cord was calibrated with LISN, the impedance and insertion loss are compliance with the requirements as stated in ANSI C63.10-2009 at Clause 4.3.

Line conducted emissions test results are shown in Section 7.8.

3.3. Radiated Emissions

The radiated test facilities consisted of an indoor 3 meter semi-anechoic chamber used for final measurements and exploratory measurements, when necessary. The measurement area is contained within the semi-anechoic chamber which is shielded from any ambient interference. For measurements above 1GHz absorbers are arranged on the floor between the turn table and the antenna mast in such a way so as to maximize the reduction of reflections. For measurements below 1GHz, the absorbers are removed. A MF Model 210SS turntable is used for radiated measurement. It is a continuously rotatable, remote controlled, metallic turntable and 2 meters (6.56 ft.) in diameter. The turn table is flush with the raised floor of the chamber in order to maintain its function as a ground plane. An 80cm high PVC support structure is placed on top of the turntable.

For all measurements, the spectrum was scanned through all EUT azimuths and from 1 to 4 meter receive antenna height using a broadband antenna from 30MHz up to the upper frequency shown in 15.33(b)(1) depending on the highest frequency generated or used in the device or on which the device operates or tunes. For frequencies above 1GHz, linearly polarized double ridge horn antennas were used. For frequencies below 30MHz, a calibrated loop antenna was used. When exploratory measurements were necessary, they were performed at 1 meter test distance inside the semi-anechoic chamber using broadband antennas, broadband amplifiers, and spectrum analyzers to determine the frequencies and modes producing the maximum emissions. Sufficient time for the EUT, support equipment, and test equipment was allowed in order for them to warm up to their normal operating condition. The test set-up was placed on top of the 0.8 meter high, 1 x 1.5 meter table. The EUT, support equipment, and interconnecting cables were arranged and manipulated to maximize each emission. Appropriate precaution was taken to ensure that all emissions from the EUT were maximized and investigated. The system configuration, clock speed, mode of operation or video resolution, if applicable, turntable azimuth, and receive antenna height was noted for each frequency found.

Final measurements were made in the semi-anechoic chamber using calibrated, linearly polarized broadband and horn antennas. The test setup was configured to the setup that produced the worst case emissions. The spectrum analyzer was set to investigate all frequencies required for testing to compare the highest radiated disturbances with respect to the specified limits. The turntable containing the EUT was rotated through 360 degrees and the height of the receive antenna was varied 1 to 4 meters and stopped at the azimuth and height producing the maximum emission. Each emission was maximized by changing the orientation of the EUT through three orthogonal planes and changing the polarity of the receive antenna, whichever produced the worst-case emissions. According to 3dB BeamWidth of horn antenna, the horn antenna should be always directed to the EUT when rising height.

4. ANTENNA REQUIREMENTS

Excerpt from §15.203 of the FCC Rules/Regulations:

“An intentional radiator antenna shall be designed to ensure that no antenna other than that furnished by the responsible party can be used with the device. The use of a permanently attached antenna or of an antenna that uses a unique coupling to the intentional radiator shall be considered sufficient to comply with the provisions of this section.”

- The antenna of the 9.6 Inch Tablet is **permanently attached**.
- There are no provisions for connection to an external antenna.

Conclusion:

The **9.6 Inch Tablet FCC ID: 2AAMSHM-9641M** unit complies with the requirement of §15.203.

5. TEST EQUIPMENT CALIBRATION DATE

Conducted Emissions

| Instrument | Manufacturer | Type No. | Serial No. | Cali. Interval | Cali. Due Date |
|-----------------------------|--------------|----------|------------|----------------|----------------|
| EMI Test Receiver | R&S | ESR7 | 101209 | 1 year | 2015/11/07 |
| Two-Line V-Network | R&S | ENV216 | 101683 | 1 year | 2015/11/07 |
| Two-Line V-Network | R&S | ENV216 | 101684 | 1 year | 2015/11/07 |
| Temperature/ Meter Humidity | Anymetre | TH101B | SR2-01 | 1 year | 2015/11/14 |

Radiated Emission

| Instrument | Manufacturer | Type No. | Serial No. | Cali. Interval | Cali. Due Date |
|----------------------------|--------------|-----------|------------|----------------|----------------|
| Spectrum Analyzer | Agilent | N9020A | MY52090106 | 1 year | 2015/04/23 |
| Preamplifier | MRT | AP01G18 | 1310002 | 1 year | 2015/10/06 |
| Loop Antenna | Schwarzbeck | FMZB1519 | 1519-041 | 1 year | 2015/11/08 |
| TRILOG Antenna | Schwarzbeck | VULB9162 | 9162-047 | 1 year | 2015/11/08 |
| Broad-Band Horn Antenna | Schwarzbeck | BBHA9120D | 9120D-1167 | 1 year | 2015/11/08 |
| Broadband Horn Antenna | Schwarzbeck | BBHA9170 | 9170-549 | 1 year | 2015/12/12 |
| Temperature/Humidity Meter | Anymetre | TH101B | AC1-01 | 1 year | 2015/11/14 |

Conducted Test Equipment

| Instrument | Manufacturer | Type No. | Serial No. | Cali. Interval | Cali. Due Date |
|----------------------------|--------------|----------|------------|----------------|----------------|
| Spectrum Analyzer | Agilent | N9020A | MY52090106 | 1 year | 2015/04/23 |
| Power Sensor | Agilent | U2021XA | MY52450003 | 1 year | 2015/12/09 |
| Temperature/Humidity Meter | Anymetre | TH101B | TR3-01 | 1 year | 2015/11/14 |

6. MEASUREMENT UNCERTAINTY

Where relevant, the following test uncertainty levels have been estimated for tests performed on the EUT as specified in CISPR 16-4-2. This uncertainty represents an expanded uncertainty expressed at approximately the 95% confidence level using a coverage factor of $k = 2$.

| |
|---|
| AC Conducted Emission Measurement |
| Measuring Uncertainty for a Level of Confidence of 95% ($U=2Uc(y)$): 150kHz~30MHz: $\pm 3.46\text{dB}$ |
| Radiated Emission Measurement |
| Measuring Uncertainty for a Level of Confidence of 95% ($U=2Uc(y)$): 9kHz ~ 1GHz: $\pm 4.18\text{dB}$ 1GHz ~ 25GHz: $\pm 4.76\text{dB}$ |

7. TEST RESULT

7.1. Summary

Product Name: 9.6 Inch Tablet
FCC ID: 2AAMSHM-9641M
FCC Classification: Digital Transmission System (DTS)
Data Rate(s) Tested: 1Mbps(GFSK) (BLE)

| FCC Part Section(s) | Test Description | Test Limit | Test Condition | Test Result | Reference |
|---------------------|---|--|----------------|-------------|-------------------|
| 15.247(a)(2) | 6dB Bandwidth | $\geq 500\text{kHz}$ | Conducted | Pass | Section 7.2 |
| 15.247(b)(3) | Output Power | $\leq 1\text{Watt}$ | | Pass | Section 7.3 |
| 15.247(e) | Power Spectral Density | $\leq 8\text{dBm} / 3\text{kHz Band}$ | | Pass | Section 7.4 |
| 15.247(d) | Band Edge / Out-of-Band Emissions | $\geq 20\text{dBc(Peak)}$ | | Pass | Section 7.5 |
| 15.205 15.209 | General Field Strength Limits (Restricted Bands and Radiated Emission Limits) | Emissions in restricted bands must meet the radiated limits detailed in 15.209 | Radiated | Pass | Section 7.6 & 7.7 |
| 15.207 | AC Conducted Emissions 150kHz - 30MHz | $< \text{FCC } 15.207 \text{ limits}$ | Line Conducted | Pass | Section 7.8 |

Notes:

- 1) All modes of operation and data rates were investigated. For radiated emission test, every axis (X, Y, Z) was also verified. The test results shown in the following sections represent the worst case emissions.
- 2) The analyzer plots shown in this section were all taken with a correction table loaded into the analyzer. The correction table was used to account for the losses of the cables and attenuators used as part of the system to connect the EUT to the analyzer at all frequencies of interest.
- 3) All antenna port conducted emissions testing was performed on a test bench with the antenna port of the EUT connected to the spectrum analyzer through calibrated cables and attenuators.

7.2. 6dB Bandwidth Measurement

7.2.1. Test Limit

The minimum 6dB bandwidth shall be at least 500 kHz.

7.2.2. Test Procedure used

KDB 558074 D01v03r02 - Section 8.2 Option 2

7.2.3. Test Setting

1. The Spectrum's automatic bandwidth measurement capability was used to perform the 6dB bandwidth measurement. The "X" dB bandwidth parameter was set to $X = 6$. The bandwidth measurement was not influenced by any intermediate power nulls in the fundamental emission.
2. Set RBW = 100 kHz
3. VBW $\geq 3 \times$ RBW
4. Detector = Peak
5. Trace mode = max hold
6. Sweep = auto couple
7. Allow the trace was allowed to stabilize

7.2.4. Test Setup

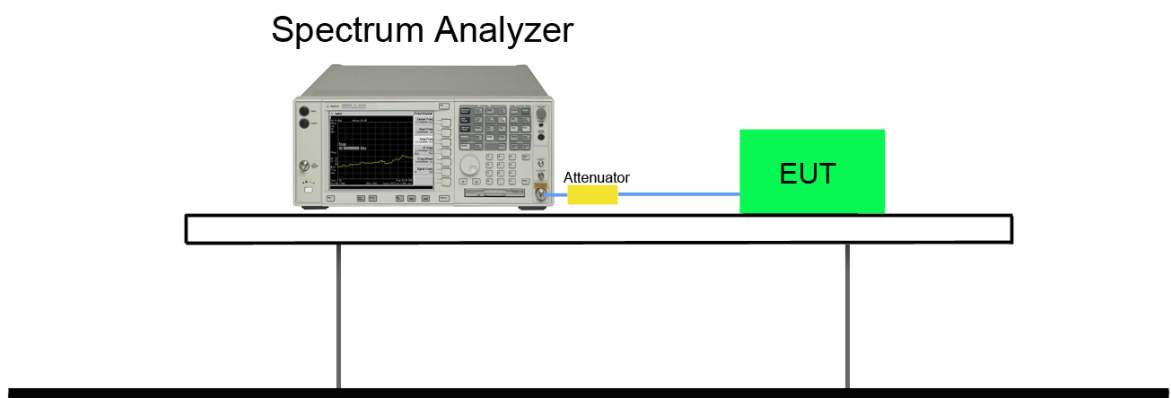

7.2.5. Test Result

| Test Mode | Data Rate (Mbps) | Channel No. | Frequency (MHz) | 6dB Bandwidth (MHz) | Limit (MHz) | Result |
|-----------|------------------|-------------|-----------------|---------------------|-------------|--------|
| BLE | 1 | 00 | 2402 | 0.696 | ≥ 0.5 | Pass |
| BLE | 1 | 19 | 2440 | 0.699 | ≥ 0.5 | Pass |
| BLE | 1 | 39 | 2480 | 0.699 | ≥ 0.5 | Pass |

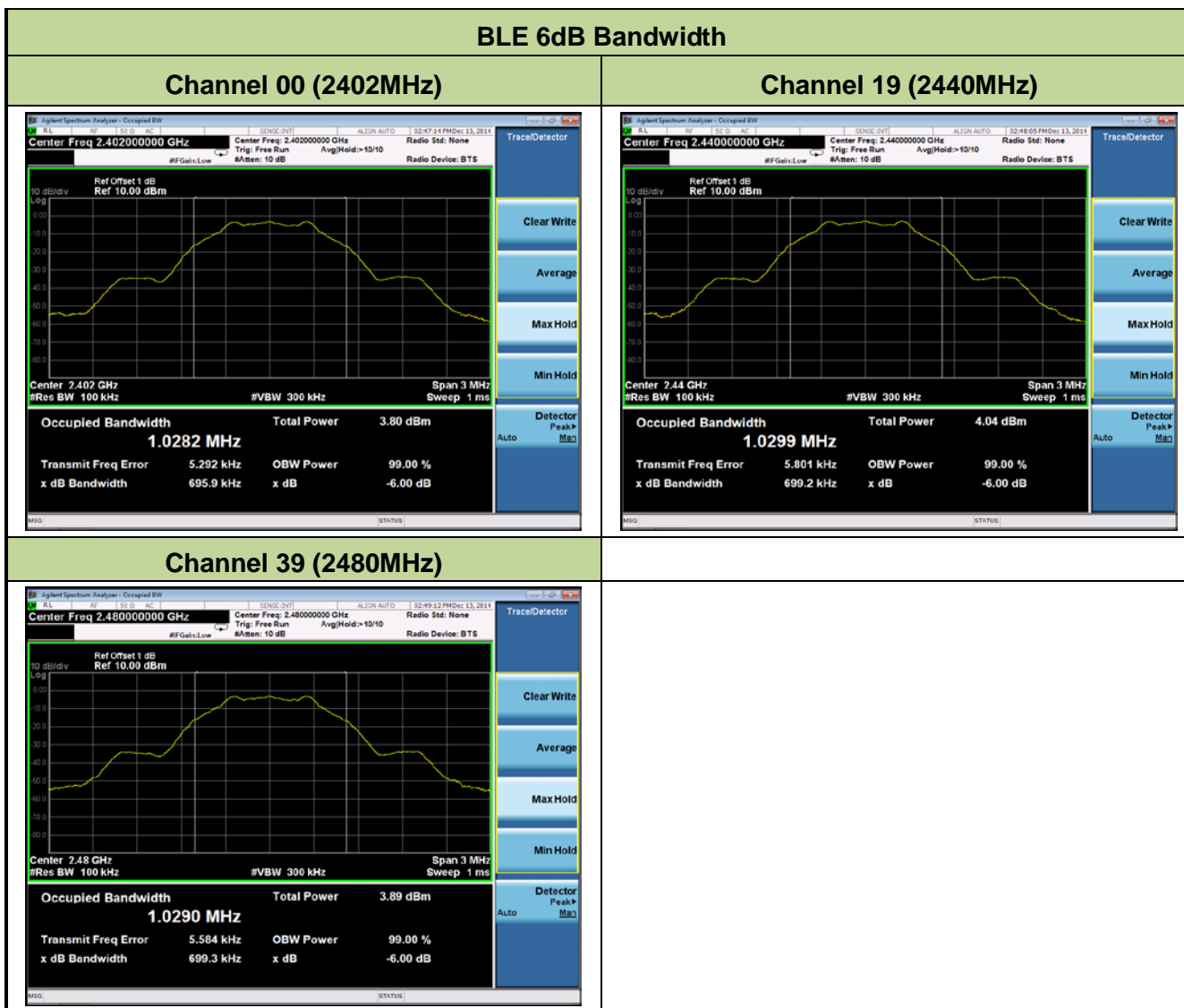

7.3. Output Power Measurement

7.3.1. Test Limit

The maximum out power shall be less 1 Watt (30dBm).

7.3.2. Test Procedure Used

KDB 558074 D01v03r02 - Section 9.1.2 PKPM1 Peak Power Method (for signals with BW \leq 50MHz)

7.3.3. Test Setting

Method PKPM1 (Peak Power Measurement of Signals with DTS BW \leq 50MHz)

Peak power measurements were performed only when the EUT was transmitting at its maximum power control level using a broadband power meter with a pulse sensor. The pulse sensor employs a VBW = 50MHz so this method was only used for signals whose DTS bandwidth was less than or equal to 50MHz.

7.3.4. Test Setup

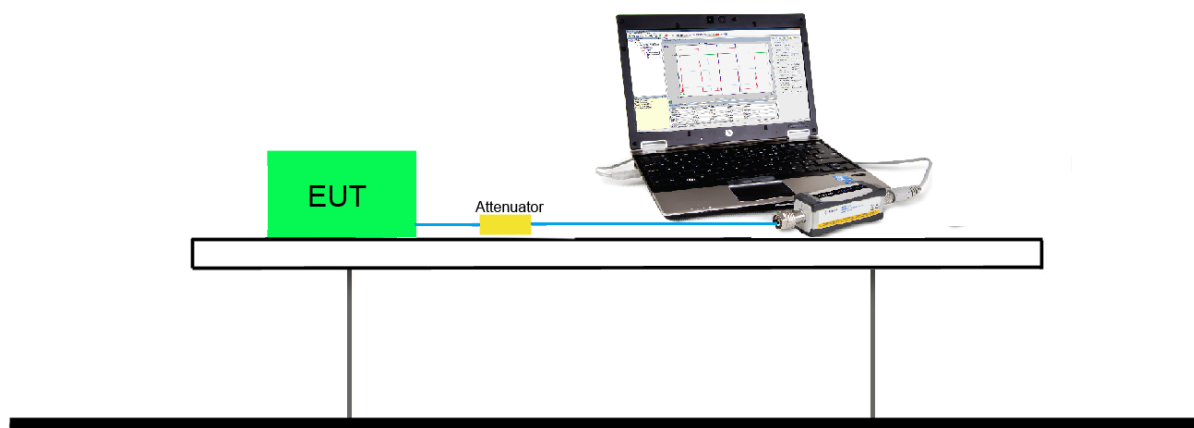

7.3.5. Test Result of Output Power

Test Result of Peak Output Power

| Test Mode | Data Rate (Mbps) | Channel No. | Frequency (MHz) | Peak Power (dBm) | Limit (dBm) | Result |
|-----------|------------------|-------------|-----------------|------------------|-------------|--------|
| BLE | 1 | 00 | 2402 | -2.21 | ≤ 30 | Pass |
| BLE | 1 | 19 | 2440 | -2.03 | ≤ 30 | Pass |
| BLE | 1 | 39 | 2480 | -2.36 | ≤ 30 | Pass |

7.4. Power Spectral Density Measurement

7.4.1. Test Limit

The maximum permissible power spectral density is 8dBm in any 3 kHz band.

7.4.2. Test Procedure Used

KDB 558074 D01v03r02 - Section 10.2 Method PKPSD

7.4.3. Test Setting

1. Analyzer was set to the center frequency of the DTS channel under investigation
2. Span = 1.5 times the DTS channel bandwidth
3. RBW = 3kHz
4. VBW = 10kHz
5. Detector = peak
6. Sweep time = auto couple
7. Trace mode = max hold
8. Trace was allowed to stabilize

7.4.4. Test Setup

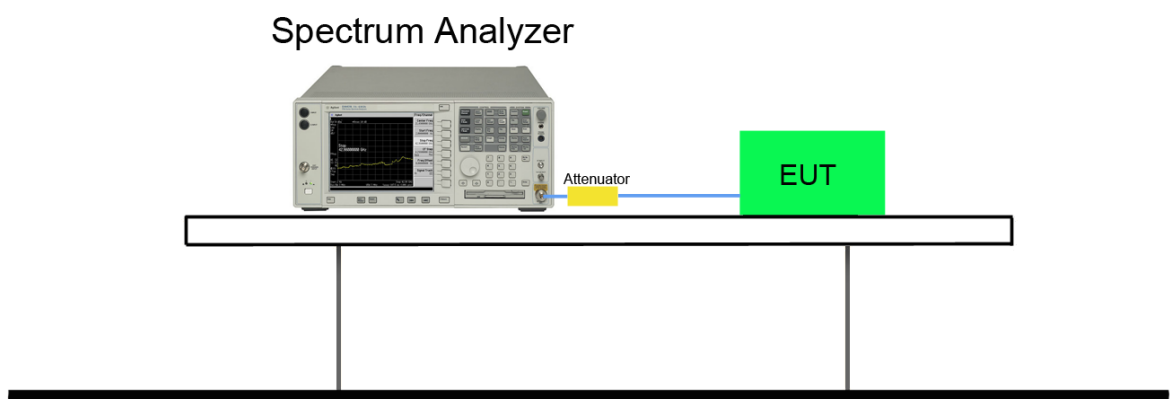

7.4.5. Test Result

| Test Mode | Data Rate (Mbps) | Channel No. | Frequency (MHz) | PSD Result (dBm / 3kHz) | Limit (dBm / 3kHz) | Result |
|-----------|------------------|-------------|-----------------|-------------------------|--------------------|--------|
| BLE | 1 | 00 | 2402 | -17.97 | ≤ 8 | Pass |
| BLE | 1 | 19 | 2440 | -17.73 | ≤ 8 | Pass |
| BLE | 1 | 39 | 2480 | -17.89 | ≤ 8 | Pass |

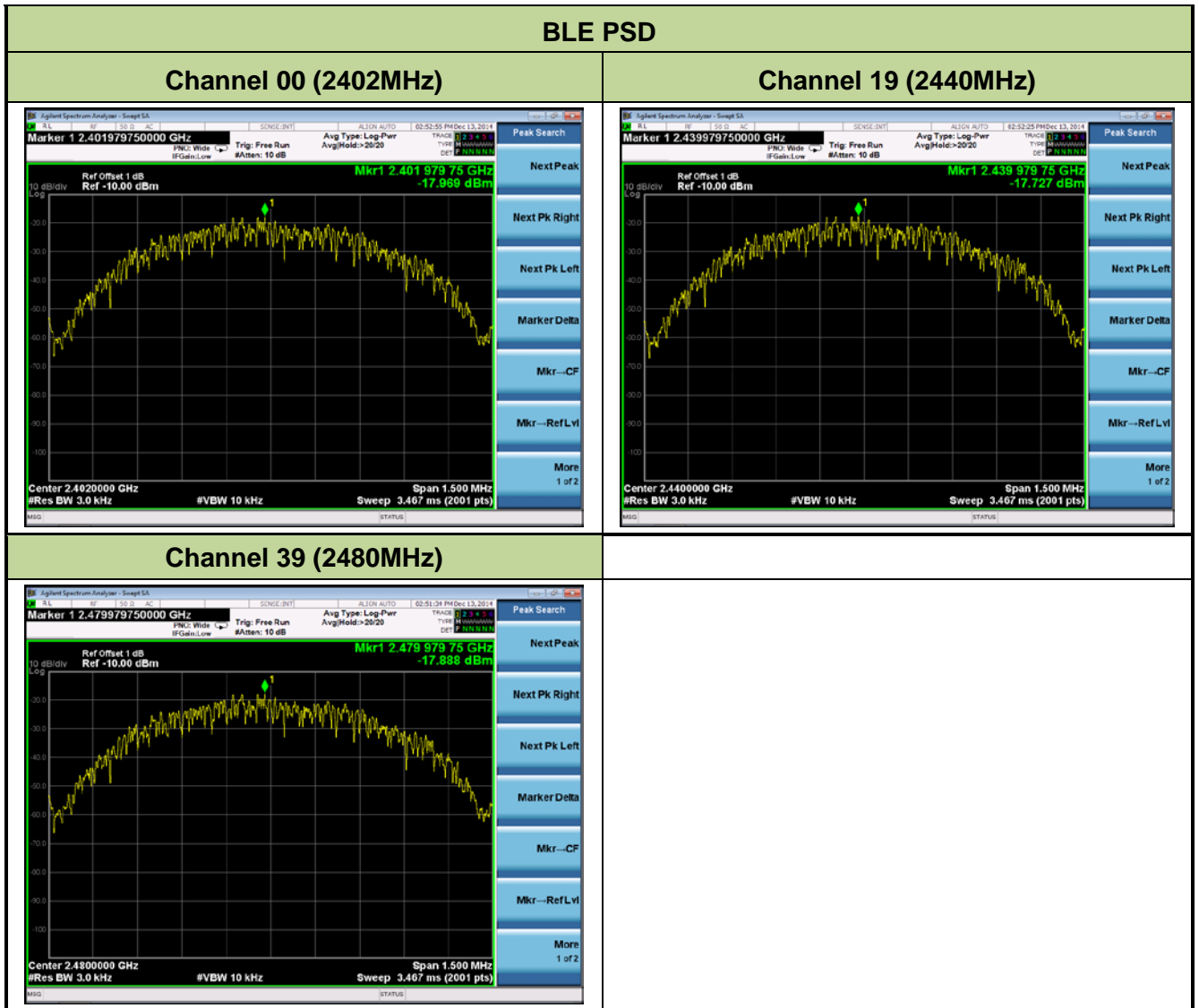

7.5. Conducted Band Edge and Out-of-Band Emissions

7.5.1. Test Limit

The limit for out-of-band spurious emissions at the band edge is 20dB below the fundamental emission level, as determined from the in-band power measurement of the DTS channel performed in a 100kHz bandwidth per the PSD procedure (Section 9.1).

7.5.2. Test Procedure Used

KDB 558074 D01v03r02 - Section 11.2 & Section 11.3

7.5.3. Test Setting

1. Reference level measurement

- (a) Set instrument center frequency to DTS channel center frequency
- (b) Set the span to ≥ 1.5 times the DTS bandwidth
- (c) Set the RBW = 100 kHz
- (d) Set the VBW $\geq 3 \times$ RBW
- (e) Detector = peak
- (f) Sweep time = auto couple
- (g) Trace mode = max hold
- (h) Allow trace to fully stabilize

2. Emission level measurement

- (a) Set the center frequency and span to encompass frequency range to be measured
- (b) RBW = 100kHz
- (c) VBW = 300kHz
- (d) Detector = Peak
- (e) Number of sweep points $\geq 2 \times$ Span/RBW
- (f) Trace mode = max hold
- (g) Sweep time = auto couple

(h) The trace was allowed to stabilize

7.5.4. Test Setup

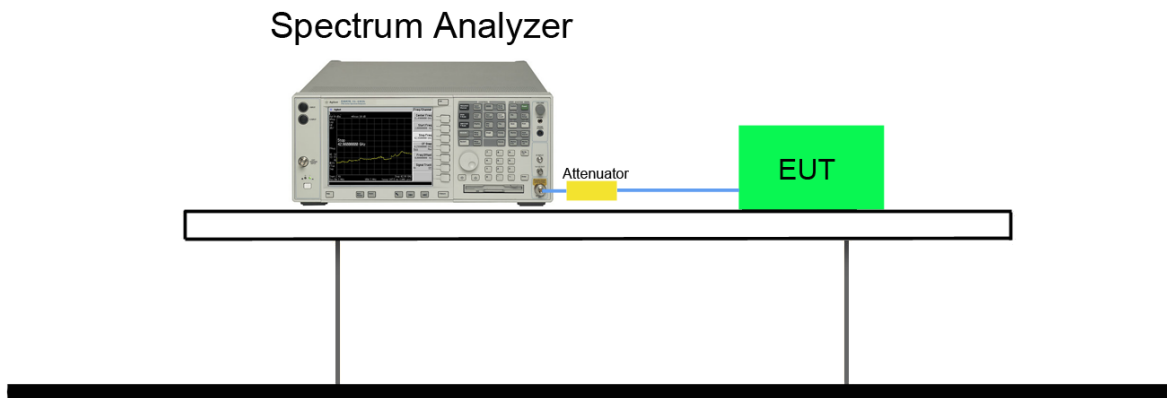

7.5.5. Test Result

| Test Mode | Data Rate (Mbps) | Channel No. | Frequency (MHz) | Limit | Result |
|-----------|------------------|-------------|-----------------|-------|--------|
| BLE | 1 | 00 | 2402 | 20dBc | Pass |
| BLE | 1 | 19 | 2440 | 20dBc | Pass |
| BLE | 1 | 39 | 2480 | 20dBc | Pass |

BLE Out-of-Band Emissions

Channel 00 (2402MHz)

100kHz PSD reference Level



Low Band Edge

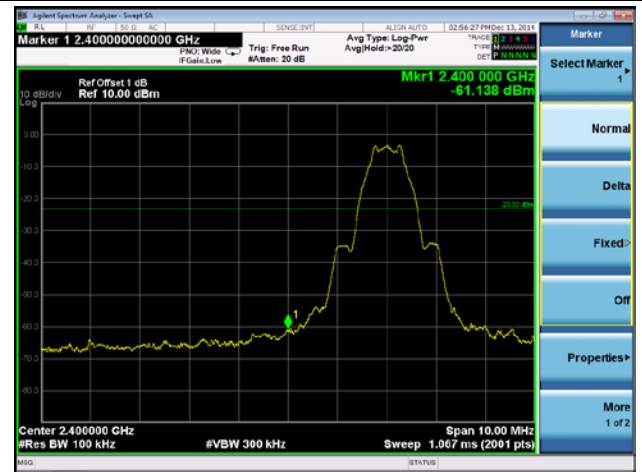

Spurious Emission 30MHz ~ 25GHz

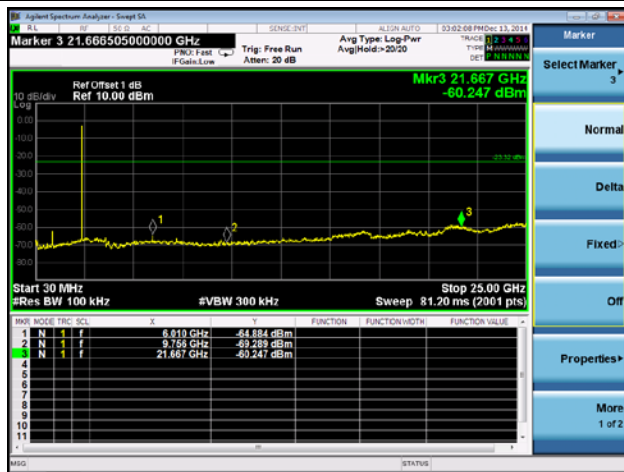

Channel 19 (2440MHz)

100kHz PSD reference Level

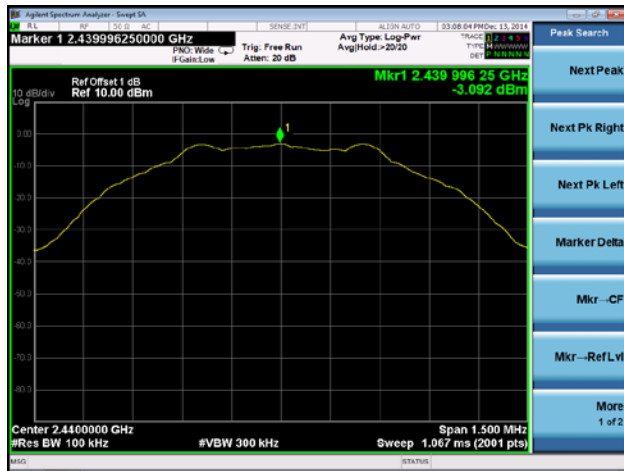

Spurious Emission 30MHz ~ 25GHz

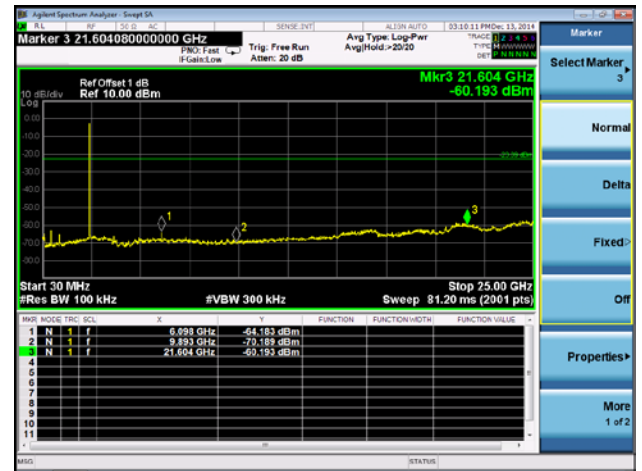

Channel 39 (2480MHz)

100kHz PSD reference Level



High Band Edge

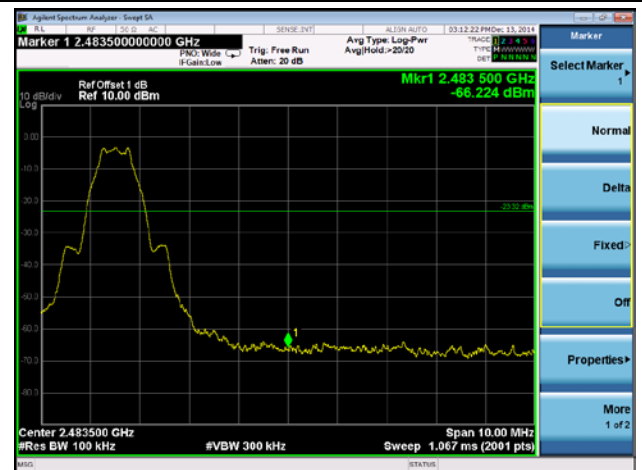

Spurious Emission 30MHz ~ 25GHz

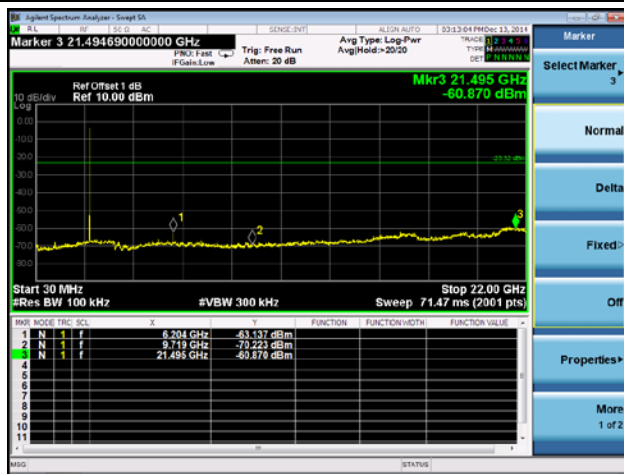

7.6. Radiated Spurious Emission Measurement

7.6.1. Test Limit

All out of band emissions appearing in a restricted band as specified in Section 15.205 of the Title 47 CFR must not exceed the limits shown in Table per Section 15.209.

| FCC Part 15 Subpart C Paragraph 15.209 | | |
|--|----------------------|----------------------------|
| Frequency [MHz] | Field Strength [V/m] | Measured Distance [Meters] |
| 0.009 – 0.490 | 2400/F (kHz) | 300 |
| 0.490 – 1.705 | 24000/F (kHz) | 30 |
| 1.705 - 30 | 30 | 30 |
| 30 - 88 | 100 | 3 |
| 88 - 216 | 150 | 3 |
| 216 - 960 | 200 | 3 |
| Above 960 | 500 | 3 |

7.6.2. Test Procedure Used

KDB 558074 D01v03r02 – Section 12.2.3 (quasi-peak measurements)

KDB 558074 D01v03r02 – Section 12.2.4 (peak power measurements)

KDB 558074 D01v03r02 – Section 12.2.5 (average power measurements)

7.6.3. Test Setting

Peak Field Strength Measurements per Section 12.2.4 of KDB 558074 D01v03r02

1. Analyzer center frequency was set to the frequency of the radiated spurious emission of interest
2. RBW = as specified in Table 1
3. VBW = 3MHz
4. Detector = peak
5. Sweep time = auto couple

6. Trace mode = max hold

7. Trace was allowed to stabilize

Table 1—RBW as a function of frequency

| Frequency | RBW |
|---------------|---------------|
| 9 ~ 150 kHz | 200 ~ 300 Hz |
| 0.15 ~ 30 MHz | 9 ~ 10 kHz |
| 30 ~ 1000 MHz | 100 ~ 120 kHz |
| > 1000 MHz | 1 MHz |

Average Field Strength Measurements per Section 12.2.5.1 of KDB 558074 D01v03r02

1. RBW = 1MHz.

2. VBW \geq 3 x RBW.

3. Detector = RMS, if span/(# of points in sweep) \leq (RBW/2). Satisfying this condition may require increasing the number of points in the sweep or reducing the span. If this condition cannot be satisfied, then the detector mode shall be set to peak.

4. Averaging type = power (*i.e.*, RMS).

- As an alternative, the detector and averaging type may be set for linear voltage averaging.
- Some instruments require linear display mode in order to use linear voltage averaging. Log or dB averaging shall not be used.

5. Sweep time = auto.

6. Perform a trace average of at least 100 traces.

7.6.4. Test Setup

9kHz ~ 30MHz Test Setup:

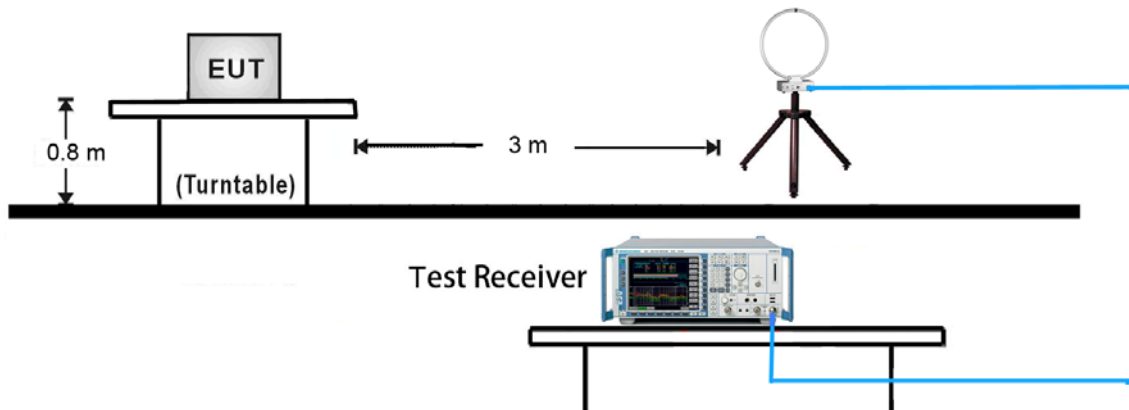

30MHz ~ 1GHz Test Setup:

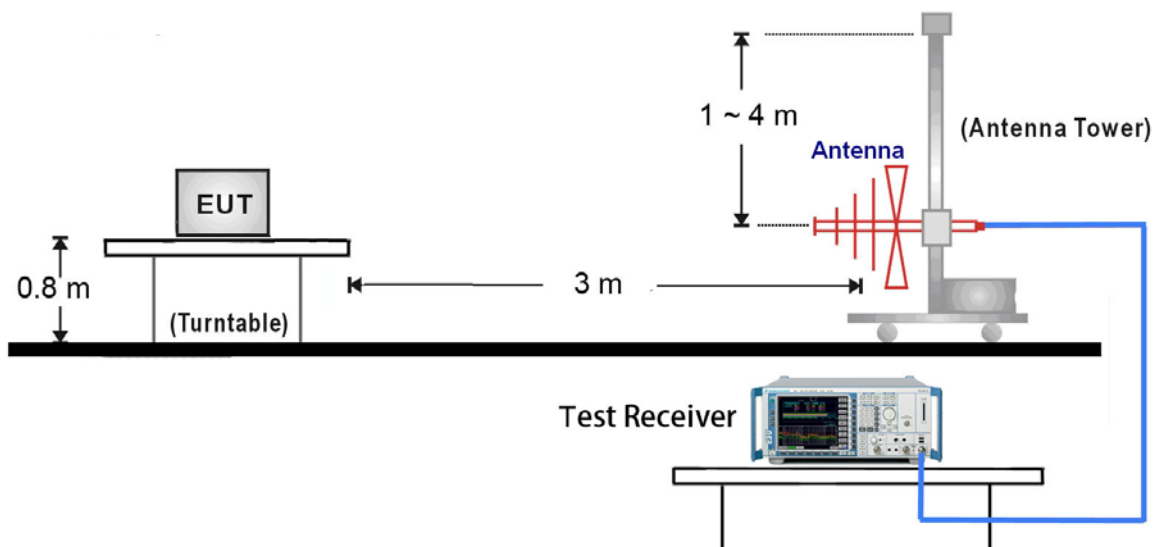

1GHz ~ 25GHz Test Setup:

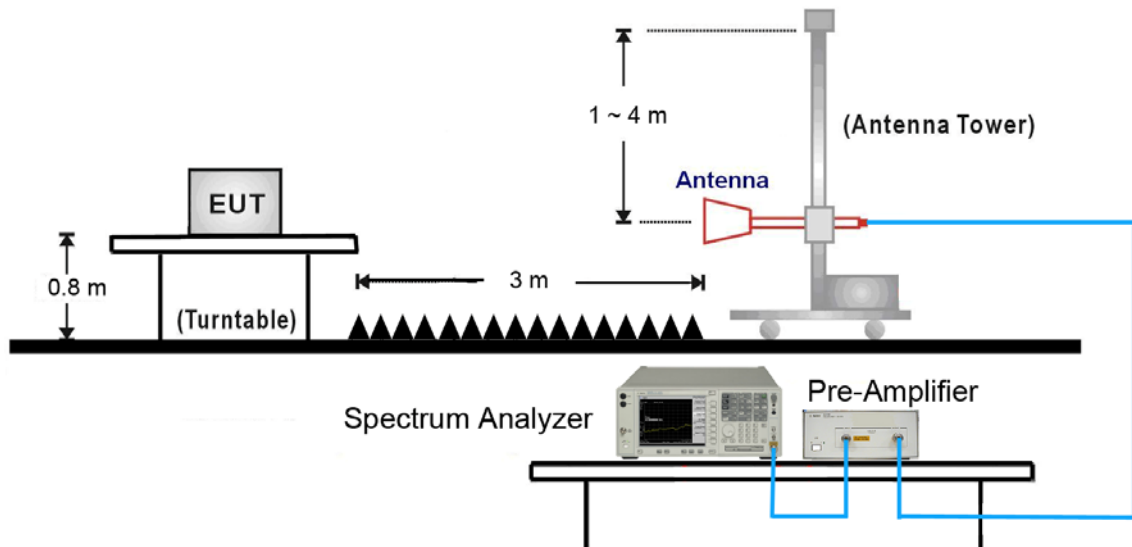

7.6.5. Test Result

| | | | |
|---------------|--|----------------|-----------|
| Test Mode: | BLE | Test Site: | AC1 |
| Test Channel: | 00 | Test Engineer: | Knight Lu |
| Remark: | 1. Average measurement was not performed if peak level lower than average limit. 2. The worst case of Radiated Spurious Emission. 3. Other frequency was 20dB below limit line within 1-18GHz, there is not show in the report. | | |

| Mark | Frequency (MHz) | Reading Level (dBμV) | Factor (dB) | Measure Level (dBμV/m) | Limit (dBμV/m) | Margin (dB) | Detector | Polarization |
|------|-----------------|----------------------|-------------|------------------------|----------------|-------------|----------|--------------|
| * | 3165.0 | 37.1 | 5.0 | 42.1 | 74.0 | -31.9 | Peak | Horizontal |
| * | 4487.0 | 36.6 | 7.1 | 43.7 | 74.0 | -30.3 | Peak | Horizontal |
| | 4804.0 | 43.5 | 1.9 | 45.4 | 74.0 | -28.6 | Peak | Horizontal |
| | 7529.0 | 43.1 | 8.8 | 51.9 | 74.0 | -22.1 | Peak | Horizontal |
| * | 3206.0 | 36.6 | 5.0 | 41.6 | 74.0 | -32.4 | Peak | Vertical |
| * | 4461.0 | 37.9 | 7.0 | 44.9 | 74.0 | -29.1 | Peak | Vertical |
| | 4804.0 | 42.5 | 1.9 | 44.4 | 74.0 | -29.6 | Peak | Vertical |
| | 7526.0 | 42.3 | 8.8 | 51.1 | 74.0 | -22.9 | Peak | Vertical |

Note 1: "*" is not in restricted band, its limit is 20dBc of the fundamental emission level (88.9dBμV/m) or 15.209 which is higher.

Note 2: Measure Level (dBμV/m) = Reading Level (dBμV) + Factor (dB)

Factor (dB) = Cable Loss (dB) + Antenna Factor (dB/m) - Pre_Amplifier Gain (dB)

The worst case of Radiated Emission below 1GHz:

| | |
|------------------------------|--------------------------|
| Site: AC1 | Time: 2014/12/14 - 11:07 |
| Limit: FCC_Part15.209_RE(3m) | Engineer: Knight Lu |
| Probe: VULB9162_0.03-8GHz | Polarity: Horizontal |
| EUT: 9.6 Inch Tablet | Power: By Battery |

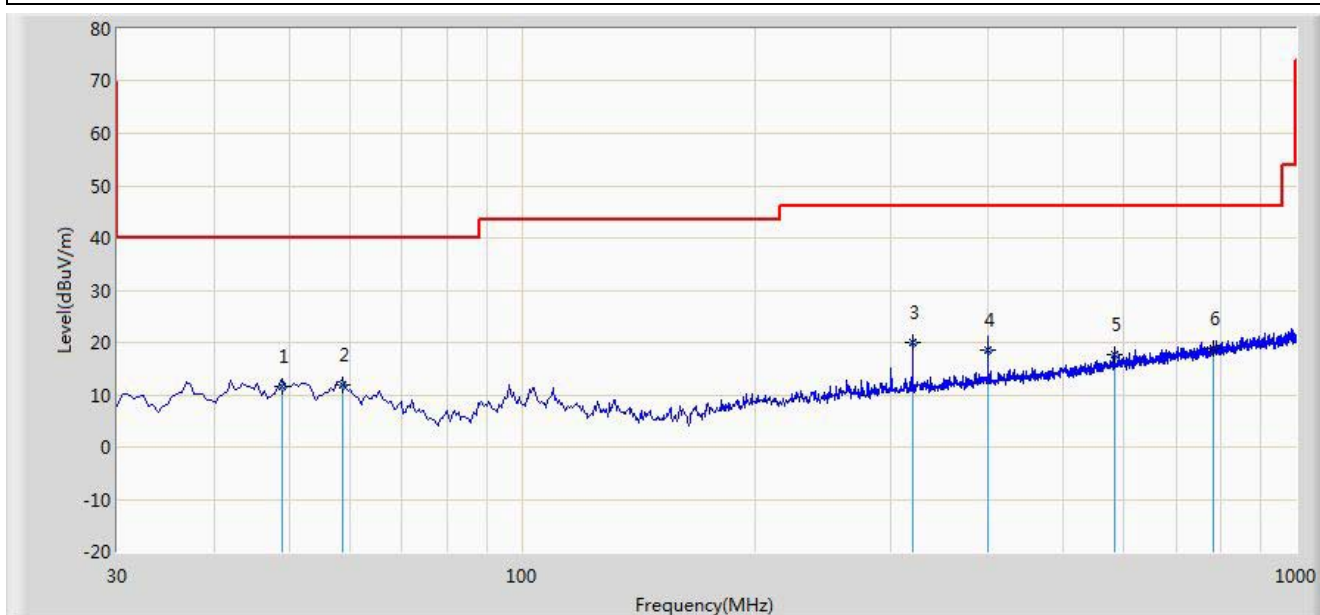
Worse Case Mode: BLE at channel 2402MHz

| No | Flag | Mark | Frequency (MHz) | Measure Level (dBuV/m) | Reading Level (dBuV) | Over Limit (dB) | Limit (dBuV/m) | Factor (dB) | Type |
|----|------|------|-----------------|------------------------|----------------------|-----------------|----------------|-------------|------|
| 1 | | | 48.915 | 11.691 | 28.036 | -28.309 | 40.000 | -16.345 | QP |
| 2 | | | 58.615 | 11.825 | 29.004 | -28.175 | 40.000 | -17.178 | QP |
| 3 | | * | 320.030 | 19.967 | 36.415 | -26.033 | 46.000 | -16.448 | QP |
| 4 | | | 400.055 | 18.449 | 33.298 | -27.551 | 46.000 | -14.849 | QP |
| 5 | | | 582.415 | 17.690 | 29.518 | -28.310 | 46.000 | -11.828 | QP |
| 6 | | | 783.205 | 18.911 | 27.926 | -27.089 | 46.000 | -9.015 | QP |

Note: Measure Level (dBμV/m) = Reading Level (dBμV) + Factor (dB)

Factor (dB) = Cable Loss (dB) + Antenna Factor (dB/m)

| | |
|--|--------------------------|
| Site: AC1 | Time: 2014/12/14 - 11:08 |
| Limit: FCC_Part15.209_RE(3m) | Engineer: Knight Lu |
| Probe: VULB9162_0.03-8GHz | Polarity: Vertical |
| EUT: 9.6 Inch Tablet | Power: By Battery |
| Worse Case Mode: BLE at channel 2402MHz | |

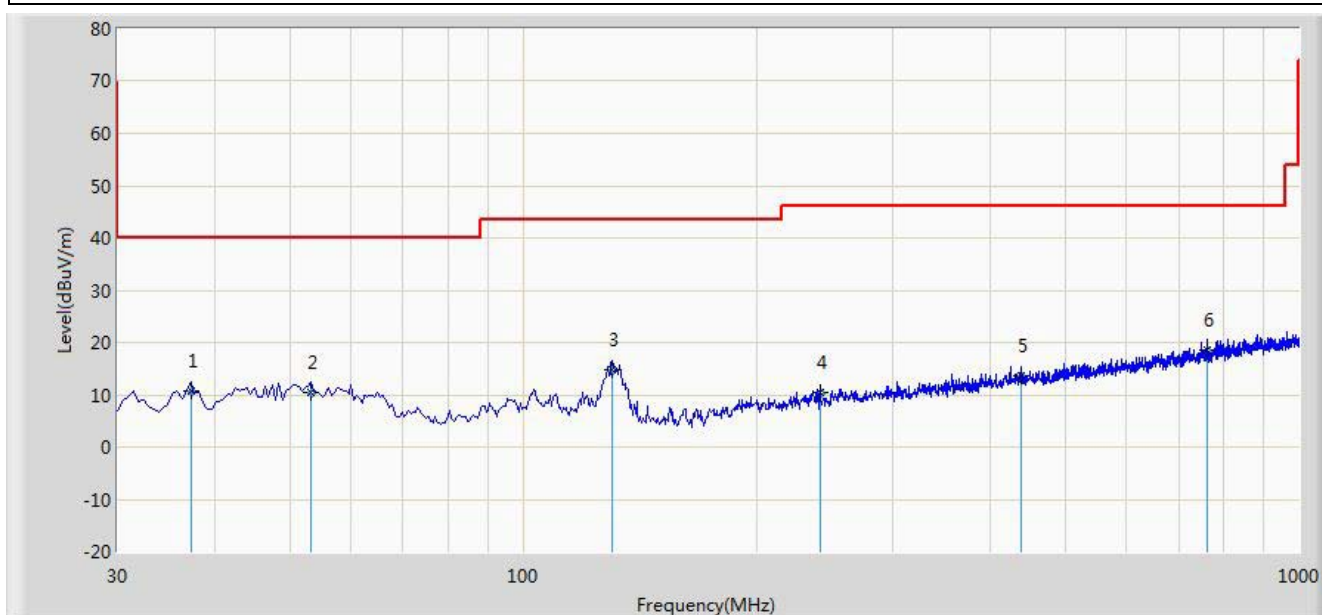

| No | Flag | Mark | Frequency (MHz) | Measure Level (dBuV/m) | Reading Level (dBuV) | Over Limit (dB) | Limit (dBuV/m) | Factor (dB) | Type |
|----|------|------|-----------------|------------------------|----------------------|-----------------|----------------|-------------|------|
| 1 | | | 37.275 | 10.839 | 28.923 | -29.161 | 40.000 | -18.083 | QP |
| 2 | | | 53.280 | 10.552 | 26.946 | -29.448 | 40.000 | -16.394 | QP |
| 3 | | | 130.395 | 14.826 | 36.189 | -28.674 | 43.500 | -21.362 | QP |
| 4 | | | 241.460 | 10.547 | 28.603 | -35.453 | 46.000 | -18.056 | QP |
| 5 | | | 439.340 | 13.487 | 27.859 | -32.513 | 46.000 | -14.373 | QP |
| 6 | | * | 761.865 | 18.629 | 27.926 | -27.371 | 46.000 | -9.297 | QP |

Note: Measure Level (dBμV/m) = Reading Level (dBμV) + Factor (dB)

Factor (dB) = Cable Loss (dB) + Antenna Factor (dB/m)

| | |
|--|--------------------------|
| Site: AC1 | Time: 2014/12/13 - 15:32 |
| Limit: FCC_Part15.209_RE(3m) | Engineer: Knight Lu |
| Probe: FMZB1519_0.009-30MHz | Polarity: Face On |
| EUT: 9.6 Inch Tablet | Power: By Battery |
| Note: There is the ambient noise within frequency range 9kHz~30MHz. | |

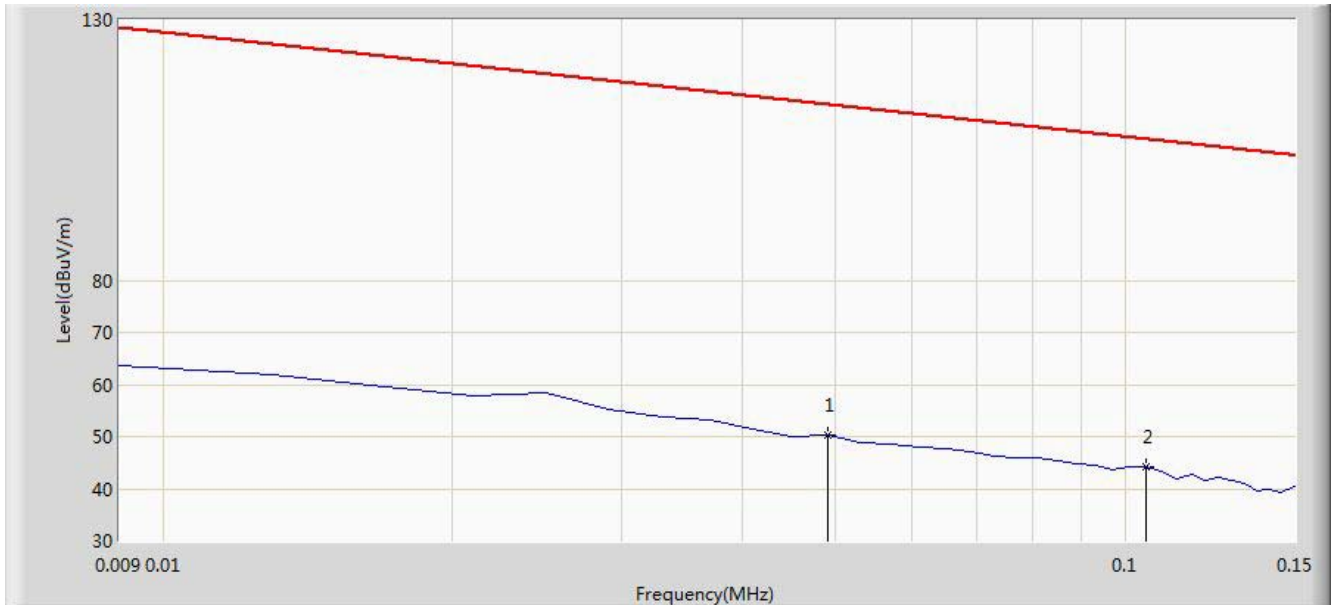

| No | Flag | Mark | Frequency (MHz) | Measure Level (dBuV/m) | Reading Level (dBuV) | Over Limit (dB) | Limit (dBuV/m) | Factor (dB) | Type |
|----|------|------|-----------------|------------------------|----------------------|-----------------|----------------|-------------|------|
| 1 | | | 0.049 | 50.367 | 29.861 | -63.788 | 114.155 | 20.505 | QP |
| 2 | | * | 0.105 | 44.143 | 23.996 | -63.392 | 107.535 | 20.147 | QP |

Note: Measure Level (dB μ V/m) = Reading Level (dB μ V) + Factor (dB)

Factor (dB) = Cable Loss (dB) + Antenna Factor (dB/m)

| | |
|--|--------------------------|
| Site: AC1 | Time: 2014/12/13 - 15:41 |
| Limit: FCC_Part15.209_RE(3m) | Engineer: Knight Lu |
| Probe: FMZB1519_0.009-30MHz | Polarity: Face On |
| EUT: 9.6 Inch Tablet | Power: By Battery |
| Note: There is the ambient noise within frequency range 9kHz~30MHz. | |

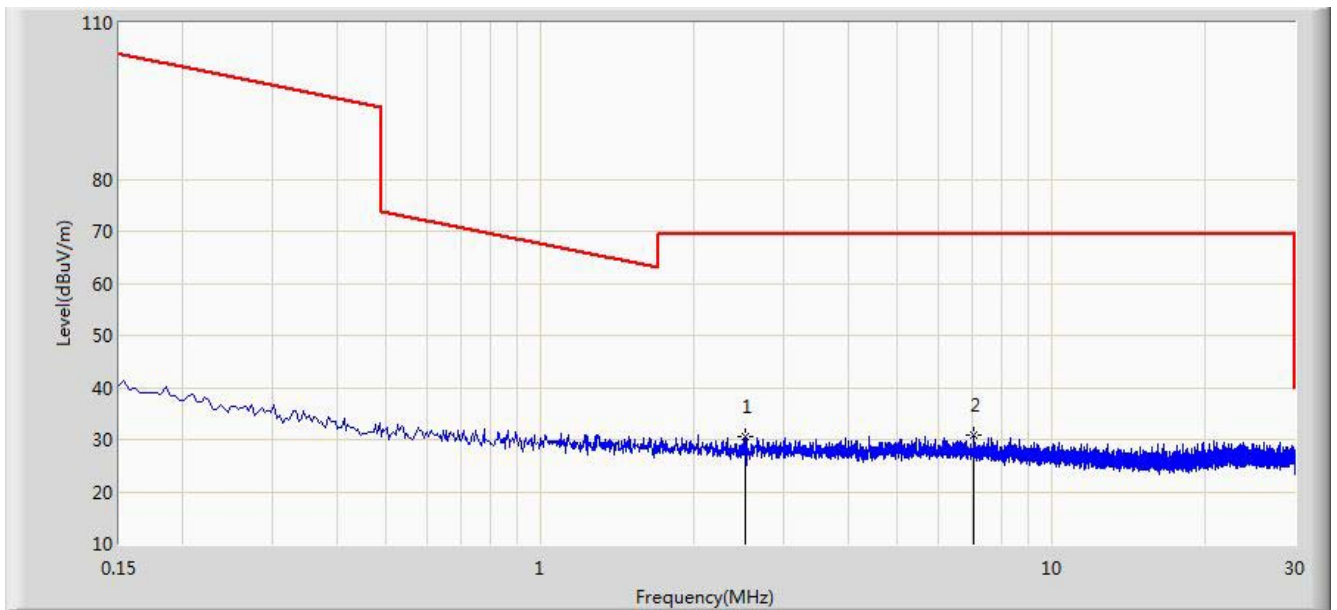

| No | Flag | Mark | Frequency (MHz) | Measure Level (dBuV/m) | Reading Level (dBuV) | Over Limit (dB) | Limit (dBuV/m) | Factor (dB) | Type |
|----|------|------|-----------------|------------------------|----------------------|-----------------|----------------|-------------|------|
| 1 | | | 2.513 | 30.495 | 10.336 | -39.005 | 69.500 | 20.159 | QP |
| 2 | | * | 7.041 | 30.974 | 10.579 | -38.526 | 69.500 | 20.395 | QP |

Note: Measure Level (dB μ V/m) = Reading Level (dB μ V) + Factor (dB)

Factor (dB) = Cable Loss (dB) + Antenna Factor (dB/m)

| | |
|--|--------------------------|
| Site: AC1 | Time: 2014/12/13 - 15:45 |
| Limit: FCC_Part15.209_RE(3m) | Engineer: Knight Lu |
| Probe: BBHA9170_18-40GHz | Polarity: Horizontal |
| EUT: 9.6 Inch Tablet | Power: By Battery |
| Note: There is the ambient noise within frequency range 18 ~ 25GHz. | |

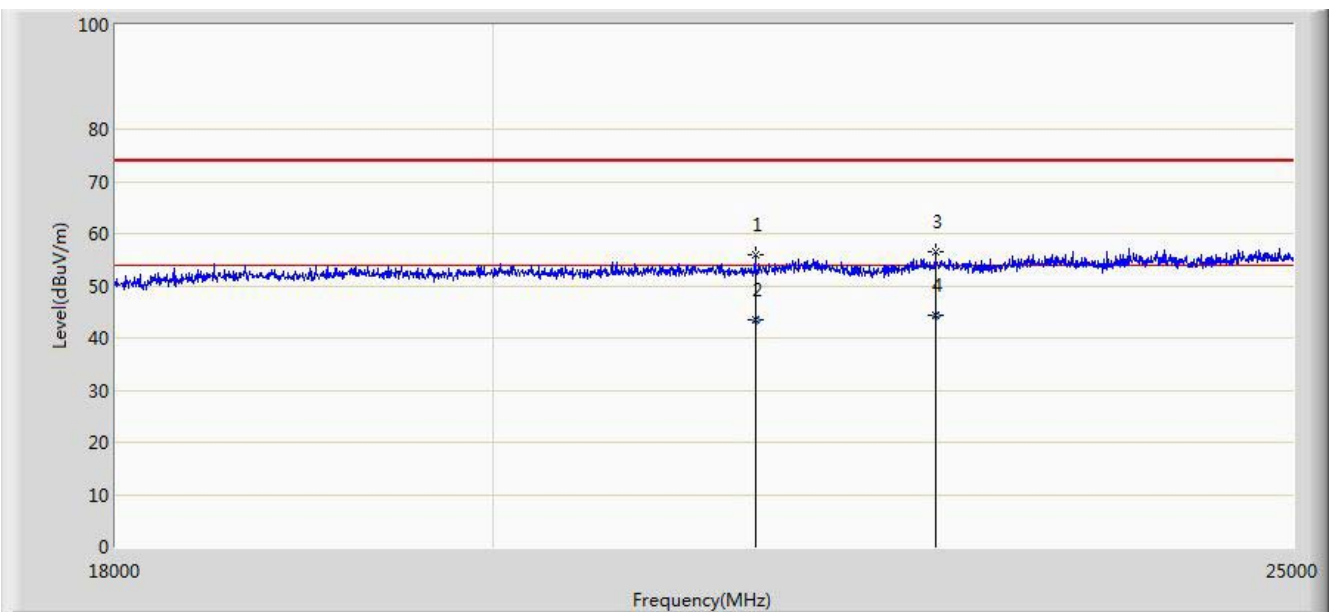

| No | Flag | Mark | Frequency (MHz) | Measure Level (dBuV/m) | Reading Level (dBuV) | Over Limit (dB) | Limit (dBuV/m) | Factor (dB) | Type |
|----|------|------|-----------------|------------------------|----------------------|-----------------|----------------|-------------|------|
| 1 | | | 21517.500 | 55.869 | 17.883 | -18.131 | 74.000 | 37.986 | PK |
| 2 | | | 21517.650 | 43.351 | 5.365 | -10.649 | 54.000 | 37.986 | AV |
| 3 | | | 22630.500 | 56.509 | 18.223 | -17.491 | 74.000 | 38.286 | PK |
| 4 | | * | 22630.540 | 44.310 | 6.024 | -9.690 | 54.000 | 38.286 | AV |

Note: Measure Level (dB μ V/m) = Reading Level (dB μ V) + Factor (dB)

Factor (dB) = Cable Loss (dB) + Antenna Factor (dB/m)

| | |
|--|--------------------------|
| Site: AC1 | Time: 2014/12/13 - 15:59 |
| Limit: FCC_Part15.209_RE(3m) | Engineer: Knight Lu |
| Probe: BBHA9170_18-40GHz | Polarity: Vertical |
| EUT: 9.6 Inch Tablet | Power: By Battery |
| Note: There is the ambient noise within frequency range 18 ~ 25GHz. | |

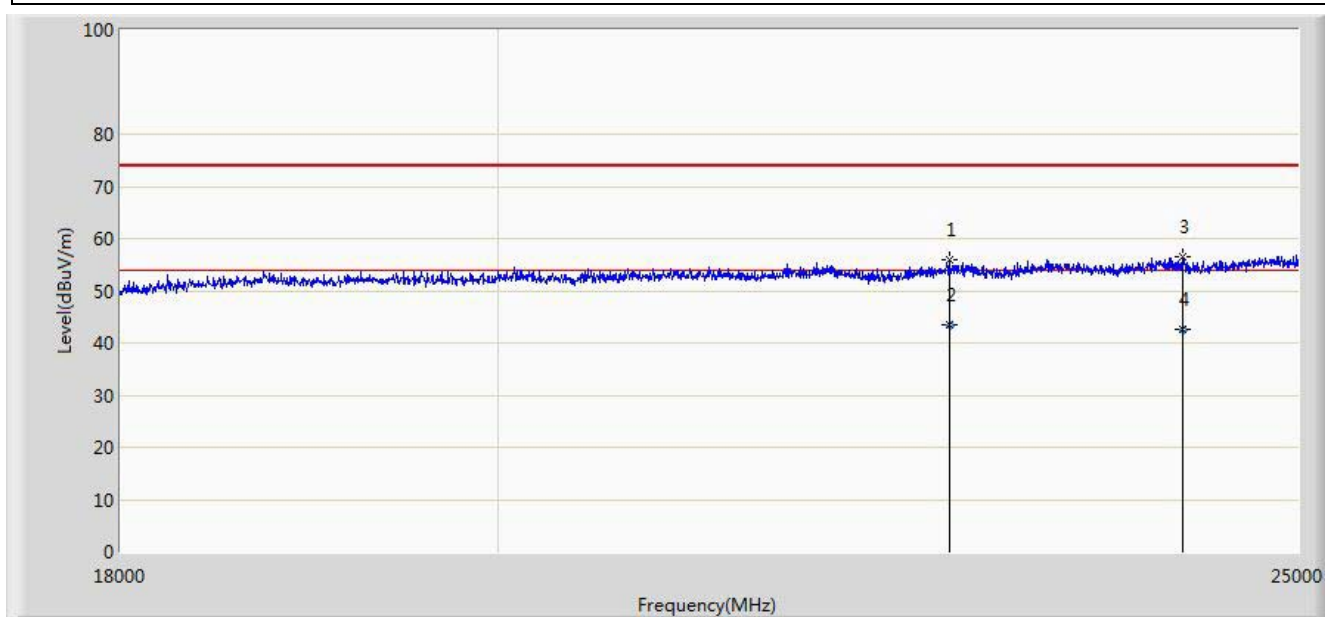

| No | Flag | Mark | Frequency (MHz) | Measure Level (dBuV/m) | Reading Level (dBuV) | Over Limit (dB) | Limit (dBuV/m) | Factor (dB) | Type |
|----|------|------|-----------------|------------------------|----------------------|-----------------|----------------|-------------|------|
| 1 | | | 22686.500 | 55.811 | 17.457 | -18.189 | 74.000 | 38.354 | PK |
| 2 | | * | 22686.540 | 43.598 | 5.244 | -10.402 | 54.000 | 38.354 | AV |
| 3 | | | 24205.500 | 56.430 | 17.607 | -17.570 | 74.000 | 38.823 | PK |
| 4 | | | 24205.658 | 42.518 | 3.695 | -11.482 | 54.000 | 38.823 | AV |

Note: Measure Level (dB μ V/m) = Reading Level (dB μ V) + Factor (dB)

Factor (dB) = Cable Loss (dB) + Antenna Factor (dB/m)

7.7. Radiated Restricted Band Edge Measurement

7.7.1. Test Result

| | |
|---|--------------------------|
| Site: AC1 | Time: 2014/12/15 - 15:25 |
| Limit: FCC_Part15.209_RE(3m) | Engineer: Knight Lu |
| Probe: BBHA9120D_1-18GHz | Polarity: Horizontal |
| EUT: 9.6 Inch Tablet | Power: By Battery |
| Worse Case Mode : BLE at channel 2402MHz | |

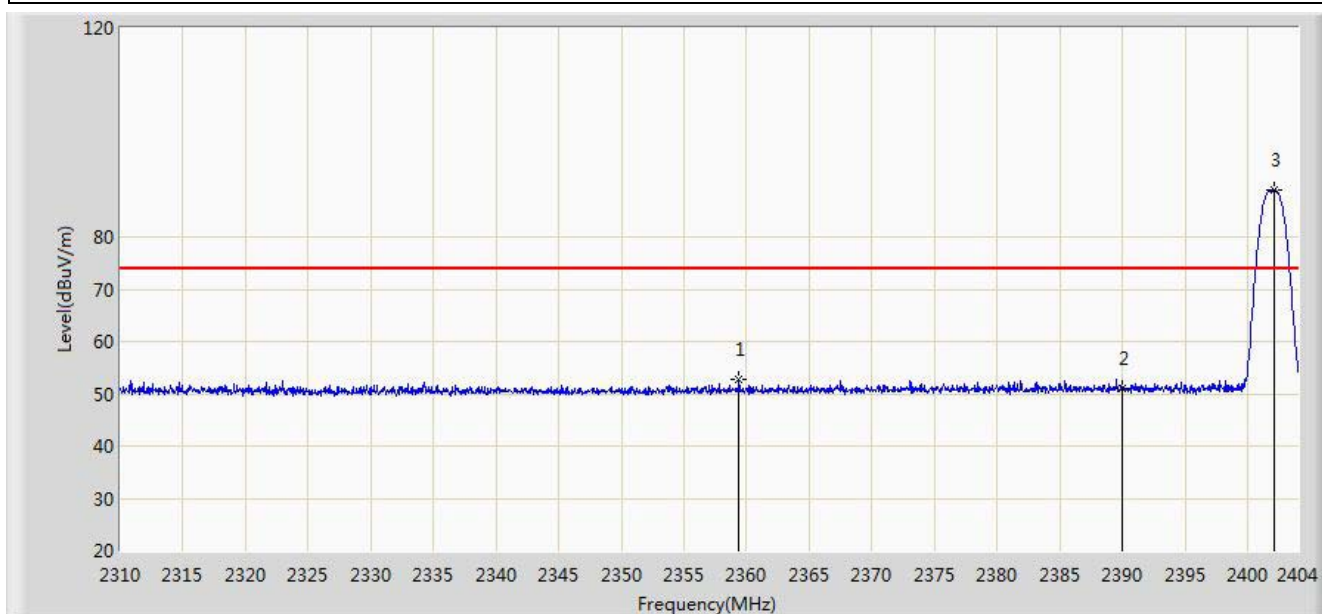

| No | Flag | Mark | Frequency (MHz) | Measure Level (dBuV/m) | Reading Level (dBuV) | Over Limit (dB) | Limit (dBuV/m) | Factor (dB) | Type |
|----|------|------|-----------------|------------------------|----------------------|-----------------|----------------|-------------|------|
| 1 | | | 2359.397 | 52.641 | 24.956 | -21.359 | 74.000 | 27.685 | PK |
| 2 | | | 2390.000 | 50.985 | 23.379 | -23.015 | 74.000 | 27.606 | PK |
| 3 | | * | 2402.073 | 88.870 | 61.295 | N/A | N/A | 27.575 | PK |

Note: Measure Level (dB μ V/m) = Reading Level (dB μ V) + Factor (dB)

Factor (dB) = Cable Loss (dB) + Antenna Factor (dB/m)

| | |
|---|--------------------------|
| Site: AC1 | Time: 2014/12/15 - 15:19 |
| Limit: FCC_Part15.209_RE(3m) | Engineer: Knight Lu |
| Probe: BBHA9120D_1-18GHz | Polarity: Horizontal |
| EUT: 9.6 Inch Tablet | Power: By Battery |
| Worse Case Mode : BLE at channel 2402MHz | |

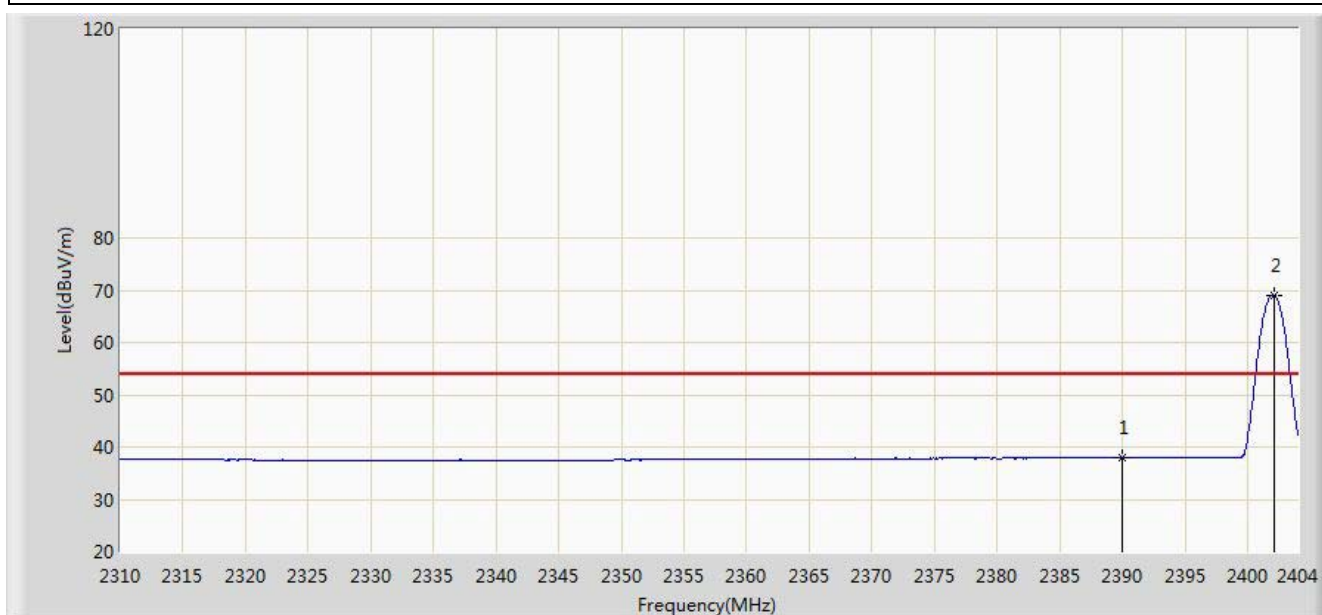

| No | Flag | Mark | Frequency (MHz) | Measure Level (dBuV/m) | Reading Level (dBuV) | Over Limit (dB) | Limit (dBuV/m) | Factor (dB) | Type |
|----|------|------|-----------------|------------------------|----------------------|-----------------|----------------|-------------|------|
| 1 | | | 2390.000 | 37.901 | 6.045 | -16.099 | 54.000 | 31.856 | AV |
| 2 | | * | 2402.073 | 69.104 | 37.268 | N/A | N/A | 31.836 | AV |

Note: Measure Level (dB μ V/m) = Reading Level (dB μ V) + Factor (dB)

Factor (dB) = Cable Loss (dB) + Antenna Factor (dB/m)

| | |
|---|--------------------------|
| Site: AC1 | Time: 2014/12/15 - 15:20 |
| Limit: FCC_Part15.209_RE(3m) | Engineer: Knight Lu |
| Probe: BBHA9120D_1-18GHz | Polarity: Vertical |
| EUT: 9.6 Inch Tablet | Power: By Battery |
| Worse Case Mode : BLE at channel 2402MHz | |

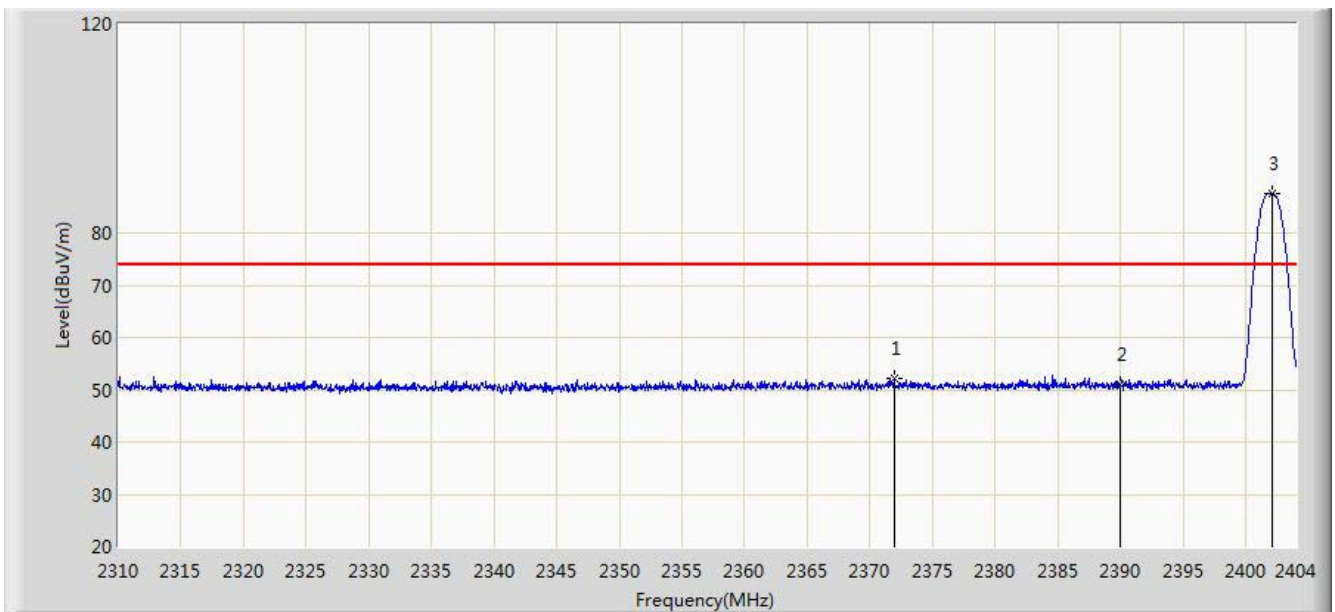

| No | Flag | Mark | Frequency (MHz) | Measure Level (dBuV/m) | Reading Level (dBuV) | Over Limit (dB) | Limit (dBuV/m) | Factor (dB) | Type |
|----|------|------|-----------------|------------------------|----------------------|-----------------|----------------|-------------|------|
| 1 | | | 2371.946 | 52.036 | 20.151 | -21.964 | 74.000 | 31.885 | PK |
| 2 | | | 2390.000 | 51.007 | 19.151 | -22.993 | 74.000 | 31.856 | PK |
| 3 | | * | 2402.073 | 87.459 | 55.623 | N/A | N/A | 31.836 | PK |

Note: Measure Level (dB μ V/m) = Reading Level (dB μ V) + Factor (dB)

Factor (dB) = Cable Loss (dB) + Antenna Factor (dB/m)

| | |
|---|--------------------------|
| Site: AC1 | Time: 2014/12/15 - 15:20 |
| Limit: FCC_Part15.209_RE(3m) | Engineer: Knight Lu |
| Probe: BBHA9120D_1-18GHz | Polarity: Vertical |
| EUT: 9.6 Inch Tablet | Power: By Battery |
| Worse Case Mode : BLE at channel 2402MHz | |

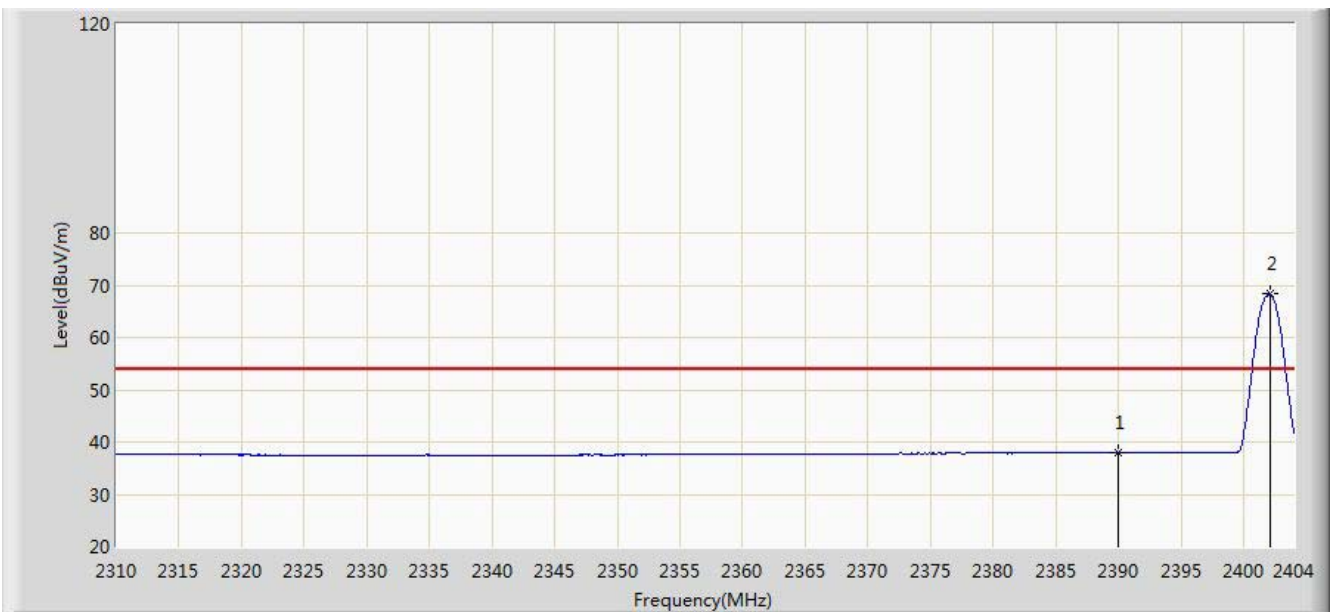

| No | Flag | Mark | Frequency (MHz) | Measure Level (dBuV/m) | Reading Level (dBuV) | Over Limit (dB) | Limit (dBuV/m) | Factor (dB) | Type |
|----|------|------|-----------------|------------------------|----------------------|-----------------|----------------|-------------|------|
| 1 | | | 2390.000 | 37.971 | 6.115 | -16.029 | 54.000 | 31.856 | AV |
| 2 | | * | 2402.073 | 68.313 | 36.477 | N/A | N/A | 31.836 | AV |

Note: Measure Level (dB μ V/m) = Reading Level (dB μ V) + Factor (dB)

Factor (dB) = Cable Loss (dB) + Antenna Factor (dB/m)

| | |
|---|--------------------------|
| Site: AC1 | Time: 2014/12/15 - 15:22 |
| Limit: FCC_Part15.209_RE(3m) | Engineer: Knight Lu |
| Probe: BBHA9120D_1-18GHz | Polarity: Horizontal |
| EUT: 9.6 Inch Tablet | Power: By Battery |
| Worse Case Mode : BLE at channel 2480MHz | |

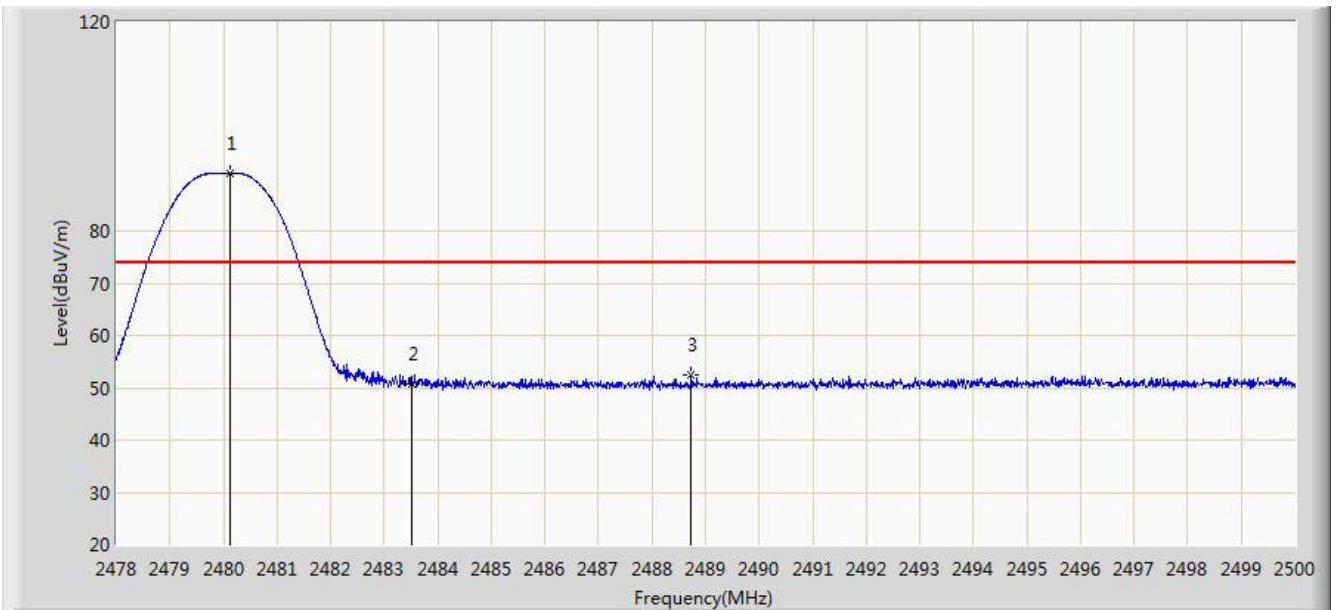

| No | Flag | Mark | Frequency (MHz) | Measure Level (dBuV/m) | Reading Level (dBuV) | Over Limit (dB) | Limit (dBuV/m) | Factor (dB) | Type |
|----|------|------|-----------------|------------------------|----------------------|-----------------|----------------|-------------|------|
| 1 | | * | 2480.112 | 91.010 | 59.172 | N/A | N/A | 31.838 | PK |
| 2 | | | 2483.500 | 50.859 | 19.011 | -23.141 | 74.000 | 31.848 | PK |
| 3 | | | 2488.736 | 52.516 | 20.655 | -21.484 | 74.000 | 31.861 | PK |

Note: Measure Level (dB μ V/m) = Reading Level (dB μ V) + Factor (dB)

Factor (dB) = Cable Loss (dB) + Antenna Factor (dB/m)

| | |
|---|--------------------------|
| Site: AC1 | Time: 2014/12/15 - 15:23 |
| Limit: FCC_Part15.209_RE(3m) | Engineer: Knight Lu |
| Probe: BBHA9120D_1-18GHz | Polarity: Horizontal |
| EUT: 9.6 Inch Tablet | Power: By Battery |
| Worse Case Mode : BLE at channel 2480MHz | |

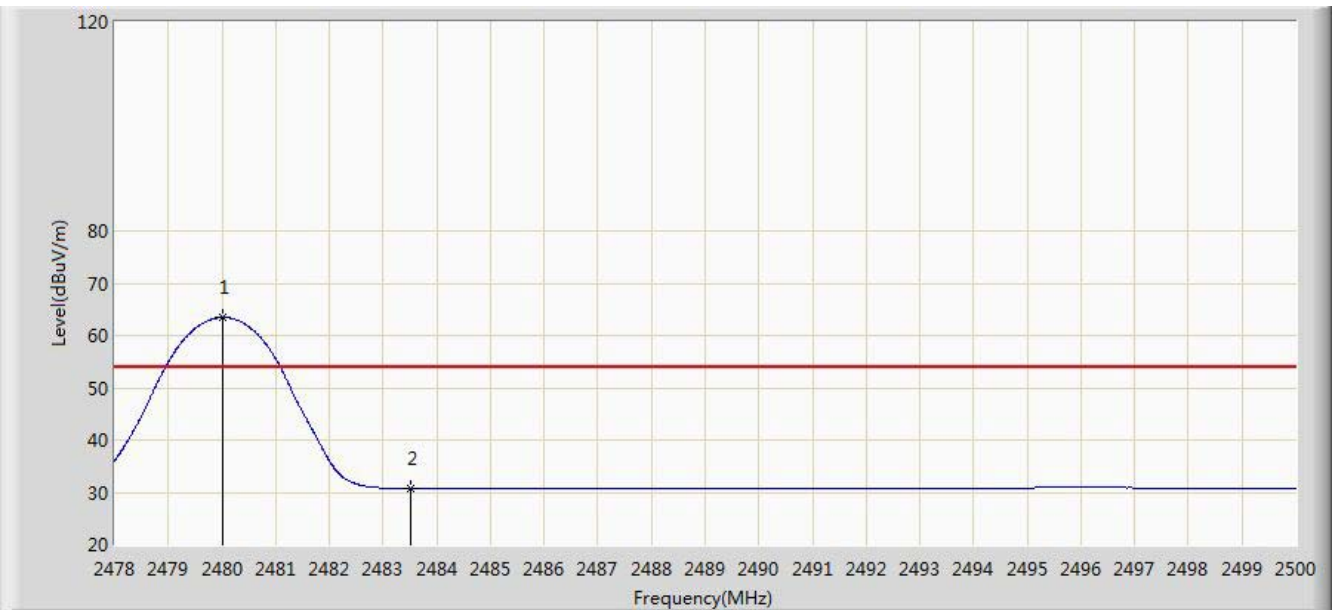

| No | Flag | Mark | Frequency (MHz) | Measure Level (dBuV/m) | Reading Level (dBuV) | Over Limit (dB) | Limit (dBuV/m) | Factor (dB) | Type |
|----|------|------|-----------------|------------------------|----------------------|-----------------|----------------|-------------|------|
| 1 | | * | 2480.002 | 63.452 | 31.614 | N/A | N/A | 31.838 | AV |
| 2 | | | 2483.500 | 30.722 | -1.126 | -23.278 | 54.000 | 31.848 | AV |

Note: Measure Level (dB μ V/m) = Reading Level (dB μ V) + Factor (dB)

Factor (dB) = Cable Loss (dB) + Antenna Factor (dB/m)

| | |
|---|--------------------------|
| Site: AC1 | Time: 2014/12/15 - 15:23 |
| Limit: FCC_Part15.209_RE(3m) | Engineer: Knight Lu |
| Probe: BBHA9120D_1-18GHz | Polarity: Vertical |
| EUT: 9.6 Inch Tablet | Power: By Battery |
| Worse Case Mode : BLE at channel 2480MHz | |

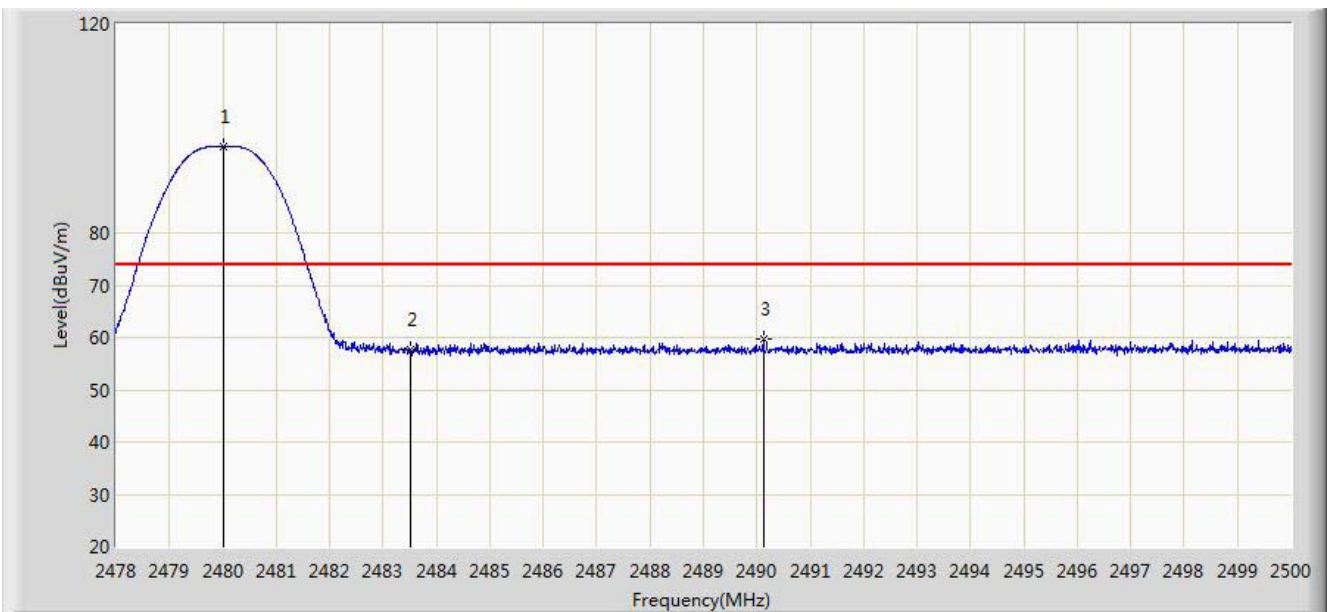

| No | Flag | Mark | Frequency (MHz) | Measure Level (dBuV/m) | Reading Level (dBuV) | Over Limit (dB) | Limit (dBuV/m) | Factor (dB) | Type |
|----|------|------|-----------------|------------------------|----------------------|-----------------|----------------|-------------|------|
| 1 | | * | 2480.002 | 89.447 | 57.609 | N/A | N/A | 31.838 | PK |
| 2 | | | 2483.500 | 50.730 | 18.882 | -23.270 | 74.000 | 31.848 | PK |
| 3 | | | 2490.122 | 52.746 | 20.881 | -21.254 | 74.000 | 31.865 | PK |

Note: Measure Level (dB μ V/m) = Reading Level (dB μ V) + Factor (dB)

Factor (dB) = Cable Loss (dB) + Antenna Factor (dB/m)

| | |
|---|--------------------------|
| Site: AC1 | Time: 2014/12/15 - 15:24 |
| Limit: FCC_Part15.209_RE(3m) | Engineer: Knight Lu |
| Probe: BBHA9120D_1-18GHz | Polarity: Vertical |
| EUT: 9.6 Inch Tablet | Power: By Battery |
| Worse Case Mode : BLE at channel 2480MHz | |

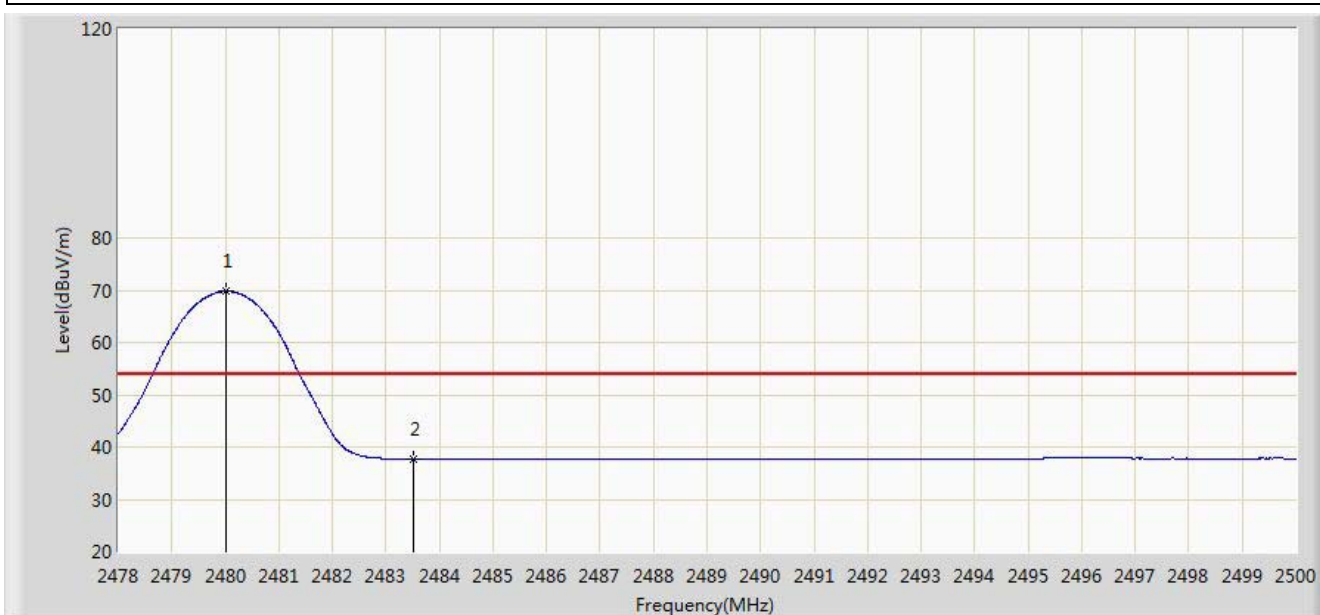

| No | Flag | Mark | Frequency (MHz) | Measure Level (dBuV/m) | Reading Level (dBuV) | Over Limit (dB) | Limit (dBuV/m) | Factor (dB) | Type |
|----|------|------|-----------------|------------------------|----------------------|-----------------|----------------|-------------|------|
| 1 | | * | 2480.002 | 69.784 | 37.946 | N/A | N/A | 31.838 | AV |
| 2 | | | 2483.500 | 37.694 | 5.846 | -16.306 | 54.000 | 31.848 | AV |

Note: Measure Level (dB μ V/m) = Reading Level (dB μ V) + Factor (dB)

Factor (dB) = Cable Loss (dB) + Antenna Factor (dB/m)

7.8. AC Conducted Emissions Measurement

7.8.1. Test Limit

| FCC Part 15 Subpart C Paragraph 15.207 Limits | | |
|---|-----------|-----------|
| Frequency (MHz) | QP (dBuV) | AV (dBuV) |
| 0.15 - 0.50 | 66 - 56 | 56 - 46 |
| 0.50 - 5.0 | 56 | 46 |
| 5.0 - 30 | 60 | 50 |

Note 1: The lower limit shall apply at the transition frequencies.

Note 2: The limit decreases linearly with the logarithm of the frequency in the range 0.15MHz to 0.5MHz.

7.8.2. Test Setup

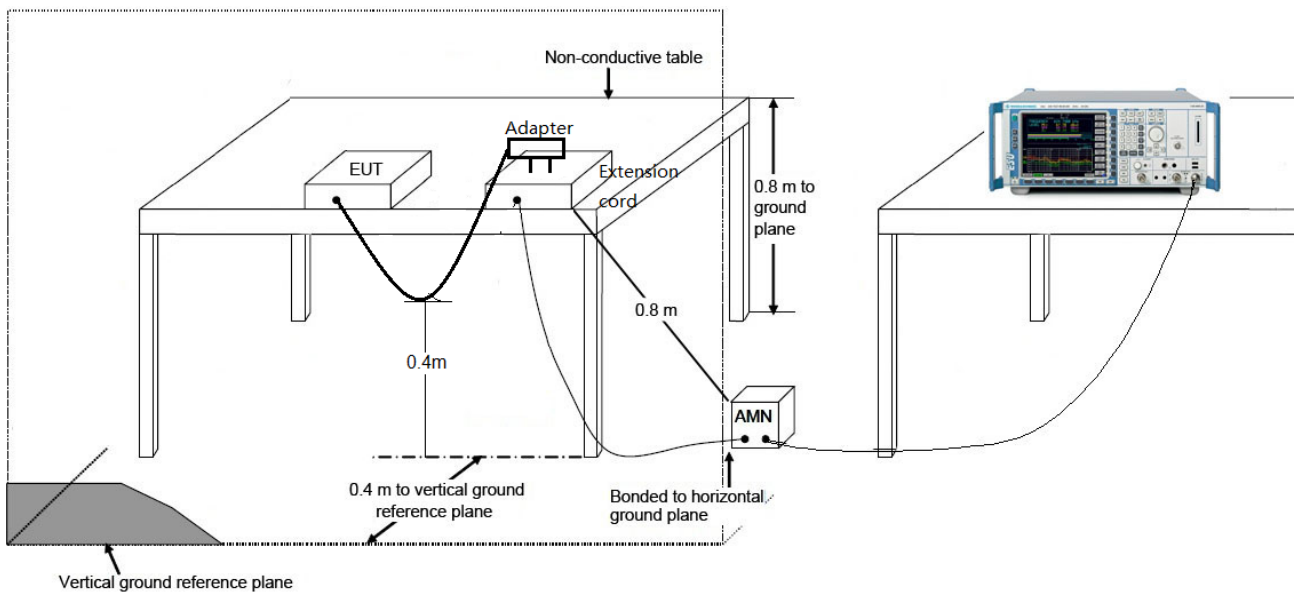

7.8.3. Test Result

| | |
|-----------------------------------|--------------------------|
| Site: SR2 | Time: 2014/12/13 - 12:29 |
| Limit: FCC_Part15.207_CE_AC Power | Engineer: Knight Lu |
| Probe: ENV216_101683_Filter On | Polarity: Line |
| EUT: 9.6 Inch Tablet | Power: AC 120V/60Hz |
| Note: Mode 1 | |

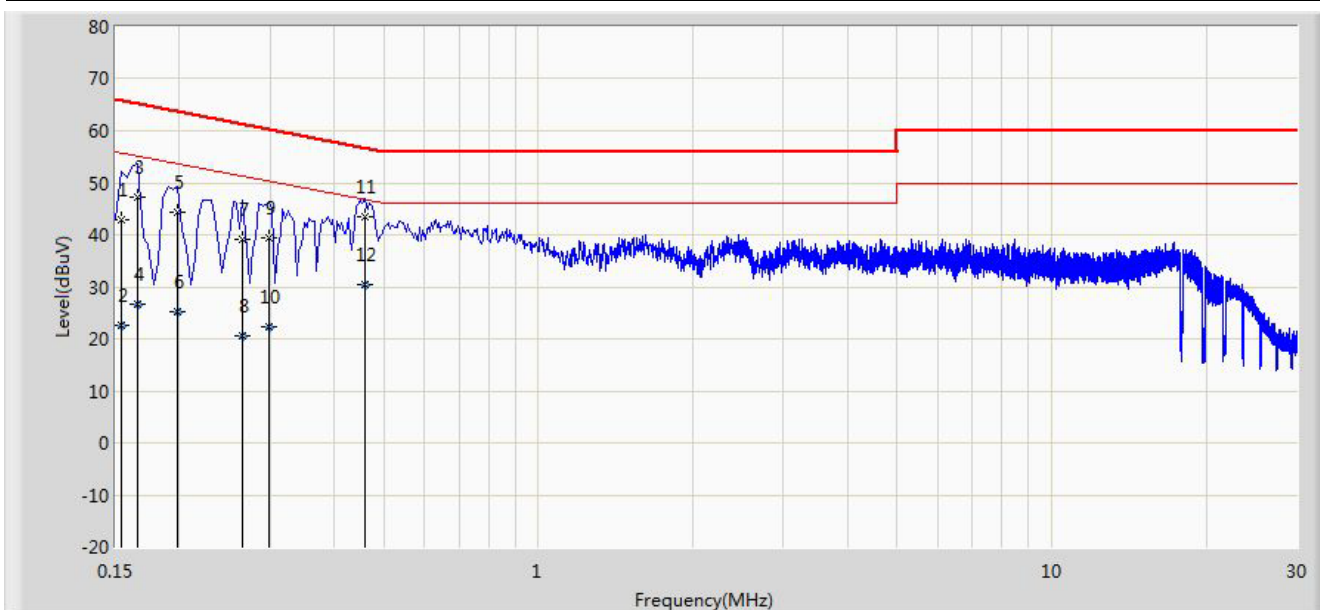

| No | Flag | Mark | Frequency (MHz) | Measure Level (dBuV) | Reading Level (dBuV) | Over Limit (dB) | Limit (dBuV) | Factor (dB) | Type |
|----|------|------|-----------------|----------------------|----------------------|-----------------|--------------|-------------|------|
| 1 | | | 0.154 | 42.786 | 31.990 | -22.996 | 65.781 | 10.796 | QP |
| 2 | | | 0.154 | 22.702 | 11.906 | -33.080 | 55.781 | 10.796 | AV |
| 3 | | | 0.166 | 47.126 | 36.983 | -18.032 | 65.158 | 10.143 | QP |
| 4 | | | 0.166 | 26.626 | 16.483 | -28.532 | 55.158 | 10.143 | AV |
| 5 | | | 0.198 | 44.216 | 34.157 | -19.478 | 63.694 | 10.058 | QP |
| 6 | | | 0.198 | 25.141 | 15.083 | -28.553 | 53.694 | 10.058 | AV |
| 7 | | | 0.266 | 39.184 | 29.159 | -22.058 | 61.242 | 10.025 | QP |
| 8 | | | 0.266 | 20.646 | 10.621 | -30.596 | 51.242 | 10.025 | AV |
| 9 | | | 0.298 | 39.421 | 29.373 | -20.877 | 60.298 | 10.048 | QP |
| 10 | | | 0.298 | 22.246 | 12.198 | -28.053 | 50.298 | 10.048 | AV |
| 11 | | * | 0.458 | 43.503 | 33.361 | -13.226 | 56.729 | 10.142 | QP |
| 12 | | | 0.458 | 30.491 | 20.349 | -16.238 | 46.729 | 10.142 | AV |

Note: Measure Level (dBμV) = Reading Level (dBμV) + Factor (dB)

Factor (dB) = Cable Loss (dB) + LISN Factor (dB)

| | |
|-----------------------------------|--------------------------|
| Site: SR2 | Time: 2014/12/13 - 12:37 |
| Limit: FCC_Part15.207_CE_AC Power | Engineer: Knight Lu |
| Probe: ENV216_101683_Filter On | Polarity: Neutral |
| EUT: 9.6 Inch Tablet | Power: AC 120V/60Hz |
| Note: Mode 1 | |

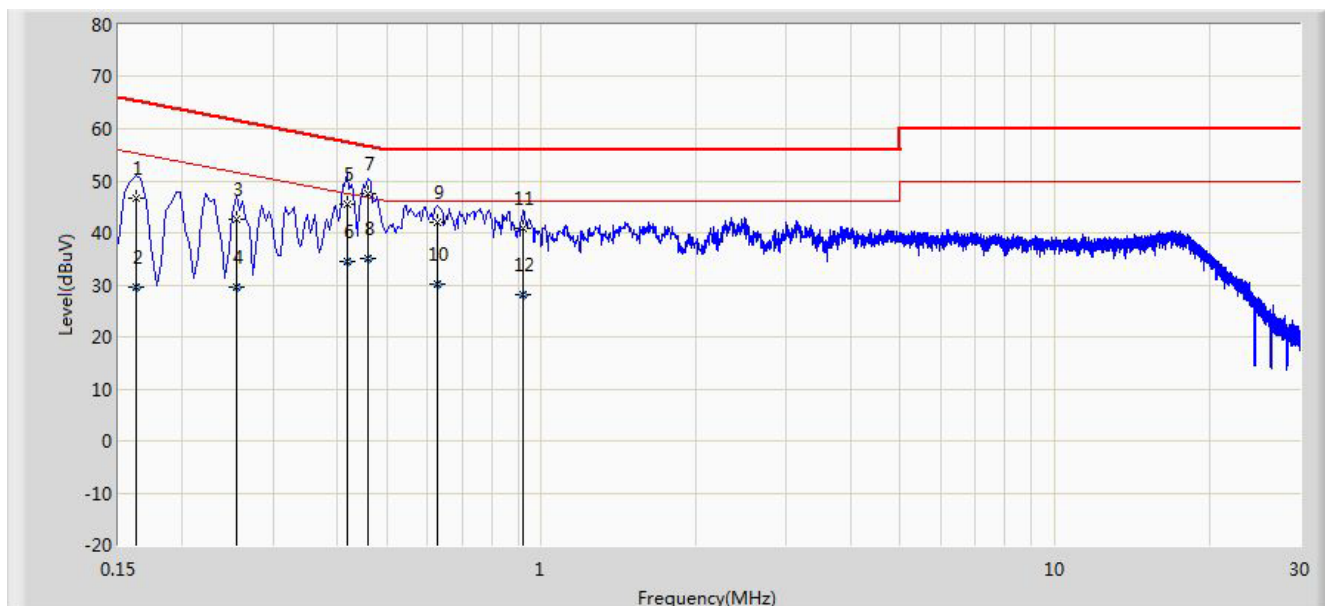

| No | Flag | Mark | Frequency (MHz) | Measure Level (dBuV) | Reading Level (dBuV) | Over Limit (dB) | Limit (dBuV) | Factor (dB) | Type |
|----|------|------|-----------------|----------------------|----------------------|-----------------|--------------|-------------|------|
| 1 | | | 0.162 | 46.674 | 36.540 | -18.686 | 65.361 | 10.134 | QP |
| 2 | | | 0.162 | 29.597 | 19.463 | -25.764 | 55.361 | 10.134 | AV |
| 3 | | | 0.254 | 42.549 | 32.496 | -19.077 | 61.625 | 10.053 | QP |
| 4 | | | 0.254 | 29.620 | 19.568 | -22.005 | 51.625 | 10.053 | AV |
| 5 | | | 0.418 | 45.511 | 35.366 | -11.977 | 57.488 | 10.145 | QP |
| 6 | | | 0.418 | 34.508 | 24.363 | -12.980 | 47.488 | 10.145 | AV |
| 7 | | * | 0.458 | 47.544 | 37.379 | -9.185 | 56.729 | 10.165 | QP |
| 8 | | | 0.458 | 34.991 | 24.826 | -11.738 | 46.729 | 10.165 | AV |
| 9 | | | 0.626 | 41.977 | 31.868 | -14.023 | 56.000 | 10.108 | QP |
| 10 | | | 0.626 | 30.259 | 20.151 | -15.741 | 46.000 | 10.108 | AV |
| 11 | | | 0.922 | 40.988 | 31.039 | -15.012 | 56.000 | 9.949 | QP |
| 12 | | | 0.922 | 28.095 | 18.146 | -17.905 | 46.000 | 9.949 | AV |

Note: Measure Level (dBuV) = Reading Level (dBuV) + Factor (dB)

Factor (dB) = Cable Loss (dB) + LISN Factor (dB)

8. CONCLUSION

The data collected relate only the item(s) tested and show that the **9.6 Inch Tablet FCC ID: 2AAMSHM-9641M** is in compliance with Part 15C of the FCC Rules.

————— The End —————