



MEASUREMENT REPORT

FCC PART 15.247 WLAN 802.11b/g/n

FCC ID: 2AAMSHM-9641M
APPLICANT: SHENZHEN NST INDUSTRY AND TRADE CO. LTD

Application Type: Certification
Product: 9.6 Inch Tablet
Model No.: HM-9641M
Brand Name: Stream
FCC Classification: Digital Transmission System (DTS)
FCC Rule Part(s): Part 15.247
Test Procedure(s): ANSI C63.10-2009, KDB 558074 D01v03r02
Test Date: Dec. 11 ~ 17, 2014

Reviewed By : Robin Wu
(Robin Wu)
Approved By : Marlin Chen
(Marlin Chen)

The test results relate only to the samples tested.

This equipment has been shown to be capable of compliance with the applicable technical standards as indicated in the measurement report and was tested in accordance with the measurement procedures specified in KDB 558074 D01v03r02. Test results reported herein relate only to the item(s) tested.

The test report shall not be reproduced except in full without the written approval of MRT Technology (Suzhou) Co., Ltd.

Revision History

Report No.	Version	Description	Issue Date
1412RSU00901	Rev. 01	Initial report	12-18-2014

CONTENTS

Description	Page
1. INTRODUCTION	6
1.1. Scope	6
1.2. MRT Test Location	6
2. PRODUCT INFORMATION	7
2.1. Equipment Description.....	7
2.2. Product Specification Subjective to this Report.....	7
2.3. Device Capabilities	8
2.4. Test Configuration	8
2.5. EMI Suppression Device(s)/Modifications.....	8
2.6. Labeling Requirements.....	9
2.7. Test Software	9
2.8. Description of Support Units	9
3. DESCRIPTION OF TEST	10
3.1. Evaluation Procedure	10
3.2. AC Line Conducted Emissions	10
3.3. Radiated Emissions.....	11
4. ANTENNA REQUIREMENTS.....	12
5. TEST EQUIPMENT CALIBRATION DATE.....	13
6. MEASUREMENT UNCERTAINTY.....	14
7. TEST RESULT	15
7.1. Summary	15
7.2. 6dB Bandwidth Measurement.....	16
7.2.1. Test Limit	16
7.2.2. Test Procedure used.....	16
7.2.3. Test Setting.....	16
7.2.4. Test Setup.....	16
7.2.5. Test Result.....	17
7.3. Output Power Measurement.....	21
7.3.1. Test Limit	21
7.3.2. Test Procedure Used	21
7.3.3. Test Setting.....	21
7.3.4. Test Setup.....	21
7.3.5. Test Result of Output Power	22

7.4.	Power Spectral Density Measurement	23
7.4.1.	Test Limit	23
7.4.2.	Test Procedure Used	23
7.4.3.	Test Setting.....	23
7.4.4.	Test Setup.....	23
7.4.5.	Test Result.....	24
7.5.	Conducted Band Edge and Out-of-Band Emissions.....	28
7.5.1.	Test Limit	28
7.5.2.	Test Procedure Used	28
7.5.3.	Test Setting.....	28
7.5.4.	Test Setup.....	29
7.5.5.	Test Result.....	30
7.6.	Radiated Spurious Emission Measurement	38
7.6.1.	Test Limit	38
7.6.2.	Test Procedure Used	38
7.6.3.	Test Setting.....	38
7.6.4.	Test Setup.....	40
7.6.5.	Test Result.....	42
7.7.	Radiated Restricted Band Edge Measurement	49
7.7.1.	Test Result.....	49
7.8.	AC Conducted Emissions Measurement.....	57
7.8.1.	Test Limit	57
7.8.2.	Test Setup.....	57
7.8.3.	Test Result.....	58
8.	CONCLUSION.....	60

§2.1033 General Information

Applicant:	SHENZHEN NST INDUSTRY AND TRADE CO. LTD
Applicant Address:	2/F, Building B, Hongmen Technical Park II, Jihua RD, Buji Town, Longgang District, Shenzhen, China
Manufacturer:	SHENZHEN NST INDUSTRY AND TRADE CO. LTD
Manufacturer Address:	2/F, Building B, Hongmen Technical Park II, Jihua RD, Buji Town, Longgang District, Shenzhen, China
Test Site:	MRT Technology (Suzhou) Co., Ltd
Test Site Address:	D8 Building, Youxin Industrial Park, No.2 Tian'edang Rd., Wuzhong Economic Development Zone, Suzhou, China
MRT Registration No.:	809388
FCC Rule Part(s):	Part 15.247
Model No.:	HM-9641M
FCC ID:	2AAMSHM-9641M
Test Device Serial No.:	N/A <input type="checkbox"/> Production <input checked="" type="checkbox"/> Pre-Production <input type="checkbox"/> Engineering
FCC Classification:	Digital Transmission System (DTS)

Test Facility / Accreditations

Measurements were performed at MRT Laboratory located in Tian'edang Rd., Suzhou, China.

- MRT facility is a FCC registered (MRT Reg. No. 809388) test facility with the site description report on file and has met all the requirements specified in Section 2.948 of the FCC Rules.
- MRT facility is an IC registered (MRT Reg. No. 11384A-1) test laboratory with the site description on file at Industry Canada.
- MRT facility is a VCCI registered (R-4179, G-814, C-4664, T-2206) test laboratory with the site description on file at VCCI Council.
- MRT Lab is accredited to ISO 17025 by the American Association for Laboratory Accreditation (A2LA) under the American Association for Laboratory Accreditation Program (A2LA Cert. No. 3628.01) in EMC, Telecommunications and Radio testing for FCC, Industry Canada, EU and TELEC Rules.

1. INTRODUCTION

1.1. Scope

Measurement and determination of electromagnetic emissions (EMC) of radio frequency devices including intentional and/or unintentional radiators for compliance with the technical rules and regulations of the Federal Communications Commission and the Industry Canada Certification and Engineering Bureau.

1.2. MRT Test Location

The map below shows the location of the MRT LABORATORY, its proximity to the Taihu Lake. These measurement tests were conducted at the MRT Technology (Suzhou) Co., Ltd. Facility located at D8 Building, Youxin Industrial Park, No.2 Tian'edang Rd., Wuzhong Economic Development Zone, Suzhou, China. The detailed description of the measurement facility was found to be in compliance with the requirements of § 2.948 according to ANSI C63.4-2009 on September 30, 2013.



2. PRODUCT INFORMATION

2.1. Equipment Description

Product Name	9.6 Inch Tablet
Model No.	HM-9641M
Serial Model	STR-9.6-TABLET, MX96XXX, Model Difference Description: e.g. MX96XXX, "XXX" in the last three digits, the first and second "X" represent A to Z, the last "X" represents 1to 9.
Wi-Fi Specification	802.11b/g/n
Bluetooth Specification	v4.0 (single mode)

Note: The difference of models is for different marketing requirement.

2.2. Product Specification Subjective to this Report

Frequency Range	802.11b/g/n-HT20: 2412 ~ 2462 MHz 802.11n-HT40: 2422 ~ 2452 MHz
Type of Modulation	802.11b: DSSS 802.11g/n: OFDM
Data Rate	802.11b: 1/2/5.5/11 Mbps 802.11g: 6/9/12/18/24/36/48/54 Mbps 802.11n: up to 150 Mbps
Antenna Type	Internal
Antenna Gain	1.2dBi

Note: For other features of this EUT, test report will be issued separately.

Channel List for 802.11b/g/n-HT20

Channel	Frequency	Channel	Frequency	Channel	Frequency
01	2412 MHz	02	2417 MHz	03	2422 MHz
04	2427 MHz	05	2432 MHz	06	2437 MHz
07	2442 MHz	08	2447 MHz	09	2452 MHz
10	2457 MHz	11	2462 MHz	N/A	N/A

Channel List for 802.11n-HT40

Channel	Frequency	Channel	Frequency	Channel	Frequency
03	2422 MHz	04	2427 MHz	05	2432 MHz
06	2437 MHz	07	2442 MHz	08	2447 MHz
09	2452 MHz	N/A	N/A	N/A	N/A

2.3. Device Capabilities

This device contains the following capabilities:

802.11b/g/n WLAN (DTS), Bluetooth (BLE)

Note: 2.4GHz WLAN (DTS) operation is possible in 20MHz, and 40MHz channel bandwidths. The maximum achievable duty cycles for all modes were determined based on measurements performed on a spectrum analyzer in zero-span mode with RBW = 8MHz, VBW = 50MHz, and detector = peak per the guidance of Section 6.0 b) of KDB 558074 D01v03r02. The RBW and VBW were both greater than $50/T$, where T is the minimum transmission duration, and the number of sweep points across T was greater than 100. The duty cycles are as follows:

- 802.11b - 100.0%
- 802.11g/n-HT20 - 100.0%
- 802.11n-HT40 - 100.0%

2.4. Test Configuration

The **9.6 Inch Tablet FCC ID: 2AAMSHM-9641M** was tested per the guidance of KDB 558074 D01v03r02. ANSI C63.10-2009 was used to reference the appropriate EUT setup for radiated spurious emissions testing and AC line conducted testing.

2.5. EMI Suppression Device(s)/Modifications

No EMI suppression device(s) were added and/or no modifications were made during testing.

2.6. Labeling Requirements

Per 2.1074 & 15.19; Docket 95-19

The label shall be permanently affixed at a conspicuous location on the device; instruction manual or pamphlet supplied to the user and be readily visible to the purchaser at the time of purchase.

However, when the device is so small wherein placement of the label with specified statement is not practical, only the trade name and FCC ID must be displayed on the device per Section 15.19(a)(5). Please see attachment for FCC ID label and label location.

2.7. Test Software

The test utility software used during testing was engineering order directive by applicant.

2.8. Description of Support Units

The EUT has been tested with associated equipment below:

Description	Manufacturer	Model No.
Adapter	Supply by MRT	HSU50600F

3. DESCRIPTION OF TEST

3.1. Evaluation Procedure

The measurement procedures described in the American National Standard for Testing Unlicensed Wireless Devices (ANSI C63.10-2009), and the guidance provided in KDB 558074 D01v03r02 were used in the measurement of the **9.6 Inch Tablet FCC ID: 2AAMSHM-9641M**.

Deviation from measurement procedure.....None

3.2. AC Line Conducted Emissions

The line-conducted facility is located inside an 8'x4'x4' shielded enclosure. A 1m x 2m wooden table 80cm high is placed 40cm away from the vertical wall and 80cm away from the sidewall of the shielded room. Two 10kHz-30MHz, 50Ω/50uH Line-Impedance Stabilization Networks (LISNs) are bonded to the shielded room floor. Power to the LISNs is filtered by external high-current high-insertion loss power line filters. These filters attenuate ambient signal noise from entering the measurement lines. These filters are also bonded to the shielded enclosure.

The EUT is powered from one LISN and the support equipment is powered from the second LISN. All interconnecting cables more than 1 meter were shortened to a 1 meter length by non-inductive bundling (serpentine fashion) and draped over the back edge of the test table. All cables were at least 40cm above the horizontal reference ground-plane. Power cables for support equipment were routed down to the second LISN while ensuring that that cables were not draped over the second LISN.

Sufficient time for the EUT, support equipment, and test equipment was allowed in order for them to warm up to their normal operating condition. The RF output of the LISN was connected to the receiver and exploratory measurements were made to determine the frequencies producing the maximum emission from the EUT. The receiver was scanned from 150kHz to 30MHz. The detector function was set to peak mode for exploratory measurements while the bandwidth of the analyzer was set to 9kHz. The EUT, support equipment, and interconnecting cables were arranged and manipulated to maximize each emission. Each emission was also maximized by varying: power lines, the mode of operation or data exchange speed, or support equipment whichever determined the worst-case emission. Once the worst case emissions have been identified, the one EUT cable configuration/arrangement and mode of operation that produced these emissions were used for final measurements on the same test site. The analyzer is set to CISPR quasi-peak and average detectors with a 9kHz resolution bandwidth for final measurements.

An extension cord was used to connect to a single LISN which powered by EUT. The extension cord was calibrated with LISN, the impedance and insertion loss are compliance with the requirements as stated in ANSI C63.10-2009 at Clause 4.3.

Line conducted emissions test results are shown in Section 7.8.

3.3. Radiated Emissions

The radiated test facilities consisted of an indoor 3 meter semi-anechoic chamber used for final measurements and exploratory measurements, when necessary. The measurement area is contained within the semi-anechoic chamber which is shielded from any ambient interference. For measurements above 1GHz absorbers are arranged on the floor between the turn table and the antenna mast in such a way so as to maximize the reduction of reflections. For measurements below 1GHz, the absorbers are removed. A MF Model 210SS turntable is used for radiated measurement. It is a continuously rotatable, remote controlled, metallic turntable and 2 meters (6.56 ft.) in diameter. The turn table is flush with the raised floor of the chamber in order to maintain its function as a ground plane. An 80cm high PVC support structure is placed on top of the turntable.

For all measurements, the spectrum was scanned through all EUT azimuths and from 1 to 4 meter receive antenna height using a broadband antenna from 30MHz up to the upper frequency shown in 15.33(b)(1) depending on the highest frequency generated or used in the device or on which the device operates or tunes. For frequencies above 1GHz, linearly polarized double ridge horn antennas were used. For frequencies below 30MHz, a calibrated loop antenna was used. When exploratory measurements were necessary, they were performed at 1 meter test distance inside the semi-anechoic chamber using broadband antennas, broadband amplifiers, and spectrum analyzers to determine the frequencies and modes producing the maximum emissions. Sufficient time for the EUT, support equipment, and test equipment was allowed in order for them to warm up to their normal operating condition. The test set-up was placed on top of the 0.8 meter high, 1 x 1.5 meter table. The EUT, support equipment, and interconnecting cables were arranged and manipulated to maximize each emission. Appropriate precaution was taken to ensure that all emissions from the EUT were maximized and investigated. The system configuration, clock speed, mode of operation or video resolution, if applicable, turntable azimuth, and receive antenna height was noted for each frequency found.

Final measurements were made in the semi-anechoic chamber using calibrated, linearly polarized broadband and horn antennas. The test setup was configured to the setup that produced the worst case emissions. The spectrum analyzer was set to investigate all frequencies required for testing to compare the highest radiated disturbances with respect to the specified limits. The turntable containing the EUT was rotated through 360 degrees and the height of the receive antenna was varied 1 to 4 meters and stopped at the azimuth and height producing the maximum emission. Each emission was maximized by changing the orientation of the EUT through three orthogonal planes and changing the polarity of the receive antenna, whichever produced the worst-case emissions. According to 3dB BeamWidth of horn antenna, the horn antenna should be always directed to the EUT when rising height.

4. ANTENNA REQUIREMENTS

Excerpt from §15.203 of the FCC Rules/Regulations:

“An intentional radiator antenna shall be designed to ensure that no antenna other than that furnished by the responsible party can be used with the device. The use of a permanently attached antenna or of an antenna that uses a unique coupling to the intentional radiator shall be considered sufficient to comply with the provisions of this section.”

- The antenna of the 9.6 Inch Tablet is **permanently attached**.
- There are no provisions for connection to an external antenna.

Conclusion:

The **9.6 Inch Tablet FCC ID: 2AAMSHM-9641M** unit complies with the requirement of §15.203.

5. TEST EQUIPMENT CALIBRATION DATE

Conducted Emissions

Instrument	Manufacturer	Type No.	Serial No.	Cali. Interval	Cali. Due Date
EMI Test Receiver	R&S	ESR7	101209	1 year	2015/11/07
Two-Line V-Network	R&S	ENV216	101683	1 year	2015/11/07
Two-Line V-Network	R&S	ENV216	101684	1 year	2015/11/07
Temperature/ Meter Humidity	Anymetre	TH101B	SR2-01	1 year	2015/11/14

Radiated Emission

Instrument	Manufacturer	Type No.	Serial No.	Cali. Interval	Cali. Due Date
Spectrum Analyzer	Agilent	N9020A	MY52090106	1 year	2015/04/23
Preamplifier	MRT	AP01G18	1310002	1 year	2015/10/06
Loop Antenna	Schwarzbeck	FMZB1519	1519-041	1 year	2015/11/08
TRILOG Antenna	Schwarzbeck	VULB9162	9162-047	1 year	2015/11/08
Broad-Band Horn Antenna	Schwarzbeck	BBHA9120D	9120D-1167	1 year	2015/11/08
Broadband Horn Antenna	Schwarzbeck	BBHA9170	9170-549	1 year	2015/12/12
Temperature/Humidity Meter	Anymetre	TH101B	AC1-01	1 year	2015/11/14

Conducted Test Equipment

Instrument	Manufacturer	Type No.	Serial No.	Cali. Interval	Cali. Due Date
Spectrum Analyzer	Agilent	N9020A	MY52090106	1 year	2015/04/23
Power Sensor	Agilent	U2021XA	MY52450003	1 year	2015/12/09
Temperature/Humidity Meter	Anymetre	TH101B	TR3-01	1 year	2015/11/14

6. MEASUREMENT UNCERTAINTY

Where relevant, the following test uncertainty levels have been estimated for tests performed on the EUT as specified in CISPR 16-4-2. This uncertainty represents an expanded uncertainty expressed at approximately the 95% confidence level using a coverage factor of $k = 2$.

AC Conducted Emission Measurement
Measuring Uncertainty for a Level of Confidence of 95% ($U=2Uc(y)$): 150kHz~30MHz: $\pm 3.46\text{dB}$
Radiated Emission Measurement
Measuring Uncertainty for a Level of Confidence of 95% ($U=2Uc(y)$): 9kHz ~ 1GHz: $\pm 4.18\text{dB}$ 1GHz ~ 25GHz: $\pm 4.76\text{dB}$

7. TEST RESULT

7.1. Summary

Product Name: 9.6 Inch Tablet
FCC ID: 2AAMSHM-9641M
FCC Classification: Digital Transmission System (DTS)
Data Rate(s) 1Mbps ~ 11Mbps (b); 6Mbps ~ 54Mbps (g);
Tested: 6.5/7.2Mbps ~ 65/72.2Mbps (n - HT20);
13.5/15Mbps ~ 135/150Mbps (n - HT40)

FCC Part Section(s)	Test Description	Test Limit	Test Condition	Test Result	Reference
15.247(a)(2)	6dB Bandwidth	$\geq 500\text{kHz}$	Conducted	Pass	Section 7.2
15.247(b)(3)	Output Power	$\leq 1\text{Watt}$		Pass	Section 7.3
15.247(e)	Power Spectral Density	$\leq 8\text{dBm} / 3\text{kHz Band}$		Pass	Section 7.4
15.247(d)	Band Edge / Out-of-Band Emissions	$\geq 20\text{dBc(Peak)}$		Pass	Section 7.5
15.205 15.209	General Field Strength Limits (Restricted Bands and Radiated Emission Limits)	Emissions in restricted bands must meet the radiated limits detailed in 15.209	Radiated	Pass	Section 7.6 & 7.7
15.207	AC Conducted Emissions 150kHz - 30MHz	$< \text{FCC 15.207 limits}$	Line Conducted	Pass	Section 7.8

Notes:

- 1) All modes of operation and data rates were investigated. For radiated emission test, every axis (X, Y, Z) was also verified. The test results shown in the following sections represent the worst case emissions.
- 2) The analyzer plots shown in this section were all taken with a correction table loaded into the analyzer. The correction table was used to account for the losses of the cables and attenuators used as part of the system to connect the EUT to the analyzer at all frequencies of interest.
- 3) All antenna port conducted emissions testing was performed on a test bench with the antenna port of the EUT connected to the spectrum analyzer through calibrated cables and attenuators.

7.2. 6dB Bandwidth Measurement

7.2.1. Test Limit

The minimum 6dB bandwidth shall be at least 500 kHz.

7.2.2. Test Procedure used

KDB 558074 D01v03r02 - Section 8.2 Option 2

7.2.3. Test Setting

1. The Spectrum's automatic bandwidth measurement capability was used to perform the 6dB bandwidth measurement. The "X" dB bandwidth parameter was set to $X = 6$. The bandwidth measurement was not influenced by any intermediate power nulls in the fundamental emission.
2. Set RBW = 100 kHz
3. VBW $\geq 3 \times$ RBW
4. Detector = Peak
5. Trace mode = max hold
6. Sweep = auto couple
7. Allow the trace was allowed to stabilize

7.2.4. Test Setup

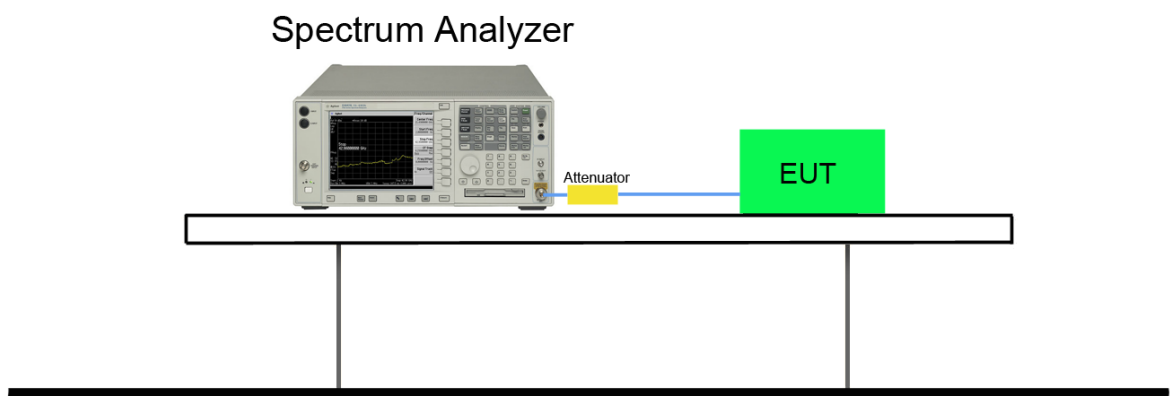

7.2.5. Test Result

Test Mode	Data Rate (Mbps)	Channel No.	Frequency (MHz)	6dB Bandwidth (MHz)	Limit (MHz)	Result
802.11b	1	01	2412	10.04	≥ 0.5	Pass
802.11b	1	06	2437	10.04	≥ 0.5	Pass
802.11b	1	11	2462	10.03	≥ 0.5	Pass
802.11g	6	01	2412	16.61	≥ 0.5	Pass
802.11g	6	06	2437	16.62	≥ 0.5	Pass
802.11g	6	11	2462	16.61	≥ 0.5	Pass
802.11n-HT20	6.5	01	2412	17.83	≥ 0.5	Pass
802.11n-HT20	6.5	06	2437	17.82	≥ 0.5	Pass
802.11n-HT20	6.5	11	2462	17.82	≥ 0.5	Pass
802.11n-HT40	13.5	03	2422	36.48	≥ 0.5	Pass
802.11n-HT40	13.5	06	2437	36.50	≥ 0.5	Pass
802.11n-HT40	13.5	09	2452	36.49	≥ 0.5	Pass

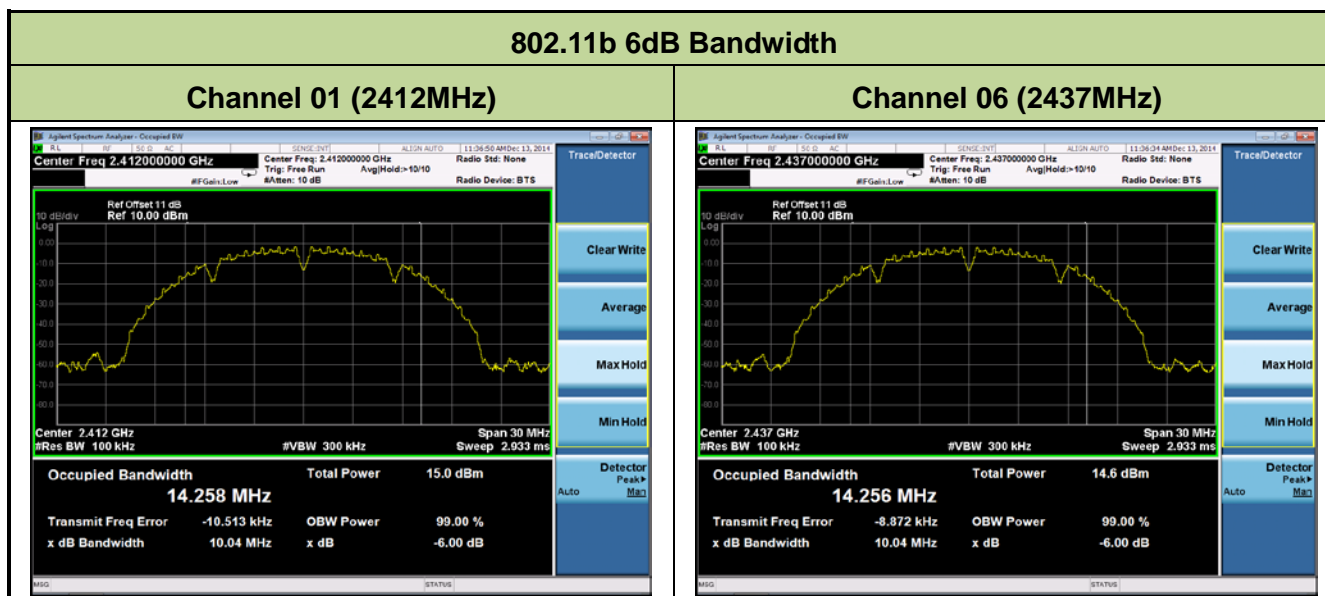

Channel 11 (2462MHz)

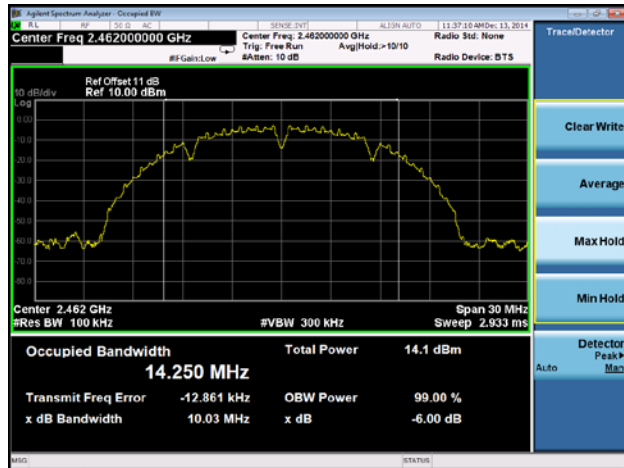

802.11g 6dB Bandwidth

Channel 01 (2412MHz)

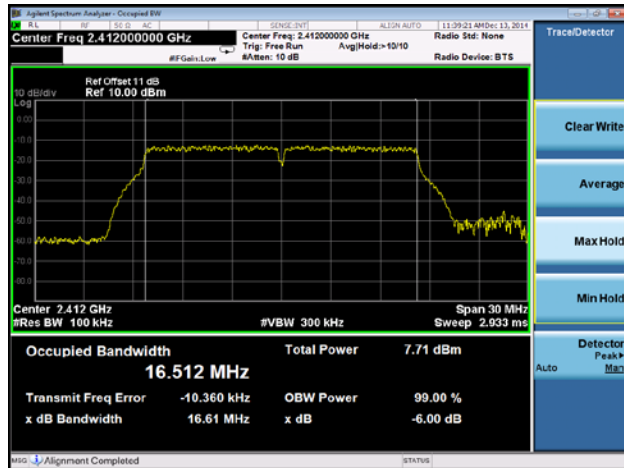

Channel 06 (2437MHz)

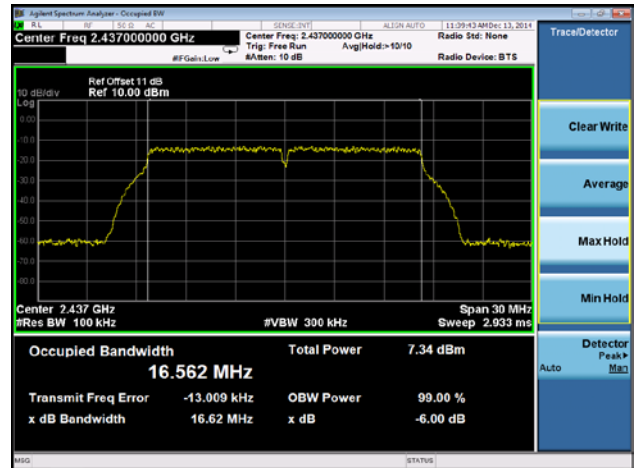

Channel 11 (2462MHz)

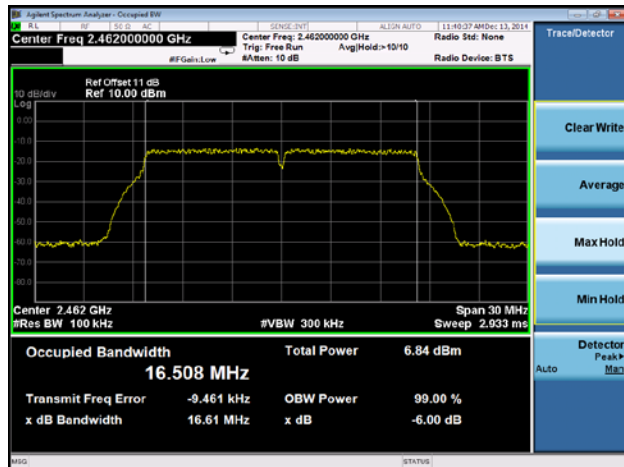

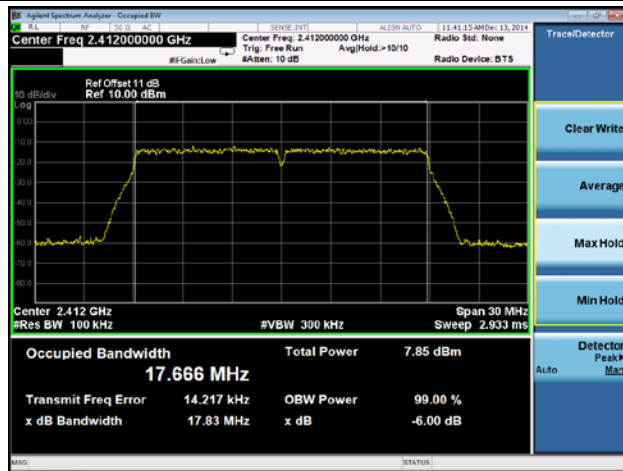
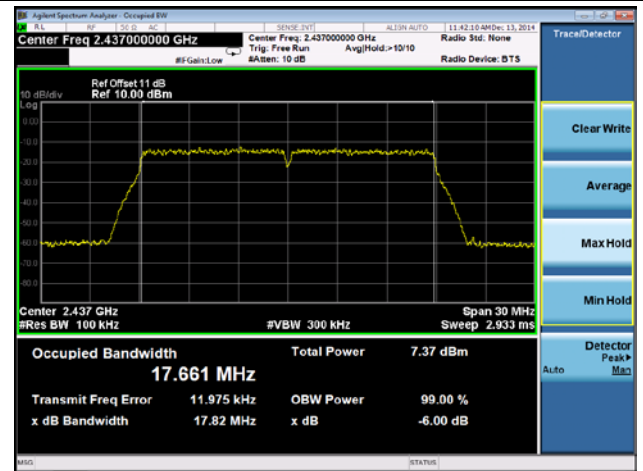
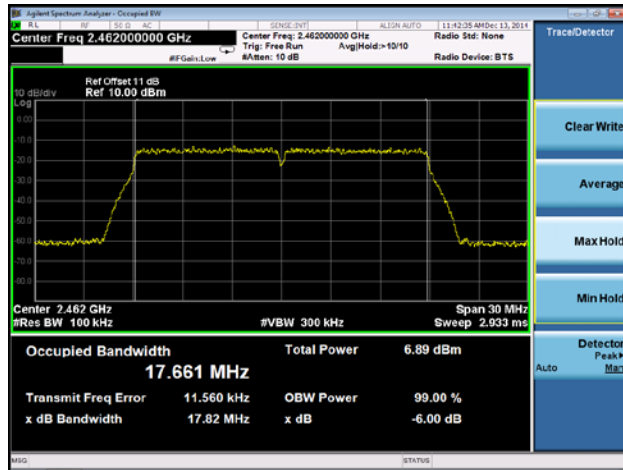
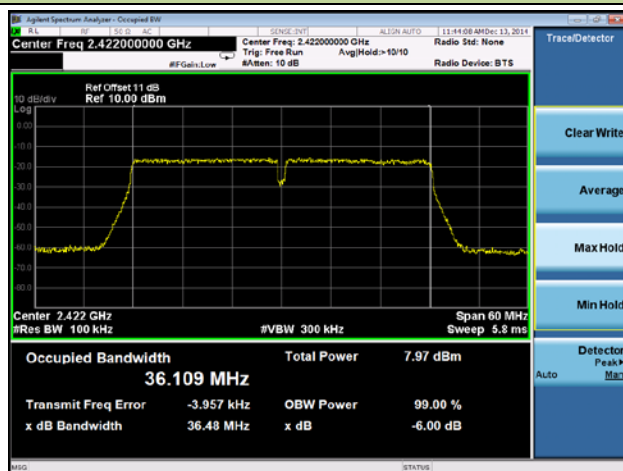
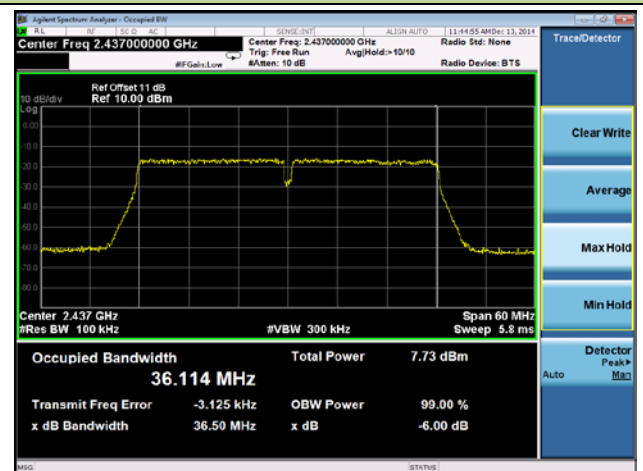
802.11n-HT20 6dB Bandwidth
Channel 01 (2412MHz)

Channel 06 (2437MHz)

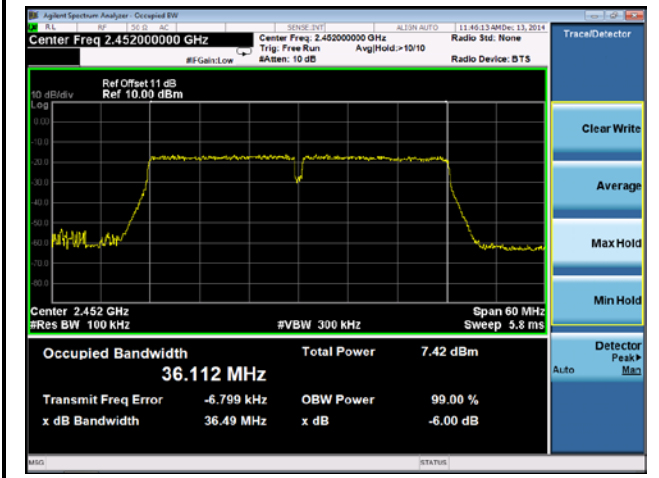
Channel 11 (2462MHz)

802.11n-HT40 6dB Bandwidth
Channel 03 (2422MHz)

Channel 06 (2437MHz)

Channel 9 (2452MHz)



7.3. Output Power Measurement

7.3.1. Test Limit

The maximum out power shall be less 1 Watt (30dBm).

7.3.2. Test Procedure Used

KDB 558074 D01v03r02 - Section 9.1.2 PKPM1 Peak Power Method (for signals with BW \leq 50MHz)

7.3.3. Test Setting

Method PKPM1 (Peak Power Measurement of Signals with DTS BW \leq 50MHz)

Peak power measurements were performed only when the EUT was transmitting at its maximum power control level using a broadband power meter with a pulse sensor. The pulse sensor employs a VBW = 50MHz so this method was only used for signals whose DTS bandwidth was less than or equal to 50MHz.

7.3.4. Test Setup

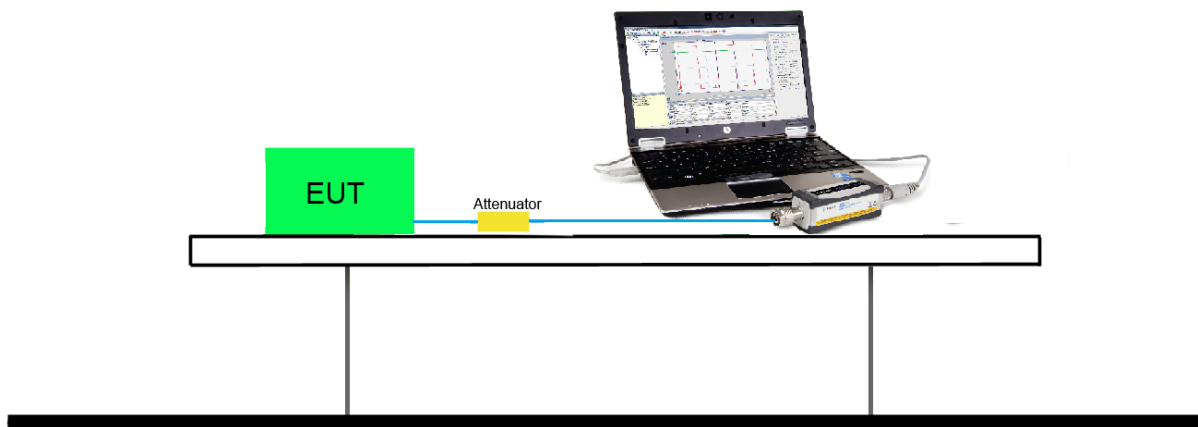

7.3.5. Test Result of Output Power

Output power at various data rates:

Test Mode	Bandwidth (MHz)	Channel No.	Frequency (MHz)	Data Rate (Mbps)	Peak Power (dBm)
802.11b	20	6	2437	1	8.91
				5.5	8.80
				11	8.69
802.11g	20	6	2437	6	8.79
				24	8.62
				54	8.49
802.11n	20	6	2437	6.5 (MCS0)	8.71
				39 (MCS4)	8.57
				65 (MCS7)	8.41
802.11n	40	6	2437	13.5 (MCS0)	8.43
				81/ (MCS4)	8.32
				135/ (MCS7)	8.15

Test Result of Peak Output Power

Test Mode	Data Rate (Mbps)	Channel No.	Frequency (MHz)	Peak Power (dBm)	Limit (dBm)	Result
11b	1	1	2412	9.04	≤ 30	Pass
11b	1	6	2437	8.91	≤ 30	Pass
11b	1	11	2462	8.75	≤ 30	Pass
11g	6	1	2412	8.98	≤ 30	Pass
11g	6	6	2437	8.79	≤ 30	Pass
11g	6	11	2462	8.60	≤ 30	Pass
11n-HT20	6.5	1	2412	8.83	≤ 30	Pass
11n-HT20	6.5	6	2437	8.71	≤ 30	Pass
11n-HT20	6.5	11	2462	8.52	≤ 30	Pass
11n-HT40	13.5	3	2422	8.57	≤ 30	Pass
11n-HT40	13.5	6	2437	8.43	≤ 30	Pass
11n-HT40	13.5	9	2452	8.22	≤ 30	Pass

7.4. Power Spectral Density Measurement

7.4.1. Test Limit

The maximum permissible power spectral density is 8dBm in any 3 kHz band.

7.4.2. Test Procedure Used

KDB 558074 D01v03r02 - Section 10.2 Method PKPSD

7.4.3. Test Setting

1. Analyzer was set to the center frequency of the DTS channel under investigation
2. Span = 1.5 times the DTS channel bandwidth
3. RBW = 3kHz
4. VBW = 10kHz
5. Detector = peak
6. Sweep time = auto couple
7. Trace mode = max hold
8. Trace was allowed to stabilize

7.4.4. Test Setup

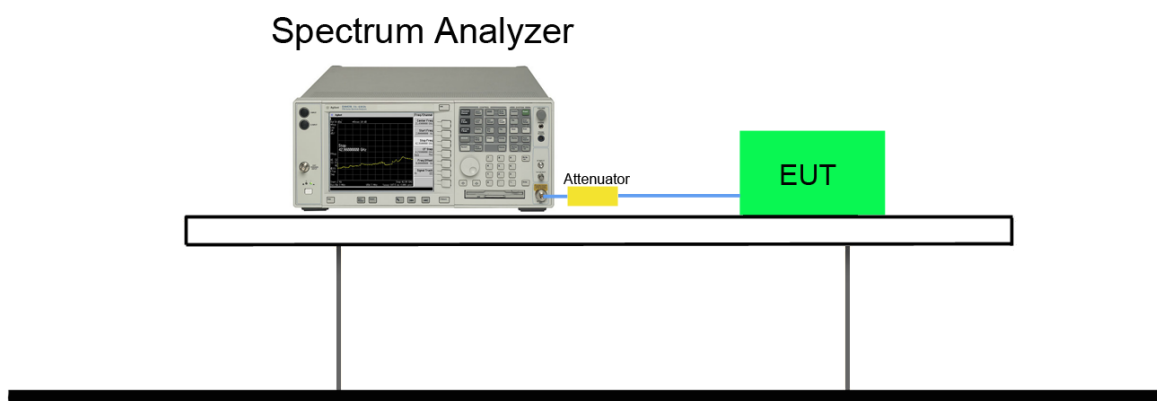

7.4.5. Test Result

Test Mode	Data Rate (Mbps)	Channel No.	Frequency (MHz)	PSD Result (dBm / 3kHz)	Limit (dBm / 3kHz)	Result
11b	1	1	2412	-19.44	≤ 8	Pass
11b	1	6	2437	-19.92	≤ 8	Pass
11b	1	11	2462	-20.44	≤ 8	Pass
11g	6	1	2412	-26.02	≤ 8	Pass
11g	6	6	2437	-26.71	≤ 8	Pass
11g	6	11	2462	-27.37	≤ 8	Pass
11n-HT20	6.5	1	2412	-25.80	≤ 8	Pass
11n-HT20	6.5	6	2437	-26.67	≤ 8	Pass
11n-HT20	6.5	11	2462	-26.36	≤ 8	Pass
11n-HT40	13.5	3	2422	-27.79	≤ 8	Pass
11n-HT40	13.5	6	2437	-27.92	≤ 8	Pass
11n-HT40	13.5	9	2452	-28.23	≤ 8	Pass

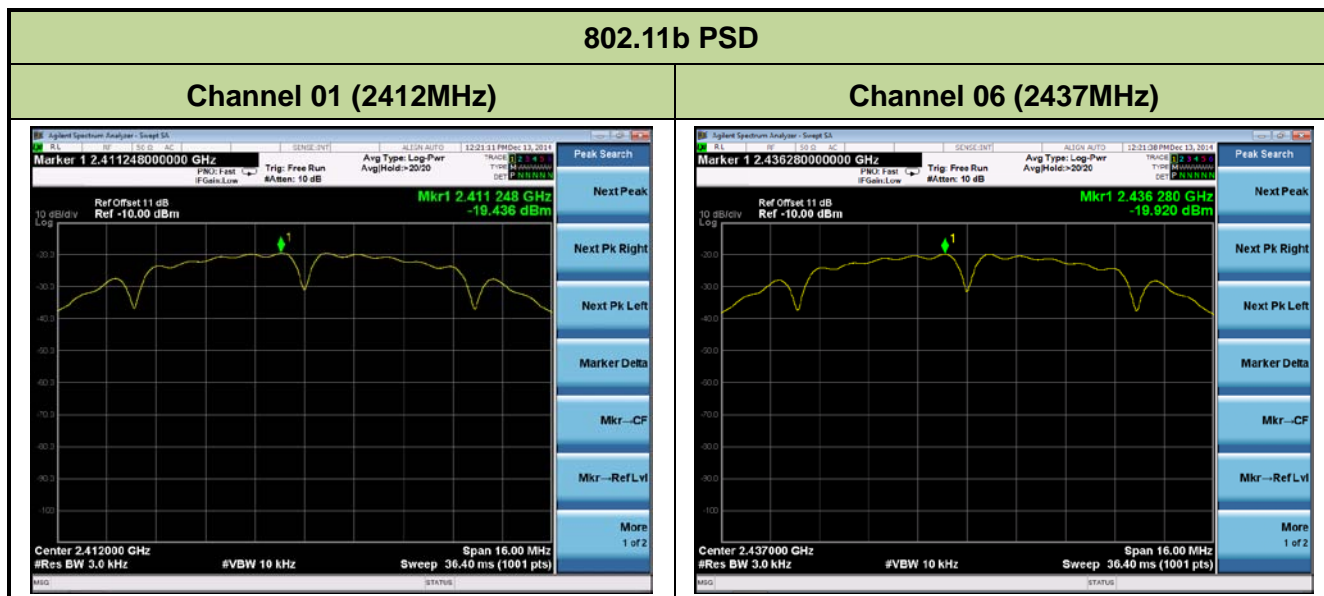

Channel 11 (2462MHz)



802.11g PSD

Channel 01 (2412MHz)

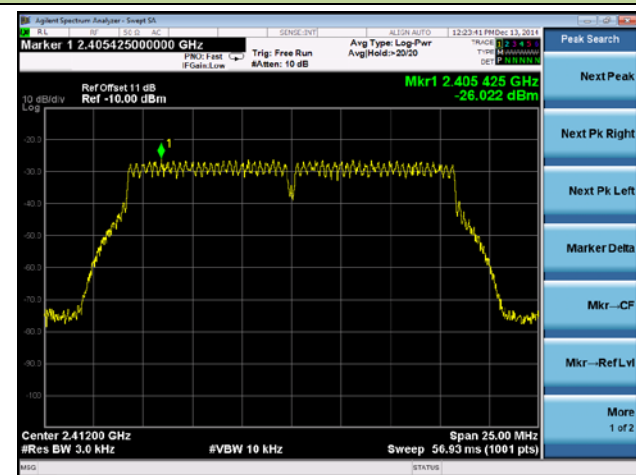

Channel 06 (2437MHz)

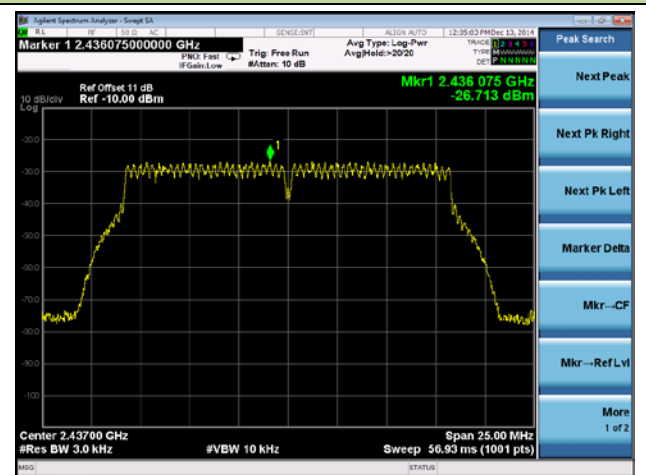

Channel 11 (2462MHz)

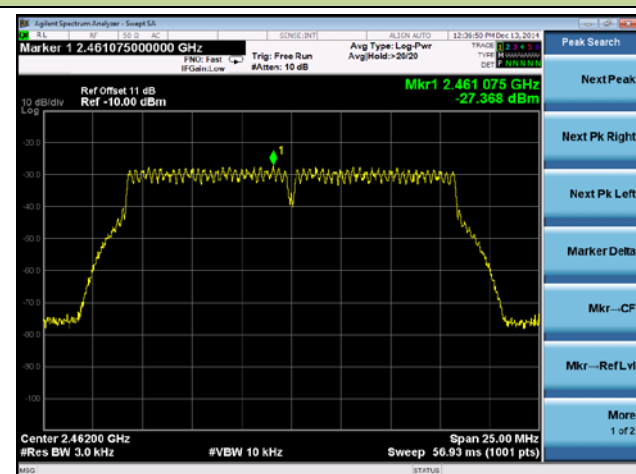

802.11n-HT20 PSD

Channel 01 (2412MHz)

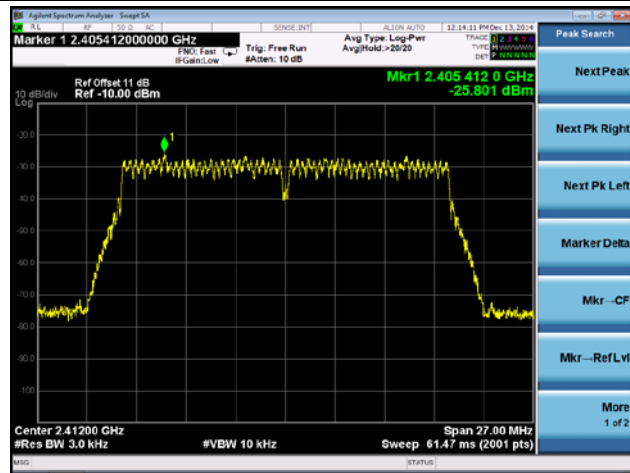

Channel 06 (2437MHz)

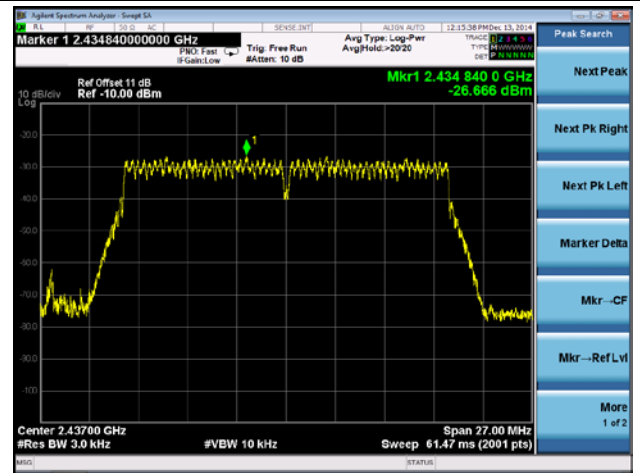

Channel 11 (2462MHz)

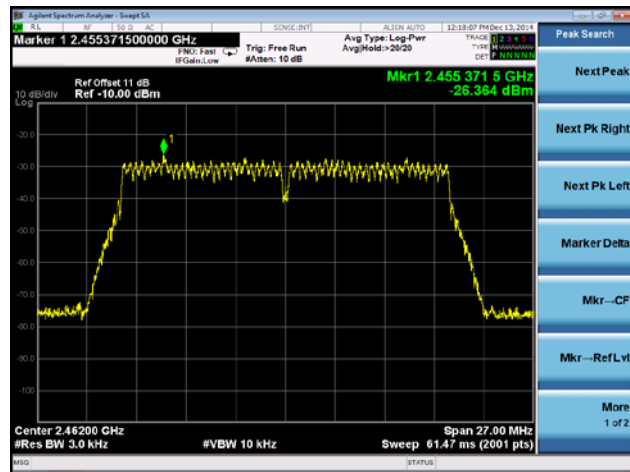

802.11n-HT40 PSD

Channel 03 (2422MHz)

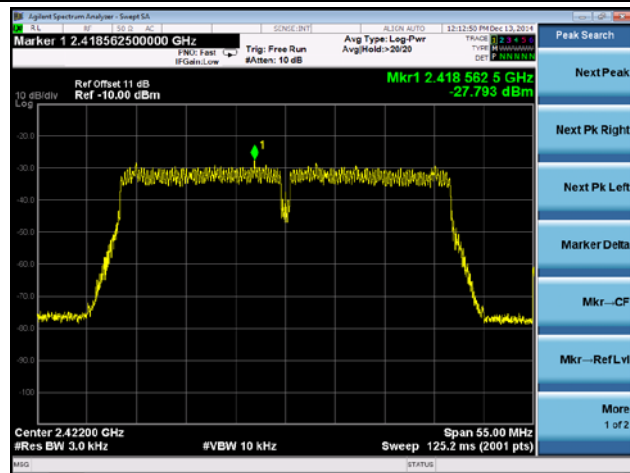

Channel 06 (2437MHz)

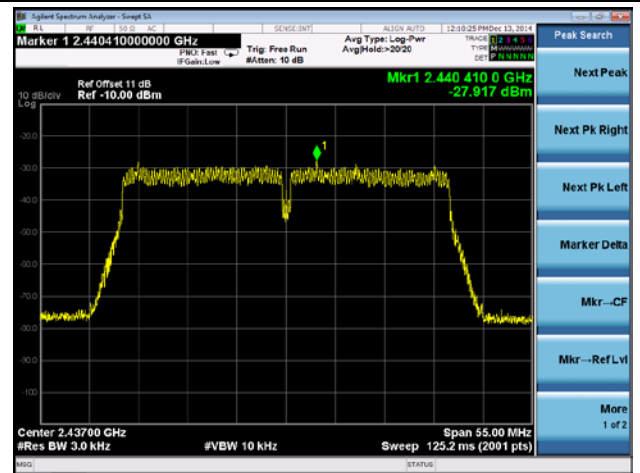

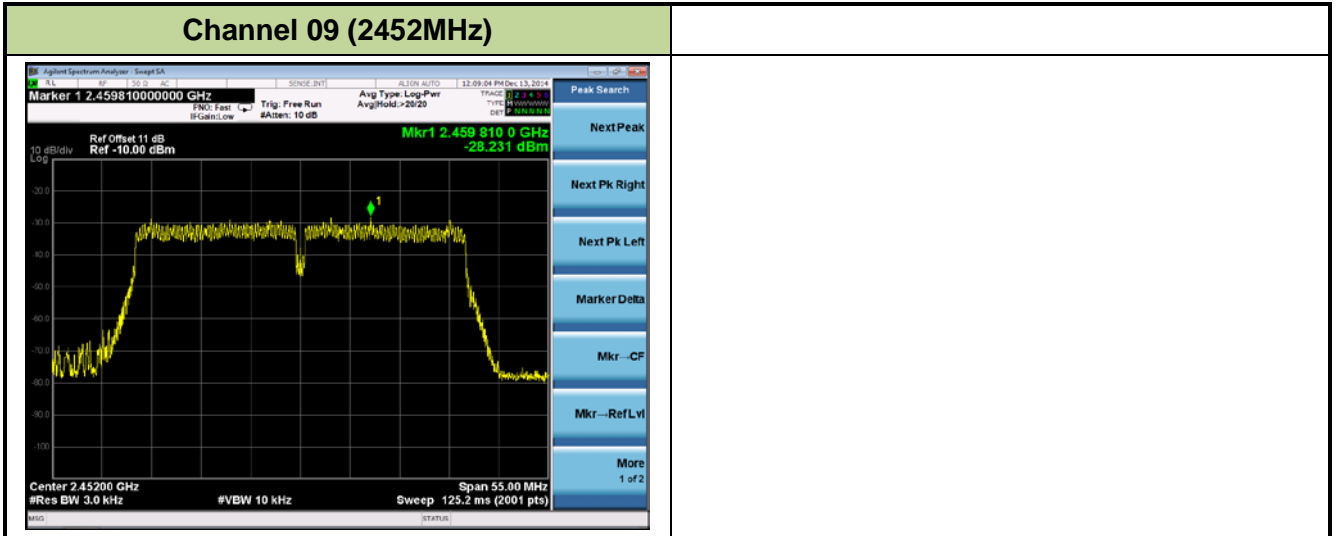

7.5. Conducted Band Edge and Out-of-Band Emissions

7.5.1. Test Limit

The limit for out-of-band spurious emissions at the band edge is 20dB below the fundamental emission level, as determined from the in-band power measurement of the DTS channel performed in a 100kHz bandwidth per the PSD procedure (Section 9.1).

7.5.2. Test Procedure Used

KDB 558074 D01v03r02 - Section 11.2 & Section 11.3

7.5.3. Test Setting

1. Reference level measurement

- (a) Set instrument center frequency to DTS channel center frequency
- (b) Set the span to ≥ 1.5 times the DTS bandwidth
- (c) Set the RBW = 100 kHz
- (d) Set the VBW $\geq 3 \times$ RBW
- (e) Detector = peak
- (f) Sweep time = auto couple
- (g) Trace mode = max hold
- (h) Allow trace to fully stabilize

2. Emission level measurement

- (a) Set the center frequency and span to encompass frequency range to be measured
- (b) RBW = 100kHz
- (c) VBW = 300kHz
- (d) Detector = Peak
- (e) Number of sweep points $\geq 2 \times$ Span/RBW
- (f) Trace mode = max hold
- (g) Sweep time = auto couple

(h) The trace was allowed to stabilize

7.5.4. Test Setup

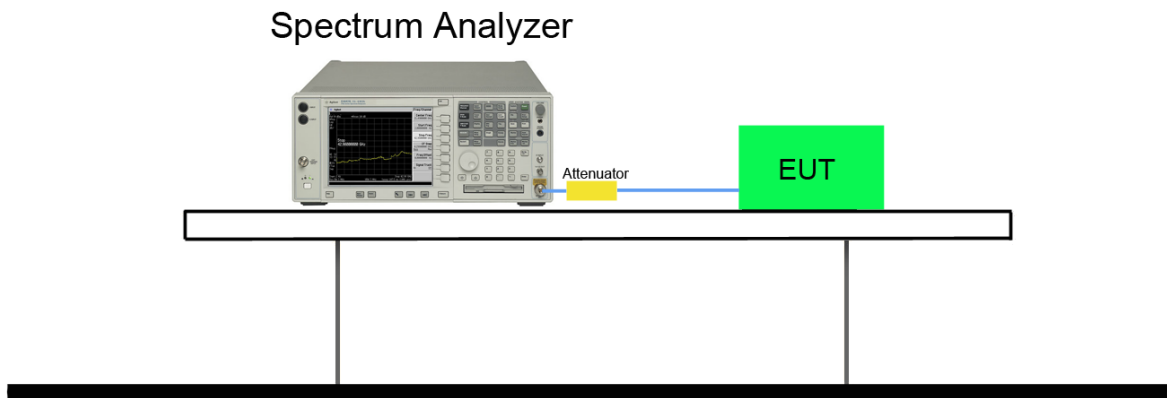

7.5.5. Test Result

Test Mode	Data Rate (Mbps)	Channel No.	Frequency (MHz)	Limit	Result
802.11b	1	01	2412	20dBc	Pass
802.11b	1	06	2437	20dBc	Pass
802.11b	1	11	2462	20dBc	Pass
802.11g	6	01	2412	20dBc	Pass
802.11g	6	06	2437	20dBc	Pass
802.11g	6	11	2462	20dBc	Pass
11n-HT20	6.5	1	2412	20dBc	Pass
11n-HT20	6.5	6	2437	20dBc	Pass
11n-HT20	6.5	11	2462	20dBc	Pass
11n-HT40	13.5	3	2422	20dBc	Pass
11n-HT40	13.5	6	2437	20dBc	Pass
11n-HT40	13.5	9	2452	20dBc	Pass

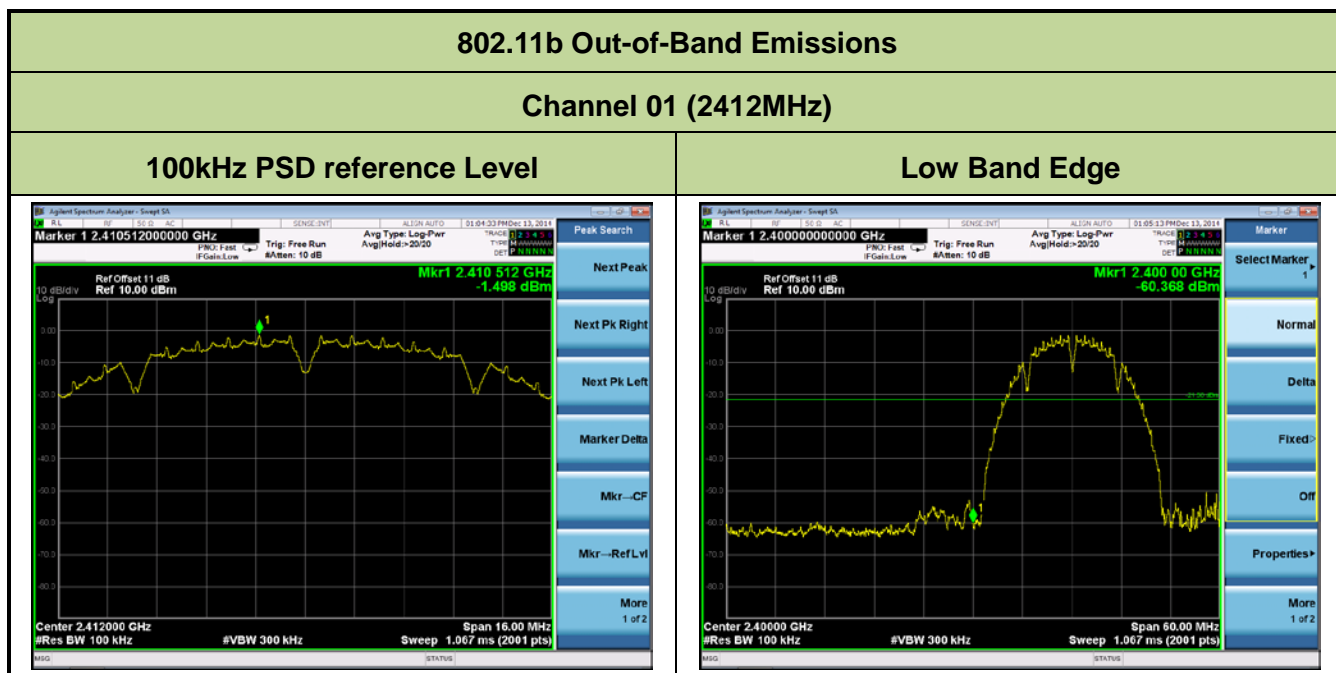

Spurious Emission 30MHz ~ 25GHz

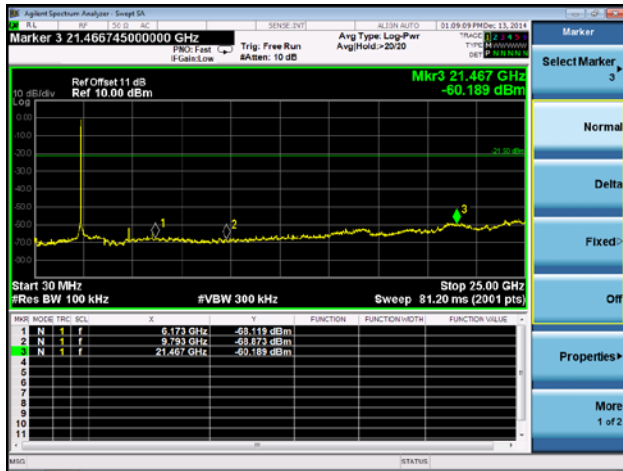

Channel 06 (2437MHz)

100kHz PSD reference Level

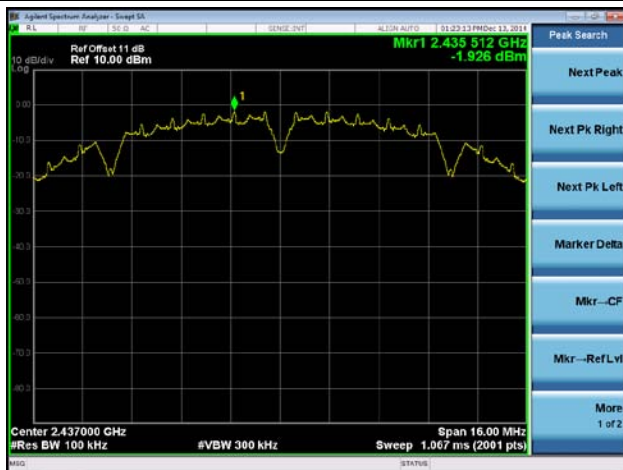

Spurious Emission 30MHz ~ 25GHz

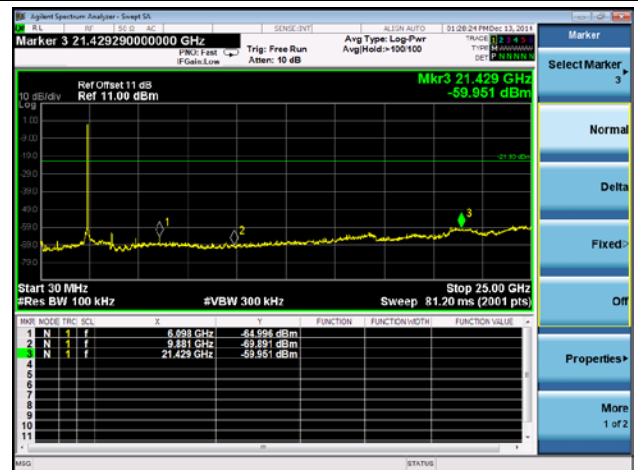

Channel 11 (2462MHz)

100kHz PSD reference Level



High Band Edge

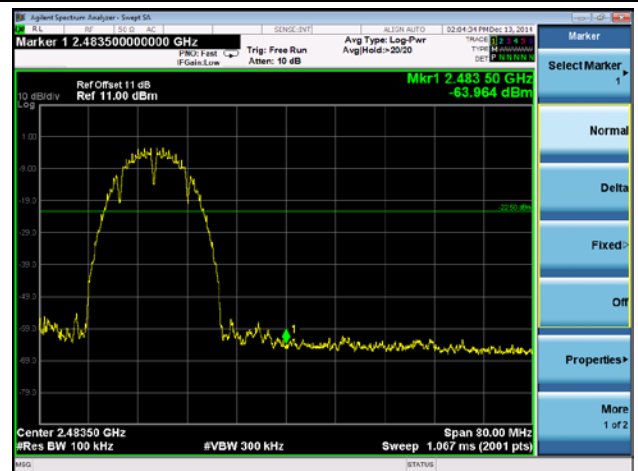

Spurious Emission 30MHz ~ 25GHz

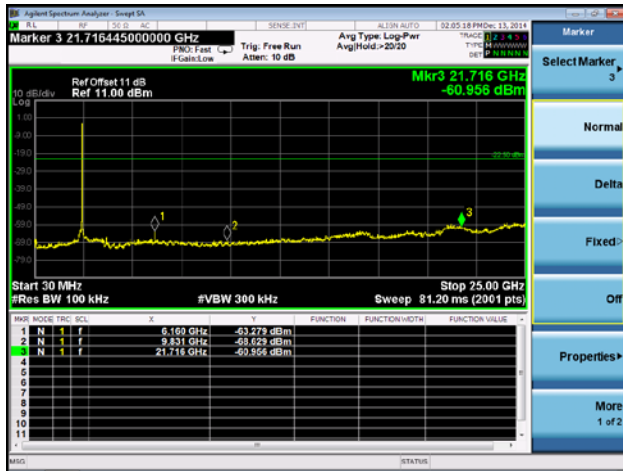

802.11g Out-of-Band Emissions

Channel 01 (2412MHz)

100kHz PSD reference Level



Low Band Edge

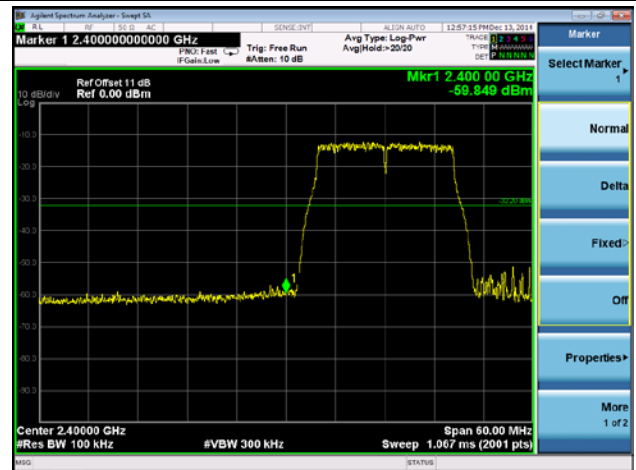

Spurious Emission 30MHz ~ 25GHz

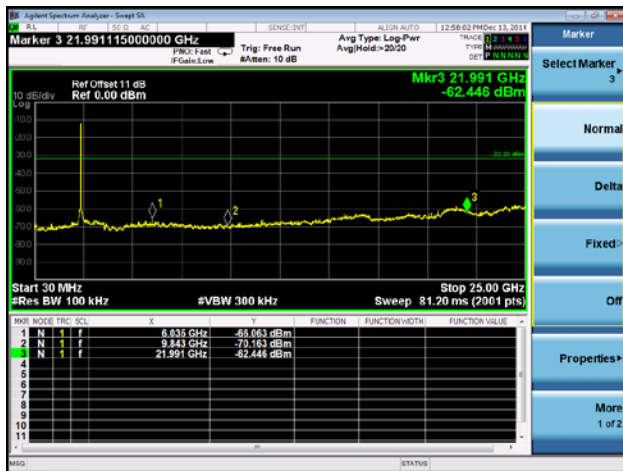

Channel 06 (2437MHz)
100kHz PSD reference Level

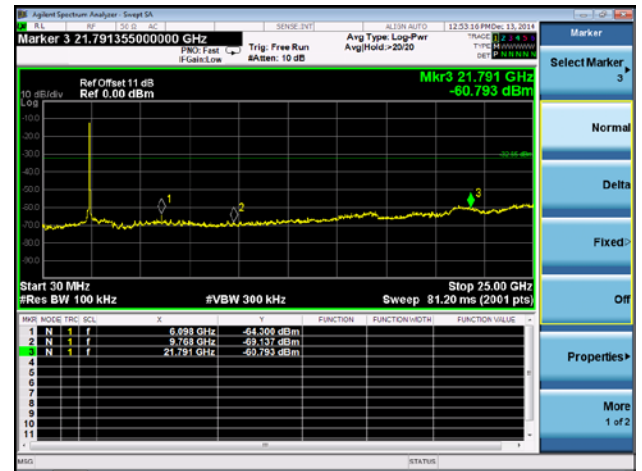
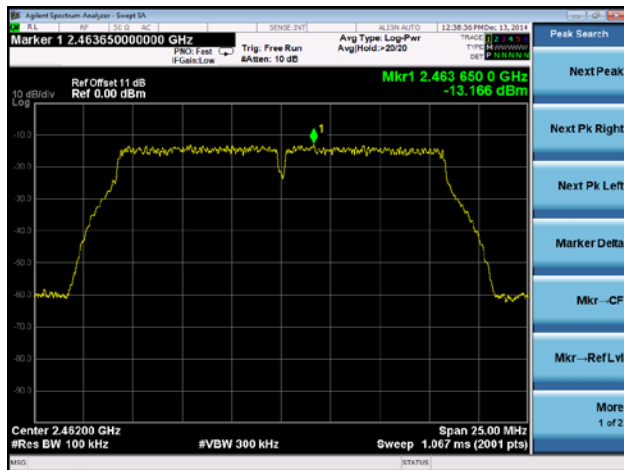
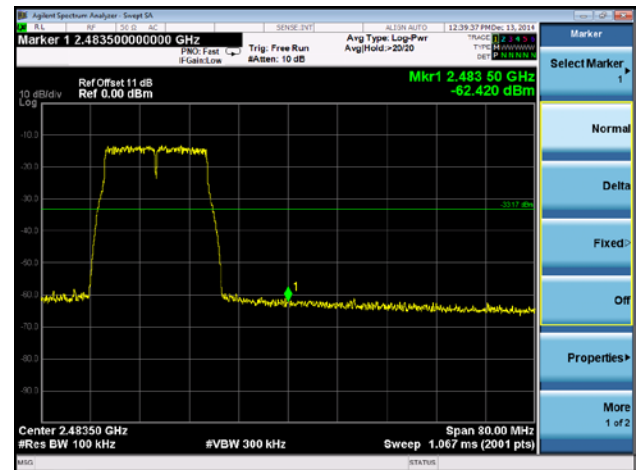
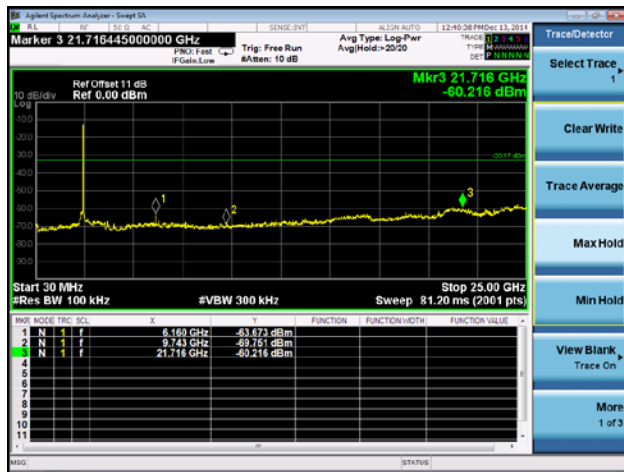
Spurious Emission 30MHz ~ 25GHz

Channel 11 (2462MHz)
100kHz PSD reference Level

High Band Edge

Spurious Emission 30MHz ~ 25GHz

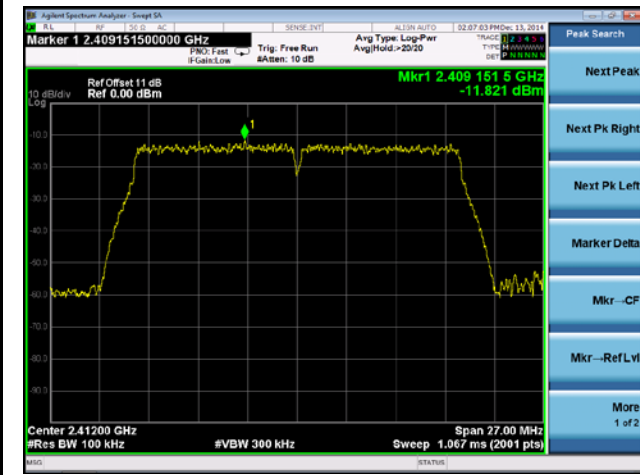
802.11n-HT20 Out-of-Band Emissions

Channel 01 (2412MHz)

100kHz PSD reference Level



Low Band Edge

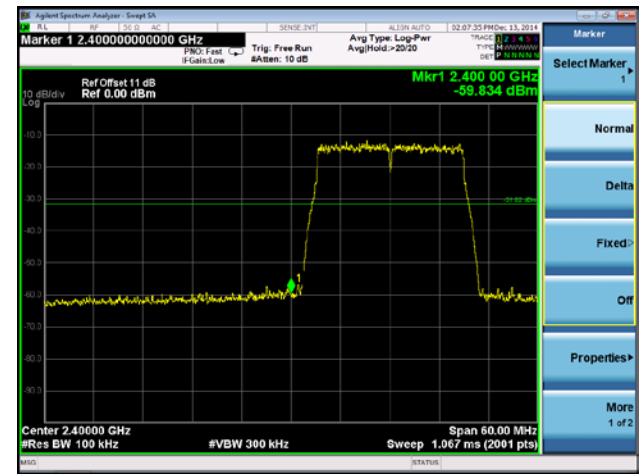

Spurious Emission 30MHz ~ 25GHz

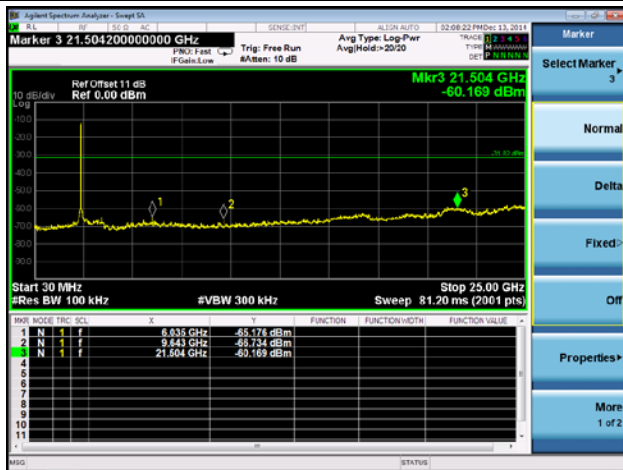

Channel 06 (2437MHz)

100kHz PSD reference Level

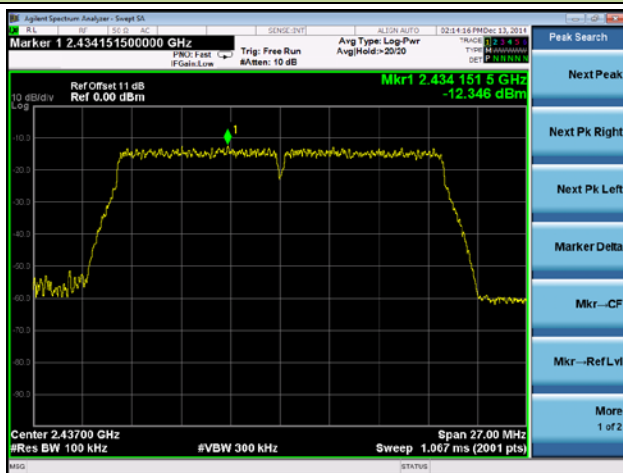

Spurious Emission 30MHz ~ 25GHz

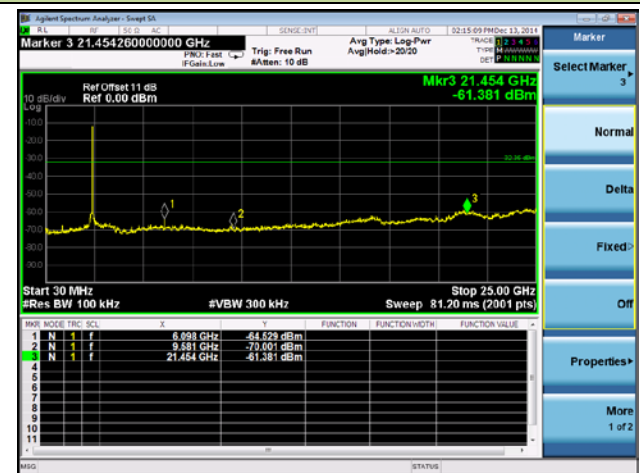

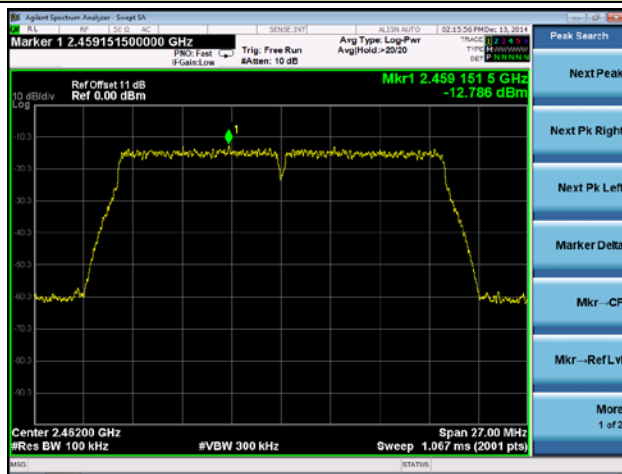
Channel 11 (2462MHz)
100kHz PSD reference Level

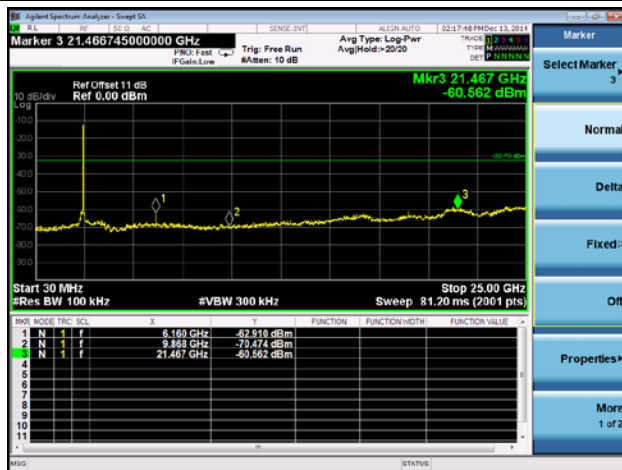
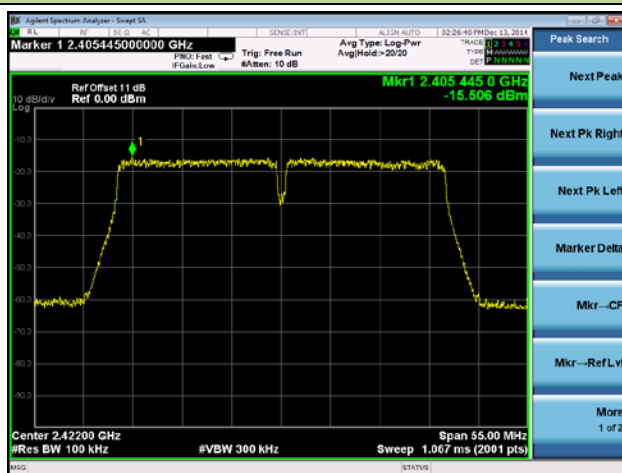
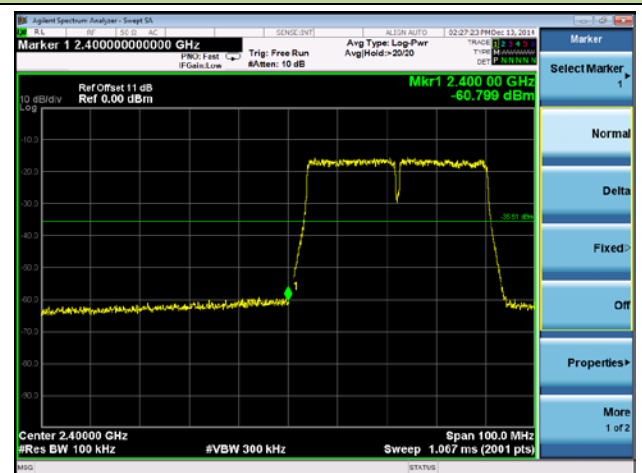
High Band Edge

Spurious Emission 30MHz ~ 25GHz

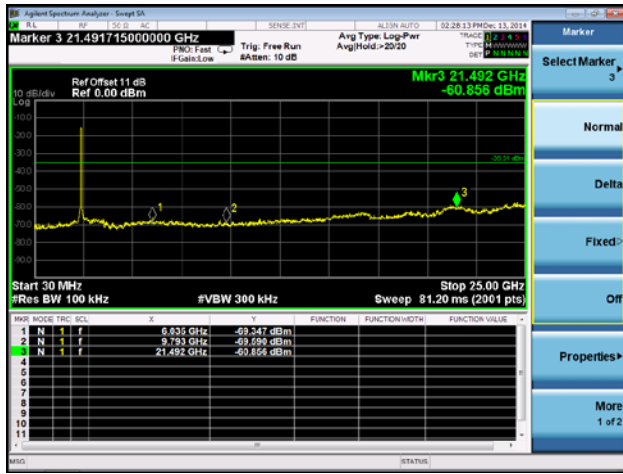
802.11n-HT40 Out-of-Band Emissions
Channel 03 (2422MHz)
100kHz PSD reference Level

Low Band Edge

Spurious Emission 30MHz ~ 25GHz

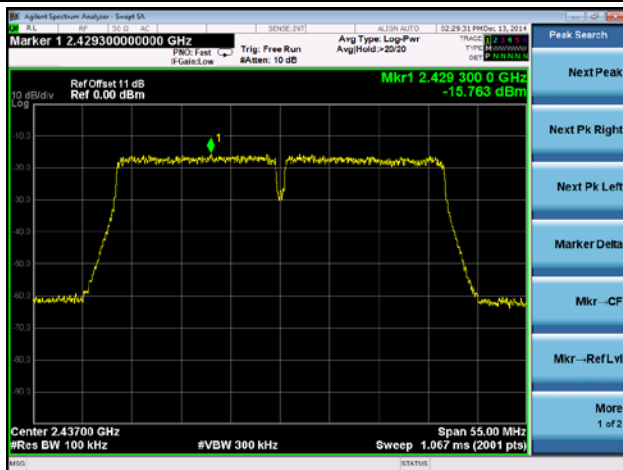

Channel 06 (2437MHz)

100kHz PSD reference Level



Spurious Emission 30MHz ~ 25GHz

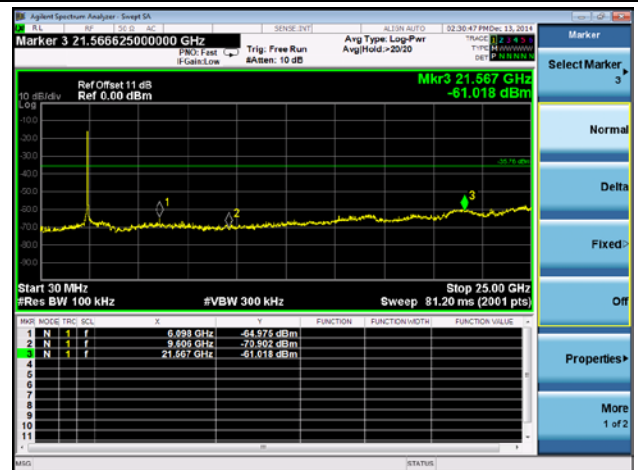

Channel 09 (2452MHz)

100kHz PSD dB reference Level

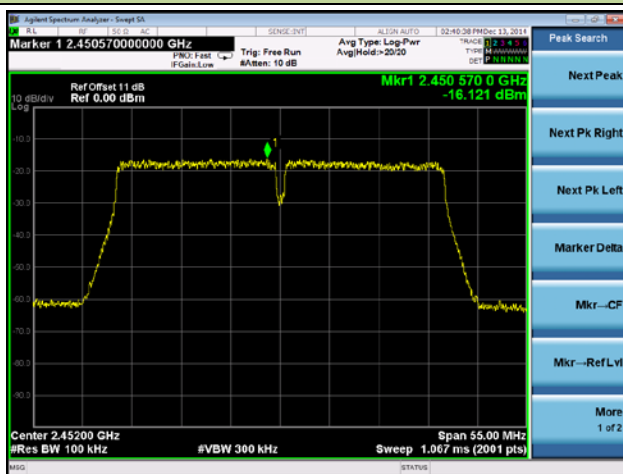

High Band Edge

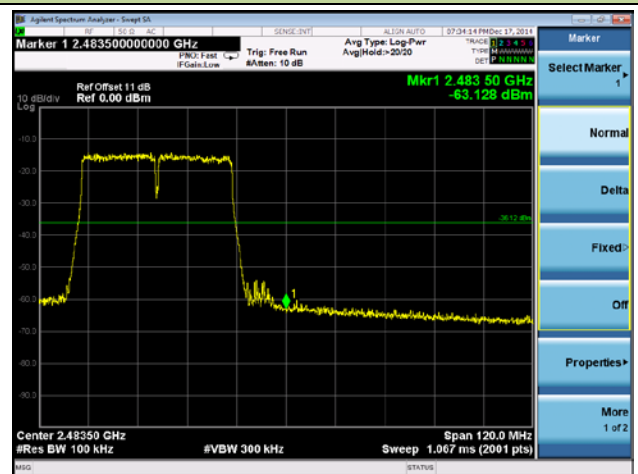

Spurious Emission 30MHz ~ 25GHz

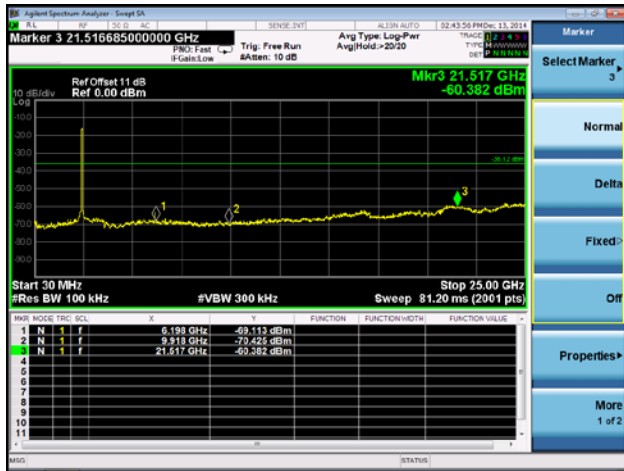

7.6. Radiated Spurious Emission Measurement

7.6.1. Test Limit

All out of band emissions appearing in a restricted band as specified in Section 15.205 of the Title 47 CFR must not exceed the limits shown in Table per Section 15.209.

FCC Part 15 Subpart C Paragraph 15.209		
Frequency [MHz]	Field Strength [V/m]	Measured Distance [Meters]
0.009 – 0.490	2400/F (kHz)	300
0.490 – 1.705	24000/F (kHz)	30
1.705 - 30	30	30
30 - 88	100	3
88 - 216	150	3
216 - 960	200	3
Above 960	500	3

7.6.2. Test Procedure Used

KDB 558074 D01v03r02 – Section 12.2.3 (quasi-peak measurements)

KDB 558074 D01v03r02 – Section 12.2.4 (peak power measurements)

KDB 558074 D01v03r02 – Section 12.2.5 (average power measurements)

7.6.3. Test Setting

Peak Field Strength Measurements per Section 12.2.4 of KDB 558074 D01v03r02

1. Analyzer center frequency was set to the frequency of the radiated spurious emission of interest
2. RBW = as specified in Table 1
3. VBW = 3MHz
4. Detector = peak
5. Sweep time = auto couple

6. Trace mode = max hold

7. Trace was allowed to stabilize

Table 1—RBW as a function of frequency

Frequency	RBW
9 ~ 150 kHz	200 ~ 300 Hz
0.15 ~ 30 MHz	9 ~ 10 kHz
30 ~ 1000 MHz	100 ~ 120 kHz
> 1000 MHz	1 MHz

Average Field Strength Measurements per Section 12.2.5.1 of KDB 558074 D01v03r02

1. RBW = 1MHz.
2. VBW $\geq 3 \times$ RBW.
3. Detector = RMS, if span/(# of points in sweep) \leq (RBW/2). Satisfying this condition may require increasing the number of points in the sweep or reducing the span. If this condition cannot be satisfied, then the detector mode shall be set to peak.
4. Averaging type = power (*i.e.*, RMS).
 - As an alternative, the detector and averaging type may be set for linear voltage averaging.
 - Some instruments require linear display mode in order to use linear voltage averaging. Log or dB averaging shall not be used.
5. Sweep time = auto.
6. Perform a trace average of at least 100 traces.

7.6.4. Test Setup

9kHz ~ 30MHz Test Setup:

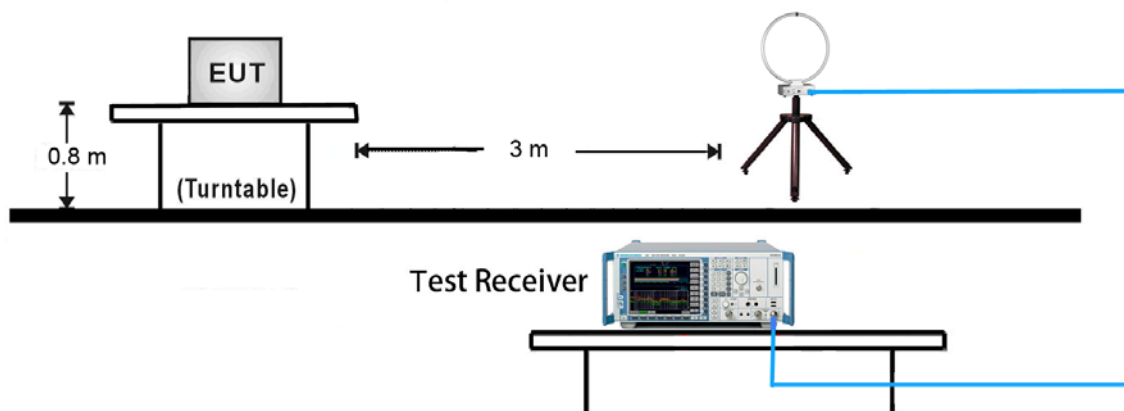

30MHz ~ 1GHz Test Setup:

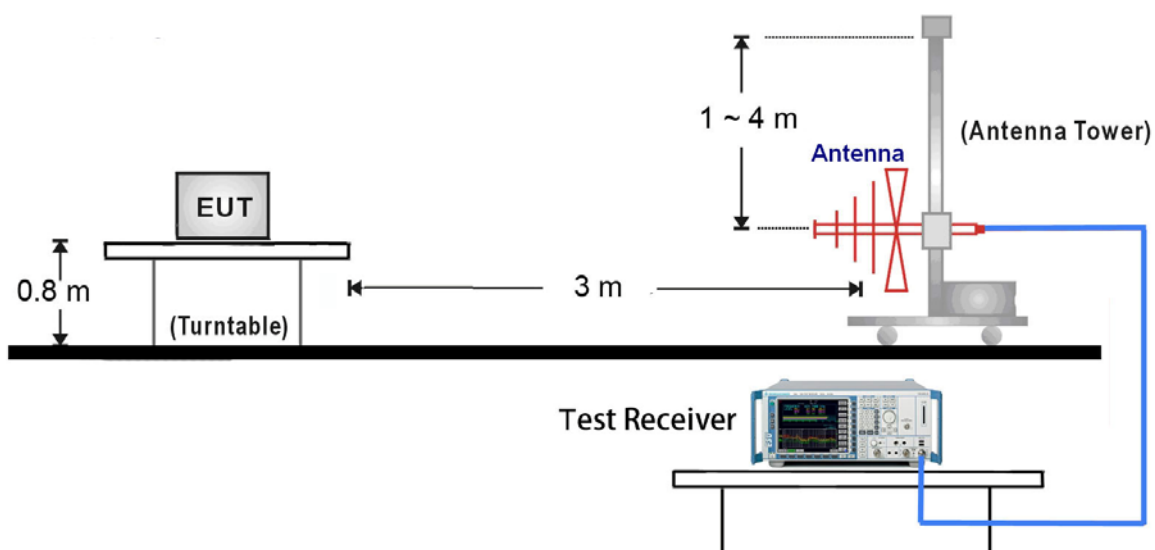

1GHz ~ 25GHz Test Setup:

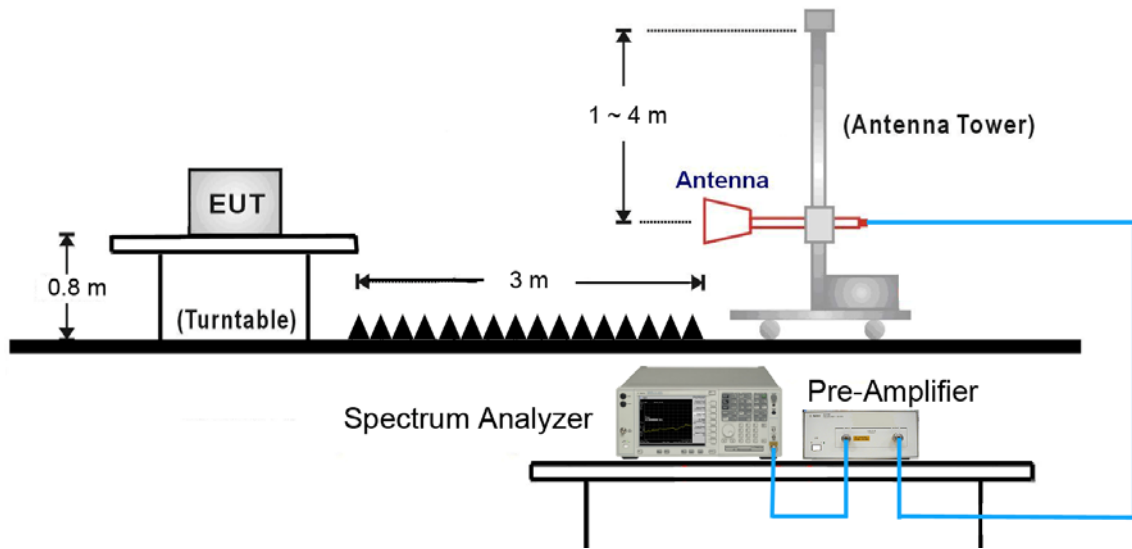

7.6.5. Test Result

Test Mode:	802.11b	Test Site:	AC1
Test Channel:	01	Test Engineer:	Knight Lu
Remark:	1. Average measurement was not performed if peak level lower than average limit. 2. The worst case of Radiated Spurious Emission. 3. Other frequency was 20dB below limit line within 1-18GHz, there is not show in the report.		

Mark	Frequency (MHz)	Reading Level (dBμV)	Factor (dB)	Measure Level (dBμV/m)	Limit (dBμV/m)	Margin (dB)	Detector	Polarization
*	3156.0	37.1	5.1	42.2	76.1	-33.9	Peak	Horizontal
*	4415.0	36.0	7.0	43.0	76.1	-33.1	Peak	Horizontal
	4825.0	39.2	7.9	47.1	74.0	-26.9	Peak	Horizontal
	7255.0	36.1	15.7	51.8	74.0	-22.2	Peak	Horizontal
*	3166.0	36.4	5.1	41.5	76.1	-34.6	Peak	Vertical
*	4426.0	36.1	7.0	43.1	76.1	-33.0	Peak	Vertical
	4825.0	40.6	7.9	48.5	74.0	-25.5	Peak	Vertical
	7251.0	36.6	15.7	52.3	74.0	-21.7	Peak	Vertical

Note 1: "*" is not in restricted band, its limit is 20dBc of the fundamental emission level (96.1dBμV/m) or 15.209 which is higher.

Note 2: Measure Level (dBμV/m) = Reading Level (dBμV) + Factor (dB)

Factor (dB) = Cable Loss (dB) + Antenna Factor (dB/m) - Pre_Amplifier Gain (dB)

The worst case of Radiated Emission below 1GHz:

Site: AC1	Time: 2014/12/13 - 10:37
Limit: FCC_Part15.209_RE(3m)	Engineer: Knight Lu
Probe: VULB9162_0.03-8GHz	Polarity: Horizontal
EUT: 9.6 Inch Tablet	Power: By Battery
Worse Case Mode: 802.11b at channel 2462MHz	

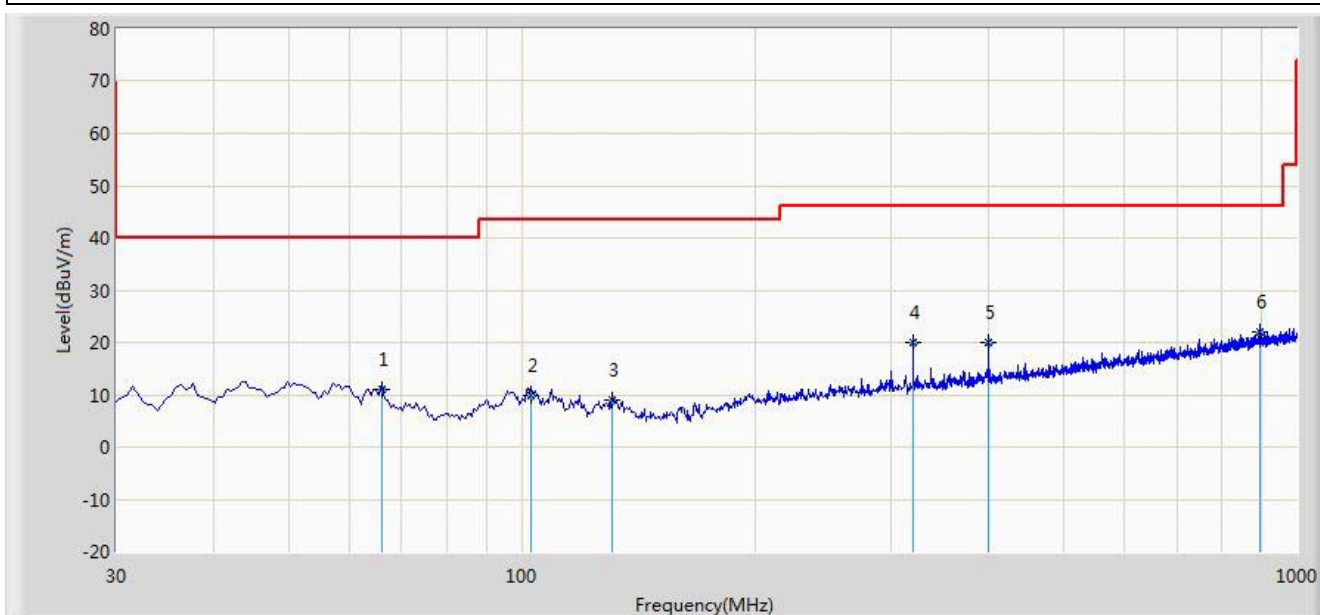

No	Flag	Mark	Frequency (MHz)	Measure Level (dBuV/m)	Reading Level (dBuV)	Over Limit (dB)	Limit (dBuV/m)	Factor (dB)	Type
1			65.890	11.084	30.159	-28.916	40.000	-19.075	QP
2			102.750	9.952	28.223	-33.548	43.500	-18.270	QP
3			130.880	9.121	30.526	-34.379	43.500	-21.405	QP
4			320.030	20.070	36.518	-25.930	46.000	-16.448	QP
5			400.055	20.067	34.916	-25.933	46.000	-14.849	QP
6		*	896.210	22.000	29.526	-24.000	46.000	-7.526	QP

Note: Measure Level (dBuV/m) = Reading Level (dBuV) + Factor (dB)

Factor (dB) = Cable Loss (dB) + Antenna Factor (dB/m)

Site: AC1	Time: 2014/12/13 - 09:16
Limit: FCC_Part15.209_RE(3m)	Engineer: Knight Lu
Probe: VULB9162_0.03-8GHz	Polarity: Vertical
EUT: 9.6 Inch Tablet	Power: By Battery
Worse Case Mode: 802.11b at channel 2462MHz	

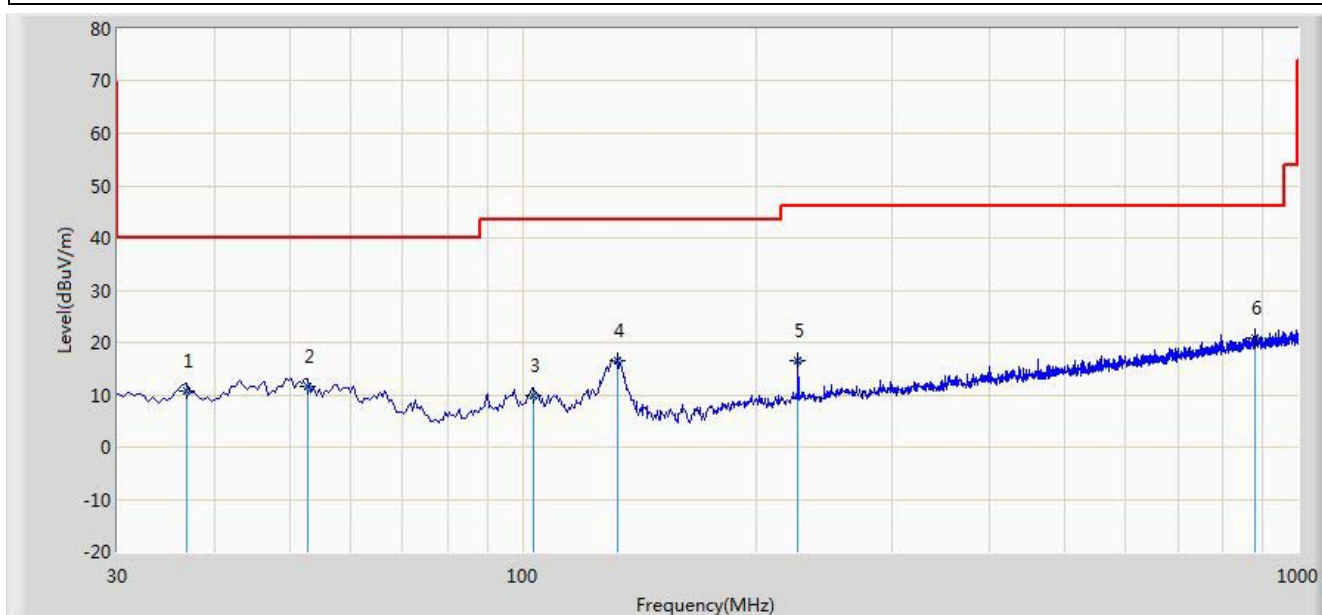

No	Flag	Mark	Frequency (MHz)	Measure Level (dBuV/m)	Reading Level (dBuV)	Over Limit (dB)	Limit (dBuV/m)	Factor (dB)	Type
1			36.790	10.828	29.005	-29.172	40.000	-18.177	QP
2			52.795	11.614	28.006	-28.386	40.000	-16.391	QP
3			103.235	9.728	28.008	-33.772	43.500	-18.279	QP
4			132.820	16.537	38.120	-26.963	43.500	-21.583	QP
5			226.425	16.597	35.203	-29.403	46.000	-18.605	QP
6		*	880.205	20.894	28.613	-25.106	46.000	-7.720	QP

Note: Measure Level (dBuV/m) = Reading Level (dBuV) + Factor (dB)

Factor (dB) = Cable Loss (dB) + Antenna Factor (dB/m)

Site: AC1	Time: 2014/12/13 - 15:32
Limit: FCC_Part15.209_RE(3m)	Engineer: Knight Lu
Probe: FMZB1519_0.009-30MHz	Polarity: Face On
EUT: 9.6 Inch Tablet	Power: By Battery
Note: There is the ambient noise within frequency range 9kHz~30MHz.	

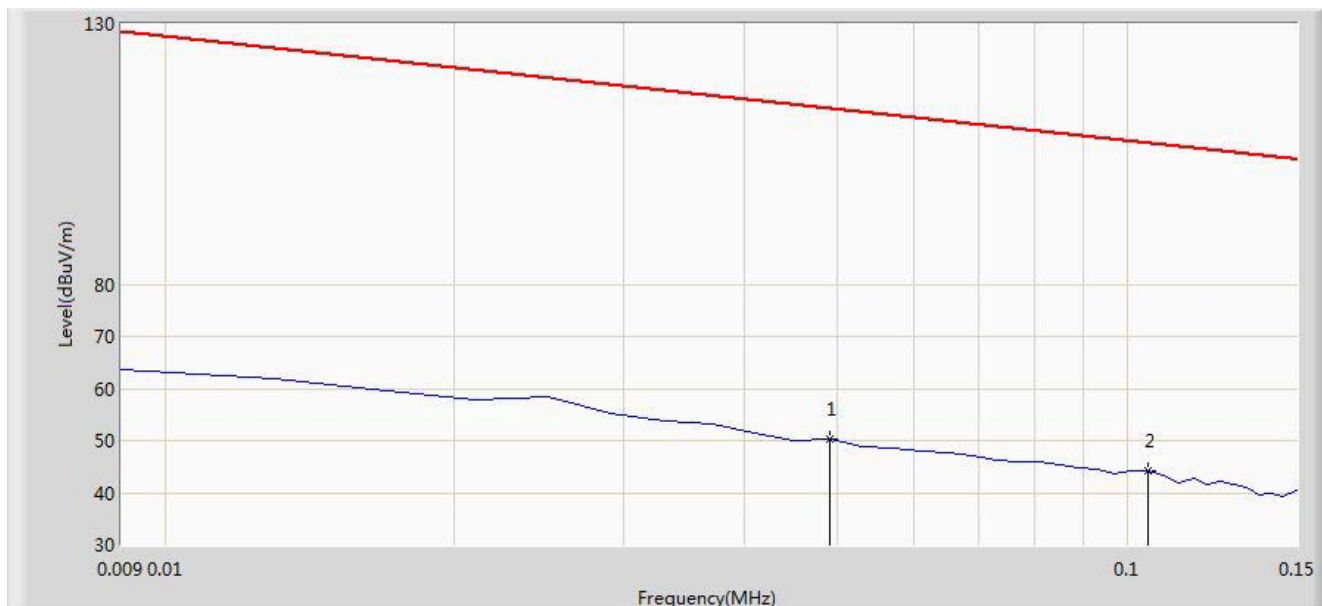

No	Flag	Mark	Frequency (MHz)	Measure Level (dBuV/m)	Reading Level (dBuV)	Over Limit (dB)	Limit (dBuV/m)	Factor (dB)	Type
1			0.049	50.367	29.861	-63.788	114.155	20.505	QP
2		*	0.105	44.143	23.996	-63.392	107.535	20.147	QP

Note: Measure Level (dBuV/m) = Reading Level (dBuV) + Factor (dB)

Factor (dB) = Cable Loss (dB) + Antenna Factor (dB/m)

Site: AC1	Time: 2014/12/13 - 15:41
Limit: FCC_Part15.209_RE(3m)	Engineer: Knight Lu
Probe: FMZB1519_0.009-30MHz	Polarity: Face On
EUT: 9.6 Inch Tablet	Power: By Battery
Note: There is the ambient noise within frequency range 9kHz~30MHz.	

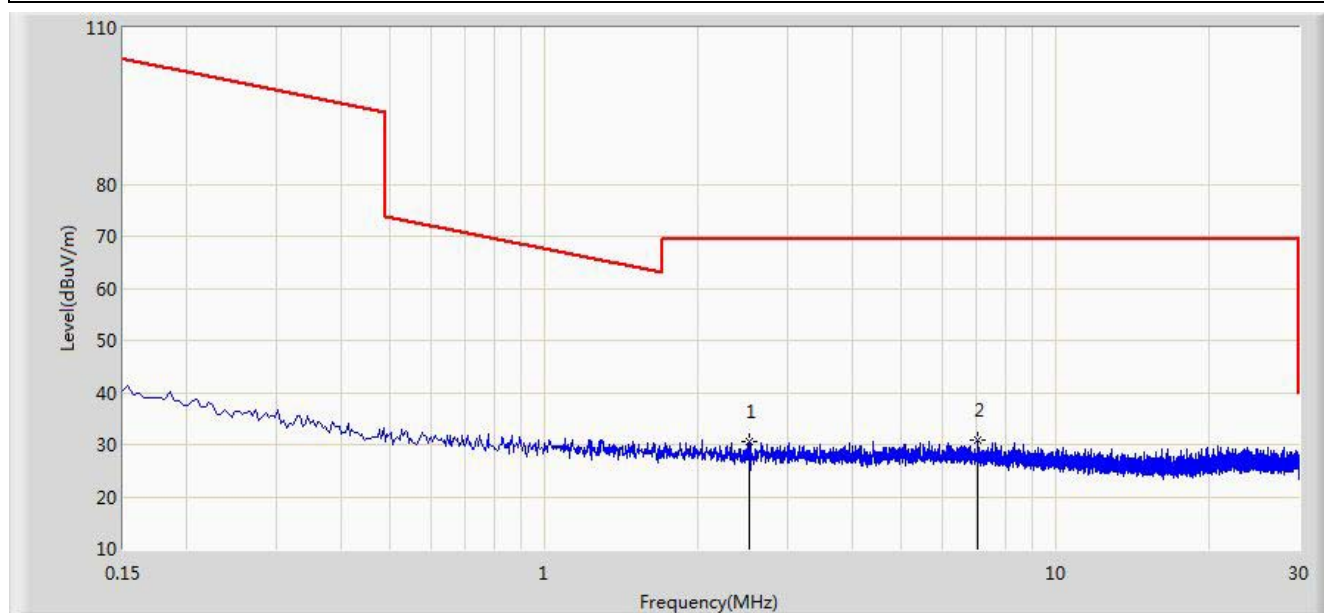

No	Flag	Mark	Frequency (MHz)	Measure Level (dBuV/m)	Reading Level (dBuV)	Over Limit (dB)	Limit (dBuV/m)	Factor (dB)	Type
1			2.513	30.495	10.336	-39.005	69.500	20.159	QP
2		*	7.041	30.974	10.579	-38.526	69.500	20.395	QP

Note: Measure Level (dB μ V/m) = Reading Level (dB μ V) + Factor (dB)

Factor (dB) = Cable Loss (dB) + Antenna Factor (dB/m)

Site: AC1	Time: 2014/12/13 - 15:45
Limit: FCC_Part15.209_RE(3m)	Engineer: Knight Lu
Probe: BBHA9170_18-40GHz	Polarity: Horizontal
EUT: 9.6 Inch Tablet	Power: By Battery
Note: There is the ambient noise within frequency range 18 ~ 25GHz.	

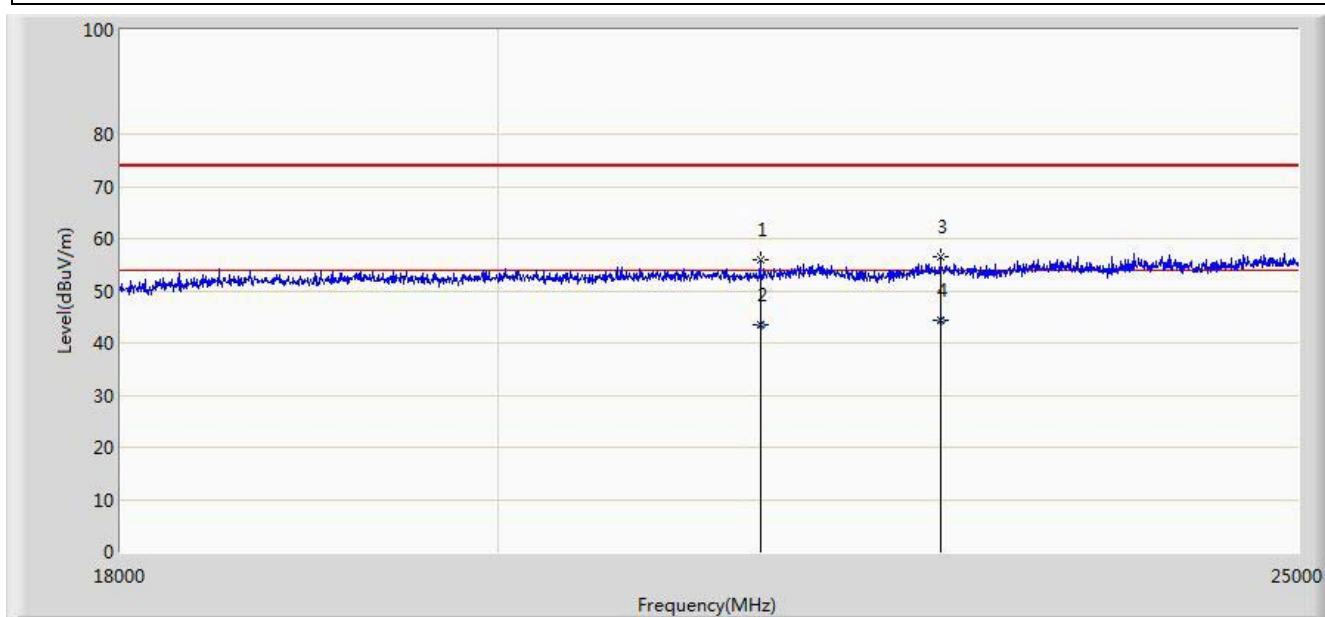

No	Flag	Mark	Frequency (MHz)	Measure Level (dBuV/m)	Reading Level (dBuV)	Over Limit (dB)	Limit (dBuV/m)	Factor (dB)	Type
1			21517.500	55.869	17.883	-18.131	74.000	37.986	PK
2			21517.650	43.351	5.365	-10.649	54.000	37.986	AV
3			22630.500	56.509	18.223	-17.491	74.000	38.286	PK
4		*	22630.540	44.310	6.024	-9.690	54.000	38.286	AV

Note: Measure Level (dBuV/m) = Reading Level (dBuV) + Factor (dB)

Factor (dB) = Cable Loss (dB) + Antenna Factor (dB/m)

Site: AC1	Time: 2014/12/13 - 15:59
Limit: FCC_Part15.209_RE(3m)	Engineer: Knight Lu
Probe: BBHA9170_18-40GHz	Polarity: Vertical
EUT: 9.6 Inch Tablet	Power: By Battery
Note: There is the ambient noise within frequency range 18 ~ 25GHz.	

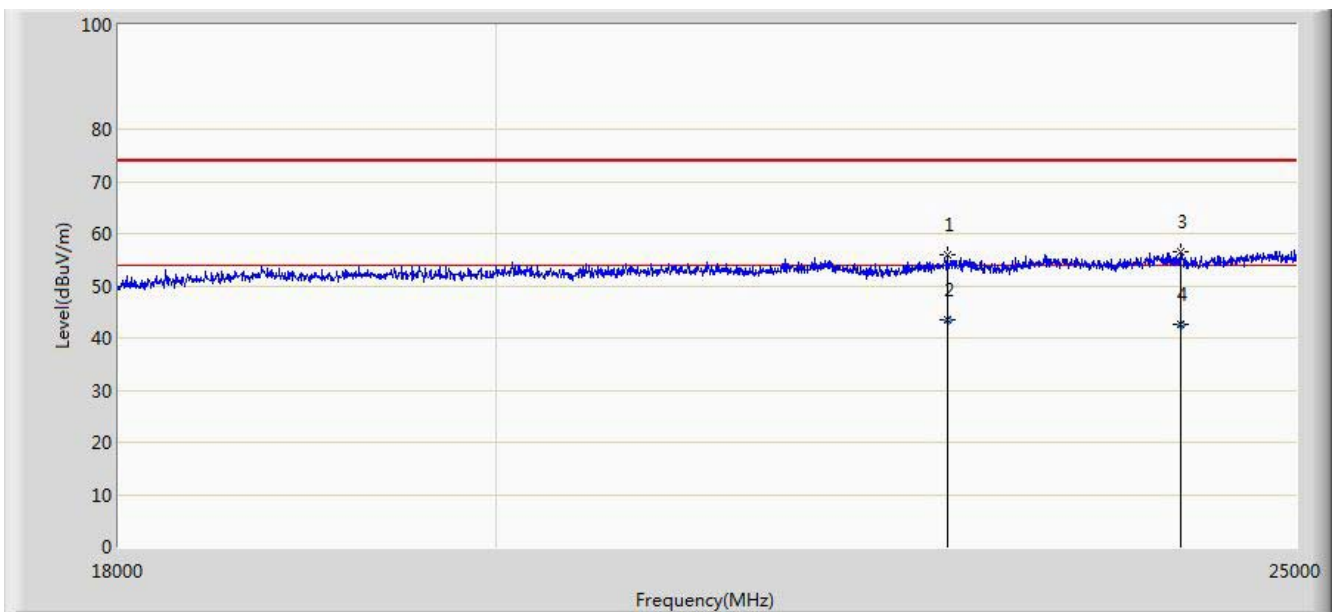

No	Flag	Mark	Frequency (MHz)	Measure Level (dBuV/m)	Reading Level (dBuV)	Over Limit (dB)	Limit (dBuV/m)	Factor (dB)	Type
1			22686.500	55.811	17.457	-18.189	74.000	38.354	PK
2		*	22686.540	43.598	5.244	-10.402	54.000	38.354	AV
3			24205.500	56.430	17.607	-17.570	74.000	38.823	PK
4			24205.658	42.518	3.695	-11.482	54.000	38.823	AV

Note: Measure Level (dB μ V/m) = Reading Level (dB μ V) + Factor (dB)

Factor (dB) = Cable Loss (dB) + Antenna Factor (dB/m)

7.7. Radiated Restricted Band Edge Measurement

7.7.1. Test Result

Site: AC1	Time: 2014/12/15 - 10:32
Limit: FCC_Part15.209_RE(3m)	Engineer: Knight Lu
Probe: BBHA9120D_1-18GHz	Polarity: Horizontal
EUT: 9.6 Inch Tablet	Power: By Battery
Worse Case Mode : 802.11b at channel 2412MHz	

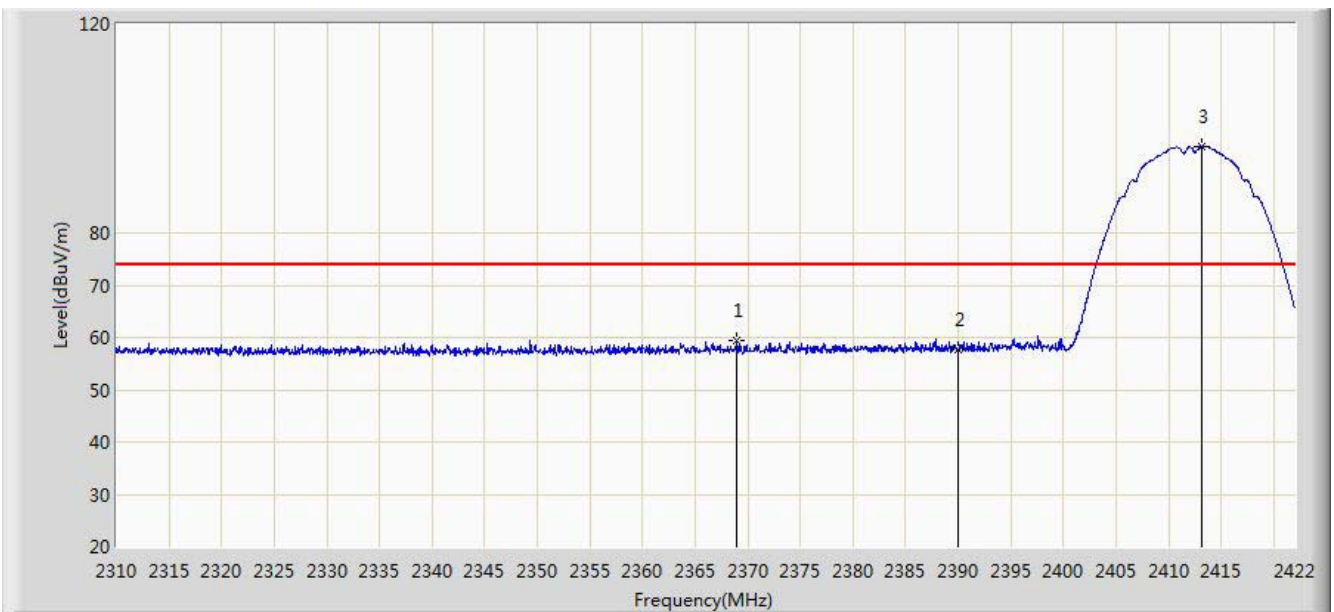

No	Flag	Mark	Frequency (MHz)	Measure Level (dBuV/m)	Reading Level (dBuV)	Over Limit (dB)	Limit (dBuV/m)	Factor (dB)	Type
1			2368.968	59.413	27.524	-14.587	74.000	31.889	PK
2			2390.000	57.579	25.723	-16.421	74.000	31.856	PK
3		*	2413.208	96.613	64.794	N/A	N/A	31.819	PK

Note: Measure Level (dB μ V/m) = Reading Level (dB μ V) + Factor (dB)

Factor (dB) = Cable Loss (dB) + Antenna Factor (dB/m)

Site: AC1	Time: 2014/12/15 - 10:36
Limit: FCC_Part15.209_RE(3m)	Engineer: Knight Lu
Probe: BBHA9120D_1-18GHz	Polarity: Horizontal
EUT: 9.6 Inch Tablet	Power: By Battery
Worse Case Mode : 802.11b at channel 2412MHz	

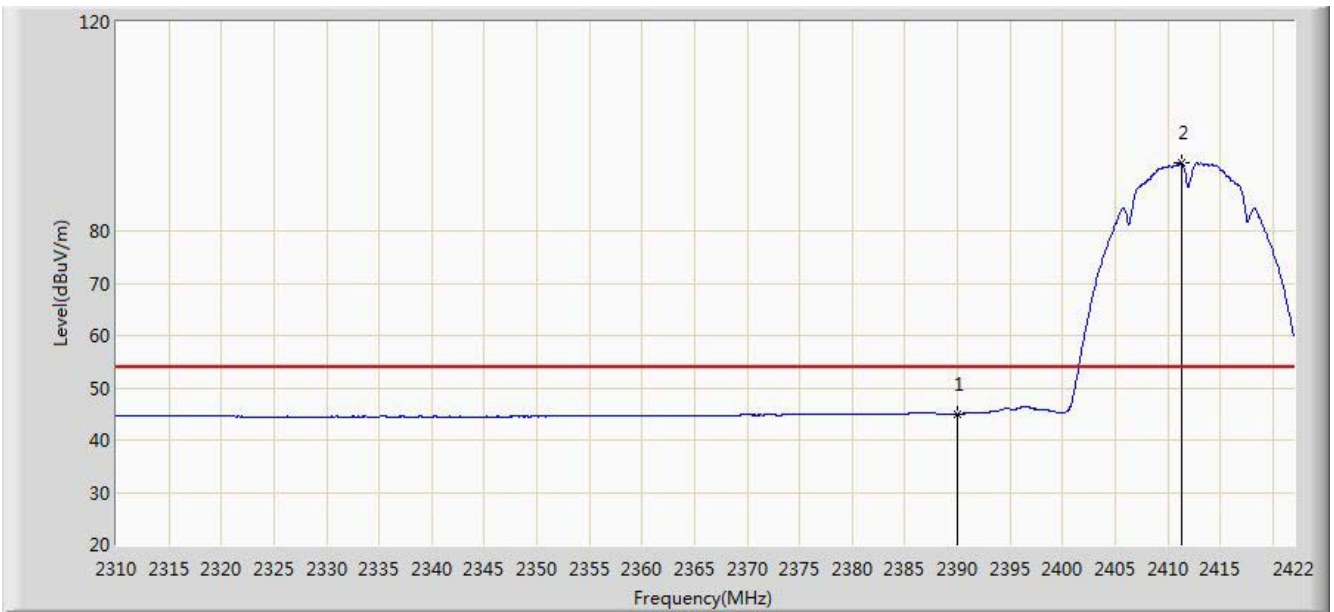

No	Flag	Mark	Frequency (MHz)	Measure Level (dBuV/m)	Reading Level (dBuV)	Over Limit (dB)	Limit (dBuV/m)	Factor (dB)	Type
1			2390.000	44.979	13.123	-9.021	54.000	31.856	AV
2		*	2411.304	93.000	61.178	N/A	N/A	31.822	AV

Note: Measure Level (dB μ V/m) = Reading Level (dB μ V) + Factor (dB)

Factor (dB) = Cable Loss (dB) + Antenna Factor (dB/m)

Limit: FCC_Part15.209_RE(3m)	Engineer: Knight Lu
Probe: BBHA9120D_1-18GHz	Polarity: Vertical
EUT: 9.6 Inch Tablet	Power: By Battery
Worse Case Mode : 802.11b at channel 2412MHz	

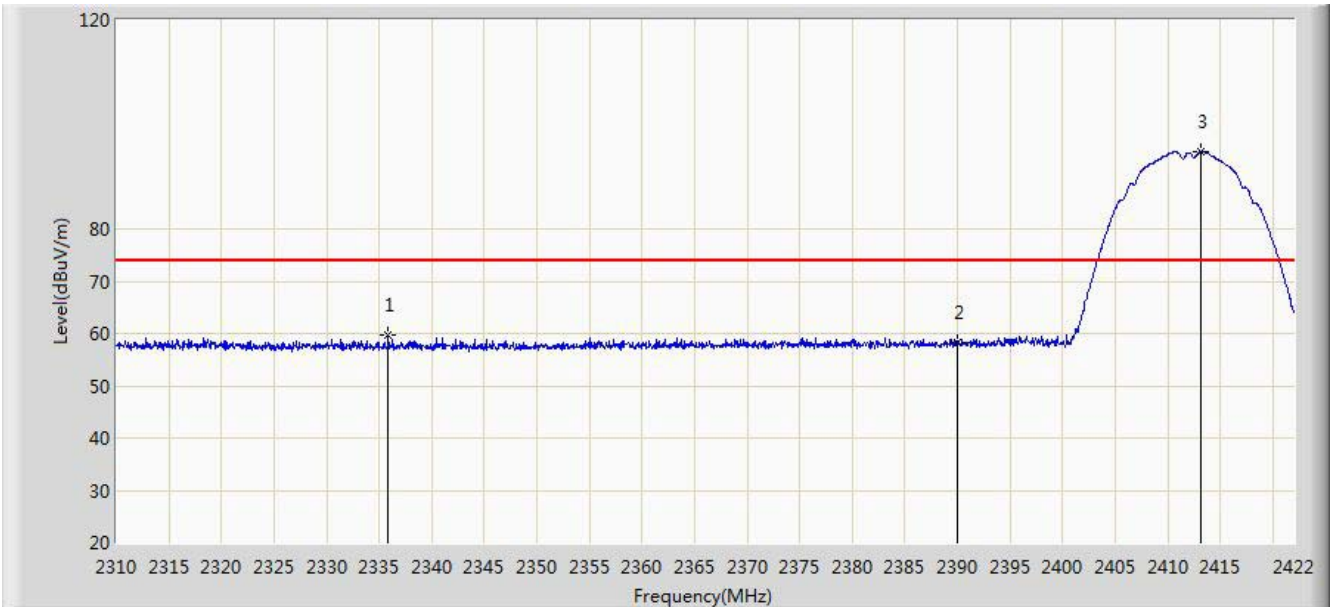

No	Flag	Mark	Frequency (MHz)	Measure Level (dBuV/m)	Reading Level (dBuV)	Over Limit (dB)	Limit (dBuV/m)	Factor (dB)	Type
1			2335.872	59.759	27.777	-14.24 1	74.000	31.983	PK
2			2390.000	58.228	26.372	-15.772	74.000	31.856	PK
3		*	2413.152	94.701	62.882	N/A	N/A	31.819	PK

Note: Measure Level (dB μ V/m) = Reading Level (dB μ V) + Factor (dB)

Factor (dB) = Cable Loss (dB) + Antenna Factor (dB/m)

Site: AC1	Time: 2014/12/15 - 10:40
Limit: FCC_Part15.209_RE(3m)	Engineer: Knight Lu
Probe: BBHA9120D_1-18GHz	Polarity: Vertical
EUT: 9.6 Inch Tablet	Power: By Battery
Worse Case Mode : 802.11b at channel 2412MHz	

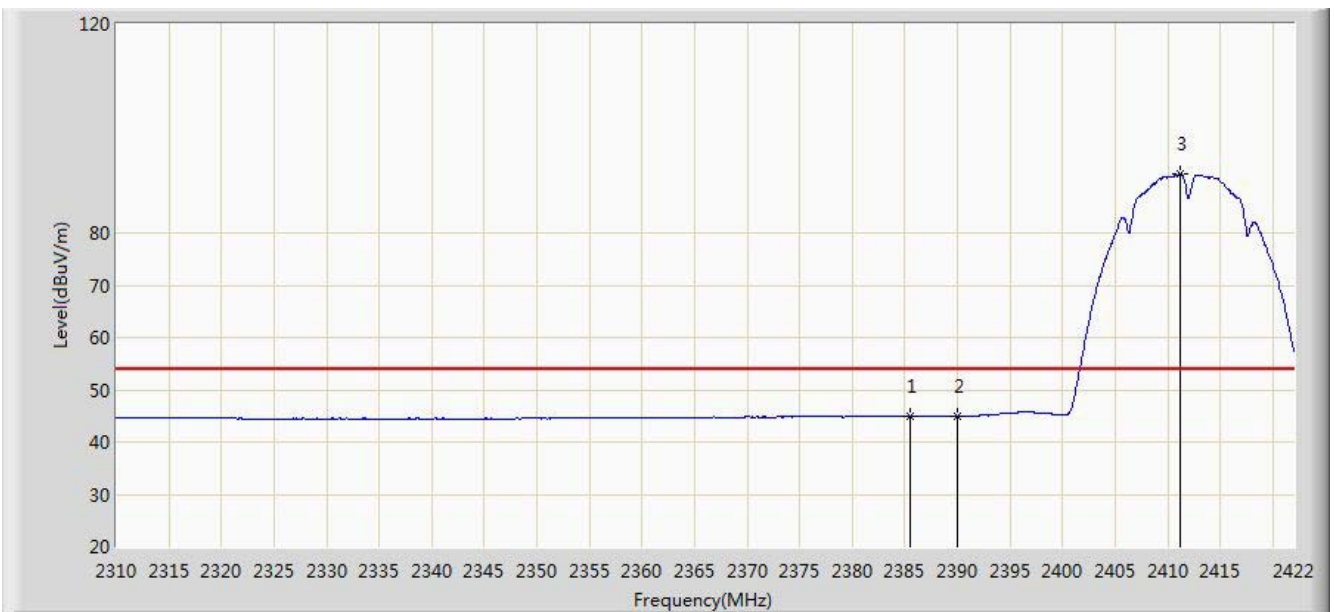

No	Flag	Mark	Frequency (MHz)	Measure Level (dBuV/m)	Reading Level (dBuV)	Over Limit (dB)	Limit (dBuV/m)	Factor (dB)	Type
1			2385.544	45.014	13.151	-8.986	54.000	31.863	AV
2			2390.000	44.953	13.097	-9.047	54.000	31.856	AV
3		*	2411.136	91.297	59.475	N/A	N/A	31.822	AV

Note: Measure Level (dB μ V/m) = Reading Level (dB μ V) + Factor (dB)

Factor (dB) = Cable Loss (dB) + Antenna Factor (dB/m)

Site: AC1	Time: 2014/12/15 - 11:01
Limit: FCC_Part15.209_RE(3m)	Engineer: Knight Lu
Probe: BBHA9120D_1-18GHz	Polarity: Horizontal
EUT: 9.6 Inch Tablet	Power: By Battery
Worse Case Mode : 802.11n-HT40 at channel 2452MHz	

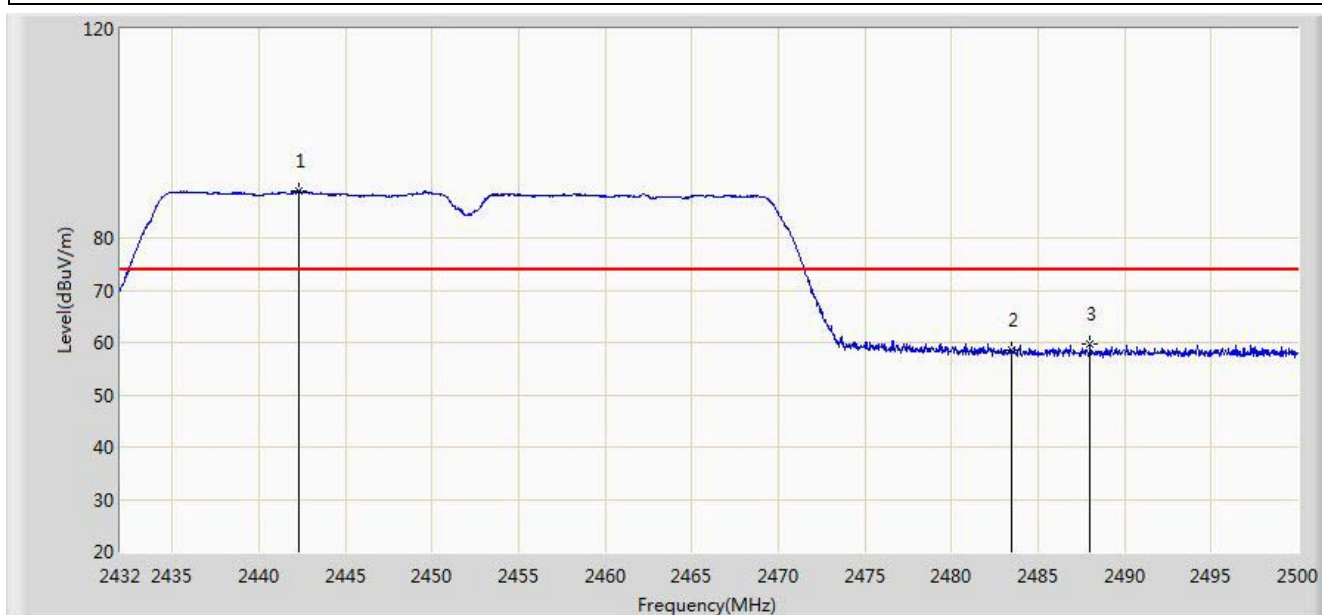

No	Flag	Mark	Frequency (MHz)	Measure Level (dBuV/m)	Reading Level (dBuV)	Over Limit (dB)	Limit (dBuV/m)	Factor (dB)	Type
1		*	2442.302	89.122	57.350	N/A	N/A	31.772	PK
2			2483.500	58.421	26.574	-15.579	74.000	31.848	PK
3			2487.998	59.647	27.788	-14.353	74.000	31.859	PK

Note: Measure Level (dB μ V/m) = Reading Level (dB μ V) + Factor (dB)

Factor (dB) = Cable Loss (dB) + Antenna Factor (dB/m)

Site: AC1	Time: 2014/12/15 - 11:10
Limit: FCC_Part15.209_RE(3m)	Engineer: Knight Lu
Probe: BBHA9120D_1-18GHz	Polarity: Horizontal
EUT: 9.6 Inch Tablet	Power: By Battery
Worse Case Mode : 802.11n-HT40 at channel 2452MHz	

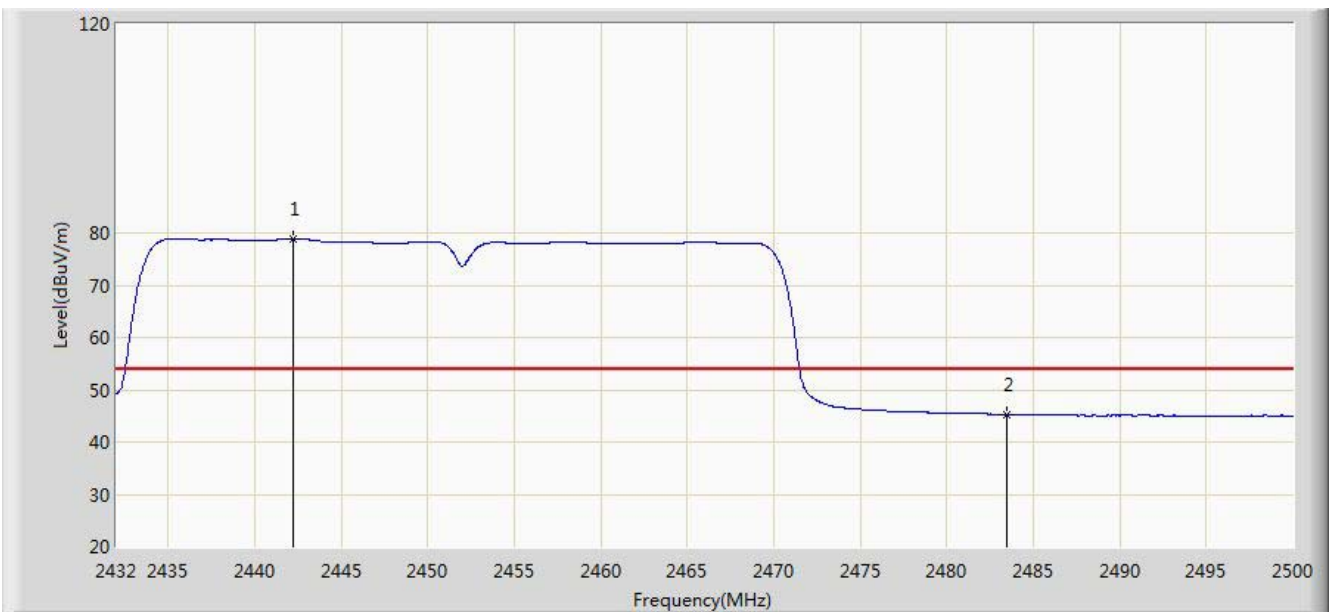

No	Flag	Mark	Frequency (MHz)	Measure Level (dBuV/m)	Reading Level (dBuV)	Over Limit (dB)	Limit (dBuV/m)	Factor (dB)	Type
1		*	2442.234	78.877	47.105	N/A	N/A	31.772	AV
2			2483.500	45.274	13.427	-8.726	54.000	31.848	AV

Note: Measure Level (dB μ V/m) = Reading Level (dB μ V) + Factor (dB)

Factor (dB) = Cable Loss (dB) + Antenna Factor (dB/m)

Site: AC1	Time: 2014/12/15 - 11:10
Limit: FCC_Part15.209_RE(3m)	Engineer: Knight Lu
Probe: BBHA9120D_1-18GHz	Polarity: Vertical
EUT: 9.6 Inch Tablet	Power: By Battery
Worse Case Mode : 802.11n-HT40 at channel 2452MHz	

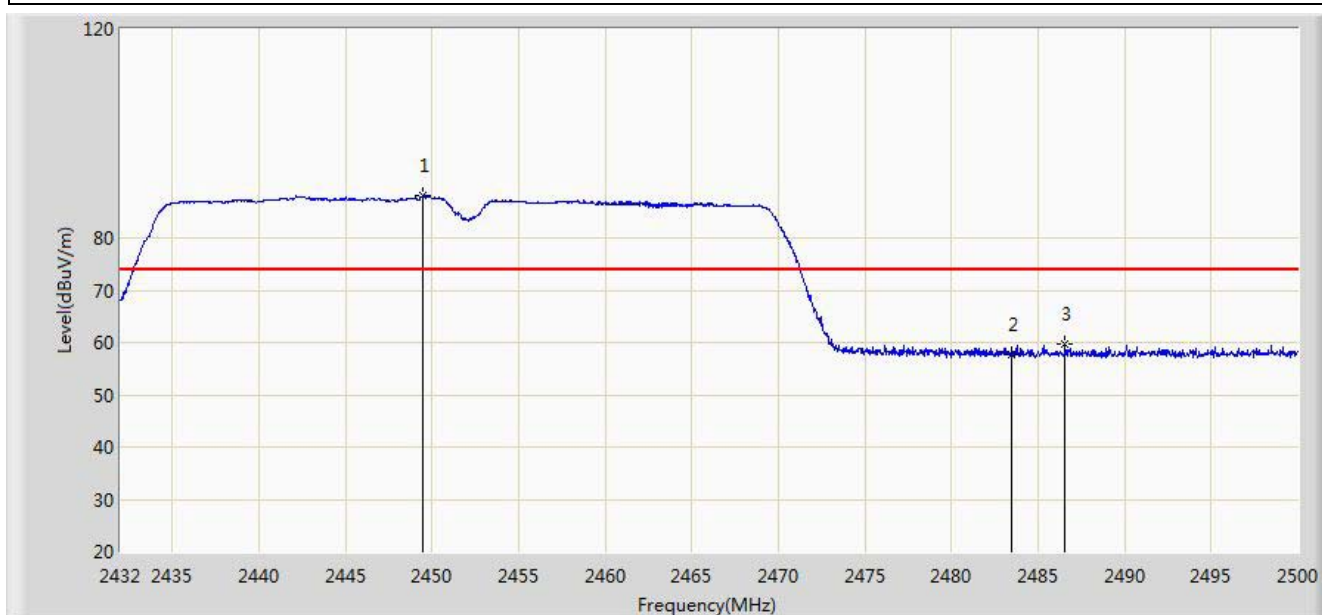

No	Flag	Mark	Frequency (MHz)	Measure Level (dBuV/m)	Reading Level (dBuV)	Over Limit (dB)	Limit (dBuV/m)	Factor (dB)	Type
1		*	2449.510	88.011	56.239	N/A	N/A	31.772	PK
2			2483.500	57.660	25.813	-16.340	74.000	31.848	PK
3			2486.536	59.597	27.742	-14.403	74.000	31.855	PK

Note: Measure Level (dB μ V/m) = Reading Level (dB μ V) + Factor (dB)

Factor (dB) = Cable Loss (dB) + Antenna Factor (dB/m)

Site: AC1	Time: 2014/12/15 - 11:14
Limit: FCC_Part15.209_RE(3m)	Engineer: Knight Lu
Probe: BBHA9120D_1-18GHz	Polarity: Vertical
EUT: 9.6 Inch Tablet	Power: By Battery
Worse Case Mode : 802.11n-HT40 at channel 2452MHz	

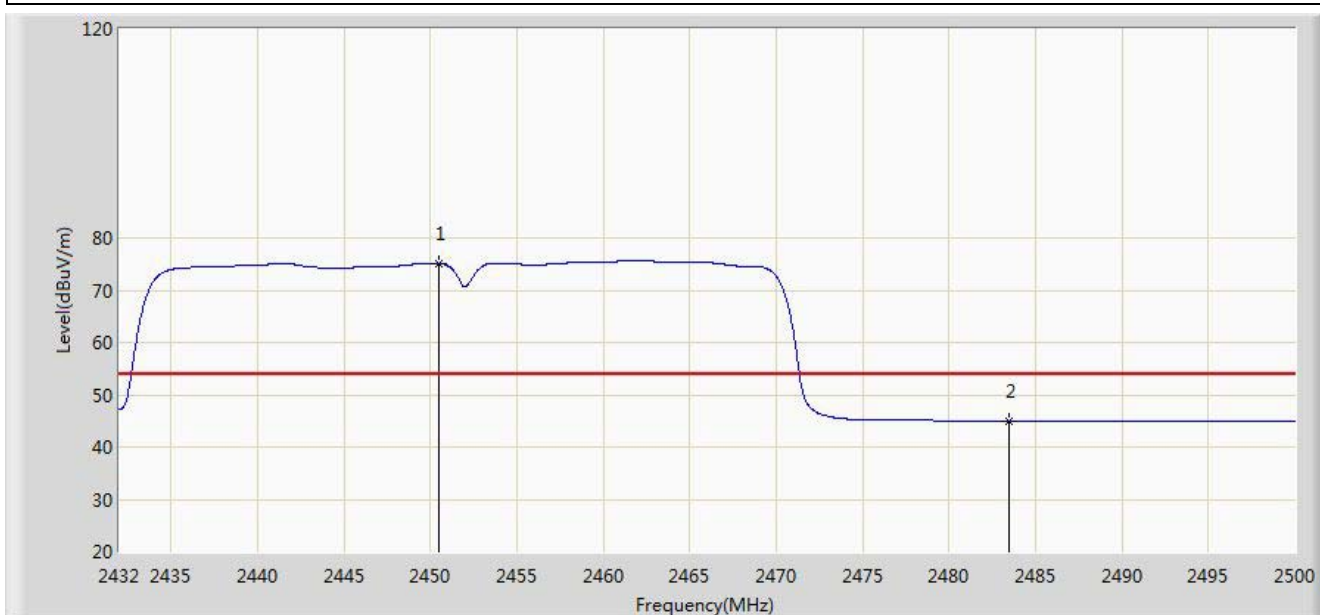

No	Flag	Mark	Frequency (MHz)	Measure Level (dBuV/m)	Reading Level (dBuV)	Over Limit (dB)	Limit (dBuV/m)	Factor (dB)	Type
1		*	2450.462	75.192	43.419	N/A	N/A	31.773	AV
2			2483.500	44.909	13.062	-9.091	54.000	31.848	AV

Note: Measure Level (dB μ V/m) = Reading Level (dB μ V) + Factor (dB)

Factor (dB) = Cable Loss (dB) + Antenna Factor (dB/m)

7.8. AC Conducted Emissions Measurement

7.8.1. Test Limit

FCC Part 15 Subpart C Paragraph 15.207 Limits		
Frequency (MHz)	QP (dBuV)	AV (dBuV)
0.15 - 0.50	66 - 56	56 - 46
0.50 - 5.0	56	46
5.0 - 30	60	50

Note 1: The lower limit shall apply at the transition frequencies.

Note 2: The limit decreases linearly with the logarithm of the frequency in the range 0.15MHz to 0.5MHz.

7.8.2. Test Setup

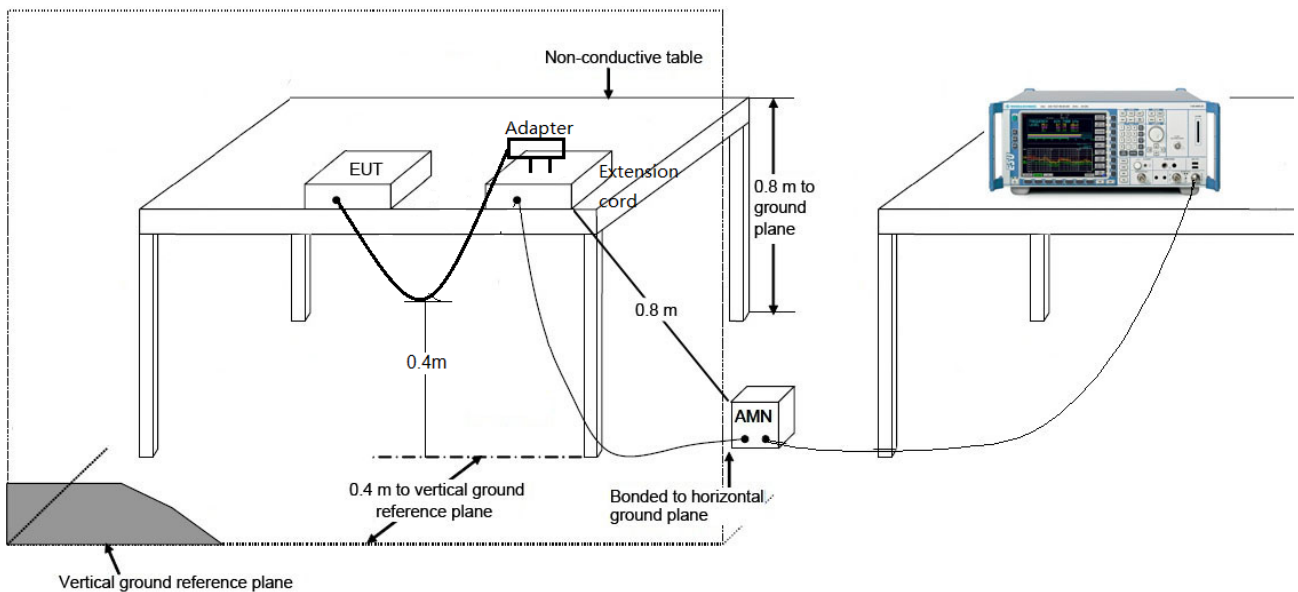

7.8.3. Test Result

Site: SR2	Time: 2014/12/13 - 12:29
Limit: FCC_Part15.207_CE_AC Power	Engineer: Knight Lu
Probe: ENV216_101683_Filter On	Polarity: Line
EUT: 9.6 Inch Tablet	Power: AC 120V/60Hz
Note: Mode 1	

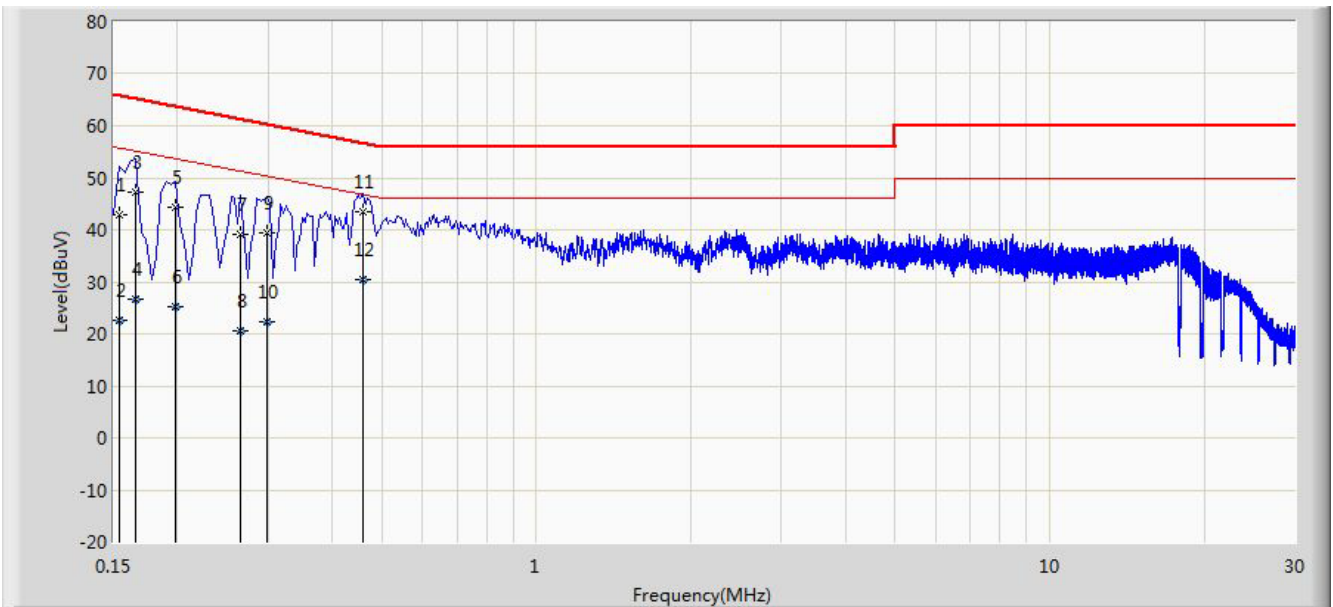

No	Flag	Mark	Frequency (MHz)	Measure Level (dBuV)	Reading Level (dBuV)	Over Limit (dB)	Limit (dBuV)	Factor (dB)	Type
1			0.154	42.786	31.990	-22.996	65.781	10.796	QP
2			0.154	22.702	11.906	-33.080	55.781	10.796	AV
3			0.166	47.126	36.983	-18.032	65.158	10.143	QP
4			0.166	26.626	16.483	-28.532	55.158	10.143	AV
5			0.198	44.216	34.157	-19.478	63.694	10.058	QP
6			0.198	25.141	15.083	-28.553	53.694	10.058	AV
7			0.266	39.184	29.159	-22.058	61.242	10.025	QP
8			0.266	20.646	10.621	-30.596	51.242	10.025	AV
9			0.298	39.421	29.373	-20.877	60.298	10.048	QP
10			0.298	22.246	12.198	-28.053	50.298	10.048	AV
11		*	0.458	43.503	33.361	-13.226	56.729	10.142	QP
12			0.458	30.491	20.349	-16.238	46.729	10.142	AV

Note: Measure Level (dBμV) = Reading Level (dBμV) + Factor (dB)

Factor (dB) = Cable Loss (dB) + LISN Factor (dB)

Site: SR2	Time: 2014/12/13 - 12:37
Limit: FCC_Part15.207_CE_AC Power	Engineer: Knight Lu
Probe: ENV216_101683_Filter On	Polarity: Neutral
EUT: 9.6 Inch Tablet	Power: AC 120V/60Hz
Note: Mode 1	

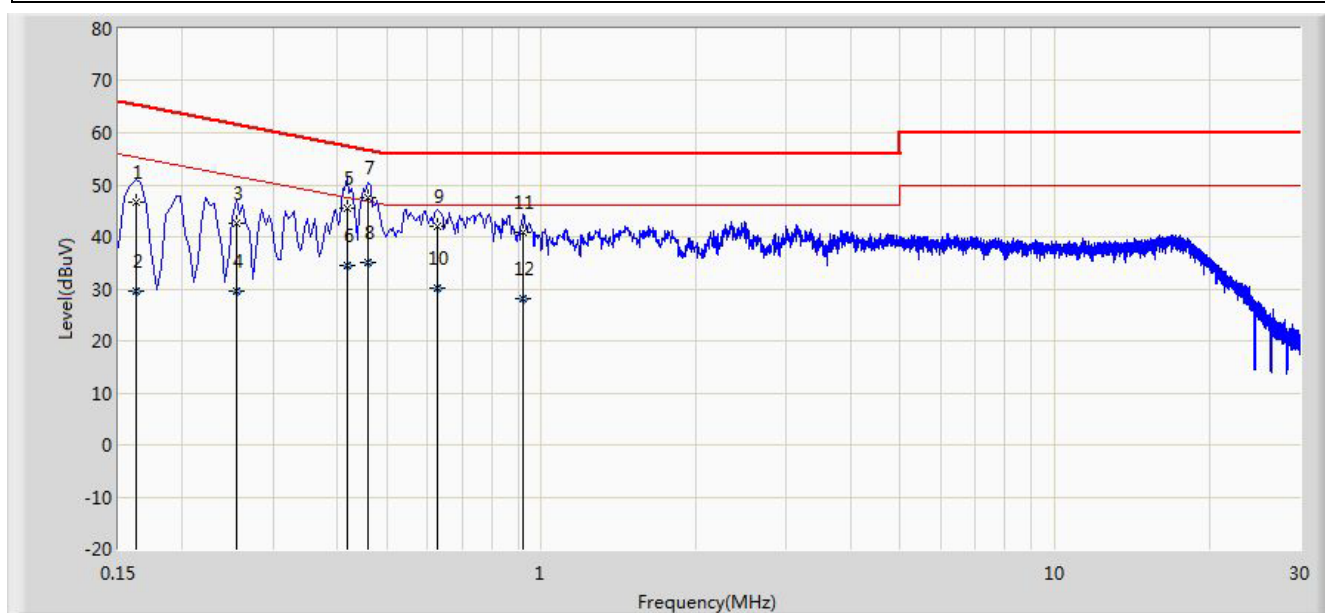

No	Flag	Mark	Frequency (MHz)	Measure Level (dBuV)	Reading Level (dBuV)	Over Limit (dB)	Limit (dBuV)	Factor (dB)	Type
1			0.162	46.674	36.540	-18.686	65.361	10.134	QP
2			0.162	29.597	19.463	-25.764	55.361	10.134	AV
3			0.254	42.549	32.496	-19.077	61.625	10.053	QP
4			0.254	29.620	19.568	-22.005	51.625	10.053	AV
5			0.418	45.511	35.366	-11.977	57.488	10.145	QP
6			0.418	34.508	24.363	-12.980	47.488	10.145	AV
7		*	0.458	47.544	37.379	-9.185	56.729	10.165	QP
8			0.458	34.991	24.826	-11.738	46.729	10.165	AV
9			0.626	41.977	31.868	-14.023	56.000	10.108	QP
10			0.626	30.259	20.151	-15.741	46.000	10.108	AV
11			0.922	40.988	31.039	-15.012	56.000	9.949	QP
12			0.922	28.095	18.146	-17.905	46.000	9.949	AV

Note: Measure Level (dBμV) = Reading Level (dBμV) + Factor (dB)

Factor (dB) = Cable Loss (dB) + LISN Factor (dB)

8. CONCLUSION

The data collected relate only the item(s) tested and show that the **9.6 Inch Tablet FCC ID: 2AAMSHM-9641M** is in compliance with Part 15C of the FCC Rules.

————— The End —————