



## MEASUREMENT REPORT

### FCC PART 15.247 BLE

---

**FCC ID:** 2AAMSHM-7843Q  
**APPLICANT:** SHENZHEN NST INDUSTRY AND TRADE CO., LTD

**Application Type:** Certification  
**Product:** 7.85 Inch Tablet  
**Model No.:** HM-7843Q  
**Brand Name:** Trio  
**FCC Classification:** Digital Transmission System (DTS)  
**FCC Rule Part(s):** Part 15.247  
**Test Procedure(s):** ANSI C63.10-2009, KDB 558074 D01v03r02  
**Test Date:** Nov. 15 ~ 21, 2014

Reviewed By : Robin Wu  
( Robin Wu )  
Approved By : Marlin Chen  
( Marlin Chen )

The test results relate only to the samples tested.

This equipment has been shown to be capable of compliance with the applicable technical standards as indicated in the measurement report and was tested in accordance with the measurement procedures specified in KDB 558074 D01v03r02. Test results reported herein relate only to the item(s) tested.

The test report shall not be reproduced except in full without the written approval of MRT Technology (Suzhou) Co., Ltd.

### Revision History

Report No.	Version	Description	Issue Date
1411RSU01902	Rev. 01	Initial report	11-22-2014

## CONTENTS

Description	Page
<b>1. INTRODUCTION .....</b>	<b>6</b>
1.1. Scope .....	6
1.2. MRT Test Location .....	6
<b>2. PRODUCT INFORMATION .....</b>	<b>7</b>
2.1. Equipment Description.....	7
2.2. Device Capabilities .....	9
2.3. Test Configuration .....	9
2.4. EMI Suppression Device(s)/Modifications.....	9
2.5. Labeling Requirements.....	9
2.6. Test Software .....	9
2.7. Description of Support Units .....	10
<b>3. DESCRIPTION OF TEST .....</b>	<b>11</b>
3.1. Evaluation Procedure .....	11
3.2. AC Line Conducted Emissions .....	11
3.3. Radiated Emissions .....	12
<b>4. ANTENNA REQUIREMENTS.....</b>	<b>13</b>
<b>5. TEST EQUIPMENT CALIBRATION DATE.....</b>	<b>14</b>
<b>6. MEASUREMENT UNCERTAINTY.....</b>	<b>15</b>
<b>7. TEST RESULT .....</b>	<b>16</b>
7.1. Summary .....	16
7.2. 6dB Bandwidth Measurement.....	17
7.2.1. Test Limit .....	17
7.2.2. Test Procedure used.....	17
7.2.3. Test Setting.....	17
7.2.4. Test Setup.....	17
7.2.5. Test Result.....	18
7.3. Output Power Measurement.....	19
7.3.1. Test Limit .....	19
7.3.2. Test Procedure Used .....	19
7.3.3. Test Setting.....	19
7.3.4. Test Setup.....	19
7.3.5. Test Result of Output Power .....	20
7.4. Power Spectral Density Measurement.....	21

---

7.4.1.	Test Limit .....	21
7.4.2.	Test Procedure Used .....	21
7.4.3.	Test Setting.....	21
7.4.4.	Test Setup.....	21
7.4.5.	Test Result.....	22
7.5.	Conducted Band Edge and Out-of-Band Emissions.....	23
7.5.1.	Test Limit .....	23
7.5.2.	Test Procedure Used .....	23
7.5.3.	Test Setting.....	23
7.5.4.	Test Setup.....	24
7.5.5.	Test Result.....	25
7.6.	Radiated Spurious Emission Measurement .....	27
7.6.1.	Test Limit .....	27
7.6.2.	Test Procedure Used .....	27
7.6.3.	Test Setting.....	27
7.6.4.	Test Setup.....	29
7.6.5.	Test Result.....	31
7.7.	Radiated Restricted Band Edge Measurement .....	38
7.7.1.	Test Result.....	38
7.8.	AC Conducted Emissions Measurement.....	46
7.8.1.	Test Limit .....	46
7.8.2.	Test Setup.....	46
7.8.3.	Test Result.....	47
<b>8.</b>	<b>CONCLUSION.....</b>	<b>49</b>

## §2.1033 General Information

<b>Applicant:</b>	SHENZHEN NST INDUSTRY AND TRADE CO., LTD
<b>Applicant Address:</b>	2/F, Building B, Hongmen Technical Park II, Jihua RD, Buji Town, Longgang District, Shenzhen, China
<b>Manufacturer:</b>	SHENZHEN NST INDUSTRY AND TRADE CO., LTD
<b>Manufacturer Address:</b>	2/F, Building B, Hongmen Technical Park II, Jihua RD, Buji Town, Longgang District, Shenzhen, China
<b>Test Site:</b>	MRT Technology (Suzhou) Co., Ltd
<b>Test Site Address:</b>	D8 Building, No.2 Tian'edang Rd., Wuzhong Economic Development Zone, Suzhou, China
<b>MRT Registration No.:</b>	809388
<b>FCC Rule Part(s):</b>	Part 15.247
<b>Model No.:</b>	HM-7843Q
<b>FCC ID:</b>	2AAMSHM-7843Q
<b>Test Device Serial No.:</b>	N/A <input type="checkbox"/> Production <input checked="" type="checkbox"/> Pre-Production <input type="checkbox"/> Engineering
<b>FCC Classification:</b>	Digital Transmission System (DTS)
<b>Date(s) of Test:</b>	Nov. 15 ~ 21, 2014
<b>Test Report S/N:</b>	1411RSU01902

### Test Facility / Accreditations

Measurements were performed at MRT Laboratory located in Tian'edang Rd., Suzhou, China.

- MRT facility is a FCC registered (MRT Reg. No. 809388) test facility with the site description report on file and has met all the requirements specified in Section 2.948 of the FCC Rules.
- MRT facility is an IC registered (MRT Reg. No. 11384A-1) test laboratory with the site description on file at Industry Canada.
- MRT facility is a VCCI registered (R-4179, G-814, C-4664, T-2206) test laboratory with the site description on file at VCCI Council.
- MRT Lab is accredited to ISO 17025 by the American Association for Laboratory Accreditation (A2LA) under the American Association for Laboratory Accreditation Program (A2LA Cert. No. 3628.01) in EMC, Telecommunications and Radio testing for FCC, Industry Canada, EU and TELEC Rules.

# 1. INTRODUCTION

## 1.1. Scope

Measurement and determination of electromagnetic emissions (EMC) of radio frequency devices including intentional and/or unintentional radiators for compliance with the technical rules and regulations of the Federal Communications Commission and the Industry Canada Certification and Engineering Bureau.

## 1.2. MRT Test Location

The map below shows the location of the MRT LABORATORY, its proximity to the Taihu Lake. These measurement tests were conducted at the MRT Technology (Suzhou) Co., Ltd. Facility located at D8 Building, No.2 Tian'edang Rd., Wuzhong Economic Development Zone, Suzhou, China. The detailed description of the measurement facility was found to be in compliance with the requirements of § 2.948 according to ANSI C63.4-2009 on September 30, 2013.



## 2. PRODUCT INFORMATION

### 2.1. Equipment Description

Product Name	7.85 Inch Tablet
Model No.	HM-7843Q
Serial Model	Trio 7.85 vQ, MX78XXX
Model Difference	MX78XXX, "XXX" in the last three digits, the first and second "X" represent A to Z, the last "X" represents 1 to 9
Brand Name	Trio
<b>Bluetooth</b>	
Bluetooth Frequency	2402~2480MHz
Bluetooth Version	V4.0
Type of modulation	FHSS
Data Rate	1Mbps(GFSK)
Antenna Type	Internal
Antenna Gain	2.3dBi
<b>Wi-Fi</b>	
Frequency Range	802.11b/g/n-HT20: 2412 ~ 2462 MHz 802.11n-HT40: 2422 ~ 2452 MHz

**Channel List for BLE**

Channel	Frequency	Channel	Frequency	Channel	Frequency
00	2402 MHz	01	2404 MHz	02	2406 MHz
03	2408 MHz	04	2410 MHz	05	2412 MHz
06	2414 MHz	07	2416 MHz	08	2418 MHz
09	2420 MHz	10	2422 MHz	11	2424 MHz
12	2426 MHz	13	2428 MHz	14	2430 MHz
15	2432 MHz	16	2434 MHz	17	2436 MHz
18	2438 MHz	19	2440 MHz	20	2442 MHz
21	2444 MHz	22	2446 MHz	23	2448 MHz
24	2450 MHz	25	2452 MHz	26	2454 MHz
27	2456 MHz	28	2458 MHz	29	2460 MHz
30	2462 MHz	31	2464 MHz	32	2466 MHz
33	2468 MHz	34	2470 MHz	35	2472 MHz
36	2474 MHz	37	2476 MHz	38	2478 MHz
39	2480 MHz	N/A	N/A	N/A	N/A



## 2.2. Device Capabilities

This device contains the following capabilities:

802.11b/g/n WLAN (DTS), Bluetooth (BLE)

**Note:** The maximum achievable duty cycles for all modes were determined based on measurements performed on a spectrum analyzer in zero-span mode with RBW = 8MHz, VBW = 50MHz, and detector = peak per the guidance of Section 6.0 b) of KDB 558074 D01v03r02. The RBW and VBW were both greater than 50/T, where T is the minimum transmission duration, and the number of sweep points across T was greater than 100. The duty cycles are as follows:

- BLE – 75.1%

## 2.3. Test Configuration

The **7.85 Inch Tablet FCC ID: 2AAMSHM-7843Q** was tested per the guidance of KDB 558074 D01v03r02. ANSI C63.10-2009 was used to reference the appropriate EUT setup for radiated spurious emissions testing and AC line conducted testing.

## 2.4. EMI Suppression Device(s)/Modifications

No EMI suppression device(s) were added and/or no modifications were made during testing.

## 2.5. Labeling Requirements

Per 2.1074 & 15.19; Docket 95-19

The label shall be permanently affixed at a conspicuous location on the device; instruction manual or pamphlet supplied to the user and be readily visible to the purchaser at the time of purchase.

However, when the device is so small wherein placement of the label with specified statement is not practical, only the trade name and FCC ID must be displayed on the device per Section 15.19(a)(5).

Please see attachment for FCC ID label and label location.

## 2.6. Test Software

The test utility software used during testing was engineering order by applicant.

## 2.7. Description of Support Units

The EUT has been tested with associated equipment below:

Description	Manufacturer	Model No.
Adapter	Supply by MRT	HSU50600F

### 3. DESCRIPTION OF TEST

#### 3.1. Evaluation Procedure

The measurement procedures described in the American National Standard for Testing Unlicensed Wireless Devices (ANSI C63.10-2009), and the guidance provided in KDB 558074 D01v03r02 were used in the measurement of the **7.85 Inch Tablet FCC ID: 2AAMSHM-7843Q**.

**Deviation from measurement procedure.....None**

#### 3.2. AC Line Conducted Emissions

The line-conducted facility is located inside an 8'x4'x4' shielded enclosure. A 1m x 2m wooden table 80cm high is placed 40cm away from the vertical wall and 80cm away from the sidewall of the shielded room. Two 10kHz-30MHz, 50Ω/50uH Line-Impedance Stabilization Networks (LISNs) are bonded to the shielded room floor. Power to the LISNs is filtered by external high-current high-insertion loss power line filters. These filters attenuate ambient signal noise from entering the measurement lines. These filters are also bonded to the shielded enclosure.

The EUT is powered from one LISN and the support equipment is powered from the second LISN. All interconnecting cables more than 1 meter were shortened to a 1 meter length by non-inductive bundling (serpentine fashion) and draped over the back edge of the test table. All cables were at least 40cm above the horizontal reference ground-plane. Power cables for support equipment were routed down to the second LISN while ensuring that that cables were not draped over the second LISN.

Sufficient time for the EUT, support equipment, and test equipment was allowed in order for them to warm up to their normal operating condition. The RF output of the LISN was connected to the receiver and exploratory measurements were made to determine the frequencies producing the maximum emission from the EUT. The receiver was scanned from 150kHz to 30MHz. The detector function was set to peak mode for exploratory measurements while the bandwidth of the analyzer was set to 9kHz. The EUT, support equipment, and interconnecting cables were arranged and manipulated to maximize each emission. Each emission was also maximized by varying: power lines, the mode of operation or data exchange speed, or support equipment whichever determined the worst-case emission. Once the worst case emissions have been identified, the one EUT cable configuration/arrangement and mode of operation that produced these emissions were used for final measurements on the same test site. The analyzer is set to CISPR quasi-peak and average detectors with a 9kHz resolution bandwidth for final measurements.

An extension cord was used to connect to a single LISN which powered by EUT. The extension cord was calibrated with LISN, the impedance and insertion loss are compliance with the requirements as stated in ANSI C63.10-2009 at Clause 4.3.

Line conducted emissions test results are shown in Section 7.8.

### 3.3. Radiated Emissions

The radiated test facilities consisted of an indoor 3 meter semi-anechoic chamber used for final measurements and exploratory measurements, when necessary. The measurement area is contained within the semi-anechoic chamber which is shielded from any ambient interference. For measurements above 1GHz absorbers are arranged on the floor between the turn table and the antenna mast in such a way so as to maximize the reduction of reflections. For measurements below 1GHz, the absorbers are removed. A MF Model 210SS turntable is used for radiated measurement. It is a continuously rotatable, remote controlled, metallic turntable and 2 meters (6.56 ft.) in diameter. The turn table is flush with the raised floor of the chamber in order to maintain its function as a ground plane. An 80cm high PVC support structure is placed on top of the turntable.

For all measurements, the spectrum was scanned through all EUT azimuths and from 1 to 4 meter receive antenna height using a broadband antenna from 30MHz up to the upper frequency shown in 15.33(b)(1) depending on the highest frequency generated or used in the device or on which the device operates or tunes. For frequencies above 1GHz, linearly polarized double ridge horn antennas were used. For frequencies below 30MHz, a calibrated loop antenna was used. When exploratory measurements were necessary, they were performed at 1 meter test distance inside the semi-anechoic chamber using broadband antennas, broadband amplifiers, and spectrum analyzers to determine the frequencies and modes producing the maximum emissions. Sufficient time for the EUT, support equipment, and test equipment was allowed in order for them to warm up to their normal operating condition. The test set-up was placed on top of the 0.8 meter high, 1 x 1.5 meter table. The EUT, support equipment, and interconnecting cables were arranged and manipulated to maximize each emission. Appropriate precaution was taken to ensure that all emissions from the EUT were maximized and investigated. The system configuration, clock speed, mode of operation or video resolution, if applicable, turntable azimuth, and receive antenna height was noted for each frequency found.

Final measurements were made in the semi-anechoic chamber using calibrated, linearly polarized broadband and horn antennas. The test setup was configured to the setup that produced the worst case emissions. The spectrum analyzer was set to investigate all frequencies required for testing to compare the highest radiated disturbances with respect to the specified limits. The turntable containing the EUT was rotated through 360 degrees and the height of the receive antenna was varied 1 to 4 meters and stopped at the azimuth and height producing the maximum emission. Each emission was maximized by changing the orientation of the EUT through three orthogonal planes and changing the polarity of the receive antenna, whichever produced the worst-case emissions. According to 3dB BeamWidth of horn antenna, the horn antenna should be always directed to the EUT when rising height.

#### 4. ANTENNA REQUIREMENTS

**Excerpt from §15.203 of the FCC Rules/Regulations:**

“An intentional radiator antenna shall be designed to ensure that no antenna other than that furnished by the responsible party can be used with the device. The use of a permanently attached antenna or of an antenna that uses a unique coupling to the intentional radiator shall be considered sufficient to comply with the provisions of this section.”

- The antenna of the 7.85 Inch Tablet is **permanently attached**.
- There are no provisions for connection to an external antenna.

**Conclusion:**

The **7.85 Inch Tablet FCC ID: 2AAMSHM-7843Q** unit complies with the requirement of §15.203.

## 5. TEST EQUIPMENT CALIBRATION DATE

### Conducted Emissions

Instrument	Manufacturer	Type No.	Serial No.	Cali. Interval	Cali. Due Date
EMI Test Receiver	R&S	ESR7	101209	1 year	2015/11/07
Two-Line V-Network	R&S	ENV216	101683	1 year	2015/11/07
Two-Line V-Network	R&S	ENV216	101684	1 year	2015/11/07
Temperature/ Meter Humidity	Anymetre	TH101B	SR2-01	1 year	2015/11/14

### Radiated Emission

Instrument	Manufacturer	Type No.	Serial No.	Cali. Interval	Cali. Due Date
Spectrum Analyzer	Agilent	N9010A	MY5144016A	1 year	2015/01/04
Preamplifier	MRT	AP01G18	1310002	1 year	2015/10/06
Loop Antenna	Schwarzbeck	FMZB1519	1519-041	1 year	2015/11/08
TRILOG Antenna	Schwarzbeck	VULB9162	9162-047	1 year	2015/11/08
Broad-Band Horn Antenna	Schwarzbeck	BBHA9120D	9120D-1167	1 year	2015/11/08
Broadband Horn Antenna	Schwarzbeck	BBHA9170	9170-549	1 year	2014/12/11
Temperature/Humidity Meter	Anymetre	TH101B	AC1-01	1 year	2015/11/14

### Conducted Test Equipment

Instrument	Manufacturer	Type No.	Serial No.	Cali. Interval	Cali. Due Date
Spectrum Analyzer	Agilent	N9010A	MY5144016A	1 year	2015/01/04
Power Sensor	Agilent	U2021XA	MY52450003	1 year	2014/12/14
Temperature/Humidity Meter	Anymetre	TH101B	TR3-01	1 year	2015/11/14

## 6. MEASUREMENT UNCERTAINTY

Where relevant, the following test uncertainty levels have been estimated for tests performed on the EUT as specified in CISPR 16-4-2. This uncertainty represents an expanded uncertainty expressed at approximately the 95% confidence level using a coverage factor of  $k = 2$ .

<b>AC Conducted Emission Measurement</b>
Measuring Uncertainty for a Level of Confidence of 95% ( $U=2Uc(y)$ ): 150kHz~30MHz: $\pm 3.46\text{dB}$
<b>Radiated Emission Measurement</b>
Measuring Uncertainty for a Level of Confidence of 95% ( $U=2Uc(y)$ ): 9kHz ~ 1GHz: $\pm 4.18\text{dB}$ 1GHz ~ 25GHz: $\pm 4.76\text{dB}$

## 7. TEST RESULT

### 7.1. Summary

Company Name: SHENZHEN NST INDUSTRY AND TRADE CO., LTD

FCC ID: 2AAMSHM-7843Q

FCC Classification: Digital Transmission System (DTS)

Data Rate(s)

1Mbps(GFSK) (BLE)

Tested:

FCC Part Section(s)	Test Description	Test Limit	Test Condition	Test Result	Reference
15.247(a)(2)	6dB Bandwidth	$\geq 500\text{kHz}$	Conducted	Pass	Section 7.2
15.247(b)(3)	Output Power	$\leq 1\text{Watt}$		Pass	Section 7.3
15.247(e)	Power Spectral Density	$\leq 8\text{dBm} / 3\text{kHz Band}$		Pass	Section 7.4
15.247(d)	Band Edge / Out-of-Band Emissions	$\geq 20\text{dBc(Peak)}$		Pass	Section 7.5
15.205 15.209	General Field Strength Limits (Restricted Bands and Radiated Emission Limits)	Emissions in restricted bands must meet the radiated limits detailed in 15.209	Radiated	Pass	Section 7.6 & 7.7
15.207	AC Conducted Emissions 150kHz - 30MHz	< FCC 15.207 limits	Line Conducted	Pass	Section 7.8

#### Notes:

- 1) All modes of operation and data rates were investigated. For radiated emission test, every axis (X, Y, Z) was also verified. The test results shown in the following sections represent the worst case emissions.
- 2) The analyzer plots shown in this section were all taken with a correction table loaded into the analyzer. The correction table was used to account for the losses of the cables and attenuators used as part of the system to connect the EUT to the analyzer at all frequencies of interest.
- 3) All antenna port conducted emissions testing was performed on a test bench with the antenna port of the EUT connected to the spectrum analyzer through calibrated cables and attenuators.



## 7.2. 6dB Bandwidth Measurement

### 7.2.1. Test Limit

The minimum 6dB bandwidth shall be at least 500 kHz.

### 7.2.2. Test Procedure used

KDB 558074 D01v03r02 - Section 8.2 Option 2

### 7.2.3. Test Setting

1. The Spectrum's automatic bandwidth measurement capability was used to perform the 6dB bandwidth measurement. The "X" dB bandwidth parameter was set to  $X = 6$ . The bandwidth measurement was not influenced by any intermediate power nulls in the fundamental emission.
2. Set RBW = 100 kHz
3. VBW  $\geq 3 \times$  RBW
4. Detector = Peak
5. Trace mode = max hold
6. Sweep = auto couple
7. Allow the trace was allowed to stabilize

### 7.2.4. Test Setup

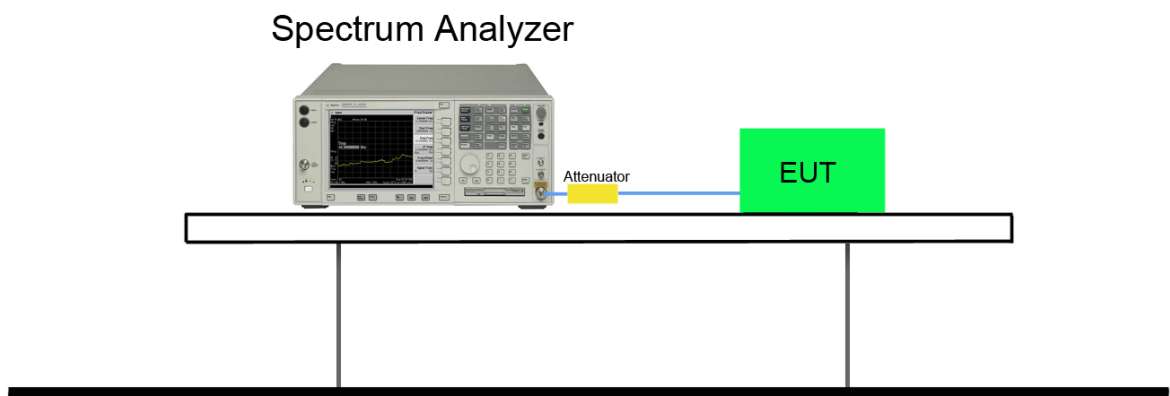

### 7.2.5. Test Result

Test Mode	Data Rate (Mbps)	Channel No.	Frequency (MHz)	6dB Bandwidth (MHz)	Limit (MHz)	Result
BLE	1	00	2402	0.697	≥ 0.5	Pass
BLE	1	19	2440	0.696	≥ 0.5	Pass
BLE	1	39	2480	0.706	≥ 0.5	Pass

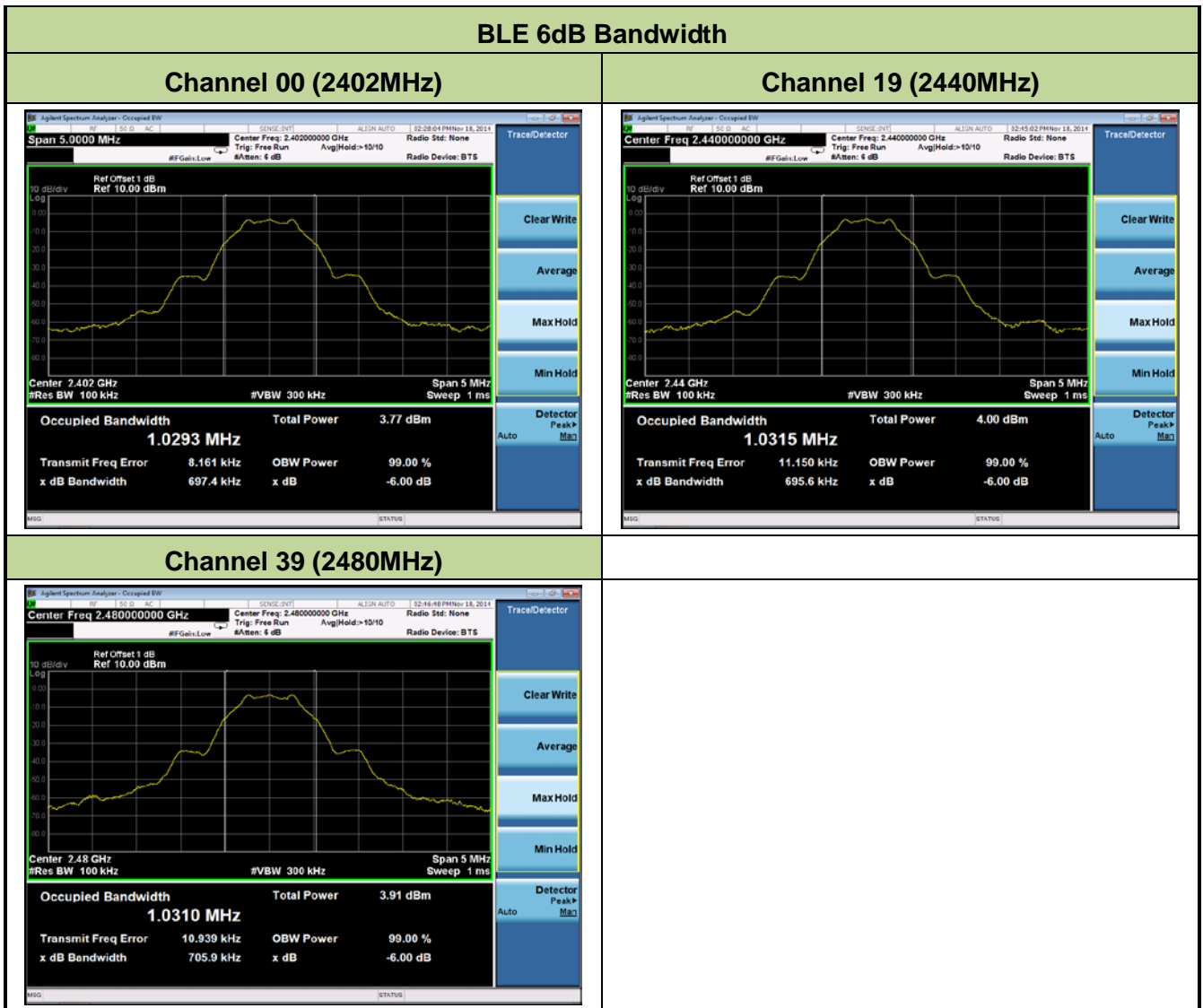

## 7.3. Output Power Measurement

### 7.3.1. Test Limit

The maximum out power shall be less 1 Watt (30dBm).

### 7.3.2. Test Procedure Used

KDB 558074 D01v03r02 - Section 9.1.2 PKPM1 Peak Power Method (for signals with BW  $\leq$  50MHz)

### 7.3.3. Test Setting

#### **Method PKPM1 (Peak Power Measurement of Signals with DTS BW $\leq$ 50MHz)**

Peak power measurements were performed only when the EUT was transmitting at its maximum power control level using a broadband power meter with a pulse sensor. The pulse sensor employs a VBW = 50MHz so this method was only used for signals whose DTS bandwidth was less than or equal to 50MHz.

### 7.3.4. Test Setup

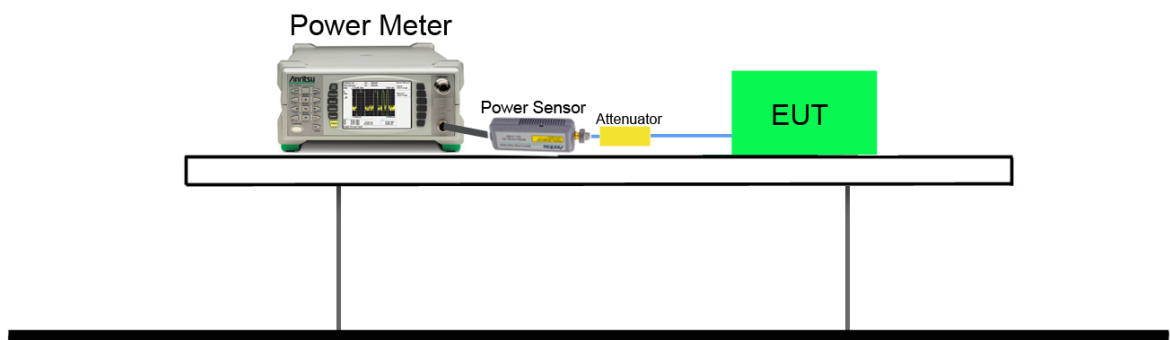

### 7.3.5. Test Result of Output Power

#### Test Result of Peak Output Power

Test Mode	Data Rate (Mbps)	Channel No.	Frequency (MHz)	Peak Power (dBm)	Limit (dBm)	Result
BLE	1	00	2402	-2.56	≤ 30	Pass
BLE	1	19	2440	-2.48	≤ 30	Pass
BLE	1	39	2480	-2.86	≤ 30	Pass

## 7.4. Power Spectral Density Measurement

### 7.4.1. Test Limit

The maximum permissible power spectral density is 8dBm in any 3 kHz band.

### 7.4.2. Test Procedure Used

KDB 558074 D01v03r02 - Section 10.2 Method PKPSD

### 7.4.3. Test Setting

1. Analyzer was set to the center frequency of the DTS channel under investigation
2. Span = 1.5 times the DTS channel bandwidth
3. RBW = 3kHz
4. VBW = 10kHz
5. Detector = peak
6. Sweep time = auto couple
7. Trace mode = max hold
8. Trace was allowed to stabilize

### 7.4.4. Test Setup

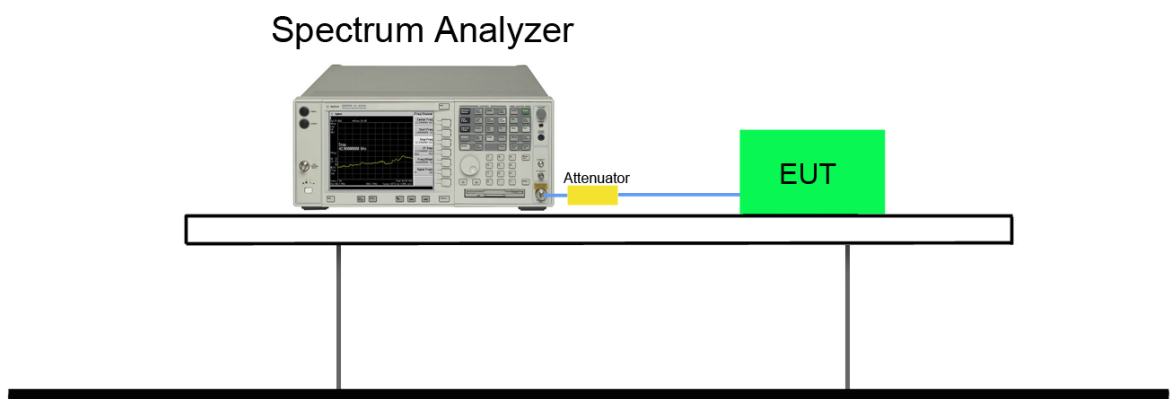

### 7.4.5. Test Result

Test Mode	Data Rate (Mbps)	Channel No.	Frequency (MHz)	PSD Result (dBm / 3kHz)	Limit (dBm / 3kHz)	Result
BLE	1	00	2402	-17.549	≤ 8	Pass
BLE	1	19	2440	-17.462	≤ 8	Pass
BLE	1	39	2480	-17.651	≤ 8	Pass

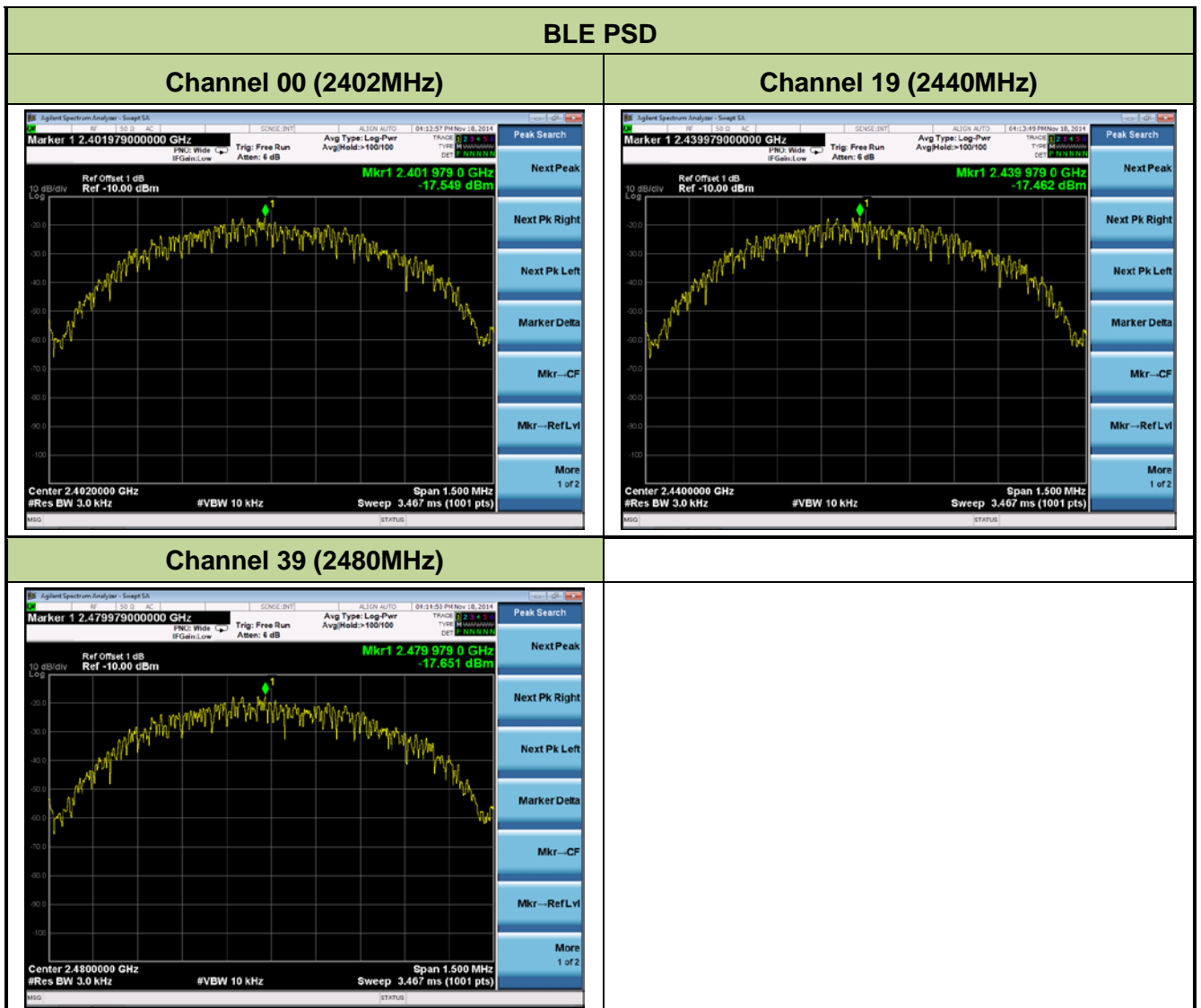

## **7.5. Conducted Band Edge and Out-of-Band Emissions**

### **7.5.1. Test Limit**

The limit for out-of-band spurious emissions at the band edge is 20dB below the fundamental emission level, as determined from the in-band power measurement of the DTS channel performed in a 100kHz bandwidth per the PSD procedure (Section 9.1).

### **7.5.2. Test Procedure Used**

KDB 558074 D01v03r02 - Section 11.2 & Section 11.3

### **7.5.3. Test Setting**

#### **1. Reference level measurement**

- (a) Set instrument center frequency to DTS channel center frequency
- (b) Set the span to  $\geq 1.5$  times the DTS bandwidth
- (c) Set the RBW = 100 kHz
- (d) Set the VBW  $\geq 3 \times$  RBW
- (e) Detector = peak
- (f) Sweep time = auto couple
- (g) Trace mode = max hold
- (h) Allow trace to fully stabilize

#### **2. Emission level measurement**

- (a) Set the center frequency and span to encompass frequency range to be measured
- (b) RBW = 100kHz
- (c) VBW = 300kHz
- (d) Detector = Peak
- (e) Number of sweep points  $\geq 2 \times$  Span/RBW
- (f) Trace mode = max hold
- (g) Sweep time = auto couple

(h) The trace was allowed to stabilize

#### 7.5.4. Test Setup

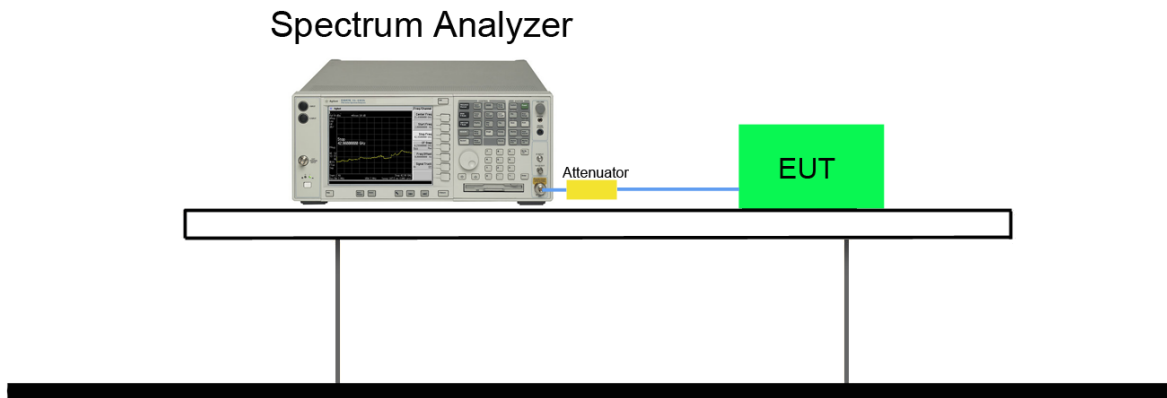



7.5.5. Test Result

Test Mode	Data Rate (Mbps)	Channel No.	Frequency (MHz)	Limit	Result
BLE	1	00	2402	20dBc	Pass
BLE	1	19	2440	20dBc	Pass
BLE	1	39	2480	20dBc	Pass

### BLE Out-of-Band Emissions

#### Channel 00 (2402MHz)

#### 100kHz PSD reference Level

Agilent Spectrum Analyzer - Sweep SA  
 Marker 1 2.401995500000 GHz  
 Ref Offset 1 dB  
 Ref 10.00 dBm  
 Mkr1 2.401 995 5 GHz  
 -2.880 dBm  
 Center 2.4020000 GHz  
 #Res BW 100 kHz  
 #VBW 300 kHz  
 Span 1.500 MHz  
 Sweep 1.000 ms (1001 pts)

#### Low Band Edge

Agilent Spectrum Analyzer - Sweep SA  
 Marker 1 2.400000000000 GHz  
 Ref Offset 1 dB  
 Ref 10.00 dBm  
 Mkr1 2.400 00 GHz  
 -60.607 dBm  
 Center 2.4000000 GHz  
 #Res BW 100 kHz  
 #VBW 300 kHz  
 Span 10.00 MHz  
 Sweep 1.000 ms (1001 pts)

#### Spurious Emission 30MHz ~ 25GHz

Agilent Spectrum Analyzer - Sweep SA  
 Marker 3 16.3354100000000 GHz  
 Ref Offset 1 dB  
 Ref 10.00 dBm  
 Mkr3 16.335 GHz  
 -62.760 dBm  
 Start 30 MHz  
 Stop 25.00 GHz  
 #Res BW 100 kHz  
 #VBW 300 kHz  
 Sweep 81.70 ms (1001 pts)

MARK	MODE	TRIG	SCL	X	Y	FUNCTION	FUNCTION(WIDTH)	FUNCTION VALUE
1	N	1	f	7.198 GHz	-65.316 dBm			
2	N	1	f	9.119 GHz	-63.855 dBm			
3	N	1	f	16.335 GHz	-62.760 dBm			

### Channel 19 (2440MHz)

#### 100kHz PSD reference Level

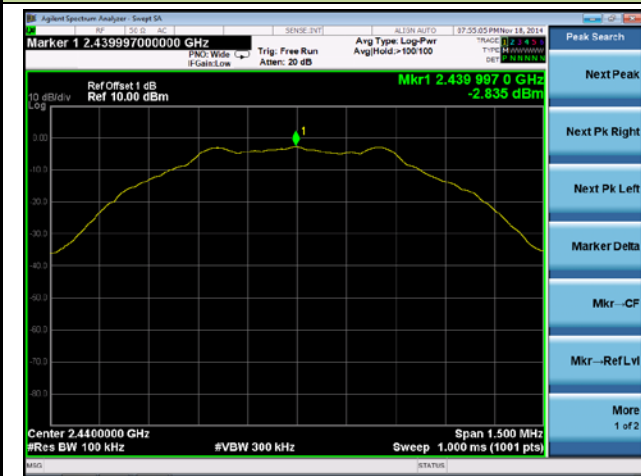

#### Spurious Emission 30MHz ~ 25GHz

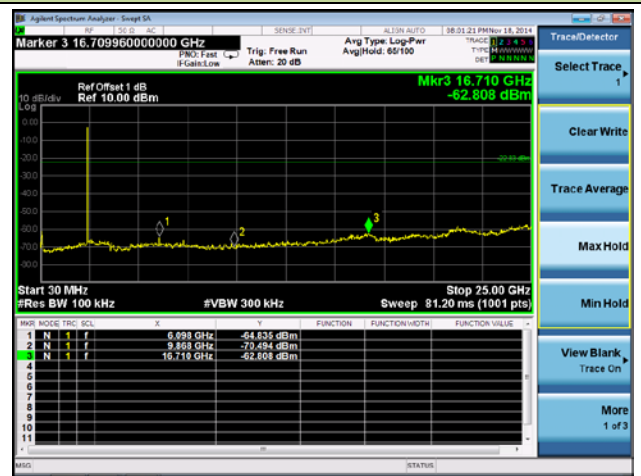

### Channel 39 (2480MHz)

#### 100kHz PSD reference Level

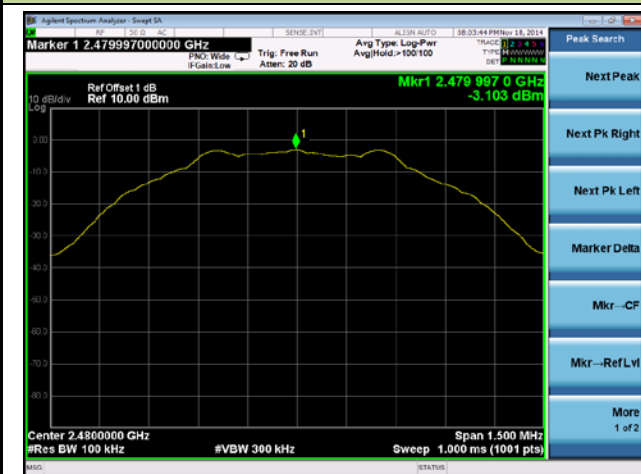

#### High Band Edge

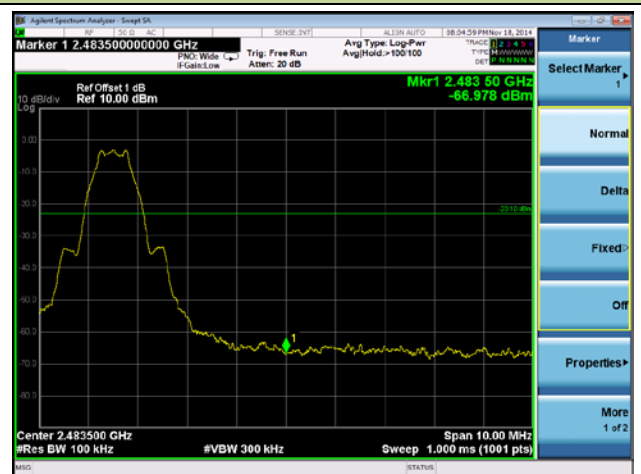

#### Spurious Emission 30MHz ~ 25GHz

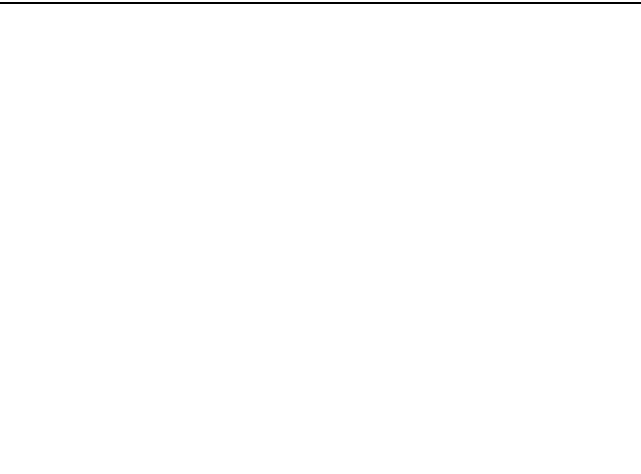
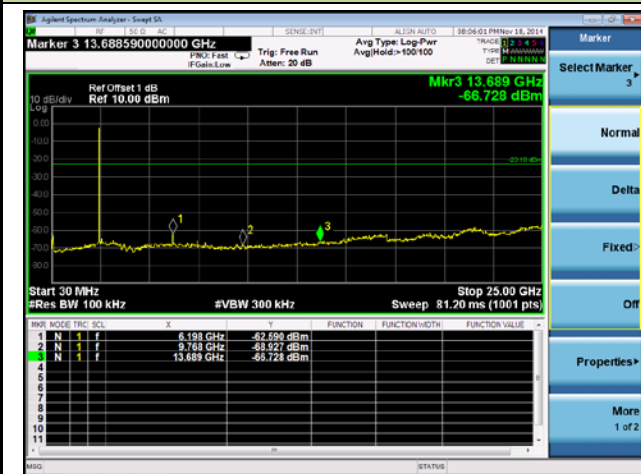

## 7.6. Radiated Spurious Emission Measurement

### 7.6.1. Test Limit

All out of band emissions appearing in a restricted band as specified in Section 15.205 of the Title 47 CFR must not exceed the limits shown in Table per Section 15.209.

FCC Part 15 Subpart C Paragraph 15.209		
Frequency [MHz]	Field Strength [V/m]	Measured Distance [Meters]
0.009 – 0.490	2400/F (kHz)	300
0.490 – 1.705	24000/F (kHz)	30
1.705 - 30	30	30
30 - 88	100	3
88 - 216	150	3
216 - 960	200	3
Above 960	500	3

### 7.6.2. Test Procedure Used

KDB 558074 D01v03r02 – Section 12.2.3 (quasi-peak measurements)

KDB 558074 D01v03r02 – Section 12.2.4 (peak power measurements)

KDB 558074 D01v03r02 – Section 12.2.5 (average power measurements)

### 7.6.3. Test Setting

#### Peak Field Strength Measurements per Section 12.2.4 of KDB 558074 D01v03r02

1. Analyzer center frequency was set to the frequency of the radiated spurious emission of interest
2. RBW = as specified in Table 1
3. VBW = 3MHz
4. Detector = peak
5. Sweep time = auto couple

6. Trace mode = max hold

7. Trace was allowed to stabilize

**Table 1—RBW as a function of frequency**

Frequency	RBW
9 ~ 150 kHz	200 ~ 300 Hz
0.15 ~ 30 MHz	9 ~ 10 kHz
30 ~ 1000 MHz	100 ~ 120 kHz
> 1000 MHz	1 MHz

**Average Field Strength Measurements per Section 12.2.5.1 of KDB 558074 D01v03r02**

1. RBW = 1MHz.
2. VBW  $\geq 3 \times$  RBW.
3. Detector = RMS, if span/(# of points in sweep)  $\leq$  (RBW/2). Satisfying this condition may require increasing the number of points in the sweep or reducing the span. If this condition cannot be satisfied, then the detector mode shall be set to peak.
4. Averaging type = power (*i.e.*, RMS).
  - As an alternative, the detector and averaging type may be set for linear voltage averaging.
  - Some instruments require linear display mode in order to use linear voltage averaging. Log or dB averaging shall not be used.
5. Sweep time = auto.
6. Perform a trace average of at least 100 traces.

### 7.6.4. Test Setup

#### 9kHz ~ 30MHz Test Setup:

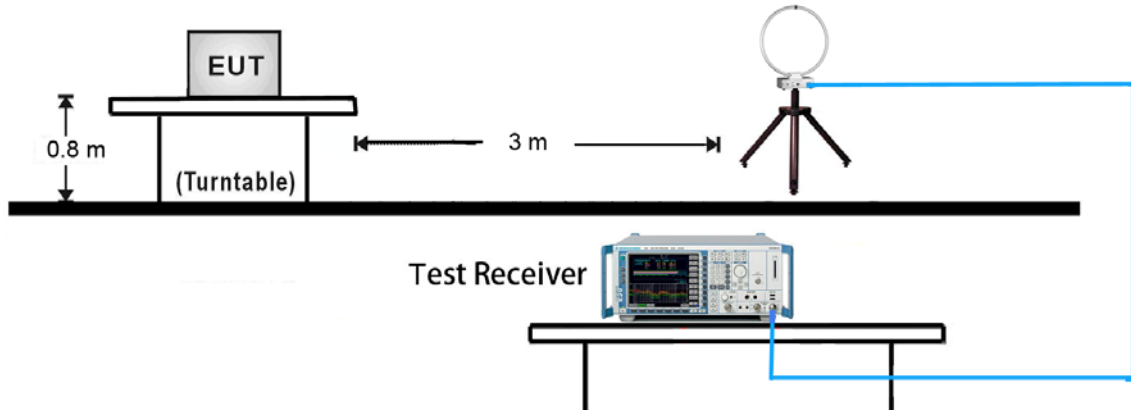

#### 30MHz ~ 1GHz Test Setup:

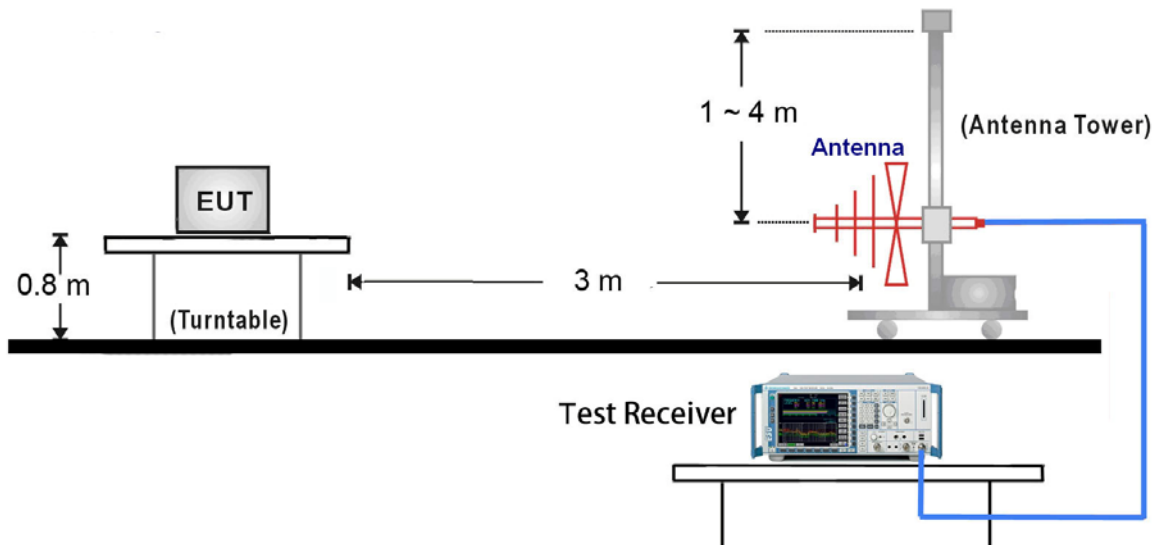

1GHz ~ 25GHz Test Setup:

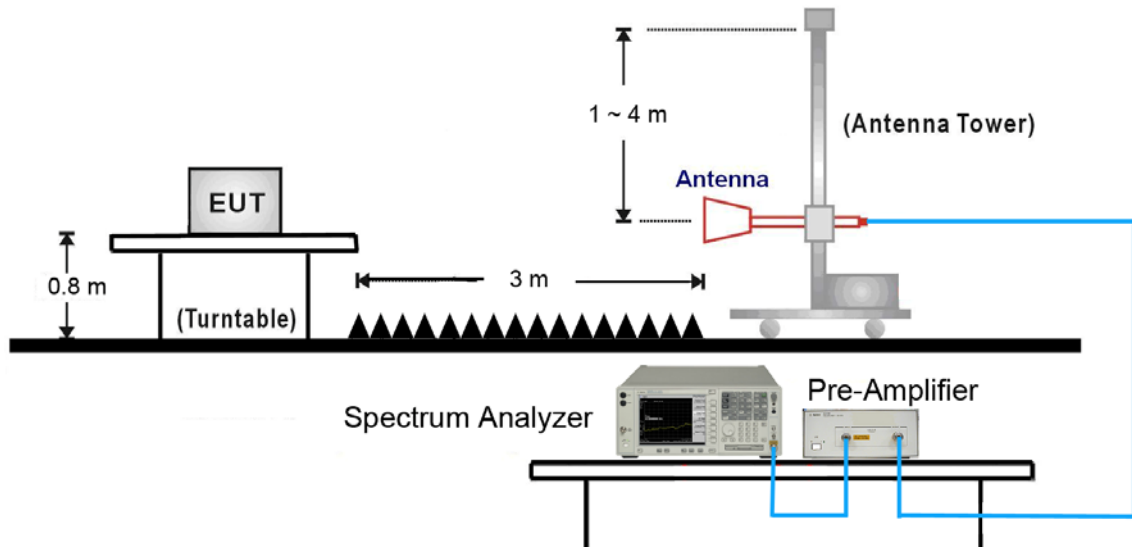

### 7.6.5. Test Result

Test Mode:	BLE	Test Site:	AC1
Test Channel:	39	Test Engineer:	Milo Li
Remark:	1. Average measurement was not performed if peak level lower than average limit. 2. <b>The worst case of Radiated Spurious Emission.</b> 3. Other frequency was 20dB below limit line within 1-18GHz, there is not show in the report.		

Mark	Frequency (MHz)	Reading Level (dB $\mu$ V)	Factor (dB)	Measure Level (dB $\mu$ V/m)	Limit (dB $\mu$ V/m)	Margin (dB)	Detector	Polarization
*	3145.0	37.1	3.6	40.7	74.0	-33.3	Peak	Horizontal
*	4426.0	36.2	5.5	41.7	74.0	-32.3	Peak	Horizontal
	4960.0	36.4	6.8	43.2	74.0	-30.8	Peak	Horizontal
	7440.0	34.0	14.2	48.2	74.0	-25.8	Peak	Horizontal
*	3146.0	37.1	3.6	40.7	74.0	-33.3	Peak	Vertical
*	4478.0	35.8	5.6	41.4	74.0	-32.6	Peak	Vertical
	4960.0	35.9	6.8	42.7	74.0	-31.3	Peak	Vertical
	7440.0	33.3	14.2	47.5	74.0	-26.5	Peak	Vertical

Note 1: "\*" is not in restricted band, its limit is 20dBc of the fundamental emission level (80.9dB $\mu$ V/m) or 15.209 which is higher.

Note 2: Measure Level (dB $\mu$ V/m) = Reading Level (dB $\mu$ V) + Factor (dB)

Factor (dB) = Cable Loss (dB) + Antenna Factor (dB/m) - Pre\_Amplifier Gain (dB)

**The worst case of Radiated Emission below 1GHz:**

Site: AC1	Time: 2014/11/21 - 14:29
Limit: FCC_Part15.209_RE(3m)	Engineer: Knight Lu
Probe: VULB9162_0.03-8GHz	Polarity: Horizontal
EUT: 7.85 Inch Tablet	Power: By Battery
<b>Worse Case Mode: BLE at Channel 2480MHz</b>	

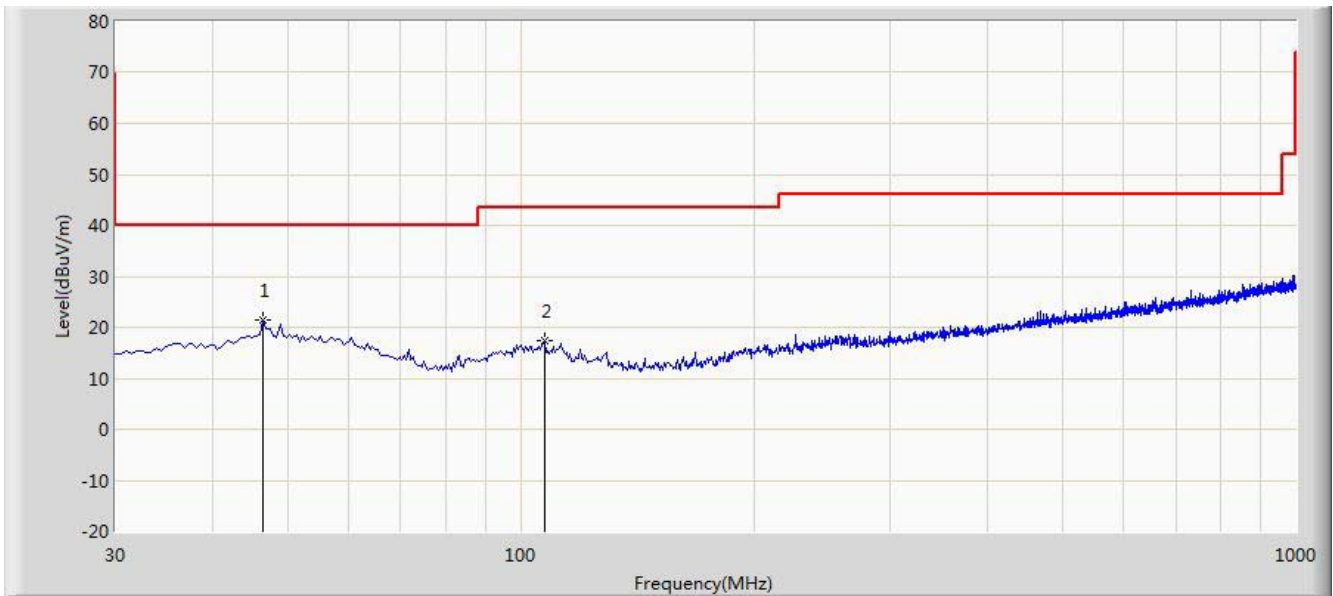

No	Frequency (MHz)	Measure Level (dBuV/m)	Reading Level (dBuV)	Over Limit (dB)	Limit (dBuV/m)	Factor (dB)	Type
1	46.490	21.315	6.499	-18.685	40.000	14.816	QP
2	107.600	17.269	4.504	-26.231	43.500	12.765	QP

Note: Measure Level (dBuV/m) = Reading Level (dBuV) + Factor (dB)

Factor (dB) = Cable Loss (dB) + Antenna Factor (dB/m)



Site: AC1	Time: 2014/11/21 - 14:30
Limit: FCC_Part15.209_RE(3m)	Engineer: Knight Lu
Probe: VULB9162_0.03-8GHz	Polarity: Vertical
EUT: 7.85 Inch Tablet	Power: By Battery
<b>Worse Case Mode: BLE at Channel 2480MHz</b>	

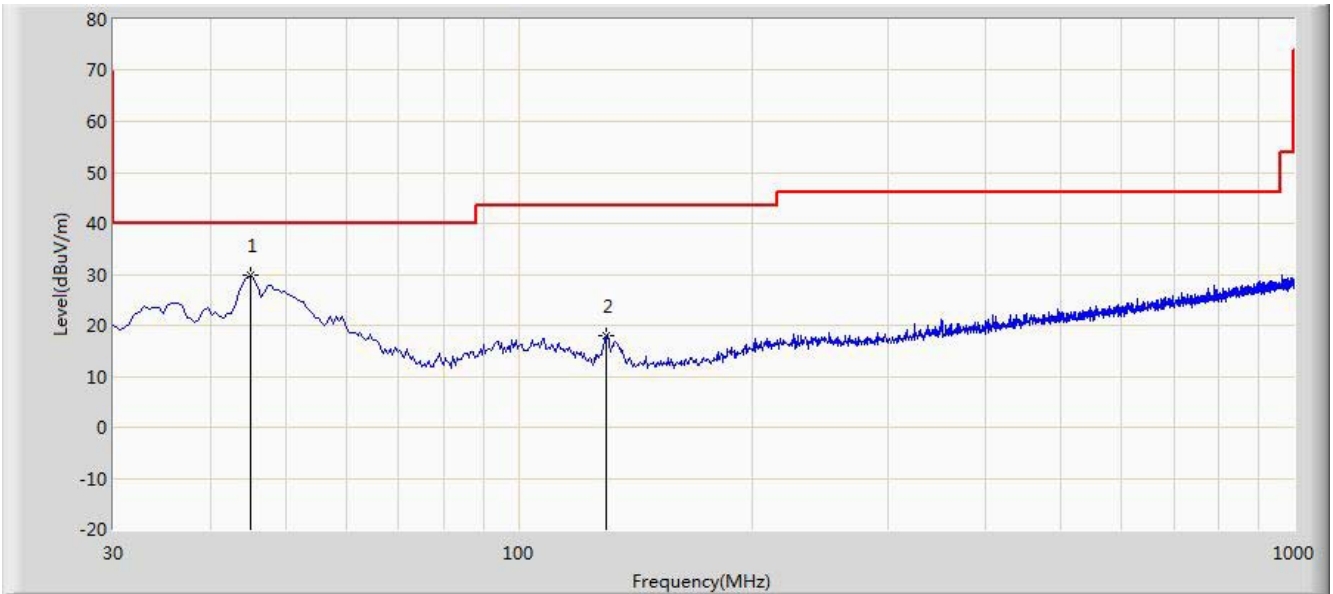

No	Frequency (MHz)	Measure Level (dBuV/m)	Reading Level (dBuV)	Over Limit (dB)	Limit (dBuV/m)	Factor (dB)	Type
1	45.035	29.823	15.169	-10.177	40.000	14.655	QP
2	129.425	18.066	8.223	-25.434	43.500	9.843	QP

Note: Measure Level (dBμV/m) = Reading Level (dBμV) + Factor (dB)

Factor (dB) = Cable Loss (dB) + Antenna Factor (dB/m)

Site: AC1	Time: 2014/11/20 - 15:32
Limit: FCC_Part15.209_RE(3m)	Engineer: Knight Lu
Probe: FMZB1519_0.009-30MHz	Polarity: Face On
EUT: 7.85 Inch Tablet	Power: By Battery

**Note: There is the ambient noise within frequency range 9kHz~30MHz.**

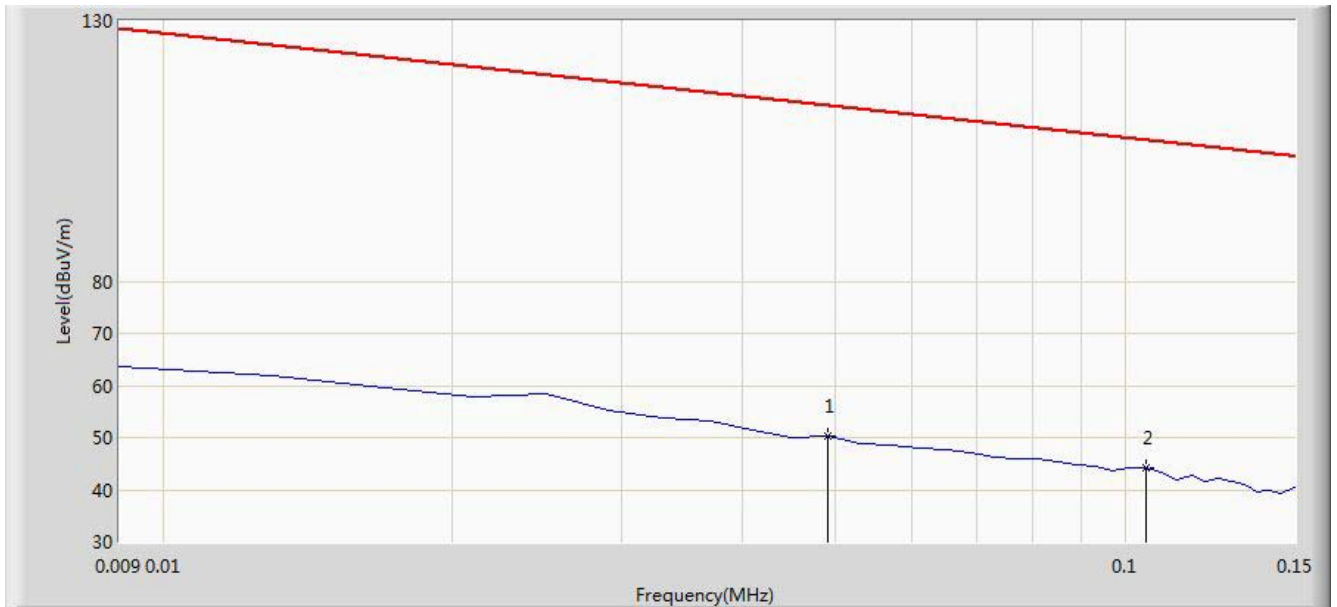

No	Frequency (MHz)	Measure Level (dBuV/m)	Reading Level (dBuV)	Over Limit (dB)	Limit (dBuV/m)	Factor (dB)	Type
1	0.049	50.367	29.861	-63.422	113.789	20.505	QP
2	0.105	44.143	23.996	-63.029	107.173	20.147	QP

Note: Measure Level (dBμV/m) = Reading Level (dBμV) + Factor (dB)

Factor (dB) = Cable Loss (dB) + Antenna Factor (dB/m)

Site: AC1	Time: 2014/11/20 - 15:41
Limit: FCC_Part15.209_RE(3m)	Engineer: Knight Lu
Probe: FMZB1519_0.009-30MHz	Polarity: Face On
EUT: 7.85 Inch Tablet	Power: By Battery
<b>Note: There is the ambient noise within frequency range 9kHz~30MHz.</b>	

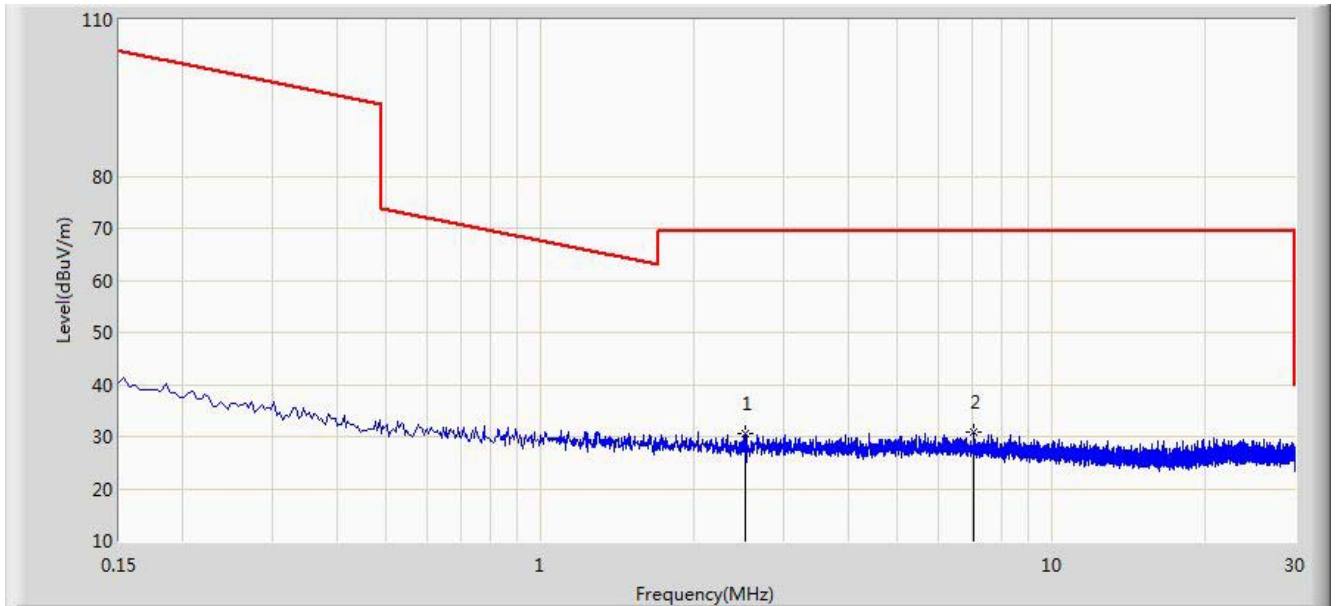

No	Frequency (MHz)	Measure Level (dBuV/m)	Reading Level (dBuV)	Over Limit (dB)	Limit (dBuV/m)	Factor (dB)	Type
1	2.513	30.495	10.336	-39.005	69.500	20.159	QP
2	7.041	30.974	10.579	-38.526	69.500	20.395	QP

Note: Measure Level (dBμV/m) = Reading Level (dBμV) + Factor (dB)

Factor (dB) = Cable Loss (dB) + Antenna Factor (dB/m)

Site: AC1	Time: 2014/11/20 - 15:45
Limit: FCC_Part15.209_RE(3m)	Engineer: Knight Lu
Probe: BBHA9170_18-40GHz	Polarity: Horizontal
EUT: 7.85 Inch Tablet	Power: By Battery
<b>Note: There is the ambient noise within frequency range 18 ~ 25GHz.</b>	

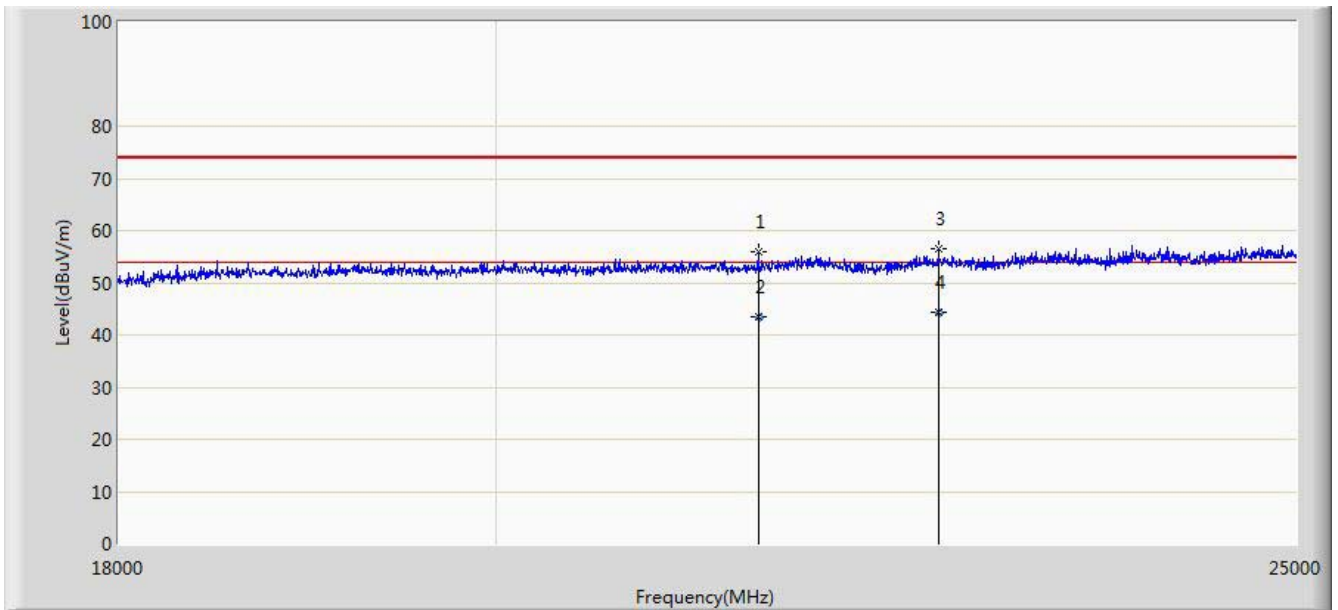

No	Frequency (MHz)	Measure Level (dBuV/m)	Reading Level (dBuV)	Over Limit (dB)	Limit (dBuV/m)	Factor (dB)	Type
1	21517.500	55.869	17.883	-18.131	74.000	37.986	PK
2	21517.650	43.351	5.365	-10.649	54.000	37.986	AV
3	22630.500	56.509	18.223	-17.491	74.000	38.286	PK
4	22630.540	44.310	6.024	-9.690	54.000	38.286	AV

Note: Measure Level (dBuV/m) = Reading Level (dBuV) + Factor (dB)

Factor (dB) = Cable Loss (dB) + Antenna Factor (dB/m)

Site: AC1	Time: 2014/11/20 - 15:59
Limit: FCC_Part15.209_RE(3m)	Engineer: Knight Lu
Probe: BBHA9170_18-40GHz	Polarity: Vertical
EUT: 7.85 Inch Tablet	Power: By Battery
<b>Note: There is the ambient noise within frequency range 18 ~ 25GHz.</b>	

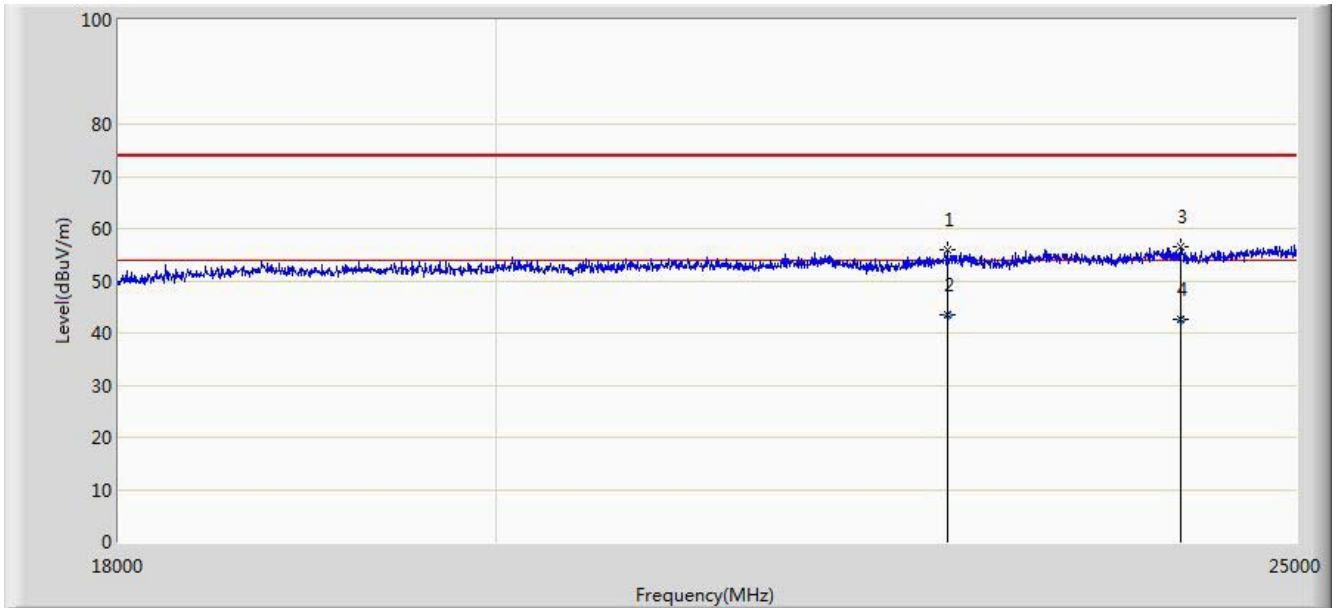

No	Frequency (MHz)	Measure Level (dBuV/m)	Reading Level (dBuV)	Over Limit (dB)	Limit (dBuV/m)	Factor (dB)	Type
1	22686.500	55.811	17.457	-18.189	74.000	38.354	PK
2	22686.540	43.598	5.244	-10.402	54.000	38.354	AV
3	24205.500	56.430	17.607	-17.570	74.000	38.823	PK
4	24205.658	42.518	3.695	-11.482	54.000	38.823	AV

Note: Measure Level (dBuV/m) = Reading Level (dBuV) + Factor (dB)

Factor (dB) = Cable Loss (dB) + Antenna Factor (dB/m)

## 7.7. Radiated Restricted Band Edge Measurement

### 7.7.1. Test Result

Site: AC1	Time: 2014/11/21 - 15:36
Limit: FCC_Part15.209_RE(3m)	Engineer: Knight Lu
Probe: BBHA9120D_1-18GHz	Polarity: Horizontal
EUT: 7.85 Inch Tablet	Power: By Battery
<b>Worse Case Mode : BLE at Channel 2402MHz</b>	

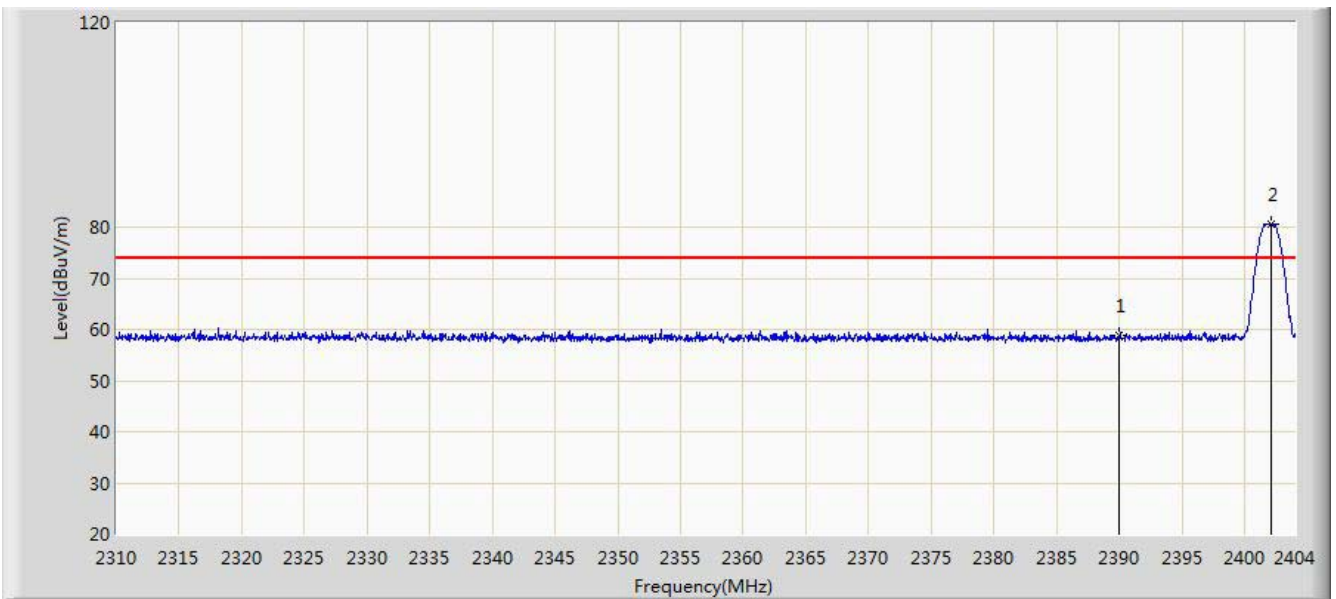

No	Frequency (MHz)	Measure Level (dBuV/m)	Reading Level (dBuV)	Over Limit (dB)	Limit (dBuV/m)	Factor (dB)	Type
1	2390.000	58.709	28.025	-15.291	74.000	30.684	PK
2	2402.073	80.595	49.934	N/A	N/A	30.661	PK

Note: Measure Level (dBμV/m) = Reading Level (dBμV) + Factor (dB)

Factor (dB) = Cable Loss (dB) + Antenna Factor (dB/m)

Site: AC1	Time: 2014/11/21 - 15:41
Limit: FCC_Part15.209_RE(3m)	Engineer: Knight Lu
Probe: BBHA9120D_1-18GHz	Polarity: Horizontal
EUT: 7.85 Inch Tablet	Power: By Battery
<b>Worse Case Mode : BLE at Channel 2402MHz</b>	

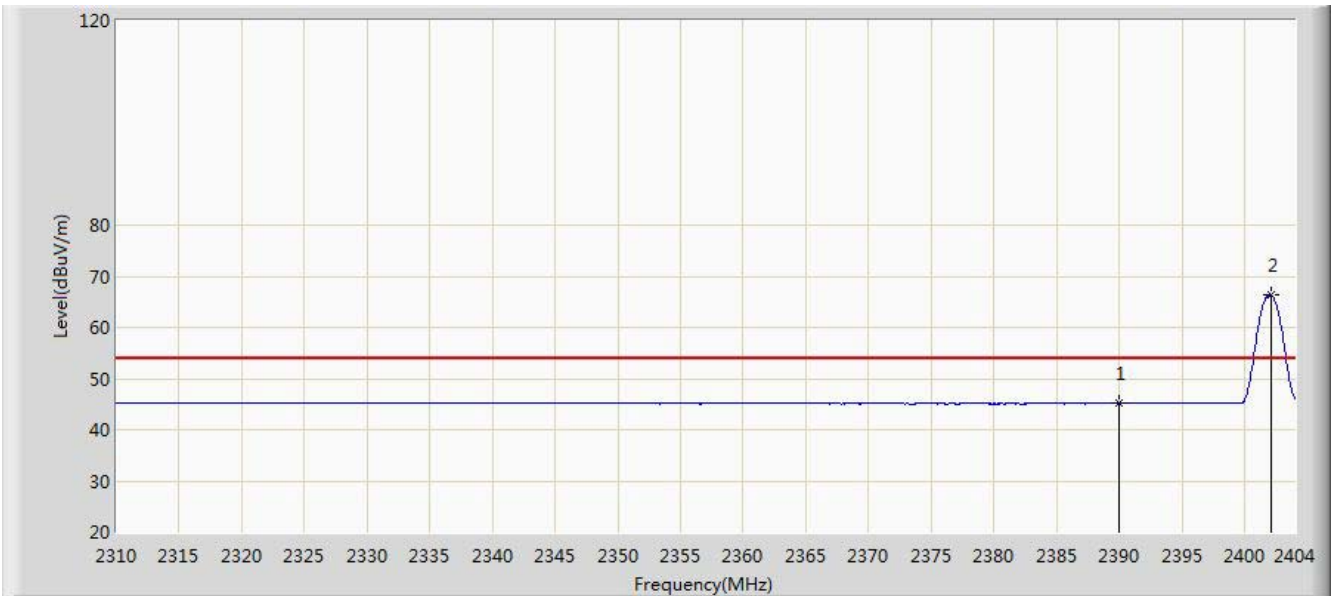

No	Frequency (MHz)	Measure Level (dBuV/m)	Reading Level (dBuV)	Over Limit (dB)	Limit (dBuV/m)	Factor (dB)	Type
1	2390.000	45.104	14.420	-8.896	54.000	30.684	AV
2	2402.073	66.324	35.663	N/A	N/A	30.661	AV

Note: Measure Level (dBμV/m) = Reading Level (dBμV) + Factor (dB)

Factor (dB) = Cable Loss (dB) + Antenna Factor (dB/m)

Site: AC1	Time: 2014/11/21 - 15:42
Limit: FCC_Part15.209_RE(3m)	Engineer: Knight Lu
Probe: BBHA9120D_1-18GHz	Polarity: Vertical
EUT: 7.85 Inch Tablet	Power: By Battery
<b>Worse Case Mode : BLE at Channel 2402MHz</b>	

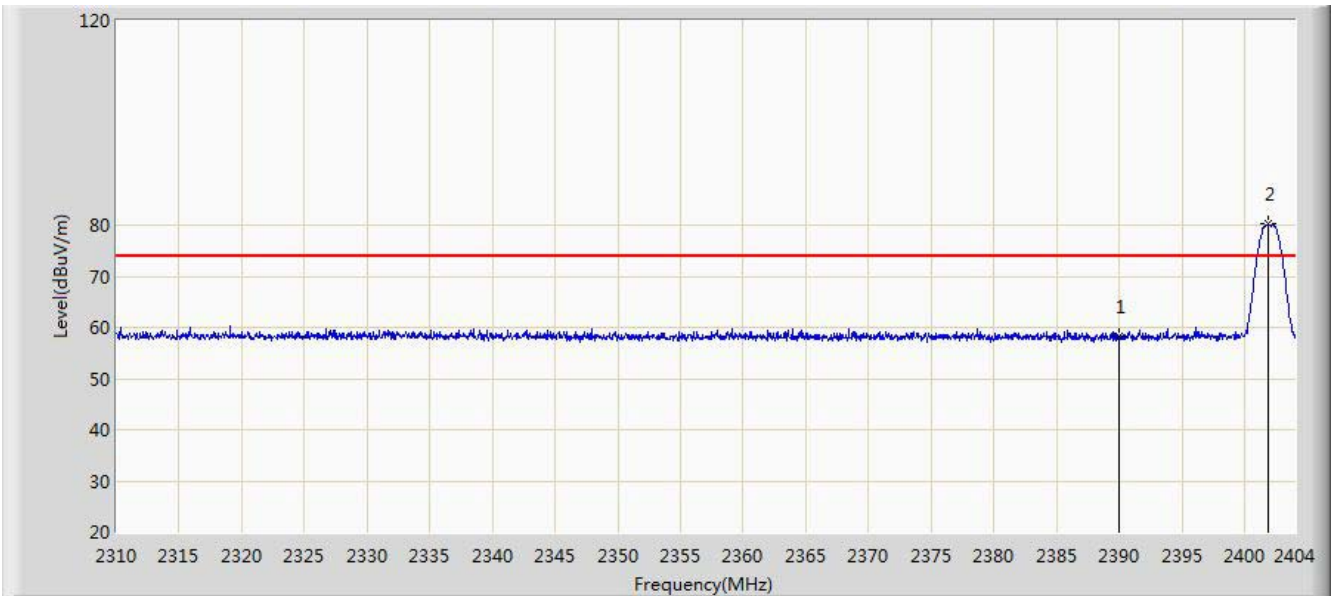

No	Frequency (MHz)	Measure Level (dBuV/m)	Reading Level (dBuV)	Over Limit (dB)	Limit (dBuV/m)	Factor (dB)	Type
1	2390.000	58.137	27.453	-15.863	74.000	30.684	PK
2	2401.885	80.167	49.506	N/A	N/A	30.661	PK

Note: Measure Level (dBμV/m) = Reading Level (dBμV) + Factor (dB)

Factor (dB) = Cable Loss (dB) + Antenna Factor (dB/m)



Site: AC1	Time: 2014/11/21 - 15:44
Limit: FCC_Part15.209_RE(3m)	Engineer: Knight Lu
Probe: BBHA9120D_1-18GHz	Polarity: Vertical
EUT: 7.85 Inch Tablet	Power: By Battery
<b>Worse Case Mode : BLE at Channel 2402MHz</b>	

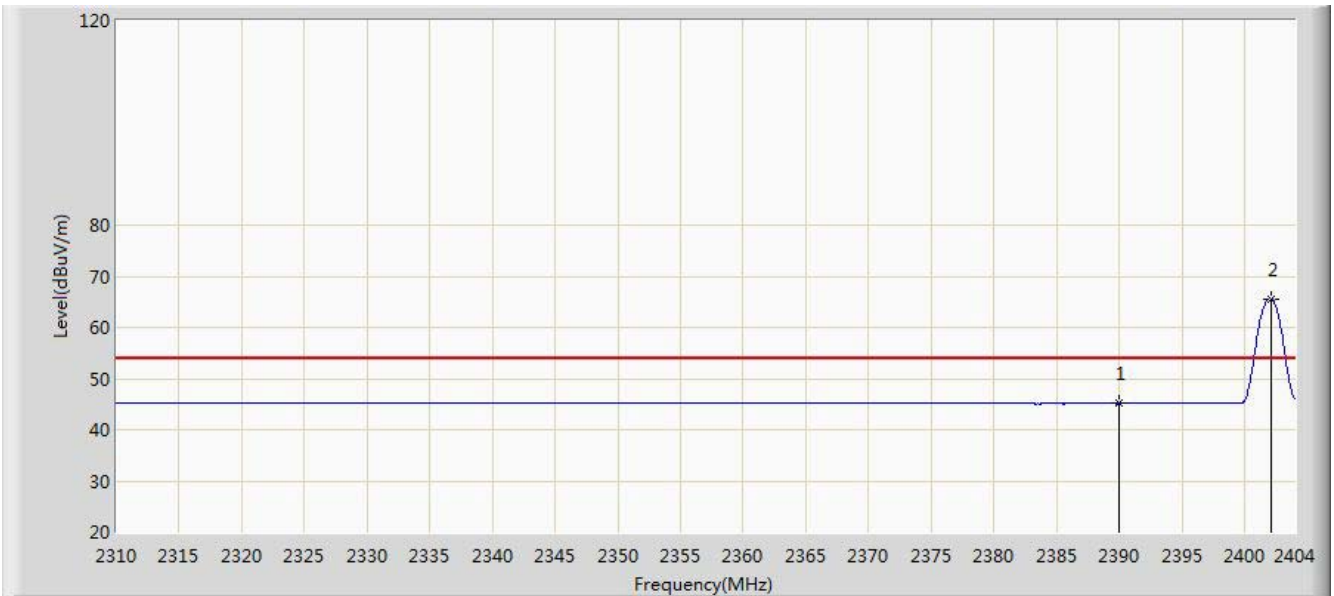

No	Frequency (MHz)	Measure Level (dBuV/m)	Reading Level (dBuV)	Over Limit (dB)	Limit (dBuV/m)	Factor (dB)	Type
1	2390.000	45.139	14.455	-8.861	54.000	30.684	AV
2	2402.073	65.645	34.984	N/A	N/A	30.661	AV

Note: Measure Level (dBμV/m) = Reading Level (dBμV) + Factor (dB)

Factor (dB) = Cable Loss (dB) + Antenna Factor (dB/m)

Site: AC1	Time: 2014/11/21 - 15:45
Limit: FCC_Part15.209_RE(3m)	Engineer: Knight Lu
Probe: BBHA9120D_1-18GHz	Polarity: Horizontal
EUT: 7.85 Inch Tablet	Power: By Battery
<b>Worse Case Mode : BLE at Channel 2480MHz</b>	

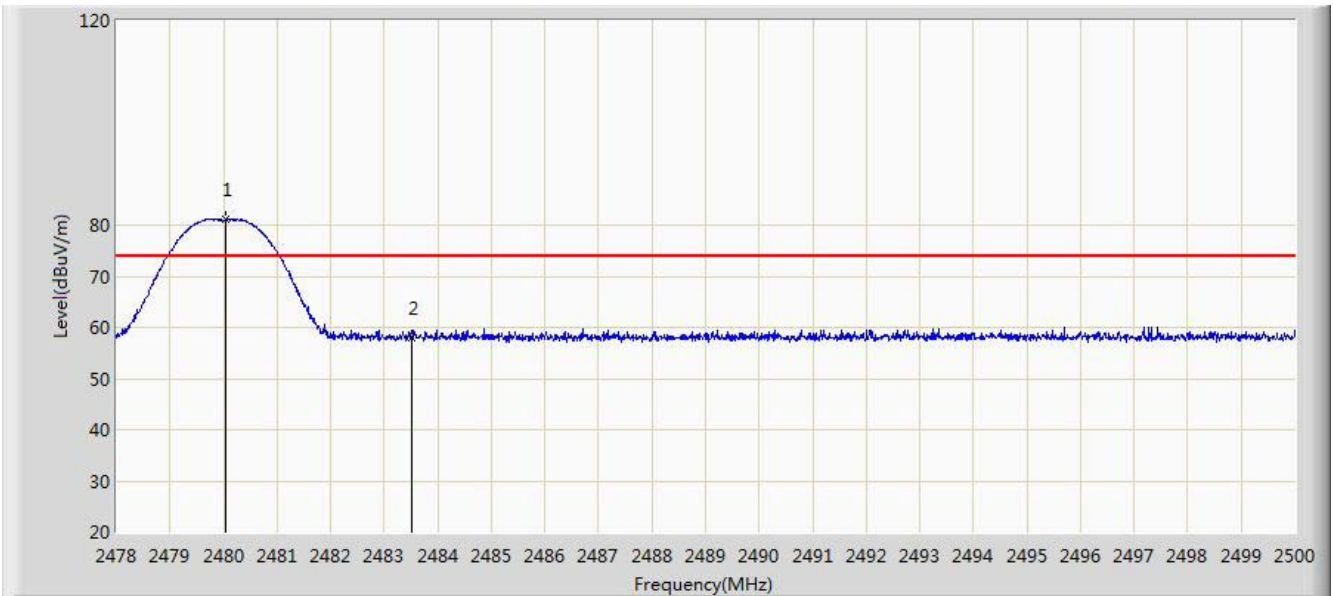

No	Frequency (MHz)	Measure Level (dBuV/m)	Reading Level (dBuV)	Over Limit (dB)	Limit (dBuV/m)	Factor (dB)	Type
1	2480.046	81.035	50.372	N/A	N/A	30.662	PK
2	2483.500	58.102	27.429	-15.898	74.000	30.673	PK

Note: Measure Level (dB $\mu$ V/m) = Reading Level (dB $\mu$ V) + Factor (dB)

Factor (dB) = Cable Loss (dB) + Antenna Factor (dB/m)

Site: AC1	Time: 2014/11/21 - 15:49
Limit: FCC_Part15.209_RE(3m)	Engineer: Knight Lu
Probe: BBHA9120D_1-18GHz	Polarity: Horizontal
EUT: 7.85 Inch Tablet	Power: By Battery
<b>Worse Case Mode : BLE at Channel 2480MHz</b>	

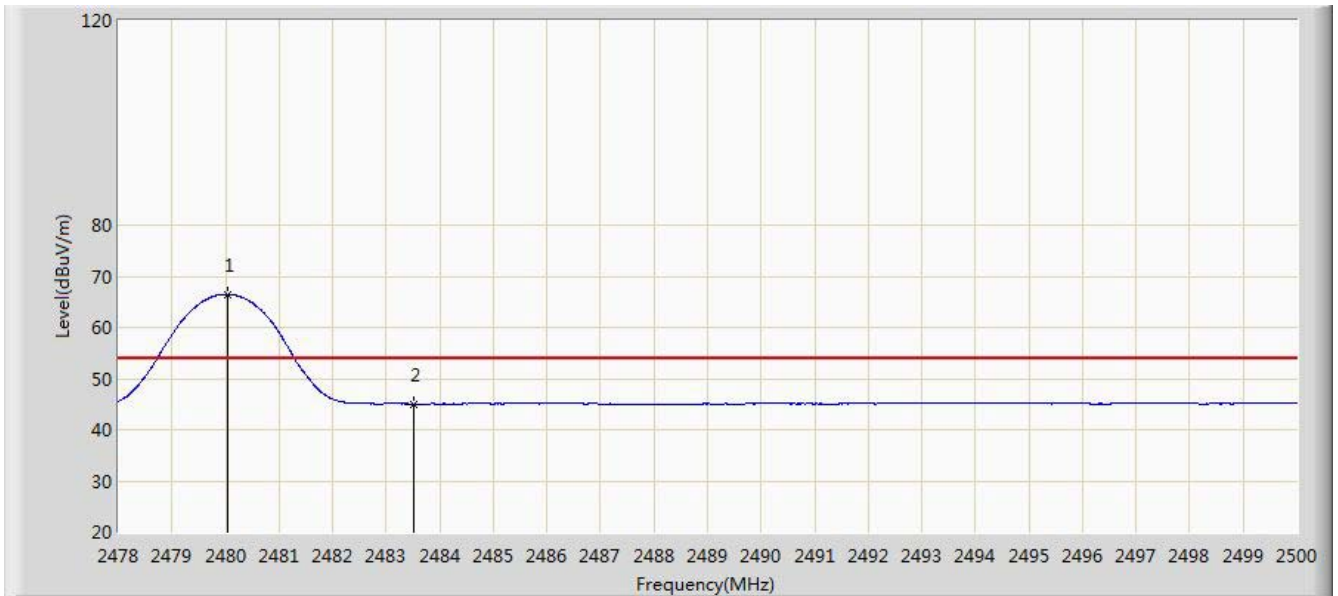

No	Frequency (MHz)	Measure Level (dBuV/m)	Reading Level (dBuV)	Over Limit (dB)	Limit (dBuV/m)	Factor (dB)	Type
1	2480.046	66.505	35.842	N/A	N/A	30.662	AV
2	2483.500	45.060	14.387	-8.940	54.000	30.673	AV

Note: Measure Level (dBμV/m) = Reading Level (dBμV) + Factor (dB)

Factor (dB) = Cable Loss (dB) + Antenna Factor (dB/m)

Site: AC1	Time: 2014/11/21 - 15:49
Limit: FCC_Part15.209_RE(3m)	Engineer: Knight Lu
Probe: BBHA9120D_1-18GHz	Polarity: Vertical
EUT: 7.85 Inch Tablet	Power: By Battery
<b>Worse Case Mode : BLE at Channel 2480MHz</b>	

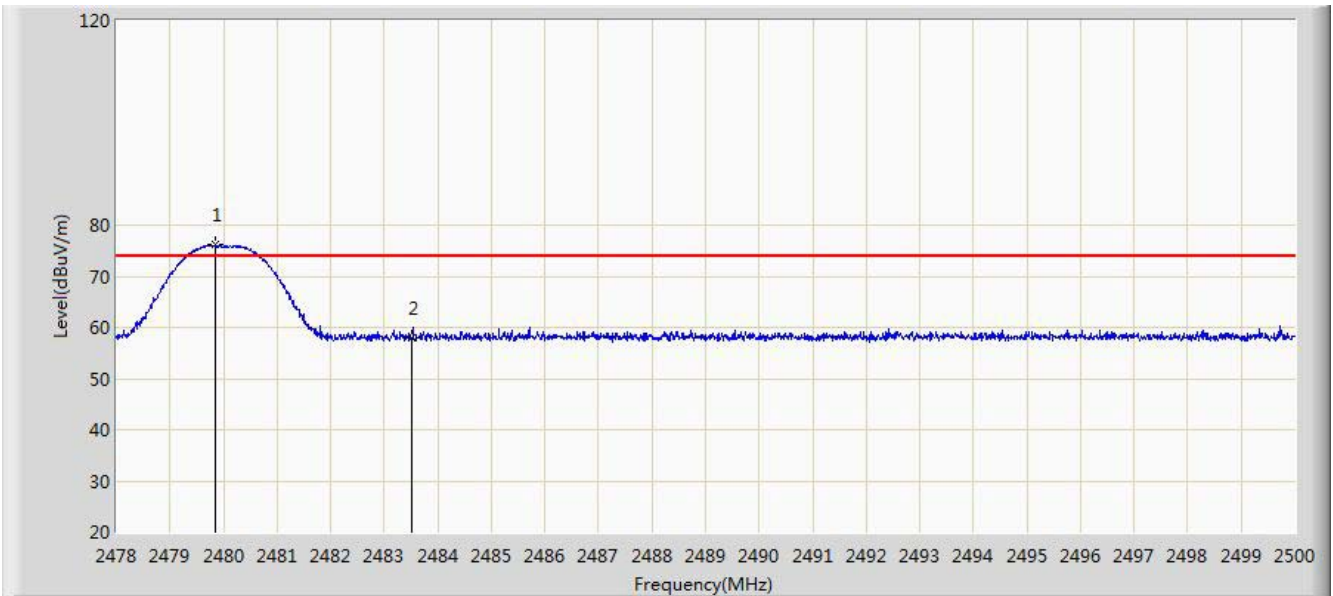

No	Frequency (MHz)	Measure Level (dBuV/m)	Reading Level (dBuV)	Over Limit (dB)	Limit (dBuV/m)	Factor (dB)	Type
1	2479.837	76.135	45.473	N/A	N/A	30.662	PK
2	2483.500	57.992	27.319	-16.008	74.000	30.673	PK

Note: Measure Level (dB $\mu$ V/m) = Reading Level (dB $\mu$ V) + Factor (dB)

Factor (dB) = Cable Loss (dB) + Antenna Factor (dB/m)

Site: AC1	Time: 2014/11/21 - 15:52
Limit: FCC_Part15.209_RE(3m)	Engineer: Knight Lu
Probe: BBHA9120D_1-18GHz	Polarity: Vertical
EUT: 7.85 Inch Tablet	Power: By Battery
<b>Worse Case Mode : BLE at Channel 2480MHz</b>	



No	Frequency (MHz)	Measure Level (dBuV/m)	Reading Level (dBuV)	Over Limit (dB)	Limit (dBuV/m)	Factor (dB)	Type
1	2480.079	63.055	32.392	N/A	N/A	30.662	AV
2	2483.500	45.087	14.414	-8.913	54.000	30.673	AV

Note: Measure Level (dBμV/m) = Reading Level (dBμV) + Factor (dB)

Factor (dB) = Cable Loss (dB) + Antenna Factor (dB/m)

## 7.8. AC Conducted Emissions Measurement

### 7.8.1. Test Limit

FCC Part 15 Subpart C Paragraph 15.207 Limits		
Frequency (MHz)	QP (dBuV)	AV (dBuV)
0.15 - 0.50	66 - 56	56 - 46
0.50 - 5.0	56	46
5.0 - 30	60	50

Note 1: The lower limit shall apply at the transition frequencies.

Note 2: The limit decreases linearly with the logarithm of the frequency in the range 0.15MHz to 0.5MHz.

### 7.8.2. Test Setup

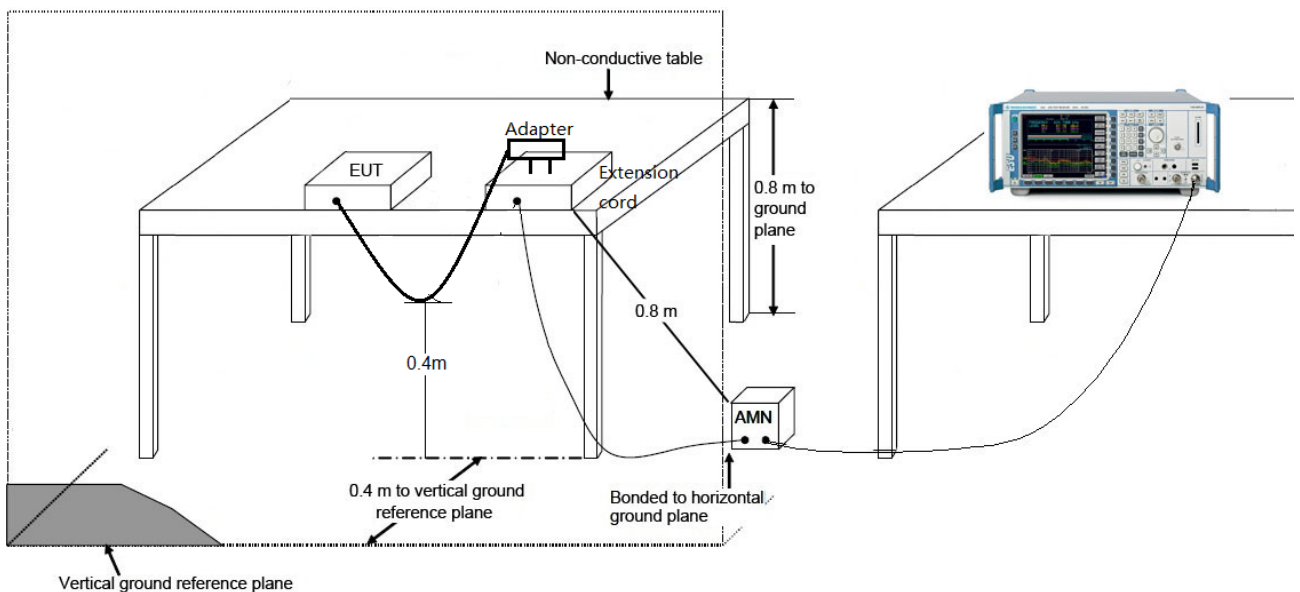

### 7.8.3. Test Result

Site: SR2	Time: 2014/11/21 - 16:46
Limit: FCC_Part15.207_CE_AC Power	Engineer: Knight Lu
Probe: ENV216_101683_Filter On	Polarity: Line
EUT: 7.85 Inch Tablet	Power: AC 120V/60Hz
Mode : Mode1	

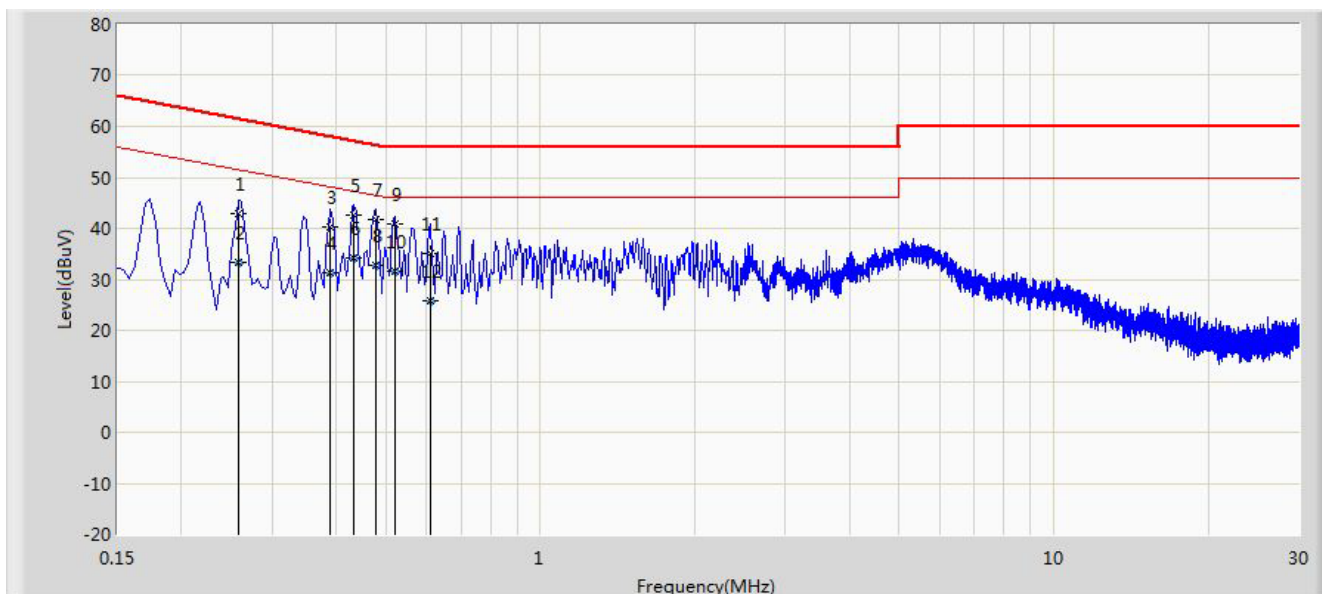

No	Frequency (MHz)	Measure Level (dBuV)	Reading Level (dBuV)	Over Limit (dB)	Limit (dBuV)	Factor (dB)	Type
1	0.258	42.872	32.902	-18.623	61.496	9.970	QP
2	0.258	33.288	23.318	-18.207	51.496	9.970	AV
3	0.390	40.252	30.175	-17.812	58.064	10.077	QP
4	0.390	31.243	21.166	-16.821	48.064	10.077	AV
5	0.434	42.602	32.488	-14.574	57.176	10.113	QP
6	0.434	34.209	24.095	-12.967	47.176	10.113	AV
7	0.478	41.694	31.545	-14.680	56.374	10.149	QP
8	0.478	32.641	22.493	-13.732	46.374	10.149	AV
9	0.522	40.926	30.771	-15.074	56.000	10.155	QP
10	0.522	31.465	21.310	-14.535	46.000	10.155	AV
11	0.610	35.062	24.952	-20.938	56.000	10.110	QP
12	0.610	25.725	15.615	-20.275	46.000	10.110	AV

Note: Measure Level (dBμV) = Reading Level (dBμV) + Factor (dB)

Factor (dB) = Cable Loss (dB) + LISN Factor (dB)

Site: SR2	Time: 2014/11/21 - 16:46
Limit: FCC_Part15.207_CE_AC Power	Engineer: Knight Lu
Probe: ENV216_101683_Filter On	Polarity: Neutral
EUT: 7.85 Inch Tablet	Power: AC 120V/60Hz
Mode : Mode1	

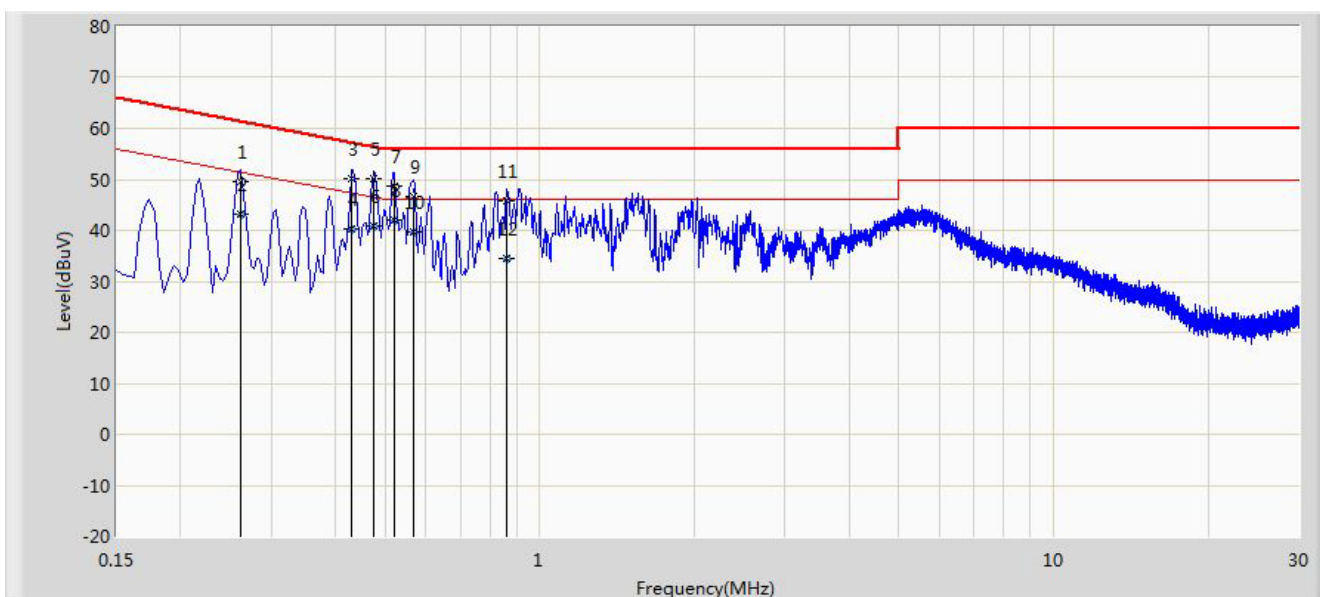

No	Frequency (MHz)	Measure Level (dBuV)	Reading Level (dBuV)	Over Limit (dB)	Limit (dBuV)	Factor (dB)	Type
1	0.262	49.538	39.528	-11.830	61.368	10.010	QP
2	0.262	43.312	33.302	-8.056	51.368	10.010	AV
3	0.430	50.065	39.930	-7.188	57.253	10.135	QP
4	0.430	40.409	30.274	-6.843	47.253	10.135	AV
5	0.474	50.246	40.079	-6.197	56.444	10.167	QP
6	0.474	40.816	30.649	-5.628	46.444	10.167	AV
7	0.522	48.717	38.543	-7.283	56.000	10.174	QP
8	0.522	41.964	31.790	-4.036	46.000	10.174	AV
9	0.566	46.658	36.509	-9.342	56.000	10.150	QP
10	0.566	39.832	29.683	-6.168	46.000	10.150	AV
11	0.862	45.936	35.951	-10.064	56.000	9.985	QP
12	0.862	34.486	24.501	-11.514	46.000	9.985	AV

Note: Measure Level (dBμV) = Reading Level (dBμV) + Factor (dB)

Factor (dB) = Cable Loss (dB) + LISN Factor (dB)



## 8. CONCLUSION

The data collected relate only the item(s) tested and show that the **7.85 Inch Tablet FCC ID: 2AAMSHM-7843Q** is in compliance with Part 15C of the FCC Rules.