

TEST REPORT

Report No.: BCTC2310719610-2E

Applicant: SHENZHEN NST INDUSTRY AND TRADE CO.,LTD

Product Name: 10.1 inch tablet PC

Test Model: T12

Tested Date: 2023-10-17 to 2024-01-17

Issued Date: 2024-01-18

Shenzhen BCTC Testing Co., Ltd.



IC: 11850A-T12T12S

Product Name: 10.1 inch tablet PC
Trademark: N/A
Model/Type reference: T12
M1X5CQ
Prepared For: SHENZHEN NST INDUSTRY AND TRADE CO.,LTD
Address: 3-4/F, Bldg 1, Hongbang Intelligent Technology Park, No.30 Cuibao Road, Baolong Street, Longgang District, Shenzhen
Manufacturer: SHENZHEN NST INDUSTRY AND TRADE CO.,LTD
Address: 3-4/F, Bldg 1, Hongbang Intelligent Technology Park, No.30 Cuibao Road, Baolong Street, Longgang District, Shenzhen
Prepared By: Shenzhen BCTC Testing Co., Ltd.
Address: 1-2/F., Building B, Pengzhou Industrial Park, No.158, Fuyuan 1st Road, Zhancheng, Fuhai Subdistrict, Bao'an District, Shenzhen, Guangdong, China
Sample Received Date: 2023-10-17
Sample tested Date: 2023-10-17 to 2024-01-17
Issue Date: 2024-01-18
Report No.: BCTC2310719610-2E
Test Standards: RSS-247 Issue 3: August 2023
RSS-Gen Issue 5: Amendment 2 (February 2021)
Test Results: PASS
Remark: This is Bluetooth BLE radio test report.

Tested by:

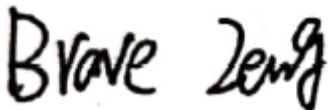

Brave Zeng/ Project Handler

Approved by:



Zero Zhou/Reviewer

The test report is effective only with both signature and specialized stamp. This result(s) shown in this report refer only to the sample(s) tested. Without written approval of Shenzhen BCTC Testing Co., Ltd, this report can't be reproduced except in full. The tested sample(s) and the sample information are provided by the client.

Table Of Content

Test Report Declaration	Page
1. Version	5
2. Test Summary	6
3. Measurement Uncertainty	7
4. Product Information And Test Setup	8
4.1 Product Information.....	8
4.2 Test Setup Configuration	8
4.3 Support Equipment	9
4.4 Channel List.....	9
4.5 Test Mode.....	9
4.6 Table Of Parameters Of Text Software Setting.....	10
5. Test Facility And Test Instrument Used.....	11
5.1 Test Facility.....	11
5.2 Test Instrument Used.....	11
6. Conducted Emissions.....	13
6.1 Block Diagram Of Test Setup.....	13
6.2 Limit	13
6.3 Test Procedure	13
6.4 EUT Operating Conditions	13
6.5 Test Result.....	14
7. Radiated Emissions.....	16
7.1 Block Diagram Of Test Setup.....	16
7.2 Limit	17
7.3 Test Procedure	18
7.4 EUT Operating Conditions	19
7.5 Test Result.....	19
8. Radiated Band Emission Measurement And Restricted Bands Of Operation	24
8.1 Block Diagram Of Test Setup.....	24
8.2 Limit	24
8.3 Test Procedure	25
8.4 EUT Operating Conditions	25
8.5 Test Result.....	26
9. Power Spectral Density Test	27
9.1 Block Diagram Of Test Setup.....	27
9.2 Limit	27
9.3 Test Procedure	27
9.4 EUT Operating Conditions	27
9.5 Test Result.....	28
10. Bandwidth Test.....	32
10.1 Block Diagram Of Test Setup.....	32
10.2 Limit	32
10.3 Test Procedure	32
10.4 EUT Operating Conditions	32
10.5 Test Result.....	32
11. Peak Output Power Test	39

11.1	Block Diagram Of Test Setup.....	39
11.2	Limit	39
11.3	Test Procedure	39
11.4	EUT Operating Conditions	39
11.5	Test Result.....	39
12.	100 KHz Bandwidth Of Frequency Band Edge.....	40
12.1	Block Diagram Of Test Setup.....	40
12.2	Limit	40
12.3	Test Procedure	40
12.4	EUT Operating Conditions	40
12.5	Test Result.....	41
13.	Antenna Requirement	51
13.1	Limit	51
13.2	Test Result.....	51
14.	Duty Cycle Of Test Signal	52
14.1	Standard Requirement.....	52
14.2	Formula.....	52
14.3	Test Procedure	52
15.	EUT Photographs.....	56
16.	EUT Test Setup Photographs.....	57

(Note: N/A Means Not Applicable)

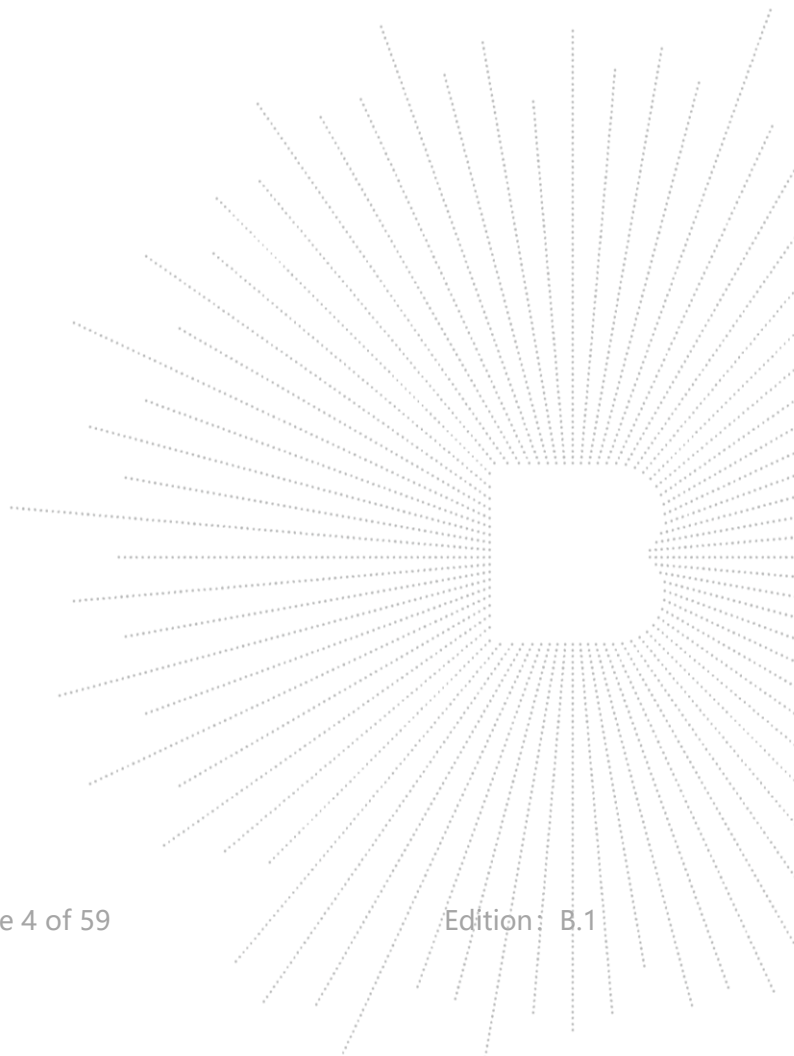

1. Version

Report No.	Issue Date	Description	Approved
BCTC2310719610-2E	2024-01-18	Original	Valid

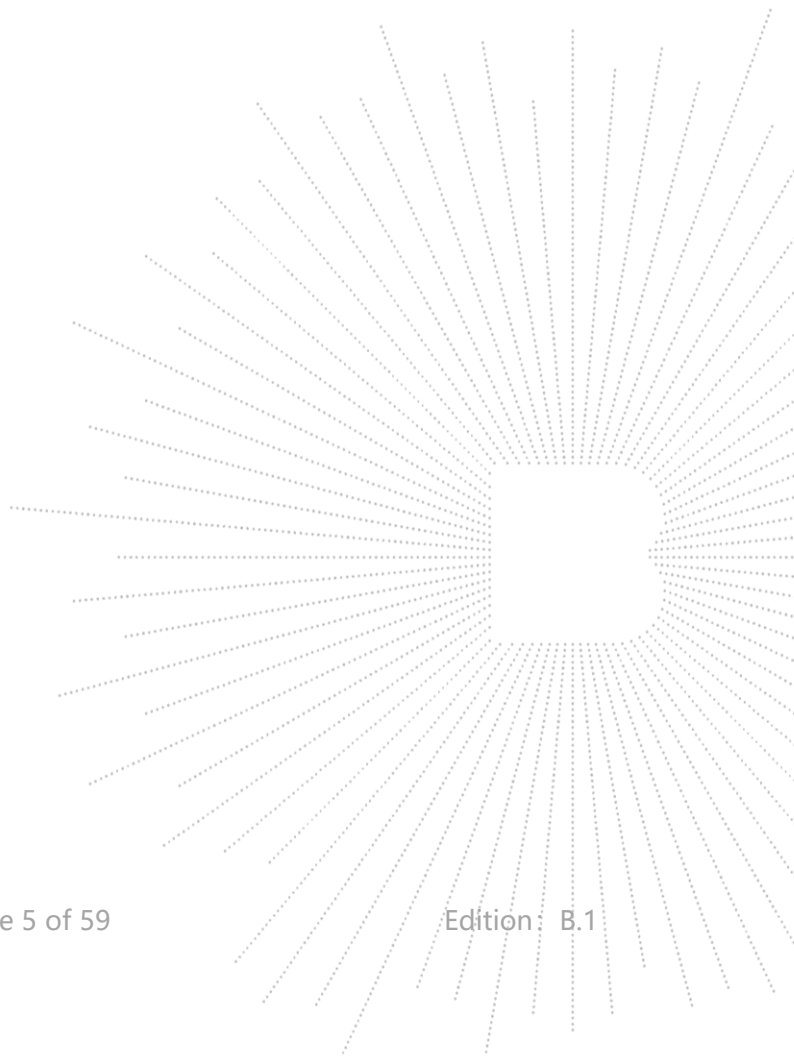

2. Test Summary

Test procedures according to the technical standards:

RSS-247 Issue 2: February 2017			
Standard Section	Test Item	Judgment	Remark
RSS-GEN 8.8 RSS-247 3.1	Conducted Emission	PASS	
RSS-247 5.2 (a) RSS-GEN 6.6	6dB Bandwidth	PASS	
RSS-Gen.6.7	99% Bandwidth	PASS	
RSS-247 5.4 (b)	Peak Output Power	PASS	
RSS-247 5.5	Radiated Spurious Emission	PASS	
RSS-247 5.2 (b)	Power Spectral Density	PASS	
RSS-247 5.5	Restricted Band of Operation	PASS	
RSS-Gen.6.7	Band Edge (Out of Band Emissions)	PASS	
RSS-GEN 6.8 RSS-247 3.1	Antenna Requirement	PASS	

NOTE:

(1) "N/A" denotes test is not applicable in this Test Report

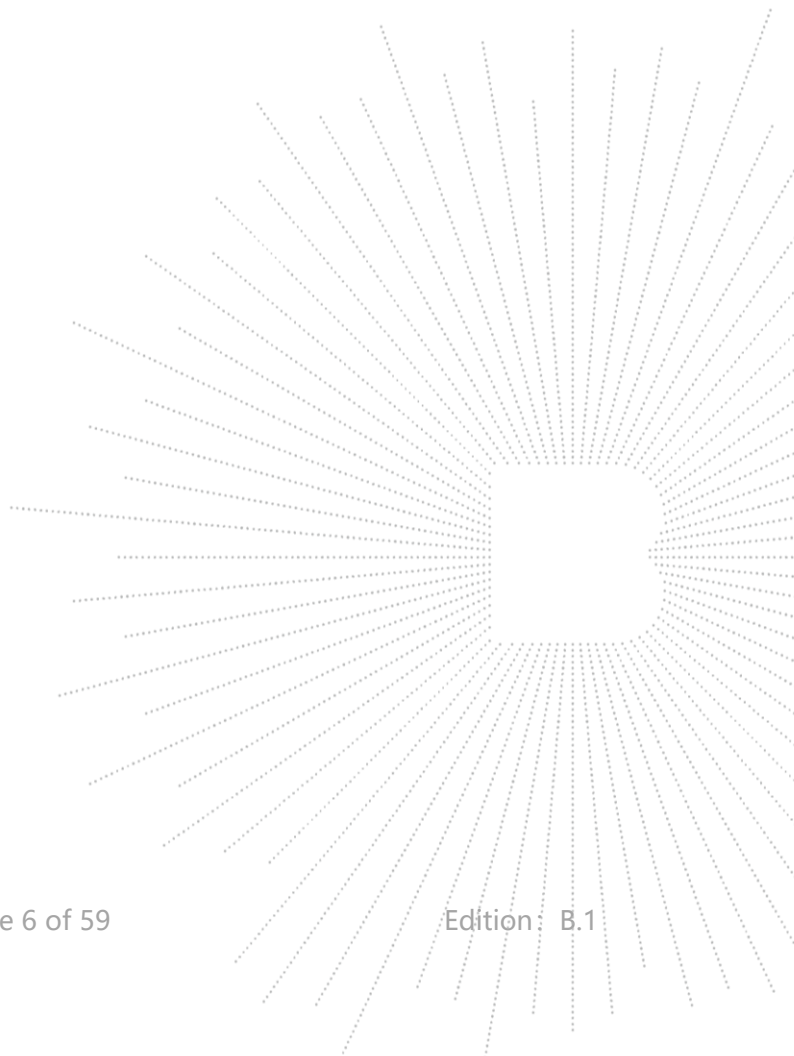

3. Measurement Uncertainty

The reported uncertainty of measurement $y \pm U$, where expanded uncertainty U is based on a standard uncertainty multiplied by a coverage factor of $k=2$, providing a level of confidence of approximately 95 %.

No.	Item	Uncertainty
1	3m chamber Radiated spurious emission(30MHz-1GHz)	U=4.3dB
2	3m chamber Radiated spurious emission(1GHz-18GHz)	U=4.5dB
3	3m chamber Radiated spurious emission(18GHz-40GHz)	U=3.34dB
4	Conducted Adjacent channel power	U=1.38dB
5	Conducted output power uncertainty Above 1G	U=1.576dB
6	Conducted output power uncertainty below 1G	U=1.28dB
7	humidity uncertainty	U=5.3%
8	Temperature uncertainty	U=0.59°C

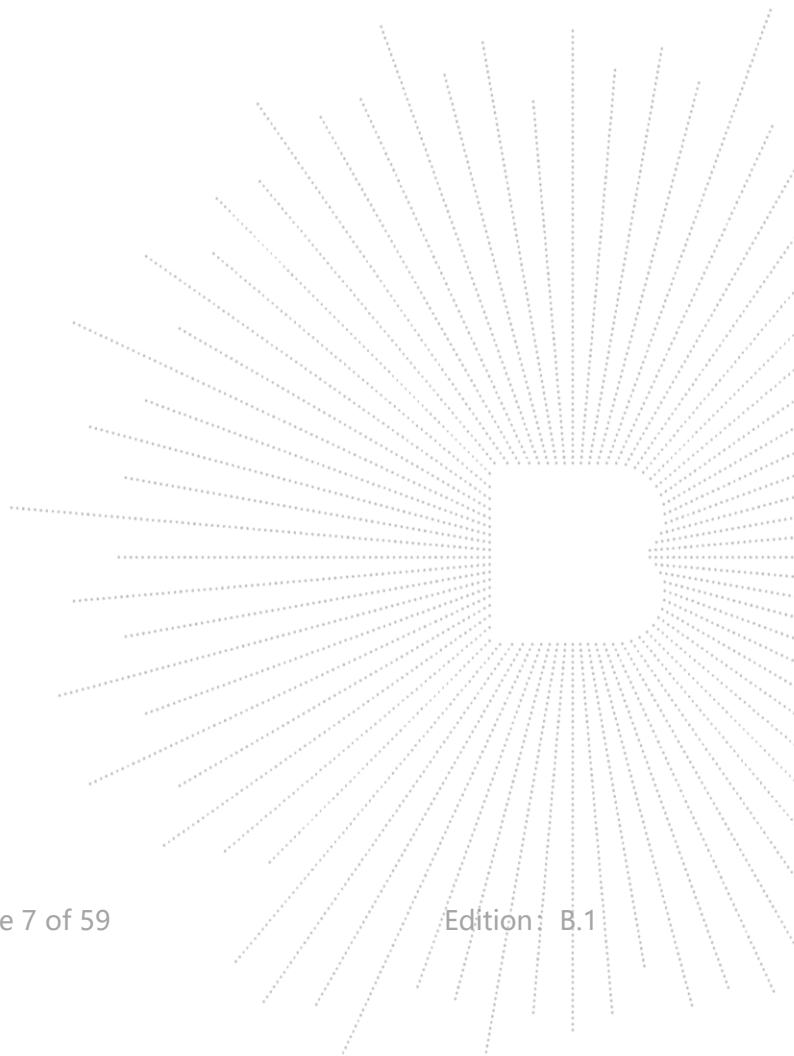

4. Product Information And Test Setup

4.1 Product Information

Model/Type reference:	T12 M1X5CQ
Model Differences:	All the model are the same circuit and RF module, except model names.
Bluetooth Version:	5.0
Hardware Version:	T30-T616-V2.0-230725-LU
Software Version:	SGIN_T12_ROW_V1.0_20231010
Operation Frequency:	2402-2480MHz
Type of Modulation:	GFSK
Number Of Channel	40CH
Data Rate	LE 1M PHY, LE 2M PHY
Antenna installation:	Internal antenna 1.27 dBi
Antenna Gain:	Remark: <input checked="" type="checkbox"/> The antenna gain of the product comes from the antenna report provided by the customer, and the test data is affected by the customer information. <input type="checkbox"/> The antenna gain of the product is provided by the customer, and the test data is affected by the customer information.
Ratings:	DC 5V from adapter/DC 3.8V from battery
Adapter Information:	MODEL: MK050200-T10USU INPUT: 100-240V-50/60Hz 0.5A Max OUTPUT: 5.0V  2000mA

4.2 Test Setup Configuration

See test photographs attached in *EUT TEST SETUP PHOTOGRAPHS* for the actual connections between Product and support equipment.

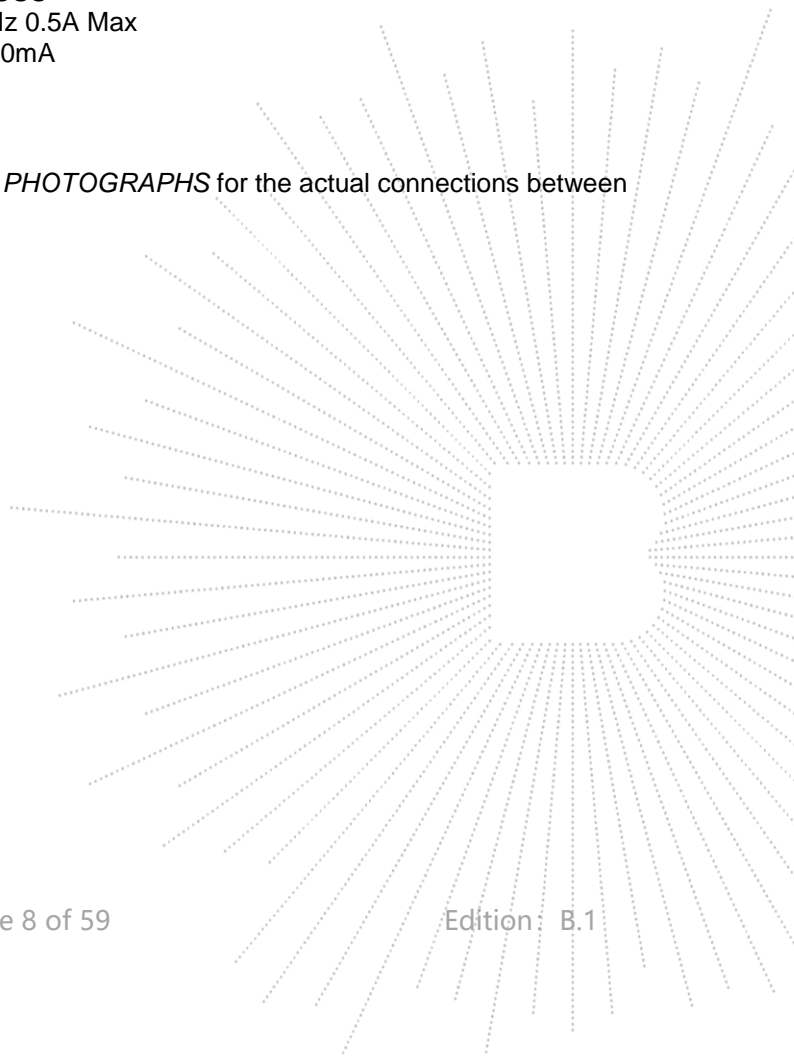

4.3 Support Equipment

No.	Device Type	Brand	Model	Series No.	Note
E-1	10.1 inch tablet PC	N/A	T12	N/A	EUT
E-2	Adapter	N/A	MK050200-T10 USU	N/A	Auxiliary

Item	Shielded Type	Ferrite Core	Length	Note
C-1	NO	NO	1M	DC cable unshielded

Notes:

- All the equipment/cables were placed in the worst-case configuration to maximize the emission during the test.
- Grounding was established in accordance with the manufacturer's requirements and conditions for the intended use.

4.4 Channel List

Channel List					
Channel	Frequency (MHz)	Channel	Frequency (MHz)	Channel	Frequency (MHz)
01	2402	11	2422	21	2442
02	2404	12	2424	22	2444
03	2406	13	2426	23	2446
~	~	~	~	~	~
09	2418	19	2438	39	2478
10	2420	20	2440	40	2480

4.5 Test Mode

To investigate the maximum EMI emission characteristics generated from EUT, the test system was pre-scanning tested based on the consideration of following EUT operation mode or test configuration mode which possible have effect on EMI emission level. Each of these EUT operation mode(s) or test configuration mode(s) mentioned above was evaluated respectively.

For All Mode	Description	Modulation Type
Mode 1	CH01	GFSK 1Mbps
Mode 2	CH20	
Mode 3	CH40	
Mode 4	CH01	GFSK 2Mbps
Mode 5	CH20	
Mode 6	CH40	
Mode 7	Link	

Note:

- The measurements are performed at the highest, middle, lowest available channels.
- Fully-charged battery is used during the test

4.6 Table Of Parameters Of Text Software Setting

During testing channel & power controlling software provided by the customer was used to control the operating channel as well as the output power level. The RF output power selection is for the setting of RF output power expected by the customer and is going to be fixed on the firmware of the final end product power parameters

Test software Version	Pixart BLE Utility		
Frequency	2402 MHz	2440 MHz	2480 MHz
Parameters	DEF	DEF	DEF

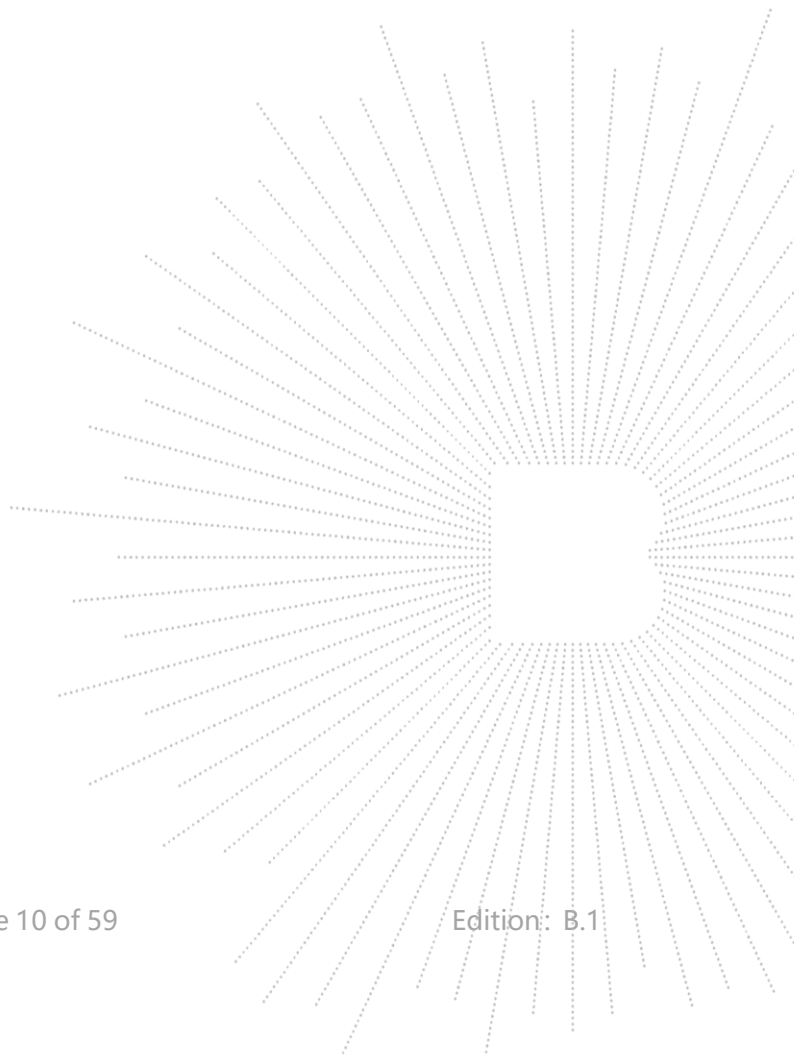

5. Test Facility And Test Instrument Used

5.1 Test Facility

All measurement facilities used to collect the measurement data are located at Shenzhen BCTC Testing Co., Ltd. Address: 1-2/F., Building B, Pengzhou Industrial Park, No.158, Fuyuan 1st Road, Zhancheng, Fuhai Subdistrict, Bao'an District, Shenzhen, Guangdong, China. The site and apparatus are constructed in conformance with the requirements of ANSI C63.4 and CISPR 16-1-1 other equivalent standards.

FCC Test Firm Registration Number: 712850

A2LA certificate registration number is: CN1212

ISED Registered No.: 23583

ISED CAB identifier: CN0017

5.2 Test Instrument Used

Conducted Emissions Test					
Equipment	Manufacturer	Model#	Serial#	Last Cal.	Next Cal.
Receiver	R&S	ESR3	102075	May 15, 2023	May 14, 2024
LISN	R&S	ENV216	101375	May 15, 2023	May 14, 2024
Software	Frad	EZ-EMC	EMC-CON 3A1	\	\
Pulse limiter	Schwarzbeck	VTSD9561-F	01323	Sept. 22, 2023	Sept 21, 2024

RF Conducted Test					
Equipment	Manufacturer	Model#	Serial#	Last Cal.	Next Cal.
Power meter	Keysight	E4419	\	May 15, 2023	May 14, 2024
Power Sensor (AV)	Keysight	E9300A	\	May 15, 2023	May 14, 2024
Signal Analyzer20kHz-26.5GHz	Keysight	N9020A	MY49100060	May 15, 2023	May 14, 2024
Spectrum Analyzer9kHz-40GHz	R&S	FSP40	100363	May 15, 2023	May 14, 2024
Radio frequency control box	MAIWEI	MW100-RFC B	\	\	\
Software	MAIWEI	MTS 8310	\	\	\

Radiated Emissions Test (966 Chamber01)					
Equipment	Manufacturer	Model#	Serial#	Last Cal.	Next Cal.
966 chamber	ChengYu	966 Room	966	May 15, 2023	May 14, 2026
Receiver	R&S	ESR3	102075	May 15, 2023	May 14, 2024
Receiver	R&S	ESRP	101154	May 15, 2023	May 14, 2024
Amplifier	Schwarzbeck	BBV9744	9744-0037	May 15, 2023	May 14, 2024
TRILOG Broadband Antenna	Schwarzbeck	VULB9163	942	May 29, 2023	May 28, 2024
Loop Antenna(9KHz -30MHz)	Schwarzbeck	FMZB1519B	00014	May 31, 2023	May 30, 2024
Amplifier	SKET	LAPA_01G18 G-45dB	SK2021040901	May 15, 2023	May 14, 2024
Horn Antenna	Schwarzbeck	BBHA9120D	1541	May 31, 2023	May 30, 2024
Amplifier(18G Hz-40GHz)	MITEQ	TTA1840-35-HG	2034381	May 15, 2023	May 14, 2024
Horn Antenna18GHz-40GHz)	Schwarzbeck	BBHA9170	00822	May 31, 2023	May 30, 2024
Spectrum Analyzer9kHz-40GHz	R&S	FSP40	100363	May 15, 2023	May 14, 2024
Software	Frad	EZ-EMC	FA-03A2 RE	\	\

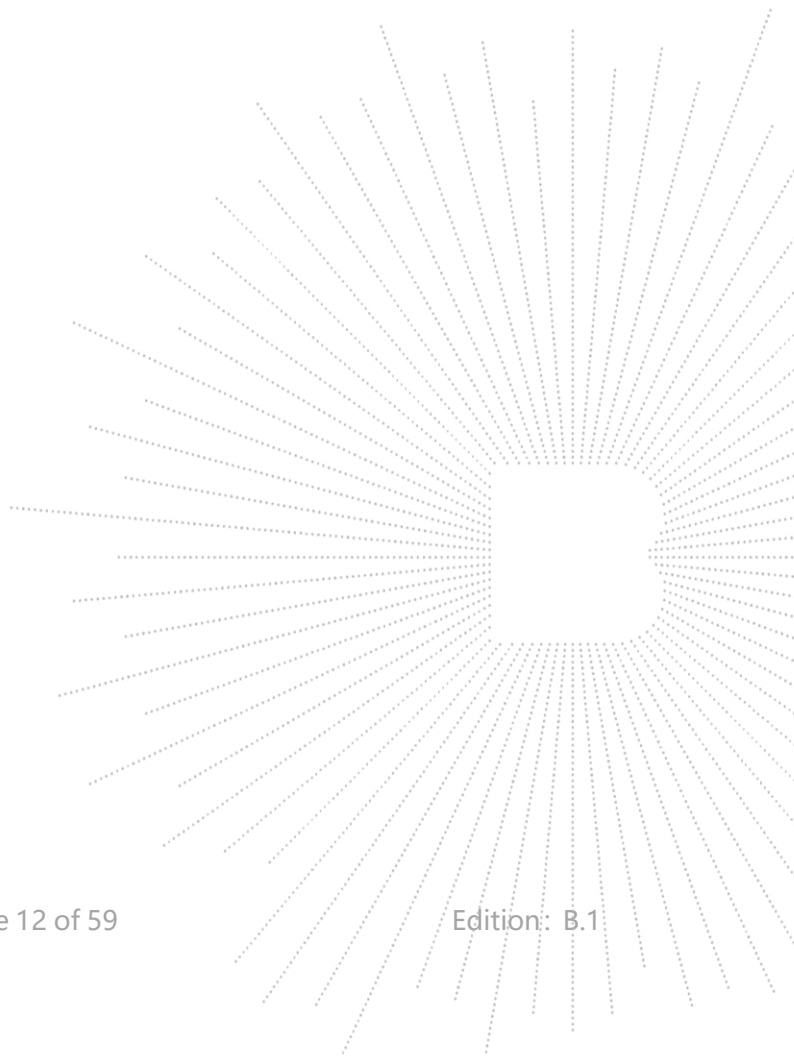

6. Conducted Emissions

6.1 Block Diagram Of Test Setup

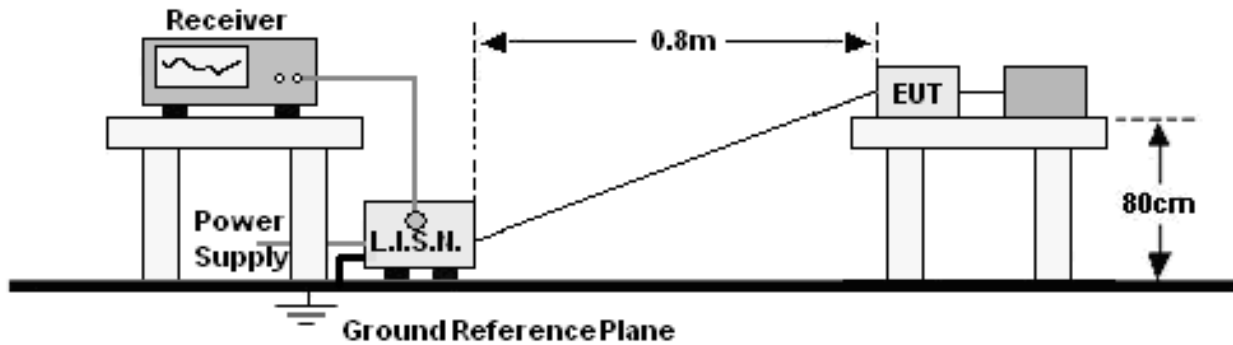

6.2 Limit

FREQUENCY (MHz)	Limit (dBuV)	
	Quas-peak	Average
0.15 -0.5	66 - 56 *	56 - 46 *
0.50 -5.0	56.00	46.00
5.0 -30.0	60.00	50.00

Notes:

- *Decreasing linearly with logarithm of frequency.
- The lower limit shall apply at the transition frequencies.

6.3 Test Procedure

Receiver Parameters	Setting
Attenuation	10 dB
Start Frequency	0.15 MHz
Stop Frequency	30 MHz
IF Bandwidth	9 kHz

- The Product was placed on a nonconductive table 0.8 m above the horizontal ground reference plane, and 0.4 m from the vertical ground reference plane, and connected to the main through Line Impedance Stability Network (L.I.S.N).
- The RBW of the receiver was set at 9 kHz in 150 kHz ~ 30MHz with Peak and AVG detector in Max Hold mode. Run the receiver's pre-scan to record the maximum disturbance generated from Product in all power lines in the full band.
- For each frequency whose maximum record was higher or close to limit, measure its QP and AVG values and record.

6.4 EUT Operating Conditions

The EUT was configured for testing in a typical fashion (as a customer would normally use it). The EUT has been programmed to continuously transmit during test. This operating condition was tested and used to collect the included data.

6.5 Test Result

Temperature:	26 °C	Relative Humidity:	54%
Pressure:	101KPa	Phase :	L
Test Mode:	Mode 7	Test Voltage :	AC 120V/60Hz

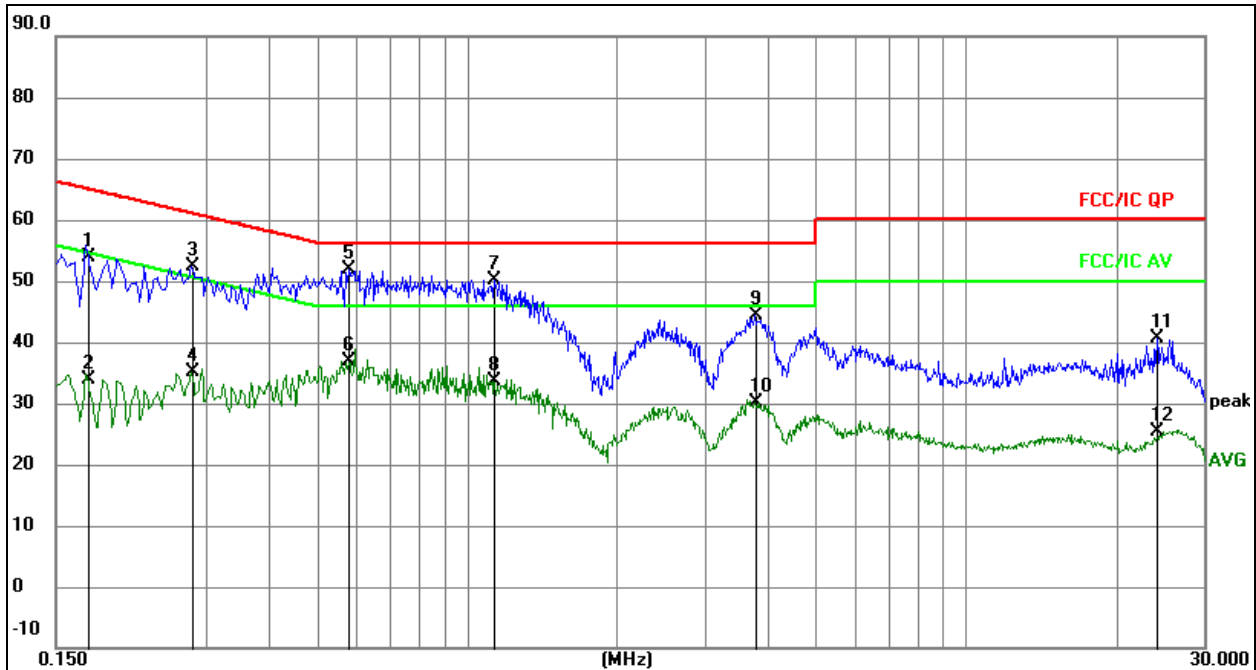

Remark:

1. All readings are Quasi-Peak and Average values.
2. Factor = Insertion Loss + Cable Loss.
3. Measurement=Reading Level+ Correct Factor
4. Over=Measurement-Limit

No.	Mk.	Freq. MHz	Reading Level	Correct Factor dB	Measure- ment dBuV	Limit dBuV	Over dB	Detector
1		0.1740	34.22	19.78	54.00	64.77	-10.77	QP
2		0.1740	14.09	19.78	33.87	54.77	-20.90	AVG
3		0.2803	32.52	19.83	52.35	60.81	-8.46	QP
4		0.2803	15.39	19.83	35.22	50.81	-15.59	AVG
5	*	0.5792	31.94	19.84	51.78	56.00	-4.22	QP
6		0.5792	17.02	19.84	36.86	46.00	-9.14	AVG
7		1.1352	30.21	19.95	50.16	56.00	-5.84	QP
8		1.1352	13.60	19.95	33.55	46.00	-12.45	AVG
9		3.7794	23.80	20.58	44.38	56.00	-11.62	QP
10		3.7794	9.47	20.58	30.05	46.00	-15.95	AVG
11		24.1423	20.54	19.99	40.53	60.00	-19.47	QP
12		24.1423	5.38	19.99	25.37	50.00	-24.63	AVG

Temperature:	26 °C	Relative Humidity:	54%
Pressure:	101KPa	Phase :	N
Test Mode:	Mode 7	Test Voltage :	AC 120V/60Hz

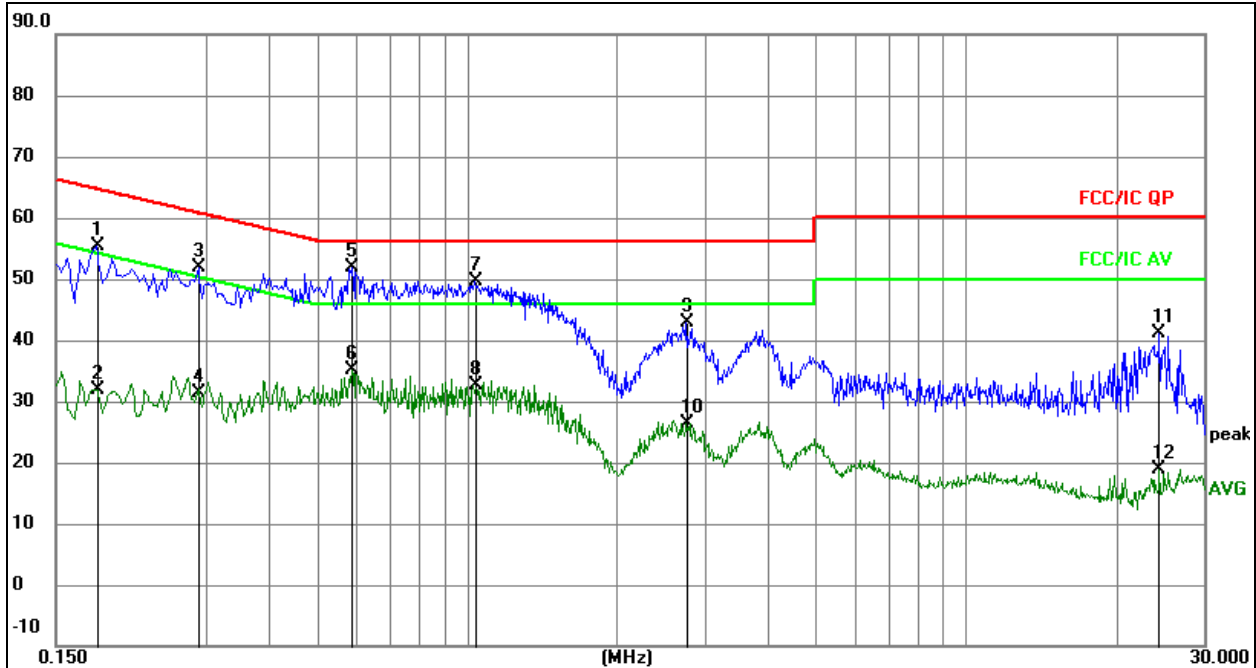
Remark:

1. All readings are Quasi-Peak and Average values.
2. Factor = Insertion Loss + Cable Loss.
3. Measurement=Reading Level+ Correct Factor
4. Over=Measurement-Limit

No.	Mk.	Freq. MHz	Reading Level	Correct Factor dB	Measure- ment dBuV	Limit dBuV	Over dB	Detector
1		0.1806	35.55	19.79	55.34	64.46	-9.12	QP
2		0.1806	12.12	19.79	31.91	54.46	-22.55	AVG
3		0.2893	32.09	19.83	51.92	60.54	-8.62	QP
4		0.2893	11.56	19.83	31.39	50.54	-19.15	AVG
5	*	0.5885	31.94	19.84	51.78	56.00	-4.22	QP
6		0.5885	15.32	19.84	35.16	46.00	-10.84	AVG
7		1.0375	29.67	19.95	49.62	56.00	-6.38	QP
8		1.0375	12.58	19.95	32.53	46.00	-13.47	AVG
9		2.7502	22.57	20.22	42.79	56.00	-13.21	QP
10		2.7502	6.15	20.22	26.37	46.00	-19.63	AVG
11		24.3994	21.22	19.99	41.21	60.00	-18.79	QP
12		24.3994	-1.17	19.99	18.82	50.00	-31.18	AVG

7. Radiated Emissions

7.1 Block Diagram Of Test Setup

(A) Radiated Emission Test-Up Frequency Below 30MHz

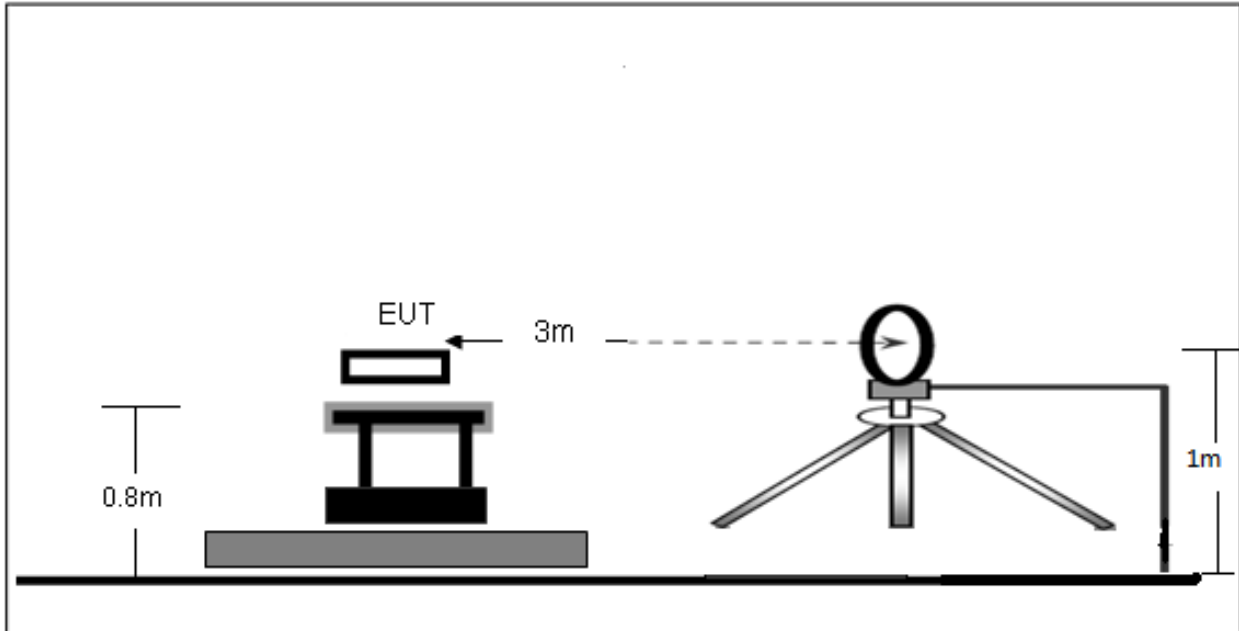

(B) Radiated Emission Test-Up Frequency 30MHz~1GHz

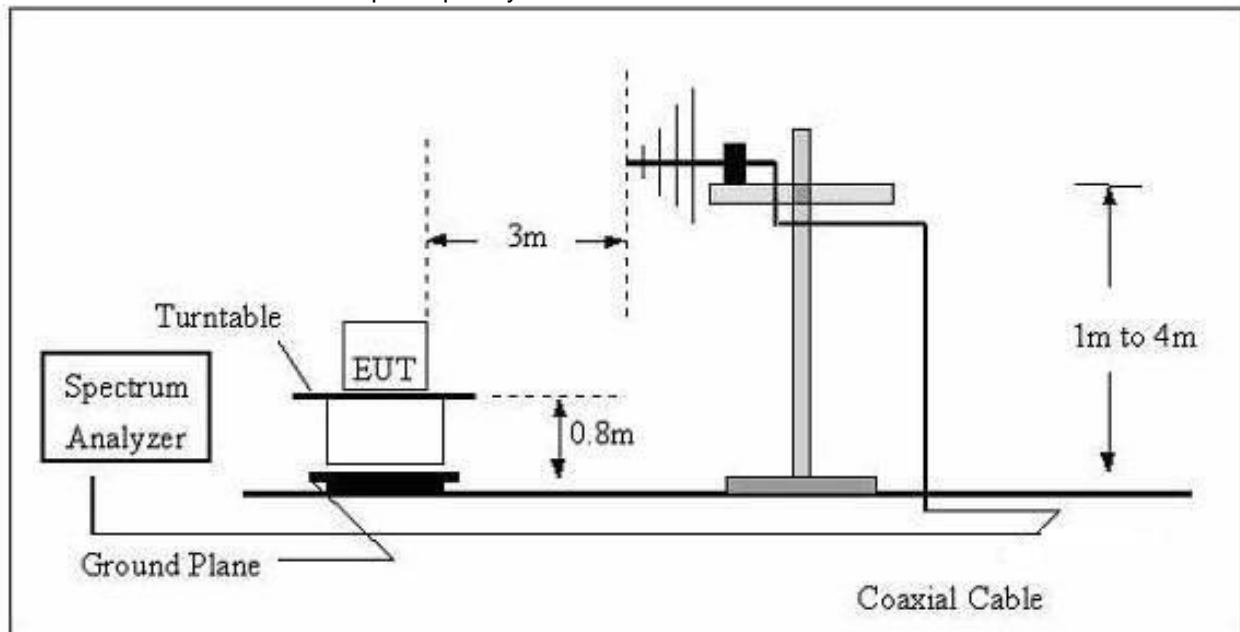

(C) Radiated Emission Test-Up Frequency Above 1GHz

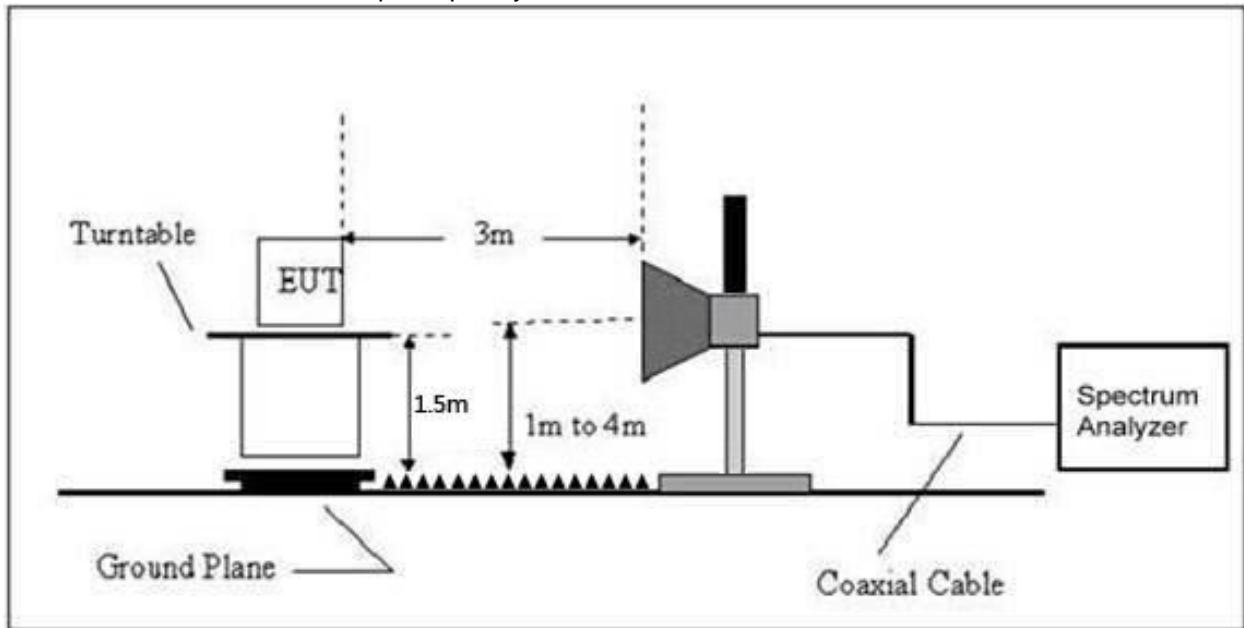

7.2 Limit

In case the emission fall within the restricted band specified on RSS-GEN, then the RSS-247 limit in the table below has to be followed.

Frequency (MHz)	Field Strength uV/m	Distance (m)	Field Strength Limit at 3m Distance	
			uV/m	dBuV/m
0.009 ~ 0.490	2400/F(kHz)	300	10000 * 2400/F(kHz)	20log ^{(2400/F(kHz))} + 80
0.490 ~ 1.705	24000/F(kHz)	30	100 * 24000/F(kHz)	20log ^{(24000/F(kHz))} + 40
1.705 ~ 30	30	30	100 * 30	20log ⁽³⁰⁾ + 40
30 ~ 88	100	3	100	20log ⁽¹⁰⁰⁾
88 ~ 216	150	3	150	20log ⁽¹⁵⁰⁾
216 ~ 960	200	3	200	20log ⁽²⁰⁰⁾
Above 960	500	3	500	20log ⁽⁵⁰⁰⁾

LIMITS OF RADIATED EMISSION MEASUREMENT (Above 1000MHz)

FREQUENCY (MHz)	Limit (dBuV/m) (at 3M)	
	PEAK	AVERAGE
Above 1000	74	54

Notes:

- (1) The limit for radiated test was performed according to FCC PART 15C.
- (2) The tighter limit applies at the band edges.
- (3) Emission level (dBuV/m) = 20log Emission level (uV/m).

Spectrum Parameter	Setting
Attenuation	Auto
Start Frequency	1000 MHz
Stop Frequency	25GHz
RB / VB (emission in restricted band)	1 MHz / 1 MHz for Peak, 1 MHz / 10Hz for Average

Receiver Parameter	Setting
Attenuation	Auto
Start ~ Stop Frequency	9kHz~150kHz / RB 200Hz for QP
Start ~ Stop Frequency	150kHz~30MHz / RB 9kHz for QP
Start ~ Stop Frequency	30MHz~1000MHz / RB 120kHz for QP

7.3 Test Procedure

Below 1GHz test procedure as below:

- a. The EUT was placed on the top of a rotating table 0.8 meters above the ground at a 3 meter semi-anechoic chamber. The table was rotated 360 degrees to determine the position of the highest radiation.
- b. The EUT was set 3 meters away from the interference-receiving antenna, which was mounted on the top of a variable-height antenna tower.
- c. The antenna height is varied from one meter to four meters above the ground to determine the maximum value of the field strength. Both horizontal and vertical polarizations of the antenna are set to make the measurement.
- d. For each suspected emission, the EUT was arranged to its worst case and then the antenna was tuned to heights from 1 meter to 4 meters (for the test frequency of below 30MHz, the antenna was tuned to heights 1 meter) and the rotatable table was turned from 0 degrees to 360 degrees to find the maximum reading.
- e. The test-receiver system was set to Peak Detect Function and Specified Bandwidth with Maximum Hold Mode.
- f. If the emission level of the EUT in peak mode was 10dB lower than the limit specified, then testing could be stopped and the peak values of the EUT would be reported. Otherwise the emissions that did not have 10dB margin would be re-tested one by one using peak, quasi-peak or average method as specified and then reported in a data sheet.

Above 1GHz test procedure as below:

- g. Different between above is the test site, change from Semi- Anechoic Chamber to fully Anechoic Chamber and change form table 0.8 metre to 1.5 metre(Above 18GHz the distance is 1 meter and table is 1.5 metre).
- h. Test the EUT in the lowest channel ,the middle channel ,the Highest channel.

Note:

Both horizontal and vertical antenna polarities were tested and performed pretest to three orthogonal axis. The worst case emissions were reported.

Above 1GHz test procedure as below:

- a.The EUT was placed on the top of a rotating table 1.5 meters above the ground at a 3 meter chamber. The table was rotated 360 degrees to determine the position of the highest radiation.
- b.The EUT was set 3 meters away from the interference-receiving antenna, which was mounted on the top of a variable-height antenna tower.
- c.The antenna height is varied from one meter to four meters above the ground to determine the maximum value of the field strength. Both horizontal and vertical polarizations of the antenna are set to make the measurement.
- d.For each suspected emission, the EUT was arranged to its worst case and then the antenna was tuned to heights from 1 meter to 4 meters and the rota table was turned from 0 degrees to 360 degrees to find the maximum reading.

e. The test-receiver system was set to Peak Detect Function and Specified Bandwidth with Maximum Hold Mode.

f. If the emission level of the EUT in peak mode was 10dB lower than the limit specified, then testing could be stopped and the peak values of the EUT would be reported. Otherwise the emissions that did not have 10dB margin would be re-tested one by one using peak, quasi-peak or average method as specified and then reported in a data sheet.

g. Test the EUT in the lowest channel, the Highest channel.

Note:

Both horizontal and vertical antenna polarities were tested and performed pretest to three orthogonal axis. The worst case emissions were reported.

7.4 EUT Operating Conditions

The EUT was configured for testing in a typical fashion (as a customer would normally use it). The EUT has been programmed to continuously transmit during test. This operating condition was tested and used to collect the included data.

7.5 Test Result

Below 30MHz

Temperature:	26°C	Relative Humidity:	24%
Pressure:	101KPa	Test Voltage :	AC 120V/60Hz
Test Mode:	Mode 7	Polarization :	--

Freq. (MHz)	Reading (dBuV/m)	Limit (dBuV/m)	Margin (dB)	State P/F
--	--	--	--	PASS
--	--	--	--	PASS

Note:

The amplitude of spurious emissions which are attenuated by more than 20dB below the permissible value has no need to be reported.

Distance extrapolation factor = $40 \log(\text{specific distance}/\text{test distance})$ (dB);

Limit line = specific limits(dBuv) + distance extrapolation factor.

Between 30MHz – 1GHz

Temperature:	26°C	Relative Humidity:	54%
Pressure:	101KPa	Phase :	Horizontal
Test Mode:	Mode 7	Test Voltage :	AC 120V/60Hz

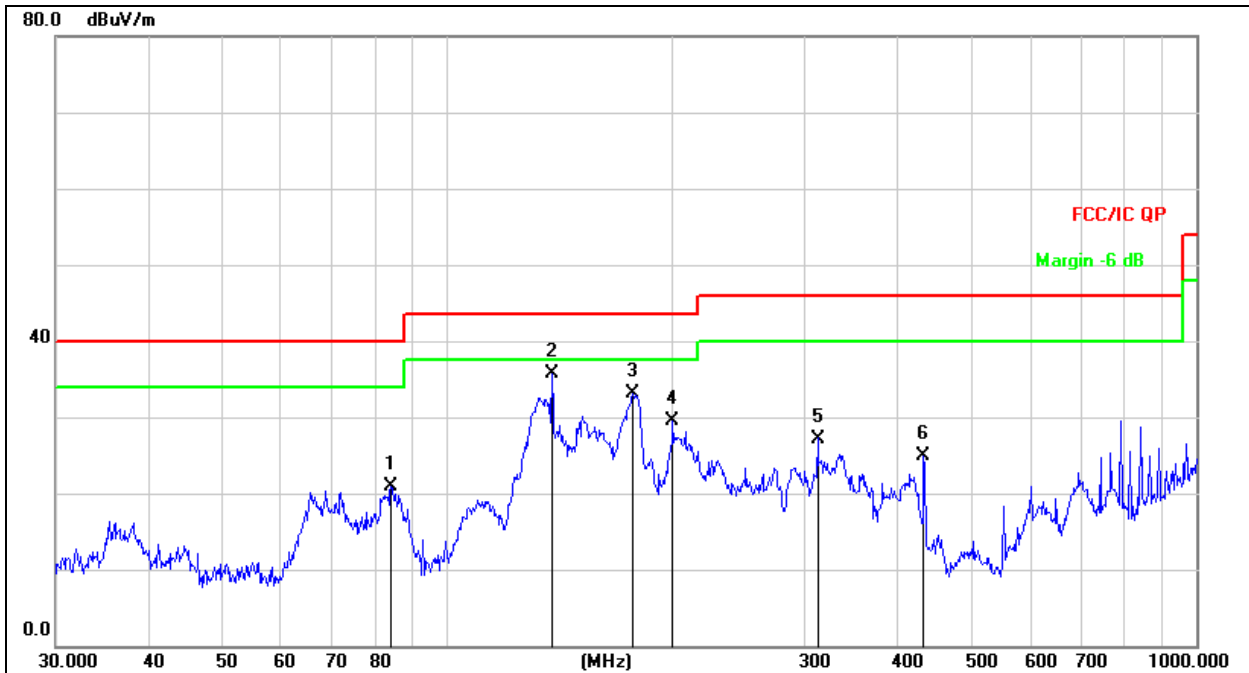

Remark:

1. Factor = Antenna Factor + Cable Loss – Pre-amplifier.
2. Measurement=Reading Level+ Correct Factor
3. Over=Measurement-Limit

No.	Mk.	Freq. MHz	Reading Level dBuV	Correct Factor dB	Measure- ment dBuV/m	Limit dB/m	Over dB	Detector
1		84.1100	36.63	-15.68	20.95	40.00	-19.05	QP
2	*	137.9028	49.53	-13.87	35.66	43.50	-7.84	QP
3		176.8878	46.89	-13.79	33.10	43.50	-10.40	QP
4		199.9856	43.52	-14.02	29.50	43.50	-14.00	QP
5		312.1794	45.72	-18.52	27.20	46.00	-18.80	QP
6		432.5457	42.56	-17.72	24.84	46.00	-21.16	QP

Temperature:	26°C	Relative Humidity:	54%
Pressure:	101KPa	Phase :	Vertical
Test Mode:	Mode 7	Test Voltage :	AC 120V/60Hz

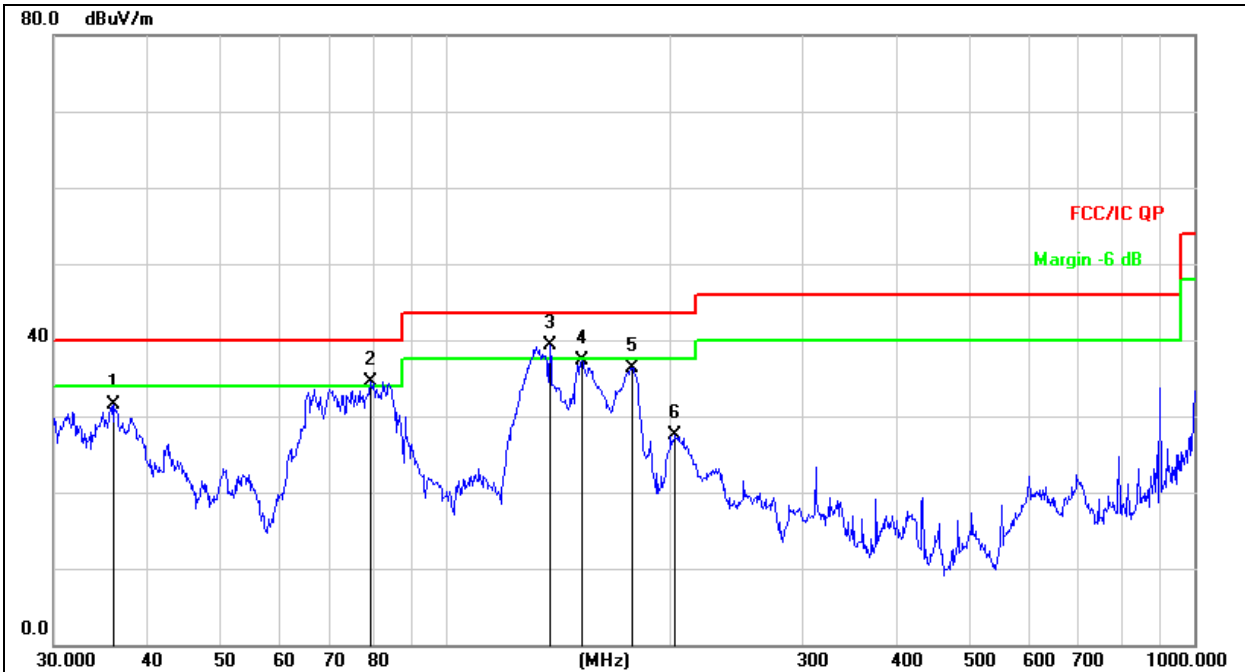

Remark:

1. Factor = Antenna Factor + Cable Loss – Pre-amplifier.
2. Measurement=Reading Level+ Correct Factor
3. Over=Measurement-Limit

No.	Mk.	Freq.	Reading Level	Correct Factor	Measurement	Limit	Over	Detector
		MHz	dBuV	dB	dBuV/m	dB/m	dB	
1		36.1272	48.12	-16.66	31.46	40.00	-8.54	QP
2	!	79.5209	50.45	-15.97	34.48	40.00	-5.52	QP
3	*	137.9028	53.25	-13.87	39.38	43.50	-4.12	QP
4		152.1297	50.76	-13.55	37.21	43.50	-6.29	QP
5		177.5092	50.11	-13.80	36.31	43.50	-7.19	QP
6		202.8104	41.58	-14.14	27.44	43.50	-16.06	QP

Between 1GHz – 25GHz

GFSK 1Mbps							
Polar (H/V)	Fre- quency	Reading Level	Correct Factor	Measure- ment	Limits	Over	Detector Type
	(MHz)	(dBuV/m)	(dB)	(dBuV/m)	(dBuV/m)	(dB)	
Low channel							
V	4804.00	70.87	-19.99	50.88	74.00	-23.12	PK
V	4804.00	60.97	-19.99	40.98	54.00	-13.02	AV
V	7206.00	60.88	-14.22	46.66	74.00	-27.34	PK
V	7206.00	51.11	-14.22	36.89	54.00	-17.11	AV
H	4804.00	66.83	-19.99	46.84	74.00	-27.16	PK
H	4804.00	57.54	-19.99	37.55	54.00	-16.45	AV
H	7206.00	59.28	-14.22	45.06	74.00	-28.94	PK
H	7206.00	50.98	-14.22	36.76	54.00	-17.24	AV
Middle channel							
V	4880.00	69.05	-19.84	49.21	74.00	-24.79	PK
V	4880.00	61.39	-19.84	41.55	54.00	-12.45	AV
V	7320.00	62.00	-13.90	48.10	74.00	-25.90	PK
V	7320.00	53.38	-13.90	39.48	54.00	-14.52	AV
H	4880.00	66.90	-19.84	47.06	74.00	-26.94	PK
H	4880.00	56.06	-19.84	36.22	54.00	-17.78	AV
H	7320.00	60.00	-13.90	46.10	74.00	-27.90	PK
H	7320.00	52.18	-13.90	38.28	54.00	-15.72	AV
High channel							
V	4960.00	72.03	-19.68	52.35	74.00	-21.65	PK
V	4960.00	61.57	-19.68	41.89	54.00	-12.11	AV
V	7440.00	64.41	-13.57	50.84	74.00	-23.16	PK
V	7440.00	54.93	-13.57	41.36	54.00	-12.64	AV
H	4960.00	70.02	-19.68	50.34	74.00	-23.66	PK
H	4960.00	60.91	-19.68	41.23	54.00	-12.77	AV
H	7440.00	62.45	-13.57	48.88	74.00	-25.12	PK
H	7440.00	55.35	-13.57	41.78	54.00	-12.22	AV

Remark:

1. Measurement = Reading Level + Correct Factor,
Correct Factor = Antenna Factor + Cable Loss - Pre-amplifier,
Over= Measurement - Limit
- 2.If peak below the average limit, the average emission was no test.
3. In restricted bands of operation, The spurious emissions below the permissible value more than 20dB
4. The amplitude of spurious emissions which are attenuated by more than 20dB below the permissible value has no need to be reported.
- 5.This report only shows the worst case test data.

GFSK 2Mbps							
Polar (H/V)	Fre- quency	Reading Level	Correct Factor	Measure- ment	Limits	Over	Detector Type
	(MHz)	(dBuV/m)	(dB)	(dBuV/m)	(dBuV/m)	(dB)	
Low channel							
V	4804.00	69.76	-19.99	49.77	74.00	-24.23	PK
V	4804.00	61.39	-19.99	41.40	54.00	-12.60	AV
V	7206.00	59.33	-14.22	45.11	74.00	-28.89	PK
V	7206.00	50.21	-14.22	35.99	54.00	-18.01	AV
H	4804.00	66.12	-19.99	46.13	74.00	-27.87	PK
H	4804.00	55.61	-19.99	35.62	54.00	-18.38	AV
H	7206.00	57.31	-14.22	43.09	74.00	-30.91	PK
H	7206.00	48.72	-14.22	34.50	54.00	-19.50	AV
Middle channel							
V	4880.00	68.51	-19.84	48.67	74.00	-25.33	PK
V	4880.00	62.26	-19.84	42.42	54.00	-11.58	AV
V	7320.00	59.88	-13.90	45.98	74.00	-28.02	PK
V	7320.00	49.94	-13.90	36.04	54.00	-17.96	AV
H	4880.00	65.66	-19.84	45.82	74.00	-28.18	PK
H	4880.00	56.28	-19.84	36.44	54.00	-17.56	AV
H	7320.00	57.47	-13.90	43.57	74.00	-30.43	PK
H	7320.00	49.74	-13.90	35.84	54.00	-18.16	AV
High channel							
V	4960.00	69.66	-19.68	49.98	74.00	-24.02	PK
V	4960.00	59.62	-19.68	39.94	54.00	-14.06	AV
V	7440.00	62.81	-13.57	49.24	74.00	-24.76	PK
V	7440.00	53.38	-13.57	39.81	54.00	-14.19	AV
H	4960.00	67.19	-19.68	47.51	74.00	-26.49	PK
H	4960.00	56.73	-19.68	37.05	54.00	-16.95	AV
H	7440.00	60.48	-13.57	46.91	74.00	-27.09	PK
H	7440.00	51.77	-13.57	38.20	54.00	-15.80	AV

Remark:

1. Measurement = Reading Level + Correct Factor,
Correct Factor = Antenna Factor + Cable Loss - Pre-amplifier,
Over= Measurement - Limit
- 2.If peak below the average limit, the average emission was no test.
3. In restricted bands of operation, The spurious emissions below the permissible value more than 20dB
4. The amplitude of spurious emissions which are attenuated by more than 20dB below the permissible value has no need to be reported.
- 5.This report only shows the worst case test data.

8. Radiated Band Emission Measurement And Restricted Bands Of Operation

8.1 Block Diagram Of Test Setup

Radiated Emission Test-Up Frequency Above 1GHz

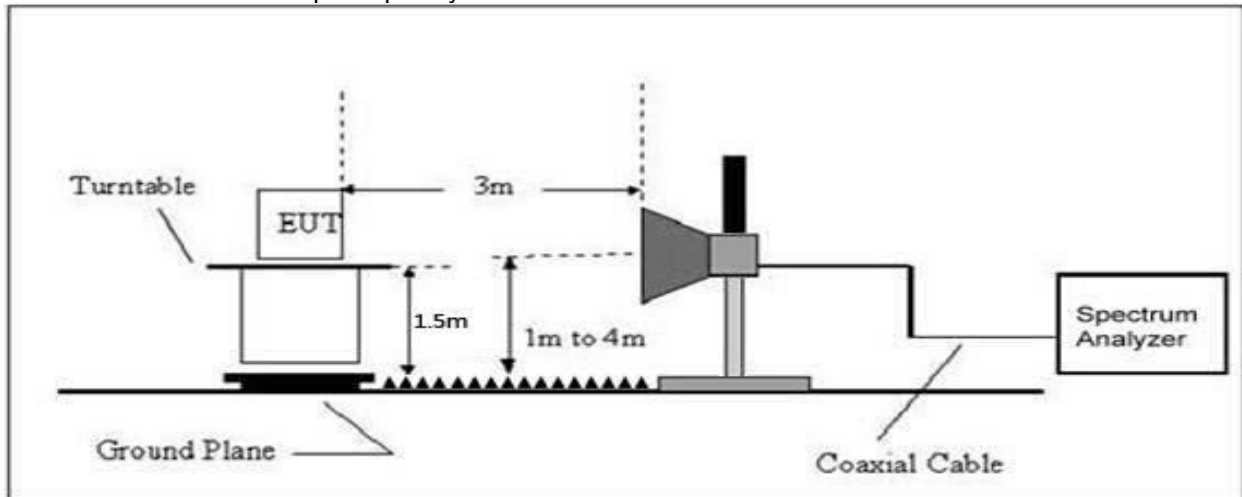

8.2 Limit

RSS-GEN, RSS-247

Table 7 – Restricted frequency bands*

MHz	MHz	GHz
0.090 - 0.110	149.9 - 150.05	9.0 - 9.2
0.495 - 0.505	156.52475 - 156.52525	9.3 - 9.5
2.1735 - 2.1905	156.7 - 156.9	10.6 - 12.7
3.020 - 3.026	162.0125 - 167.17	13.25 - 13.4
4.125 - 4.128	167.72 - 173.2	14.47 - 14.5
4.17725 - 4.17775	240 - 285	15.35 - 16.2
4.20725 - 4.20775	322 - 335.4	17.7 - 21.4
5.677 - 5.683	399.9 - 410	22.01 - 23.12
6.215 - 6.218	608 - 614	23.6 - 24.0
6.26775 - 6.26825	960 - 1427	31.2 - 31.8
6.31175 - 6.31225	1435 - 1626.5	36.43 - 36.5
8.291 - 8.294	1645.5 - 1646.5	Above 38.6
8.362 - 8.366	1660 - 1710	
8.37625 - 8.38675	1718.8 - 1722.2	
8.41425 - 8.41475	2200 - 2300	
12.29 - 12.293	2310 - 2390	
12.51975 - 12.52025	2483.5 - 2500	
12.57675 - 12.57725	2655 - 2900	
13.36 - 13.41	3260 - 3267	
16.42 - 16.423	3332 - 3339	
16.69475 - 16.69525	3345.8 - 3358	
16.80425 - 16.80475	3500 - 4400	
25.5 - 25.67	4500 - 5150	
37.5 - 38.25	5350 - 5460	
73 - 74.6	7250 - 7750	
74.8 - 75.2	8025 - 8500	
108 - 138	--	

* Certain frequency bands listed in table 7 and in bands above 38.6 GHz are designated for licence-exempt applications. These frequency bands and the requirements that apply to related devices are set out in the 200 and 300 series of RSSs.

LIMITS OF RADIATED EMISSION MEASUREMENT (Above 1000MHz)

FREQUENCY (MHz)	Limit (dBuV/m) (at 3M)	
	PEAK	AVERAGE
Above 1000	74	54

Notes:

- (1)The limit for radiated test was performed according to FCC PART 15C.
- (2)The tighter limit applies at the band edges.
- (3)Emission level (dBuV/m)=20log Emission level (uV/m).

8.3 Test Procedure

Receiver Parameter	Setting
Attenuation	Auto
Start Frequency	2300MHz
Stop Frequency	2520
RB / VB (emission in restricted band)	1 MHz / 1 MHz for Peak, 1 MHz / 10Hz for Average

Above 1GHz test procedure as below:

- a.The EUT was placed on the top of a rotating table 1.5 meters above the ground at a 3 meter camber. The table was rotated 360 degrees to determine the position of the highest radiation.
- b.The EUT was set 3 meters away from the interference-receiving antenna, which was mounted on the top of a variable-height antenna tower.
- c.The antenna height is varied from one meter to four meters above the ground to determine the maximum value of the field strength. Both horizontal and vertical polarizations of the antenna are set to make the measurement.
- d.For each suspected emission, the EUT was arranged to its worst case and then the antenna was tuned to heights from 1 meter to 4 meters and the rota table was turned from 0 degrees to 360 degrees to find the maximum reading.
- e.The test-receiver system was set to Peak Detect Function and Specified Bandwidth with Maximum Hold Mode.
- f. If the emission level of the EUT in peak mode was 10dB lower than the limit specified, then testing could be stopped and the peak values of the EUT would be reported. Otherwise the emissions that did not have 10dB margin would be re-tested one by one using peak, quasi-peak or average method as specified and then reported in a data sheet.
- g.Test the EUT in the lowest channel,the Highest channel.

Note:

Both horizontal and vertical antenna polarities were tested and performed pretest to three orthogonal axis. The worst case emissions were reported.

8.4 EUT Operating Conditions

The EUT tested system was configured as the statements of 2.3 Unless otherwise a special operating condition is specified in the follows during the testing.

8.5 Test Result

	Polar (H/V)	Frequency (MHz)	Reading Level (dBuV/m)	Correct Factor (dB)	Measurement (dBuV/m)	Limits (dBuV/m)		Result
					PK	PK	AV	
GFSK 1Mbps	Low Channel 2402MHz							
	H	2390.00	71.40	-25.43	45.97	74.00	54.00	PASS
	H	2400.00	75.00	-25.40	49.60	74.00	54.00	PASS
	V	2390.00	71.35	-25.43	45.92	74.00	54.00	PASS
	V	2400.00	76.32	-25.40	50.92	74.00	54.00	PASS
	High Channel 2480MHz							
	H	2483.50	74.30	-25.15	49.15	74.00	54.00	PASS
	H	2500.00	70.60	-25.10	45.50	74.00	54.00	PASS
	V	2483.50	74.03	-25.15	48.88	74.00	54.00	PASS
	V	2500.00	70.92	-25.10	45.82	74.00	54.00	PASS
GFSK 2Mbps	Low Channel 2402MHz							
	H	2390.00	71.81	-25.43	46.38	74.00	54.00	PASS
	H	2400.00	76.07	-25.40	50.67	74.00	54.00	PASS
	V	2390.00	72.70	-25.43	47.27	74.00	54.00	PASS
	V	2400.00	75.84	-25.40	50.44	74.00	54.00	PASS
	High Channel 2480MHz							
	H	2390.00	76.24	-25.15	51.09	74.00	54.00	PASS
	H	2400.00	69.75	-25.10	44.65	74.00	54.00	PASS
	V	2390.00	75.13	-25.15	49.98	74.00	54.00	PASS
	V	2400.00	70.29	-25.10	45.19	74.00	54.00	PASS
Remark:								
1. Measurement = Reading Level + Correct Factor, Correct Factor = Antenna Factor + Cable Loss - Pre-amplifier, Over= Measurement - Limit								
2. If the PK measured levels comply with average limit, then the average level were deemed to comply with average limit.								
3 In restricted bands of operation, The spurious emissions below the permissible value more than 20dB								
4. The amplitude of spurious emissions which are attenuated by more than 20dB below the permissible value has no need to be reported.								

9. Power Spectral Density Test

9.1 Block Diagram Of Test Setup



9.2 Limit

RSS-247 5.2				
Section	Test Item	Limit	Frequency Range (MHz)	Result
RSS-247 5.2	Power Spectral Density	8 dBm (in any 3KHz)	2400-2483.5	PASS

LIMITS OF RADIATED EMISSION MEASUREMENT (Above 1000MHz)

9.3 Test Procedure

1. Set analyzer center frequency to DTS channel center frequency.
2. Set the span to 1.5 times the DTS bandwidth.
3. Set the RBW to: $3 \text{ kHz} \leq \text{RBW} \leq 100 \text{ kHz}$.
4. Set the VBW $\geq 3 \times \text{RBW}$.
5. Detector = peak.
6. Sweep time = auto couple.
7. Trace mode = max hold.
8. Allow trace to fully stabilize.
9. Use the peak marker function to determine the maximum amplitude level within the RBW.
10. If measured value exceeds limit, reduce RBW (no less than 3 kHz) and repeat.

9.4 EUT Operating Conditions

The EUT tested system was configured as the statements of 4.6 Unless otherwise a special operating condition is specified in the follows during the testing.

Note: Power Spectral Density(dBm)=Reading+Cable Loss

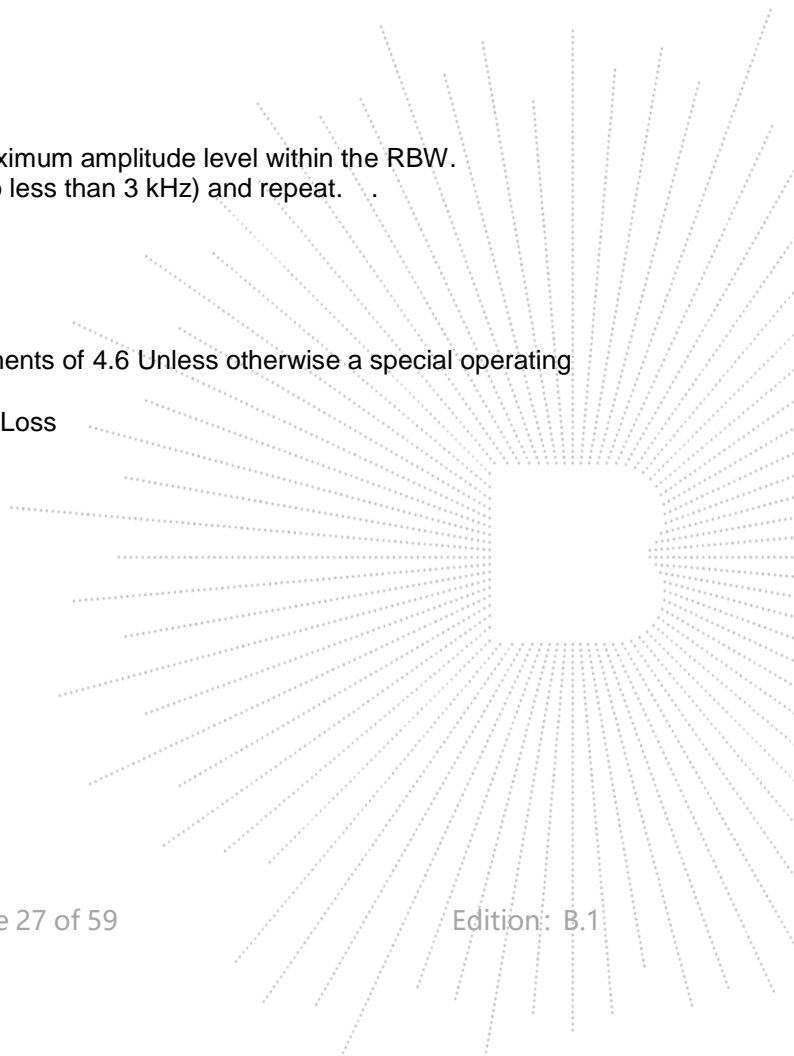

9.5 Test Result

Temperature:	26°C	Relative Humidity:	54%
Test Mode:	GFSK	Test Voltage:	DC 5V

Condition	Mode	Frequency (MHz)	Conducted PSD (dBm)	Limit (dBm)	Verdict
NVNT	BLE 1M	2402	-16.79	8	Pass
NVNT	BLE 1M	2440	-16.26	8	Pass
NVNT	BLE 1M	2480	-17.52	8	Pass
NVNT	BLE 2M	2402	-21.45	8	Pass
NVNT	BLE 2M	2440	-20.9	8	Pass
NVNT	BLE 2M	2480	-22.22	8	Pass

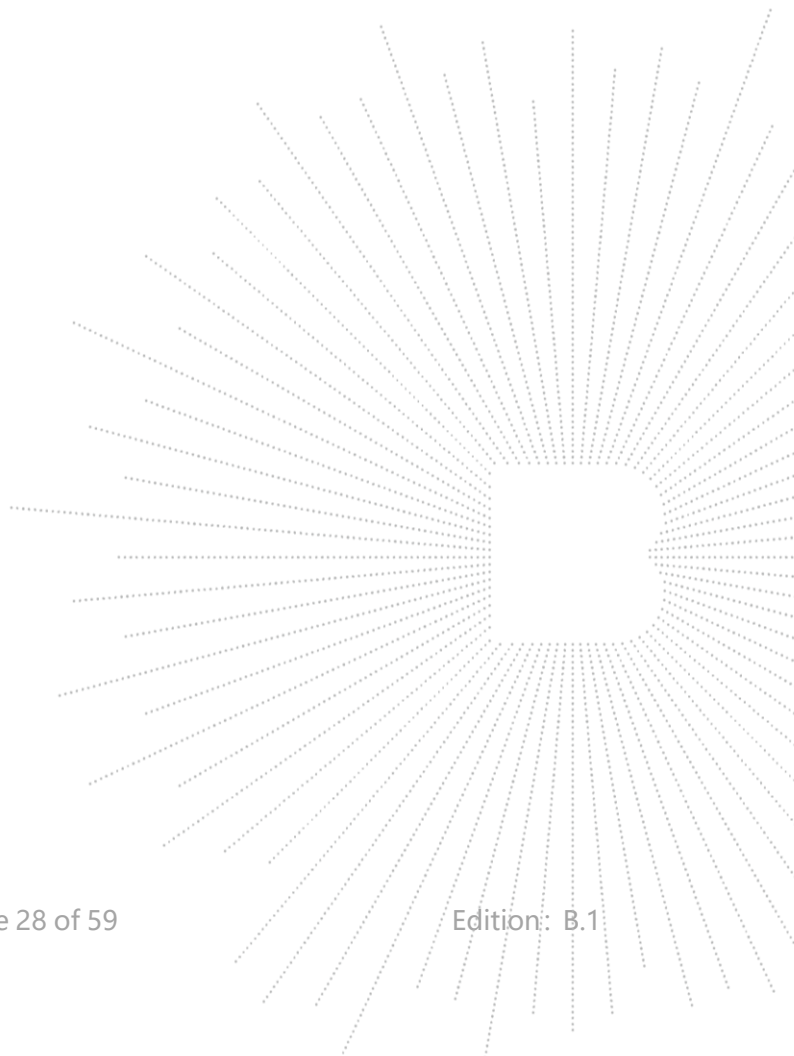

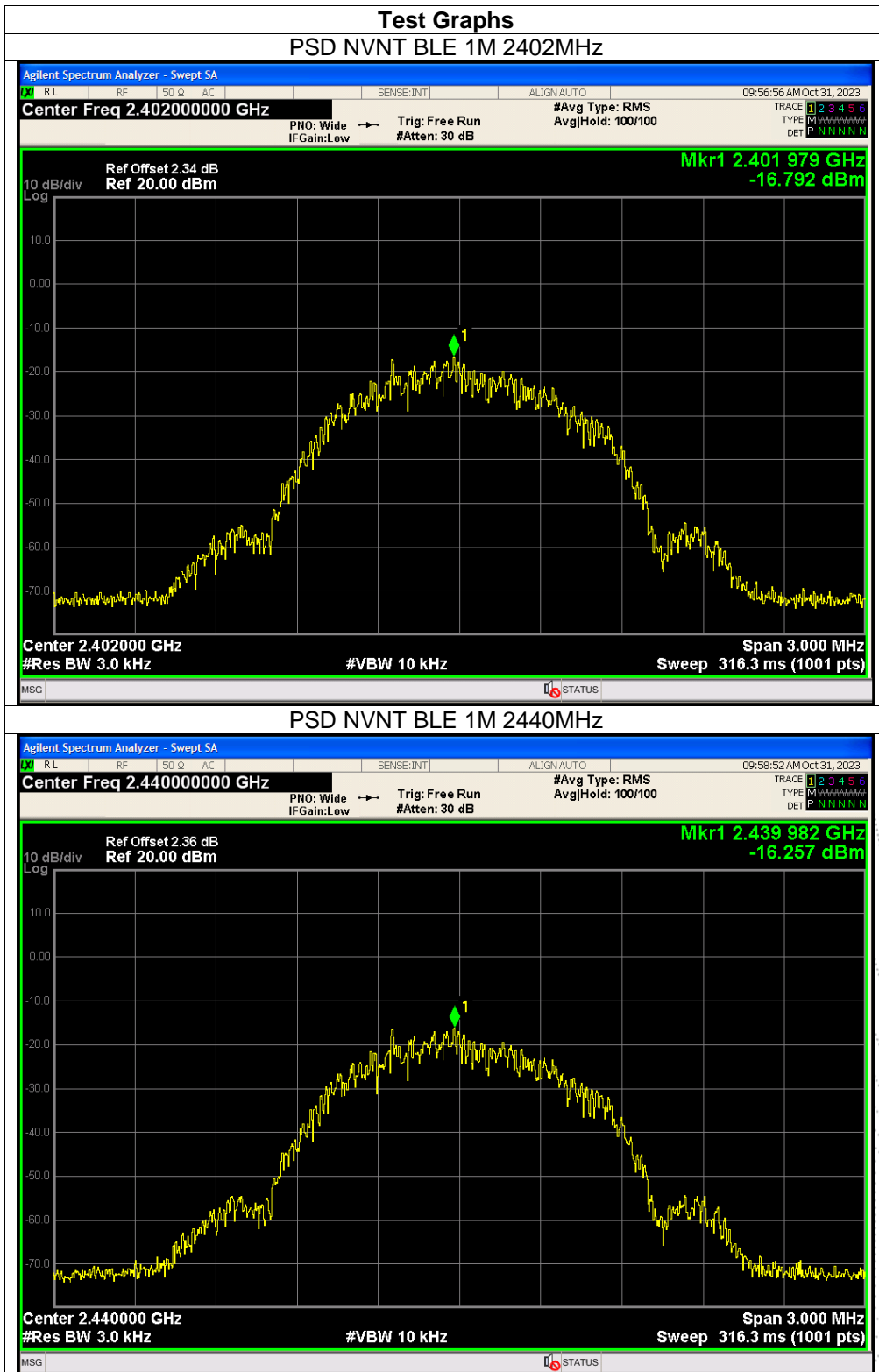

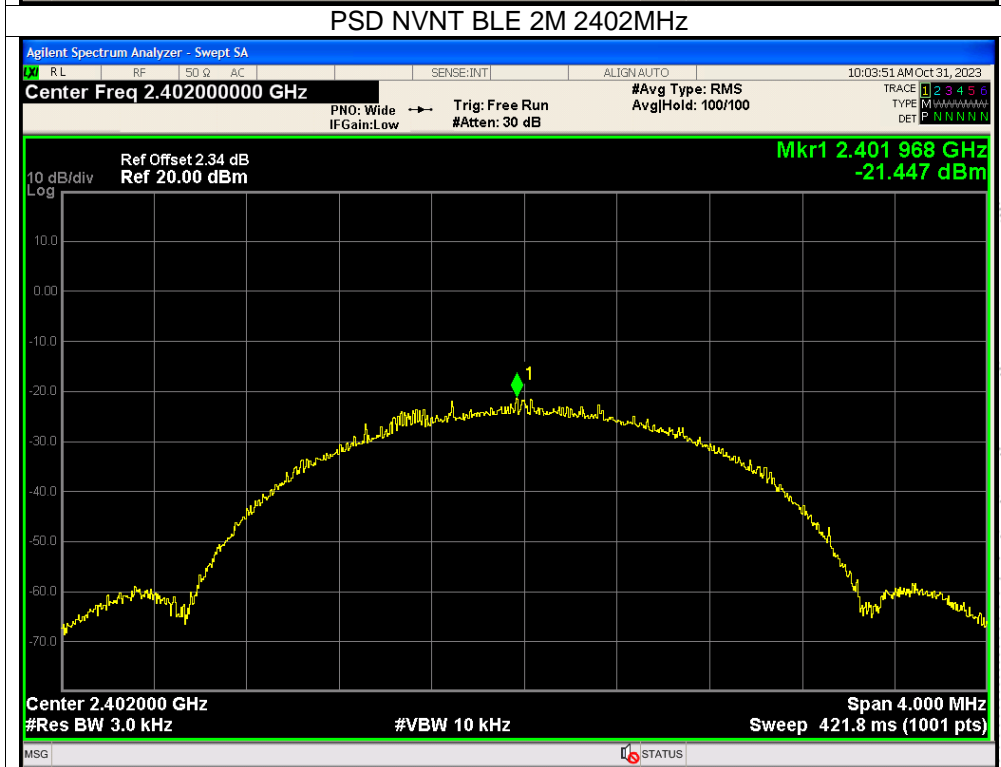
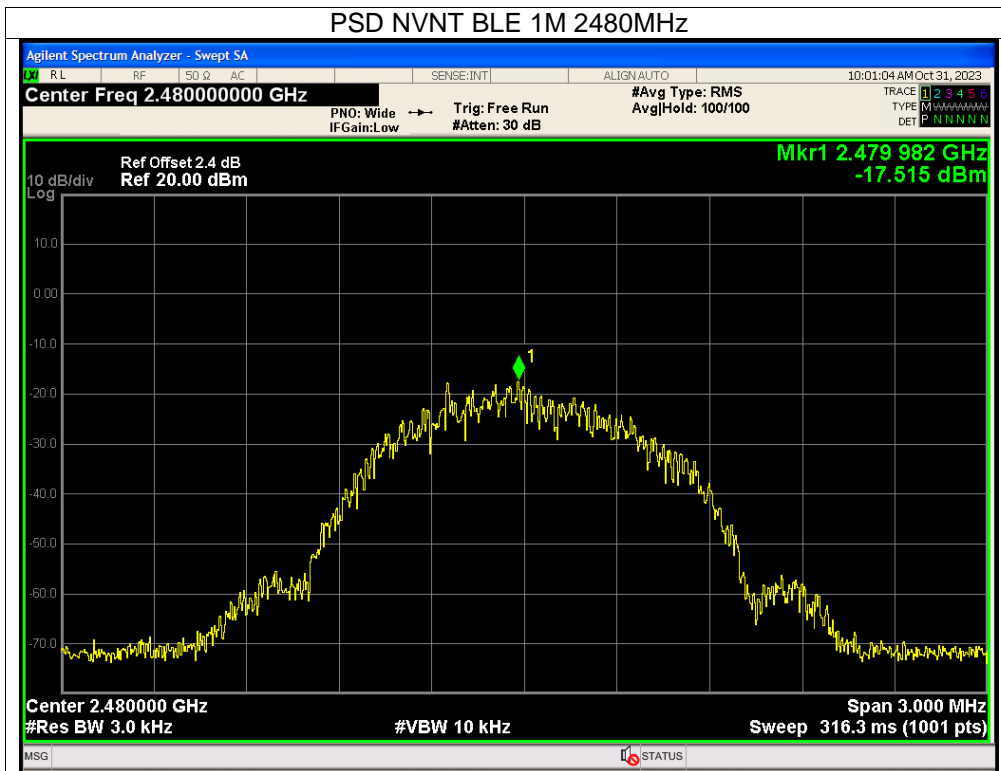

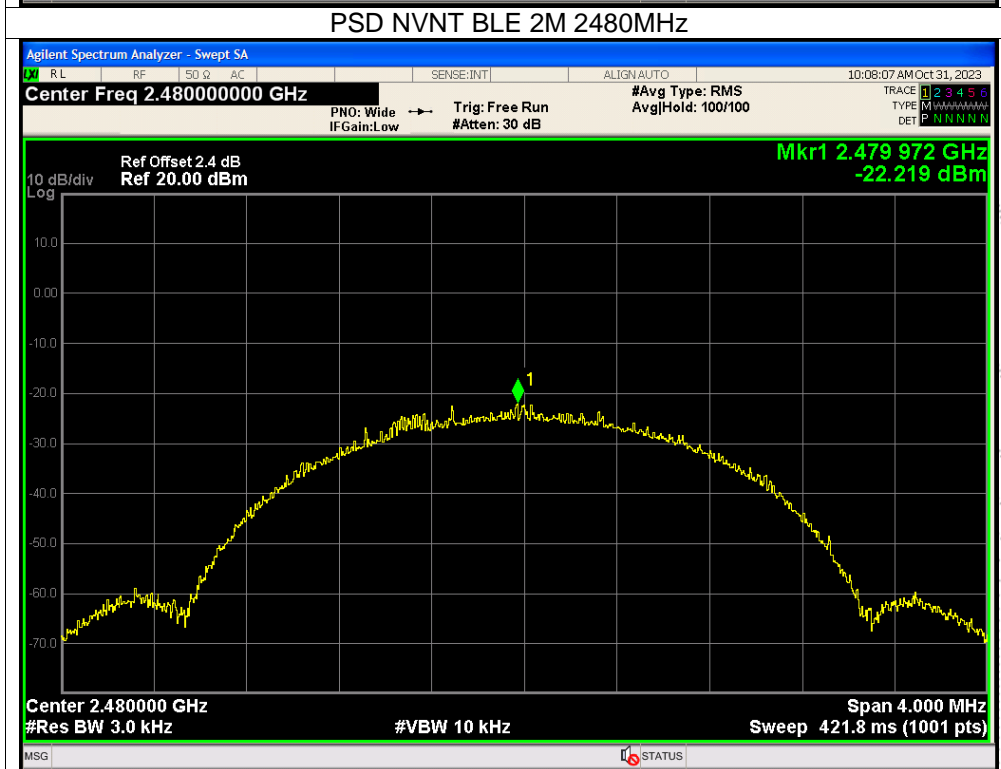
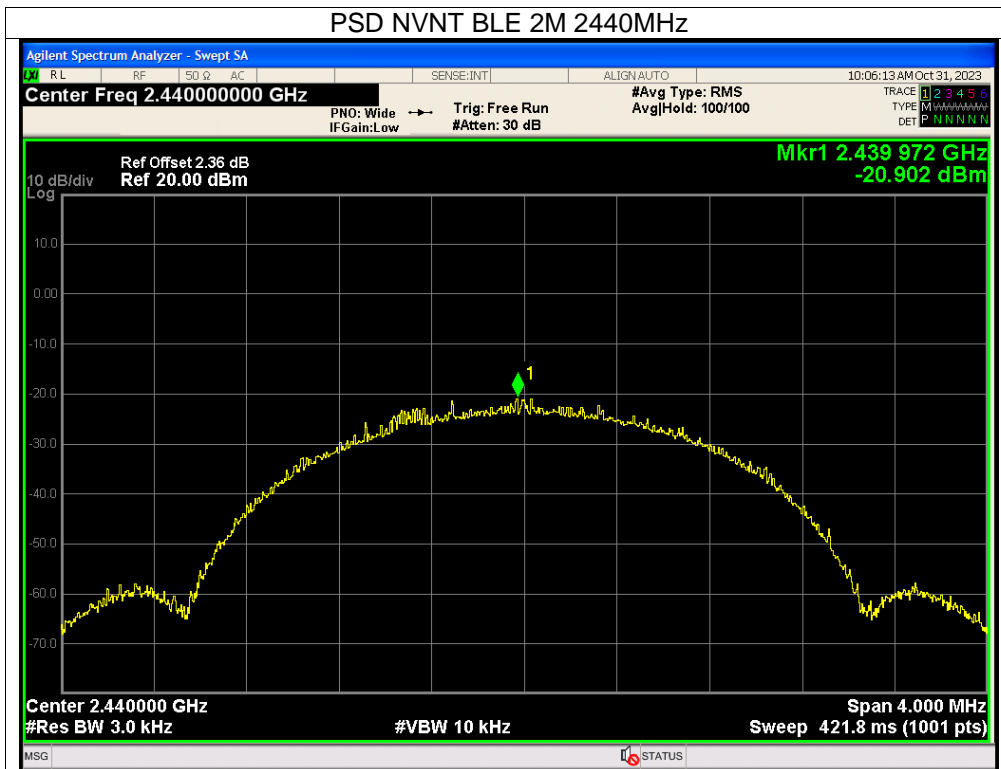

10. Bandwidth Test

10.1 Block Diagram Of Test Setup



10.2 Limit

RSS-247 5.2				
Section	Test Item	Limit	Frequency Range (MHz)	Result
RSS-247 5.2	Bandwidth	$\geq 500\text{KHz}$ (6dB bandwidth)	2400-2483.5	PASS

10.3 Test Procedure

1. Set RBW = 30 kHz.
2. Set the video bandwidth (VBW) $\geq 3 \times$ RBW.
3. Detector = Peak.
4. Trace mode = max hold.
5. Sweep = auto couple.
6. Allow the trace to stabilize.
7. Measure the maximum width of the emission that is constrained by the frequencies associated with the two outermost amplitude points (upper and lower frequencies) that are attenuated by 6 dB relative to the maximum level measured in the fundamental emission.

10.4 EUT Operating Conditions

The EUT tested system was configured as the statements of 2.4 Unless otherwise a special operating condition is specified in the follows during the testing.

10.5 Test Result

Temperature:	26°C	Relative Humidity:	54%
Test Mode:	GFSK	Test Voltage:	DC 5V

Condition	Mode	Frequency (MHz)	-6 dB Bandwidth (MHz)	99% OBW	Limit -6 dB Bandwidth (MHz)	Verdict
NVNT	BLE 1M	2402	0.647	1.013	0.5	Pass
NVNT	BLE 1M	2440	0.657	1.018	0.5	Pass
NVNT	BLE 1M	2480	0.686	1.03	0.5	Pass
NVNT	BLE 2M	2402	1.146	2.029	0.5	Pass
NVNT	BLE 2M	2440	1.138	2.034	0.5	Pass
NVNT	BLE 2M	2480	1.12	2.043	0.5	Pass

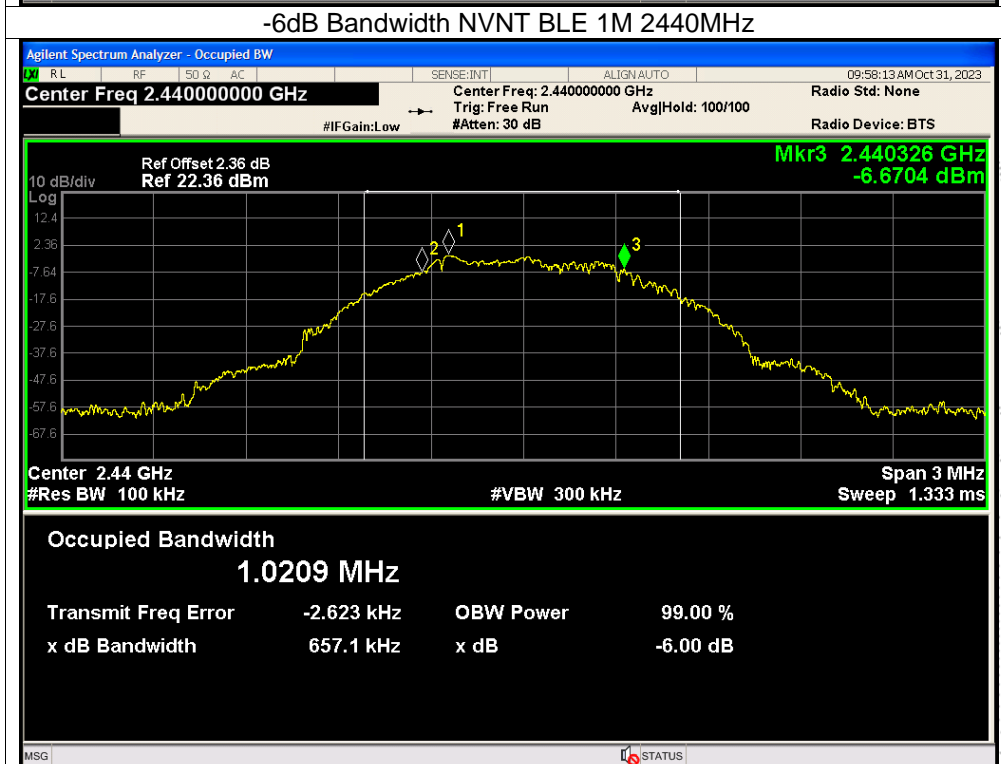
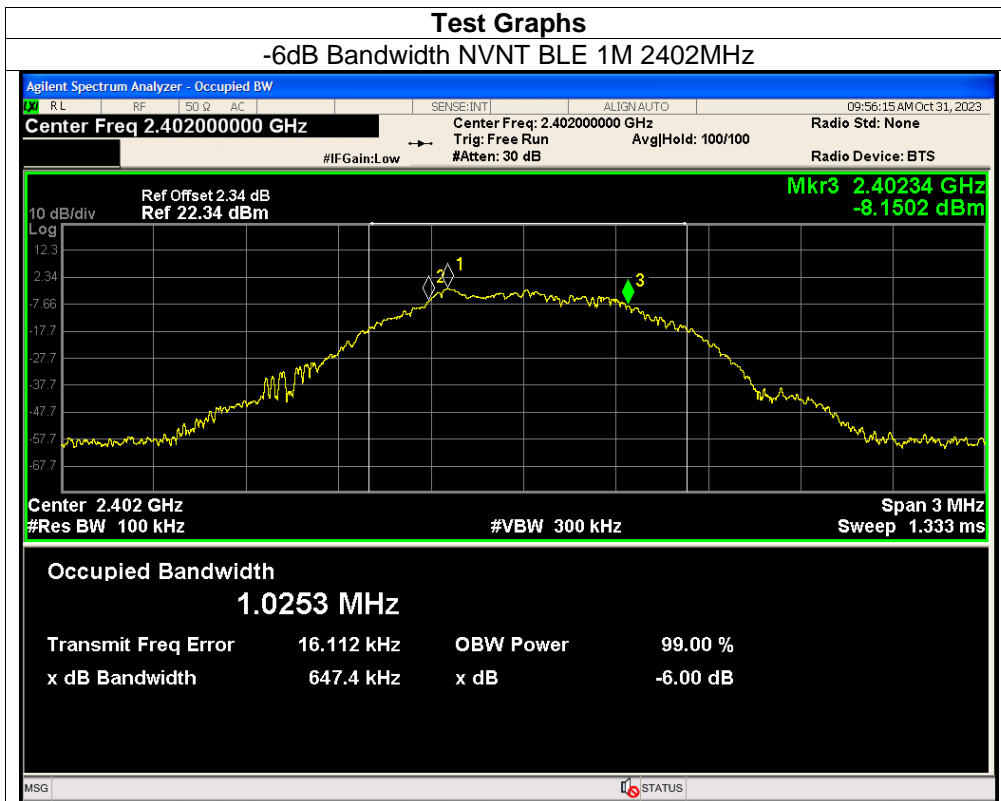

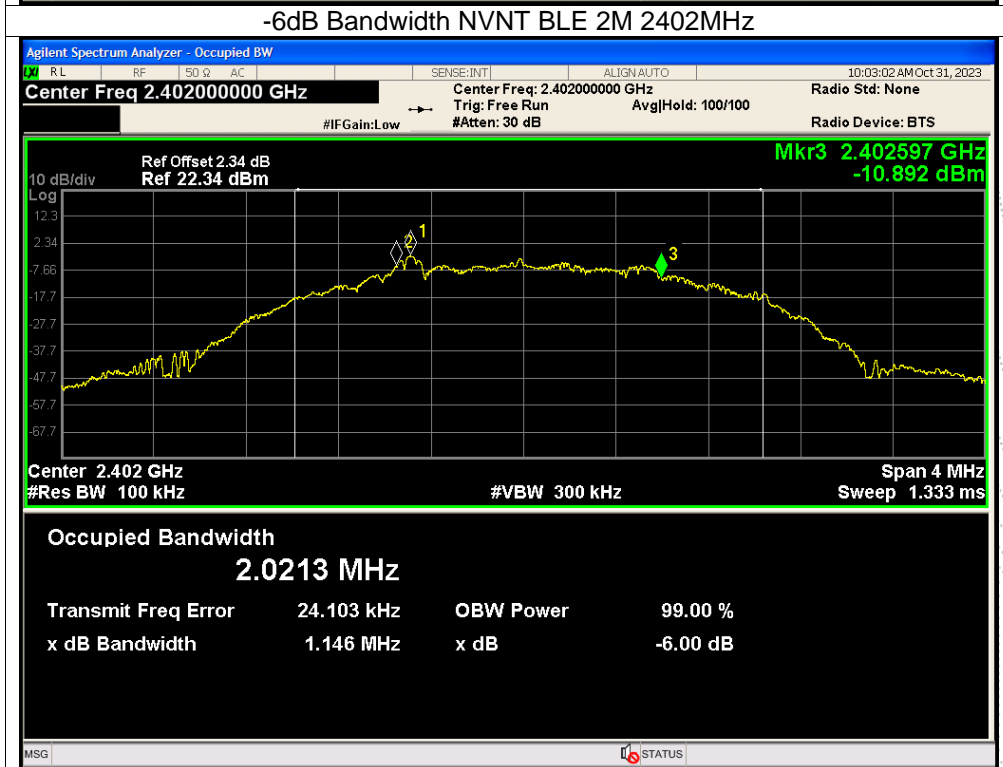
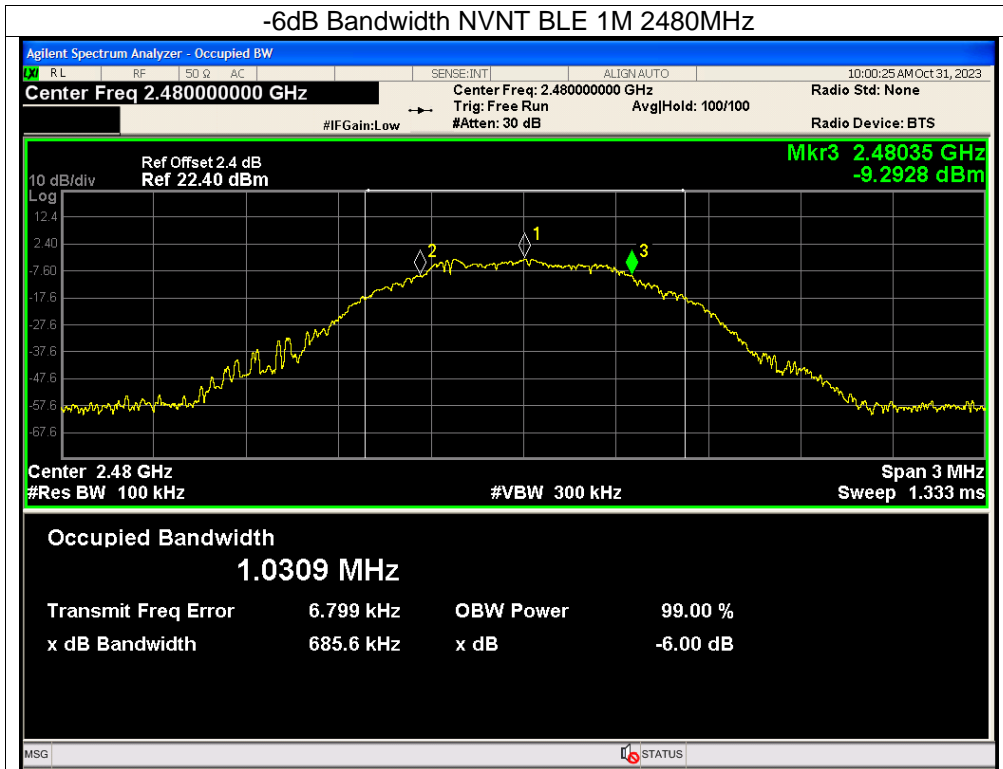

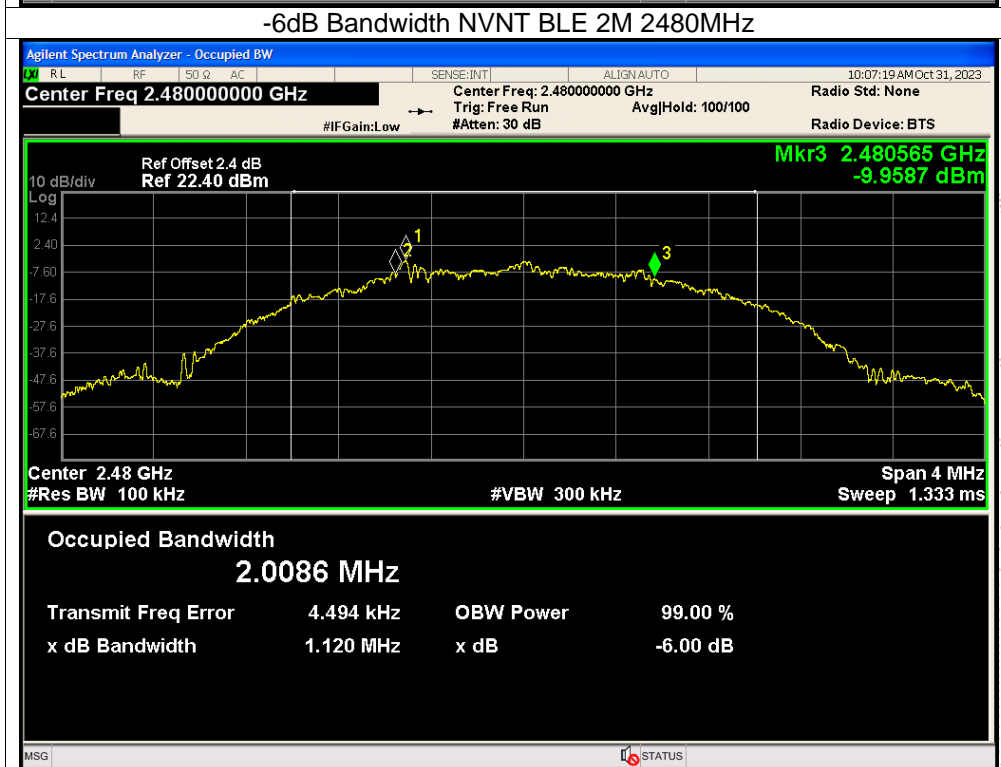
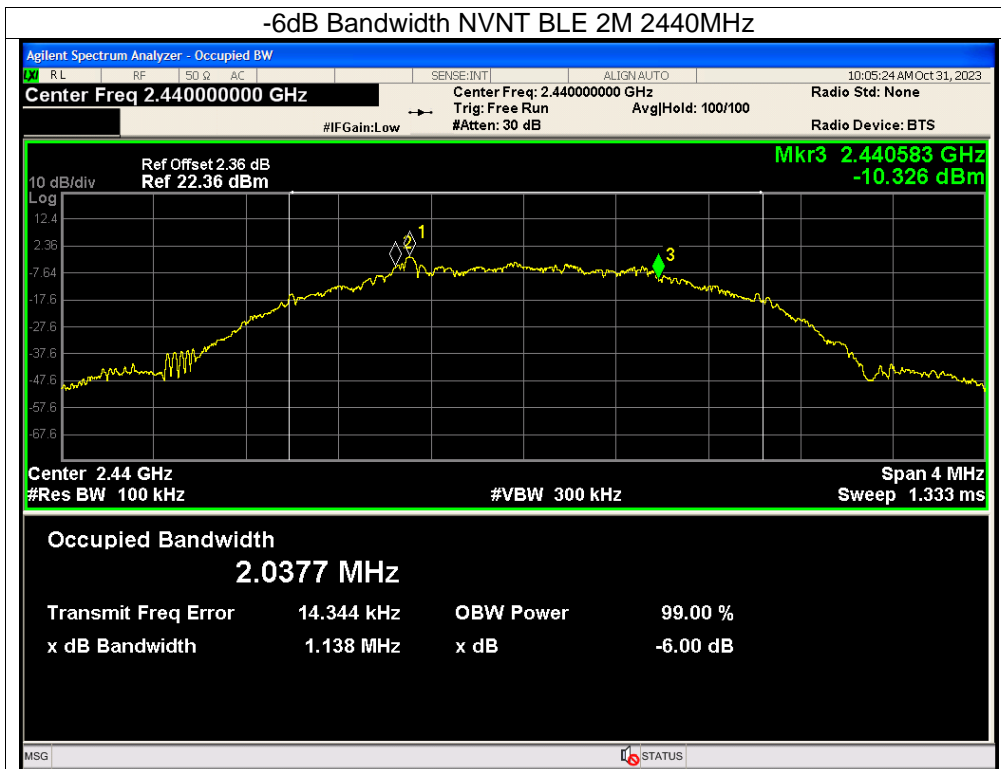

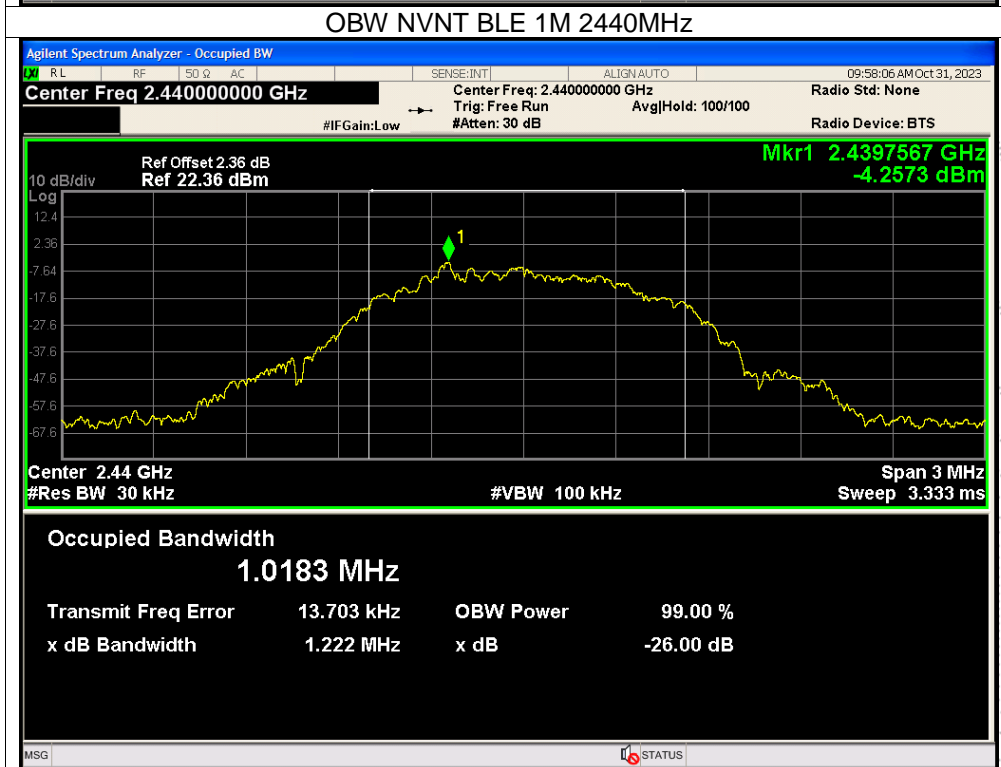
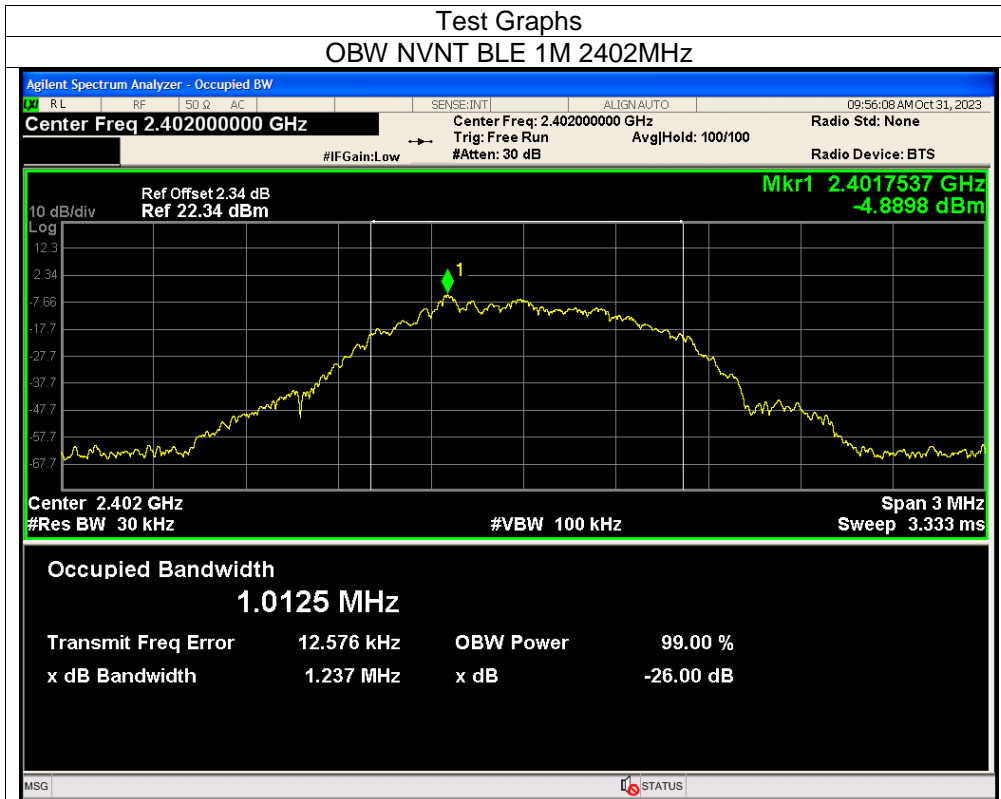

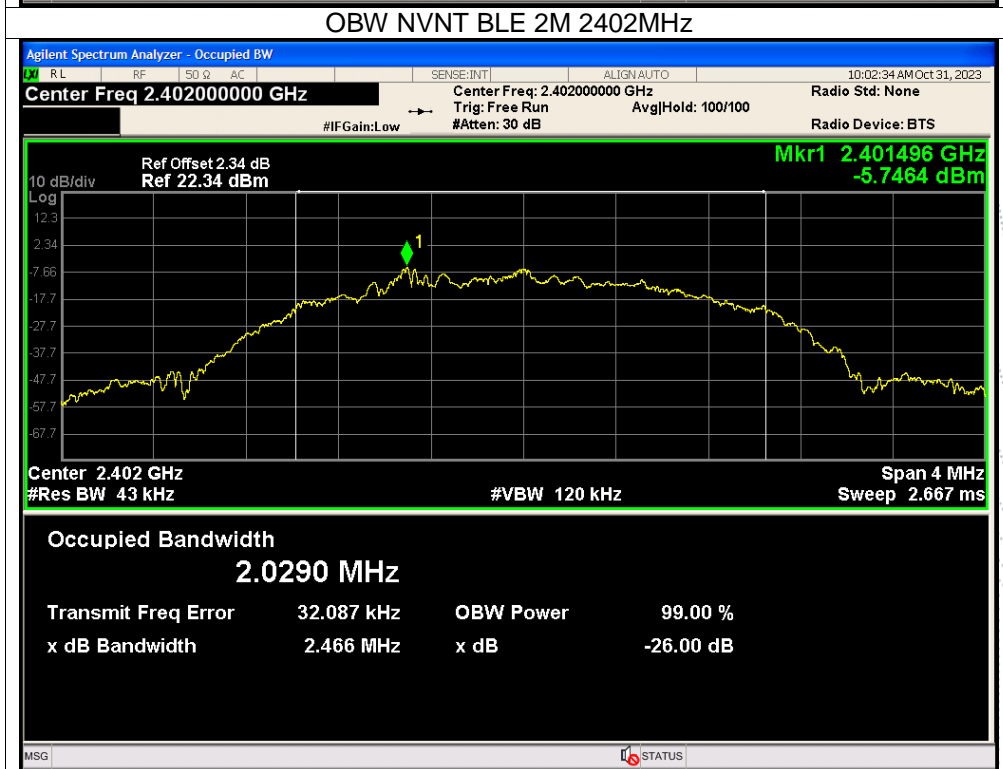
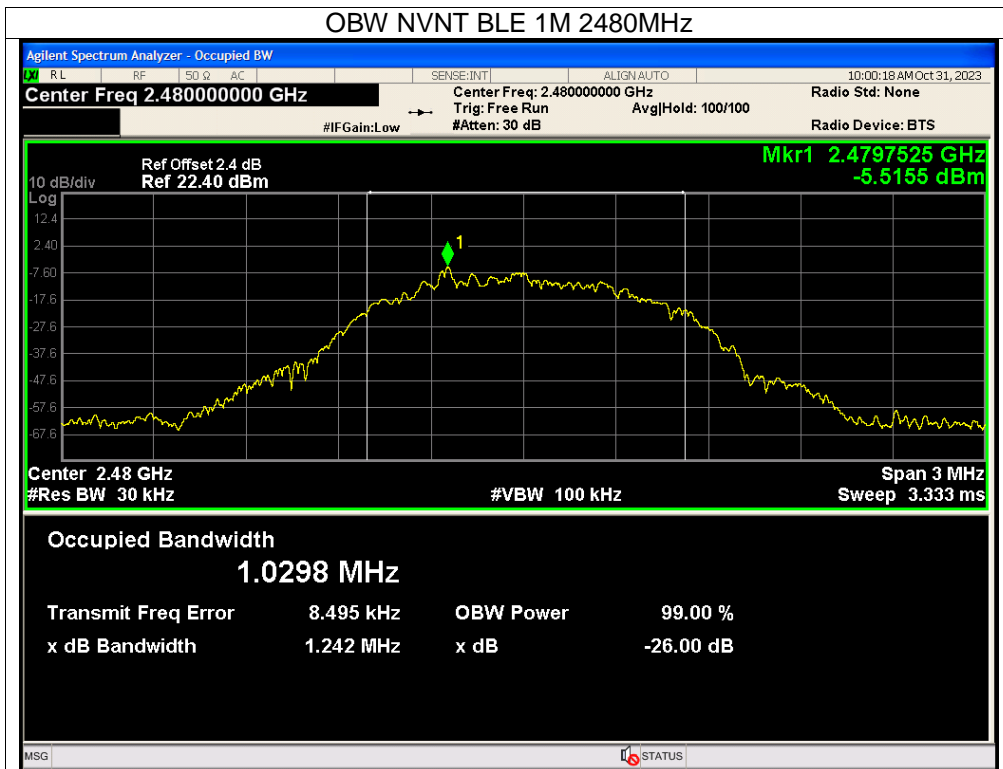

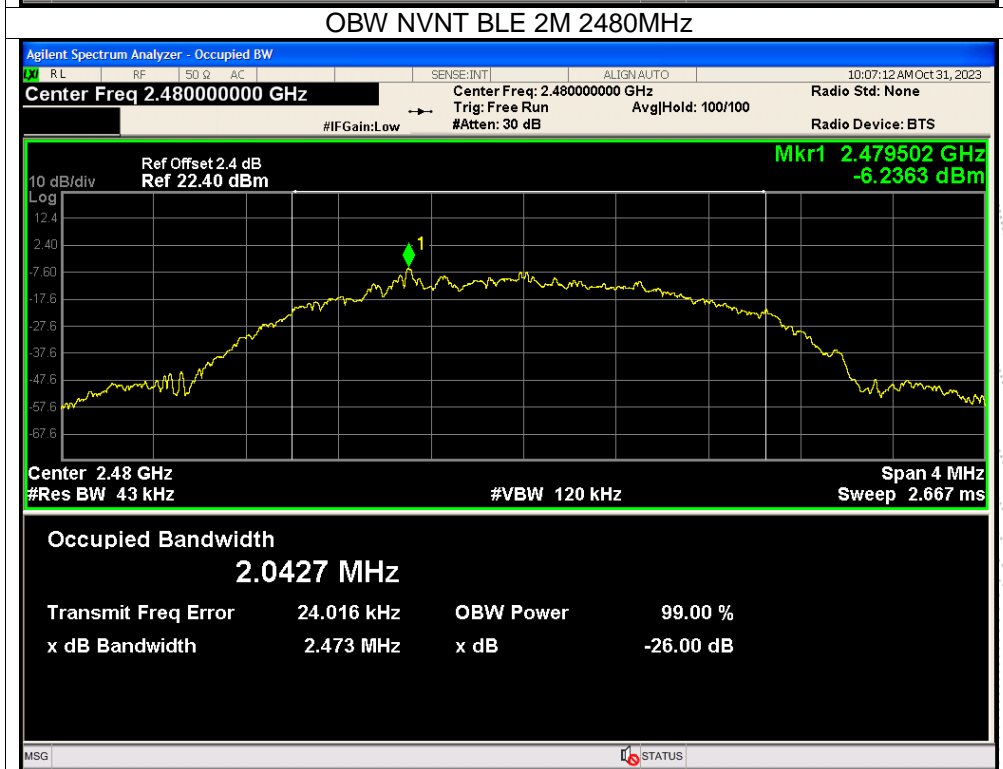
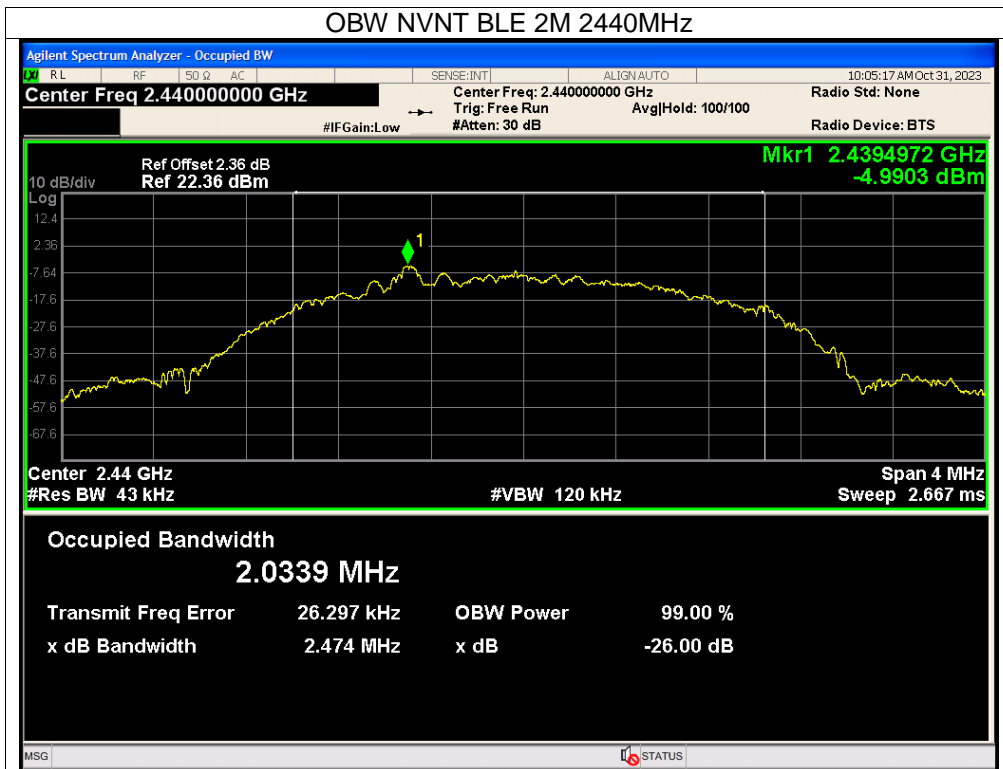

11. Peak Output Power Test

11.1 Block Diagram Of Test Setup

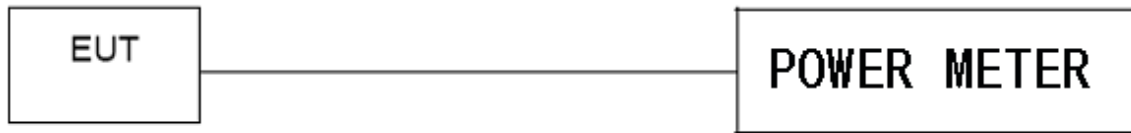

11.2 Limit

RSS-247 5.4 (b)				
Section	Test Item	Limit	Frequency Range (MHz)	Result
RSS-247 5.4 (b)	Peak Output Power	1 watt or 30dBm	2400-2483.5	PASS

11.3 Test Procedure

- a. The EUT was directly connected to the Power meter

11.4 EUT Operating Conditions

The EUT tested system was configured as the statements of 2.4 Unless otherwise a special operating condition is specified in the follows during the testing.

11.5 Test Result

Temperature:	26°C	Relative Humidity:	54%
Test Mode:	GFSK	Test Voltage:	DC 5V

Condition	Mode	Frequency (MHz)	Conducted Power (dBm)	Limit (dBm)	EIRP (dBm)	EIRP LIMIT (dBm)	Verdict
NVNT	BLE 1M	2402	-1.43	30	-0.16	36	Pass
NVNT	BLE 1M	2440	-0.92	30	0.35	36	Pass
NVNT	BLE 1M	2480	-2.22	30	-0.95	36	Pass
NVNT	BLE 2M	2402	-1.61	30	-0.34	36	Pass
NVNT	BLE 2M	2440	-1.14	30	0.13	36	Pass
NVNT	BLE 2M	2480	-2.5	30	-1.23	36	Pass

Note: 1. EIRP= Output Power+Antenna Gain.
2. Antenna Gain=1.27 dBi.

12. 100 KHz Bandwidth Of Frequency Band Edge

12.1 Block Diagram Of Test Setup



12.2 Limit

In any 100 kHz bandwidth outside the frequency band in which the spread spectrum or digitally modulated device is operating, the RF power that is produced shall be at least 20 dB below that in the 100 kHz bandwidth within the band that contains the highest level of the desired power, based on either an RF conducted or a radiated measurement, provided that the transmitter demonstrates compliance with the peak conducted power limits. If the transmitter complies with the conducted power limits based on the use of root-mean-square averaging over a time interval, as permitted under section RSS-247 5.4(d), the attenuation required shall be 30 dB instead of 20 dB. Attenuation below the general field strength limits specified in RSS-Gen is not required.

12.3 Test Procedure

Using the following spectrum analyzer setting:

- Set the RBW = 100KHz.
- Set the VBW = 300KHz.
- Sweep time = auto couple.
- Detector function = peak.
- Trace mode = max hold.
- Allow trace to fully stabilize..

12.4 EUT Operating Conditions

The EUT tested system was configured as the statements of 2.4 Unless otherwise a special operating condition is specified in the follows during the testing.

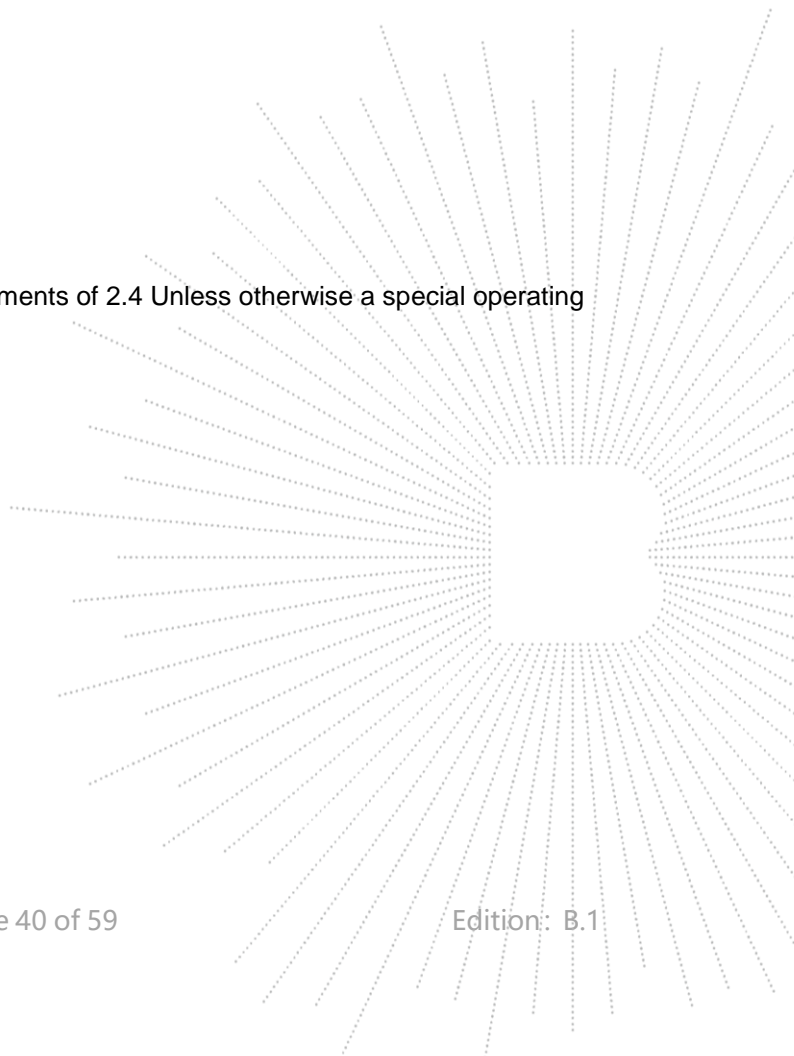

12.5 Test Result

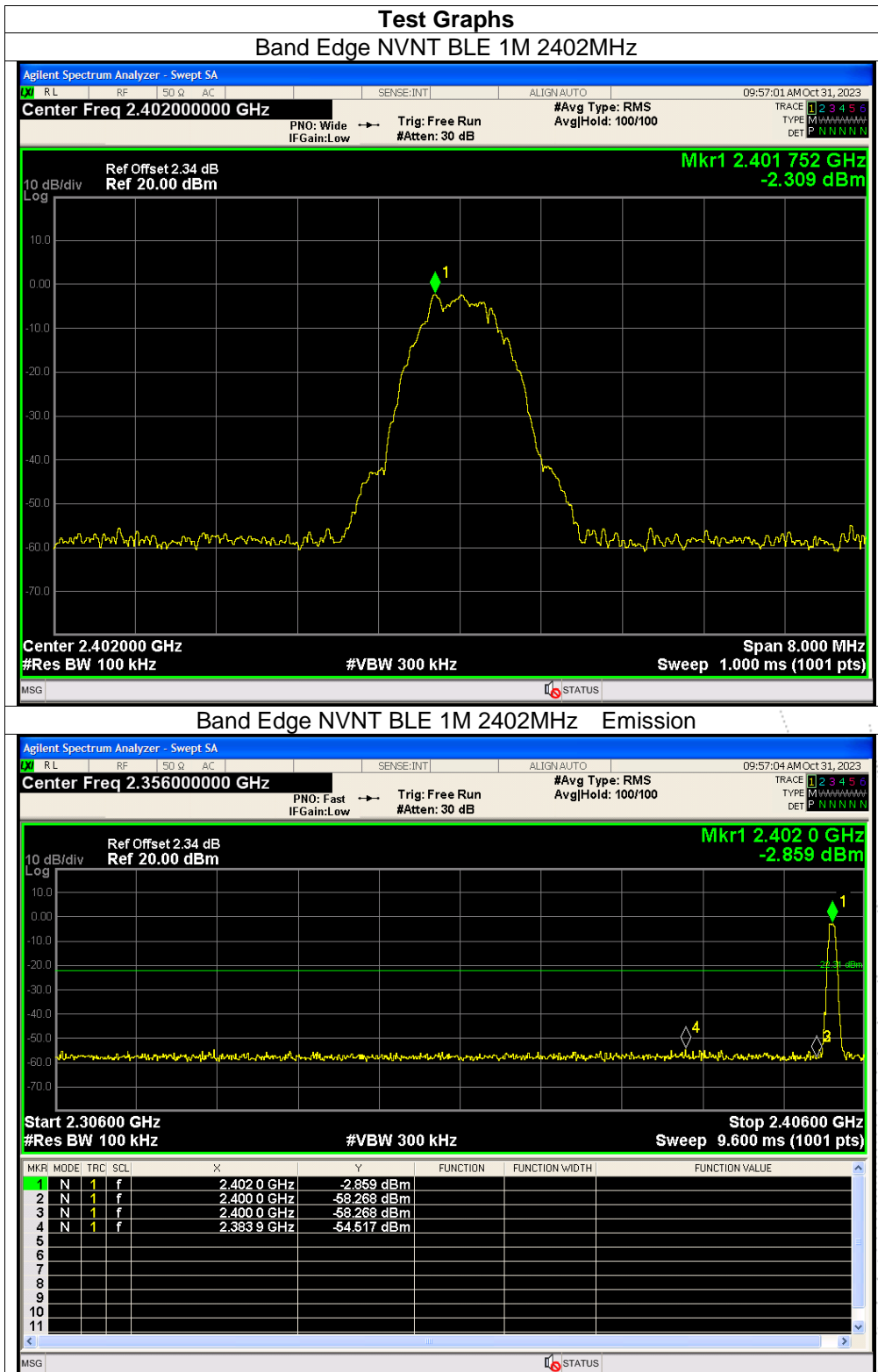

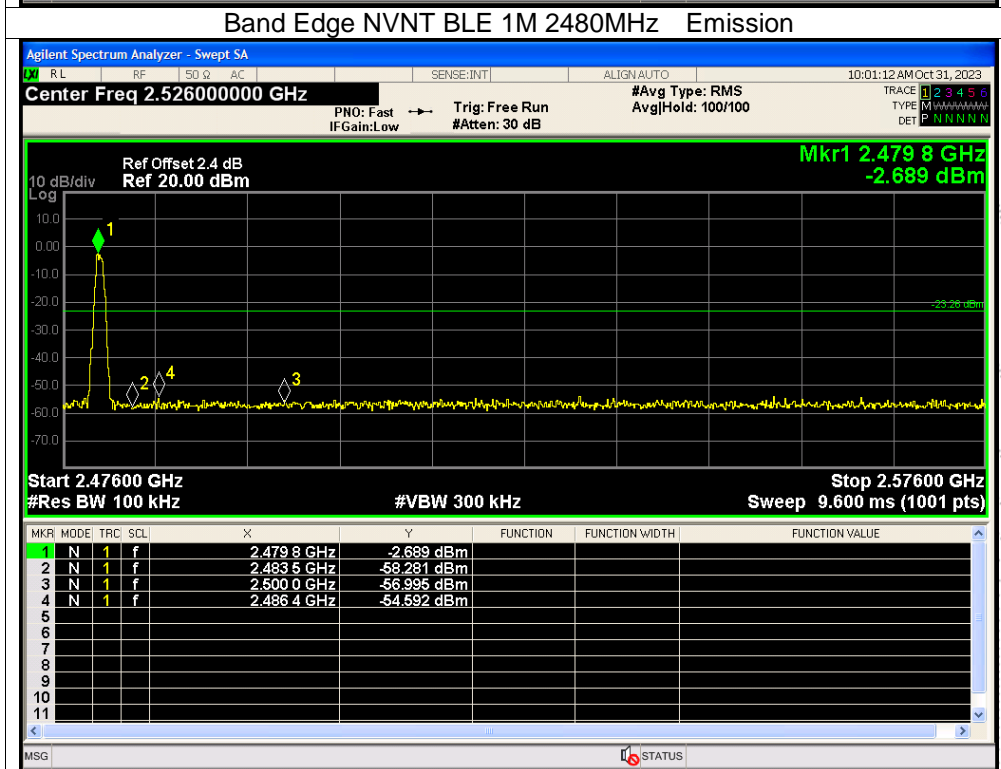
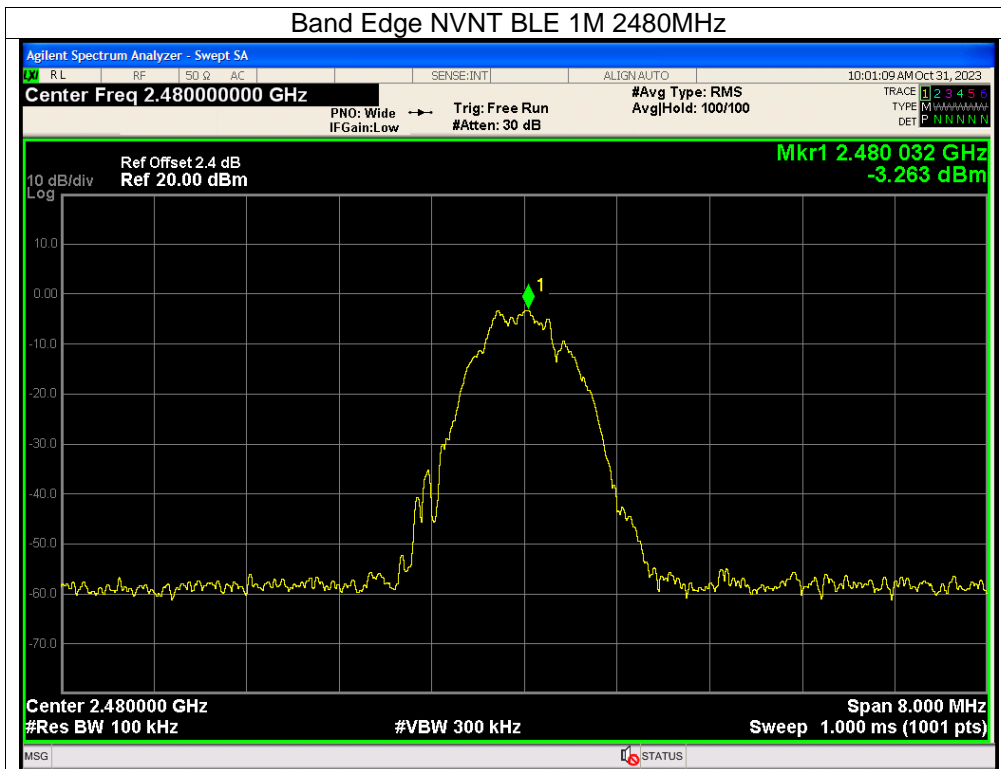

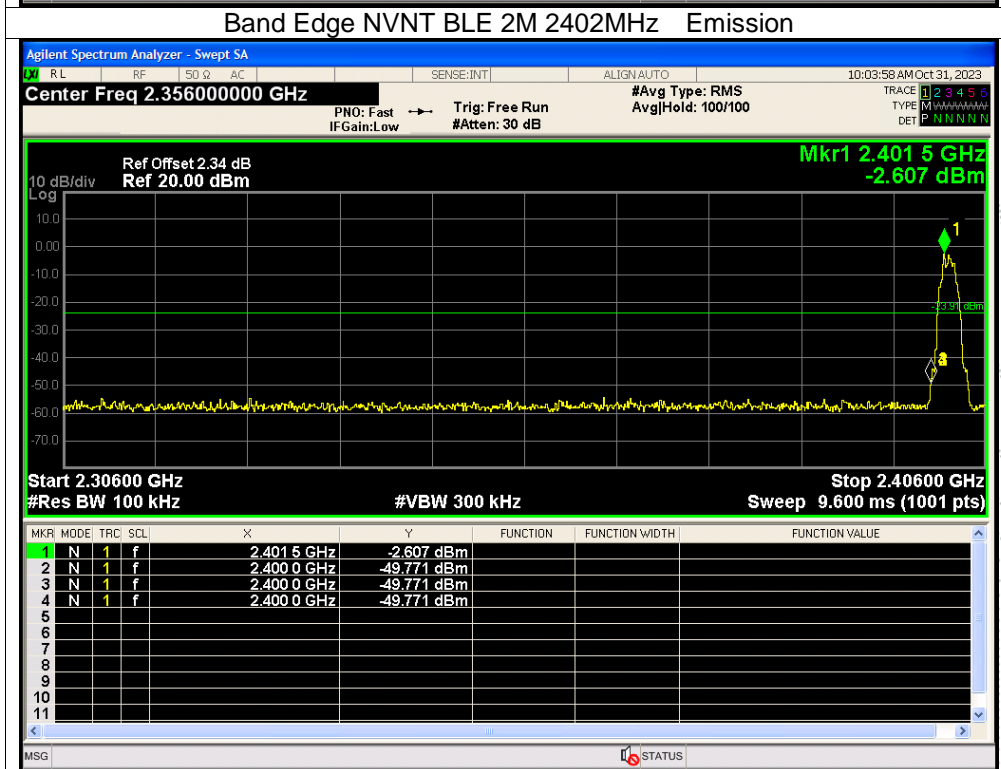
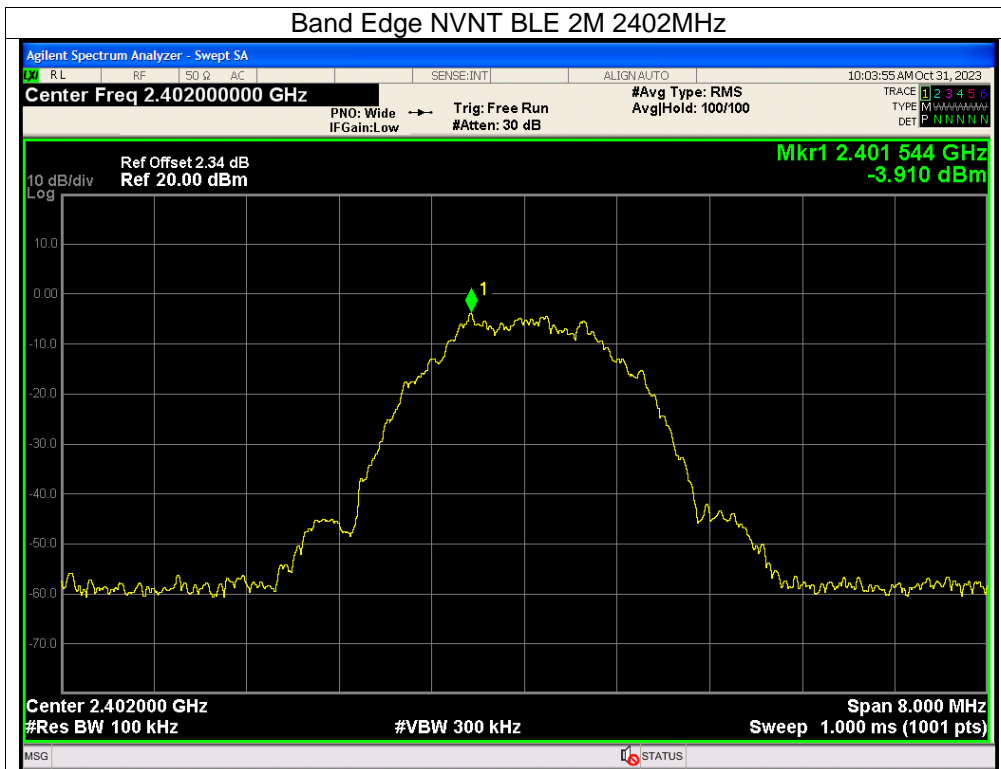

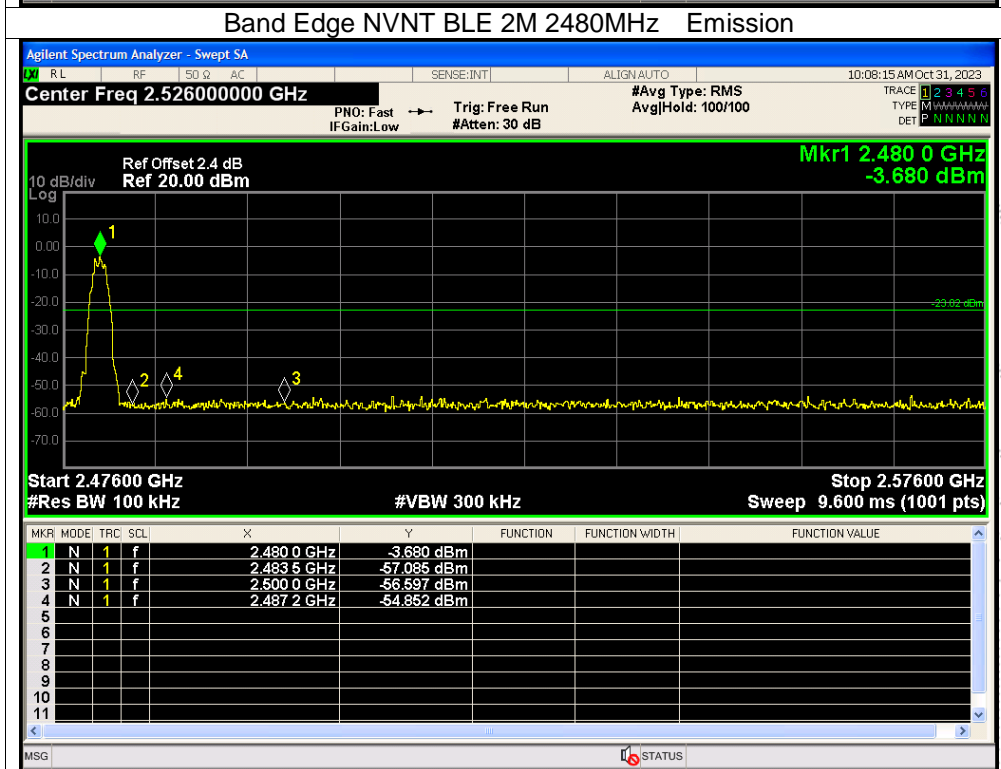
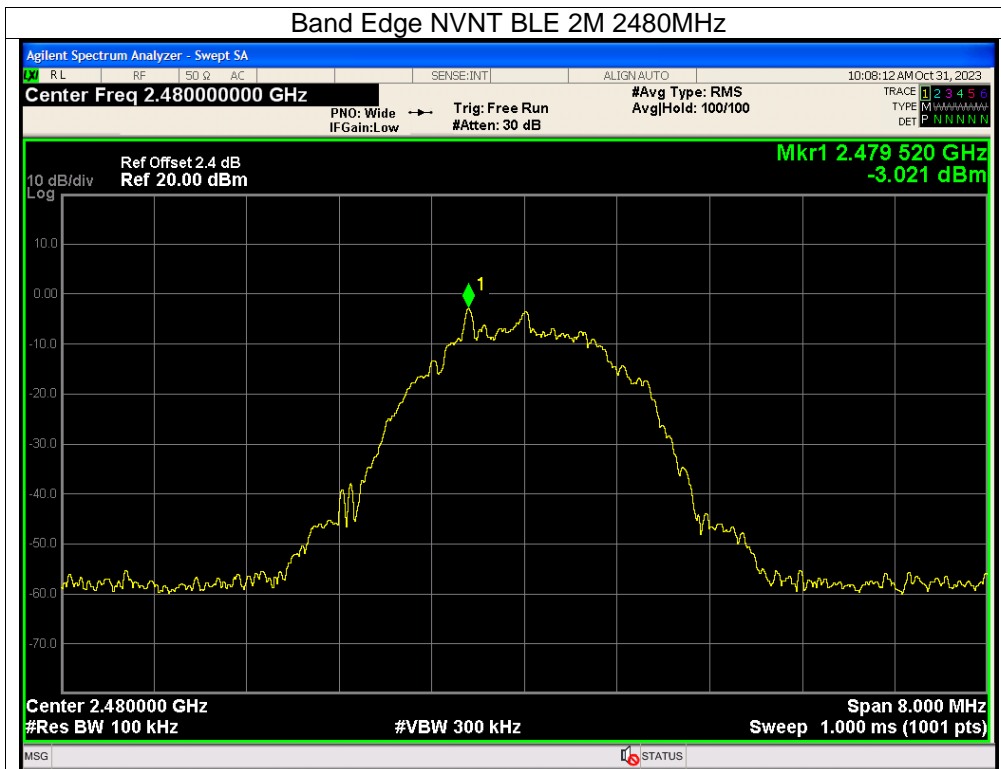

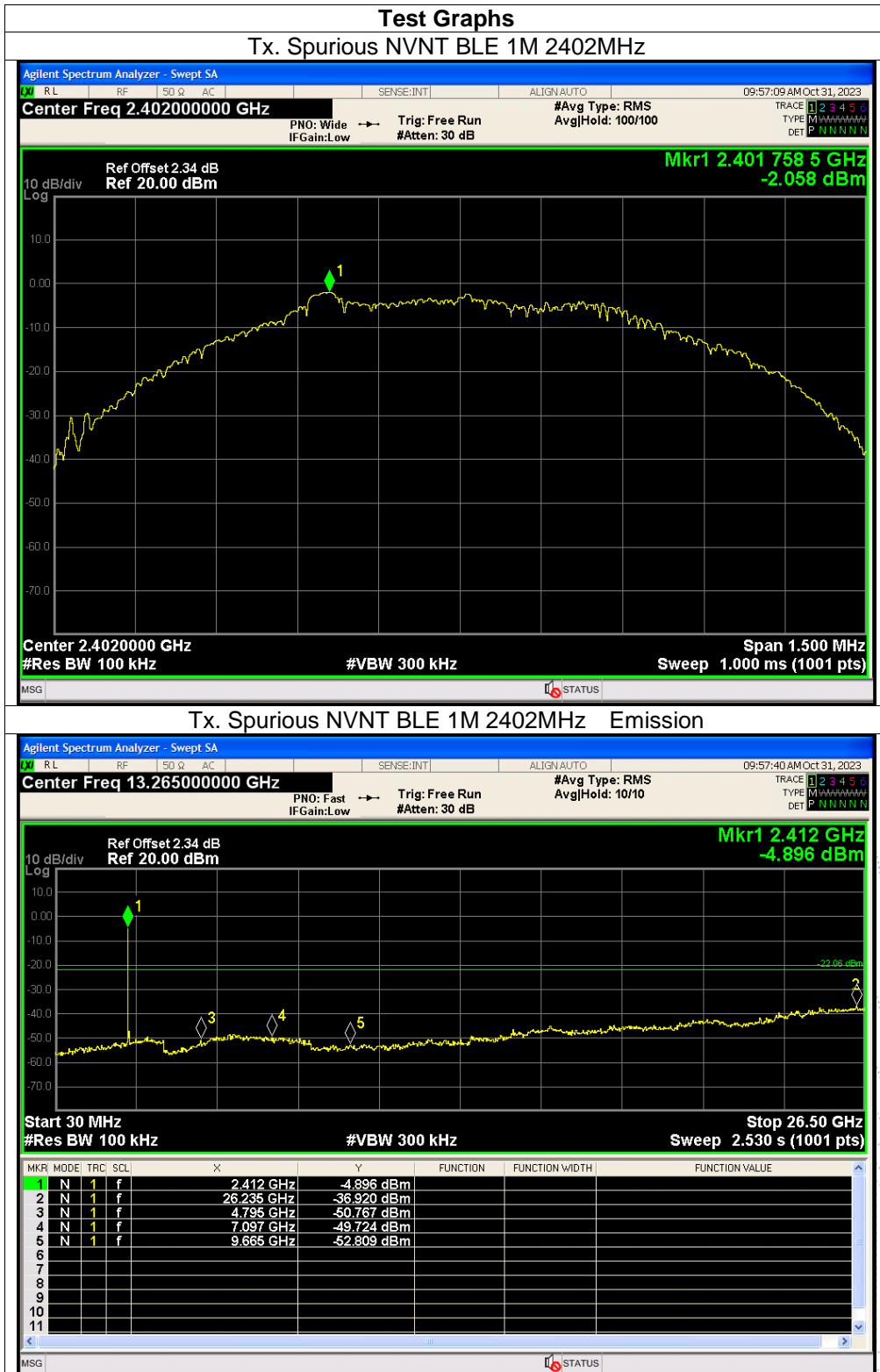

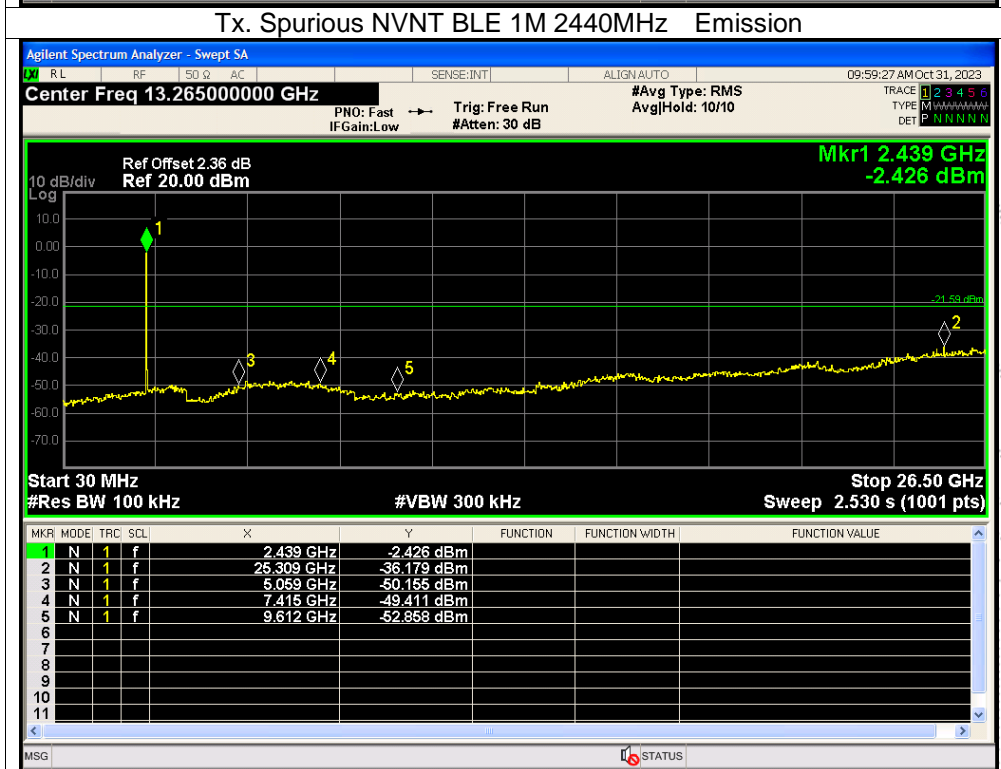
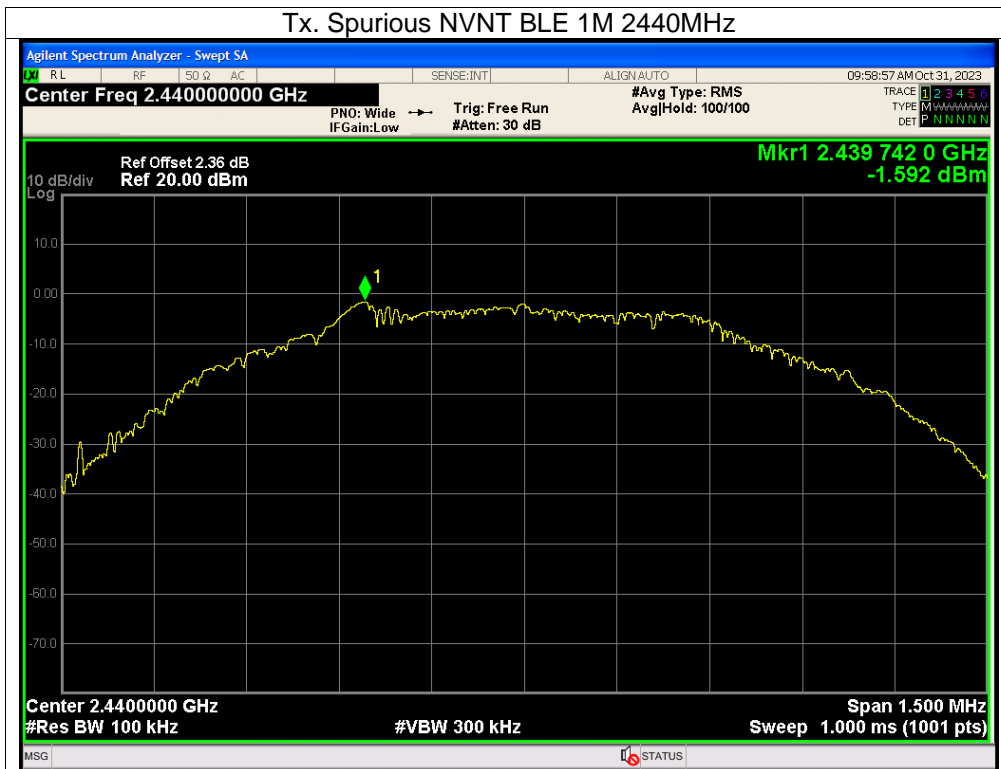

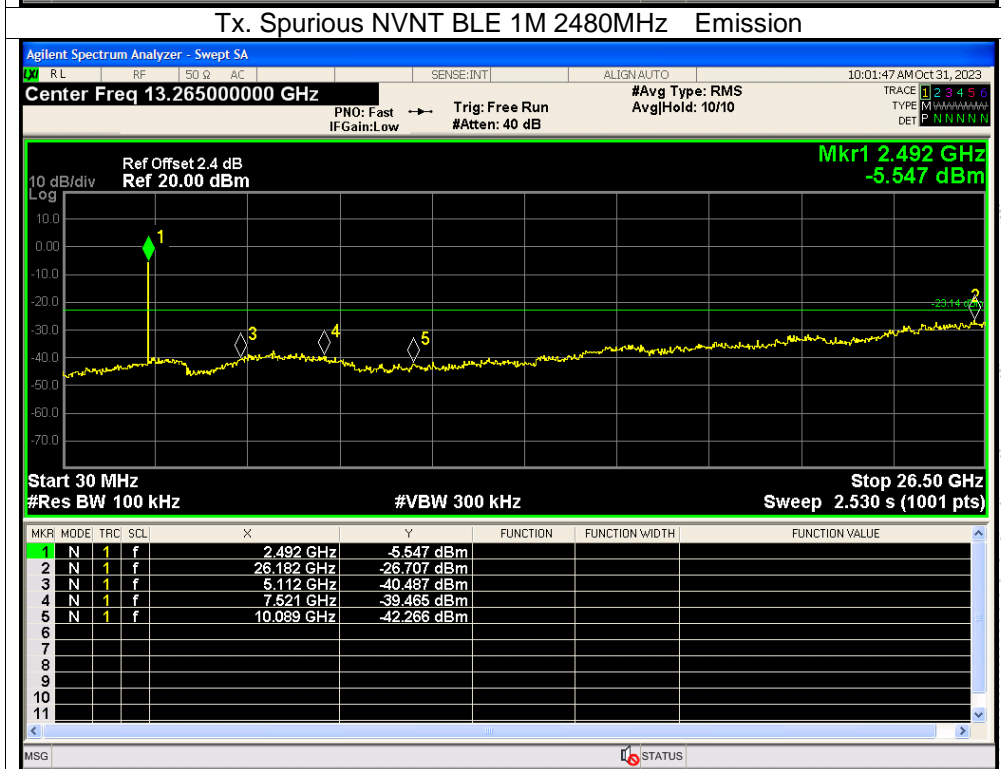
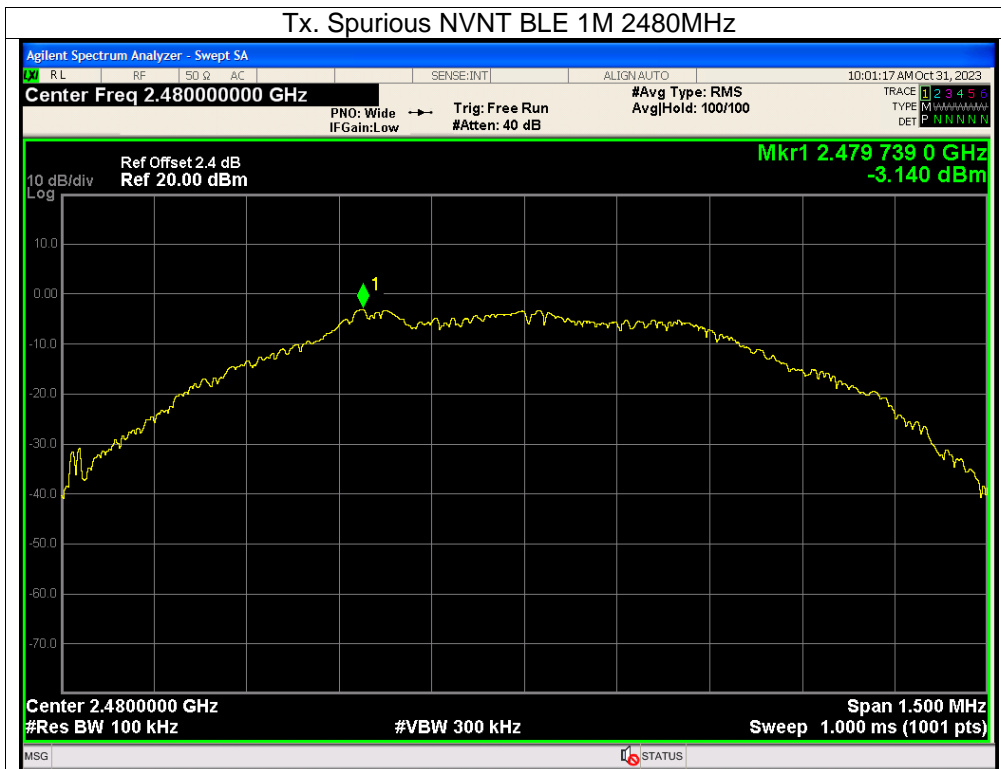

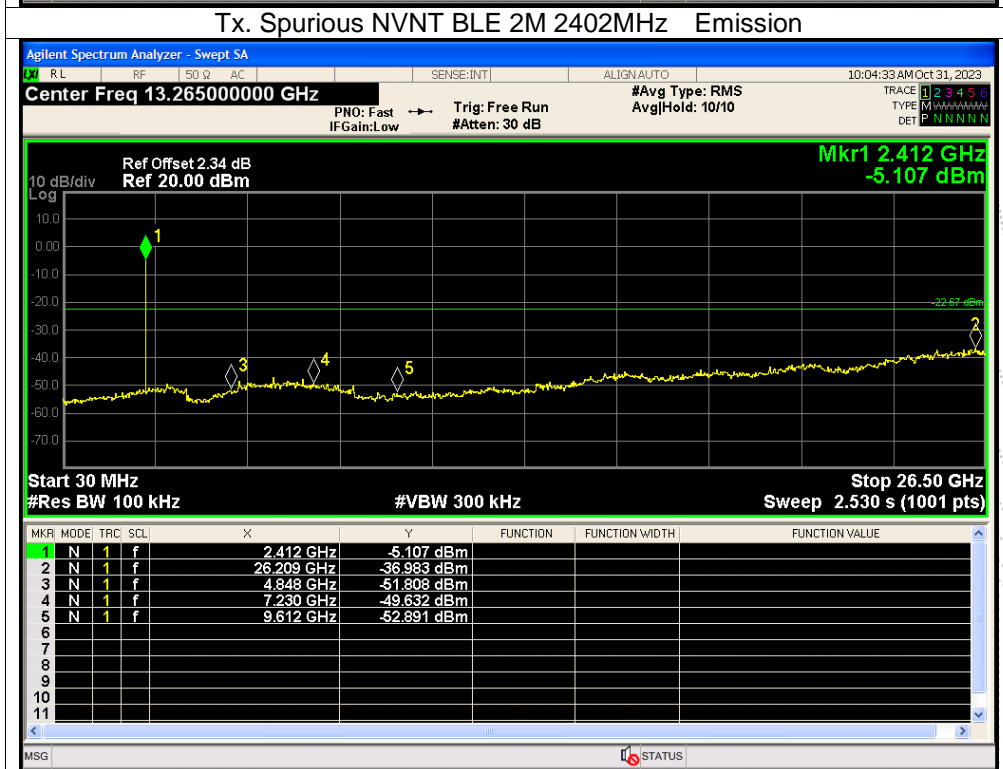
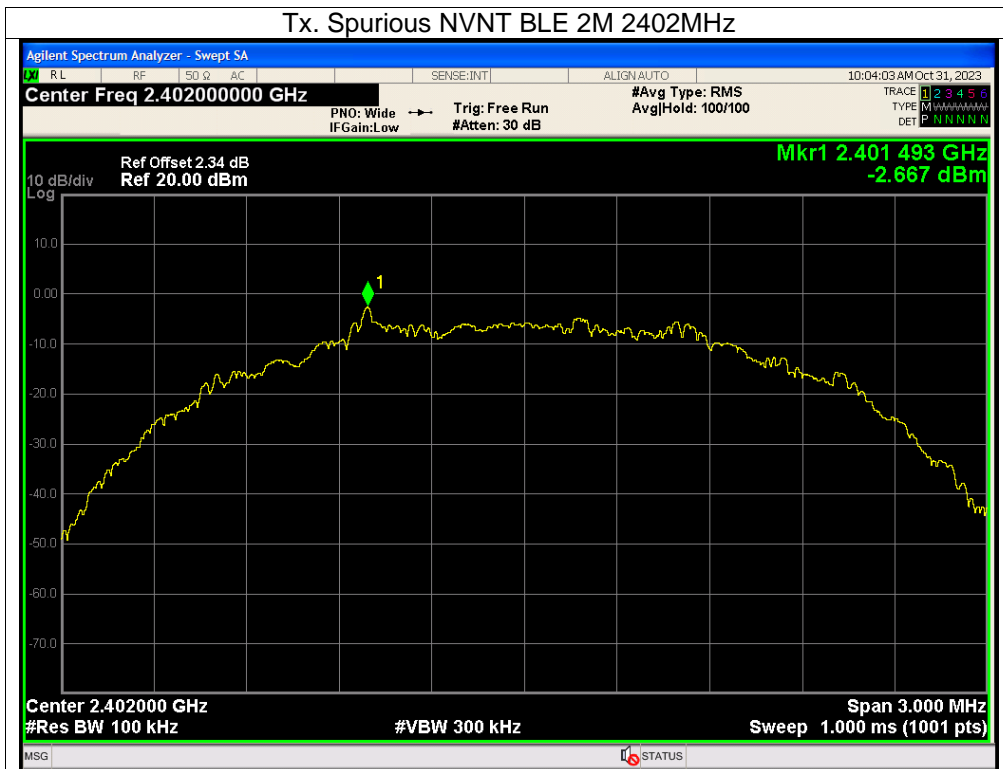

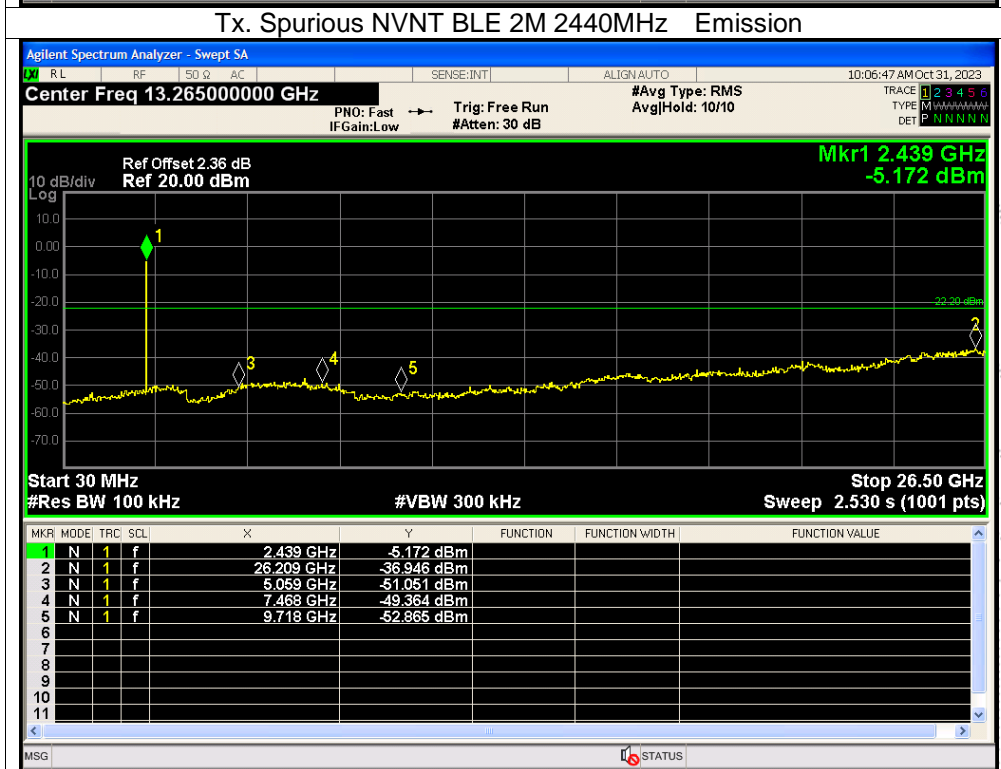
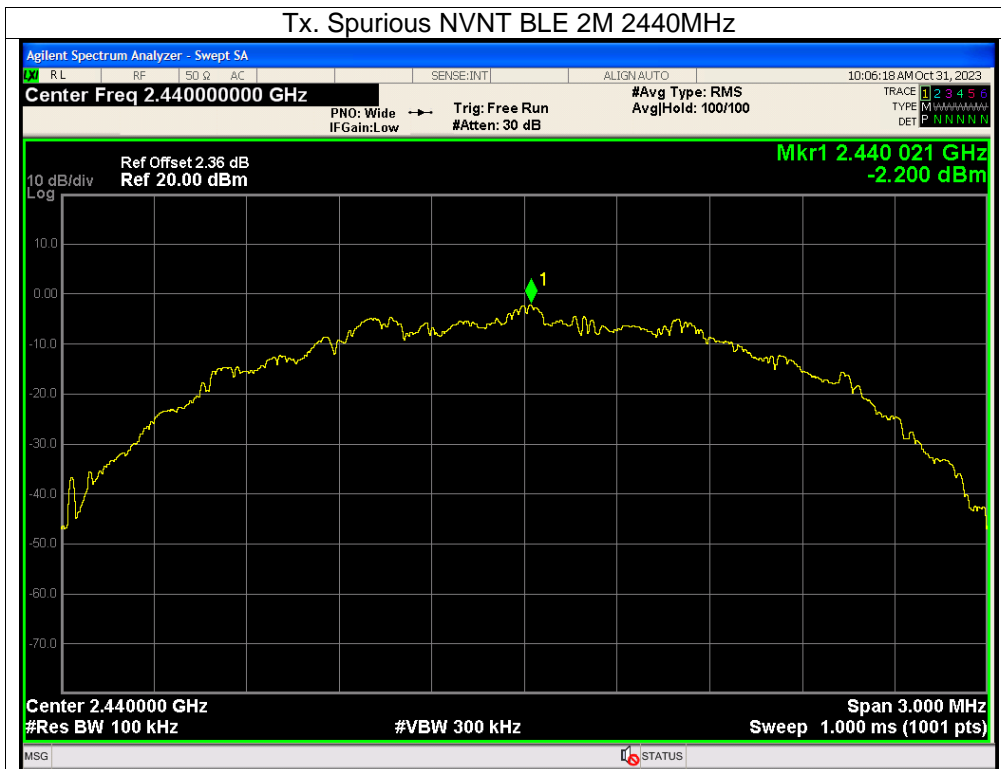

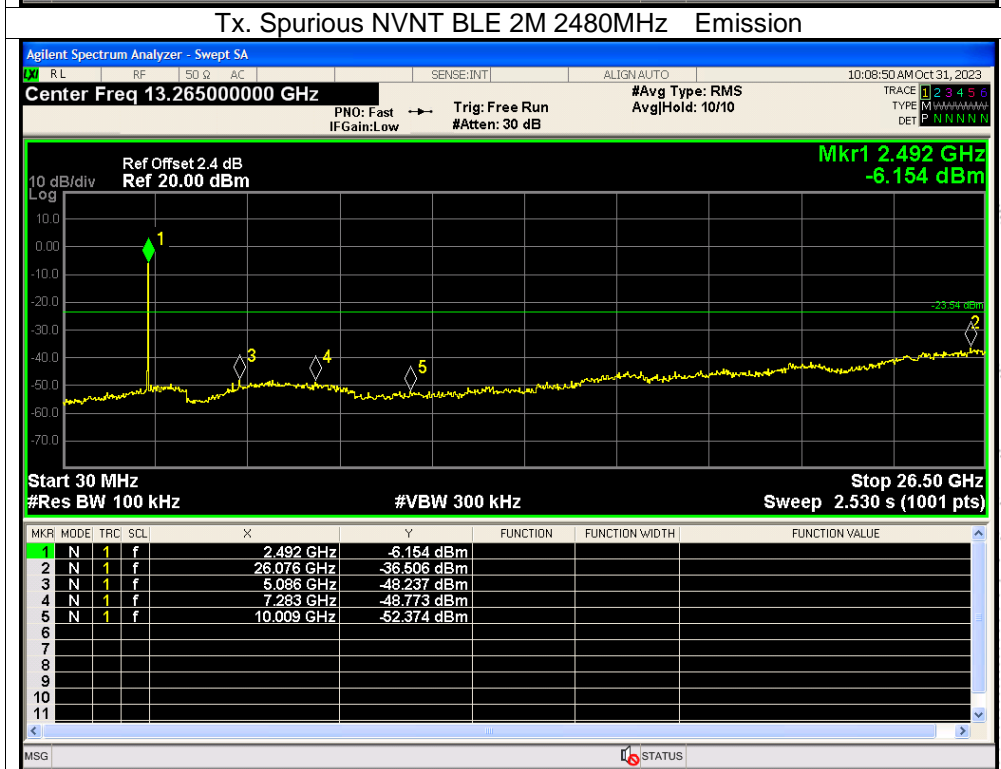
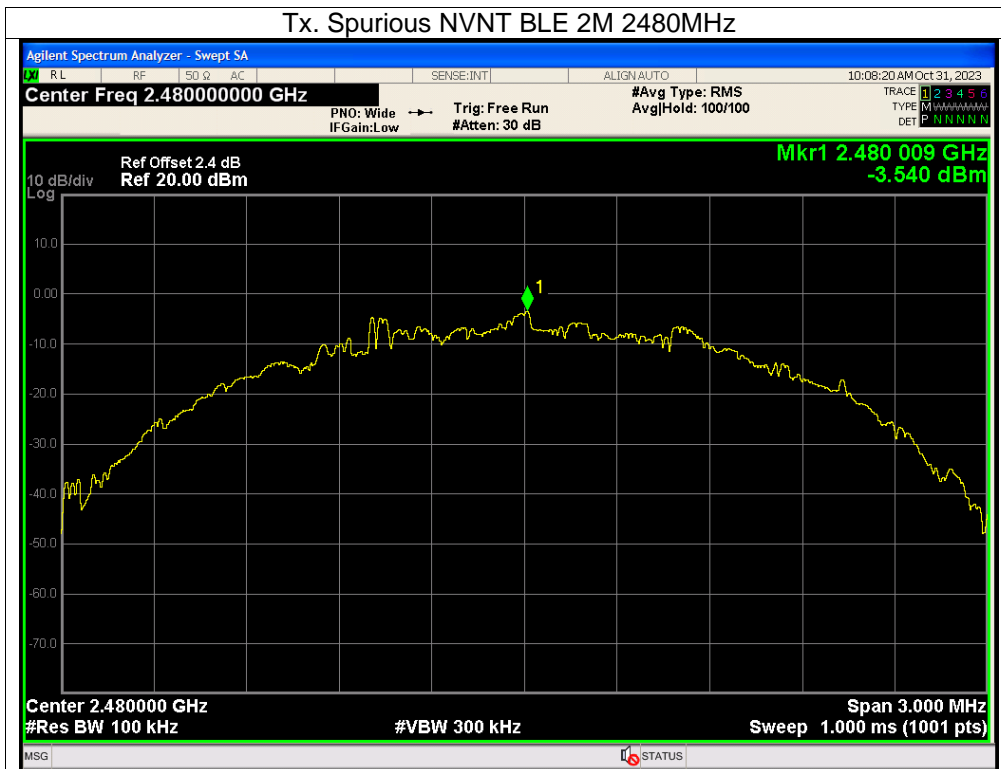

13. Antenna Requirement

13.1 Limit

According to RSS-Gen issue 5, section 8.3, a transmitter can only be sold or operated with antennas with which it was certified. A transmitter may be certified with multiple antenna types. An antenna type comprises antennas having similar in-band and out-of-band radiation patterns.

13.2 Test Result

The EUT antenna is Internal antenna, fulfill the requirement of this section.

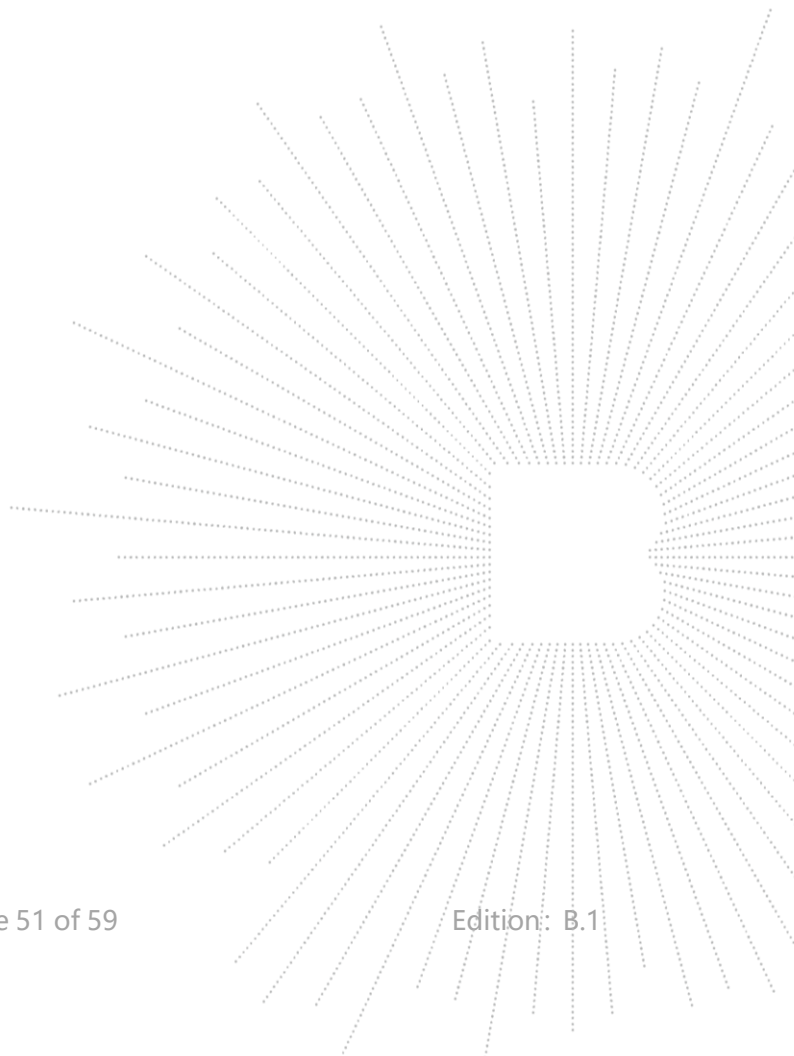

14. Duty Cycle Of Test Signal

14.1 Standard Requirement

Pre-analysis Check: While conducting average power measurement, duty cycle of each mode shall be checked to ensure its duty cycle in order to compensate for the loss due to insufficient ratio of duty cycle. All duty cycle is pre-scanned, and result as obtained below shows only the most representative ones where duty cycle is conducted as the given transmission with given virtual operation that expresses the percentage.

14.2 Formula

Duty Cycle = $T_{on} / (T_{on} + T_{off})$

14.3 Test Procedure

1. Set span = Zero
2. RBW = 8MHz
3. VBW = 8MHz,
4. Detector = Peak

Condition	Mode	Frequency (MHz)	Duty Cycle (%)	Correction Factor (dB)	1/T (kHz)
NVNT	BLE 1M	2402	95.2	0.21	0.85
NVNT	BLE 1M	2440	95.2	0.21	0.85
NVNT	BLE 1M	2480	96	0.18	0.84
NVNT	BLE 2M	2402	96	0.18	0.84
NVNT	BLE 2M	2440	95.2	0.21	0.85
NVNT	BLE 2M	2480	95.2	0.21	0.85

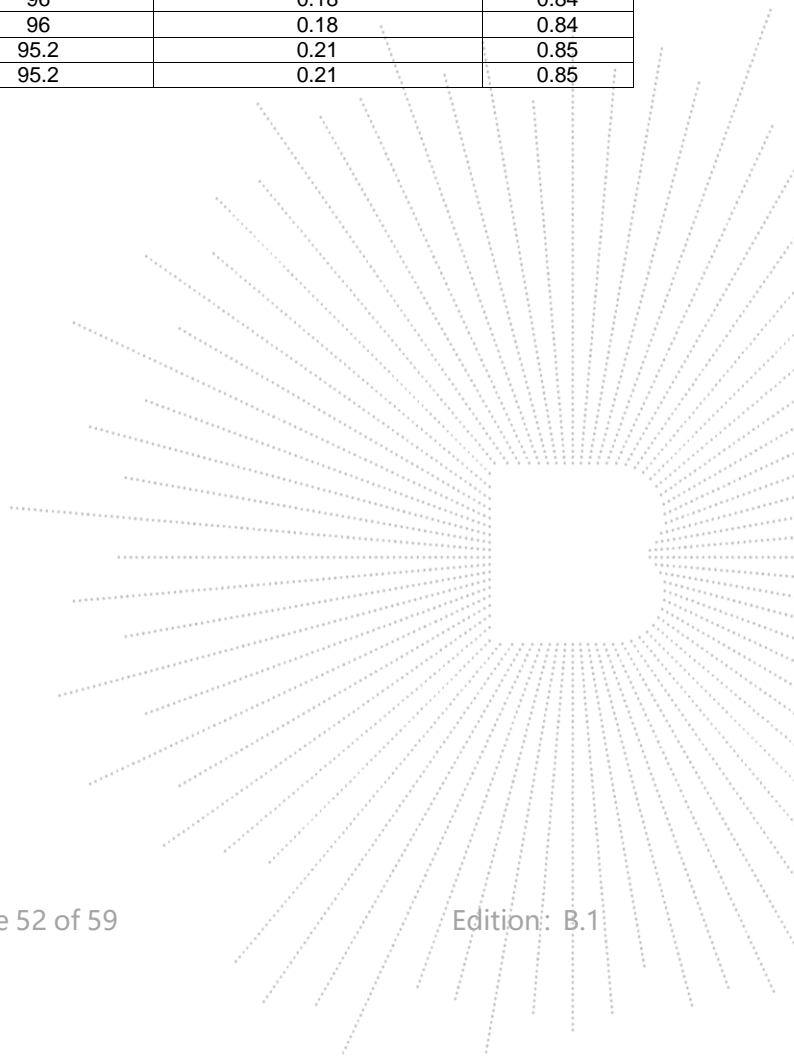

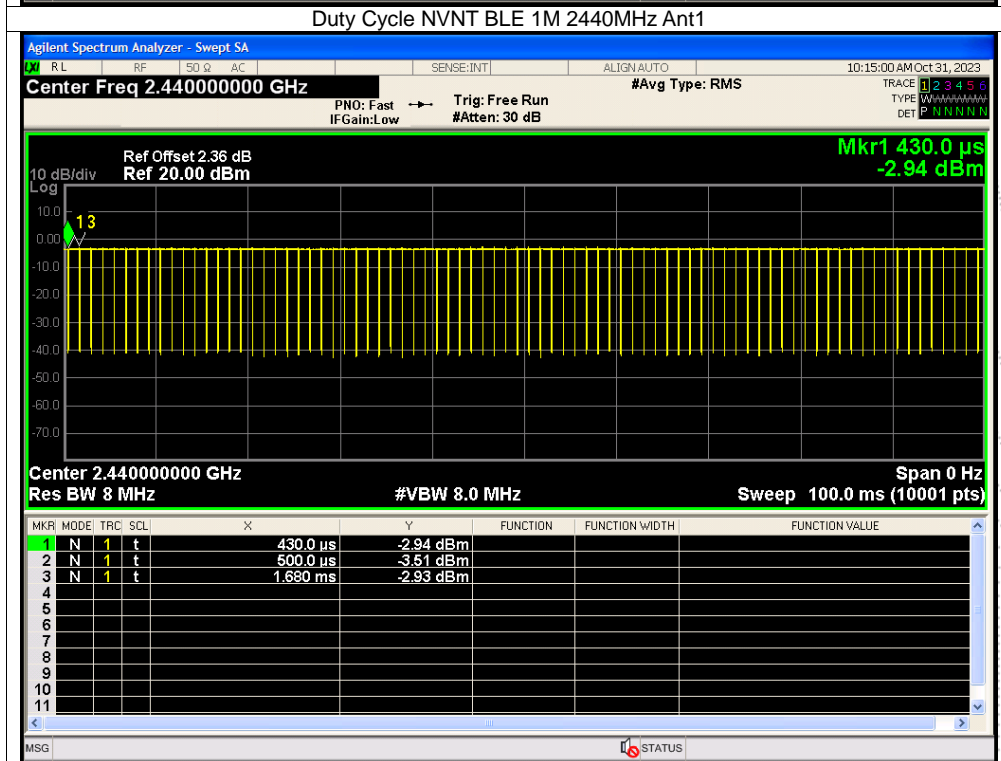
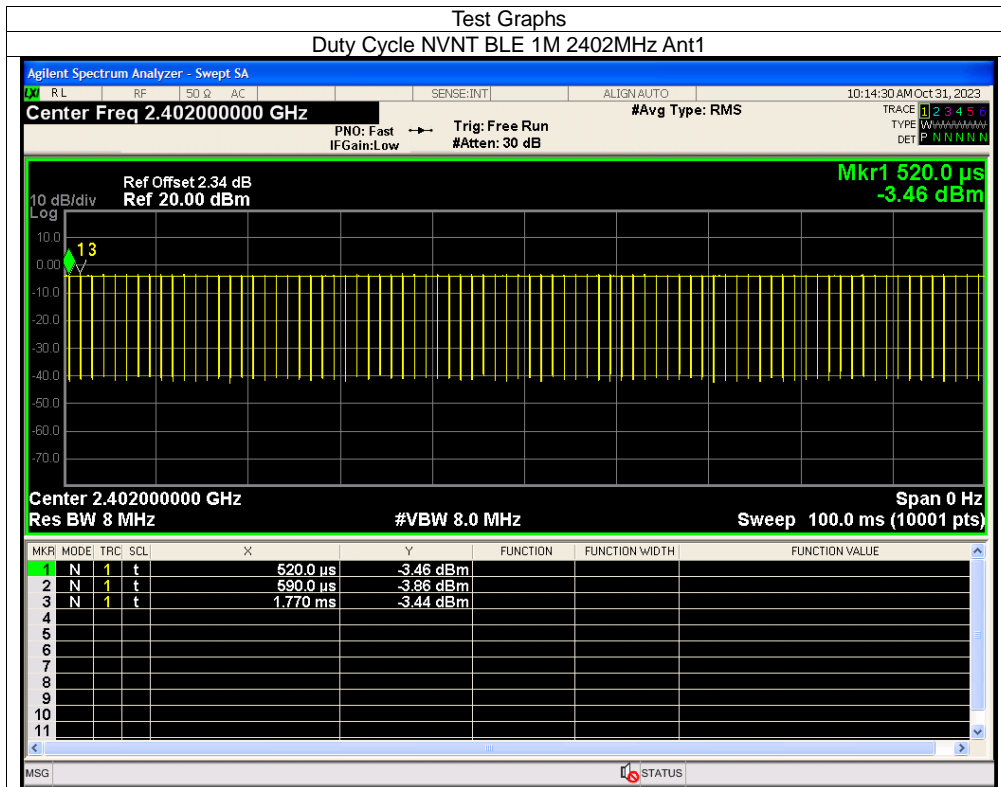

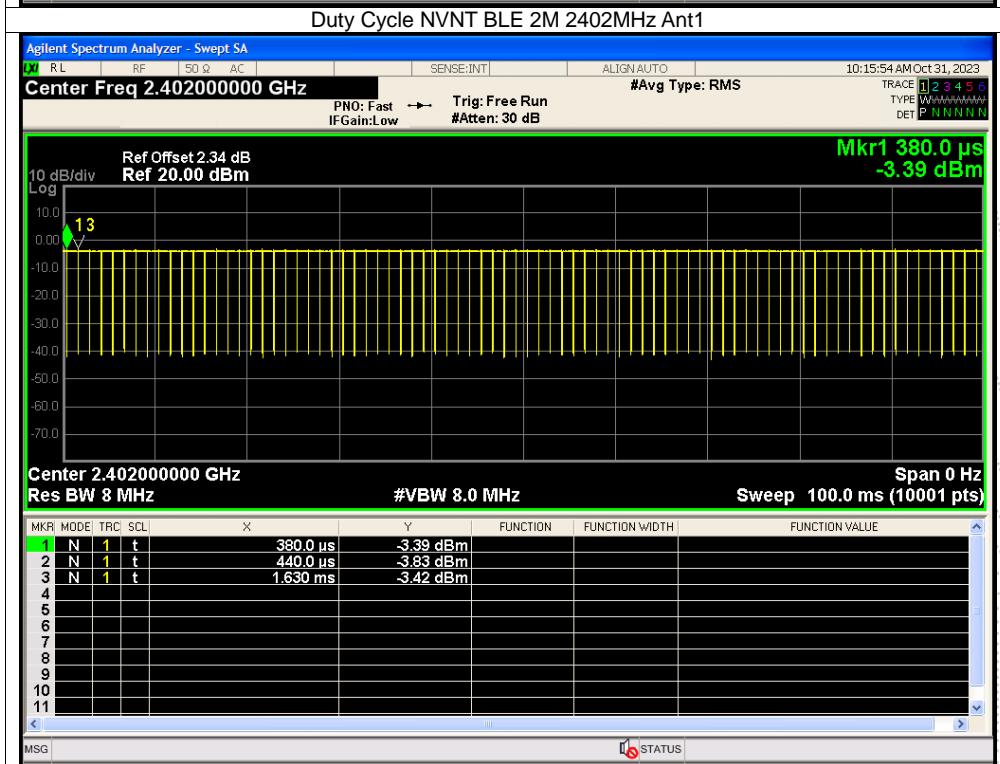
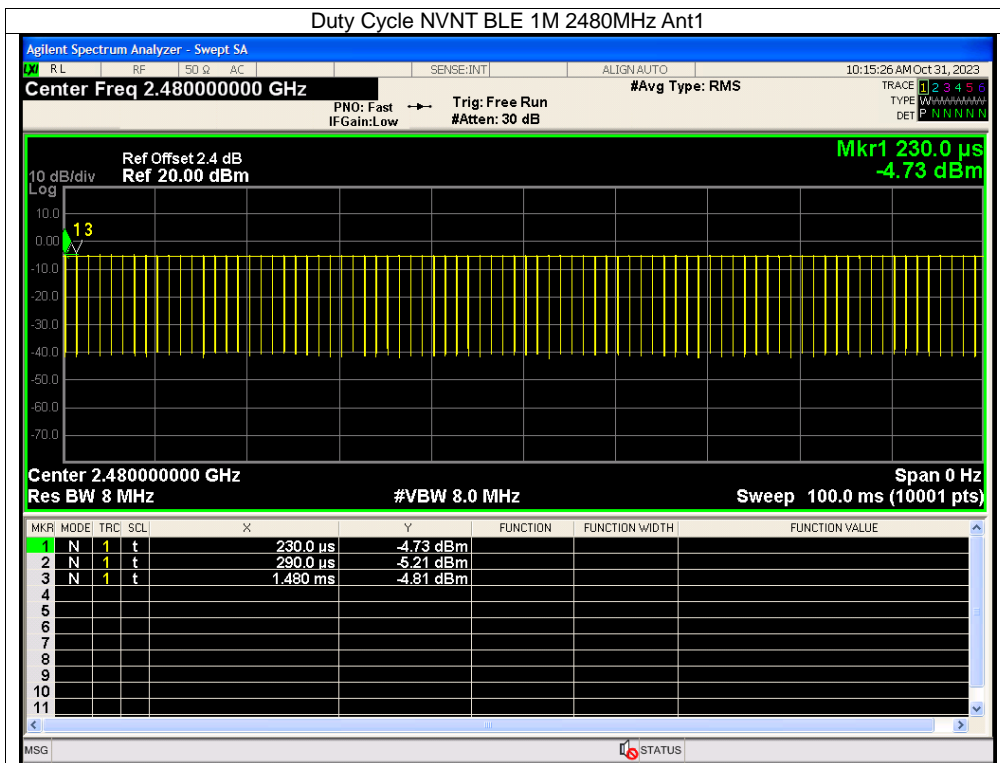

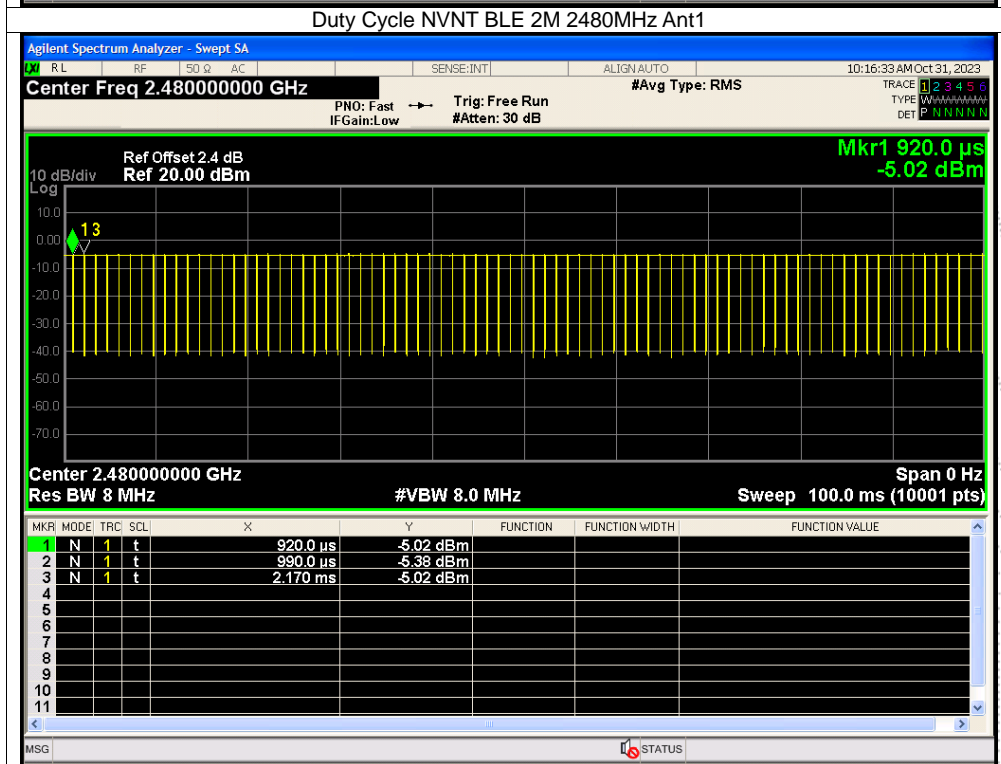
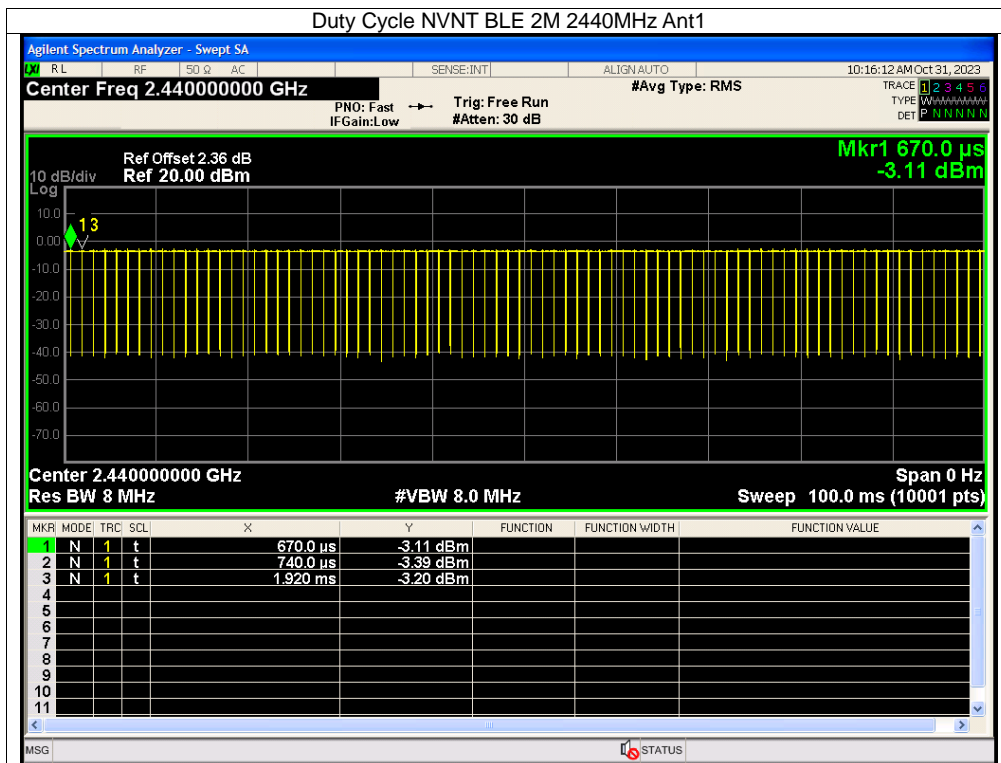

15. EUT Photographs

EUT Photo 1



EUT Photo 2

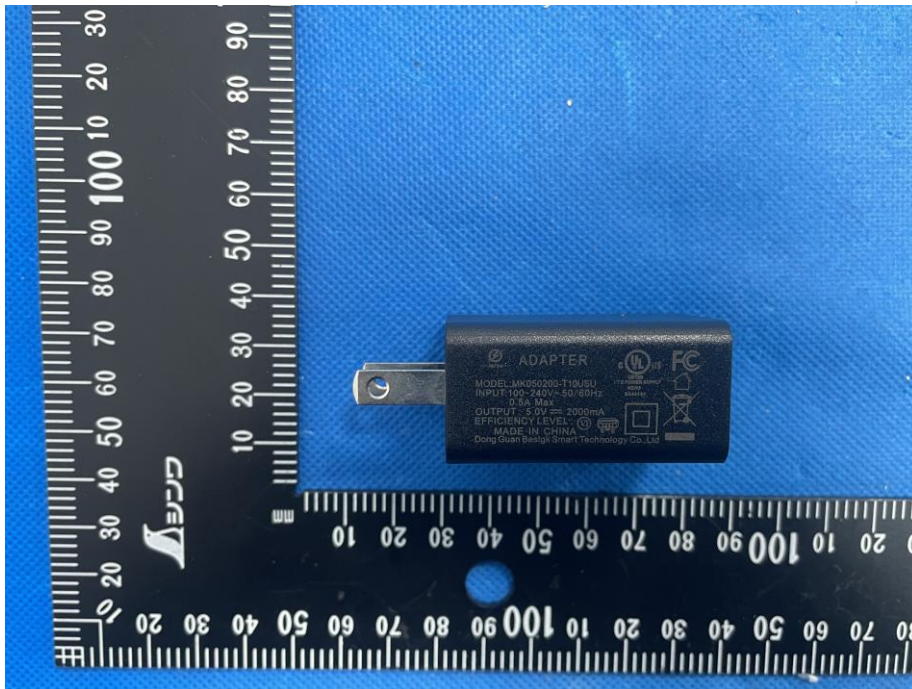

16. EUT Test Setup Photographs

Conducted Emissions Photo



Radiated Measurement Photos

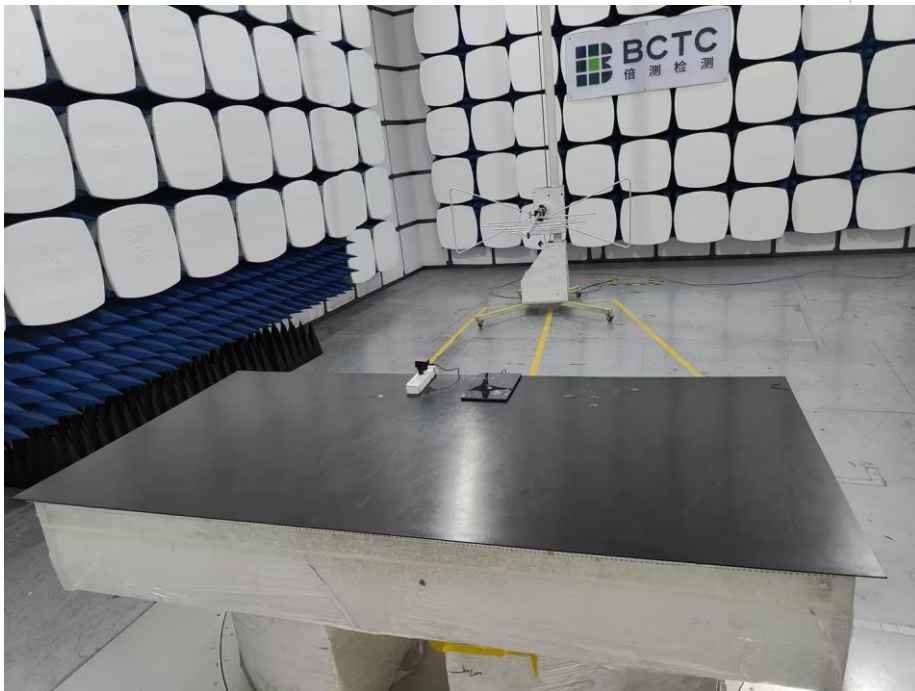

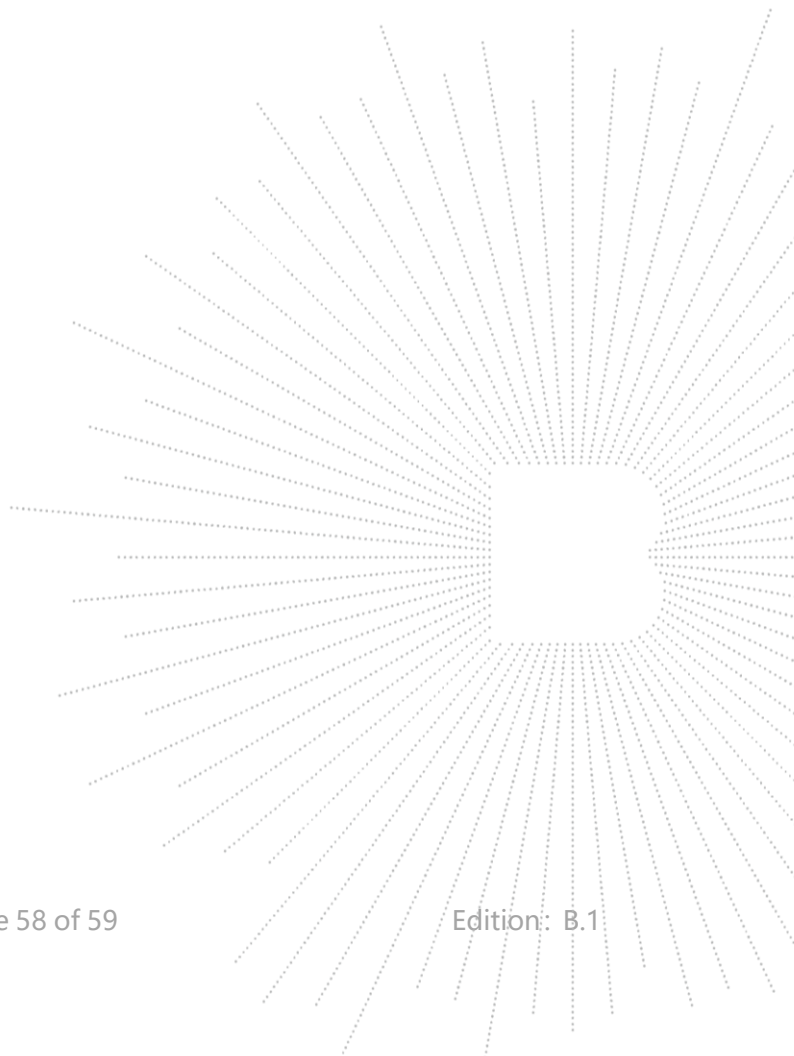

STATEMENT

1. The equipment lists are traceable to the national reference standards.
2. The test report can not be partially copied unless prior written approval is issued from our lab.
3. The test report is invalid without the "special seal for inspection and testing".
4. The test report is invalid without the signature of the approver.
5. The test process and test result is only related to the Unit Under Test.
6. Sample information is provided by the client and the laboratory is not responsible for its authenticity.
7. The quality system of our laboratory is in accordance with ISO/IEC17025.
8. If there is any objection to this test report, the client should inform issuing laboratory within 15 days from the date of receiving test report.

Address:

1-2/F., Building B, Pengzhou Industrial Park, No.158, Fuyuan 1st Road, Zhancheng, Fuhai Subdistrict, Bao'an District, Shenzhen, Guangdong, China

TEL: 400-788-9558

P.C.: 518103

FAX: 0755-33229357

Website: <http://www.chnbctc.com>E-Mail: bctc@bctc-lab.com.cn

***** END *****

