

# TEST REPORT

Report No.: BCTC2401807783-4E

---

Applicant: SHENZHEN NST INDUSTRY AND TRADE CO.,LTD

---

Product Name: 15.6 inch laptop

---

Test Model: M15-N

---

Tested Date: 2024-01-16 to 2024-02-01

---

Issued Date: 2024-02-02

---

**Shenzhen BCTC Testing Co., Ltd.**



# FCC ID: 2AAMS-M15NPRO

Product Name: 15.6 inch laptop  
Trademark: N/A  
Model/Type reference: M15-N  
M15PRO-N, M156FH  
Prepared For: SHENZHEN NST INDUSTRY AND TRADE CO.,LTD  
Address: 3-4/F, Bldg 1, Hongbang Intelligent Technology Park, No.30 Cuibao Road,  
Baolong Street, Longgang District, Shenzhen  
Manufacturer: SHENZHEN NST INDUSTRY AND TRADE CO.,LTD  
Address: 3-4/F, Bldg 1, Hongbang Intelligent Technology Park, No.30 Cuibao Road,  
Baolong Street, Longgang District, Shenzhen  
Prepared By: Shenzhen BCTC Testing Co., Ltd.  
Address: 1-2/F., Building B, Pengzhou Industrial Park, No.158, Fuyuan 1st Road,  
Zhancheng, Fuhai Subdistrict, Bao'an District, Shenzhen, Guangdong, China  
Sample Received Date: 2024-01-16  
Sample tested Date: 2024-01-16 to 2024-02-01  
Issue Date: 2024-02-02  
Report No.: BCTC2401807783-4E  
FCC Part15 15.407  
Test Standards: ANSI C63.10-2013  
KDB 662911 D01 v02r01  
KDB 789033 D02 v02r01  
Test Results: PASS

Tested by:

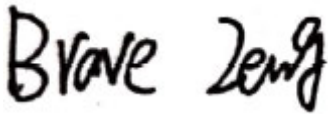

Brave Zeng/ Project Handler

Approved by:



Zero Zhou/Reviewer

The test report is effective only with both signature and specialized stamp. This result(s) shown in this report refer only to the sample(s) tested. Without written approval of Shenzhen BCTC Testing Co., Ltd, this report can't be reproduced except in full. The tested sample(s) and the sample information are provided by the client.

## Table Of Content

	Page
Test Report Declaration	
1. Version .....	5
2. Test Summary .....	6
3. Measurement Uncertainty .....	7
4. Product Information And Test Setup .....	8
4.1 Product Information.....	8
4.2 Test Setup Configuration .....	9
4.3 Support Equipment .....	9
4.4 Channel List.....	9
4.5 Test Mode .....	10
4.7 Antenna.....	11
5. Test Facility And Test Instrument Used.....	12
5.1 Test Facility.....	12
5.2 Test Instrument Used.....	12
6. Conducted Emissions.....	14
6.1 Block Diagram Of Test Setup.....	14
6.2 Limit .....	14
6.3 Test Procedure .....	14
6.4 EUT Operating Conditions .....	14
6.5 Test Result.....	15
7. Radiated Emissions.....	17
7.1 Block Diagram Of Test Setup.....	17
7.2 Limit .....	18
7.3 Test Procedure .....	19
7.4 EUT Operating Conditions .....	20
7.5 Test Result.....	20
8. Power Spectral Density Test .....	35
8.1 Block Diagram Of Test Setup.....	35
8.2 Limit .....	35
8.3 Test Procedure .....	36
8.4 EUT Operating Conditions .....	36
8.5 Test Result.....	37
9. 26dB & 6dB & 99% Emission Bandwidth .....	53
9.1 Block Diagram Of Test Setup.....	53
9.2 Limit .....	53
9.3 Test Procedure .....	53
9.4 EUT Operating Conditions .....	54
9.5 Test Result.....	55
10. Maximum Conducted Output Power.....	85
10.1 Block Diagram Of Test Setup.....	85
10.2 Limit .....	85
10.3 Test Procedure .....	85
10.4 EUT Operating Conditions .....	86
10.5 Test Result.....	87

11. Out Of Band Emissions .....	89
11.1 Block Diagram Of Test Setup.....	89
11.2 Limit .....	89
11.3 Test Procedure .....	89
11.4 EUT Operating Conditions .....	89
11.5 Test Result.....	89
12. Spurious RF Conducted Emissions.....	102
12.1 Block Diagram Of Test Setup.....	102
12.2 Limit .....	102
12.3 Test Procedure .....	102
12.4 Test Result.....	102
13. Frequency Stability Measurement .....	117
13.1 Block Diagram Of Test Setup.....	117
13.2 Limit .....	117
13.3 Test Procedure .....	117
13.4 Test Result.....	118
14. Antenna Requirement .....	124
14.1 Limit .....	124
14.2 Test Result.....	124
15. EUT Photographs.....	125
16. EUT Test Setup Photographs.....	126

(Note: N/A Means Not Applicable)

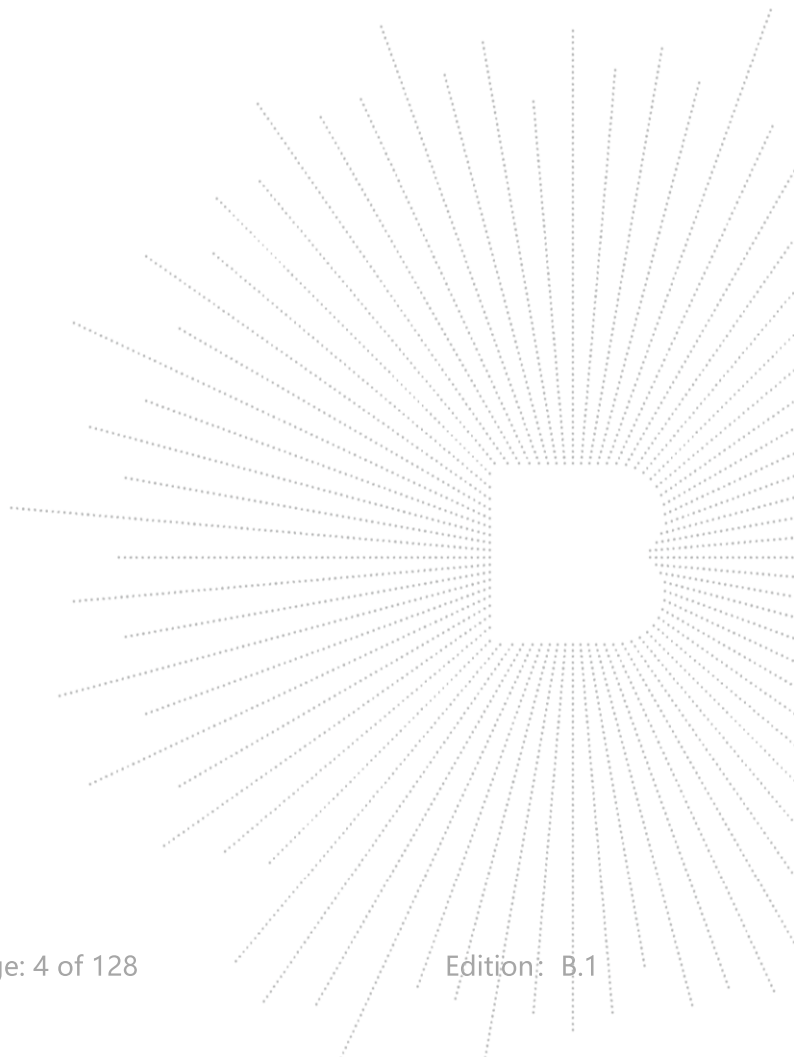

**1. Version**

<b>Report No.</b>	<b>Issue Date</b>	<b>Description</b>	<b>Approved</b>
BCTC2401807783-4E	2024-02-02	Original	Valid

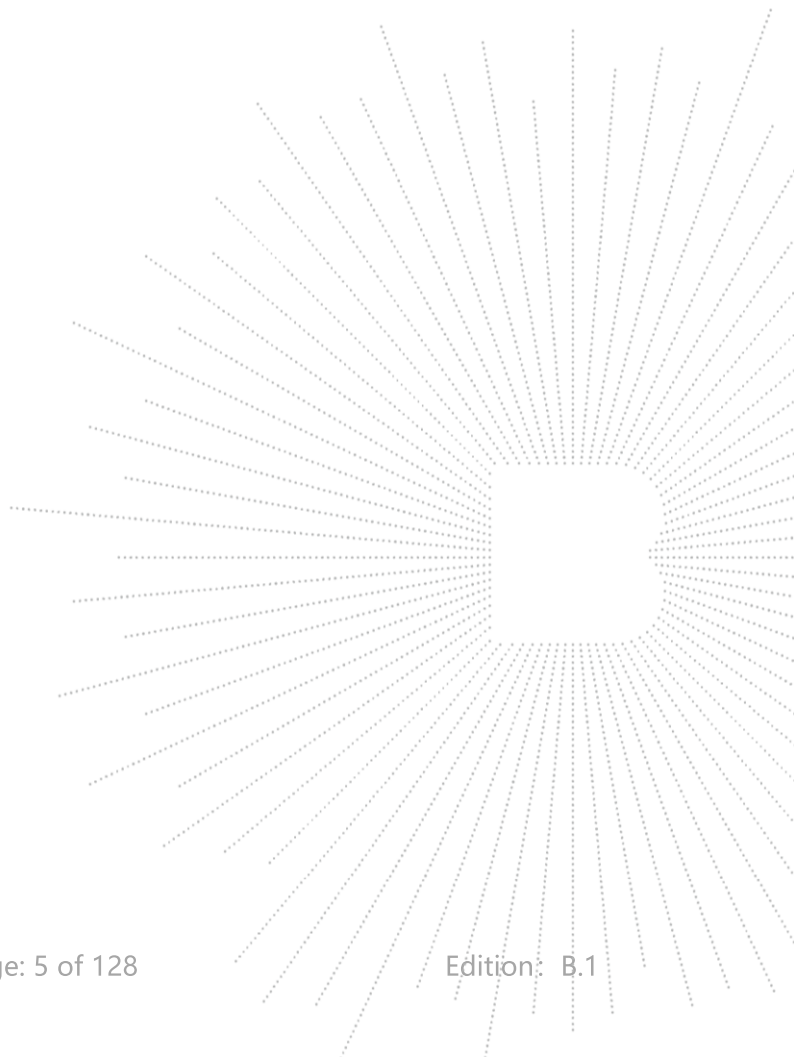

## 2. Test Summary

The Product has been tested according to the following specifications:

No.	Test Parameter	Clause No	Results
1	Spurious Radiated Emissions	15.209(a), 15.407 (b)(1) 15.407 (b)(4) 15.407 (b)(8)	PASS
2	Conducted Emission	15.207	PASS
3	26 dB and 99% Emission Bandwidth	15.407 (a)(12) 15.1049	PASS
4	Minimum 6 dB bandwidth	15.407(e)	PASS
5	Maximum Conducted Output Power	15.407 (a)(1) 15.407 (a)(3)	PASS
6	Band Edge	2.1051, 15.407(b)(1) 15.407(b)(4)	PASS
7	Power Spectral Density	15.407 (a)(1) 15.407 (a)(3)	PASS
8	Spurious Emissions at Antenna Terminals	2.1051, 15.407(b)	PASS
9	Antenna Requirement	15.203	PASS

Note: The device shall automatically discontinue transmission in case of either absence of information to transmit or operational failure.

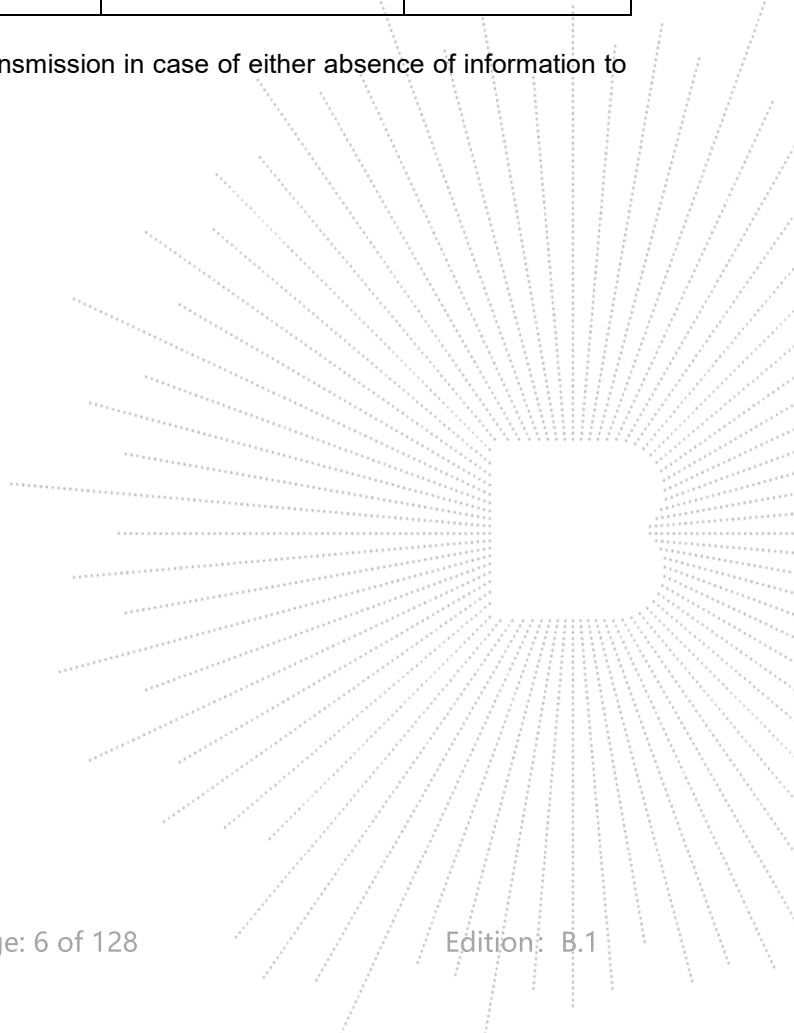

### 3. Measurement Uncertainty

Where relevant, the following measurement uncertainty levels have been estimated for tests performed on the Product as specified in CISPR 16-4-2. This uncertainty represents an expanded uncertainty expressed at approximately the 95% confidence level using a coverage factor of k=2.

No.	Item	Uncertainty
1	3m chamber Radiated spurious emission(9kHz-30MHz)	U=3.7dB
2	3m chamber Radiated spurious emission(30MHz-1GHz)	U=4.3dB
3	3m chamber Radiated spurious emission(1GHz-18GHz)	U=4.5dB
4	3m chamber Radiated spurious emission(18GHz-40GHz)	U=3.34dB
5	Conducted Emission(150kHz-30MHz)	U=3.20dB
6	Conducted Adjacent channel power	U=1.38dB
7	Conducted output power uncertainty Above 1G	U=1.576dB
8	Conducted output power uncertainty below 1G	U=1.28dB
9	humidity uncertainty	U=5.3%
10	Temperature uncertainty	U=0.59°C

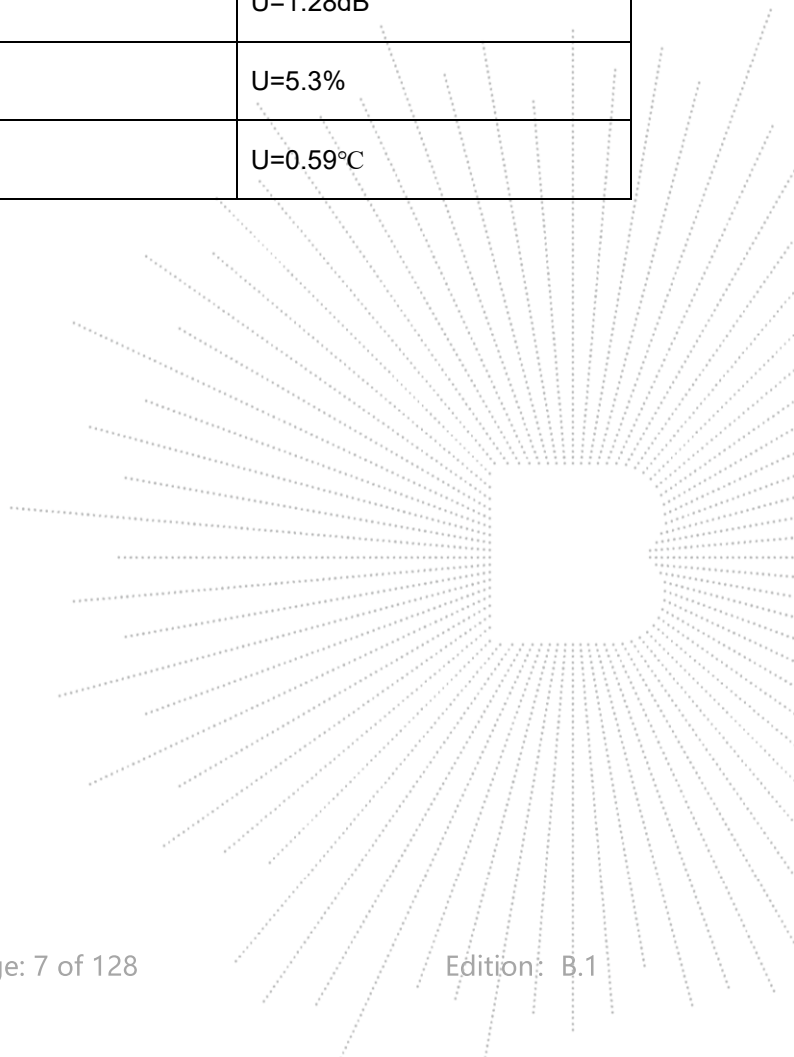

## 4. Product Information And Test Setup

### 4.1 Product Information

Model/Type reference:	M15-N M15PRO-N, M156FH
Model differences:	All the model are the same circuit and RF module, except model names and appearance of the color.
Hardware Version:	X133GRX100
Software Version:	windows11 HOME
IEEE 802.11 WLAN Mode Supported	802.11a/n/ac(20MHz channel bandwidth) 802.11n/ac(40MHz channel bandwidth) 802.11ac(80MHz channel bandwidth)
Operation Frequency:	5180-5240MHz for 802.11a/n(HT20); 5190-5230MHz for 802.11n(HT40); 5210MHz for 802.11 ac80; 5745-5825 MHz for 802.11a/n(HT20); 5755-5795 MHz for 802.11n(HT40); 5775MHz for 802.11 ac80;
Data Rate	802.11a: 6,9,12,18,24,36,48,54Mbps; 802.11n(HT20/HT40):MCS0-MCS15; 802.11ac(VHT20): NSS1, MCS0-MCS8 802.11ac(VHT40/VHT80):NSS1, MCS0-MCS
Type of Modulation:	OFDM with BPSK/QPSK/16QAM/64QAM/256QAM for 802.11a/n/ac; 4 channels for 802.11a/n20 in the 5180-5240MHz band ; 2 channels for 802.11 n40 in the 5190-5230MHz band ;
Number Of Channel	1 channels for 802.11 ac80 in the 5210MHz band ; 5 channels for 802.11a/n20 in the 5745-5825MHz band ; 2 channels for 802.11 n40 in the 5755-5795MHz band ; 1 channels for 802.11 ac80 in the 5775MHz band
Antenna installation:	Internal antenna 5.1G & 5.8G: Antenna A & B: 2.92 dBi
Antenna Gain:	Remark: <input checked="" type="checkbox"/> The antenna gain of the product comes from the antenna report provided by the customer, and the test data is affected by the customer information. <input type="checkbox"/> The antenna gain of the product is provided by the customer, and the test data is affected by the customer information.
Ratings:	DC 12V from adapter/DC 7.6V from battery
Adapter Information:	MODEL: JZB024-1202000UX INPUT: 100-240V~50/60Hz 1.0A OUTPUT: DC 12.0V 2.0A 24.0W



## 4.2 Test Setup Configuration

See test photographs attached in *EUT TEST SETUP PHOTOGRAPHS* for the actual connections between Product and support equipment.

Conducted Emission:

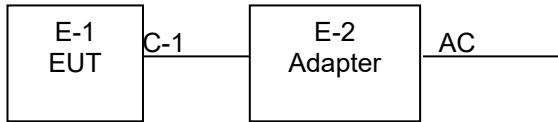

Radiated Spurious Emission

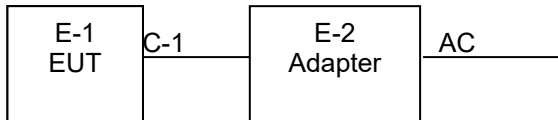

## 4.3 Support Equipment

No.	Device Type	Brand	Model	Series No.	Note
E-1	15.6 inch laptop	N/A	M15-N	N/A	EUT
E-2	Adapter	N/A	JZB024-120200 0UX	N/A	Auxiliary

Item	Shielded Type	Ferrite Core	Length	Note
C-1	N/A	N/A	3M	DC cable unshielded

### Notes:

- All the equipment/cables were placed in the worst-case configuration to maximize the emission during the test.
- Grounding was established in accordance with the manufacturer's requirements and conditions for the intended use.

## 4.4 Channel List

### 5.1G

802.11a/n/ac( 20MHz) Carrier Frequency Channel							
Channel	Frequency (MHz)	Channel	Frequency (MHz)	Channel	Frequency (MHz)	Channel	Frequency (MHz)
36	5180	44	5220	-	-	-	-
40	5200	48	5240	-	-	-	-

802.11n /ac(40MHz) Carrier Frequency Channel							
Channel	Frequency (MHz)	Channel	Frequency (MHz)	Channel	Frequency (MHz)	Channel	Frequency (MHz)
38	5190	-	-	-	-	-	-
46	5230	-	-	-	-	-	-

802.11ac (80MHz) Carrier Frequency Channel	
Channel	Frequency (MHz)
42	5210

## 5.8G

802.11a/n/ac( 20 MHz) Carrier Frequency Channel							
Channel	Frequency (MHz)	Channel	Frequency (MHz)	Channel	Frequency (MHz)	Channel	Frequency (MHz)
149	5745	153	5765	157	5785	161	5805
165	5825	-	-	-	-	-	-

802.11n/ac 40MHz Carrier Frequency Channel					
Channel	Frequency (MHz)	Channel	Frequency (MHz)	Channel	Frequency (MHz)
151	5755	159	5795	-	-

802.11ac 80MHz Carrier Frequency Channel	
Channel	Frequency (MHz)
155	5775

#### 4.5 Test Mode

To investigate the maximum EMI emission characteristics generates from EUT, the test system was pre-scanning tested base on the consideration of following EUT operation mode or test configuration mode which possible have effect on EMI emission level. Each of these EUT operation mode(s) or test configuration mode(s) mentioned above was evaluated respectively.

Pretest Mode	Description
Mode 1	802.11a / n/ ac 20 CH36/ CH40/ CH 48 802.11a /n/ ac 20 CH149/ CH157/ CH 165
Mode 2	802.11n/ ac40 CH38/ CH 46 802.11n/ ac40 CH 151 / CH 159
Mode 3	802.11 ac80 CH 42/CH 155
Mode 4	Link Mode

Note:

- (1) The measurements are performed at all Bit Rate of Transmitter, the worst data was reported.
- (2) We're testing antenna A data.

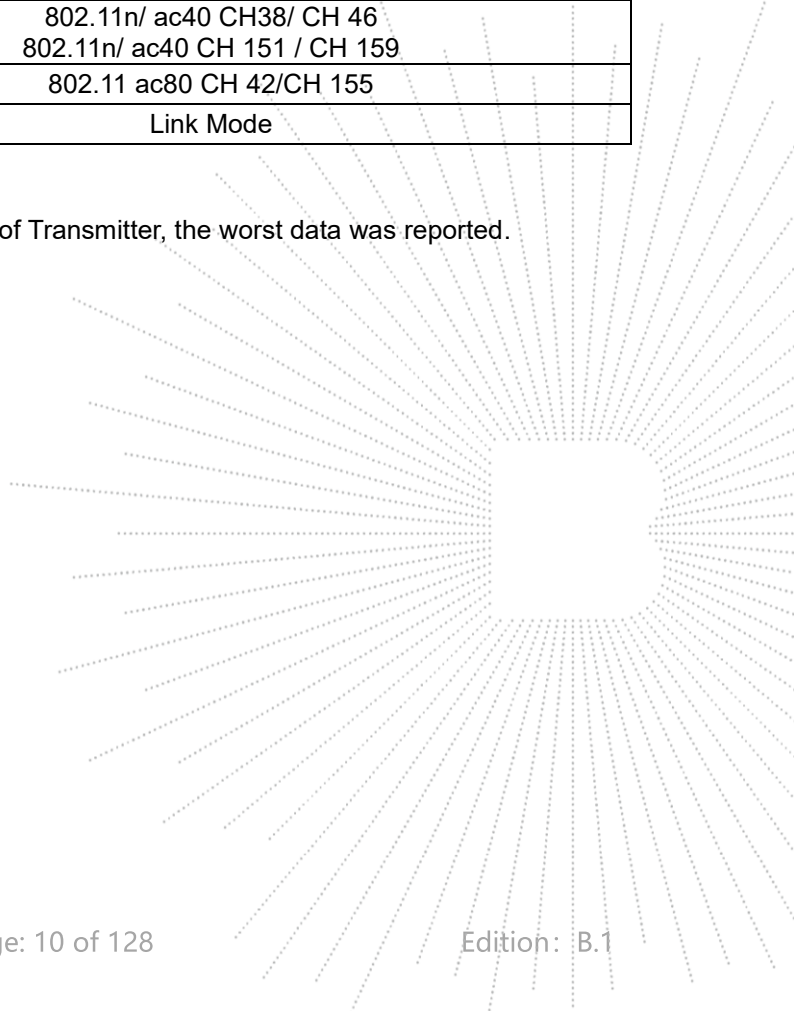

#### 4.6 Table Of Parameters Of Text Software Setting

During testing channel & power controlling software provided by the customer was used to control the operating channel as well as the output power level. The RF output power selection is for the setting of RF output power expected by the customer and is going to be fixed on the firmware of the final end product power parameters

Test software Version	CMD		
Parameters	DEF	DEF	DEF

#### 4.7 Antenna

##### 5.1G & 5.8G

Ant.	Brand	Model Name	Antenna Type	Gain (dBi)	NOTE
A	N/A	N/A	Internal antenna	2.92	N/A
B	N/A	N/A	Internal antenna	2.92	N/A

EUT has two Internal antennas with Max gain GANT 2.92 dBi on every antenna, CDD device with one spatial streams, also can operat with one spatial streams according to KDB662911 D01 v02r01, Directional gain= GANT + Array Gain, where Array Gain is as follows.

1)For power spectral density(PSD) measurements,  
 Array Gain= $10\log(NANT/NSS)$ dB= $10\log(2/1)$ =3.01 dBi,  
 So the directional gain for PSD is 5.93 dBi

2)For power measurements,  
 The Array gain=0 for  $NANT \leq 4$ ,  
 So the directional gain for Power measurements is 2.92 dBi

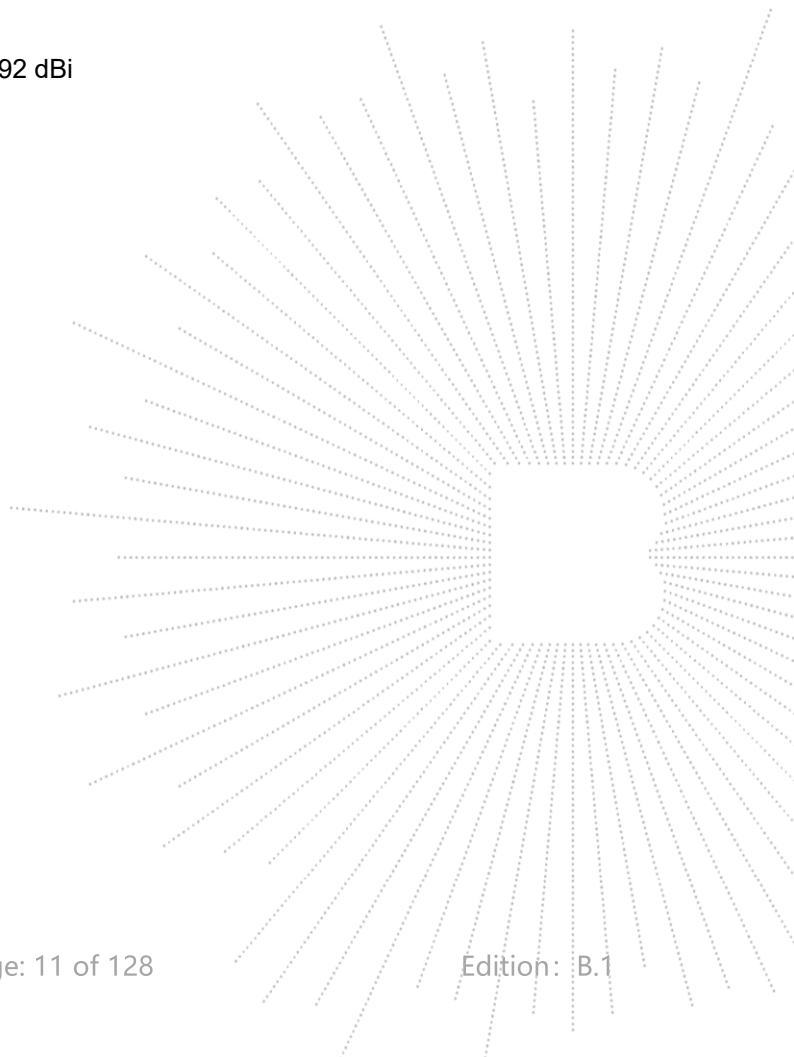

## 5. Test Facility And Test Instrument Used

### 5.1 Test Facility

All measurement facilities used to collect the measurement data are located at Shenzhen BCTC Testing Co., Ltd. Address: 1-2/F., Building B, Pengzhou Industrial Park, No.158, Fuyuan 1st Road, Zhancheng, Fuhai Subdistrict, Bao'an District, Shenzhen, Guangdong, China. The site and apparatus are constructed in conformance with the requirements of ANSI C63.4 and CISPR 16-1-1 other equivalent standards.

FCC Test Firm Registration Number: 712850

A2LA certificate registration number is: CN1212

ISED Registered No.: 23583

ISED CAB identifier: CN0017

### 5.2 Test Instrument Used

Conducted Emissions Test					
Equipment	Manufacturer	Model#	Serial#	Last Cal.	Next Cal.
Receiver	R&S	ESR3	102075	May 15, 2023	May 14, 2024
LISN	R&S	ENV216	101375	May 15, 2023	May 14, 2024
Software	Frad	EZ-EMC	EMC-CON 3A1	\	\
Pulse limiter	Schwarzbeck	VTSD9561-F	01323	Sept. 22, 2023	Sept. 21, 2024

RF Conducted Test					
Equipment	Manufacturer	Model#	Serial#	Last Cal.	Next Cal.
Power meter	Keysight	E4419	\	May 15, 2023	May 14, 2024
Power Sensor (AV)	Keysight	E9300A	\	May 15, 2023	May 14, 2024
Signal Analyzer20kHz-26.5GHz	Keysight	N9020A	MY49100060	May 15, 2023	May 14, 2024
Spectrum Analyzer9kHz-40GHz	R&S	FSP40	100363	May 15, 2023	May 14, 2024
Radio frequency control box	MAIWEI	MW100-RFC B	\	\	\
Software	MAIWEI	MTS 8310	\	\	\

Radiated Emissions Test (966 Chamber01)					
Equipment	Manufacturer	Model#	Serial#	Last Cal.	Next Cal.
966 chamber	ChengYu	966 Room	966	May 15, 2023	May 14, 2026
Receiver	R&S	ESR3	102075	May 15, 2023	May 14, 2024
Receiver	R&S	ESRP	101154	May 15, 2023	May 14, 2024
Amplifier	Schwarzbeck	BBV9744	9744-0037	May 15, 2023	May 14, 2024
TRILOG Broadband Antenna	Schwarzbeck	VULB9163	942	May 29, 2023	May 28, 2024
Loop Antenna(9KHz -30MHz)	Schwarzbeck	FMZB1519B	00014	May 31, 2023	May 30, 2024
Amplifier	SKET	LAPA_01G18 G-45dB	SK2021040901	May 15, 2023	May 14, 2024
Horn Antenna	Schwarzbeck	BBHA9120D	1541	May 31, 2023	May 30, 2024
Amplifier(18G Hz-40GHz)	MITEQ	TTA1840-35-HG	2034381	May 15, 2023	May 14, 2024
Horn Antenna(18G Hz-40GHz)	Schwarzbeck	BBHA9170	00822	May 31, 2023	May 30, 2024
Spectrum Analyzer9kHz-40GHz	R&S	FSP40	100363	May 15, 2023	May 14, 2024
Software	Frad	EZ-EMC	FA-03A2 RE	\	\

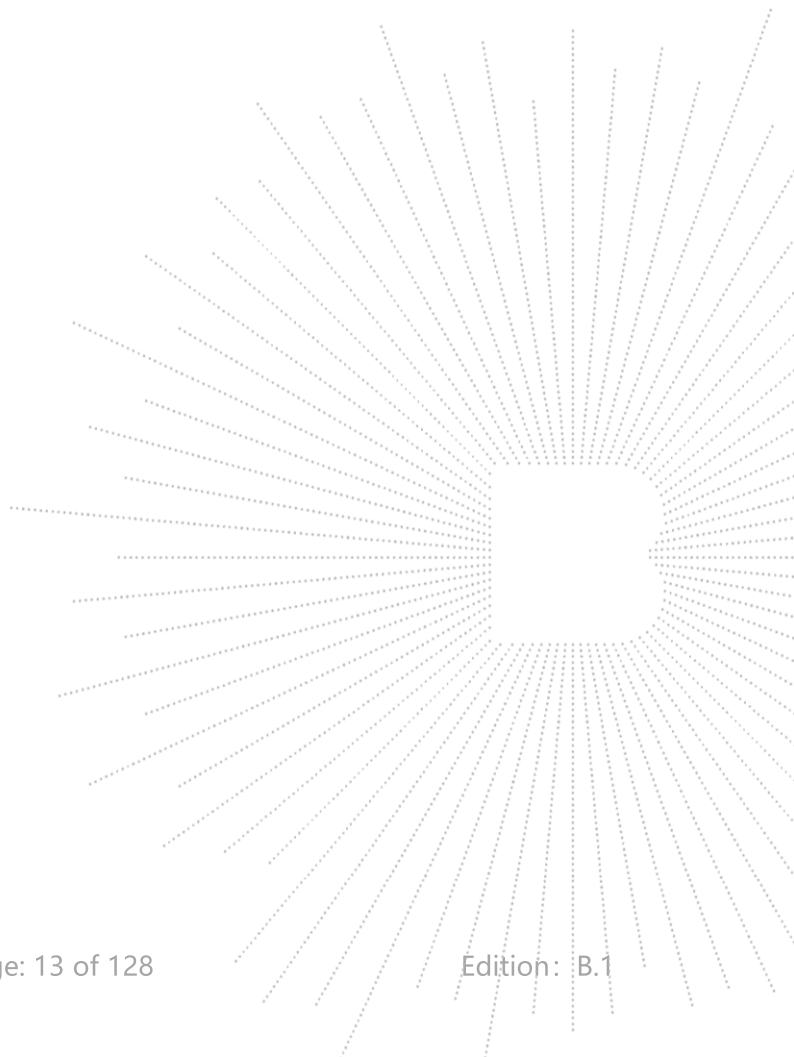

## 6. Conducted Emissions

### 6.1 Block Diagram Of Test Setup

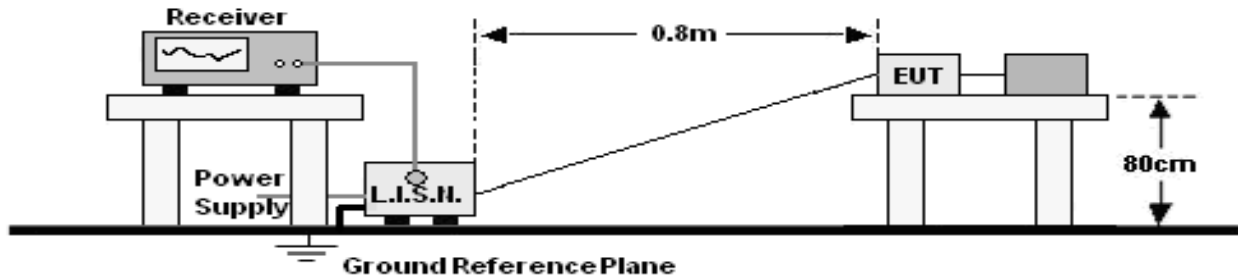

### 6.2 Limit

Frequency (MHz)	Limit (dBuV)	
	Quas-peak	Average
0.15 -0.5	66 - 56 *	56 - 46 *
0.50 -5.0	56.00	46.00
5.0 -30.0	60.00	50.00

Notes:  
 1. \*Decreasing linearly with logarithm of frequency.  
 2. The lower limit shall apply at the transition frequencies.

### 6.3 Test Procedure

Receiver Parameters	Setting
Attenuation	10 dB
Start Frequency	0.15 MHz
Stop Frequency	30 MHz
IF Bandwidth	9 kHz

- The Product was placed on a nonconductive table 0.8 m above the horizontal ground reference plane, and 0.4 m from the vertical ground reference plane, and connected to the main through Line Impedance Stability Network (L.I.S.N).
- The RBW of the receiver was set at 9 kHz in 150 kHz ~ 30MHz with Peak and AVG detector in Max Hold mode. Run the receiver's pre-scan to record the maximum disturbance generated from Product in all power lines in the full band.
- For each frequency whose maximum record was higher or close to limit, measure its QP and AVG values and record.

### 6.4 EUT Operating Conditions

The EUT was configured for testing in a typical fashion (as a customer would normally use it). The EUT has been programmed to continuously transmit during test. This operating condition was tested and used to collect the included data.

### 6.5 Test Result

Temperature:	26 °C	Relative Humidity:	54%
Pressure:	101KPa	Phase :	L
Test Mode:	Mode 2	Test Voltage :	AC120V/60Hz

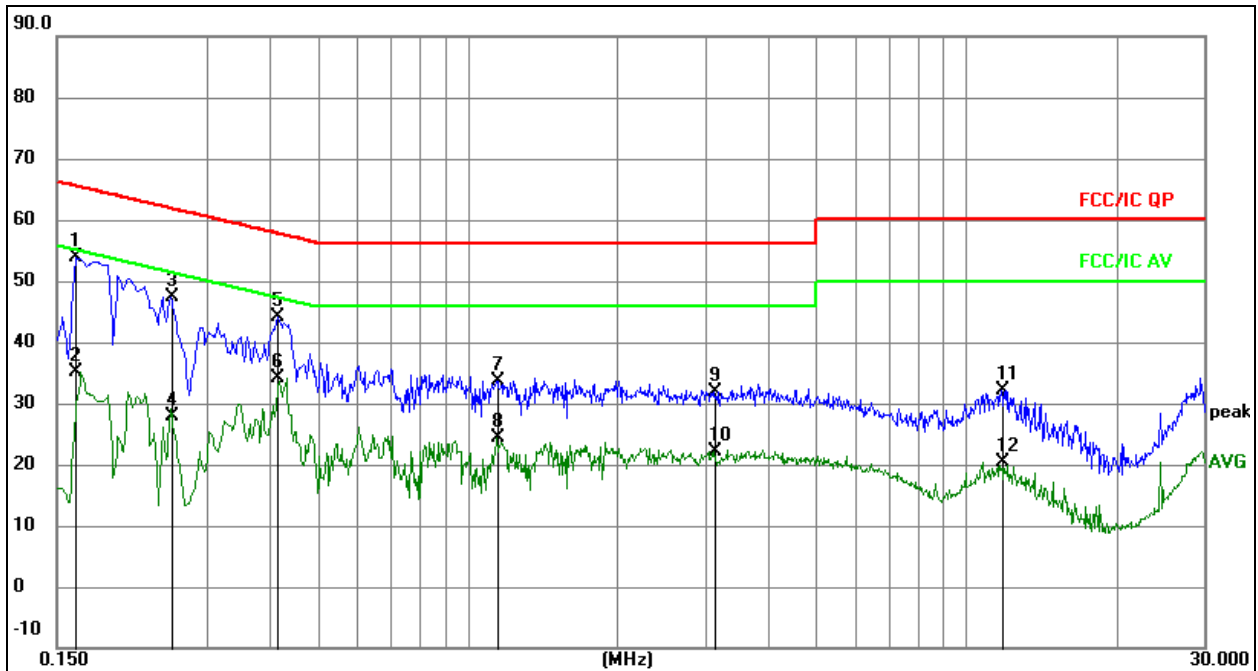
**Remark:**

1. All readings are Quasi-Peak and Average values.
2. Factor = Insertion Loss + Cable Loss.
3. Measurement=Reading Level+ Correct Factor
4. Over= Measurement-Limit

No.	Mk.	Freq. MHz	Reading Level	Correct Factor dB	Measure- ment dBuV	Limit dBuV	Over dB	Detector
1	*	0.1635	34.04	19.76	53.80	65.28	-11.48	QP
2		0.1635	15.33	19.76	35.09	55.28	-20.19	AVG
3		0.2535	27.54	19.83	47.37	61.64	-14.27	QP
4		0.2535	8.17	19.83	28.00	51.64	-23.64	AVG
5		0.4155	24.18	19.84	44.02	57.54	-13.52	QP
6		0.4155	14.18	19.84	34.02	47.54	-13.52	AVG
7		1.1490	13.72	19.95	33.67	56.00	-22.33	QP
8		1.1490	4.33	19.95	24.28	46.00	-21.72	AVG
9		3.1380	11.63	20.35	31.98	56.00	-24.02	QP
10		3.1380	1.75	20.35	22.10	46.00	-23.90	AVG
11		11.7780	12.15	19.88	32.03	60.00	-27.97	QP
12		11.7780	0.39	19.88	20.27	50.00	-29.73	AVG

Temperature:	26 °C	Relative Humidity:	54%
Pressure:	101KPa	Phase :	N
Test Mode:	Mode 2	Test Voltage :	AC120V/60Hz

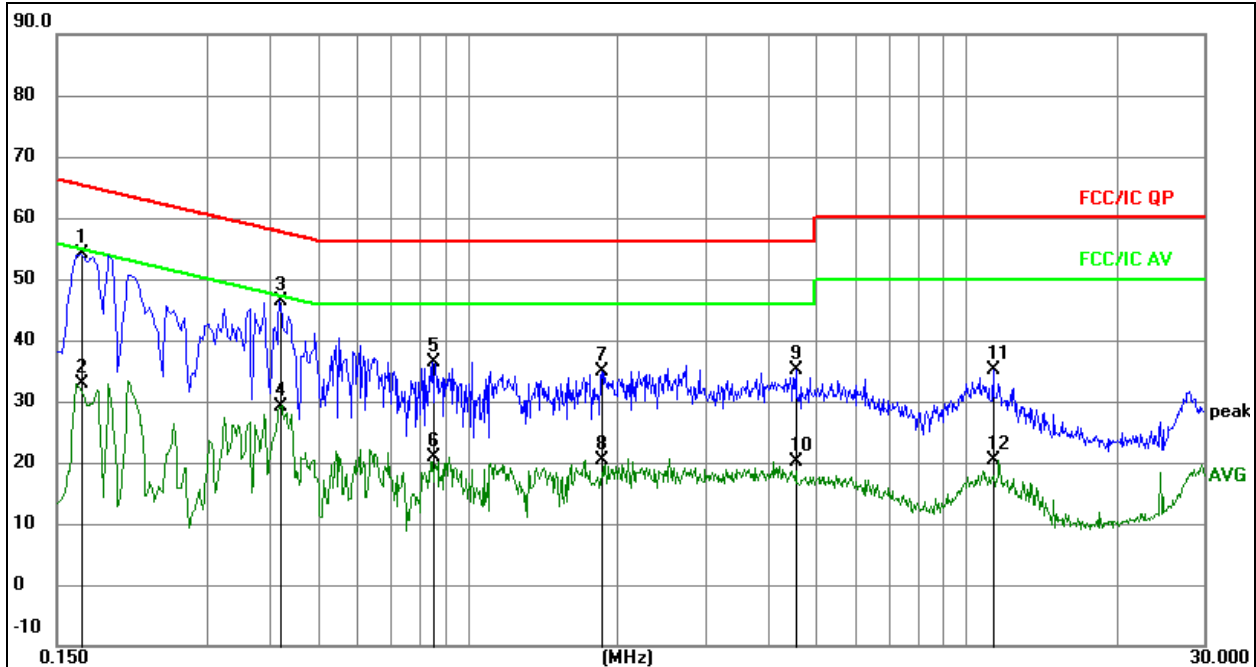
**Remark:**

1. All readings are Quasi-Peak and Average values.
2. Factor = Insertion Loss + Cable Loss.
3. Measurement=Reading Level+ Correct Factor
4. Over= Measurement-Limit

No.	Mk.	Freq. MHz	Reading Level	Correct Factor dB	Measure- ment dBuV	Limit dBuV	Over dB	Detector
1		0.1677	34.26	19.77	54.03	65.07	-11.04	QP
2		0.1677	13.17	19.77	32.94	55.07	-22.13	AVG
3	*	0.4193	26.58	19.84	46.42	57.46	-11.04	QP
4		0.4193	9.41	19.84	29.25	47.46	-18.21	AVG
5		0.8483	16.44	19.89	36.33	56.00	-19.67	QP
6		0.8483	1.04	19.89	20.93	46.00	-25.07	AVG
7		1.8581	14.88	19.95	34.83	56.00	-21.17	QP
8		1.8581	0.55	19.95	20.50	46.00	-25.50	AVG
9		4.5494	14.65	20.53	35.18	56.00	-20.82	QP
10		4.5494	-0.39	20.53	20.14	46.00	-25.86	AVG
11		11.3170	15.18	19.88	35.06	60.00	-24.94	QP
12		11.3170	0.54	19.88	20.42	50.00	-29.58	AVG



## 7. Radiated Emissions

### 7.1 Block Diagram Of Test Setup

(A) Radiated Emission Test-Up Frequency Below 30MHz

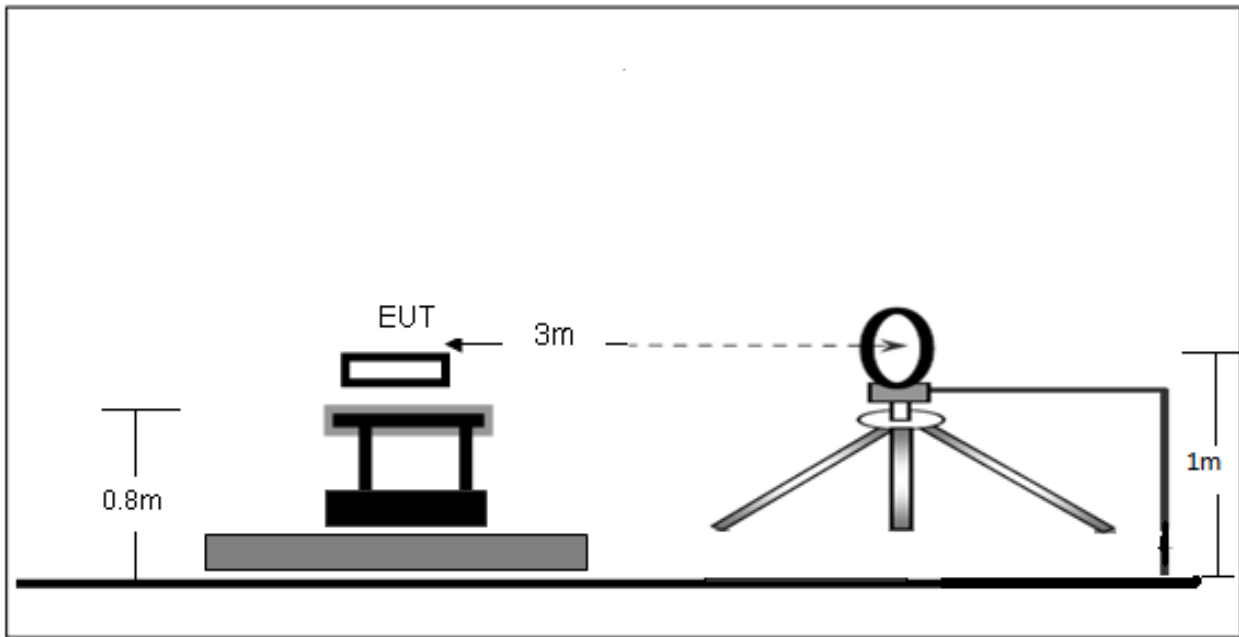

(B) Radiated Emission Test-Up Frequency 30MHz~1GHz

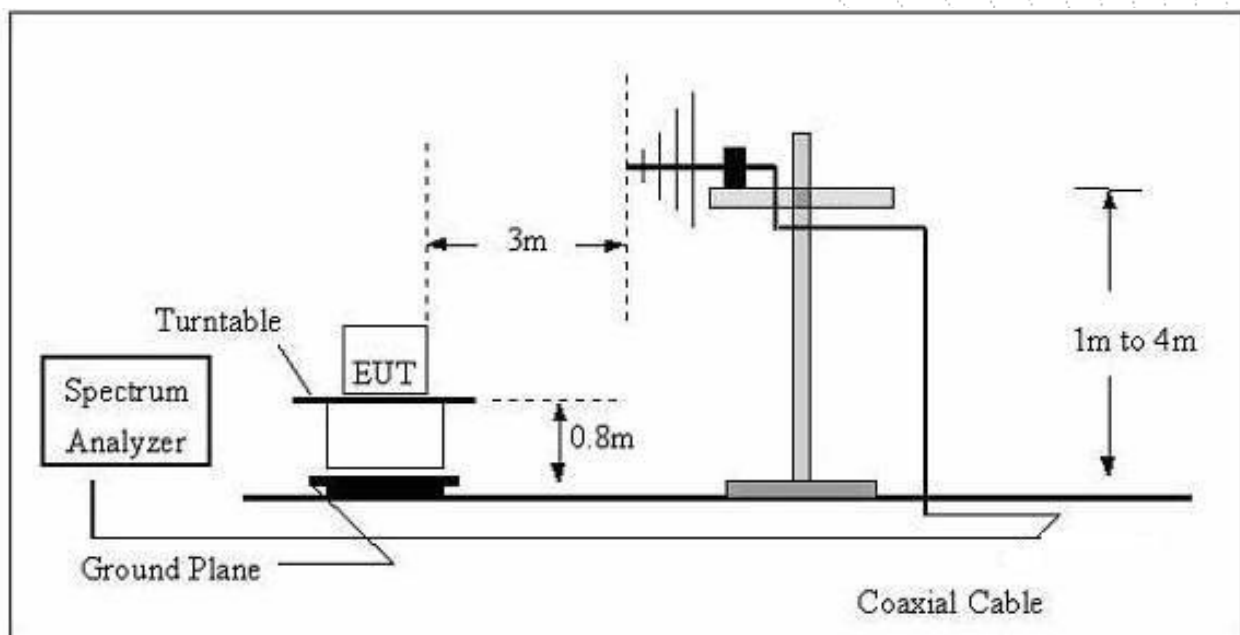

## (C) Radiated Emission Test-Up Frequency Above 1GHz

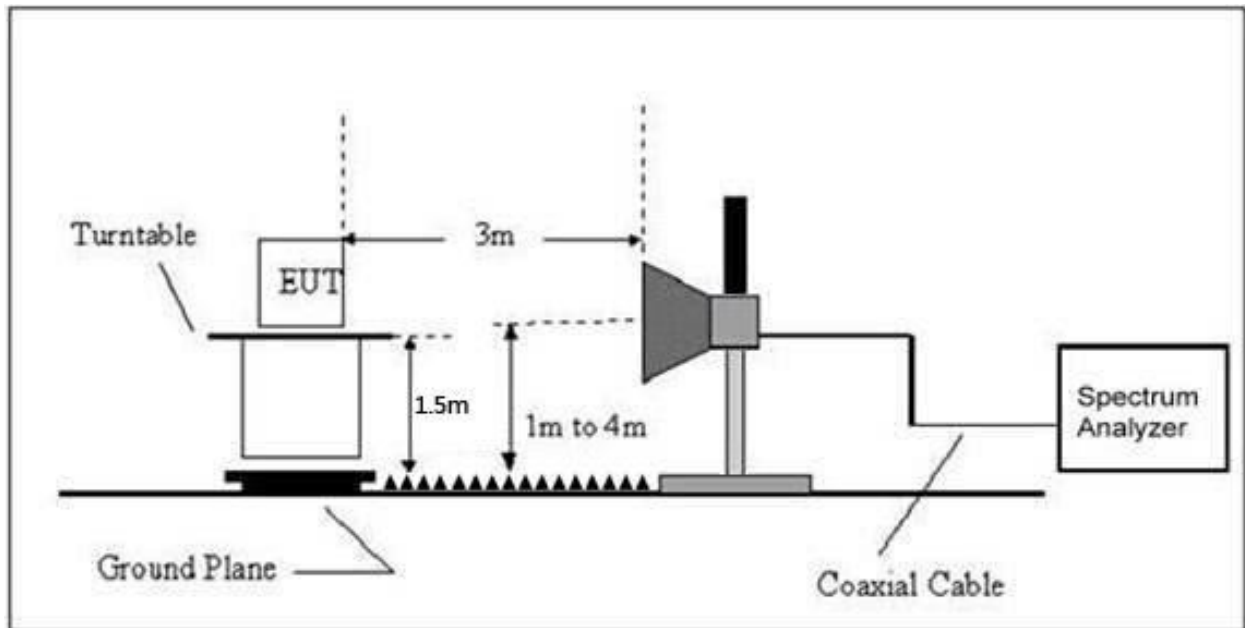

## 7.2 Limit

20dBc in any 100 kHz bandwidth outside the operating frequency band. In case the emission fall within the restricted band specified on 15.205(a), then the 15.209(a) limit in the table below has to be followed.

Frequency (MHz)	Field Strength uV/m	Distance (m)	Field Strength Limit at 3m Distance	
			uV/m	dBuV/m
0.009 ~ 0.490	2400/F(kHz)	300	10000 * 2400/F(kHz)	20log <sup>(2400/F(kHz))</sup> + 80
0.490 ~ 1.705	24000/F(kHz)	30	100 * 24000/F(kHz)	20log <sup>(24000/F(kHz))</sup> + 40
1.705 ~ 30	30	30	100 * 30	20log <sup>(30)</sup> + 40
30 ~ 88	100	3	100	20log <sup>(100)</sup>
88 ~ 216	150	3	150	20log <sup>(150)</sup>
216 ~ 960	200	3	200	20log <sup>(200)</sup>
Above 960	500	3	500	20log <sup>(500)</sup>

## Limits Of Radiated Emission Measurement (Above 1000MHz)

Frequency (MHz)	Limit (dBuV/m) (at 3M)	
	Peak	Average
Above 1000	74	54

## Notes:

- (1)The limit for radiated test was performed according to FCC PART 15C.
- (2)The tighter limit applies at the band edges.
- (3) Emission level (dBuV/m)=20log Emission level (uV/m).

### 7.3 Test Procedure

The test site semi-anechoic chamber has met the requirement of NSA tolerance 4 dB according to the standards: ANSI C63.10-2013. The test distance is 3m. The setup is according to the requirements in Section 13.1.4.1 of ANSI C63.10-2013 and CAN/CSA-CEI/IEC CISPR 22.

This test is required for any spurious emission that falls in a Restricted Band, as defined in Section 15.205. It must be performed with the highest gain of each type of antenna proposed for use with the EUT.

Use the following spectrum analyzer settings:

Spectrum Parameter	Setting
Attenuation	Auto
Start Frequency	1000 MHz
Stop Frequency	10th carrier harmonic
RB / VB (emission in restricted band)	1 MHz / 1 MHz for Peak, 1 MHz / 10Hz for Average

Receiver Parameter	Setting
Attenuation	Auto
Start ~ Stop Frequency	9kHz~150kHz / RB 200Hz for QP
Start ~ Stop Frequency	150kHz~30MHz / RB 9kHz for QP
Start ~ Stop Frequency	30MHz~1000MHz / RB 120kHz for QP

- The measuring distance of at 3 m shall be used for measurements at frequency up to 1GHz. For frequencies above 1GHz, any suitable measuring distance may be used.
- The EUT was placed on the top of a rotating table 0.8 m for below 1GHz and 1.5m for above 1GHz the ground at a 3 meter. The table was rotated 360 degrees to determine the position of the highest radiation.
- The height of the equipment or of the substitution antenna shall be 0.8 m for below 1GHz and 1.5m for above 1GHz; the height of the test antenna shall vary between 1 m to 4 m. Both horizontal and vertical polarizations of the antenna are set to make the measurement.
- The initial step in collecting conducted emission data is a spectrum analyzer peak detector mode pre-scanning the measurement frequency range. Significant peaks are then marked and then Quasi Peak detector mode re-measured.
- If the Peak Mode measured value compliance with and lower than Quasi Peak Mode Limit, the EUT shall be deemed to meet QP Limits and then no additional QP Mode measurement performed.
- For the actual test configuration, please refer to the related Item –EUT Test Photos.

Note:

Both horizontal and vertical antenna polarities were tested and performed pretest to three orthogonal axis. The worst case emissions were reported

During the radiated emission test, the Spectrum Analyzer was set with the following configurations:

Frequency Band (MHz)	Function	Resolution bandwidth	Video Bandwidth
30 to 1000	QP	120 kHz	300 kHz
Above 1000	Peak	1 MHz	1 MHz
	Average	1 MHz	10 Hz

Note: for the frequency ranges below 30 MHz, a narrower RBW is used for these ranges but the measured value should add a RBW correction factor (RBWCF) where  $RBWCF [dB] = 10 \cdot \lg(100 [kHz] / \text{narrower RBW} [kHz])$ . , the narrower RBW is 1 kHz and RBWCF is 20 dB for the frequency 9 kHz to 150 kHz, and the narrower RBW is 10 kHz and RBWCF is 10 dB for the frequency 150 kHz to 30 MHz.

## 7.4 EUT Operating Conditions

The EUT was configured for testing in a typical fashion (as a customer would normally use it). The EUT has been programmed to continuously transmit during test. This operating condition was tested and used to collect the included data.

## 7.5 Test Result

Below 30MHz

Temperature:	26°C	Relative Humidity:	24%
Pressure:	101 kPa	Test Voltage:	AC120V/60Hz
Test Mode:	Mode 2	Polarization:	--

Freq. (MHz)	Reading (dBuV/m)	Limit (dBuV/m)	Margin (dB)	State P/F
--	--	--	--	PASS
--	--	--	--	PASS

**Note:**

The amplitude of spurious emissions which are attenuated by more than 20dB below the permissible value has no need to be reported.

Distance extrapolation factor =  $40 \log(\text{specific distance/test distance})(\text{dB})$ ;

Limit line = specific limits(dBuv) + distance extrapolation factor.

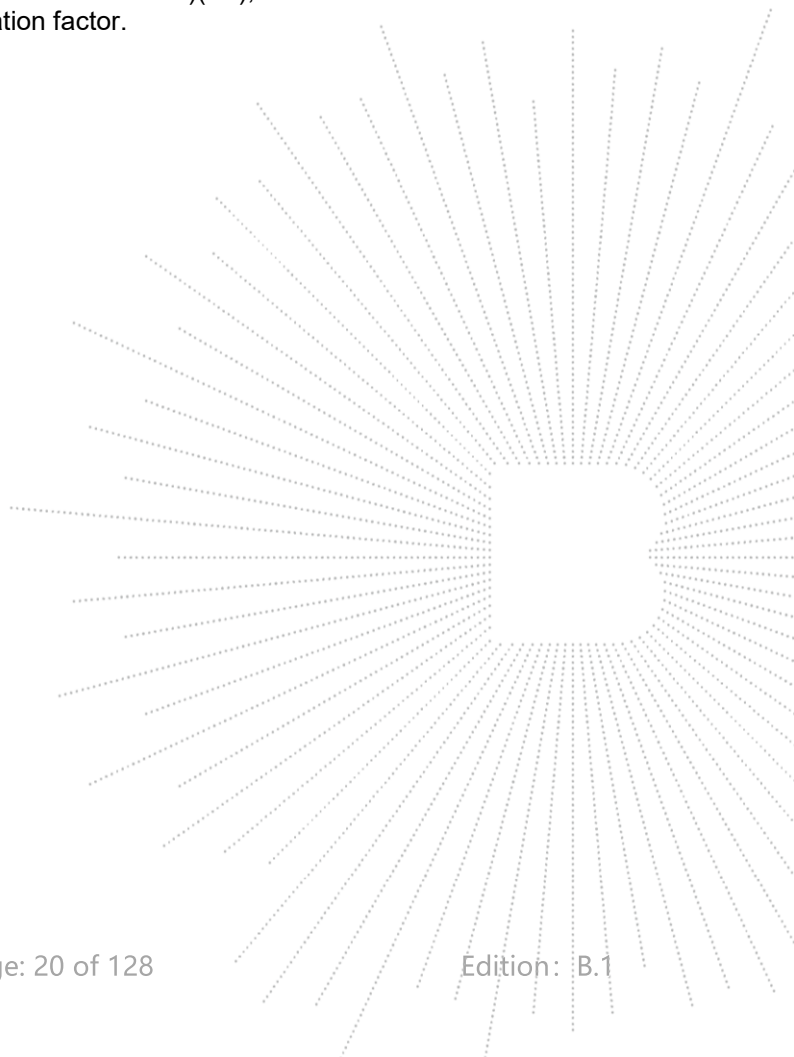

Between 30MHz – 1GHz

Temperature:	26 °C	Relative Humidity:	54%
Pressure:	101KPa	Phase :	Horizontal
Test Mode:	Mode 2	Test Voltage :	AC120V/60Hz

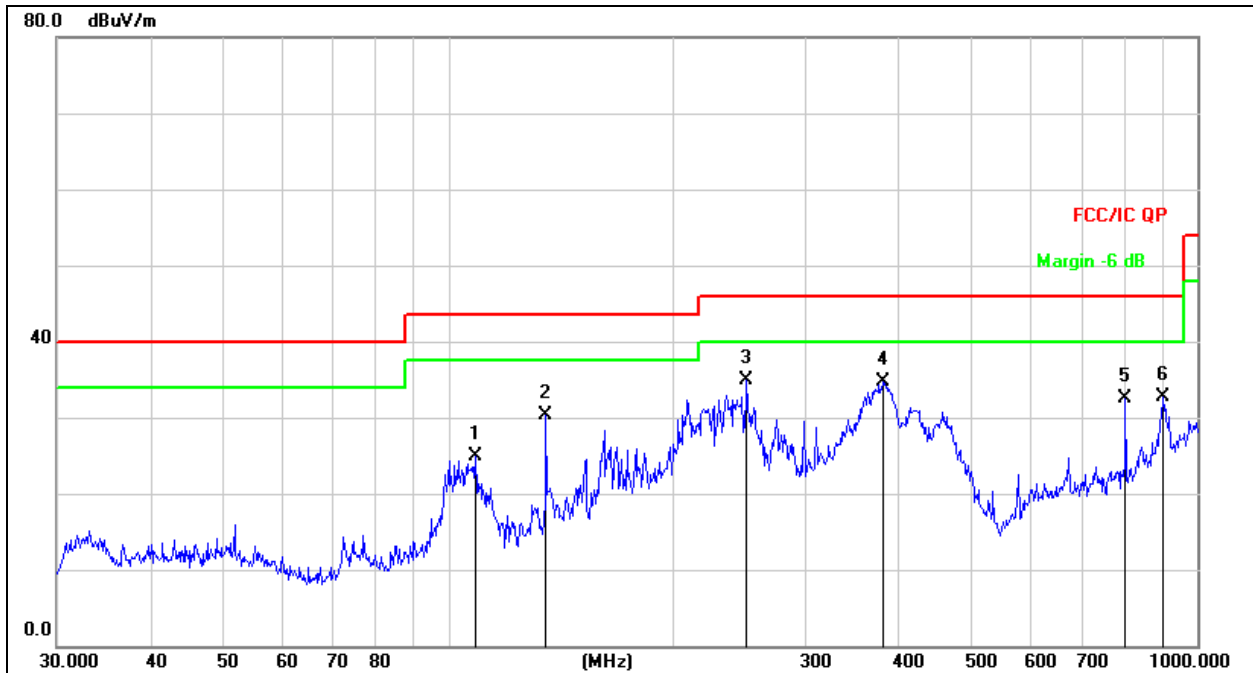

Remark:

1. Factor = Antenna Factor + Cable Loss – Pre-amplifier.
2. Measurement=Reading Level+ Correct Factor
3. Over= Measurement-Limit

No.	Mk.	Freq. MHz	Reading Level dBuV	Correct Factor dB	Measure- ment dBuV/m	Limit dB/m	Over dB	Detector
1		108.6470	41.54	-16.54	25.00	43.50	-18.50	QP
2		135.0319	48.70	-18.38	30.32	43.50	-13.18	QP
3	*	250.3012	49.23	-14.28	34.95	46.00	-11.05	QP
4		379.9141	45.75	-11.10	34.65	46.00	-11.35	QP
5		801.7863	36.84	-4.38	32.46	46.00	-13.54	QP
6		900.1474	35.89	-3.12	32.77	46.00	-13.23	QP

Temperature:	26 °C	Relative Humidity:	54%
Pressure:	101KPa	Phase :	Vertical
Test Mode:	Mode 2	Test Voltage :	AC120V/60Hz

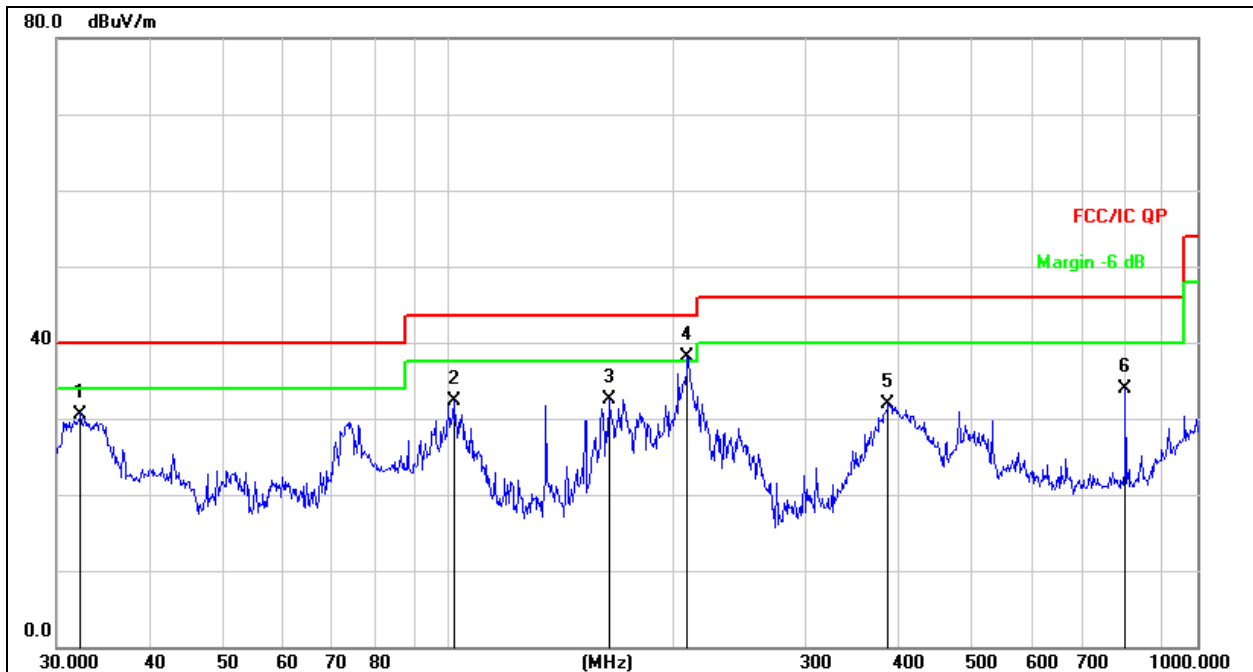
**Remark:**

1. Factor = Antenna Factor + Cable Loss – Pre-amplifier.
2. Measurement=Reading Level+ Correct Factor
3. Over= Measurement-Limit

No.	Mk.	Freq. MHz	Reading Level dBuV	Correct Factor dB	Measure- ment dBuV/m	Limit dB/m	Over dB	Detector
1		32.2925	46.81	-16.21	30.60	40.00	-9.40	QP
2		101.6443	48.44	-16.05	32.39	43.50	-11.11	QP
3		164.3301	50.94	-18.37	32.57	43.50	-10.93	QP
4	*	208.5803	53.59	-15.47	38.12	43.50	-5.38	QP
5		386.6338	42.93	-11.01	31.92	46.00	-14.08	QP
6		801.7863	38.33	-4.38	33.95	46.00	-12.05	QP

Between 1GHz – 40GHz

Test Mode:	TX(5.1G) - 802.11a
------------	--------------------

Polar (H/V)	Frequency (MHz)	Reading Level (dBuV/m)	Correct Factor (dB)	Measure- ment (dBuV/m)	Limits (dBuV/m)	Over (dB)	Detector Type
Low Channel (5180 MHz)-Above 1G							
Vertical	4434.08	71.57	-20.73	50.84	68.20	-17.36	PK
Vertical	4434.08	59.43	-20.73	38.70	54.00	-15.30	AV
Vertical	10360.17	61.54	-9.36	52.18	68.20	-16.02	PK
Vertical	10360.17	49.51	-9.36	40.15	54.00	-13.85	AV
Vertical	15540.16	62.73	-7.84	54.89	74.00	-19.11	PK
Vertical	15540.16	49.78	-7.84	41.94	54.00	-12.06	AV
Horizontal	4434.07	70.67	-20.73	49.94	68.20	-18.26	PK
Horizontal	4434.07	59.21	-20.73	38.48	54.00	-15.52	AV
Horizontal	10360.00	64.79	-9.36	55.43	68.20	-12.77	PK
Horizontal	10360.00	49.32	-9.36	39.96	54.00	-14.04	AV
Horizontal	15540.05	63.35	-7.84	55.51	74.00	-18.49	PK
Horizontal	15540.05	49.72	-7.84	41.88	54.00	-12.12	AV
Middle Channel (5200 MHz)-Above 1G							
Vertical	4592.01	74.82	-20.42	54.40	74.00	-19.60	PK
Vertical	4592.01	59.31	-20.42	38.89	54.00	-15.11	AV
Vertical	10400.04	63.81	-9.30	54.51	68.20	-13.69	PK
Vertical	10400.04	49.76	-9.30	40.46	54.00	-13.54	AV
Vertical	15600.19	60.52	-7.82	52.70	74.00	-21.30	PK
Vertical	15600.19	49.07	-7.82	41.25	54.00	-12.75	AV
Horizontal	4592.08	74.83	-20.42	54.41	74.00	-19.59	PK
Horizontal	4592.08	59.29	-20.42	38.87	54.00	-15.13	AV
Horizontal	10400.09	60.17	-9.30	50.87	68.20	-17.33	PK
Horizontal	10400.09	49.06	-9.30	39.76	54.00	-14.24	AV
Horizontal	15600.14	64.56	-7.82	56.74	74.00	-17.26	PK
Horizontal	15600.14	49.88	-7.82	42.06	54.00	-11.94	AV
High Channel (5240 MHz)-Above 1G							
Vertical	4739.18	71.92	-20.12	51.80	74.00	-22.20	PK
Vertical	4739.18	59.84	-20.12	39.71	54.00	-14.29	AV
Vertical	10480.03	60.29	-9.18	51.11	68.20	-17.09	PK
Vertical	10480.03	49.15	-9.18	39.97	54.00	-14.03	AV
Vertical	15720.14	61.51	-7.78	53.73	74.00	-20.27	PK
Vertical	15720.14	49.65	-7.78	41.87	54.00	-12.13	AV
Horizontal	4739.11	70.12	-20.12	50.00	74.00	-24.00	PK
Horizontal	4739.11	59.82	-20.12	39.70	54.00	-14.30	AV
Horizontal	10480.19	60.40	-9.18	51.22	68.20	-16.98	PK
Horizontal	10480.19	49.77	-9.18	40.59	54.00	-13.41	AV
Horizontal	15720.05	64.19	-7.78	56.41	74.00	-17.59	PK
Horizontal	15720.05	49.71	-7.78	41.93	54.00	-12.07	AV

Note: PK value is lower than the Average value limit, So average didn't record.  
 The 26.5-40G amplitude of spurious emissions that are attenuated by more than 20dB below the permissible value has no need to be reported.  
 Emission level (dBuV/m) = 20 log Emission level (uV/m).  
 Corrected Reading: Antenna Factor + Cable Loss + Read Level - Preamp Factor = Level.  
 The worst case is Antenna A

Test Mode:	TX(5.1G) - 802.11n-HT20
------------	-------------------------

Polar	Frequency	Reading Level	Correct Factor	Measurement	Limits	Over	Detector Type
(H/V)	(MHz)	(dBuV/m)	(dB)	(dBuV/m)	(dBuV/m)	(dB)	
Low Channel (5180 MHz)-Above 1G							
Vertical	4434.06	74.92	-20.73	54.19	68.20	-14.01	PK
Vertical	4434.06	59.69	-20.73	38.95	54.00	-15.05	AV
Vertical	10360.03	63.69	-9.36	54.33	68.20	-13.87	PK
Vertical	10360.03	49.29	-9.36	39.93	54.00	-14.07	AV
Vertical	15540.02	60.97	-7.84	53.13	74.00	-20.87	PK
Vertical	15540.02	49.76	-7.84	41.92	54.00	-12.08	AV
Horizontal	4434.20	74.66	-20.73	53.93	68.20	-14.27	PK
Horizontal	4434.20	59.60	-20.73	38.87	54.00	-15.13	AV
Horizontal	10360.01	60.40	-9.36	51.04	68.20	-17.16	PK
Horizontal	10360.01	49.33	-9.36	39.97	54.00	-14.03	AV
Horizontal	15540.16	60.09	-7.84	52.25	74.00	-21.75	PK
Horizontal	15540.16	49.45	-7.84	41.61	54.00	-12.39	AV
Middle Channel (5200 MHz)-Above 1G							
Vertical	4592.09	71.15	-20.42	50.73	74.00	-23.27	PK
Vertical	4592.09	59.49	-20.42	39.08	54.00	-14.92	AV
Vertical	10400.08	64.97	-9.30	55.67	68.20	-12.53	PK
Vertical	10400.08	49.24	-9.30	39.94	54.00	-14.06	AV
Vertical	15600.14	62.87	-7.82	55.05	74.00	-18.95	PK
Vertical	15600.14	49.72	-7.82	41.90	54.00	-12.10	AV
Horizontal	4592.03	71.13	-20.42	50.71	74.00	-23.29	PK
Horizontal	4592.03	59.23	-20.42	38.81	54.00	-15.19	AV
Horizontal	10400.14	60.19	-9.30	50.89	68.20	-17.31	PK
Horizontal	10400.14	49.77	-9.30	40.47	54.00	-13.53	AV
Horizontal	15600.06	64.86	-7.82	57.04	74.00	-16.96	PK
Horizontal	15600.06	49.76	-7.82	41.94	54.00	-12.06	AV
High Channel (5240 MHz)-Above 1G							
Vertical	4739.19	74.39	-20.12	54.27	74.00	-19.73	PK
Vertical	4739.19	59.91	-20.12	39.78	54.00	-14.22	AV
Vertical	10480.07	63.55	-9.18	54.37	68.20	-13.83	PK
Vertical	10480.07	49.88	-9.18	40.70	54.00	-13.30	AV
Vertical	15720.00	61.60	-7.78	53.82	74.00	-20.18	PK
Vertical	15720.00	50.00	-7.78	42.22	54.00	-11.78	AV
Horizontal	4739.10	73.96	-20.12	53.84	74.00	-20.16	PK
Horizontal	4739.10	59.24	-20.12	39.12	54.00	-14.88	AV
Horizontal	10480.02	63.33	-9.18	54.15	68.20	-14.05	PK
Horizontal	10480.02	49.75	-9.18	40.57	54.00	-13.43	AV
Horizontal	15720.01	63.38	-7.78	55.60	74.00	-18.40	PK
Horizontal	15720.01	49.40	-7.78	41.62	54.00	-12.38	AV

Note: PK value is lower than the Average value limit, So average didn't record.

The 26.5-40G amplitude of spurious emissions that are attenuated by more than 20dB below the permissible value has no need to be reported.

Emission level (dBuV/m) = 20 log Emission level (uV/m).

Corrected Reading: Antenna Factor + Cable Loss + Read Level - Preamp Factor = Level.

Test Mode is MIMO Mode.



Test Mode:	TX(5.1G) - 802.11n-HT40
------------	-------------------------

Polar (H/V)	Frequency (MHz)	Reading Level (dBuV/m)	Correct Factor (dB)	Measurement (dBuV/m)	Limits (dBuV/m)	Over (dB)	Detector Type
Low Channel (5190 MHz)-Above 1G							
Vertical	4434.18	71.06	-20.73	50.33	68.20	-17.87	PK
Vertical	4434.18	59.30	-20.73	38.56	54.00	-15.44	AV
Vertical	10380.19	62.98	-9.33	53.65	68.20	-14.55	PK
Vertical	10380.19	49.43	-9.33	40.10	54.00	-13.90	AV
Vertical	15570.12	62.29	-7.83	54.46	74.00	-19.54	PK
Vertical	15570.12	49.10	-7.83	41.27	54.00	-12.73	AV
Horizontal	4434.11	74.38	-20.73	53.65	74.00	-20.35	PK
Horizontal	4434.11	59.89	-20.73	39.16	54.00	-14.84	AV
Horizontal	10380.03	60.27	-9.33	50.94	68.20	-17.26	PK
Horizontal	10380.03	49.91	-9.33	40.58	54.00	-13.42	AV
Horizontal	15570.04	63.23	-7.83	55.40	74.00	-18.60	PK
Horizontal	15570.04	49.49	-7.83	41.66	54.00	-12.34	AV
Middle Channel (5230 MHz)-Above 1G							
Vertical	4739.13	71.25	-20.12	51.13	68.20	-17.07	PK
Vertical	4739.13	59.06	-20.12	38.94	54.00	-15.06	AV
Vertical	10460.16	62.87	-9.21	53.66	68.20	-14.54	PK
Vertical	10460.16	49.89	-9.21	40.68	54.00	-13.32	AV
Vertical	15690.07	60.48	-7.79	52.69	74.00	-21.31	PK
Vertical	15690.07	49.95	-7.79	42.16	54.00	-11.84	AV
Horizontal	4739.11	71.77	-20.12	51.64	68.20	-16.56	PK
Horizontal	4739.11	59.76	-20.12	39.64	54.00	-14.36	AV
Horizontal	10460.11	60.85	-9.21	51.64	68.20	-16.56	PK
Horizontal	10460.11	49.64	-9.21	40.43	54.00	-13.57	AV
Horizontal	15690.05	61.57	-7.79	53.78	74.00	-20.22	PK
Horizontal	15690.05	49.91	-7.79	42.12	54.00	-11.88	AV

Note: PK value is lower than the Average value limit, So average didn't record.

The 26.5-40G amplitude of spurious emissions that are attenuated by more than 20dB below the permissible value has no need to be reported.

Emission level (dBuV/m) = 20 log Emission level (uV/m).

Corrected Reading: Antenna Factor + Cable Loss + Read Level - Preamp Factor = Level.

Test Mode is MIMO Mode.

Test Mode:	TX(5.1G) - 802.11ac-HT20
------------	--------------------------

Polar (H/V)	Frequency (MHz)	Reading Level (dBuV/m)	Correct Factor (dB)	Measurement (dBuV/m)	Limits (dBuV/m)	Over (dB)	Detector Type
Low Channel (5180 MHz)-Above 1G							
Vertical	4434.15	71.94	-20.73	51.21	68.20	-16.99	PK
Vertical	4434.15	59.80	-20.73	39.07	54.00	-14.93	AV
Vertical	10360.15	64.25	-9.36	54.89	68.20	-13.31	PK
Vertical	10360.15	49.67	-9.36	40.31	54.00	-13.69	AV
Vertical	15540.09	62.93	-7.84	55.09	74.00	-18.91	PK
Vertical	15540.09	49.01	-7.84	41.17	54.00	-12.83	AV
Horizontal	4434.08	74.11	-20.73	53.38	68.20	-14.82	PK
Horizontal	4434.08	59.17	-20.73	38.44	54.00	-15.56	AV
Horizontal	10360.09	63.59	-9.36	54.23	68.20	-13.97	PK
Horizontal	10360.09	49.25	-9.36	39.89	54.00	-14.11	AV
Horizontal	15540.02	61.67	-7.84	53.83	74.00	-20.17	PK
Horizontal	15540.02	49.92	-7.84	42.08	54.00	-11.92	AV
Middle Channel (5200 MHz)-Above 1G							
Vertical	4592.17	72.63	-20.42	52.22	74.00	-21.78	PK
Vertical	4592.17	59.49	-20.42	39.07	54.00	-14.93	AV
Vertical	10400.16	60.41	-9.30	51.11	68.20	-17.09	PK
Vertical	10400.16	49.02	-9.30	39.72	54.00	-14.28	AV
Vertical	15600.15	60.43	-7.82	52.61	74.00	-21.39	PK
Vertical	15600.15	49.78	-7.82	41.96	54.00	-12.04	AV
Horizontal	4592.01	74.69	-20.42	54.27	74.00	-19.73	PK
Horizontal	4592.01	59.43	-20.42	39.02	54.00	-14.98	AV
Horizontal	10400.11	60.65	-9.30	51.35	68.20	-16.85	PK
Horizontal	10400.11	49.98	-9.30	40.68	54.00	-13.32	AV
Horizontal	15600.09	60.47	-7.82	52.65	74.00	-21.35	PK
Horizontal	15600.09	49.96	-7.82	42.14	54.00	-11.86	AV
High Channel (5240 MHz)-Above 1G							
Vertical	4739.19	72.12	-20.12	51.99	74.00	-22.01	PK
Vertical	4739.19	59.54	-20.12	39.42	54.00	-14.58	AV
Vertical	10480.02	64.65	-9.18	55.47	68.20	-12.73	PK
Vertical	10480.02	49.71	-9.18	40.53	54.00	-13.47	AV
Vertical	15720.14	61.34	-7.78	53.56	74.00	-20.44	PK
Vertical	15720.14	49.76	-7.78	41.98	54.00	-12.02	AV
Horizontal	4739.17	70.80	-20.12	50.68	74.00	-23.32	PK
Horizontal	4739.17	59.59	-20.12	39.47	54.00	-14.53	AV
Horizontal	10480.10	63.17	-9.18	53.99	68.20	-14.21	PK
Horizontal	10480.10	49.75	-9.18	40.57	54.00	-13.43	AV
Horizontal	15720.05	62.41	-7.78	54.63	74.00	-19.37	PK
Horizontal	15720.05	49.85	-7.78	42.07	54.00	-11.93	AV

Note: PK value is lower than the Average value limit, So average didn't record.  
 The 26.5-40G amplitude of spurious emissions that are attenuated by more than 20dB below the permissible value has no need to be reported.  
 Emission level (dBuV/m) = 20 log Emission level (uV/m).  
 Corrected Reading: Antenna Factor + Cable Loss + Read Level - Preamp Factor = Level.  
 Test Mode is MIMO Mode.

Test Mode:	TX(5.1G) - 802.11ac-HT40
------------	--------------------------

Polar (H/V)	Frequency (MHz)	Reading Level (dBuV/m)	Correct Factor (dB)	Measurement (dBuV/m)	Limits (dBuV/m)	Over (dB)	Detector Type
Low Channel (5190 MHz)-Above 1G							
Vertical	4434.02	70.55	-20.73	49.82	68.20	-18.38	PK
Vertical	4434.02	59.79	-20.73	39.06	54.00	-14.94	AV
Vertical	10380.08	62.55	-9.33	53.22	68.20	-14.98	PK
Vertical	10380.08	49.70	-9.33	40.37	54.00	-13.63	AV
Vertical	15570.17	61.32	-7.83	53.49	74.00	-20.51	PK
Vertical	15570.17	49.09	-7.83	41.26	54.00	-12.74	AV
Horizontal	4434.05	72.99	-20.73	52.25	74.00	-21.75	PK
Horizontal	4434.05	59.06	-20.73	38.33	54.00	-15.67	AV
Horizontal	10380.19	60.07	-9.33	50.74	68.20	-17.46	PK
Horizontal	10380.19	49.55	-9.33	40.22	54.00	-13.78	AV
Horizontal	15570.10	63.86	-7.83	56.03	74.00	-17.97	PK
Horizontal	15570.10	49.99	-7.83	42.16	54.00	-11.84	AV
Middle Channel (5230 MHz)-Above 1G							
Vertical	4739.16	73.95	-20.12	53.83	68.20	-14.37	PK
Vertical	4739.16	59.89	-20.12	39.77	54.00	-14.23	AV
Vertical	10460.11	63.74	-9.21	54.53	68.20	-13.67	PK
Vertical	10460.11	49.05	-9.21	39.84	54.00	-14.16	AV
Vertical	15690.20	62.11	-7.79	54.32	74.00	-19.68	PK
Vertical	15690.20	49.39	-7.79	41.60	54.00	-12.40	AV
Horizontal	4739.18	73.18	-20.12	53.06	68.20	-15.14	PK
Horizontal	4739.18	59.01	-20.12	38.89	54.00	-15.11	AV
Horizontal	10460.00	61.13	-9.21	51.92	68.20	-16.28	PK
Horizontal	10460.00	49.97	-9.21	40.76	54.00	-13.24	AV
Horizontal	15690.14	60.70	-7.79	52.91	74.00	-21.09	PK
Horizontal	15690.14	49.98	-7.79	42.19	54.00	-11.81	AV

Note: PK value is lower than the Average value limit, So average didn't record.

The 26.5-40G amplitude of spurious emissions that are attenuated by more than 20dB below the permissible value has no need to be reported.

Emission level (dBuV/m) = 20 log Emission level (uV/m).

Corrected Reading: Antenna Factor + Cable Loss + Read Level - Preamp Factor = Level.

Test Mode is MIMO Mode.

Test Mode:	TX(5.1G) - 802.11ac 80
------------	------------------------

Polar (H/V)	Frequency (MHz)	Reading Level (dBuV/m)	Correct Factor (dB)	Measurement (dBuV/m)	Limits (dBuV/m)	Over (dB)	Detector Type
Low Channel (5210 MHz)-Above 1G							
Vertical	4434.15	73.70	-20.73	52.96	68.20	-15.24	PK
Vertical	4434.15	59.19	-20.73	38.46	54.00	-15.54	AV
Vertical	10420.16	61.05	-9.27	51.78	68.20	-16.42	PK
Vertical	10420.16	49.44	-9.27	40.17	54.00	-13.83	AV
Vertical	15630.13	62.18	-7.81	54.37	74.00	-19.63	PK
Vertical	15630.13	49.56	-7.81	41.75	54.00	-12.25	AV
Horizontal	4434.08	71.65	-20.73	50.91	68.20	-17.29	PK
Horizontal	4434.08	49.12	-20.73	28.39	54.00	-25.61	AV
Horizontal	10420.07	43.09	9.27	52.36	68.20	-15.84	PK
Horizontal	10420.07	29.22	9.27	38.49	54.00	-15.51	AV
Horizontal	15630.13	63.84	-7.81	56.03	74.00	-17.97	PK
Horizontal	15630.13	49.79	-7.81	41.98	54.00	-12.02	AV

Note: PK value is lower than the Average value limit, So average didn't record.  
 The 26.5-40G amplitude of spurious emissions that are attenuated by more than 20dB below the permissible value has no need to be reported.  
 Emission level (dBuV/m) = 20 log Emission level (uV/m).  
 Corrected Reading: Antenna Factor + Cable Loss + Read Level - Preamp Factor = Level.  
 Test Mode is MIMO Mode.

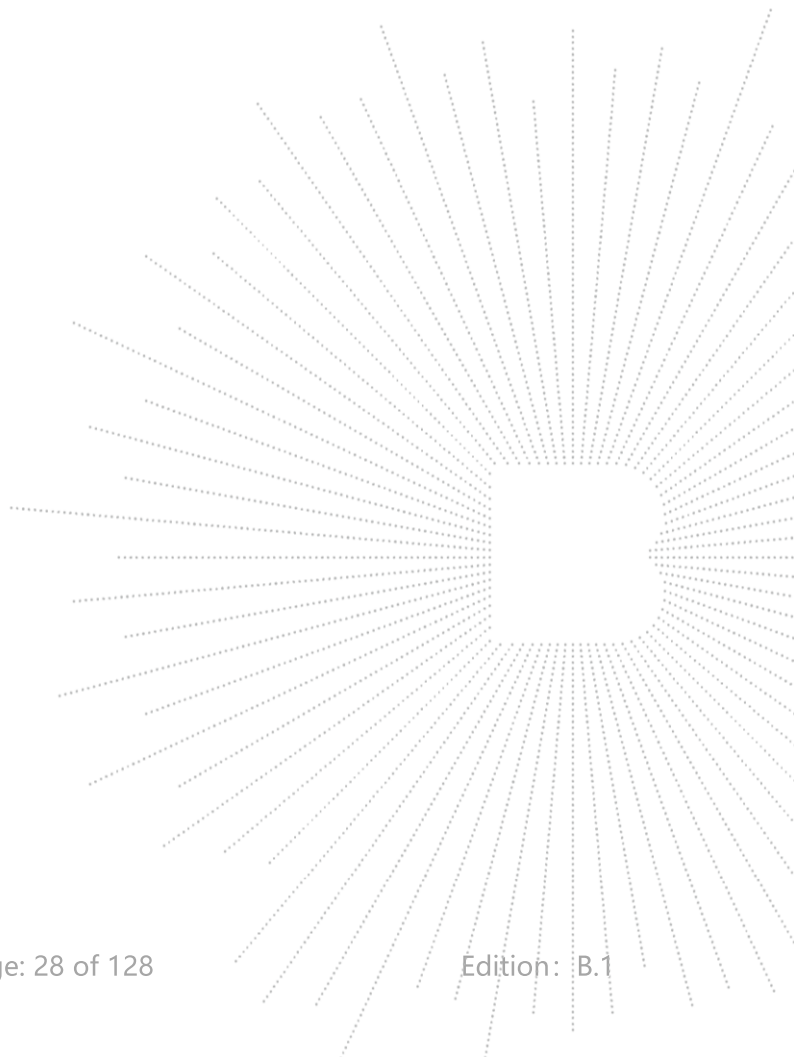

Test Mode:	TX (5.8G) -- 802.11a
------------	----------------------

Polar	Frequency	Reading Level	Correct Factor	Measurement	Limits	Over	Detector Type
(H/V)	(MHz)	(dBuV/m)	(dB)	(dBuV/m)	(dBuV/m)	(dB)	
Low Channel (5745 MHz)-Above 1G							
Vertical	4679.12	72.10	-20.24	51.86	74.00	-22.14	PK
Vertical	4679.12	59.78	-20.24	39.54	54.00	-14.46	AV
Vertical	11490.02	64.91	-8.79	56.12	68.20	-12.08	PK
Vertical	11490.02	49.65	-8.79	40.86	54.00	-13.14	AV
Vertical	17235.19	56.02	-3.18	52.84	68.20	-15.36	PK
Vertical	17235.19	44.07	-3.18	40.89	54.00	-13.11	AV
Horizontal	4679.13	74.38	-20.73	53.65	74.00	-20.35	PK
Horizontal	4679.13	59.15	-20.73	38.42	54.00	-15.58	AV
Horizontal	11490.10	64.14	-8.79	55.35	68.20	-12.85	PK
Horizontal	11490.10	49.91	-8.79	41.12	54.00	-12.88	AV
Horizontal	17235.09	58.64	-3.18	55.46	68.20	-12.74	PK
Horizontal	17235.09	44.10	-3.18	40.92	54.00	-13.08	AV
Middle Channel (5785 MHz)-Above 1G							
Vertical	4592.01	71.16	-20.42	50.74	74.00	-23.26	PK
Vertical	4592.01	59.16	-20.42	38.74	54.00	-15.26	AV
Vertical	11570.08	63.05	-8.86	54.19	68.20	-14.01	PK
Vertical	11570.08	49.11	-8.86	40.25	54.00	-13.75	AV
Vertical	17355.15	59.07	-2.52	56.55	68.20	-11.65	PK
Vertical	17355.15	44.23	-2.52	41.71	54.00	-12.29	AV
Horizontal	4592.10	72.15	-20.42	51.73	74.00	-22.27	PK
Horizontal	4592.10	59.74	-20.42	39.33	54.00	-14.67	AV
Horizontal	11570.06	64.26	-8.86	55.40	68.20	-12.80	PK
Horizontal	11570.06	49.07	-8.86	40.21	54.00	-13.79	AV
Horizontal	17355.10	58.14	-2.52	55.62	68.20	-12.58	PK
Horizontal	17355.10	44.57	-2.52	42.05	54.00	-11.95	AV
High Channel (5825 MHz)-Above 1G							
Vertical	6039.15	71.18	-18.93	52.25	68.20	-15.95	PK
Vertical	6039.15	59.65	-18.93	40.72	54.00	-13.28	AV
Vertical	11650.18	64.83	-8.92	55.91	74.00	-18.09	PK
Vertical	11650.18	49.84	-8.92	40.92	54.00	-13.08	AV
Vertical	17475.04	55.17	-1.86	53.31	68.20	-14.89	PK
Vertical	17475.04	44.03	-1.86	42.17	54.00	-11.83	AV
Horizontal	6039.09	70.93	-18.93	51.99	68.20	-16.21	PK
Horizontal	6039.09	59.27	-18.93	40.33	54.00	-13.67	AV
Horizontal	11650.04	64.69	-8.92	55.77	74.00	-18.23	PK
Horizontal	11650.04	49.66	-8.92	40.74	54.00	-13.26	AV
Horizontal	17475.11	57.73	-1.86	55.87	68.20	-12.33	PK
Horizontal	17475.11	44.40	-1.86	42.54	54.00	-11.46	AV

Note: PK value is lower than the Average value limit, So average didn't record.  
 The 26.5-40G amplitude of spurious emissions that are attenuated by more than 20dB below the permissible value has no need to be reported.  
 Emission level (dBuV/m) = 20 log Emission level (uV/m).  
 Corrected Reading: Antenna Factor + Cable Loss + Read Level - Preamp Factor = Level.  
 The worst case is Antenna A

Test Mode:	TX (5.8G) --802.11n-HT20
------------	--------------------------

Polar	Frequency	Reading Level	Correct Factor	Measurement	Limits	Over	Detector Type
(H/V)	(MHz)	(dBuV/m)	(dB)	(dBuV/m)	(dBuV/m)	(dB)	
Low Channel (5745 MHz)-Above 1G							
Vertical	4679.12	72.48	-20.24	52.24	74.00	-21.76	PK
Vertical	4679.12	59.87	-20.24	39.63	54.00	-14.37	AV
Vertical	11490.06	64.28	-8.79	55.49	68.20	-12.71	PK
Vertical	11490.06	49.18	-8.79	40.39	54.00	-13.61	AV
Vertical	17235.20	56.51	-3.18	53.33	68.20	-14.87	PK
Vertical	17235.20	44.43	-3.18	41.25	54.00	-12.75	AV
Horizontal	4679.03	72.49	-20.24	52.25	74.00	-21.75	PK
Horizontal	4679.03	59.76	-20.24	39.52	54.00	-14.48	AV
Horizontal	11490.13	60.97	-8.79	52.18	68.20	-16.02	PK
Horizontal	11490.13	49.30	-8.79	40.51	54.00	-13.49	AV
Horizontal	17235.10	58.47	-3.18	55.29	68.20	-12.91	PK
Horizontal	17235.10	44.44	-3.18	41.26	54.00	-12.74	AV
Middle Channel (5785 MHz)-Above 1G							
Vertical	4592.03	72.51	-20.42	52.10	74.00	-21.90	PK
Vertical	4592.03	59.09	-20.42	38.67	54.00	-15.33	AV
Vertical	11570.04	61.46	-8.86	52.60	68.20	-15.60	PK
Vertical	11570.04	50.00	-8.86	41.14	54.00	-12.86	AV
Vertical	17355.10	59.69	-2.52	57.17	68.20	-11.03	PK
Vertical	17355.10	44.15	-2.52	41.63	54.00	-12.37	AV
Horizontal	4592.19	73.83	-20.42	53.42	74.00	-20.58	PK
Horizontal	4592.19	59.07	-20.42	38.65	54.00	-15.35	AV
Horizontal	11570.03	63.22	-8.86	54.36	68.20	-13.84	PK
Horizontal	11570.03	49.53	-8.86	40.67	54.00	-13.33	AV
Horizontal	17355.10	56.85	-2.52	54.33	68.20	-13.87	PK
Horizontal	17355.10	44.44	-2.52	41.92	54.00	-12.08	AV
High Channel (5825 MHz)-Above 1G							
Vertical	6039.19	74.66	-18.93	55.73	68.20	-12.47	PK
Vertical	6039.19	59.65	-18.93	40.72	54.00	-13.28	AV
Vertical	11650.06	64.53	-8.92	55.61	74.00	-18.39	PK
Vertical	11650.06	49.72	-8.92	40.80	54.00	-13.20	AV
Vertical	17475.03	58.78	-1.86	56.92	68.20	-11.28	PK
Vertical	17475.03	44.98	-1.86	43.12	54.00	-10.88	AV
Horizontal	6039.13	70.66	-18.93	51.73	68.20	-16.47	PK
Horizontal	6039.13	59.88	-18.93	40.95	54.00	-13.05	AV
Horizontal	11650.09	63.31	-8.92	54.39	74.00	-19.61	PK
Horizontal	11650.09	49.39	-8.92	40.47	54.00	-13.53	AV
Horizontal	17475.13	57.20	-1.86	55.34	68.20	-12.86	PK
Horizontal	17475.13	44.50	-1.86	42.64	54.00	-11.36	AV

Note: PK value is lower than the Average value limit, So average didn't record.  
 The 26.5-40G amplitude of spurious emissions that are attenuated by more than 20dB below the permissible value has no need to be reported.  
 Emission level (dBuV/m) = 20 log Emission level (uV/m).  
 Corrected Reading: Antenna Factor + Cable Loss + Read Level - Preamp Factor = Level.  
 Test Mode is MIMO Mode.

Test Mode:	TX (5.8G) -- 802.11n-HT40
------------	---------------------------

Polar (H/V)	Frequency (MHz)	Reading Level (dBuV/m)	Correct Factor (dB)	Measurement (dBuV/m)	Limits (dBuV/m)	Over (dB)	Detector Type
Low Channel (5755 MHz)-Above 1G							
Vertical	4679.04	70.61	-20.24	50.37	74.00	-23.63	PK
Vertical	4679.04	59.10	-20.24	38.86	54.00	-15.14	AV
Vertical	11510.19	63.03	-8.81	54.22	74.00	-19.78	PK
Vertical	11510.19	49.40	-8.81	40.59	54.00	-13.41	AV
Vertical	17265.02	58.87	-3.01	55.86	68.20	-12.34	PK
Vertical	17265.02	44.65	-3.01	41.64	54.00	-12.36	AV
Horizontal	4679.04	71.85	-20.24	51.61	74.00	-22.39	PK
Horizontal	4679.04	59.55	-20.24	39.31	54.00	-14.69	AV
Horizontal	11510.20	60.12	-8.81	51.31	74.00	-22.69	PK
Horizontal	11510.20	49.02	-8.81	40.21	54.00	-13.79	AV
Horizontal	17265.20	57.73	-3.01	54.72	68.20	-13.48	PK
Horizontal	17265.20	44.42	-3.01	41.41	54.00	-12.59	AV
Middle Channel (5795 MHz)-Above 1G							
Vertical	6039.09	70.19	-18.93	51.26	68.20	-16.94	PK
Vertical	6039.09	59.11	-18.93	40.17	54.00	-13.83	AV
Vertical	11590.06	63.93	-8.87	55.06	74.00	-18.94	PK
Vertical	11590.06	49.26	-8.87	40.39	54.00	-13.61	AV
Vertical	17385.00	55.90	-2.35	53.55	68.20	-14.65	PK
Vertical	17385.00	44.31	-2.35	41.96	54.00	-12.04	AV
Horizontal	6039.00	74.63	-18.93	55.70	68.20	-12.50	PK
Horizontal	6039.00	59.71	-18.93	40.78	54.00	-13.22	AV
Horizontal	11590.11	61.77	-8.87	52.90	74.00	-21.10	PK
Horizontal	11590.11	49.87	-8.87	41.00	54.00	-13.00	AV
Horizontal	17385.04	58.30	-2.35	55.95	68.20	-12.25	PK
Horizontal	17385.04	44.39	-2.35	42.04	54.00	-11.96	AV

Note: PK value is lower than the Average value limit, So average didn't record.

The 26.5-40G amplitude of spurious emissions that are attenuated by more than 20dB below the permissible value has no need to be reported.

Emission level (dBuV/m) = 20 log Emission level (uV/m).

Corrected Reading: Antenna Factor + Cable Loss + Read Level - Preamp Factor = Level.

Test Mode is MIMO Mode.

Test Mode:	TX (5.8G) --802.11ac-HT20
------------	---------------------------

Polar	Frequency	Reading Level	Correct Factor	Measurement	Limits	Over	Detector Type
(H/V)	(MHz)	(dBuV/m)	(dB)	(dBuV/m)	(dBuV/m)	(dB)	
Low Channel (5745 MHz)-Above 1G							
Vertical	4679.14	70.70	-20.24	50.46	74.00	-23.54	PK
Vertical	4679.14	59.37	-20.24	39.13	54.00	-14.87	AV
Vertical	11490.14	60.94	-8.79	52.15	68.20	-16.05	PK
Vertical	11490.14	49.93	-8.79	41.14	54.00	-12.86	AV
Vertical	17235.03	56.66	-3.18	53.48	68.20	-14.72	PK
Vertical	17235.03	44.04	-3.18	40.86	54.00	-13.14	AV
Horizontal	4679.04	72.27	-20.24	52.02	74.00	-21.98	PK
Horizontal	4679.04	59.60	-20.24	39.36	54.00	-14.64	AV
Horizontal	11490.15	62.98	-8.79	54.19	68.20	-14.01	PK
Horizontal	11490.15	49.89	-8.79	41.10	54.00	-12.90	AV
Horizontal	17235.20	56.38	-3.18	53.20	68.20	-15.00	PK
Horizontal	17235.20	44.27	-3.18	41.09	54.00	-12.91	AV
Middle Channel (5785 MHz)-Above 1G							
Vertical	4592.05	71.07	-20.42	50.65	74.00	-23.35	PK
Vertical	4592.05	59.75	-20.42	39.33	54.00	-14.67	AV
Vertical	11570.11	64.25	-8.86	55.39	68.20	-12.81	PK
Vertical	11570.11	49.53	-8.86	40.67	54.00	-13.33	AV
Vertical	17355.07	55.18	-2.52	52.66	68.20	-15.54	PK
Vertical	17355.07	44.52	-2.52	42.00	54.00	-12.00	AV
Horizontal	4592.05	71.88	-20.42	51.46	74.00	-22.54	PK
Horizontal	4592.05	59.93	-20.42	39.51	54.00	-14.49	AV
Horizontal	11570.00	61.68	-8.86	52.82	68.20	-15.38	PK
Horizontal	11570.00	49.85	-8.86	40.99	54.00	-13.01	AV
Horizontal	17355.13	57.58	-2.52	55.06	68.20	-13.14	PK
Horizontal	17355.13	44.95	-2.52	42.43	54.00	-11.57	AV
High Channel (5825 MHz)-Above 1G							
Vertical	6039.18	74.24	-18.93	55.31	68.20	-12.89	PK
Vertical	6039.18	59.88	-18.93	40.95	54.00	-13.05	AV
Vertical	11650.05	62.65	-8.92	53.73	74.00	-20.27	PK
Vertical	11650.05	49.64	-8.92	40.72	54.00	-13.28	AV
Vertical	17475.19	59.05	-1.86	57.19	68.20	-11.01	PK
Vertical	17475.19	44.12	-1.86	42.26	54.00	-11.74	AV
Horizontal	6039.05	72.89	-18.93	53.96	68.20	-14.24	PK
Horizontal	6039.05	59.06	-18.93	40.12	54.00	-13.88	AV
Horizontal	11650.01	61.72	-8.92	52.80	74.00	-21.20	PK
Horizontal	11650.01	49.02	-8.92	40.10	54.00	-13.90	AV
Horizontal	17475.14	56.39	-1.86	54.53	68.20	-13.67	PK
Horizontal	17475.14	44.47	-1.86	42.61	54.00	-11.39	AV

Note: PK value is lower than the Average value limit, So average didn't record.  
 The 26.5-40G amplitude of spurious emissions that are attenuated by more than 20dB below the permissible value has no need to be reported.  
 Emission level (dBuV/m) = 20 log Emission level (uV/m).  
 Corrected Reading: Antenna Factor + Cable Loss + Read Level - Preamp Factor = Level.  
 Test Mode is MIMO Mode.



Test Mode :	TX (5.8G) -- 802.11ac-HT40
-------------	----------------------------

Polar (H/V)	Frequency (MHz)	Reading Level (dBuV/m)	Correct Factor (dB)	Measure- ment (dBuV/m)	Limits (dBuV/m)	Over (dB)	Detector Type
Low Channel (5755 MHz)-Above 1G							
Vertical	4679.08	70.19	-20.24	49.94	74.00	-24.06	PK
Vertical	4679.08	59.58	-20.24	39.34	54.00	-14.66	AV
Vertical	11510.04	61.66	-8.81	52.85	74.00	-21.15	PK
Vertical	11510.04	49.36	-8.81	40.55	54.00	-13.45	AV
Vertical	17265.03	55.36	-3.01	52.35	68.20	-15.85	PK
Vertical	17265.03	44.08	-3.01	41.07	54.00	-12.93	AV
Horizontal	4679.10	74.34	-20.24	54.10	74.00	-19.90	PK
Horizontal	4679.10	59.29	-20.24	39.05	54.00	-14.95	AV
Horizontal	11510.08	63.90	-8.81	55.09	74.00	-18.91	PK
Horizontal	11510.08	49.52	-8.81	40.71	54.00	-13.29	AV
Horizontal	17265.18	58.55	-3.01	55.54	68.20	-12.66	PK
Horizontal	17265.18	44.62	-3.01	41.61	54.00	-12.39	AV
Middle Channel (5795 MHz)-Above 1G							
Vertical	6039.17	72.91	-18.93	53.97	68.20	-14.23	PK
Vertical	6039.17	59.98	-18.93	41.04	54.00	-12.96	AV
Vertical	11590.05	60.60	-8.87	51.73	74.00	-22.27	PK
Vertical	11590.05	49.68	-8.87	40.81	54.00	-13.19	AV
Vertical	17385.04	58.91	-2.35	56.56	68.20	-11.64	PK
Vertical	17385.04	44.22	-2.35	41.87	54.00	-12.13	AV
Horizontal	6039.07	73.53	-18.93	54.60	68.20	-13.60	PK
Horizontal	6039.07	59.68	-18.93	40.74	54.00	-13.26	AV
Horizontal	11590.09	60.89	-8.87	52.02	74.00	-21.98	PK
Horizontal	11590.09	49.50	-8.87	40.63	54.00	-13.37	AV
Horizontal	17385.04	58.70	-2.35	56.35	68.20	-11.85	PK
Horizontal	17385.04	44.18	-2.35	41.83	54.00	-12.17	AV

Note: PK value is lower than the Average value limit, So average didn't record.  
 The 26.5-40G amplitude of spurious emissions that are attenuated by more than 20dB below the permissible value has no need to be reported.  
 Emission level (dBuV/m) = 20 log Emission level (uV/m).  
 Corrected Reading: Antenna Factor + Cable Loss + Read Level - Preamp Factor = Level.  
 Test Mode is MIMO Mode.

Test Mode :	TX (5.8G) -- 802.11ac 80
-------------	--------------------------

Polar (H/V)	Frequency (MHz)	Reading Level (dBuV/m)	Correct Factor (dB)	Measurement (dBuV/m)	Limits (dBuV/m)	Over (dB)	Detector Type
Low Channel (5775 MHz)-Above 1G							
Vertical	4679.11	70.44	-20.24	50.19	74.00	-23.81	PK
Vertical	4679.11	59.10	-20.24	38.86	54.00	-15.14	AV
Vertical	11550.02	62.80	-8.84	53.96	74.00	-20.04	PK
Vertical	11550.02	49.25	-8.84	40.41	54.00	-13.59	AV
Vertical	17325.09	56.85	-2.68	54.17	68.20	-14.03	PK
Vertical	17325.09	44.20	-2.68	41.52	54.00	-12.48	AV
Horizontal	4679.16	71.14	-20.24	50.90	74.00	-23.10	PK
Horizontal	4679.16	59.75	-20.24	39.51	54.00	-14.49	AV
Horizontal	11550.01	61.74	-8.84	52.90	74.00	-21.10	PK
Horizontal	11550.01	49.71	-8.84	40.87	54.00	-13.13	AV
Horizontal	17325.15	55.92	-2.68	53.24	68.20	-14.96	PK
Horizontal	17325.15	44.75	-2.68	42.07	54.00	-11.93	AV

Note: PK value is lower than the Average value limit, So average didn't record.

The 26.5-40G amplitude of spurious emissions that are attenuated by more than 20dB below the permissible value has no need to be reported.

Emission level (dBuV/m) = 20 log Emission level (uV/m).

Corrected Reading: Antenna Factor + Cable Loss + Read Level - Preamp Factor = Level.

Test Mode is MIMO Mode.

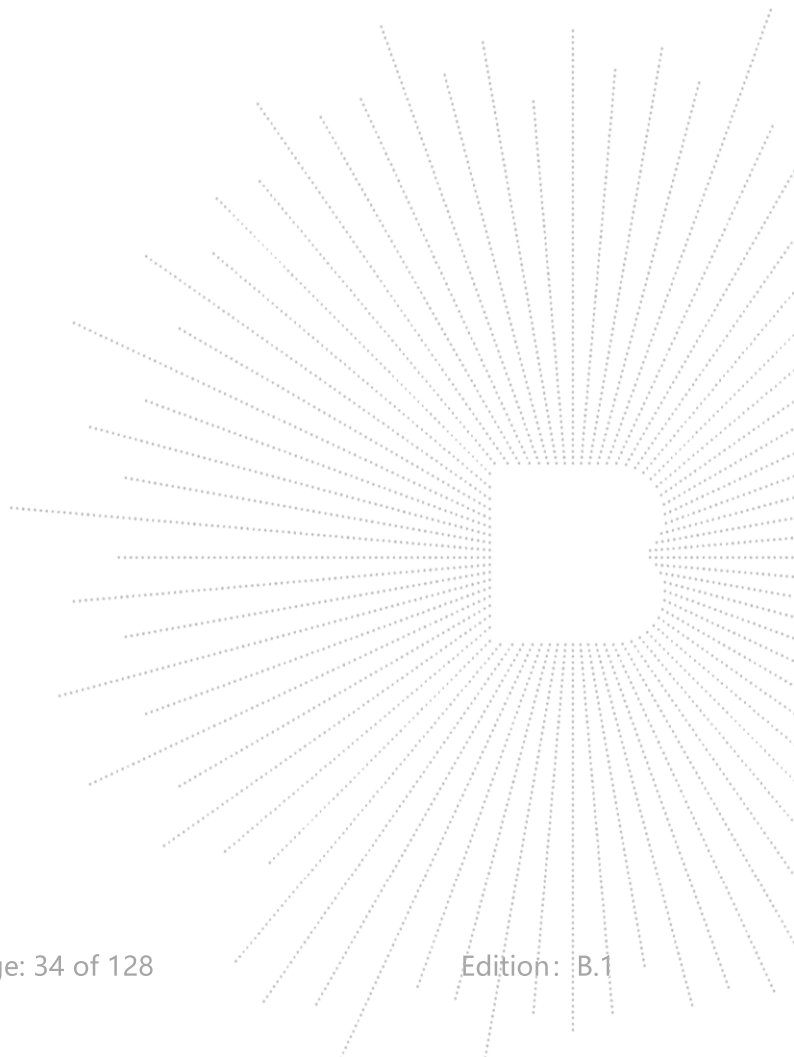

## 8. Power Spectral Density Test

### 8.1 Block Diagram Of Test Setup



### 8.2 Limit

For the band 5.15-5.25 GHz,

(i) For an outdoor access point operating in the band 5.15-5.25 GHz, the maximum power spectral density shall not exceed 17 dBm in any 1 megahertz band. If transmitting antennas of directional gain greater than 6 dBi are used, both the maximum conducted output power and the maximum power spectral density shall be reduced by the amount in dB that the directional gain of the antenna exceeds 6 dBi. The maximum e.i.r.p. at any elevation angle above 30 degrees as measured from the horizon must not exceed 125 mW (21 dBm).

(ii) For an indoor access point operating in the band 5.15-5.25 GHz, the maximum power spectral density shall not exceed 17 dBm in any 1 megahertz band. If transmitting antennas of directional gain greater than 6 dBi are used, both the maximum conducted output power and the maximum power spectral density shall be reduced by the amount in dB that the directional gain of the antenna exceeds 6 dBi.

(iii) For fixed point-to-point access points operating in the band 5.15-5.25 GHz, the maximum power spectral density shall not exceed 17 dBm in any 1 megahertz band. Fixed point-to-point U-NII devices may employ antennas with directional gain up to 23 dBi without any corresponding reduction in the maximum conducted output power or maximum power spectral density. For fixed point-to-point transmitters that employ a directional antenna gain greater than 23 dBi, a 1 dB reduction in maximum conducted output power and maximum power spectral density is required for each 1 dB of antenna gain in excess of 23 dBi. Fixed, point-to-point operations exclude the use of point-to-multipoint systems, omnidirectional applications, and multiple collocated transmitters transmitting the same information. The operator of the U-NII device, or if the equipment is professionally installed, the installer, is responsible for ensuring that systems employing high gain directional antennas are used exclusively for fixed, point-to-point operations.

(iv) For client devices in the 5.15-5.25 GHz band, the maximum power spectral density shall not exceed 11 dBm in any 1 megahertz band. If transmitting antennas of directional gain greater than 6 dBi are used, both the maximum conducted output power and the maximum power spectral density shall be reduced by the amount in dB that the directional gain of the antenna exceeds 6 dBi.

For the band 5.725-5.85 GHz

(3) For the band 5.725-5.85 GHz, the maximum power spectral density shall not exceed 30 dBm in any 500-kHz band. If transmitting antennas of directional gain greater than 6 dBi are used, both the maximum conducted output power and the maximum power spectral density shall be reduced by the amount in dB that the directional gain of the antenna exceeds 6 dBi.

### 8.3 Test Procedure

For devices operating in the bands 5.15-5.25 GHz, 5.25-5.35 GHz, and 5.47-5.725 GHz, the above procedures make use of 1 MHz RBW to satisfy directly the 1 MHz reference bandwidth specified in § 15.407(a)(5). For devices operating in the band 5.725-5.85 GHz, the rules specify a measurement bandwidth of 500 kHz. Many spectrum analyzers do not have 500 kHz RBW, thus a narrower RBW may need to be used. The rules permit the use of a RBWs less than 1 MHz, or 500 kHz, “provided that the measured power is integrated over the full reference bandwidth” to show the total power over the specified measurement bandwidth (i.e., 1 MHz, or 500 kHz). If measurements are performed using a reduced resolution bandwidth (< 1 MHz, or < 500 kHz) and integrated over 1 MHz, or 500 KHz bandwidth, the following adjustments to the procedures apply:

- a) Set  $RBW \geq 1/T$ , where T is defined in section II.B.I.a).
- b) Set  $VBW \geq 3 RBW$ .
- c) If measurement bandwidth of Maximum PSD is specified in 500 kHz, add  $10\log(500\text{kHz}/RBW)$  to the measured result, whereas RBW (< 500 KHz) is the reduced resolution bandwidth of the spectrum analyzer set during measurement.
- d) If measurement bandwidth of Maximum PSD is specified in 1 MHz, add  $10\log(1\text{MHz}/RBW)$  to the measured result, whereas RBW (< 1 MHz) is the reduced resolution bandwidth of spectrum analyzer set during measurement.
- e) Care must be taken to ensure that the measurements are performed during a period of continuous transmission or are corrected upward for duty cycle.

Note: As a practical matter, it is recommended to use reduced RBW of 100 kHz for the sections 5.c) and 5.d) above, since RBW=100 KHZ is available on nearly all spectrum analyzers.

### 8.4 EUT Operating Conditions

The EUT was configured for testing in a typical fashion (as a customer would normally use it). The EUT has been programmed to continuously transmit during test. This operating condition was tested and used to collect the included data.

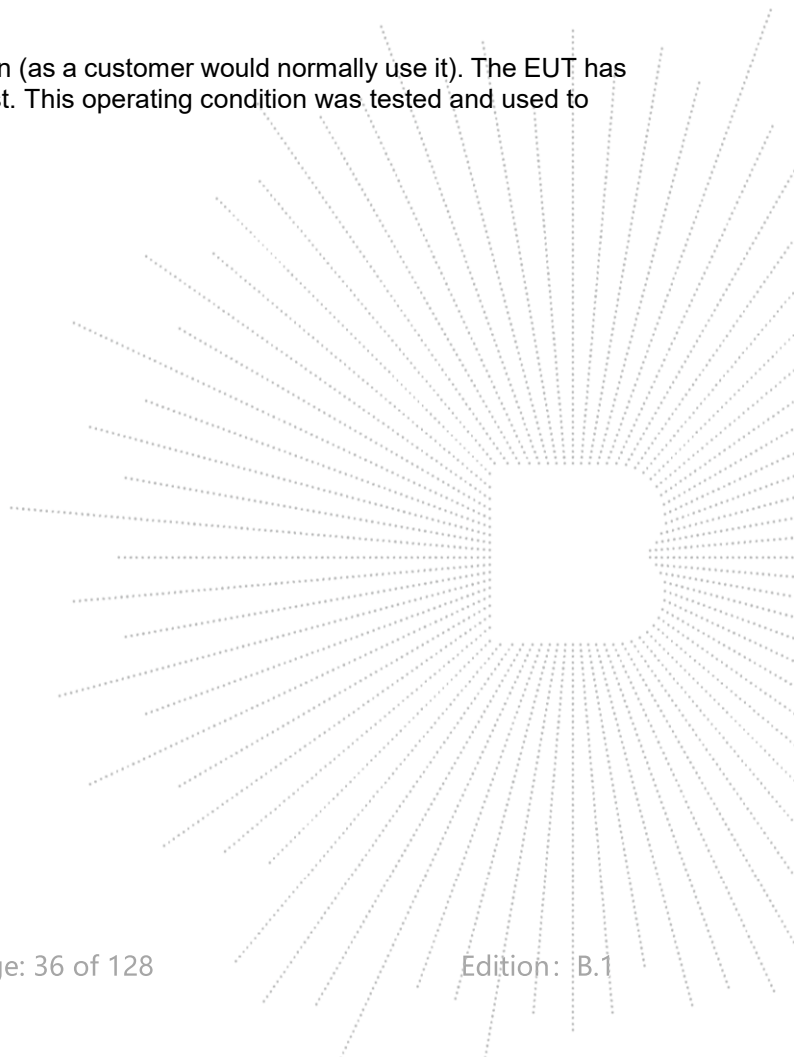

## 8.5 Test Result

Temperature:	26 °C	Relative Humidity:	54%
Pressure:	101kPa	Test Voltage:	DC 12V
Test Mode:	TX Frequency U-NII-1 (5180-5240MHz)		

Condition	Mode	Frequency (MHz)	Conducted PSD (dBm/MHz)		Total (dBm/MHz)	Limit (dBm/MHz)	Verdict
			Ant A	Ant B			
NVNT	a	5180	2.94	2.98	/	11	Pass
NVNT	a	5200	3.23	2.95	/	11	Pass
NVNT	a	5240	<b>3.91</b>	3.84	/	11	Pass
NVNT	n20	5180	2.82	2.83	5.84	11	Pass
NVNT	n20	5200	1.21	2.74	5.05	11	Pass
NVNT	n20	5240	3.69	3.77	6.74	11	Pass
NVNT	n40	5190	2.37	2.2	5.30	11	Pass
NVNT	n40	5230	2.59	2.94	5.78	11	Pass
NVNT	ac20	5180	2.1	2.11	5.12	11	Pass
NVNT	ac20	5200	1.92	2.52	5.24	11	Pass
NVNT	ac20	5240	3.01	3.39	6.21	11	Pass
NVNT	ac40	5190	2.26	2.52	5.40	11	Pass
NVNT	ac40	5230	2.46	2.94	5.72	11	Pass
NVNT	ac80	5210	1.89	2.35	5.14	11	Pass

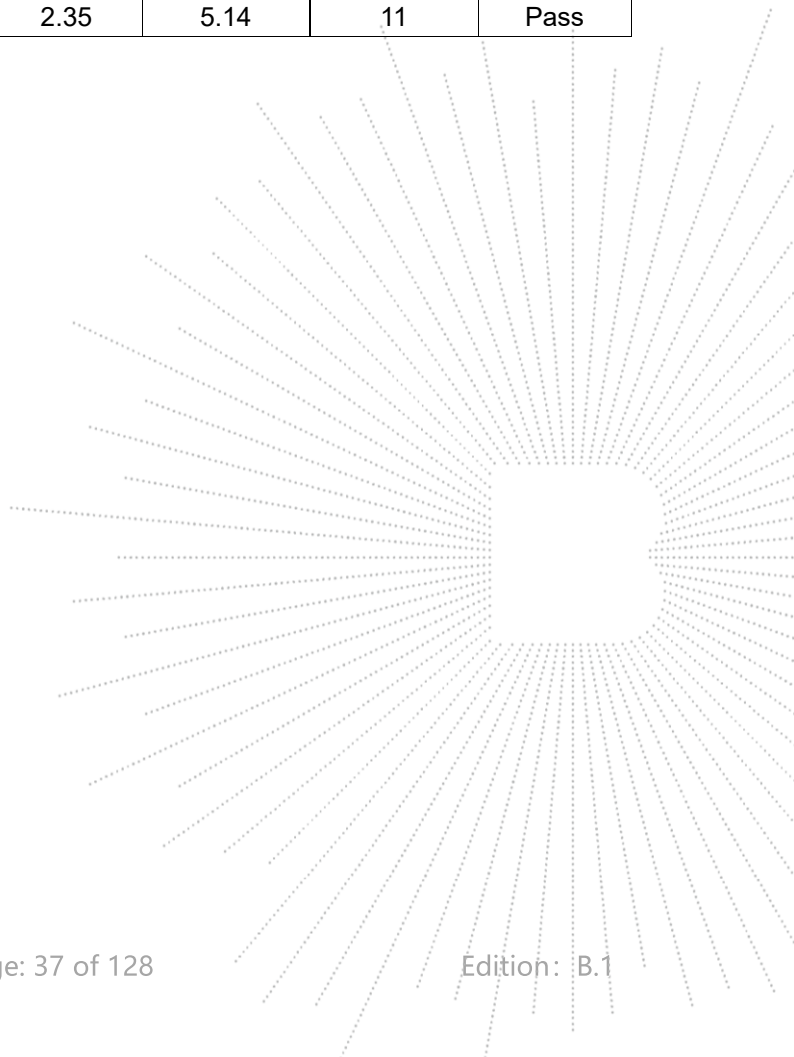

Note: A(B) Represent the value of antenna A and B, The worst data is Antenna A, only shown Antenna A Plot.

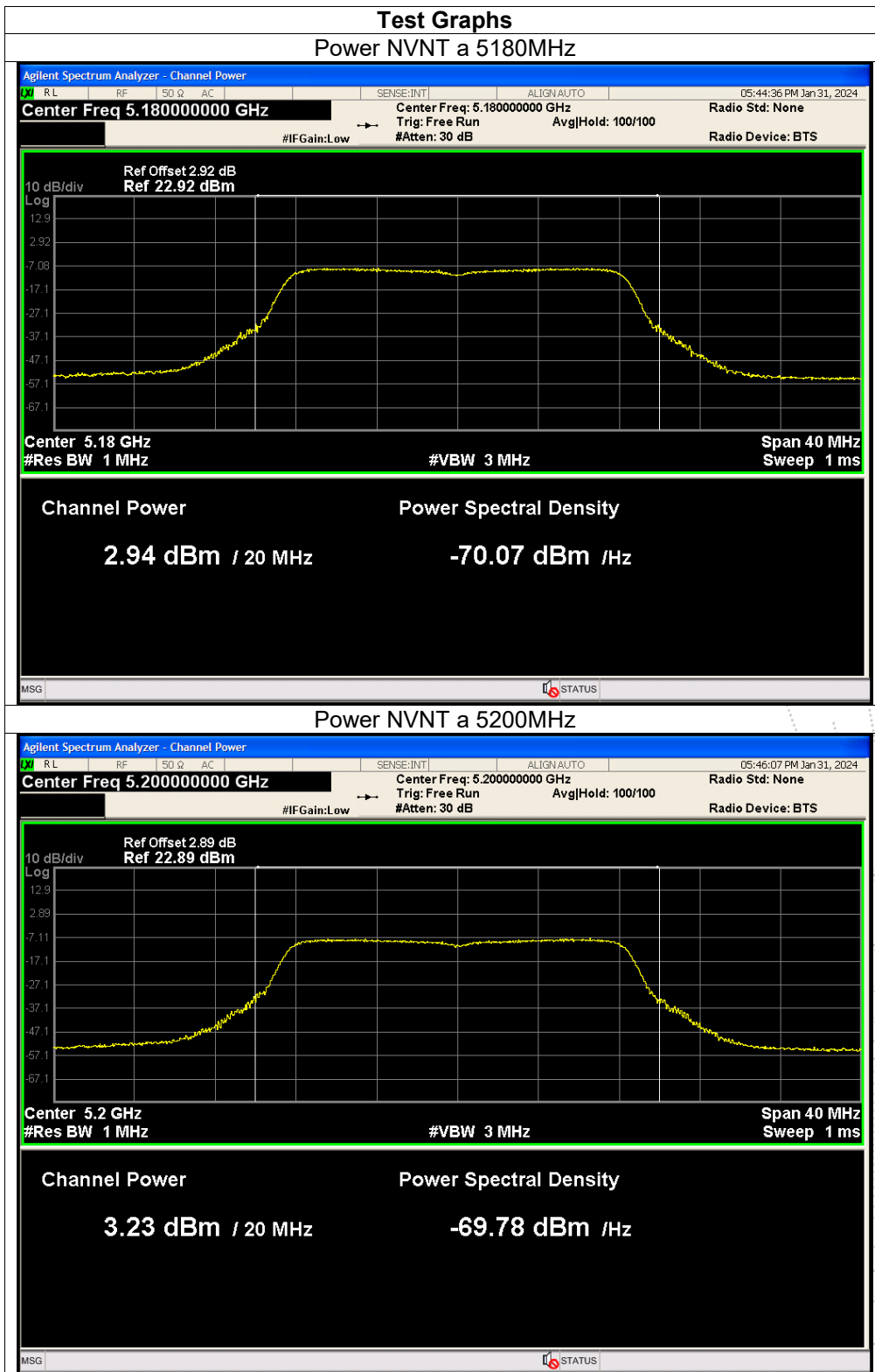

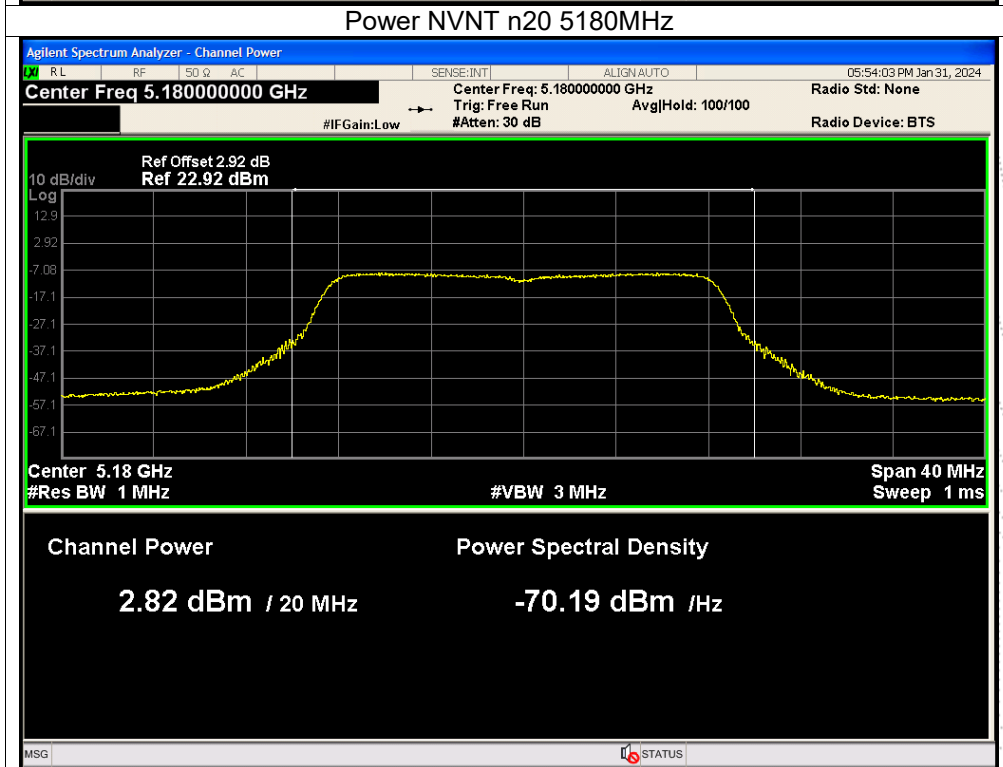
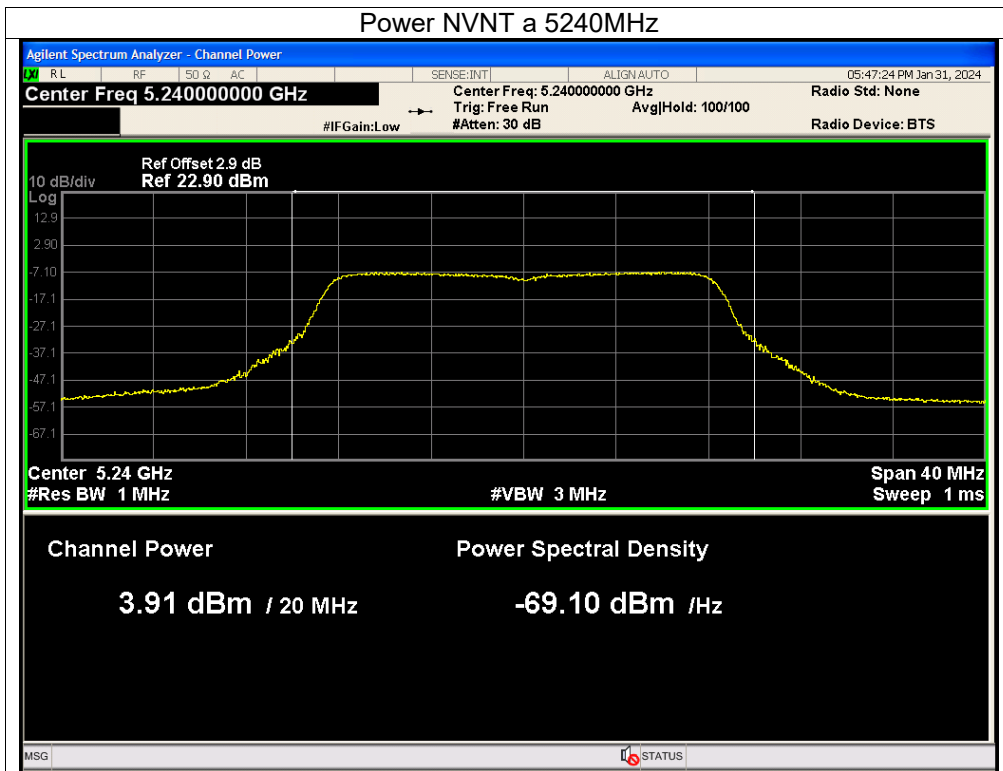

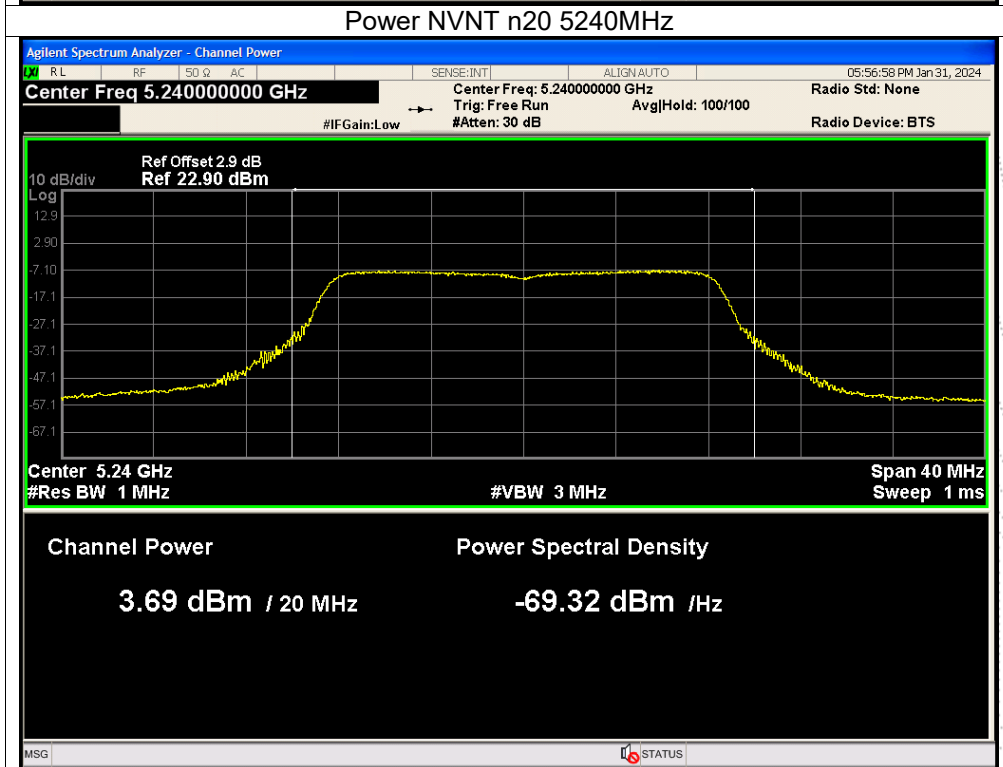
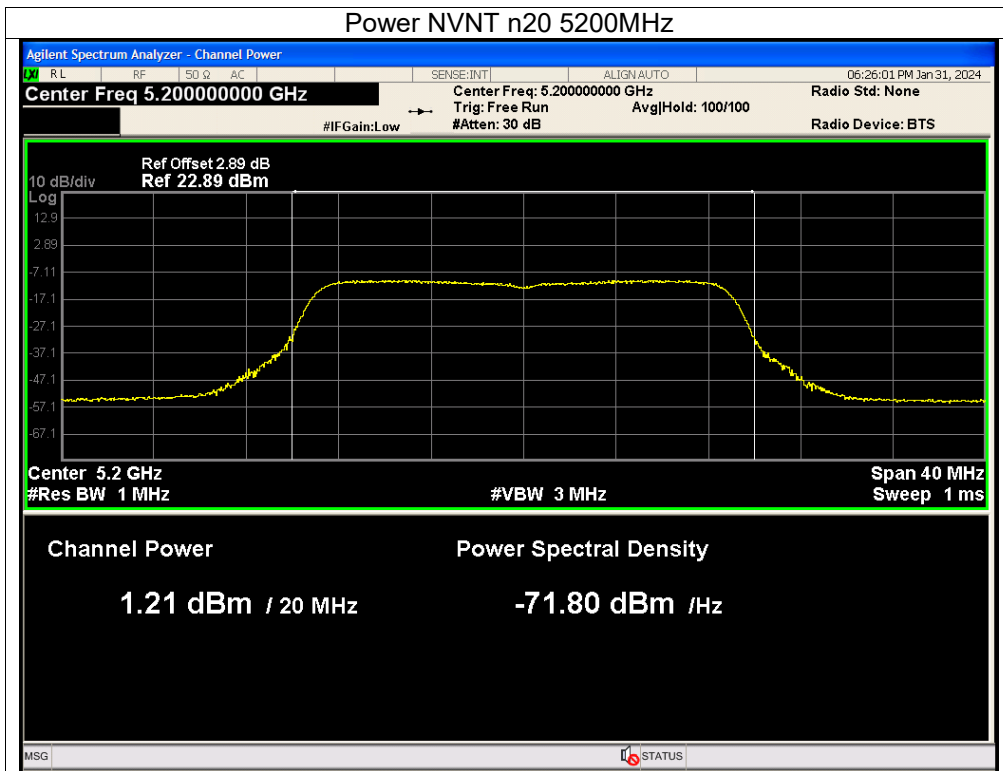



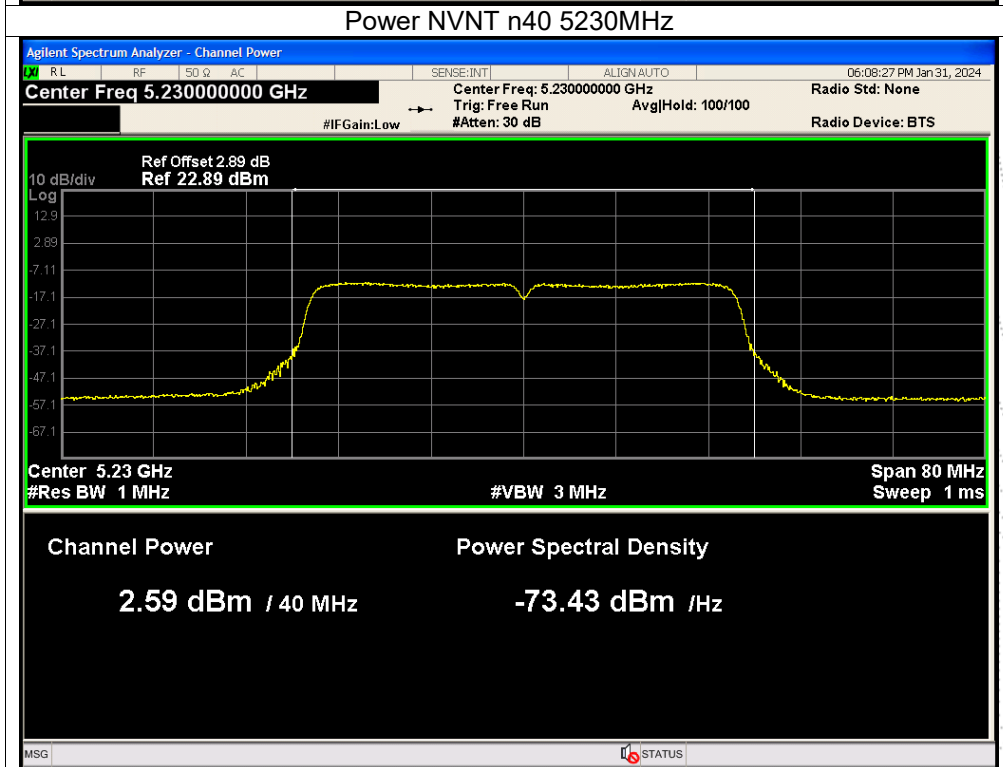
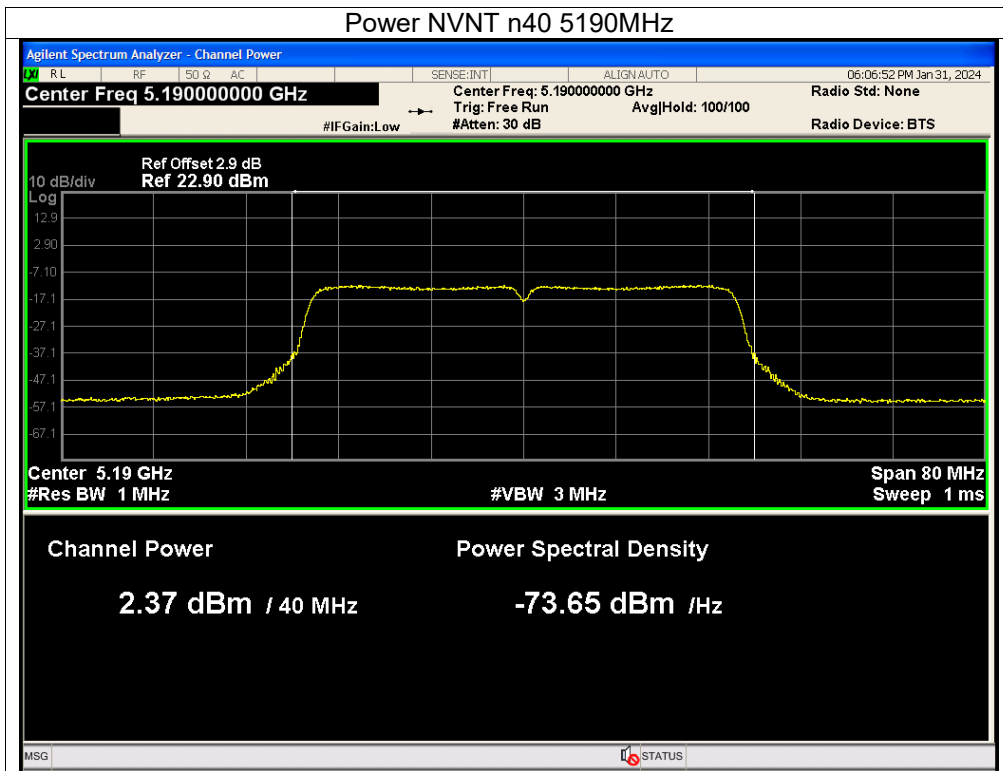

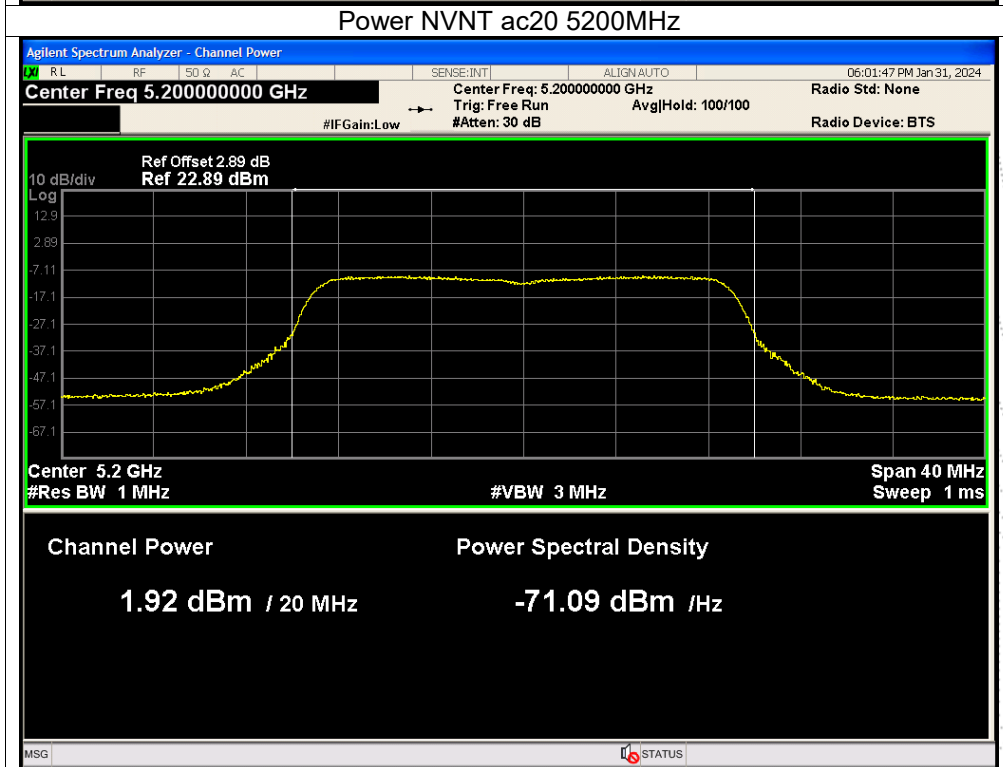
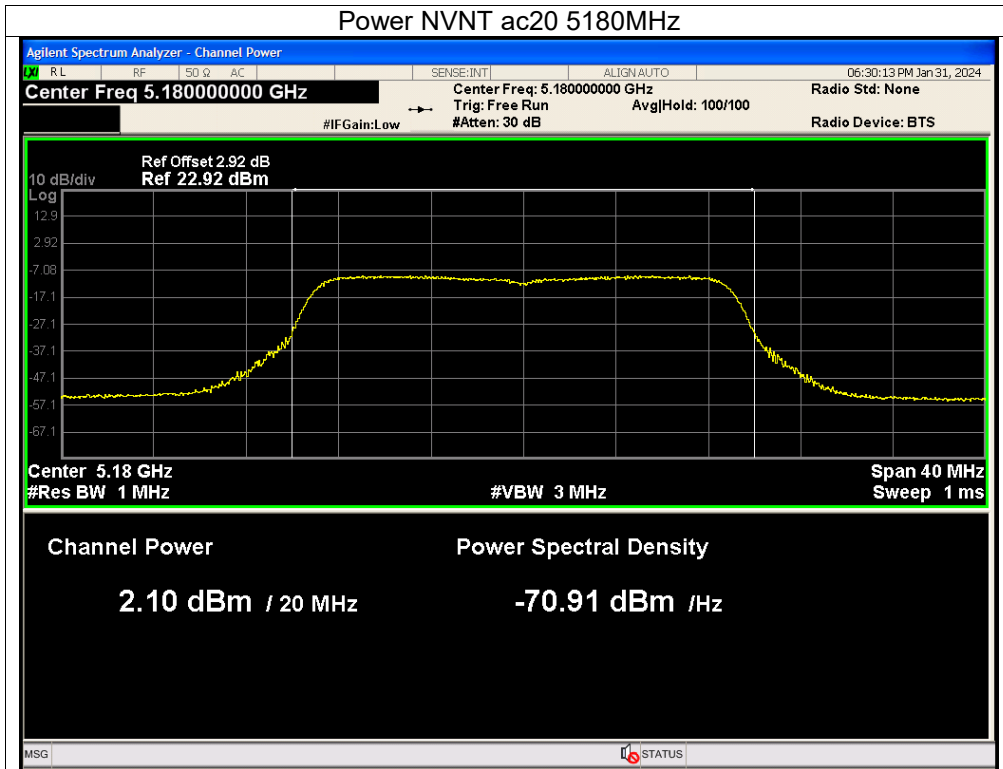

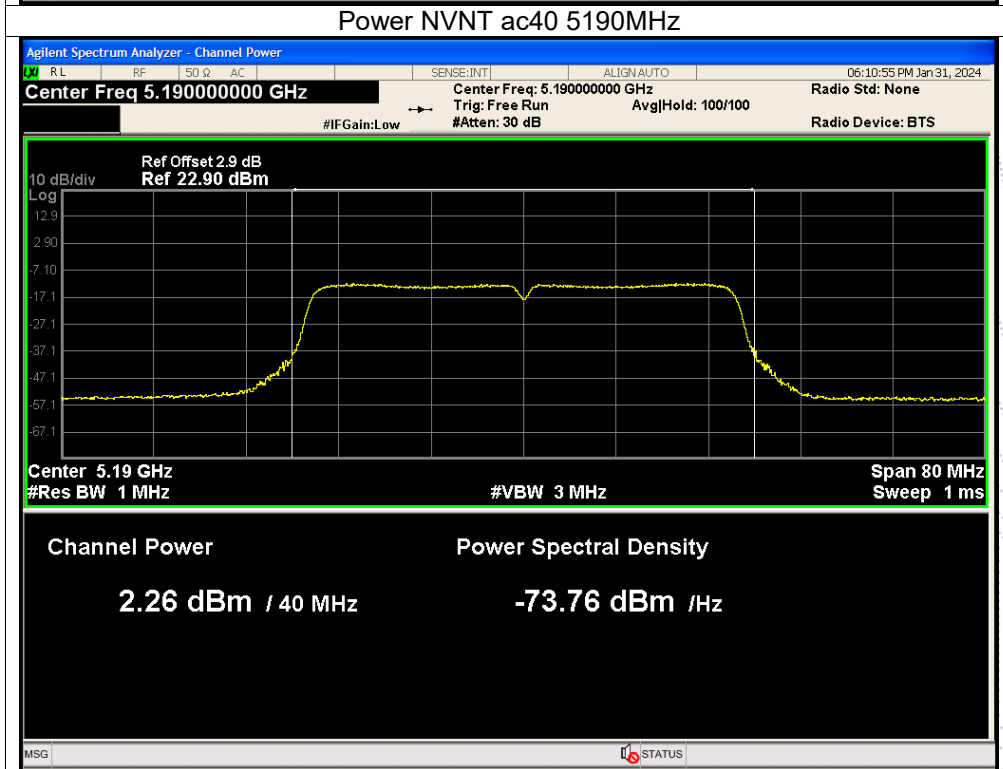
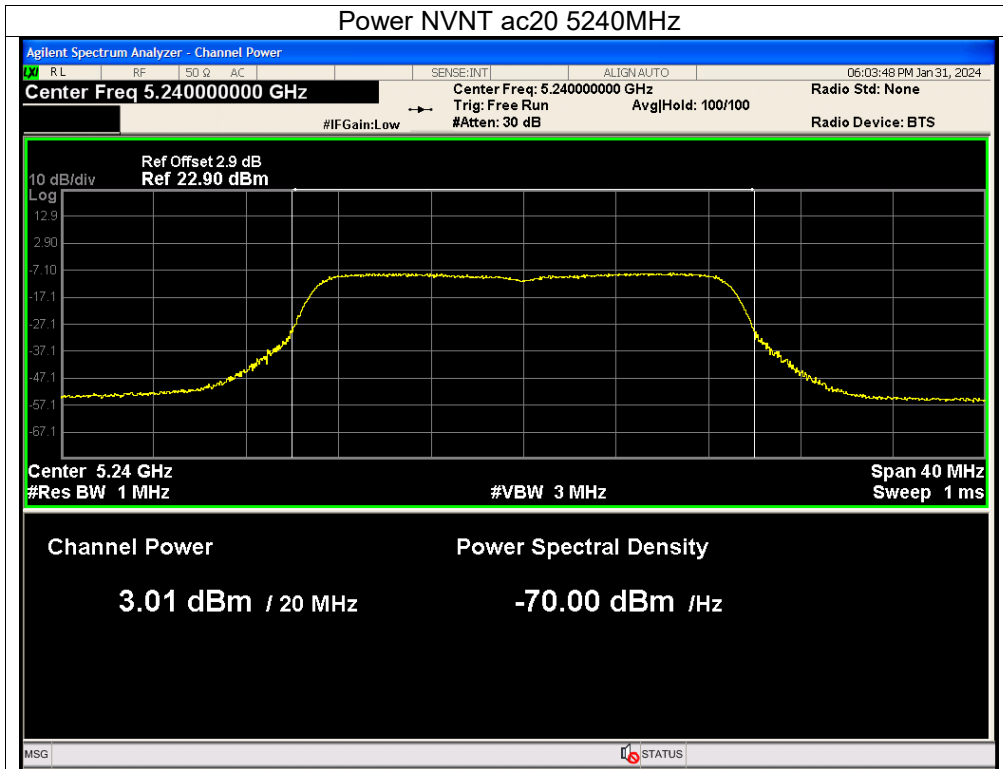

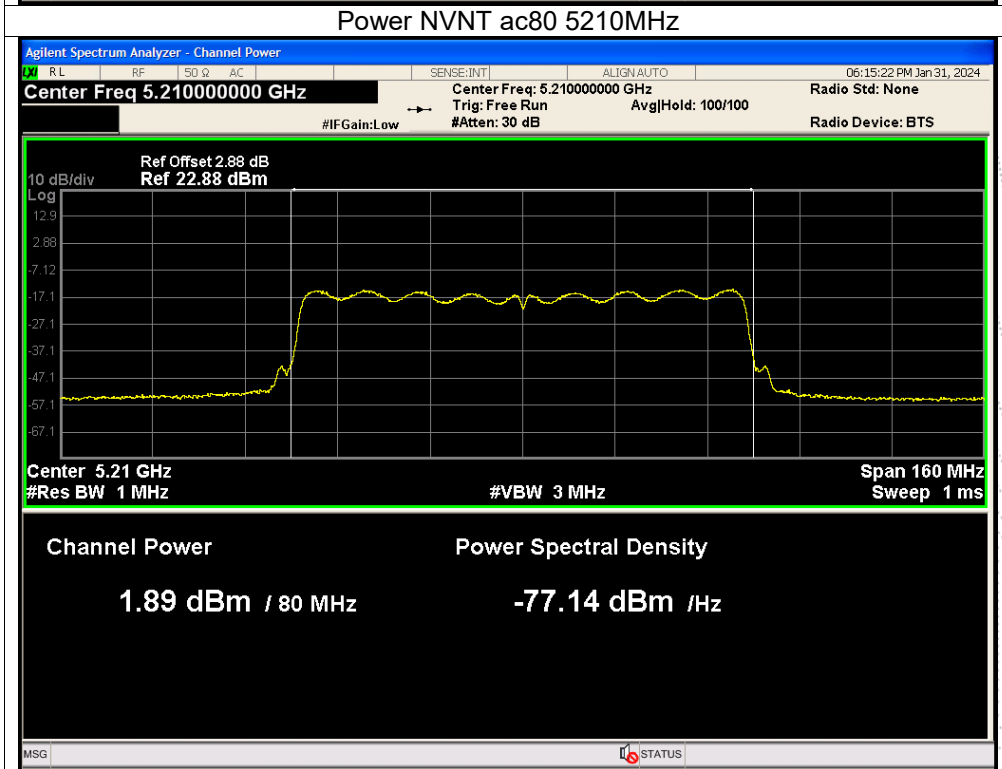
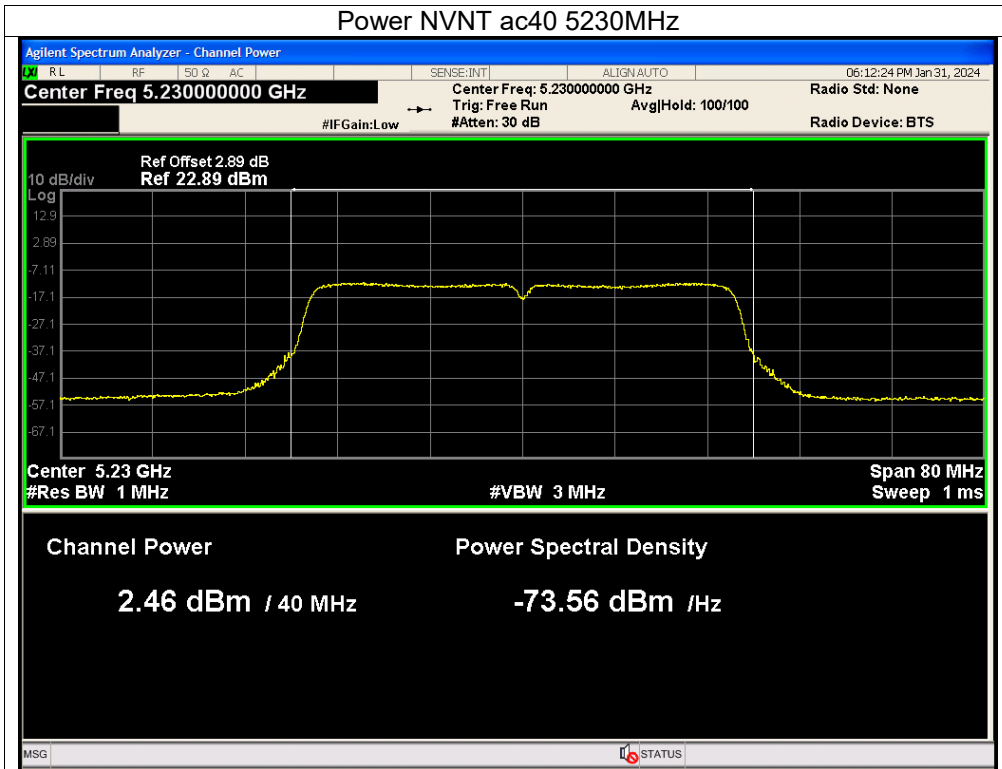

Temperature:	26 °C	Relative Humidity:	54%
Pressure:	101kPa	Test Voltage:	DC 12V
Test Mode:	TX Frequency U-NII-3 (5745-5825MHz)		

Condition	Mode	Frequency (MHz)	Conducted PSD (dBm)		Total (dBm)	Limit (dBm)	Verdict
			Ant A	Ant B			
NVNT	a	5745	2.93	3.01	/	30	Pass
NVNT	a	5785	3.46	3.34	/	30	Pass
NVNT	a	5825	<b>3.48</b>	3	/	30	Pass
NVNT	n20	5745	2.5	2.38	5.45	30	Pass
NVNT	n20	5785	2.67	2.79	5.74	30	Pass
NVNT	n20	5825	2.53	2.5	5.53	30	Pass
NVNT	n40	5755	2.18	1.68	4.95	30	Pass
NVNT	n40	5795	2.27	2.1	5.20	30	Pass
NVNT	ac20	5745	2.22	1.97	5.11	30	Pass
NVNT	ac20	5785	3.01	2.53	5.79	30	Pass
NVNT	ac20	5825	2.22	2.26	5.25	30	Pass
NVNT	ac40	5755	2.09	1.84	4.98	30	Pass
NVNT	ac40	5795	2	2.04	5.03	30	Pass
NVNT	ac80	5775	2.23	2.16	5.21	30	Pass

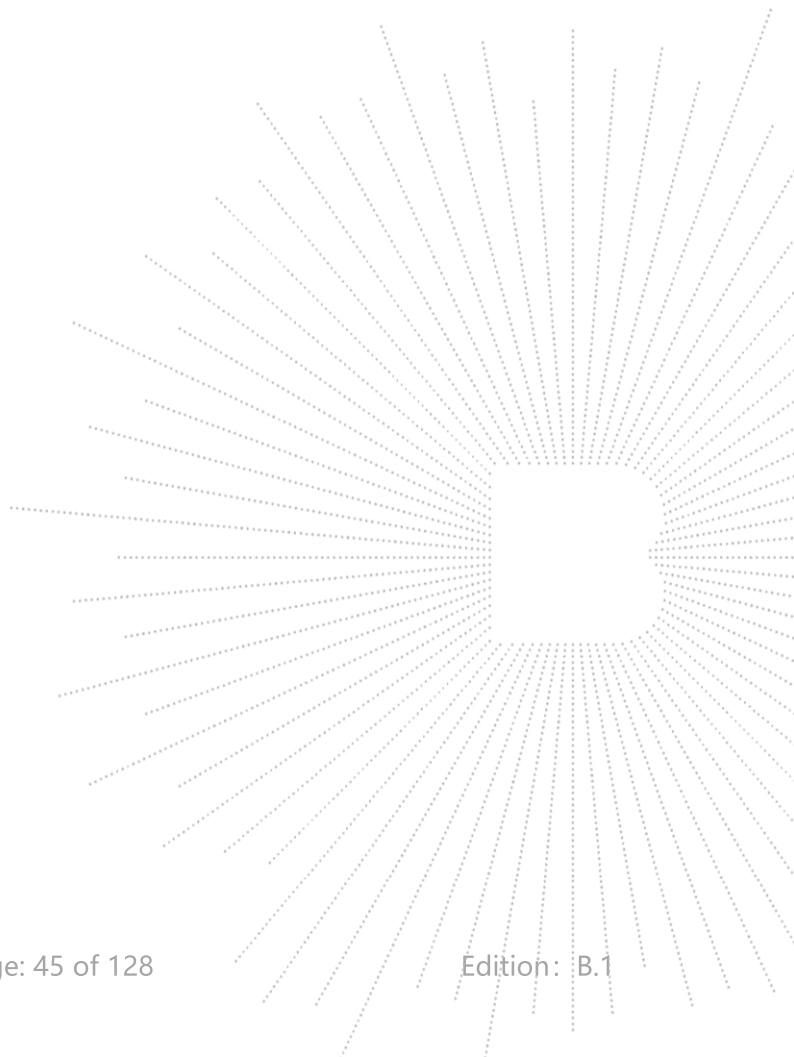

Note: A(B) Represent the value of antenna A and B, The worst data is Antenna A, only shown Antenna A Plot.

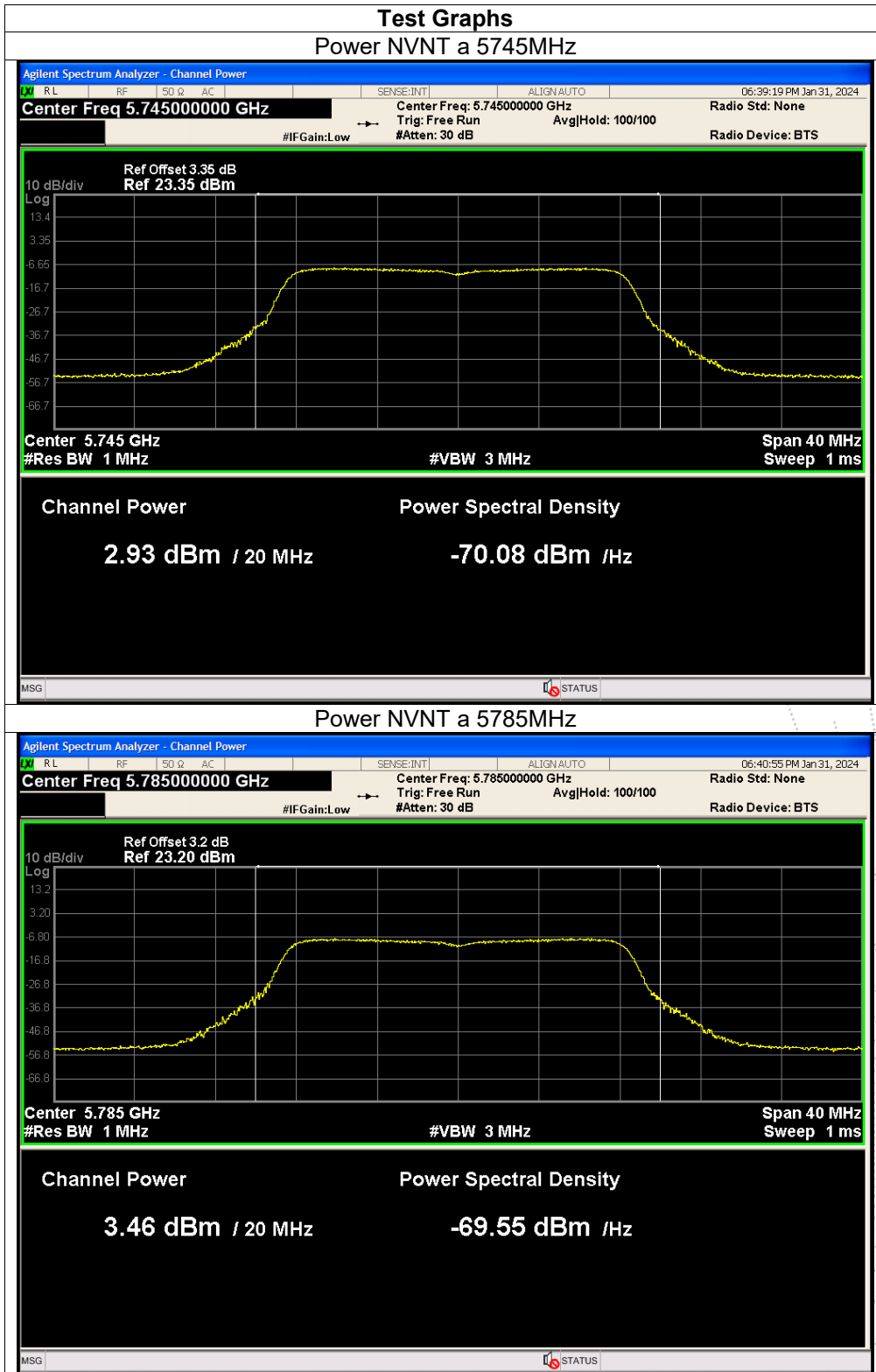

#### Power NVNT a 5785MHz

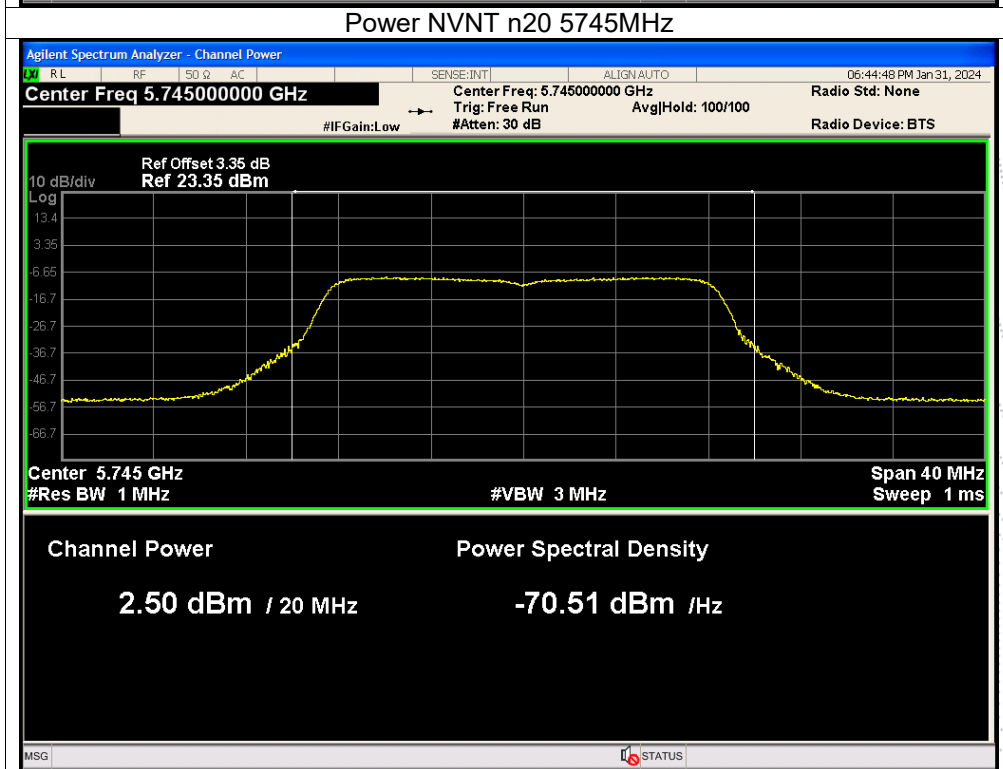
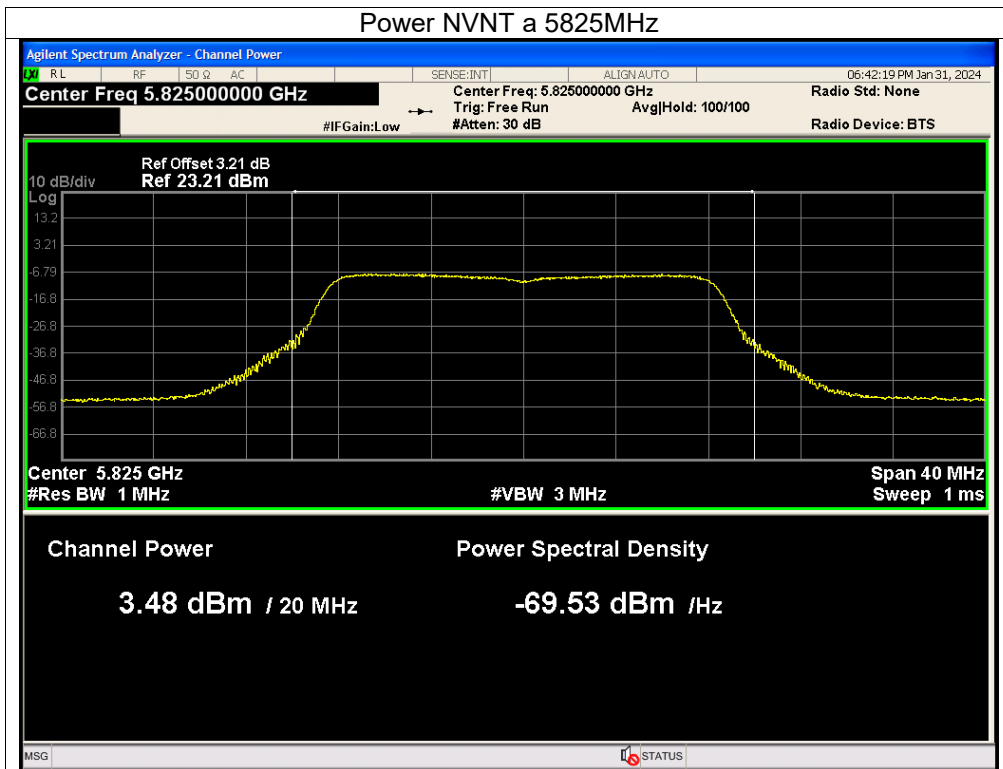

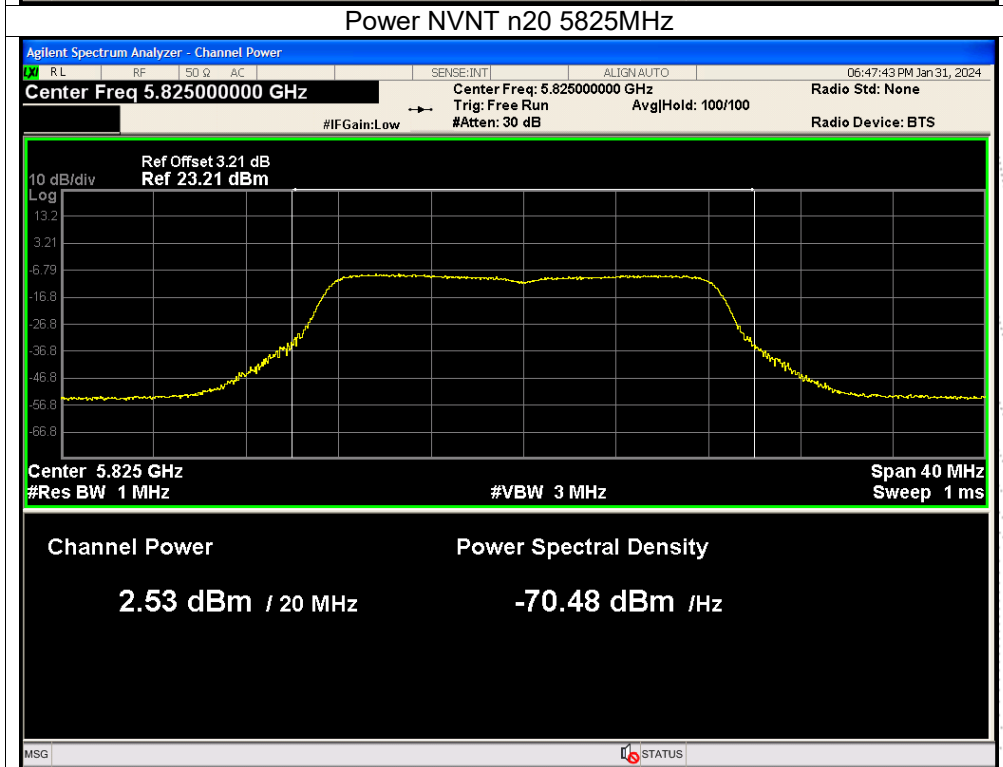
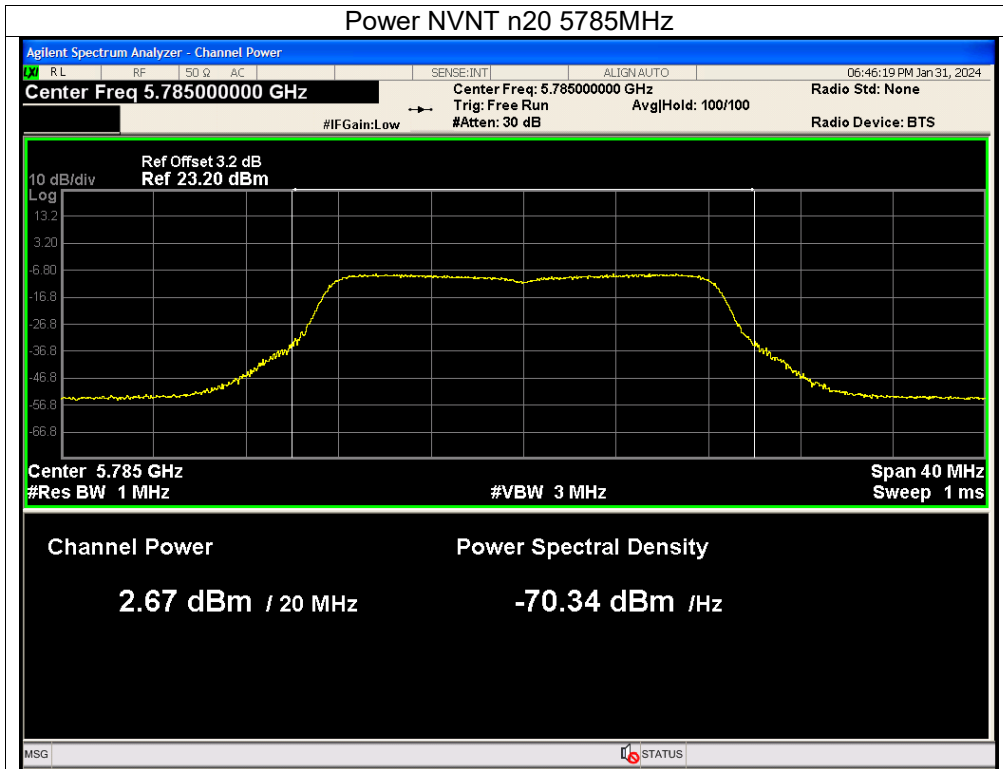



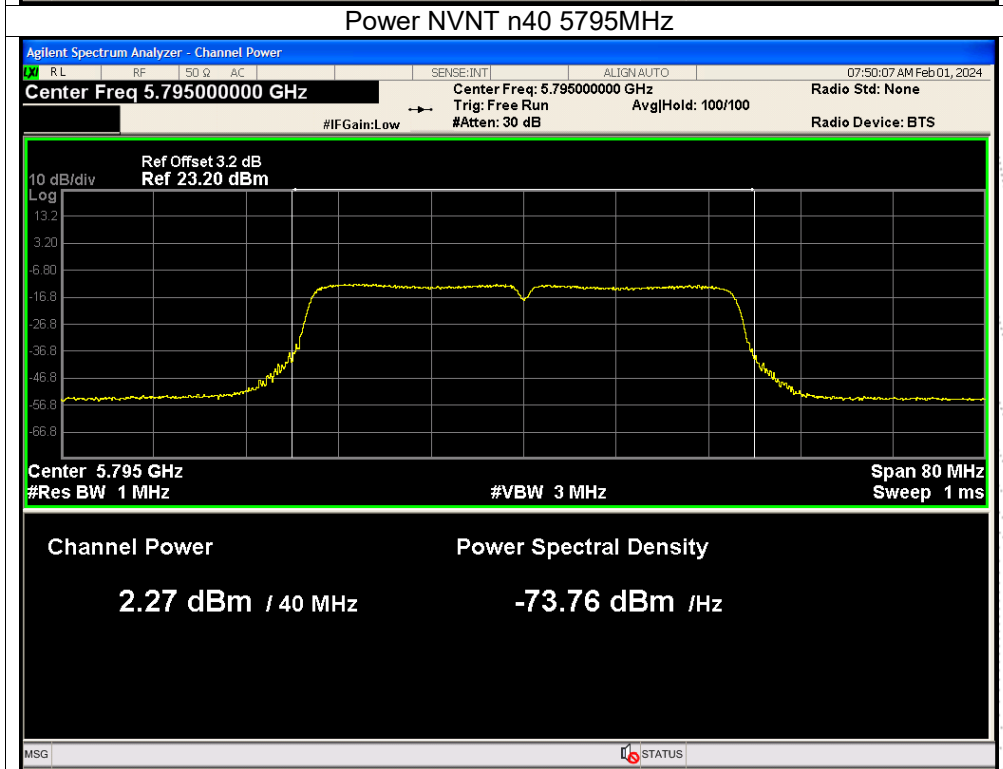
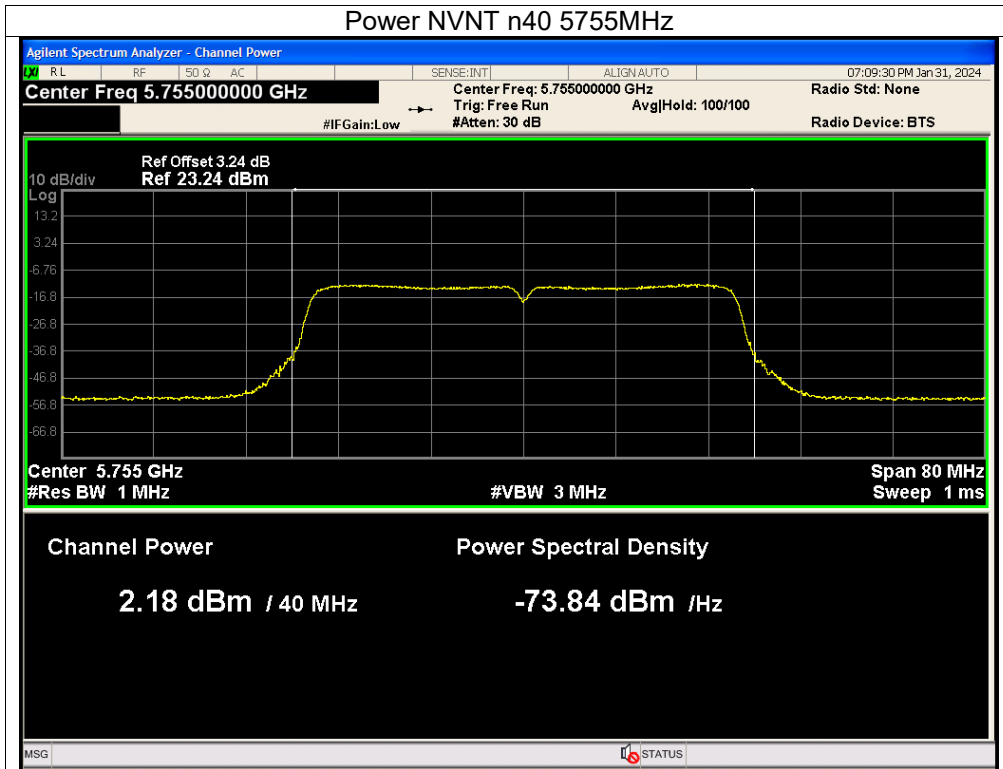

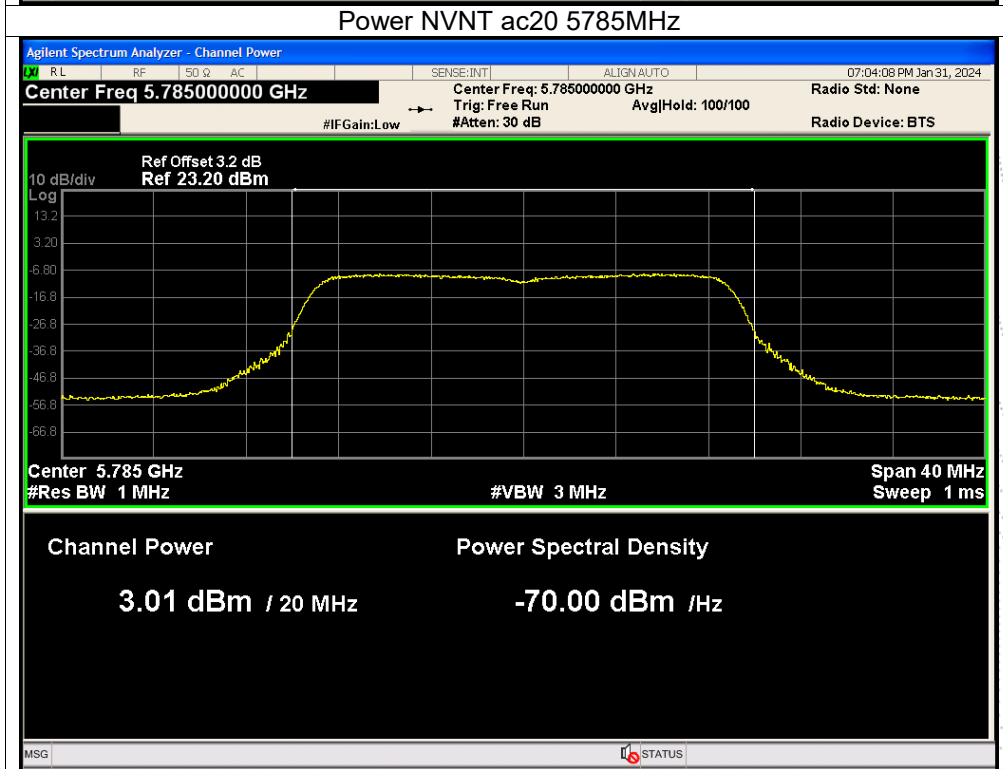
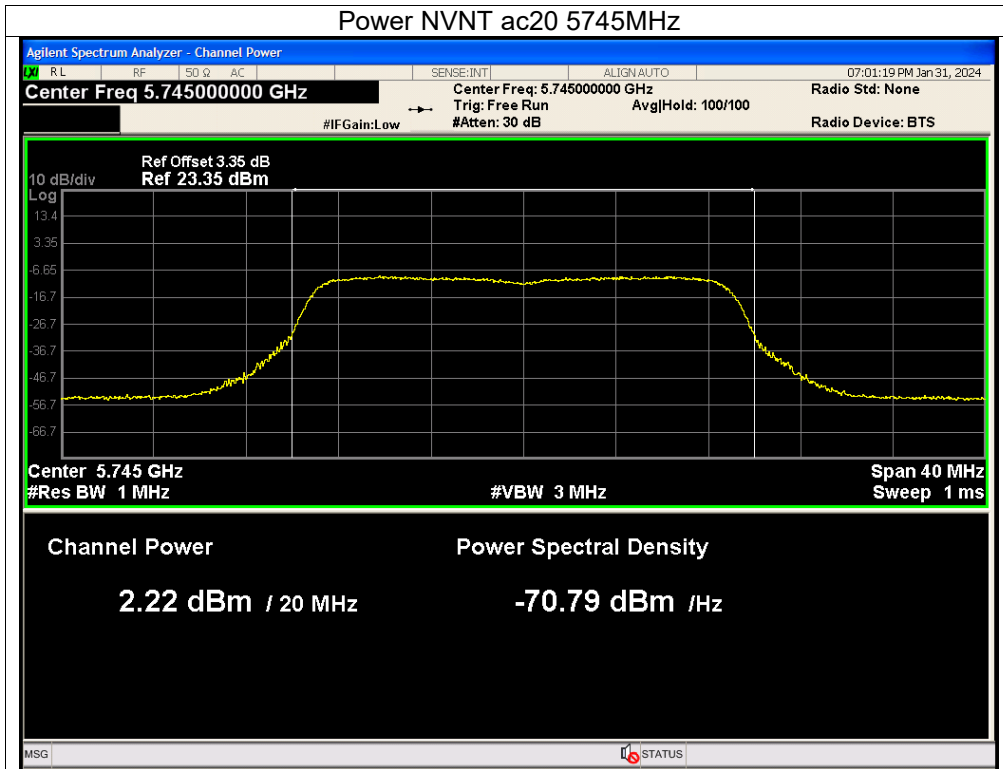

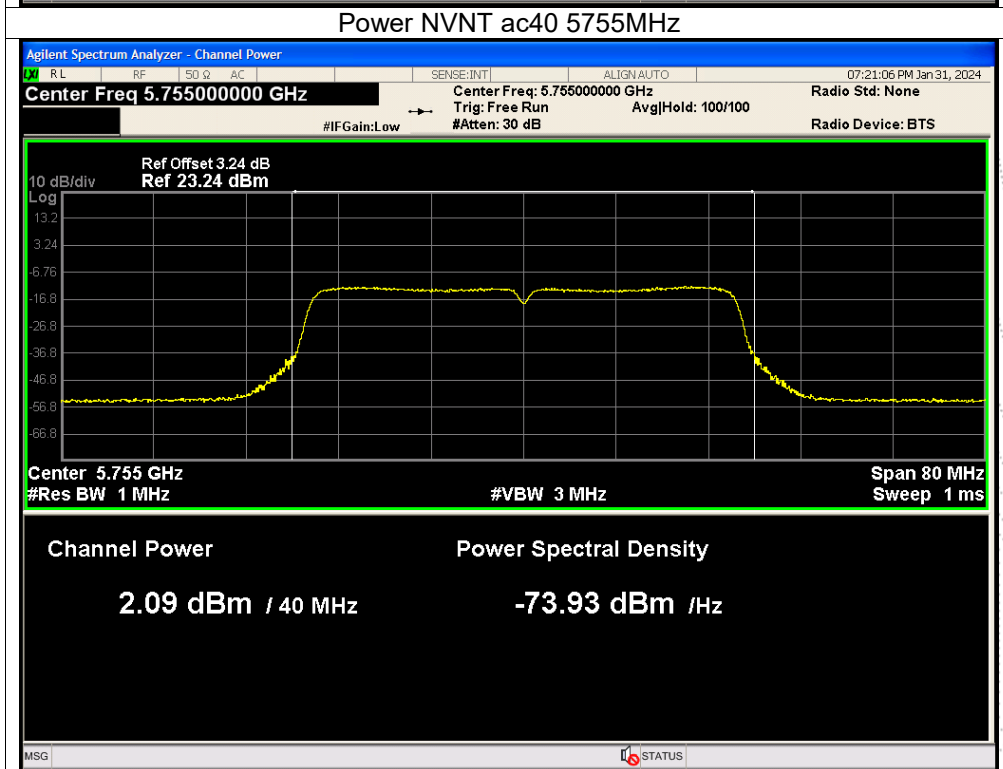
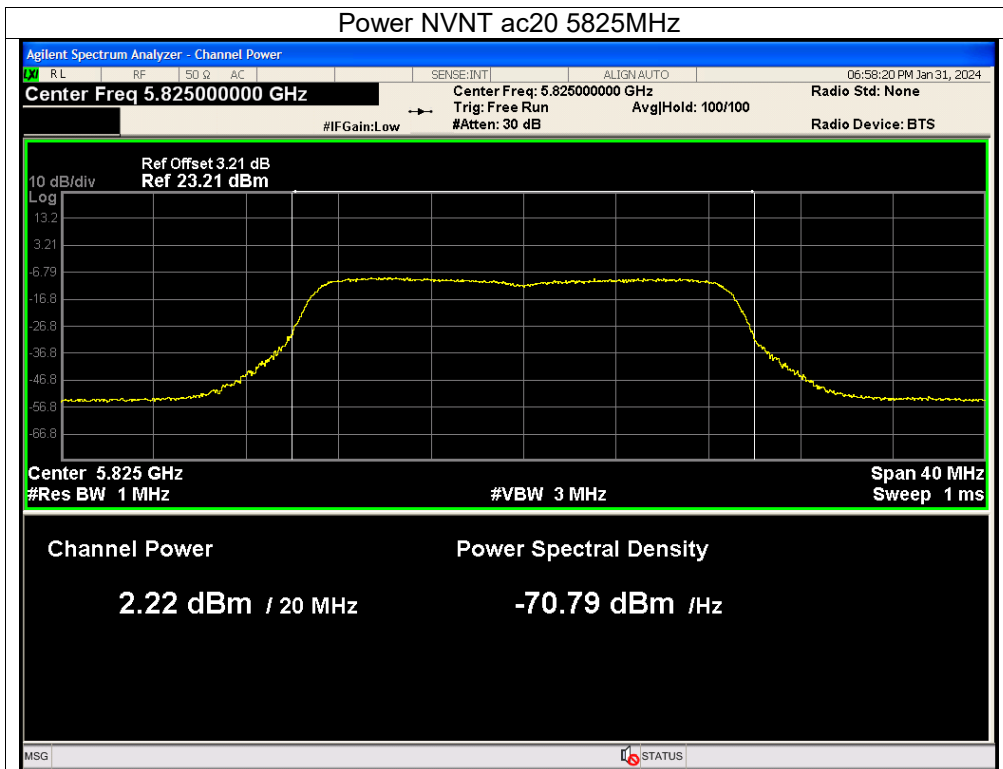

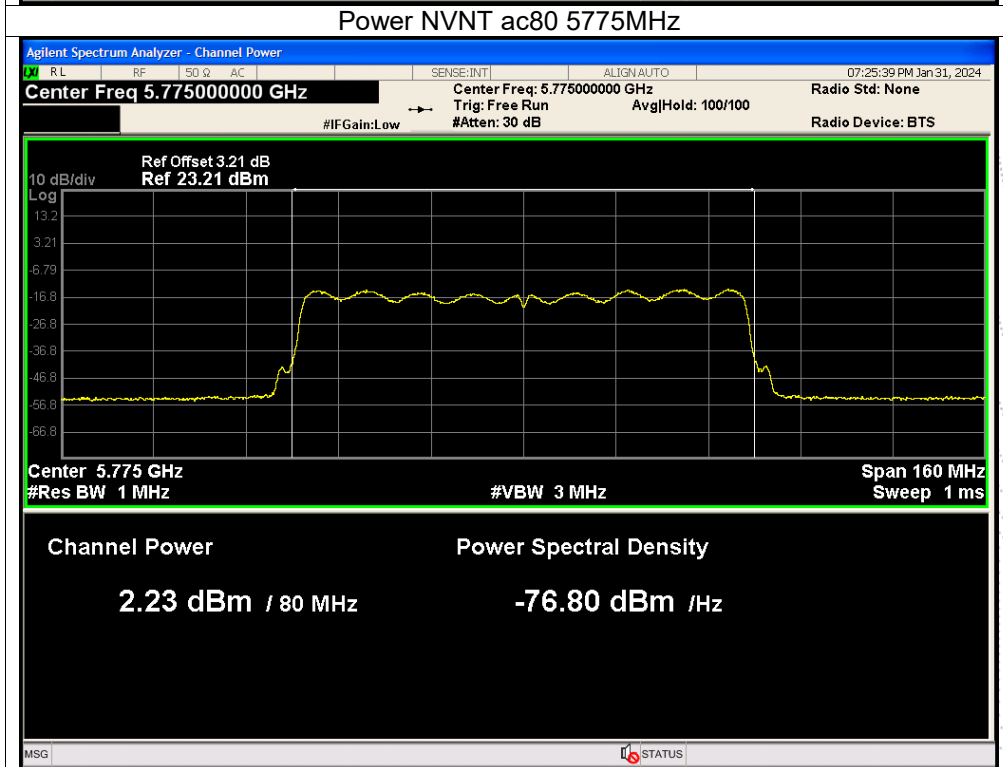
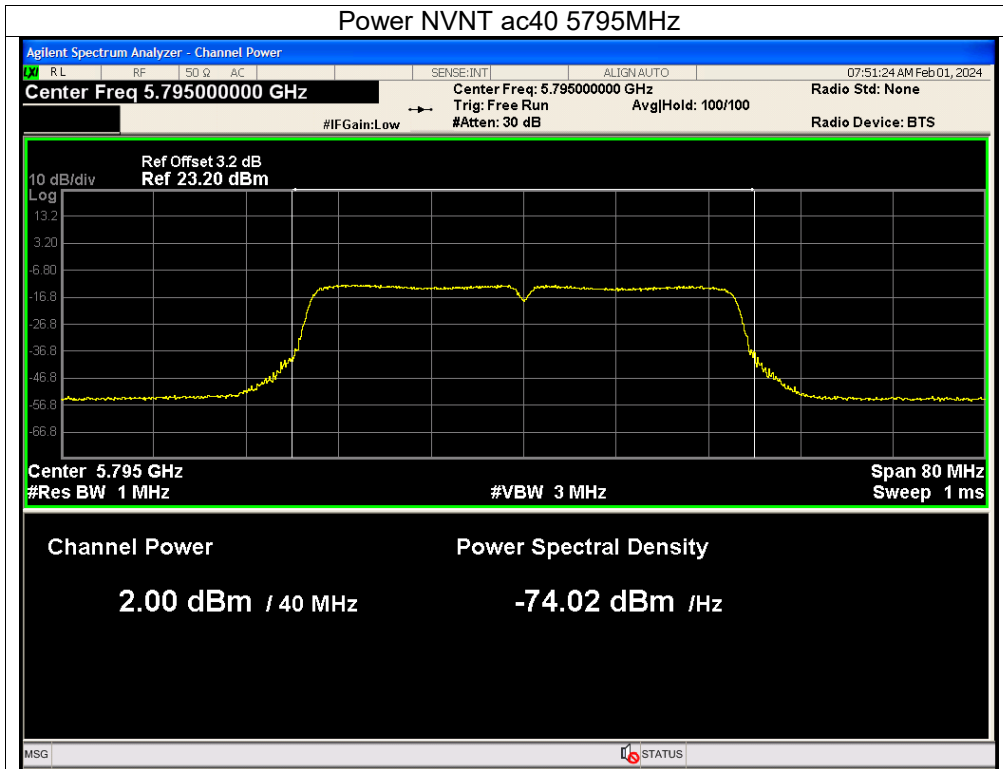

## 9. 26dB & 6dB & 99% Emission Bandwidth

### 9.1 Block Diagram Of Test Setup

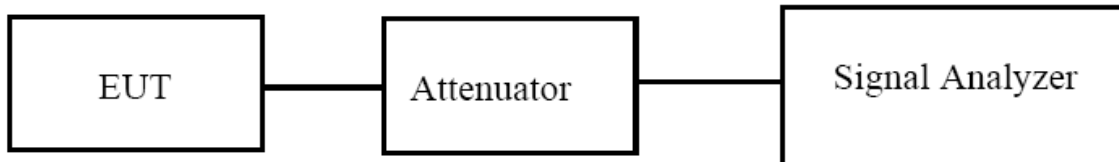

### 9.2 Limit

The maximum power spectral density is measured as a conducted emission by direct connection of a calibrated test instrument to the equipment under test. If the device cannot be connected directly, alternative techniques acceptable to the Commission may be used. Measurements in the 5.725-5.85 GHz band are made over a reference bandwidth of 500 kHz or the 26 dB emission bandwidth of the device, whichever is less. Measurements in the 5.15-5.25 GHz, 5.25-5.35 GHz, and the 5.47-5.725 GHz bands are made over a bandwidth of 1 MHz or the 26 dB emission bandwidth of the device, whichever is less. A narrower resolution bandwidth can be used, provided that the measured power is integrated over the full reference bandwidth.  
(6dB bandwidth)>500kHz

### 9.3 Test Procedure

- a) Set RBW = approximately 1% of the emission bandwidth.
- b) Set the VBW > RBW.
- c) Detector = Peak.
- d) Trace mode = max hold.
- e) Measure the maximum width of the emission that is 26 dB down from the maximum of the emission. Compare this with the RBW setting of the analyzer. Readjust RBW and repeat measurement as needed until the RBW/EBW ratio is approximately 1%.

The following procedure shall be used for measuring (99 %) power bandwidth:

1. Set center frequency to the nominal EUT channel center frequency.
2. Set span = 1.5 times to 5.0 times the OBW.
3. Set RBW = 1 % to 5 % of the OBW
4. Set VBW  $\geq 3 \cdot$  RBW
5. Video averaging is not permitted. Where practical, a sample detection and single sweep mode shall be used. Otherwise, peak detection and max hold mode (until the trace stabilizes) shall be used.
6. Use the 99 % power bandwidth function of the instrument (if available).
7. If the instrument does not have a 99 % power bandwidth function, the trace data points are recovered and directly summed in power units. The recovered amplitude data points, beginning at the lowest frequency, are placed in a running sum until 0.5 % of the total is reached; that frequency is recorded as the lower frequency. The process is repeated until 99.5 % of the total is reached; that frequency is recorded as the upper frequency. The 99% occupied bandwidth is the difference between these two frequencies.

6dB

1. Set RBW = 100 kHz.
2. Set the video bandwidth (VBW)  $\geq 3 \times$  RBW.
3. Detector = Peak.
4. Trace mode = max hold.
5. Sweep = auto couple.

6. Allow the trace to stabilize.
7. Measure the maximum width of the emission that is constrained by the frequencies associated with the two outermost amplitude points (upper and lower frequencies) that are attenuated by 6 dB relative to the maximum level measured in the fundamental emission.

#### 9.4 EUT Operating Conditions

The EUT was configured for testing in a typical fashion (as a customer would normally use it). The EUT has been programmed to continuously transmit during test. This operating condition was tested and used to collect the included data.

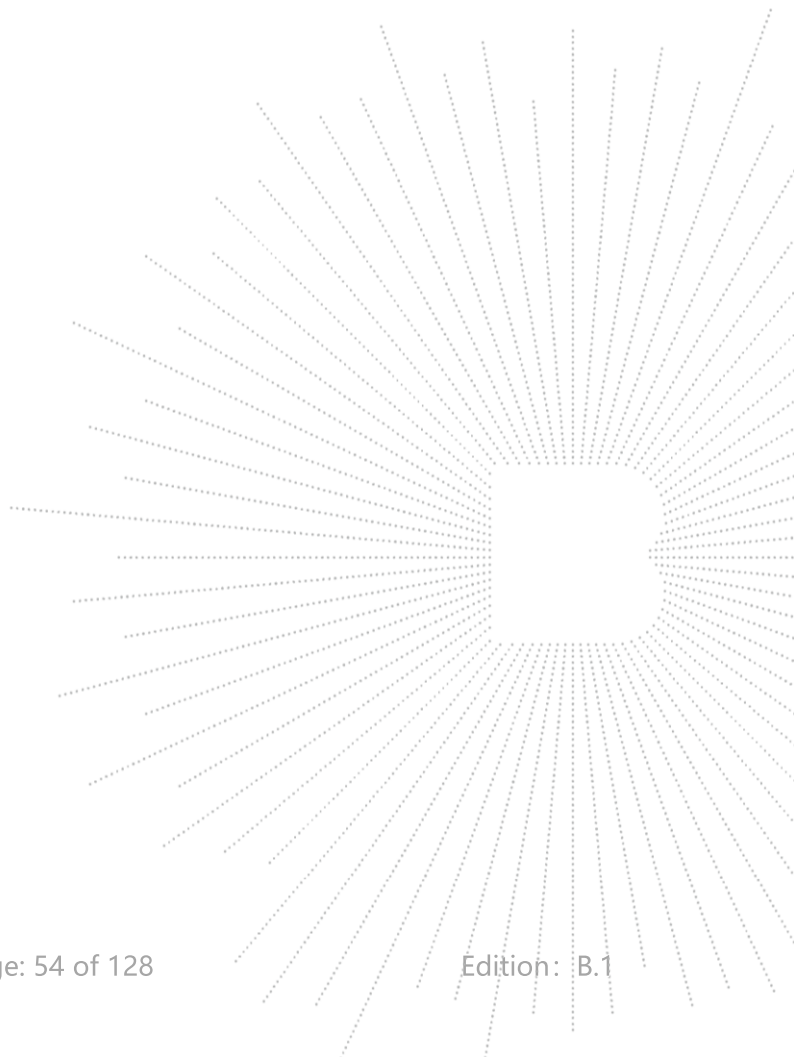

## 9.5 Test Result

Temperature:	26 °C	Relative Humidity:	54%
Pressure:	101kPa	Test Voltage:	DC 12V
Test Mode:	TX Frequency U-NII-1 (5180-5240MHz)		

Condition	Mode	Frequency (MHz)	-26 dB Bandwidth (MHz)		99% OBW (MHz)		Verdict
			Ant A	Ant B	Ant A	Ant B	
NVNT	a	5180	20.746	20.785	16.579	16.553	Pass
NVNT	a	5200	21.039	20.545	16.543	16.517	Pass
NVNT	a	5240	20.478	20.507	16.507	16.56	Pass
NVNT	n20	5180	20.724	21.421	16.555	17.713	Pass
NVNT	n20	5200	20.867	21.498	16.565	17.687	Pass
NVNT	n20	5240	21.171	21.505	16.566	17.714	Pass
NVNT	n40	5190	43.519	43.379	36.272	36.227	Pass
NVNT	n40	5230	43.818	43.223	36.309	36.233	Pass
NVNT	ac20	5180	21.507	21.117	17.676	17.681	Pass
NVNT	ac20	5200	21.288	21.498	17.711	17.717	Pass
NVNT	ac20	5240	21.602	21.534	17.71	17.705	Pass
NVNT	ac40	5190	43.935	43.621	36.256	36.269	Pass
NVNT	ac40	5230	43.569	43.78	36.221	36.267	Pass
NVNT	ac80	5210	<b>83.182</b>	82.88	75.856	<b>75.921</b>	Pass

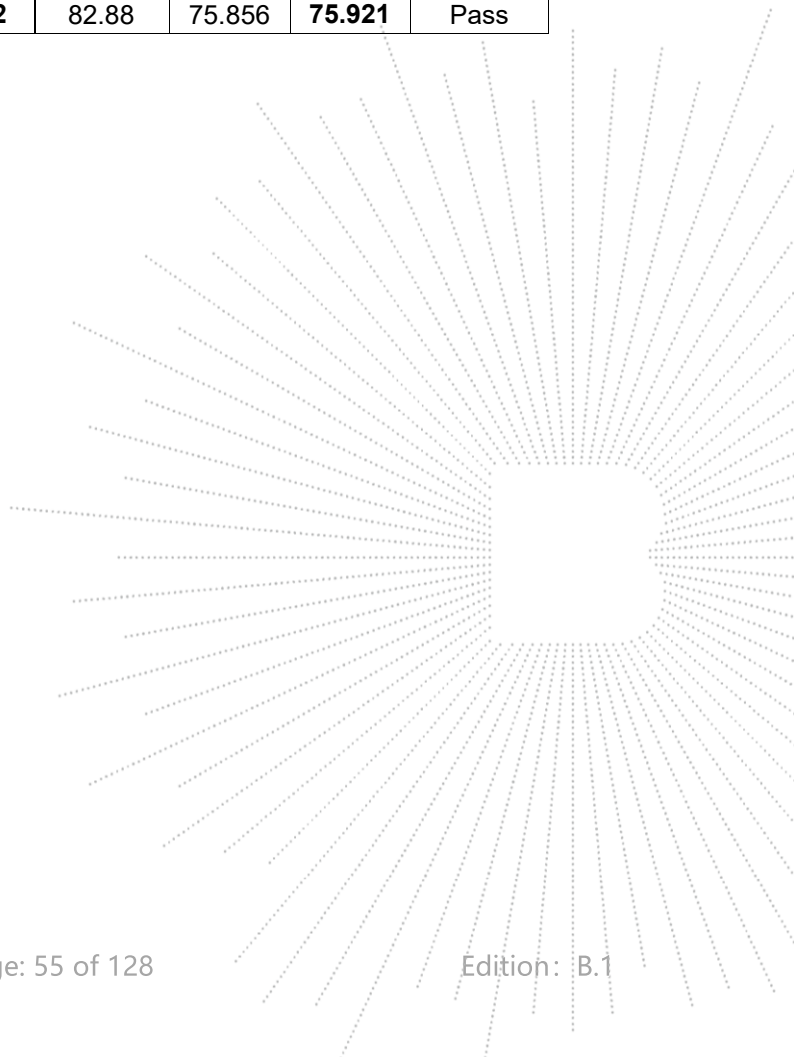

Note: A(B) Represent the value of antenna A and B, The worst data is Antenna A, only shown Antenna A Plot.

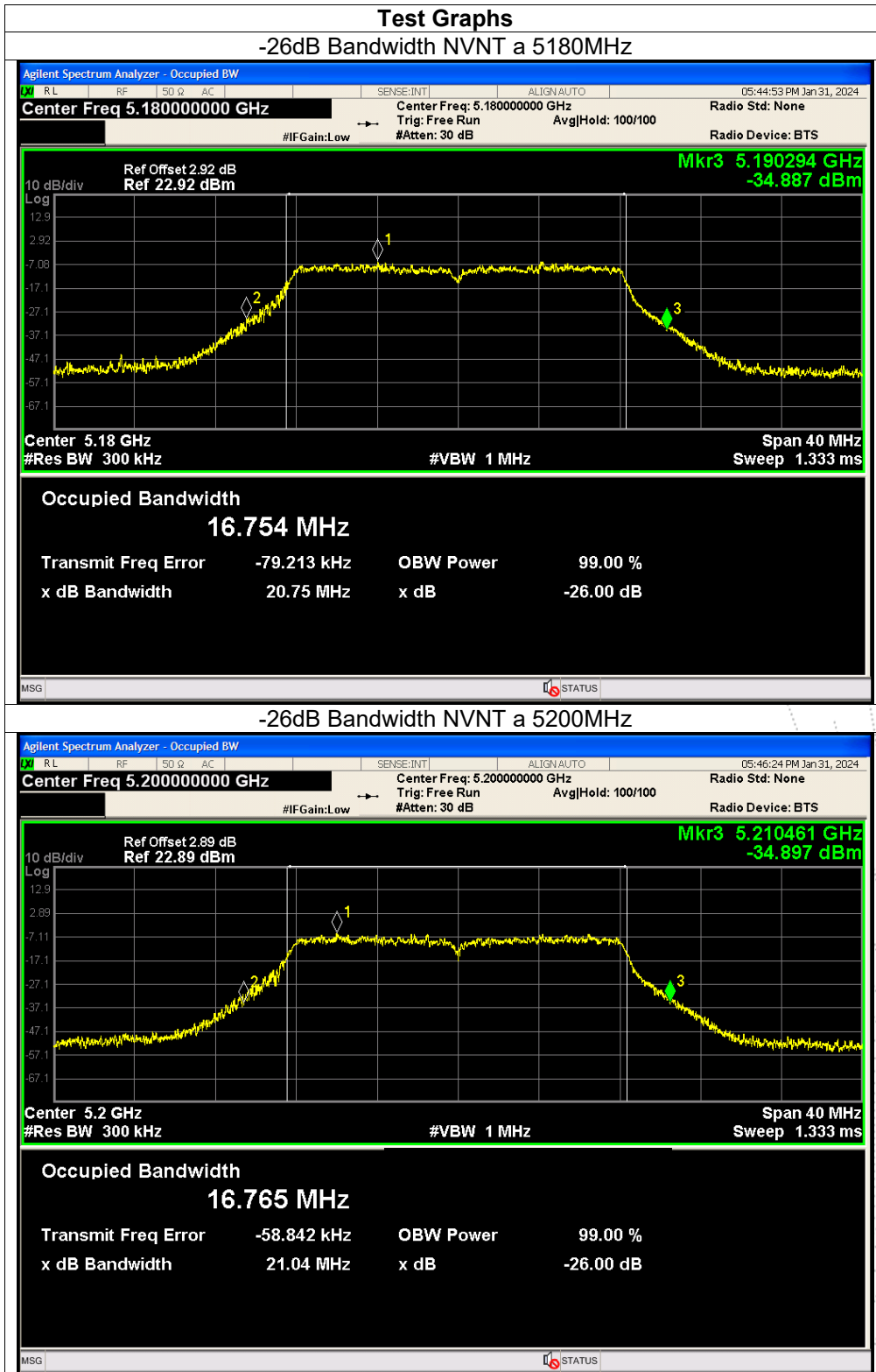



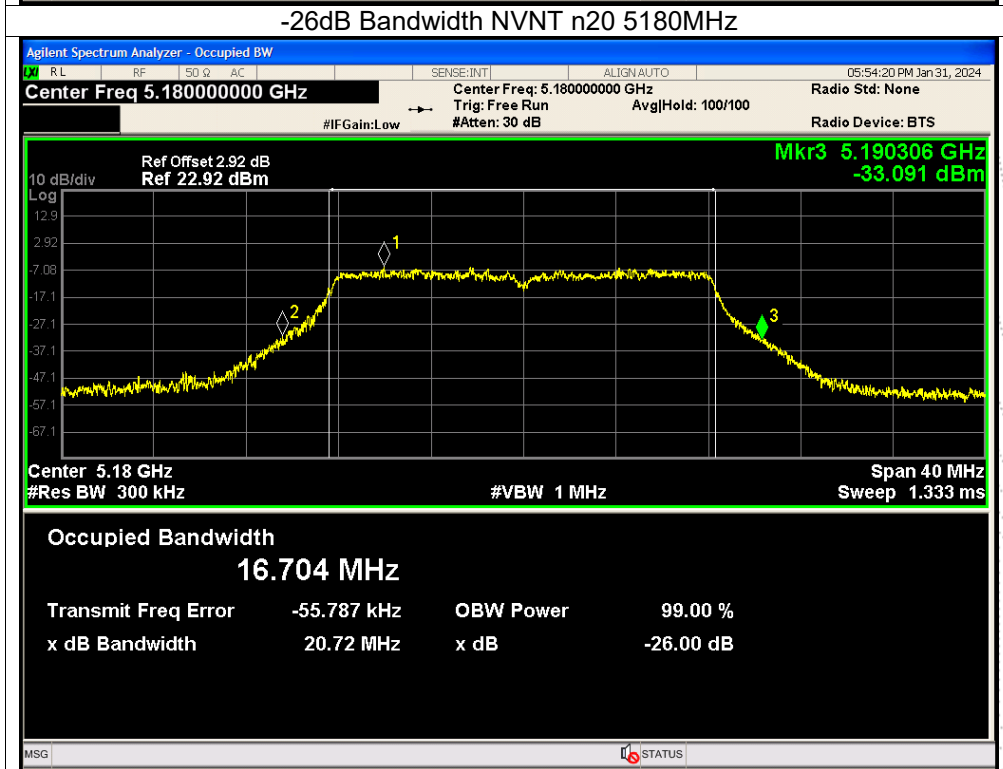
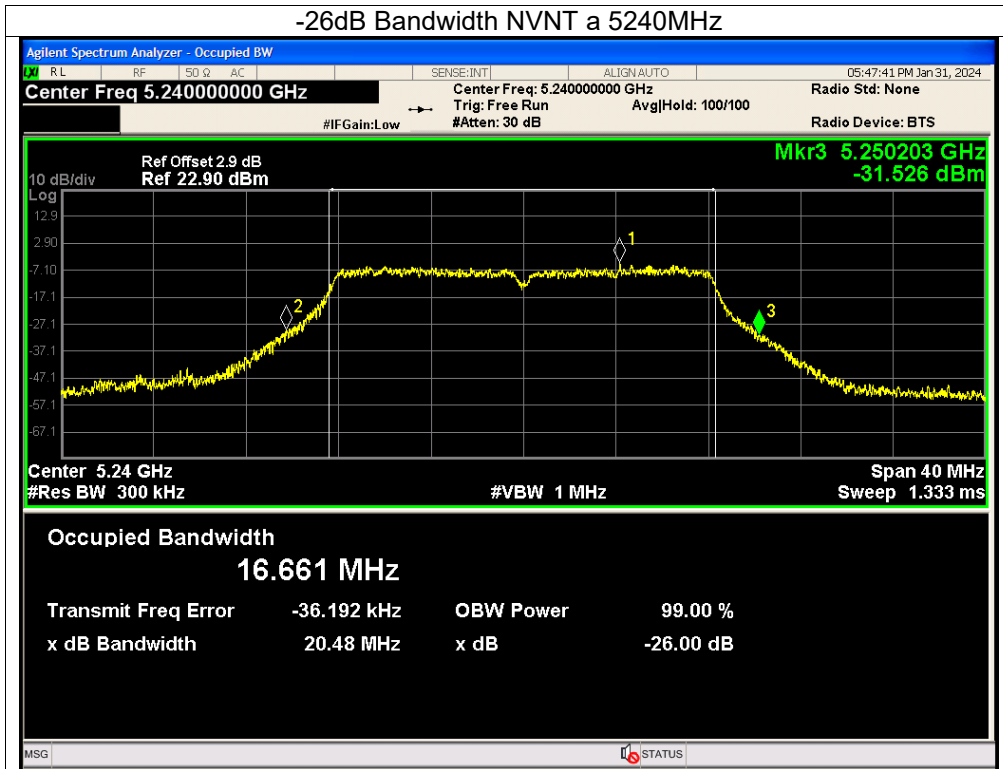

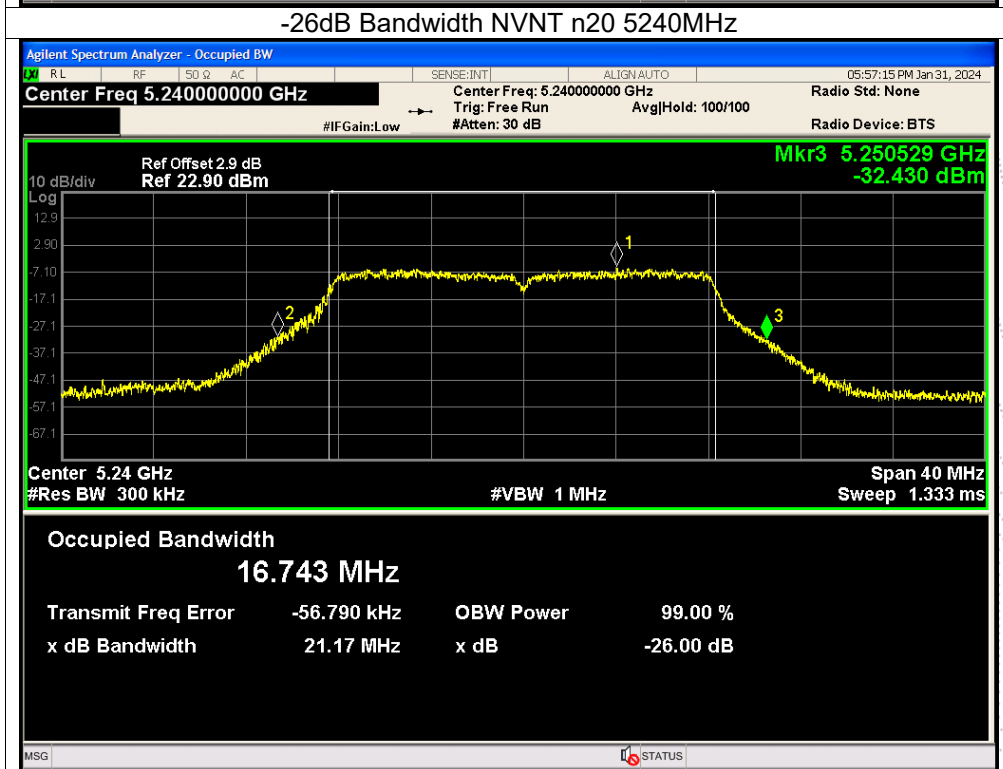
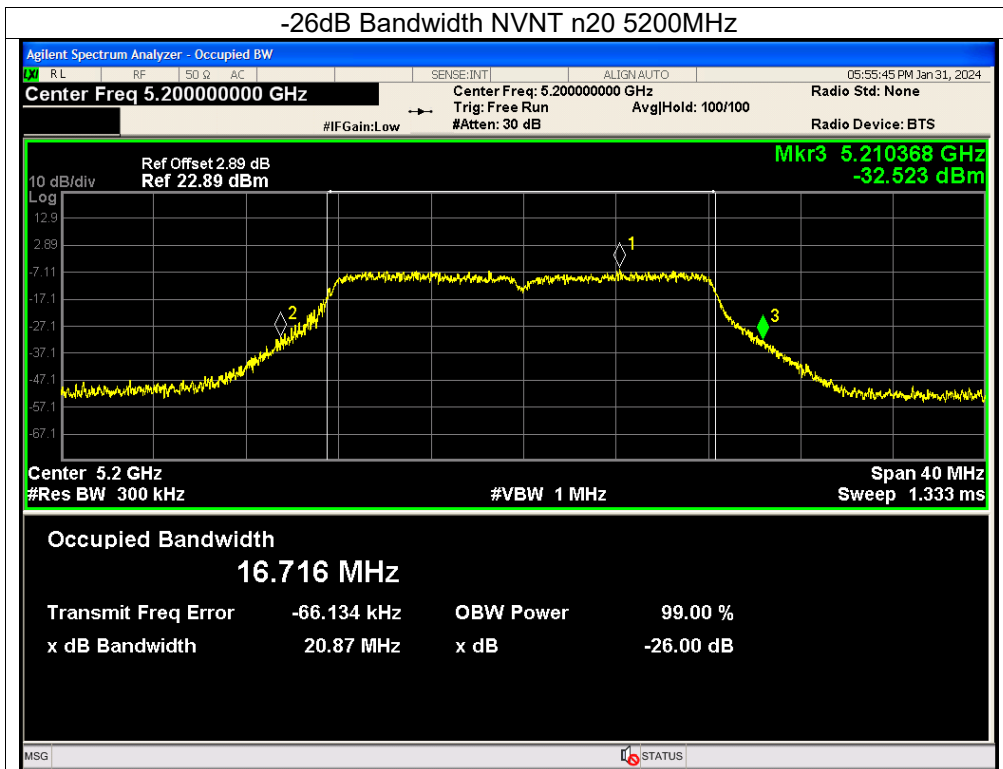

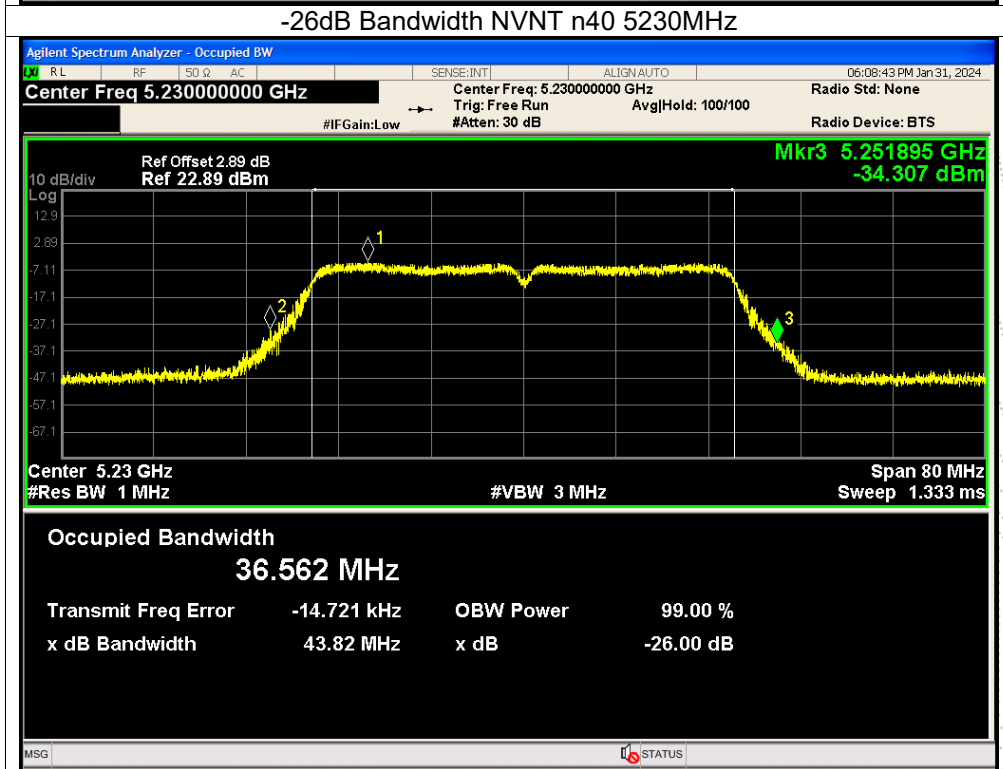
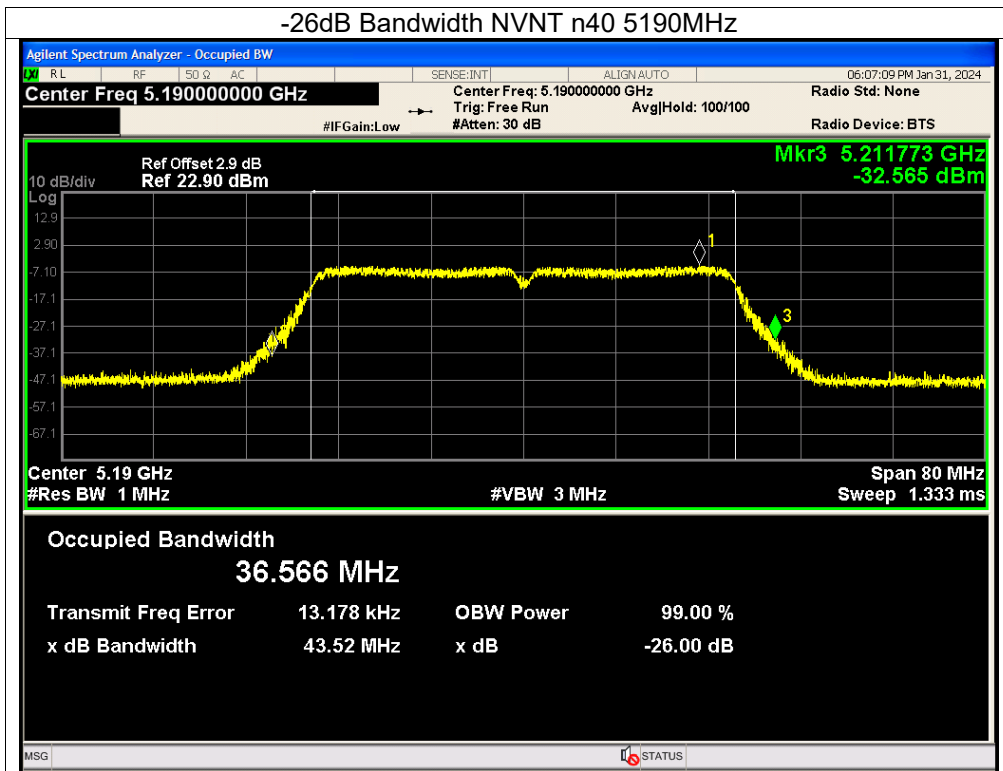

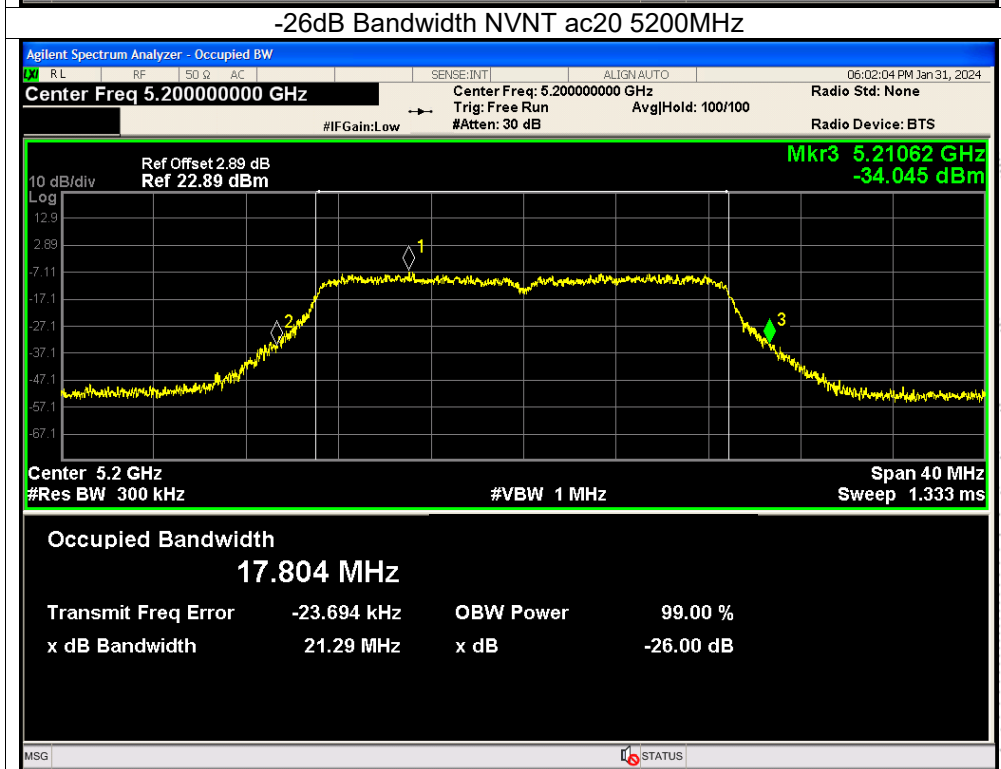
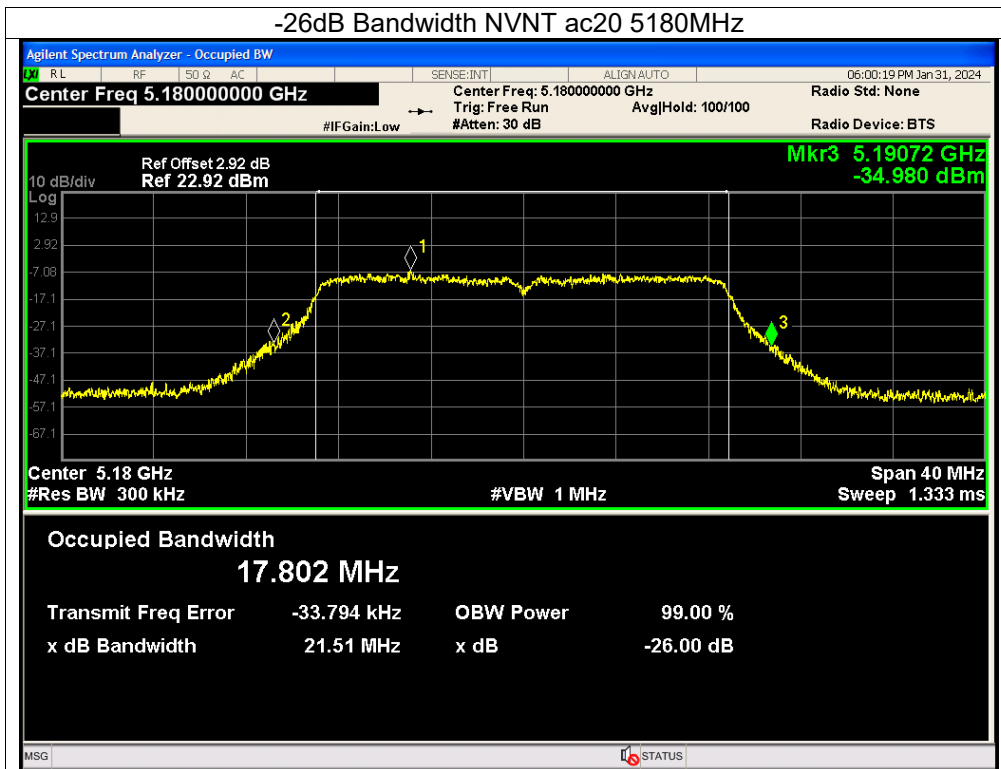

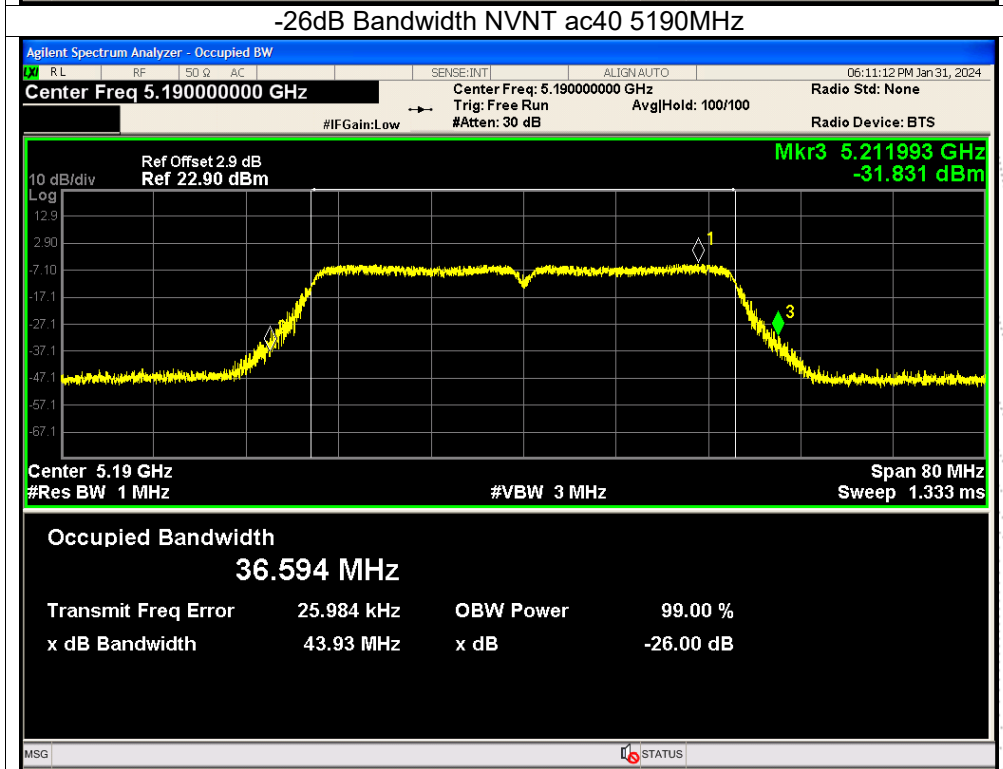
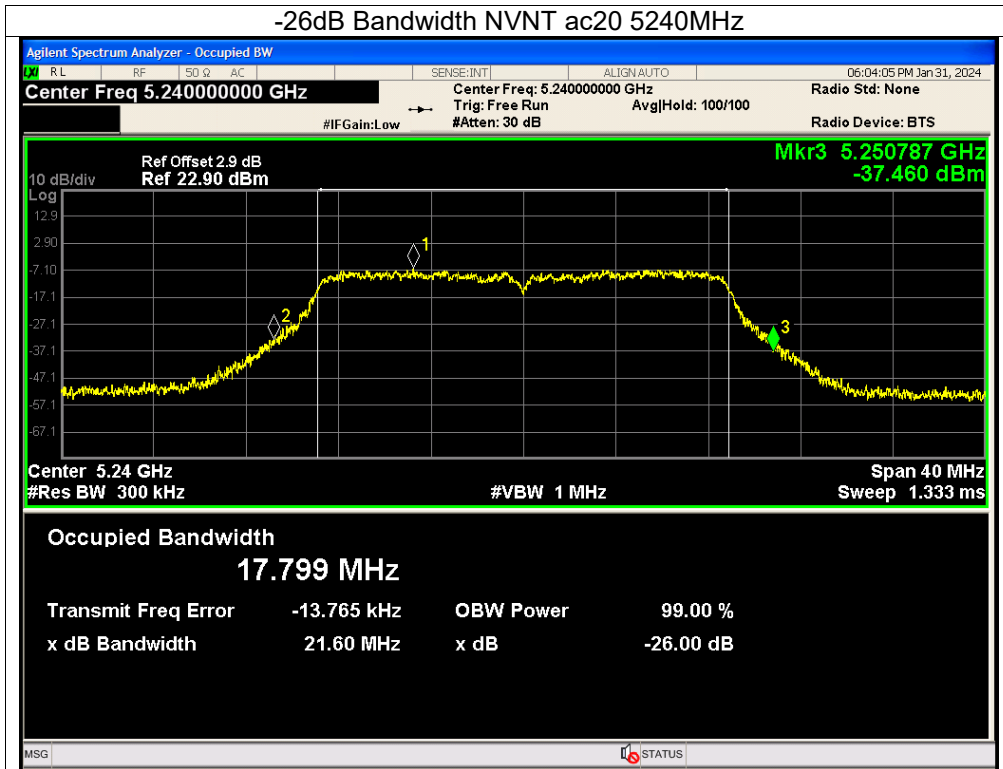

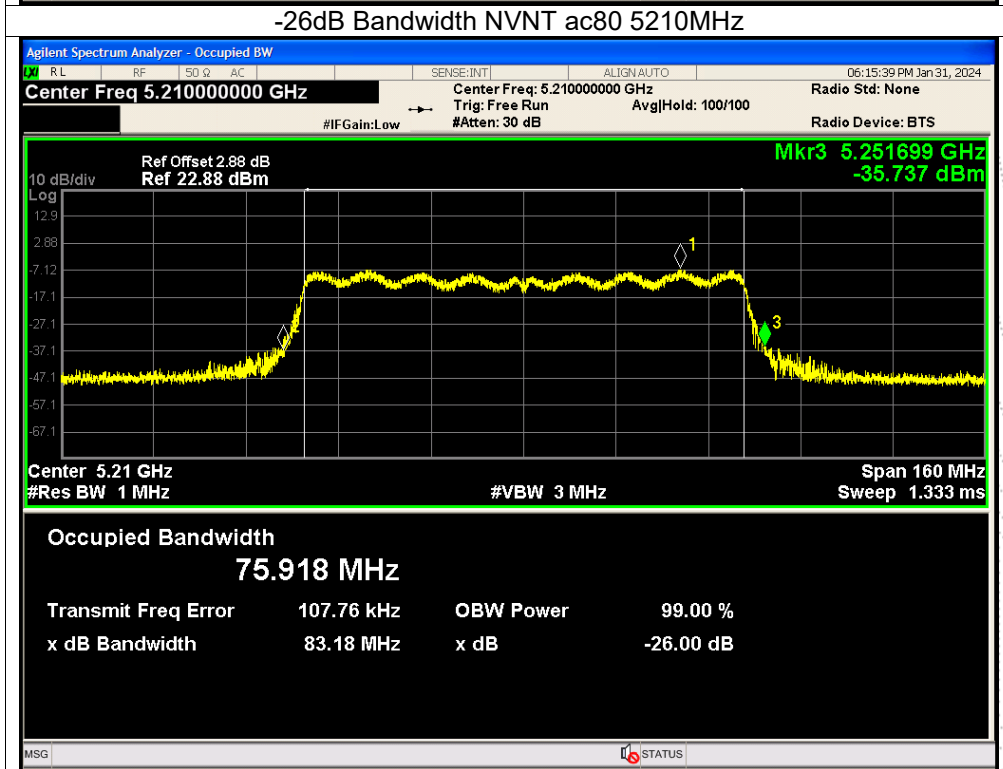
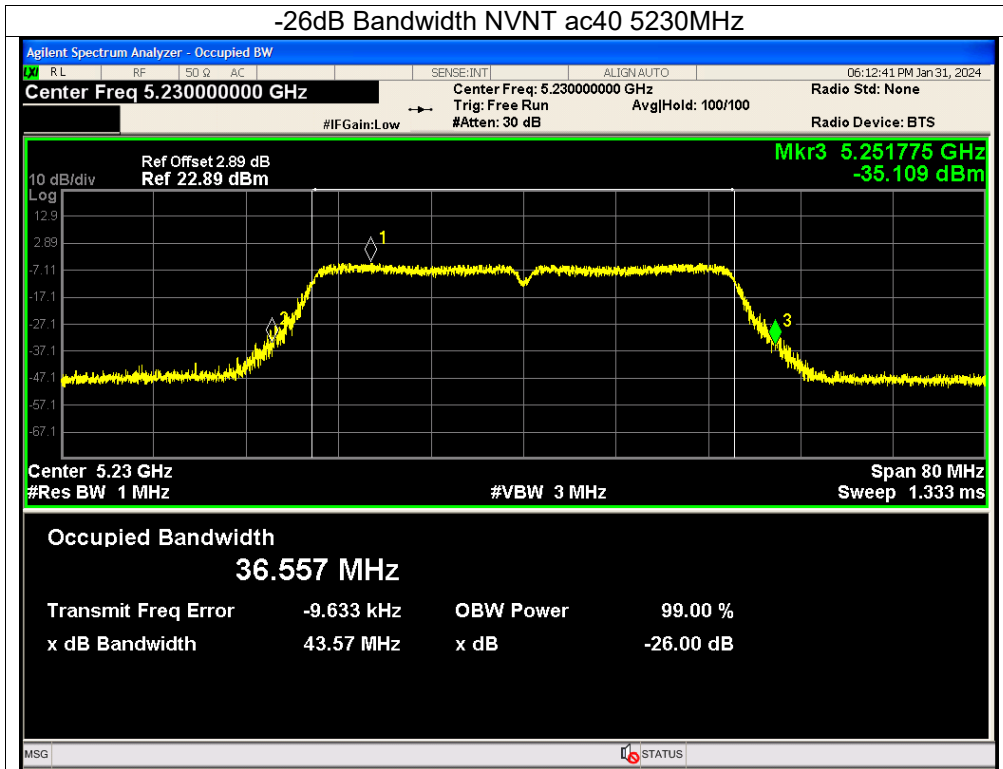

Note: A(B) Represent the value of antenna A and B, The worst data is Antenna B, only shown Antenna B Plot.

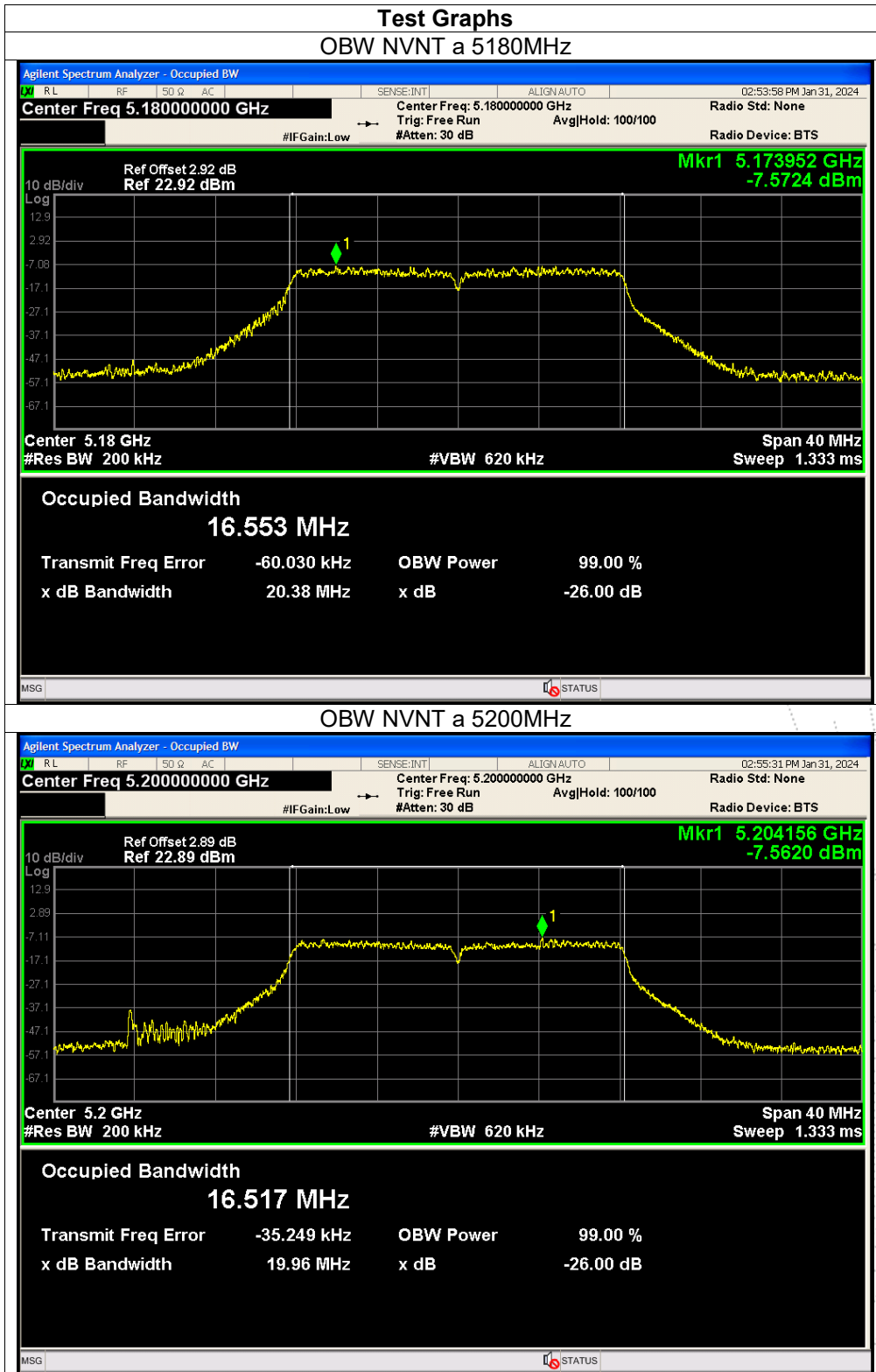

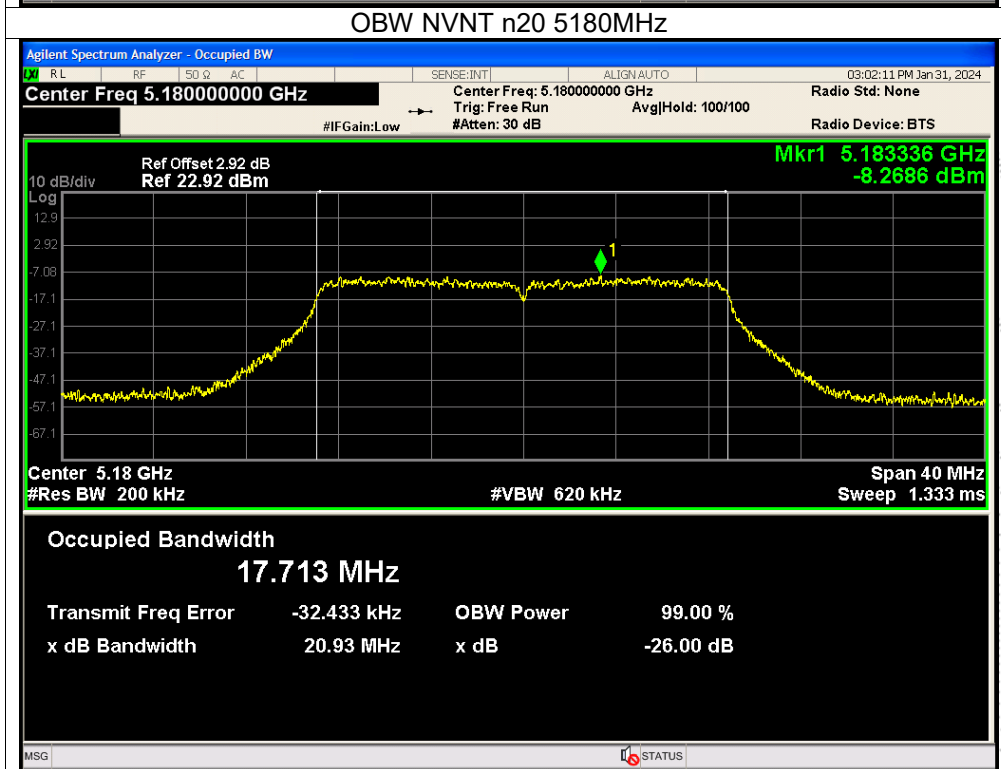
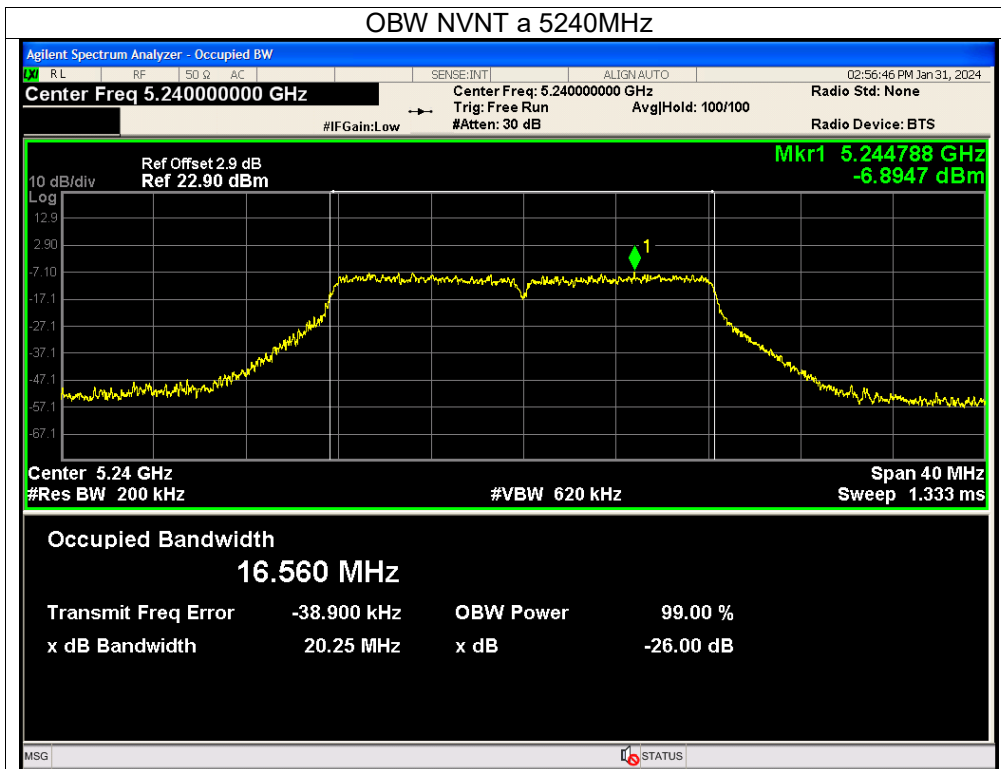



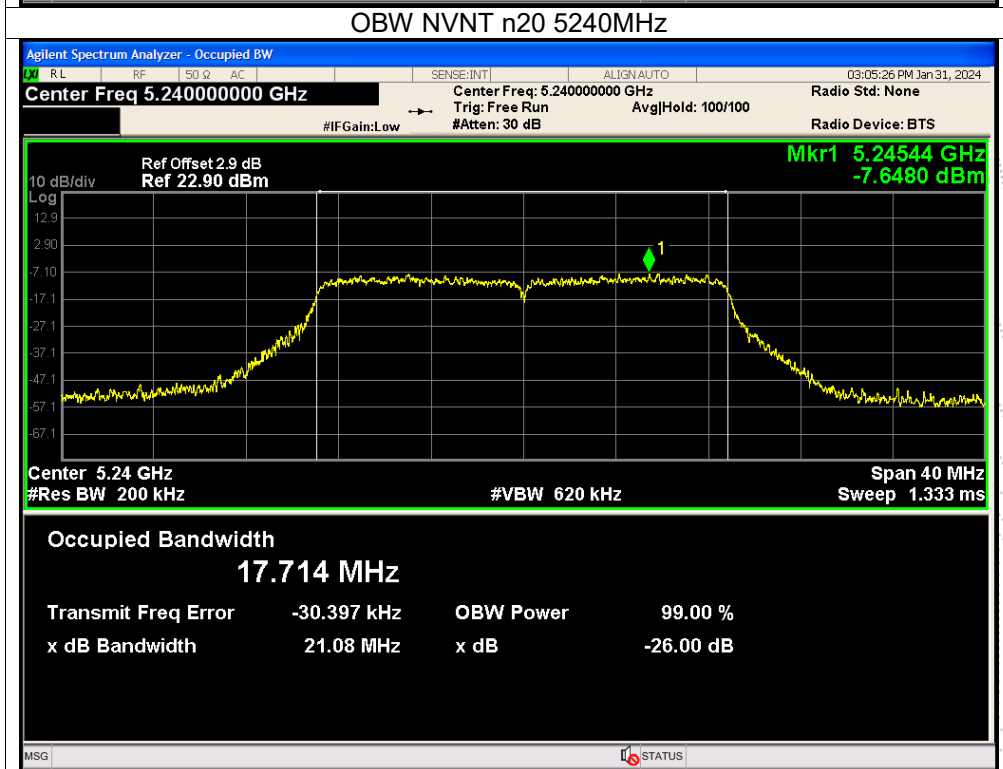
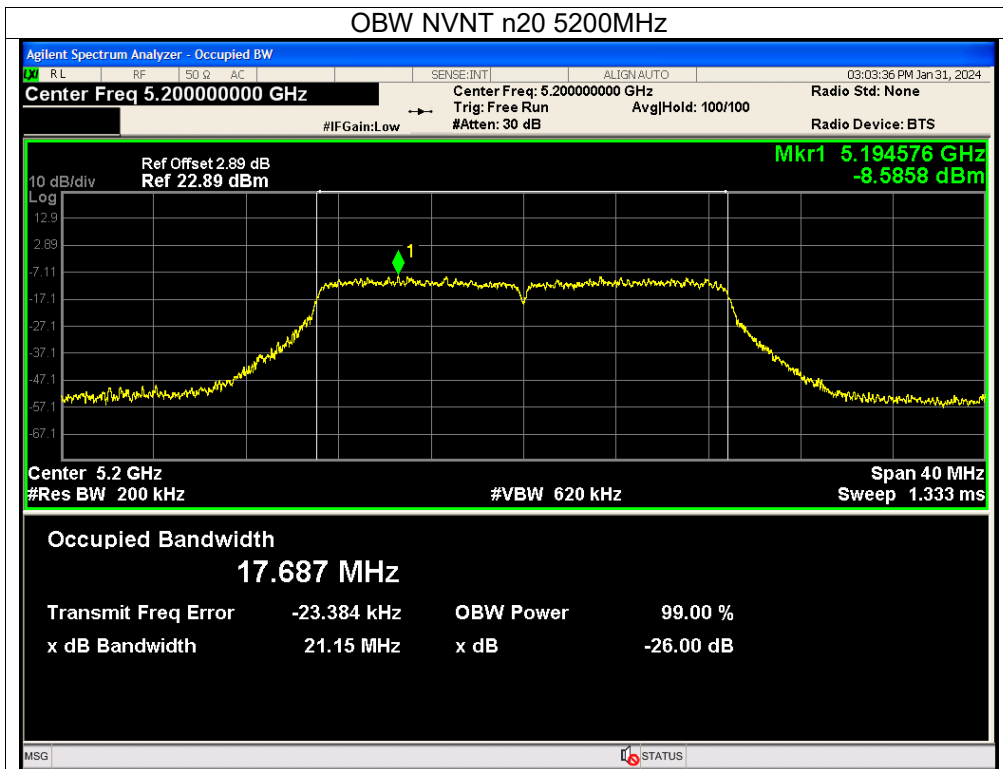

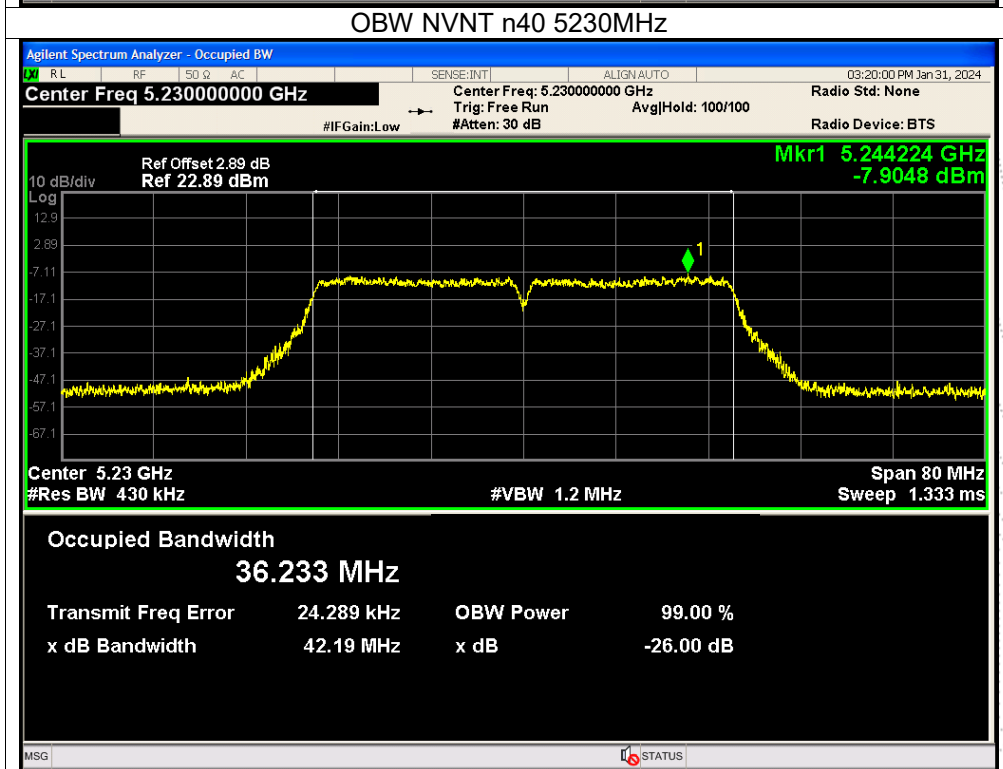
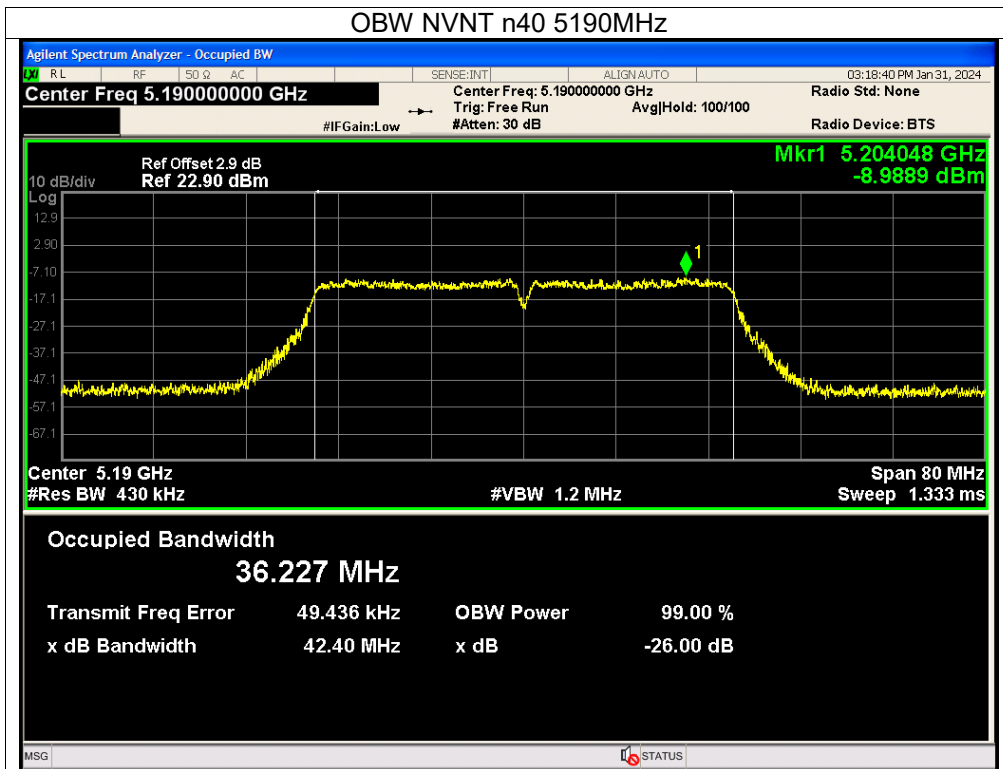

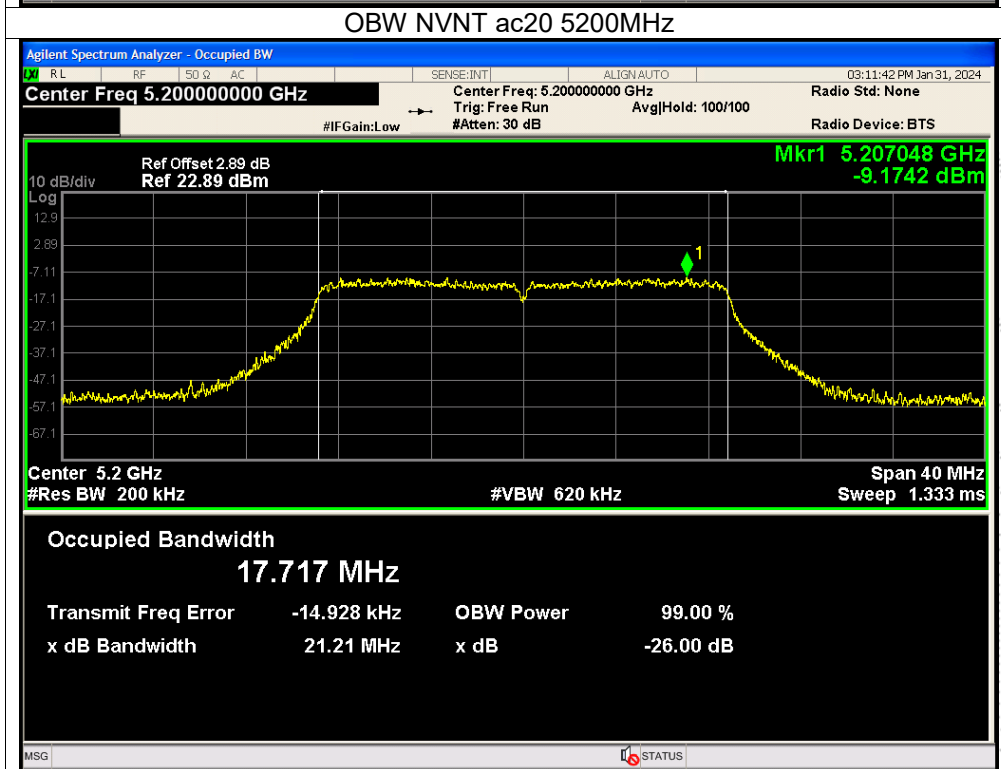
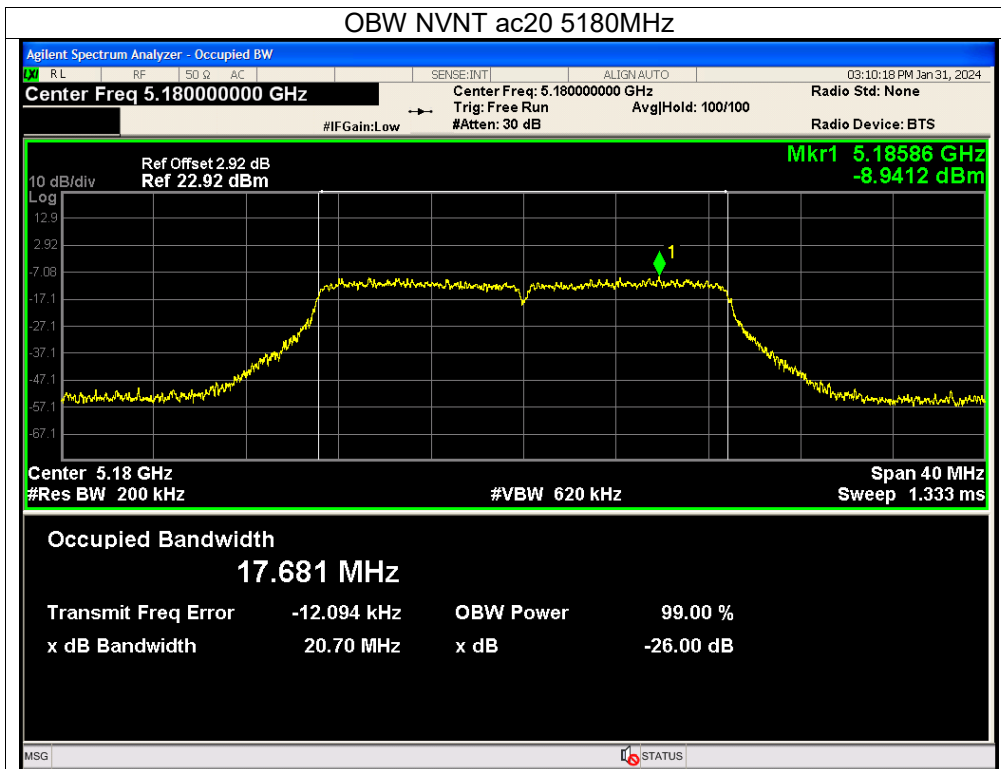

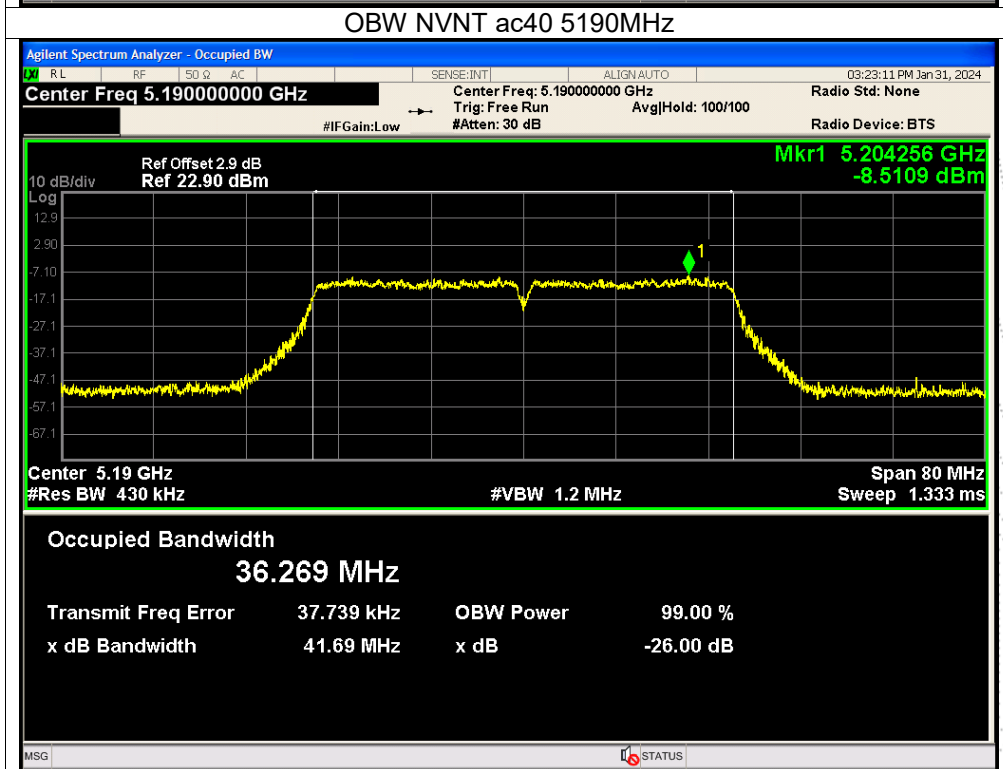
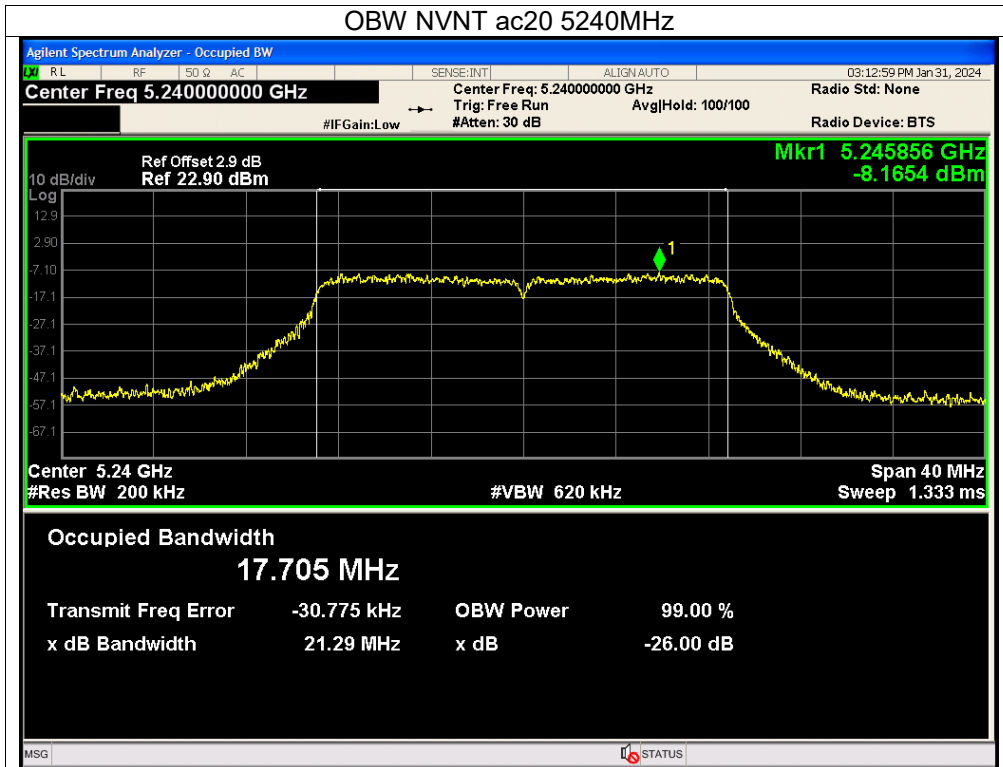

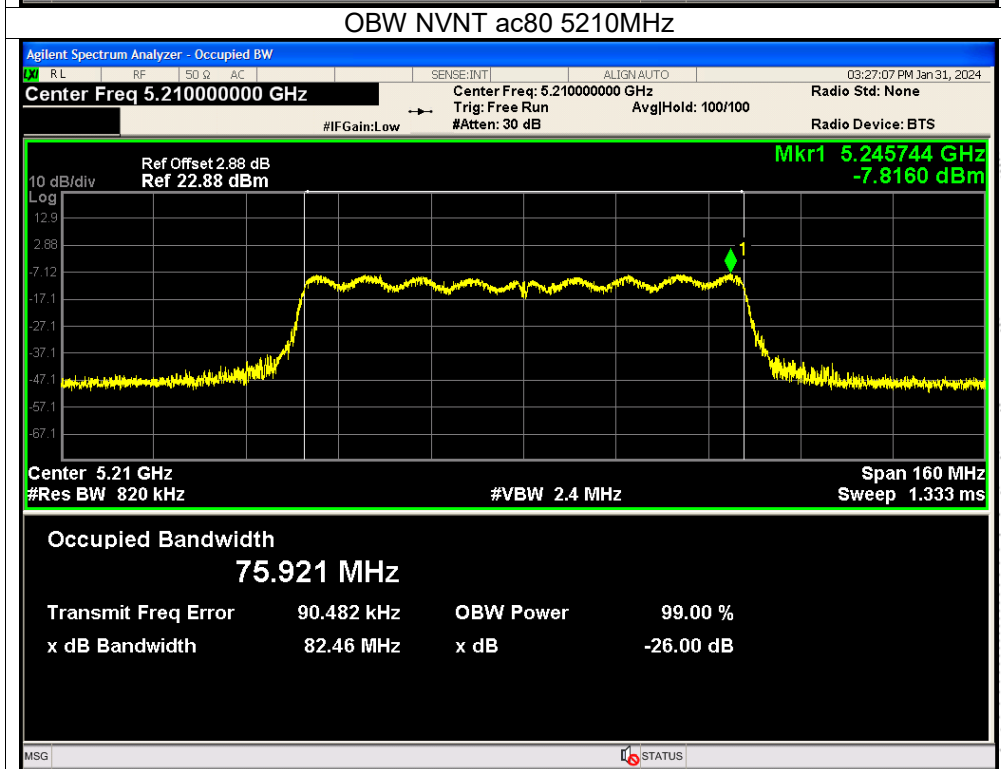
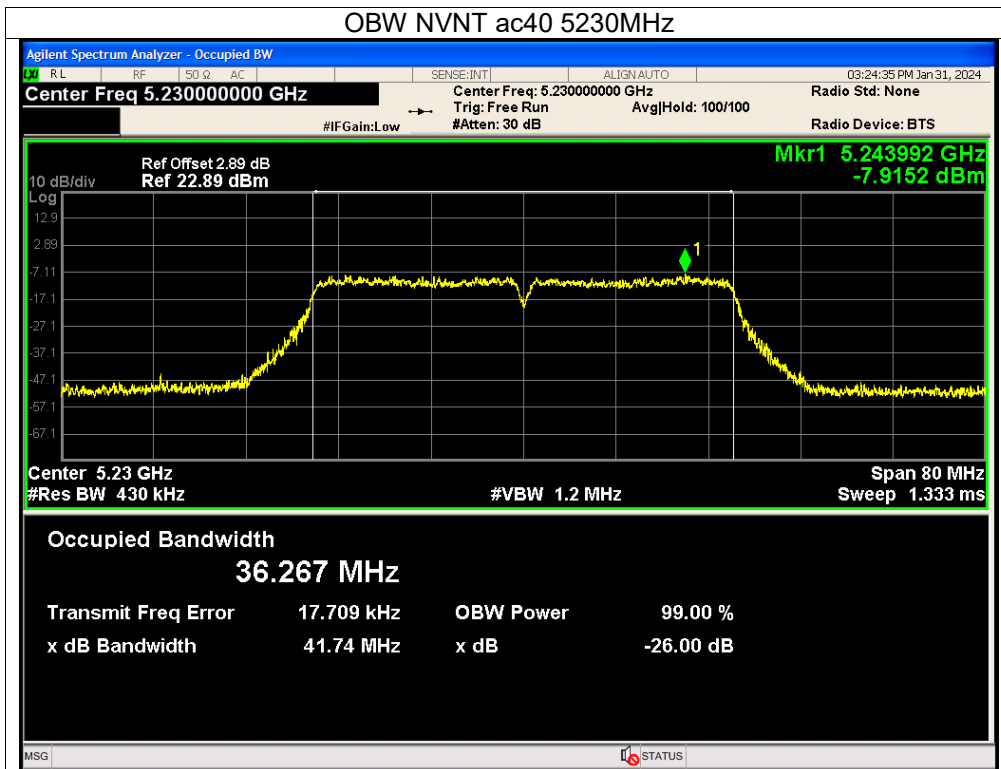

Temperature :	26 °C	Relative Humidity :	54%
Pressure :	101kPa	Test Voltage :	DC 12V
Test Mode :	TX Frequency U-NII-3(5745-5825MHz)		

Condition	Mode	Frequency (MHz)	-6 dB Bandwidth (MHz)		99% OBW (MHz)		Limit -6 dB Bandwidth (MHz)	Verdict
			Ant A	Ant B	Ant A	Ant B		
NVNT	a	5745	16.517	16.531	16.526	16.533	0.5	Pass
NVNT	a	5785	16.528	16.526	16.55	16.529	0.5	Pass
NVNT	a	5825	16.551	16.502	16.559	16.54	0.5	Pass
NVNT	n20	5745	16.519	17.704	16.516	17.658	0.5	Pass
NVNT	n20	5785	16.531	17.75	16.512	17.716	0.5	Pass
NVNT	n20	5825	16.573	17.664	16.585	17.707	0.5	Pass
NVNT	n40	5755	36.467	36.436	36.233	36.286	0.5	Pass
NVNT	n40	5795	36.464	36.479	36.261	36.224	0.5	Pass
NVNT	ac20	5745	17.709	17.668	17.647	17.681	0.5	Pass
NVNT	ac20	5785	17.71	17.776	17.65	17.683	0.5	Pass
NVNT	ac20	5825	17.705	17.73	17.667	17.7	0.5	Pass
NVNT	ac40	5755	36.439	36.409	36.263	36.326	0.5	Pass
NVNT	ac40	5795	36.47	36.451	36.291	36.29	0.5	Pass
NVNT	ac80	5775	76.366	<b>76.381</b>	<b>75.872</b>	75.848	0.5	Pass

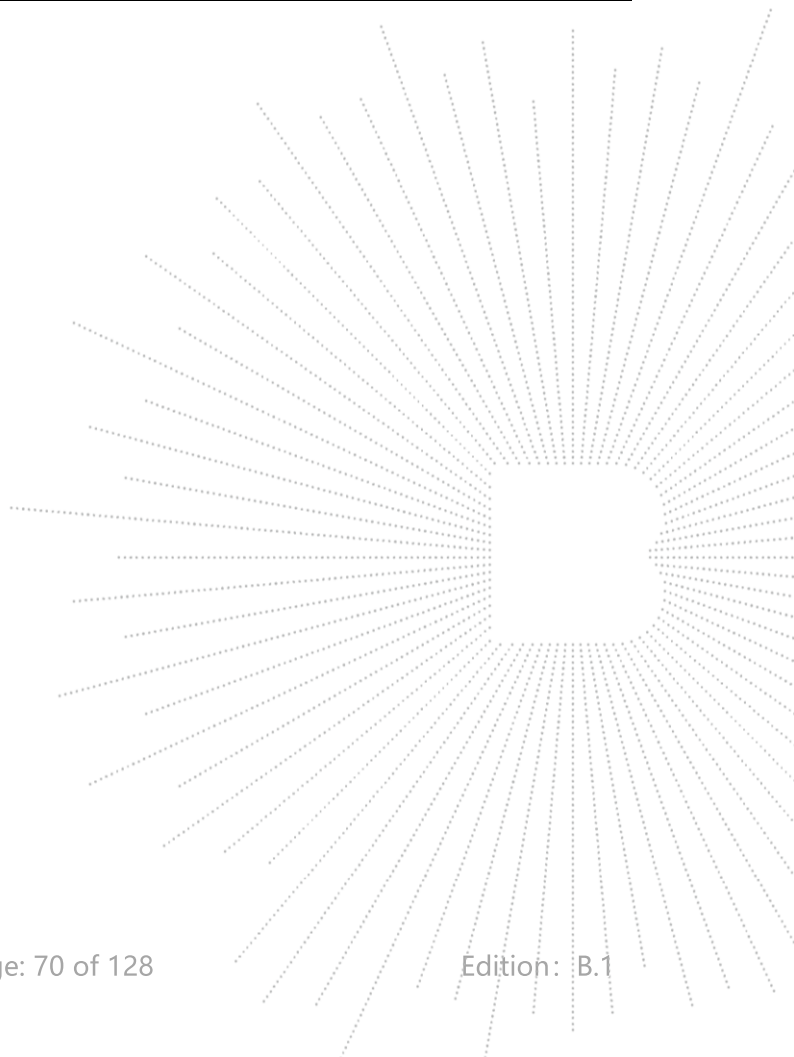

Note: A(B) Represent the value of antenna A and B, The worst data is Antenna A, only shown Antenna A Plot.

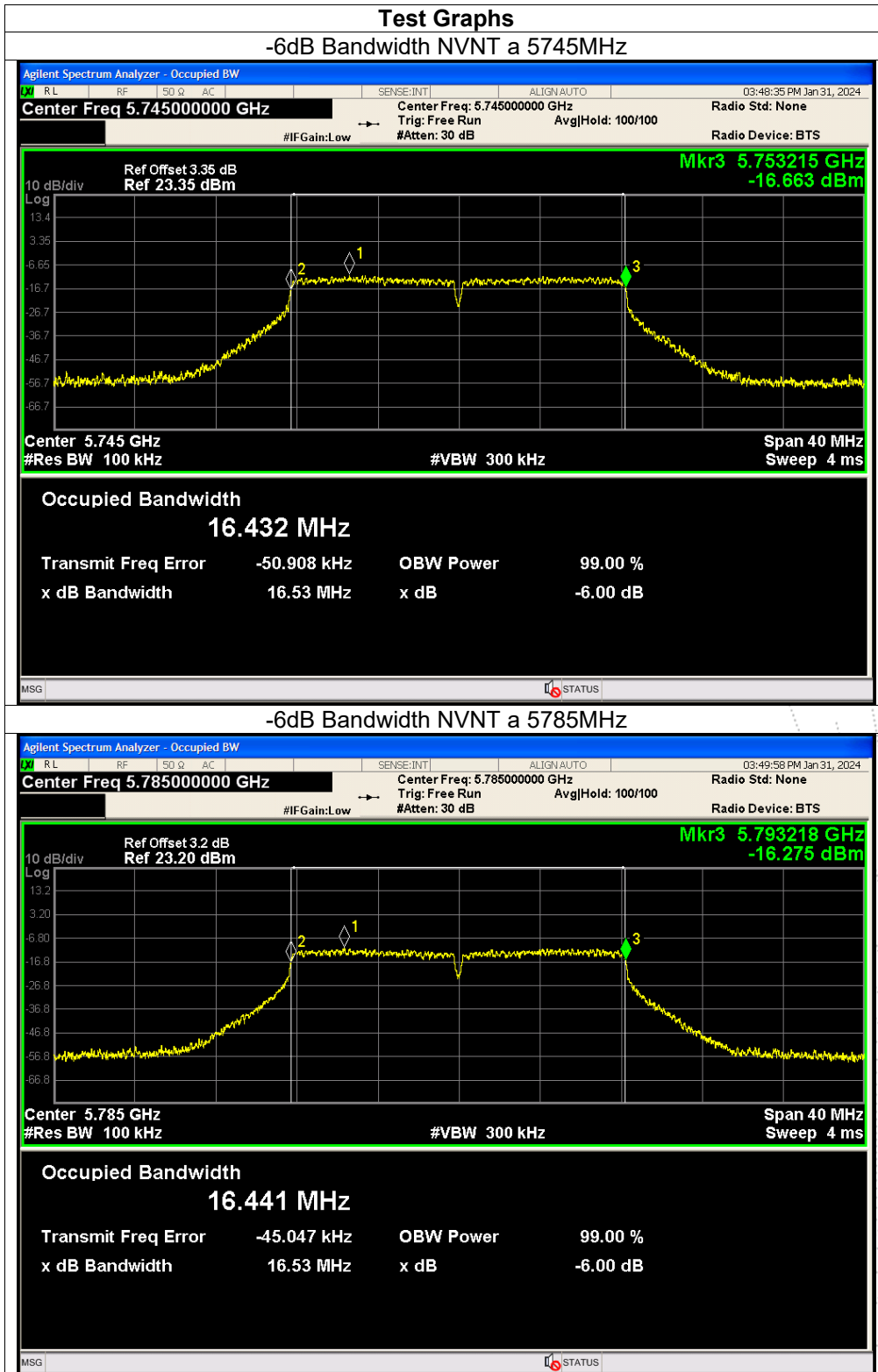

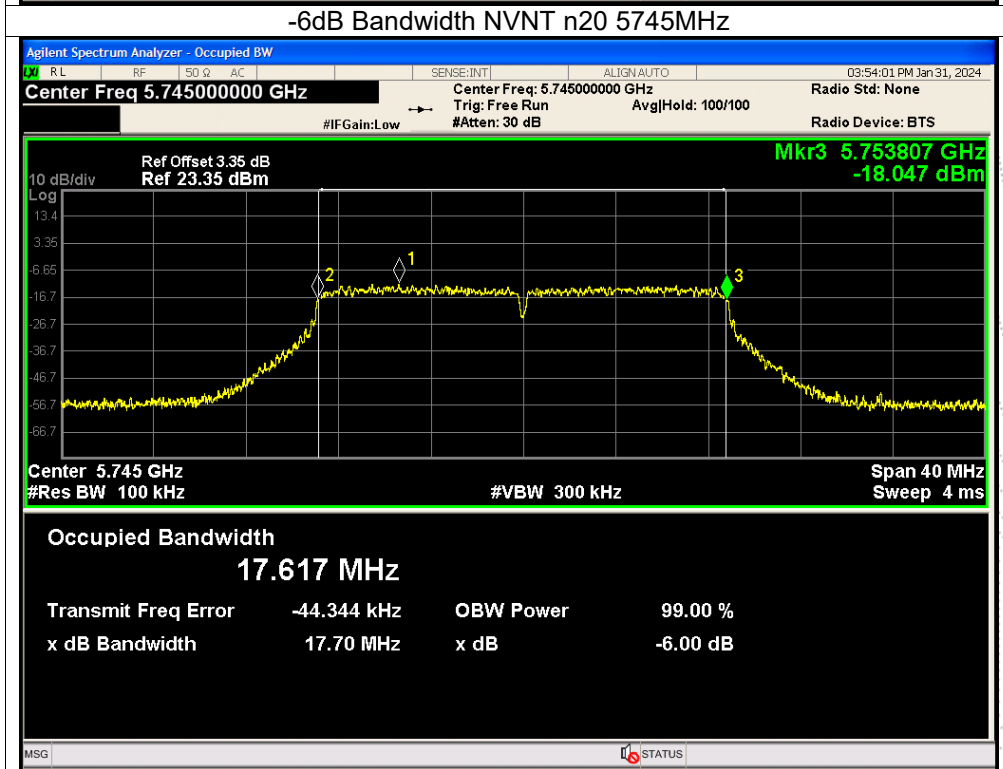
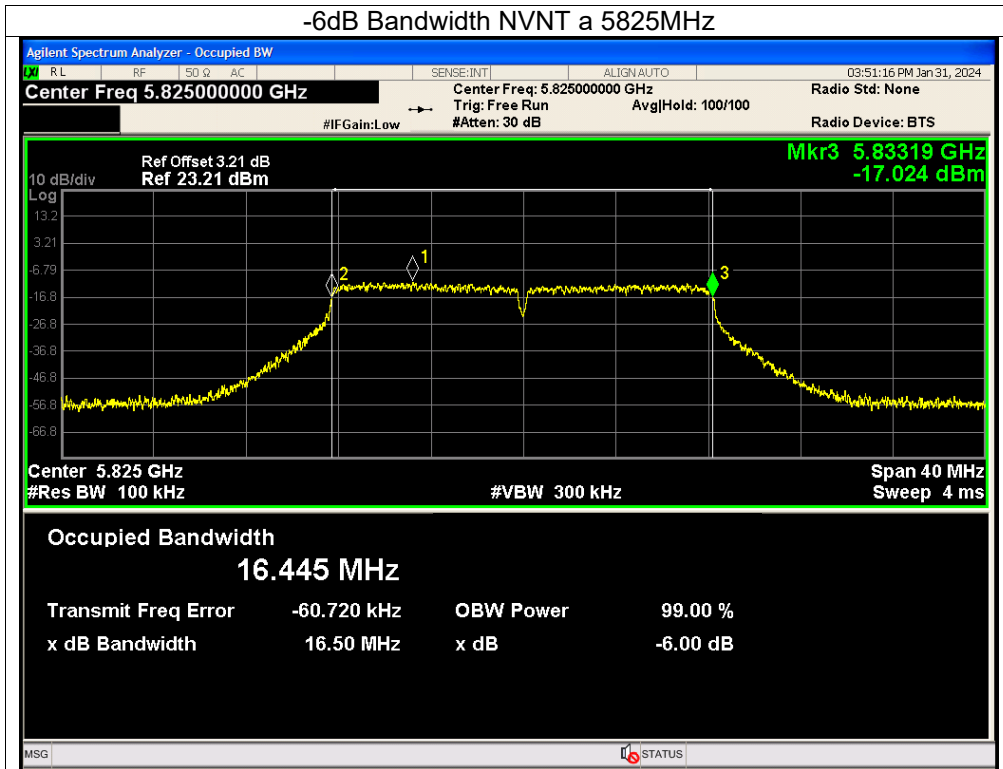



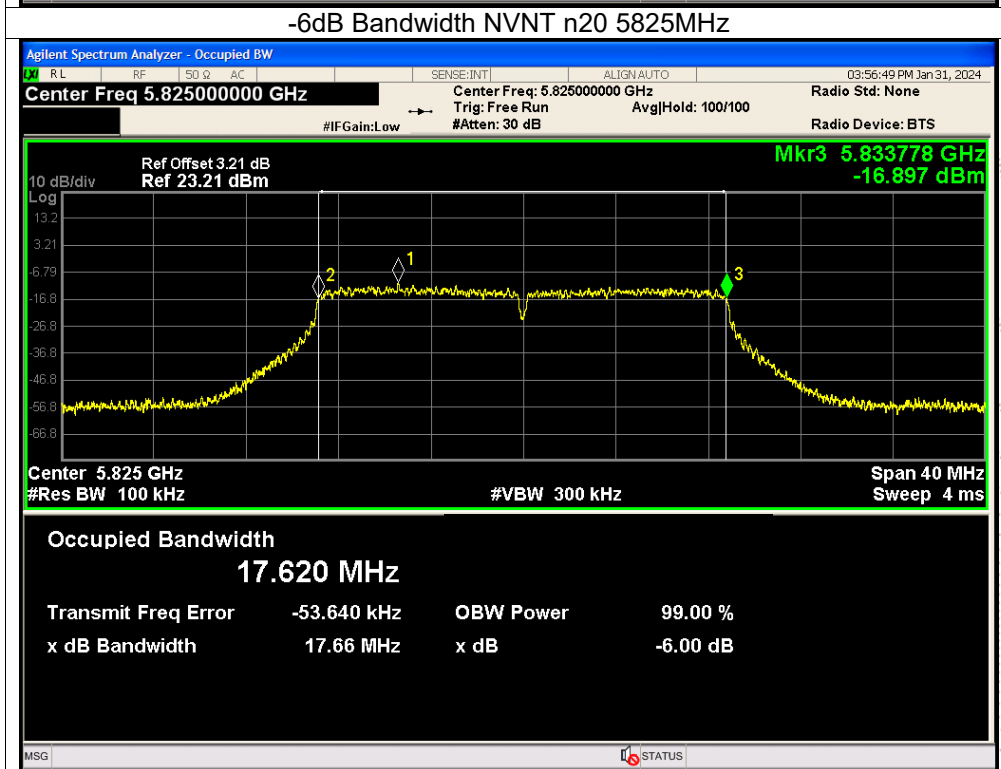
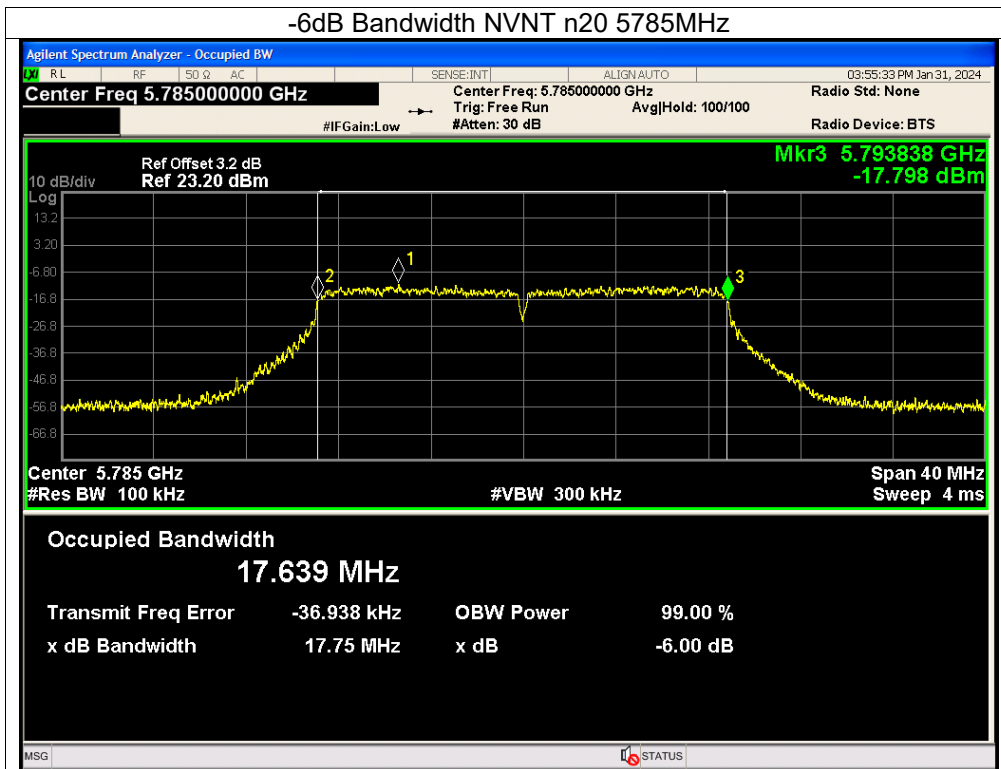

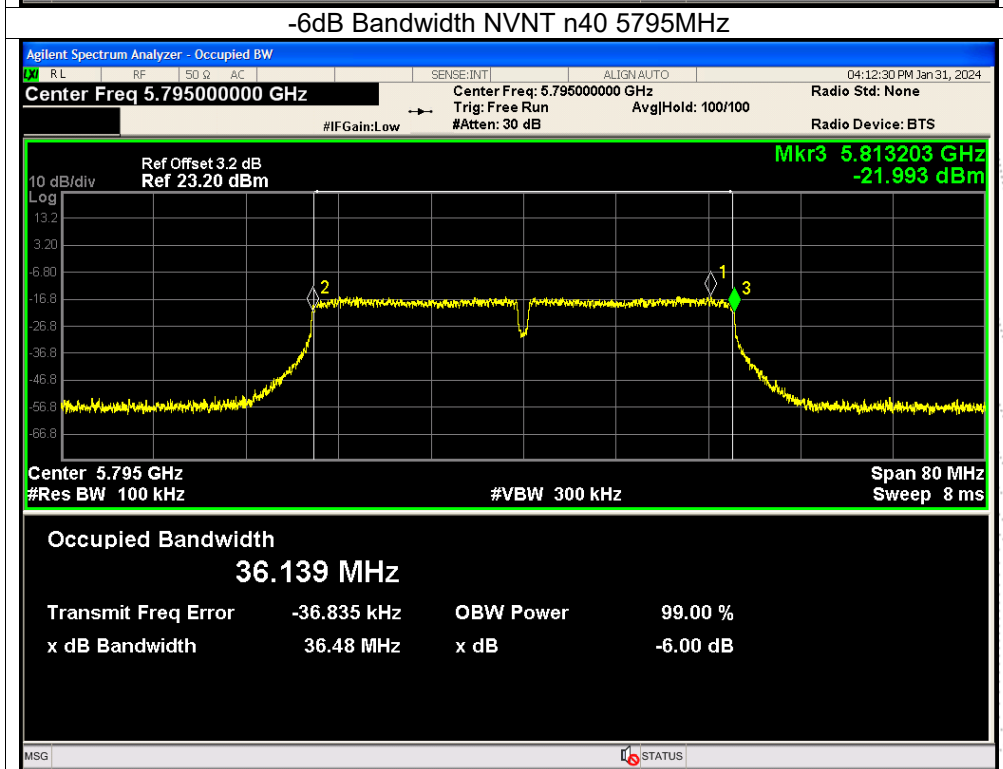
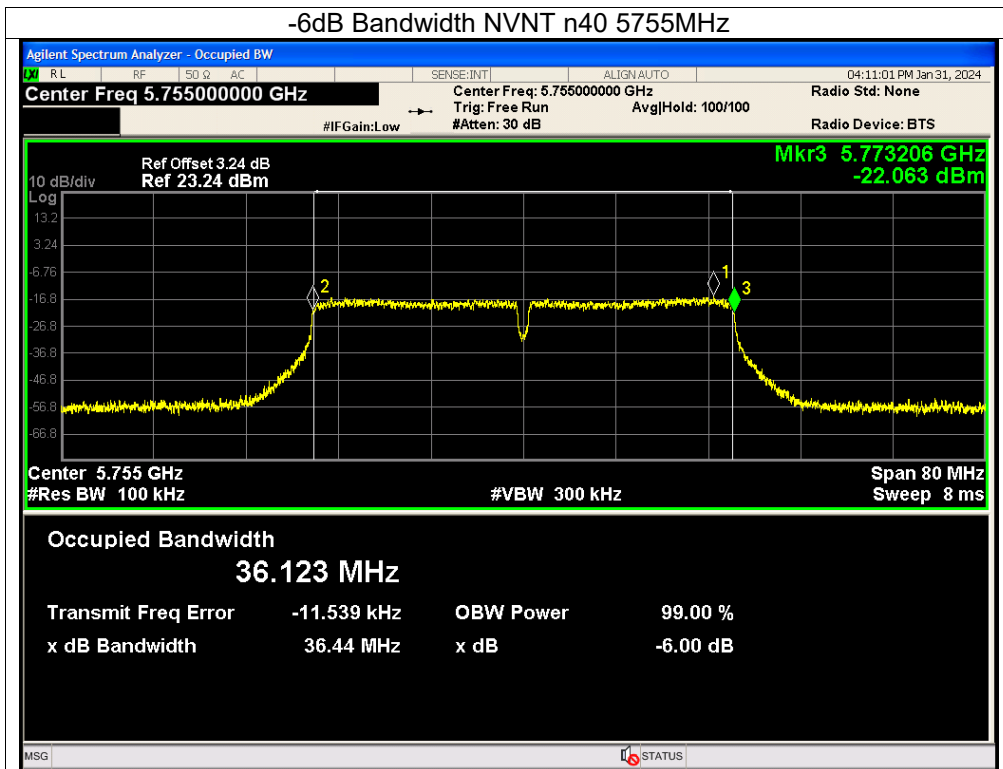

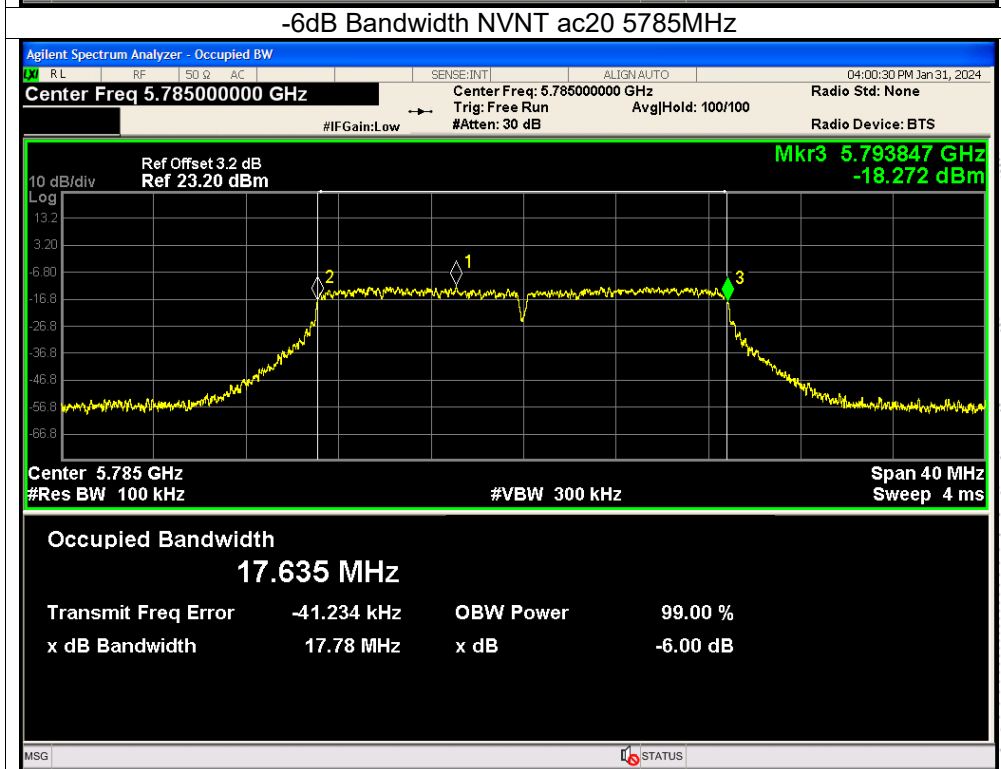
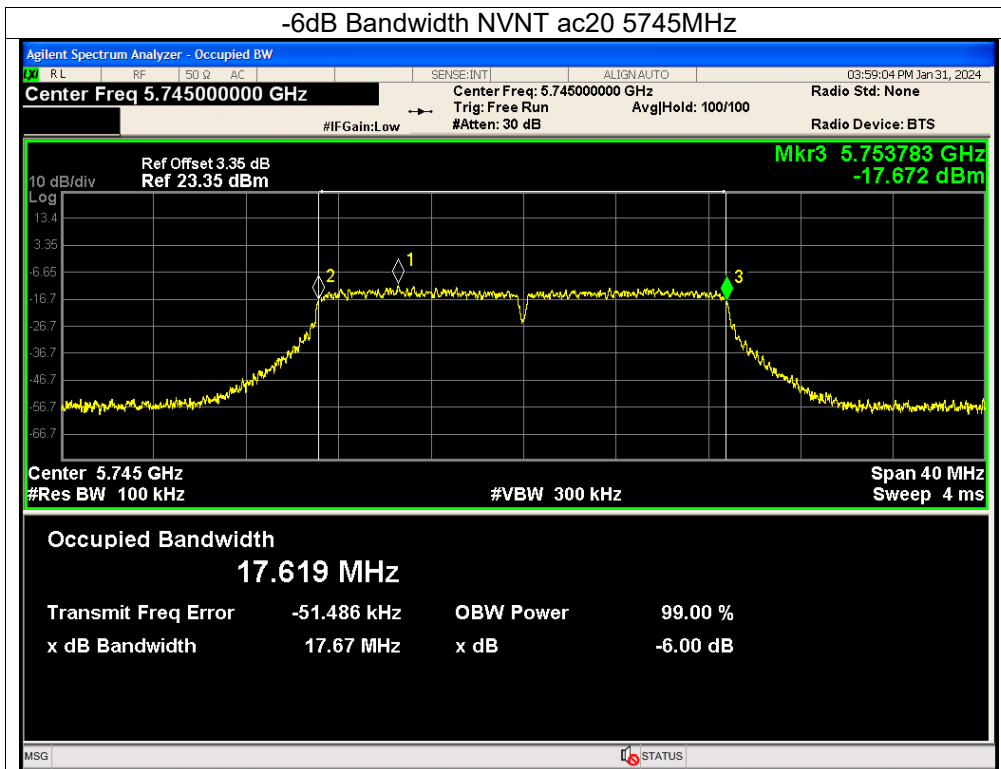

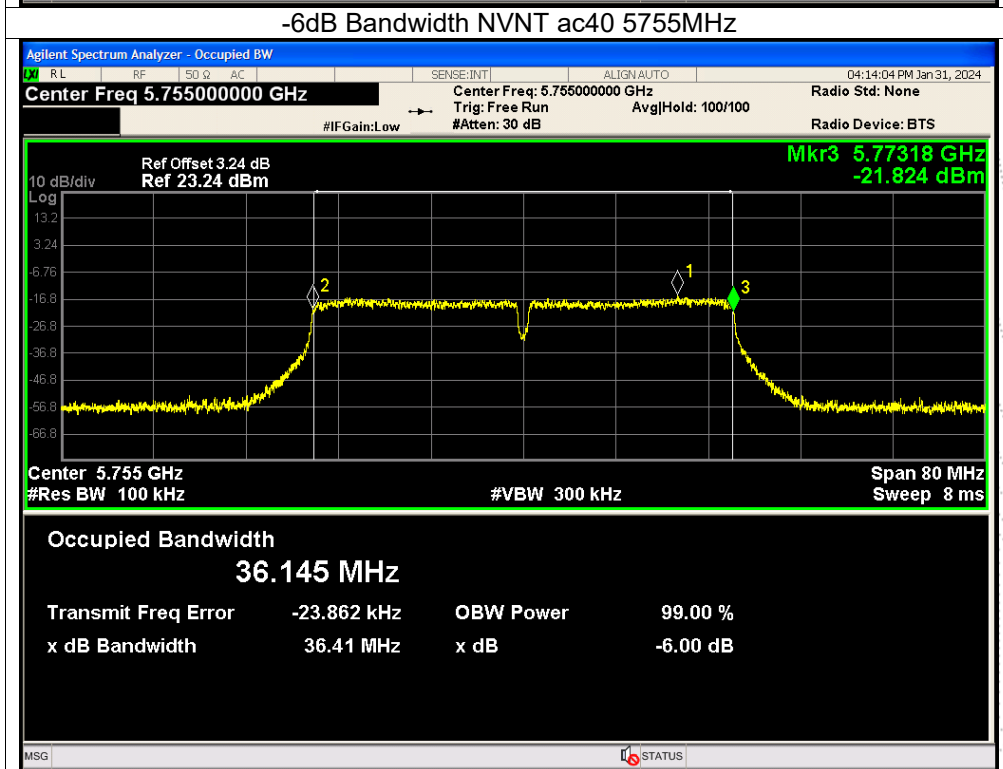
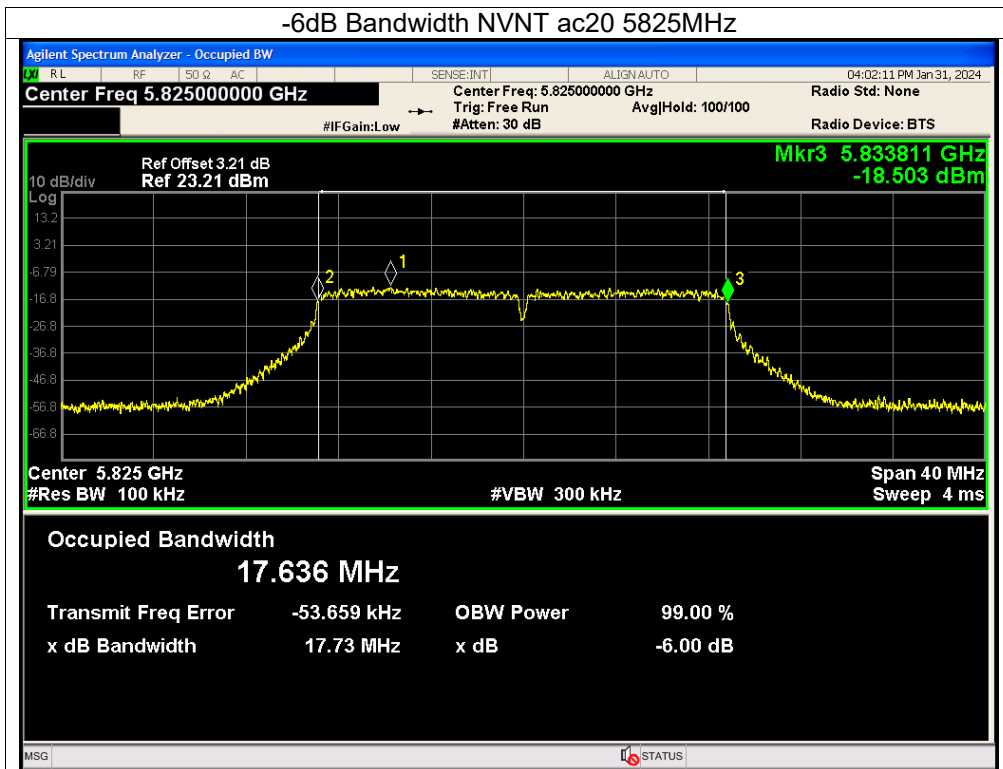

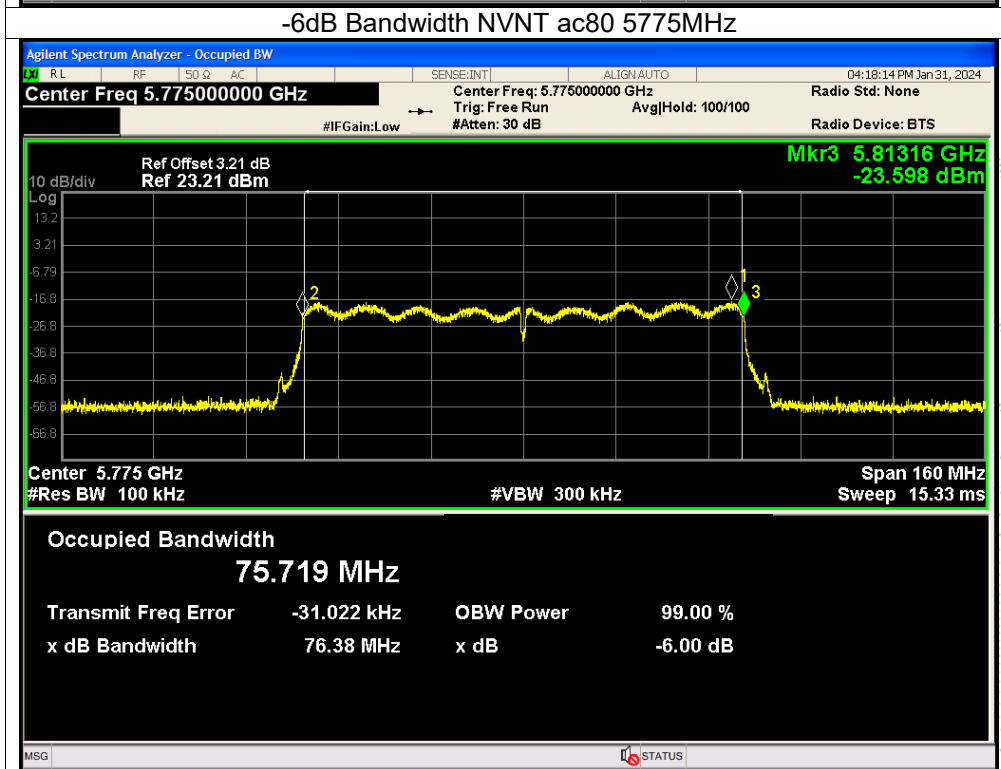
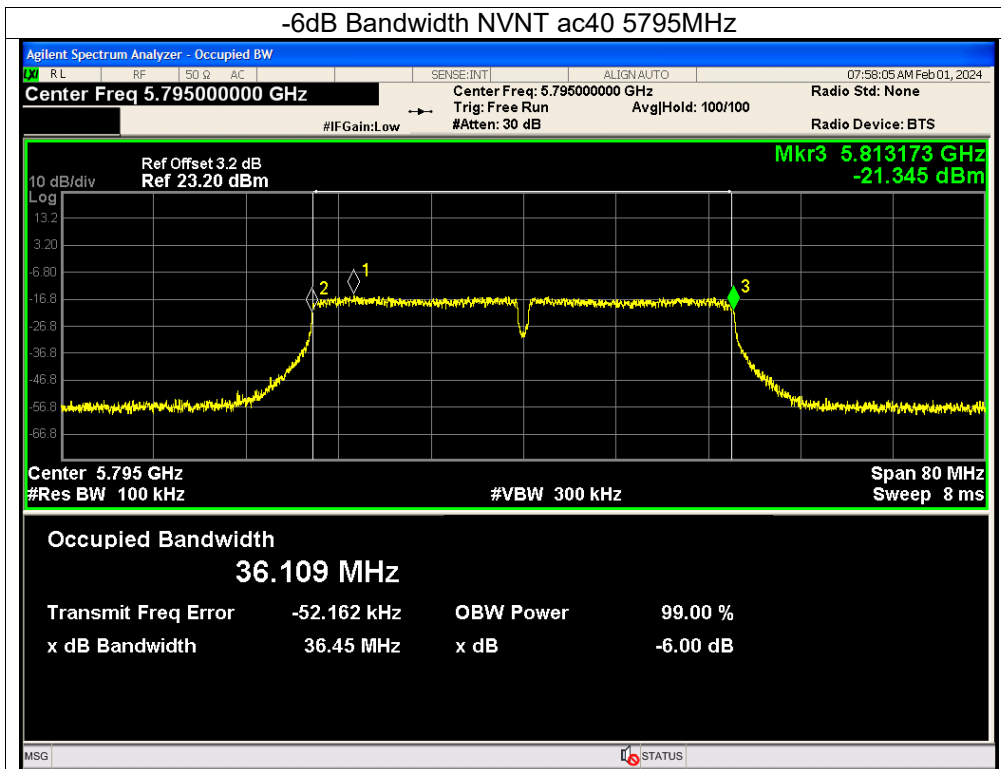

Note: A(B) Represent the value of antenna A and B, The worst data is Antenna B, only shown Antenna B Plot.

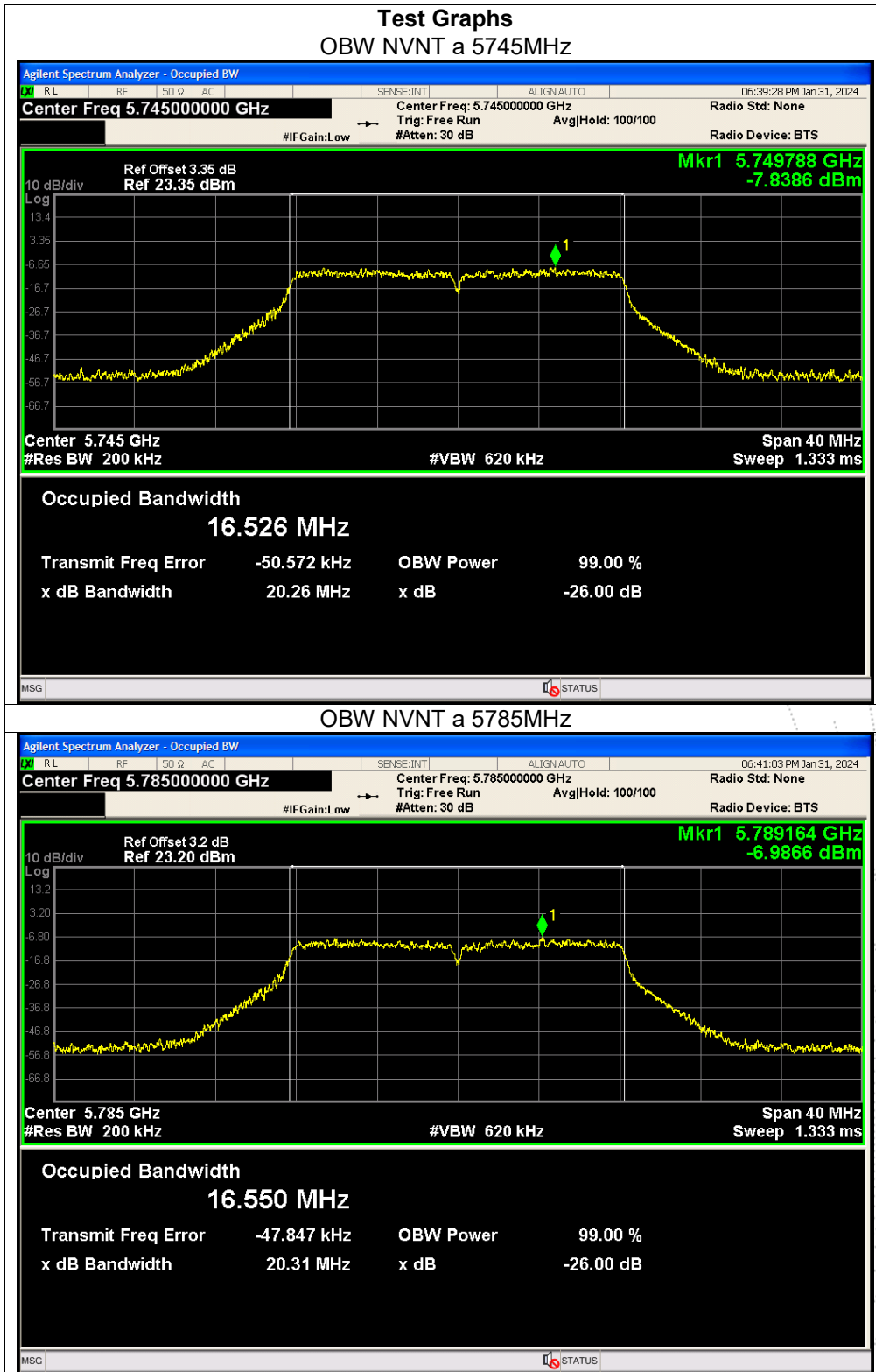

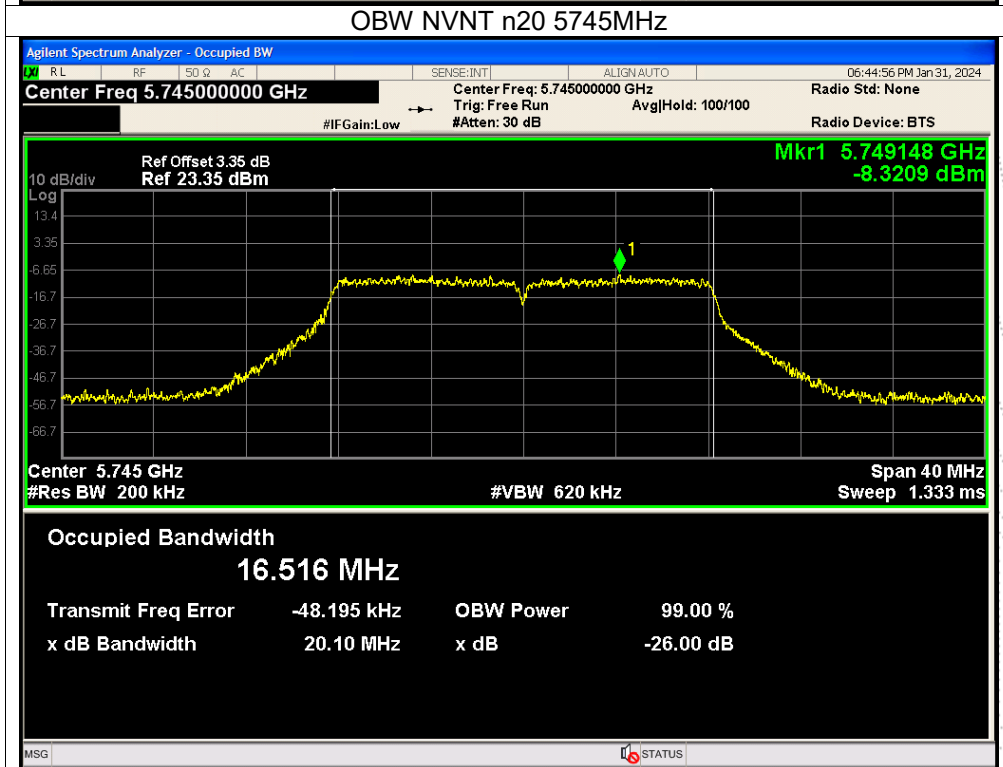
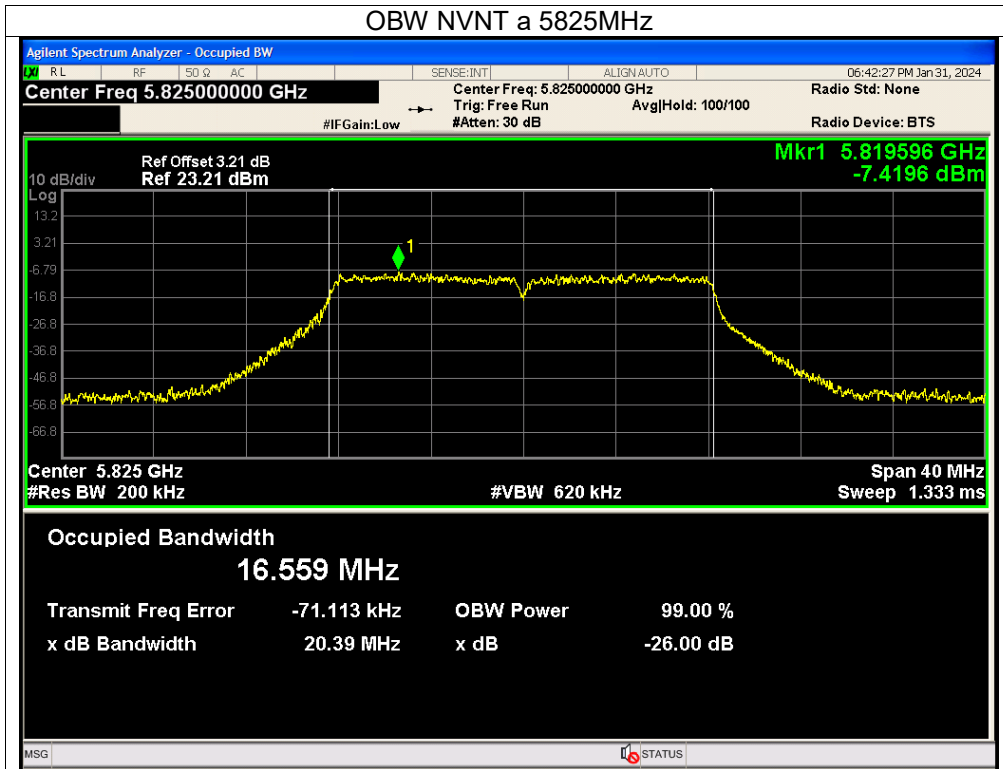

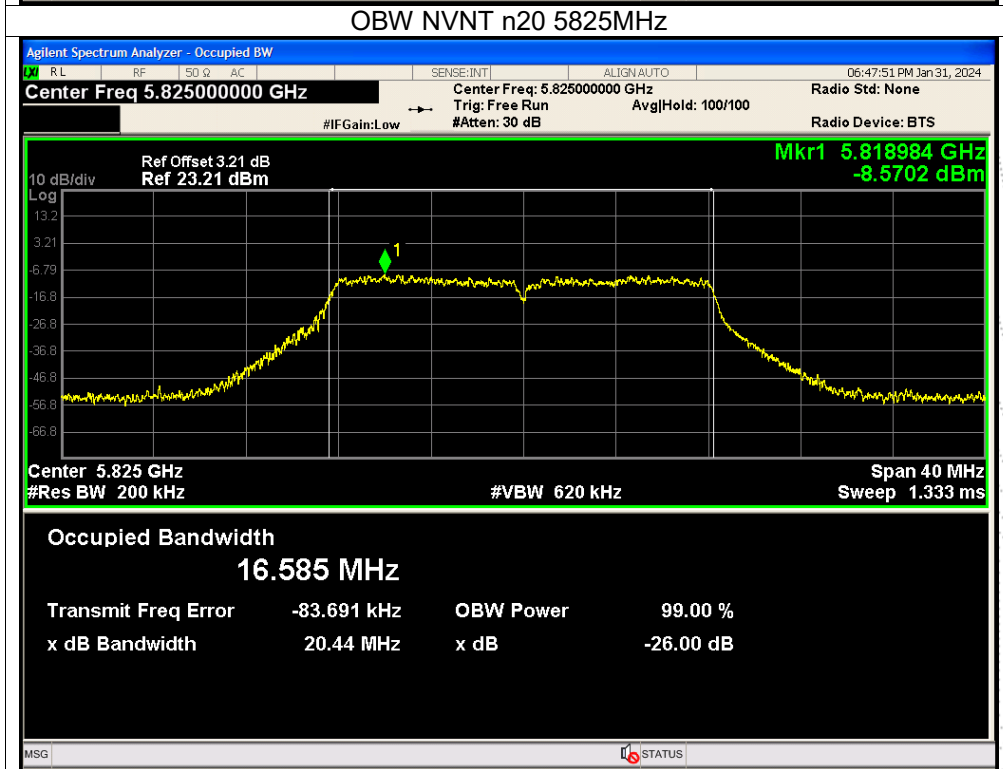
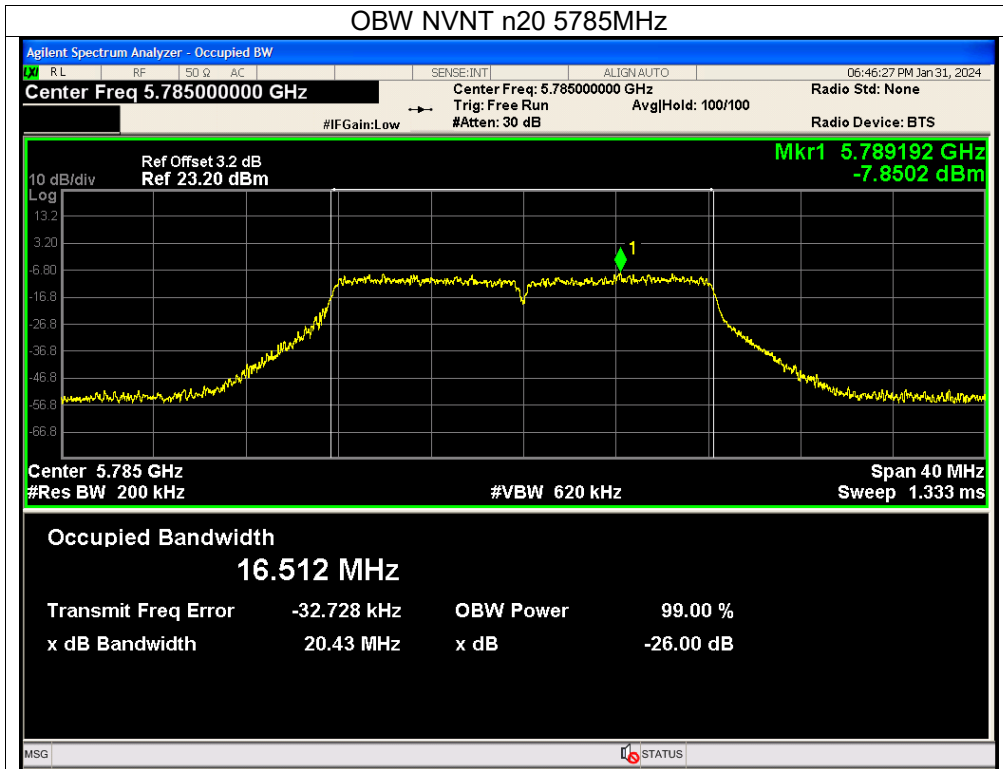



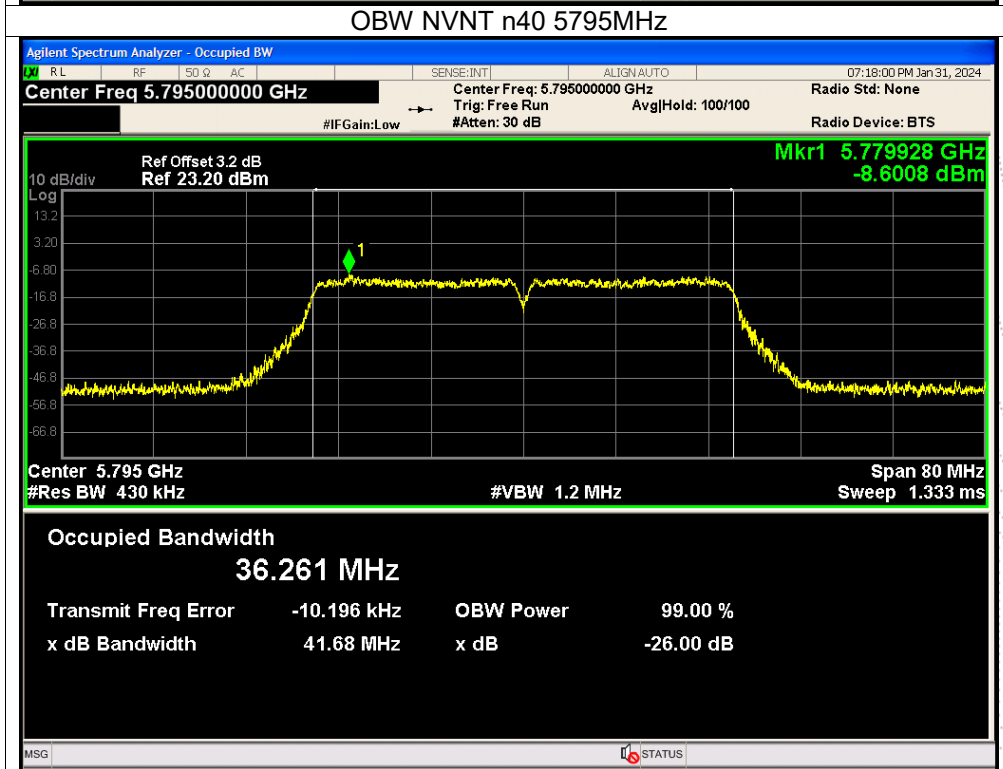
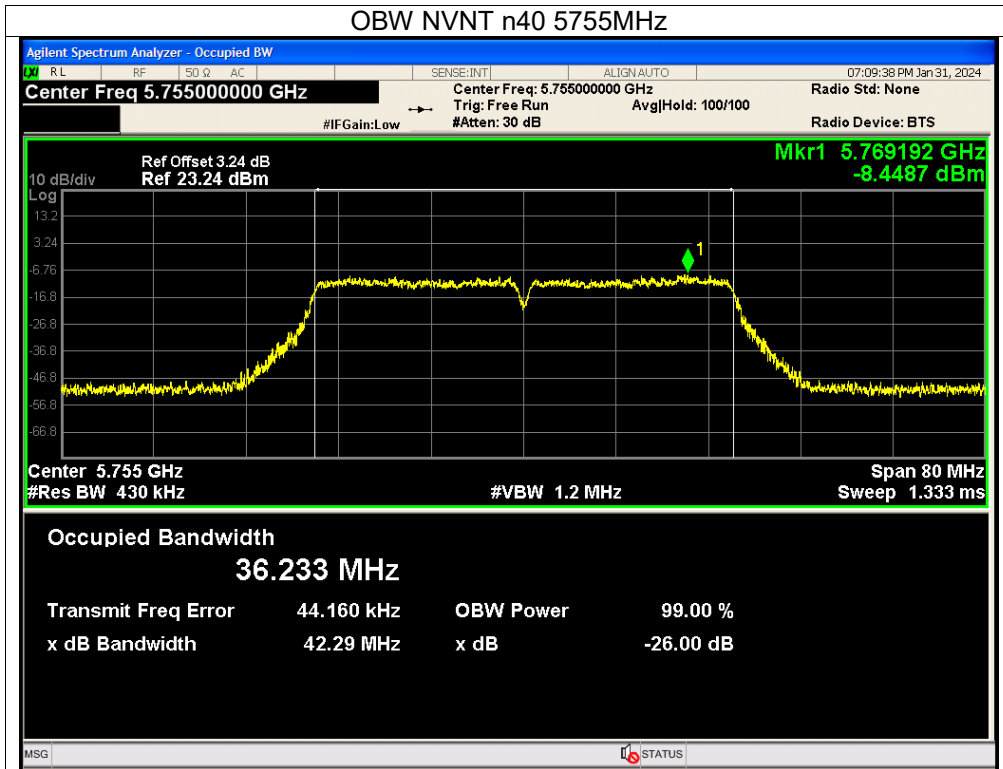

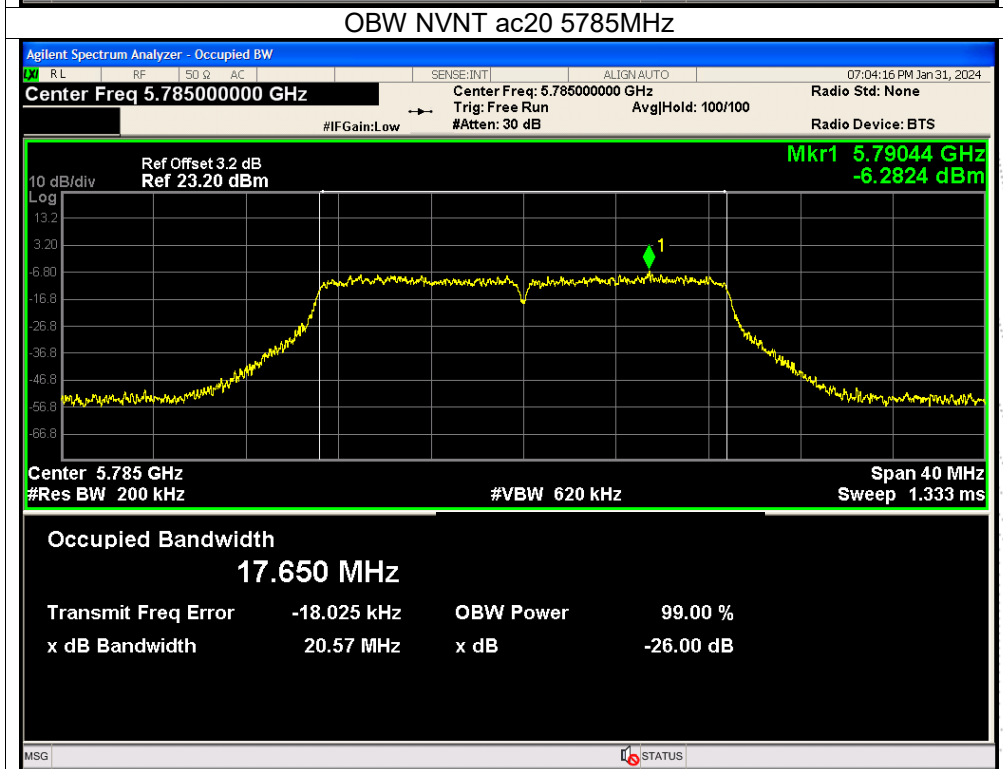
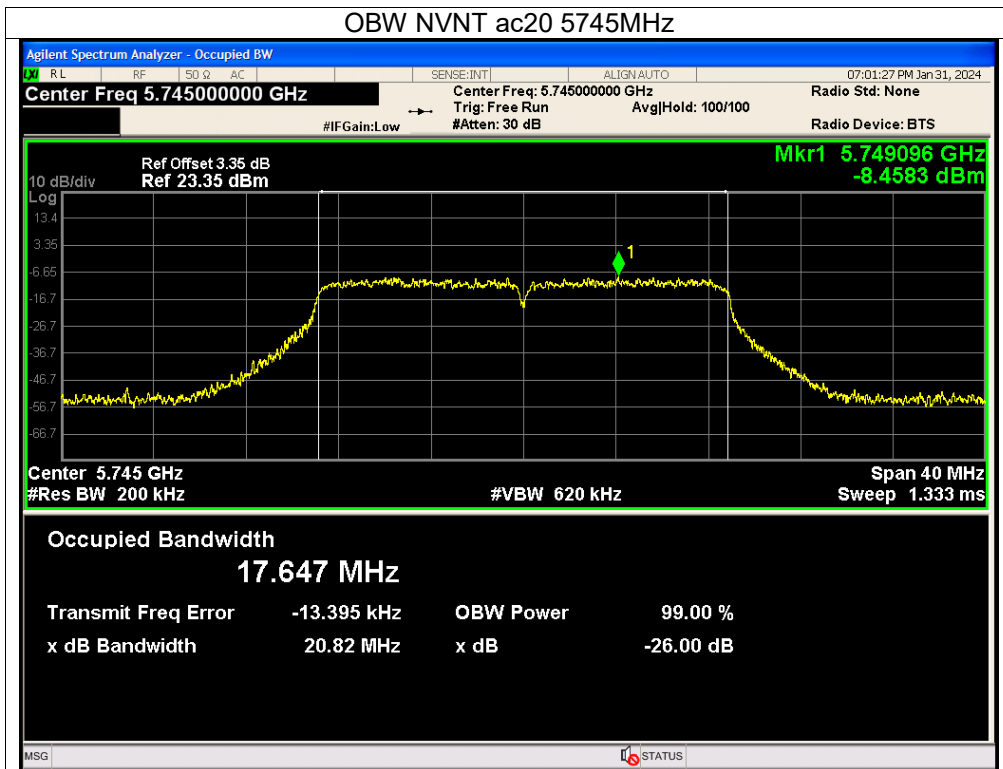

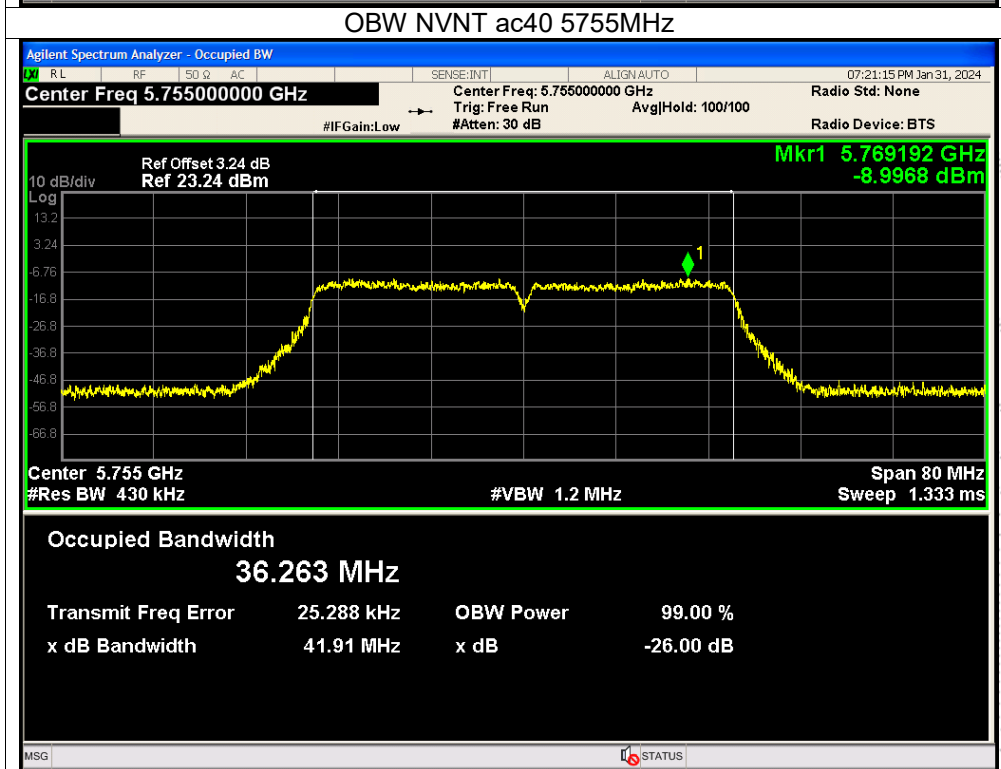
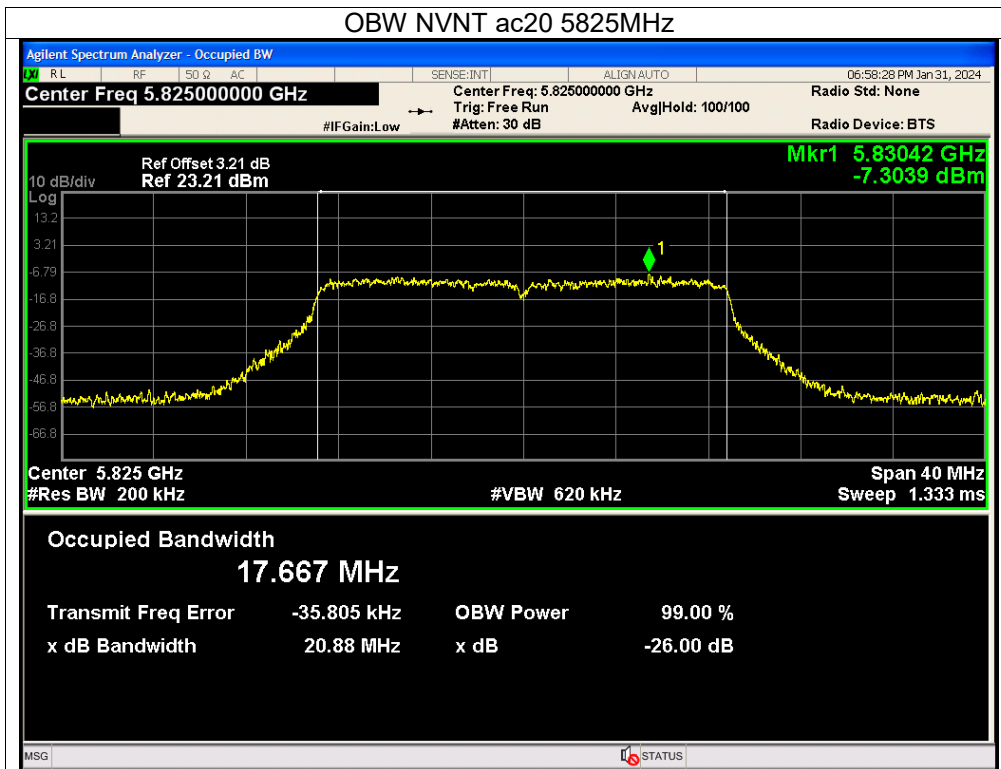

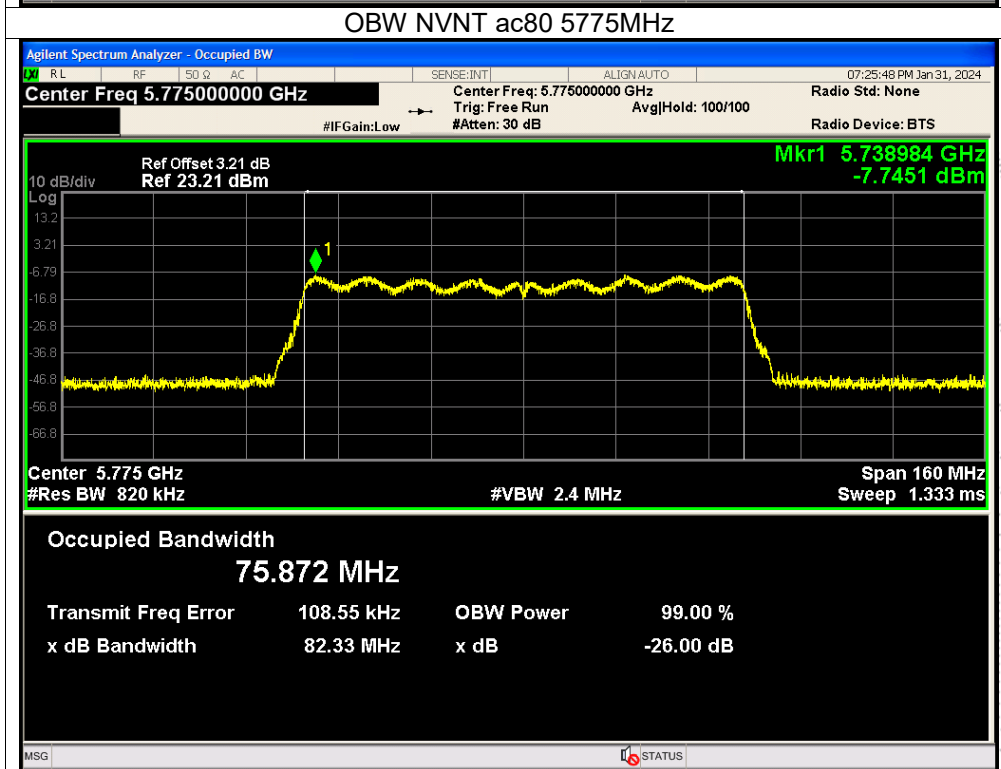
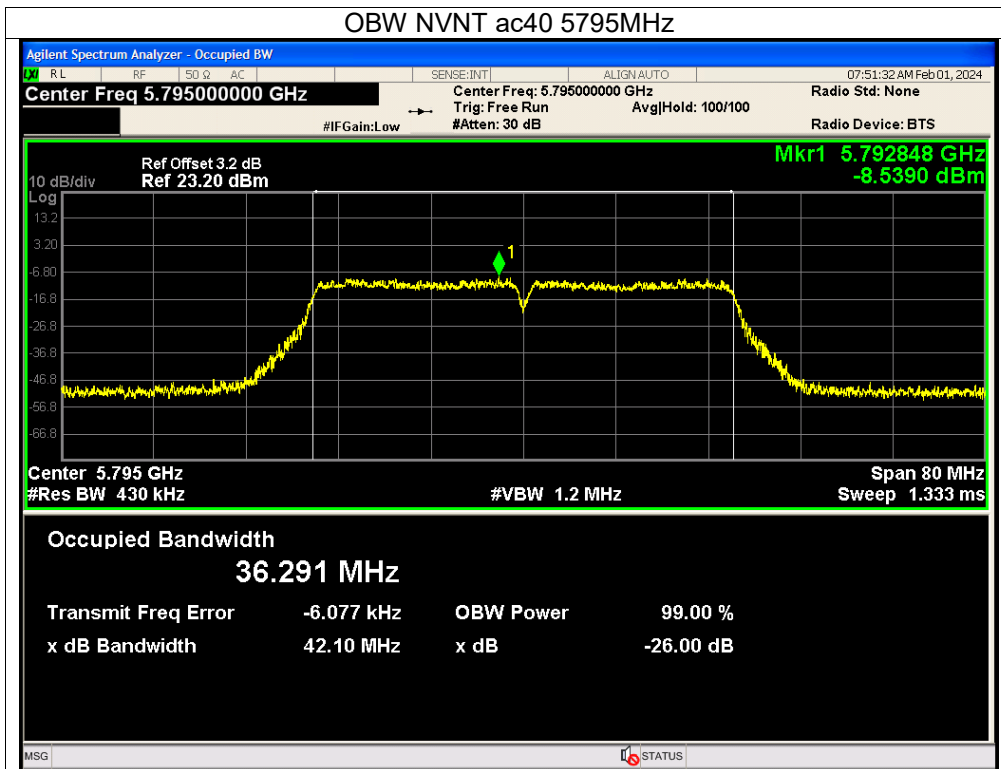

## 10. Maximum Conducted Output Power

### 10.1 Block Diagram Of Test Setup



### 10.2 Limit

#### According to FCC §15.407

The maximum conducted output power should not exceed:

Frequency Band(MHz)	Limit
5150~5250	250mW
5725~5850	1W

### 10.3 Test Procedure

Maximum conducted output power may be measured using a spectrum analyzer/EMI receiver or an RF power meter.

#### 1. Device Configuration

If possible, configure or modify the operation of the EUT so that it transmits continuously at its maximum power control level (see section II.B.).

a) The intent is to test at 100 percent duty cycle; however a small reduction in duty cycle (to no lower than 98 percent) is permitted if required by the EUT for amplitude control purposes. Manufacturers are expected to provide software to the test lab to permit such continuous operation.

b) If continuous transmission (or at least 98 percent duty cycle) cannot be achieved due to hardware limitations (e.g., overheating), the EUT shall be operated at its maximum power control level with the transmit duration as long as possible and the duty cycle as high as possible.

#### 2. Measurement using a Spectrum Analyzer or EMI Receiver (SA)

Measurement of maximum conducted output power using a spectrum analyzer requires integrating the spectrum across a frequency span that encompasses, at a minimum, either the EBW or the 99-percent occupied bandwidth of the signal.<sup>1</sup> However, the EBW must be used to determine bandwidth dependent limits on maximum conducted output power in accordance with § 15.407(a).

a) The test method shall be selected as follows: (i) Method SA-1 or SA-1 Alternative (averaging with the EUT transmitting at full power throughout each sweep) shall be applied if either of the following conditions can be satisfied:

- The EUT transmits continuously (or with a duty cycle  $\geq 98$  percent).
- Sweep triggering or gating can be implemented in a way that the device transmits at the maximum power control level throughout the duration of each of the instrument sweeps to be averaged. This condition can generally be achieved by triggering the instrument's sweep if the duration of the sweep (with the analyzer configured as in Method SA-1, below) is equal to or shorter than the duration T of each transmission from the EUT and if those transmissions exhibit full power throughout their durations.

(ii) Method SA-2 or SA-2 Alternative (averaging across on and off times of the EUT transmissions, followed by duty cycle correction) shall be applied if the conditions of (i) cannot be achieved and the transmissions exhibit a constant duty cycle during the measurement duration. Duty cycle will be considered to be constant if variations are less than  $\pm 2$  percent.

(iii) Method SA-3 (RMS detection with max hold) or SA-3 Alternative (reduced VBW with max hold) shall be applied if the conditions of (i) and (ii) cannot be achieved.

b) Method SA-1 (trace averaging with the EUT transmitting at full power throughout each sweep): (i) Set span to encompass the entire emission bandwidth (EBW) (or, alternatively, the entire 99% occupied bandwidth) of the signal.

(ii) Set RBW = 1 MHz.

(iii) Set VBW  $\geq$  3 MHz.

(iv) Number of points in sweep  $\geq$  2 Span / RBW. (This ensures that bin-to-bin spacing is  $\leq$  RBW/2, so that narrowband signals are not lost between frequency bins.)

(v) Sweep time = auto.

(vi) Detector = RMS (i.e., power averaging), if available. Otherwise, use sample detector mode.

(vii) If transmit duty cycle < 98 percent, use a video trigger with the trigger level set to enable triggering only on full power pulses. Transmitter must operate at maximum power control level for the entire duration of every sweep. If the EUT transmits continuously (i.e., with no off intervals) or at duty cycle  $\geq$  98 percent, and if each transmission is entirely at the maximum power control level, then the trigger shall be set to "free run".

(viii) Trace average at least 100 traces in power averaging (i.e., RMS) mode.

(ix) Compute power by integrating the spectrum across the EBW (or, alternatively, the entire 99% occupied bandwidth) of the signal using the instrument's band power measurement function with band limits set equal to the EBW (or occupied bandwidth) band edges. If the instrument does not have a band power function, sum the spectrum

#### 10.4 EUT Operating Conditions

The EUT was configured for testing in a typical fashion (as a customer would normally use it). The EUT has been programmed to continuously transmit during test. This operating condition was tested and used to collect the included data.

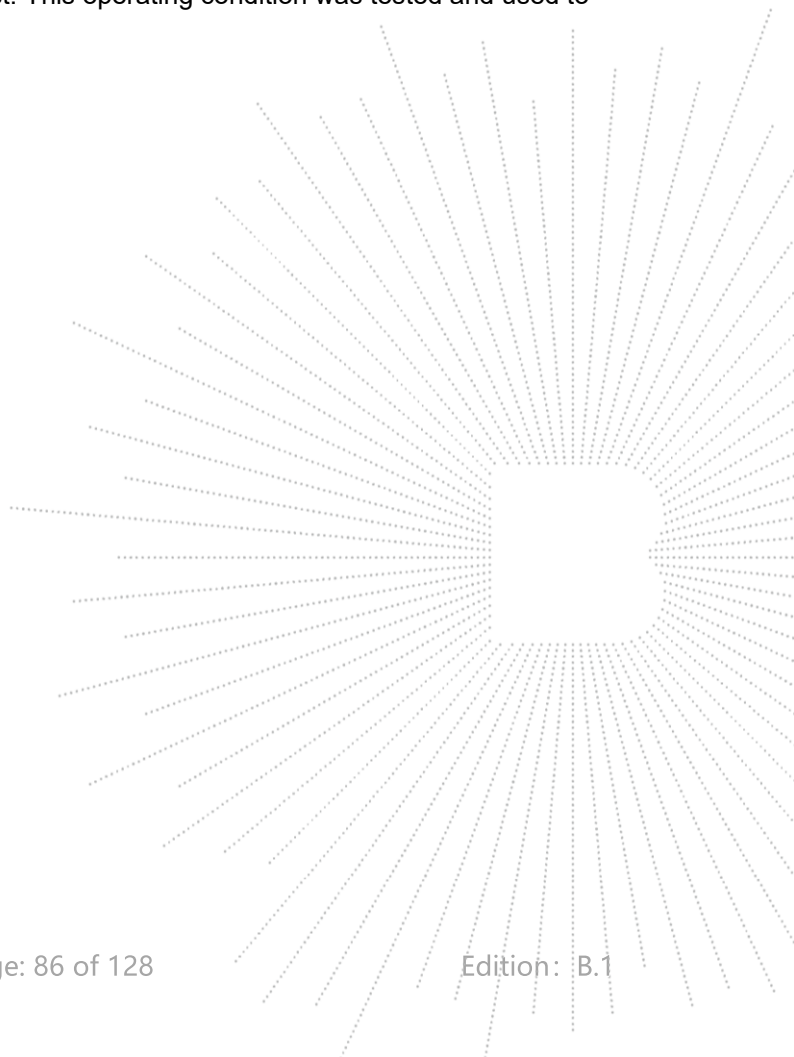

## 10.5 Test Result

Temperature:	26 °C	Relative Humidity:	54%
Pressure:	101kPa	Test Voltage:	DC 12V
Test Mode:	TX (5G) Mode Frequency U-NII-1 (5180-5240MHz)		

Condition	Mode	Frequency (MHz)	Conducted Power (dBm)		Total(dBm)	Limit dBm	Verdict
			Ant A	Ant B			
NVNT	a	5180	2.94	2.98	/	24	Pass
NVNT	a	5200	3.23	2.95	/	24	Pass
NVNT	a	5240	3.91	3.84	/	24	Pass
NVNT	n20	5180	2.82	2.83	5.84	24	Pass
NVNT	n20	5200	1.21	2.74	5.05	24	Pass
NVNT	n20	5240	3.69	3.77	6.74	24	Pass
NVNT	n40	5190	2.37	2.2	5.30	24	Pass
NVNT	n40	5230	2.59	2.94	5.78	24	Pass
NVNT	ac20	5180	2.1	2.11	5.12	24	Pass
NVNT	ac20	5200	1.92	2.52	5.24	24	Pass
NVNT	ac20	5240	3.01	3.39	6.21	24	Pass
NVNT	ac40	5190	2.26	2.52	5.40	24	Pass
NVNT	ac40	5230	2.46	2.94	5.72	24	Pass
NVNT	ac80	5210	1.89	2.35	5.14	24	Pass

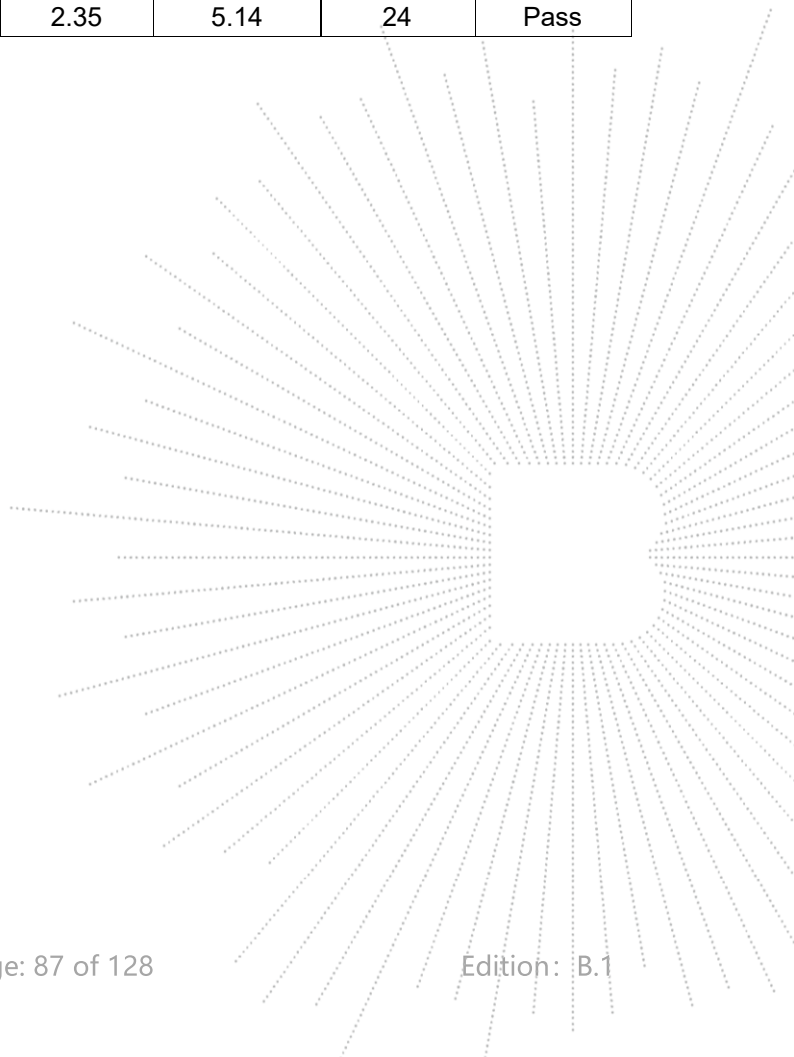

Temperature:	26 °C	Relative Humidity:	54%
Pressure:	101kPa	Test Voltage:	DC 12V
Test Mode:	TX (5G) Mode Frequency U-NII-3 (5745-5825MHz)		

Condition	Mode	Frequency (MHz)	Conducted Power (dBm)		Total(dBm)	Limit (dBm)	Verdict
			Ant A	Ant B			
NVNT	a	5745	2.93	3.01	/	30	Pass
NVNT	a	5785	3.46	3.34	/	30	Pass
NVNT	a	5825	3.48	3	/	30	Pass
NVNT	n20	5745	2.5	2.38	5.45	30	Pass
NVNT	n20	5785	2.67	2.79	5.74	30	Pass
NVNT	n20	5825	2.53	2.5	5.53	30	Pass
NVNT	n40	5755	2.18	1.68	4.95	30	Pass
NVNT	n40	5795	2.27	2.1	5.20	30	Pass
NVNT	ac20	5745	2.22	1.97	5.11	30	Pass
NVNT	ac20	5785	3.01	2.53	5.79	30	Pass
NVNT	ac20	5825	2.22	2.26	5.25	30	Pass
NVNT	ac40	5755	2.09	1.84	4.98	30	Pass
NVNT	ac40	5795	2	2.04	5.03	30	Pass
NVNT	ac80	5775	2.23	2.16	5.21	30	Pass

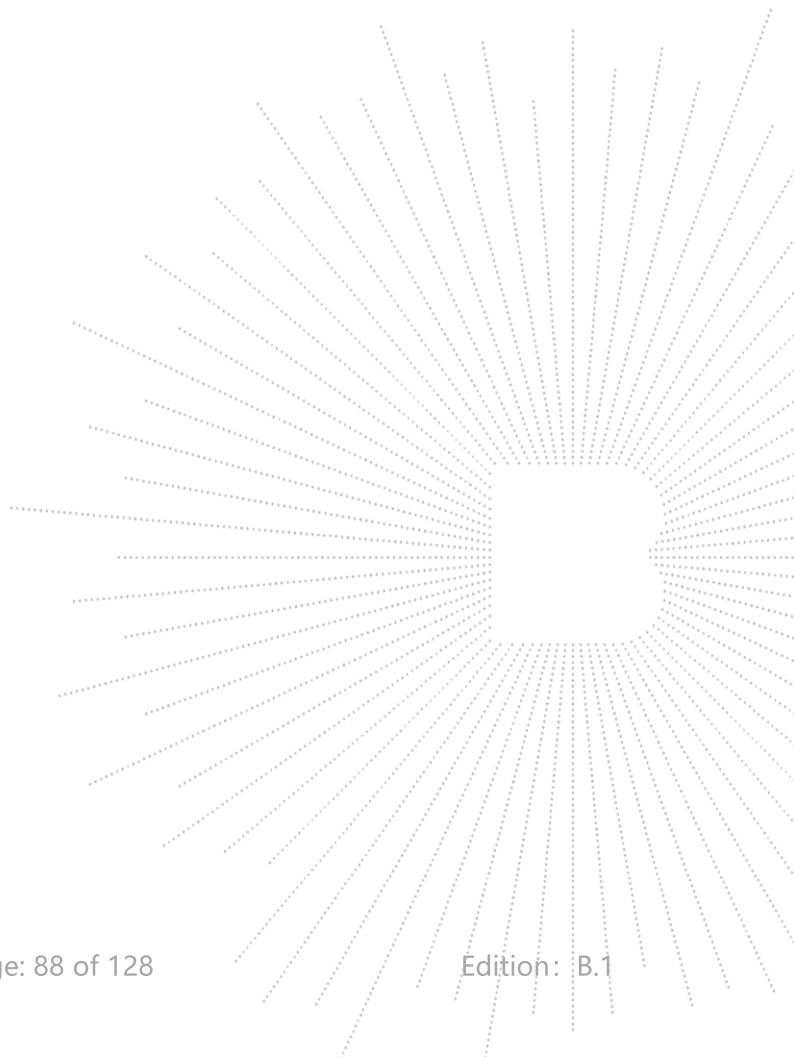



## 11. Out Of Band Emissions

### 11.1 Block Diagram Of Test Setup

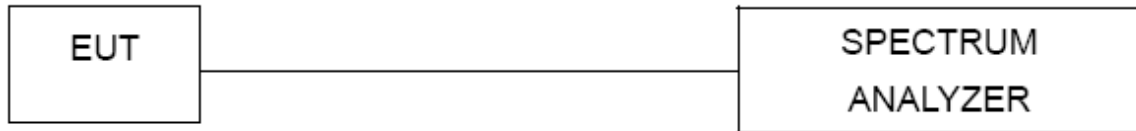

### 11.2 Limit

According to FCC §15.407(b)

Undesirable emission limits. Except as shown in paragraph (b)(7) of this section, the maximum emissions outside of the frequency bands of operation shall be attenuated in accordance with the following limits:

- (1) For transmitters operating in the 5.15-5.25 GHz band: All emissions outside of the 5.15-5.35 GHz band shall not exceed an e.i.r.p. of  $-27$  dBm/MHz.
- (2) All emissions shall be limited to a level of  $-27$  dBm/MHz at 75 MHz or more above or below the band edge increasing linearly to 10 dBm/MHz at 25 MHz above or below the band edge, and from 25 MHz above or below the band edge increasing linearly to a level of 15.6 dBm/MHz at 5 MHz above or below the band edge, and from 5 MHz above or below the band edge increasing linearly to a level of 27 dBm/MHz at the band edge.

### 11.3 Test Procedure

1. Check the calibration of the measuring instrument using either an internal calibrator or a known signal from an external generator.
2. Position the EUT without connection to measurement instrument. Turn on the EUT and connect its antenna terminal to measurement instrument via a low loss cable. Then set it to any one measured frequency within its operating range, and make sure the instrument is operated in its linear range.
3. Set RBW of spectrum analyzer to 1 MHz with a convenient frequency span.
4. Measure the highest amplitude appearing on spectral display and set it as a reference level. Plot the graph with marking the highest point and edge frequency.
5. Repeat above procedures until all measured frequencies were complete.

### 11.4 EUT Operating Conditions

The EUT was configured for testing in a typical fashion (as a customer would normally use it). The EUT has been programmed to continuously transmit during test. This operating condition was tested and used to collect the included data

### 11.5 Test Result

Temperature:	26 °C	Relative Humidity:	54%
Pressure:	101kPa	Test Voltage:	DC 12V

Note: A(B) Represent the value of antenna A and B, The worst data is Antenna A, only shown Antenna A Plot. Antenna B: 5180-5240MHz

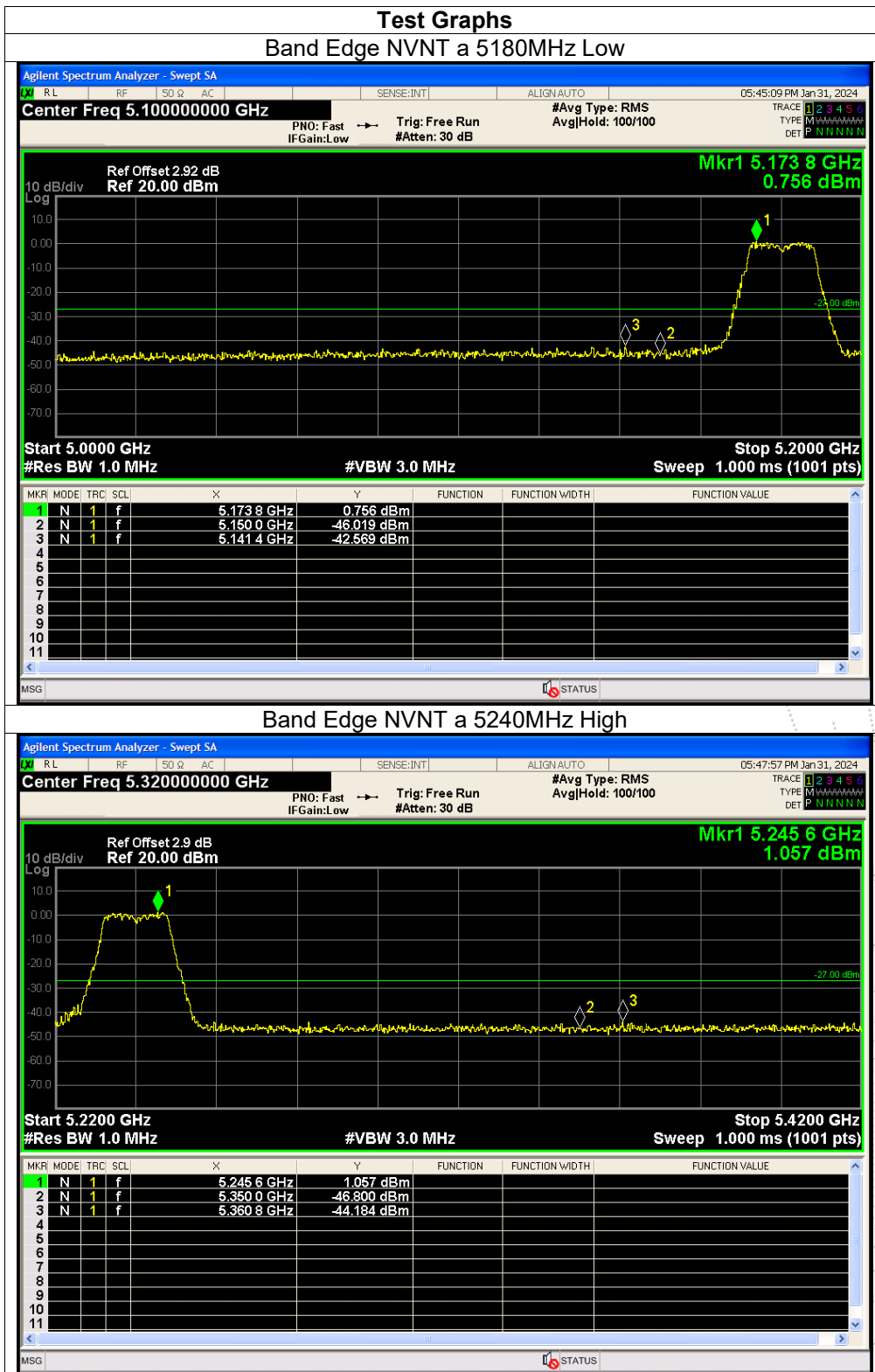

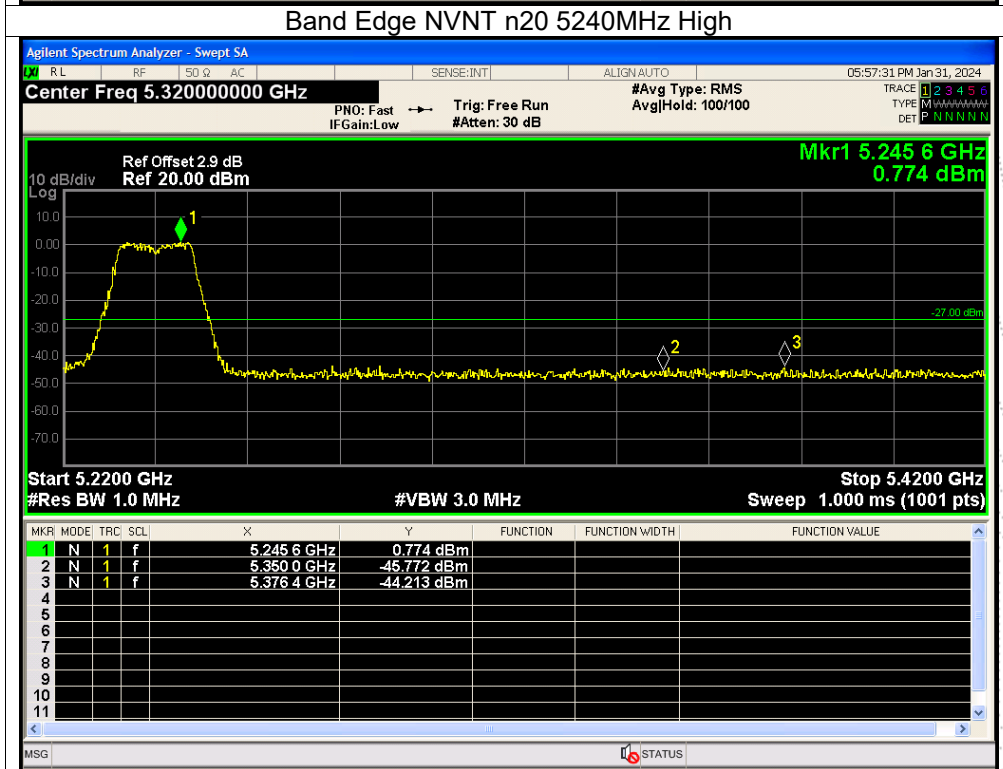
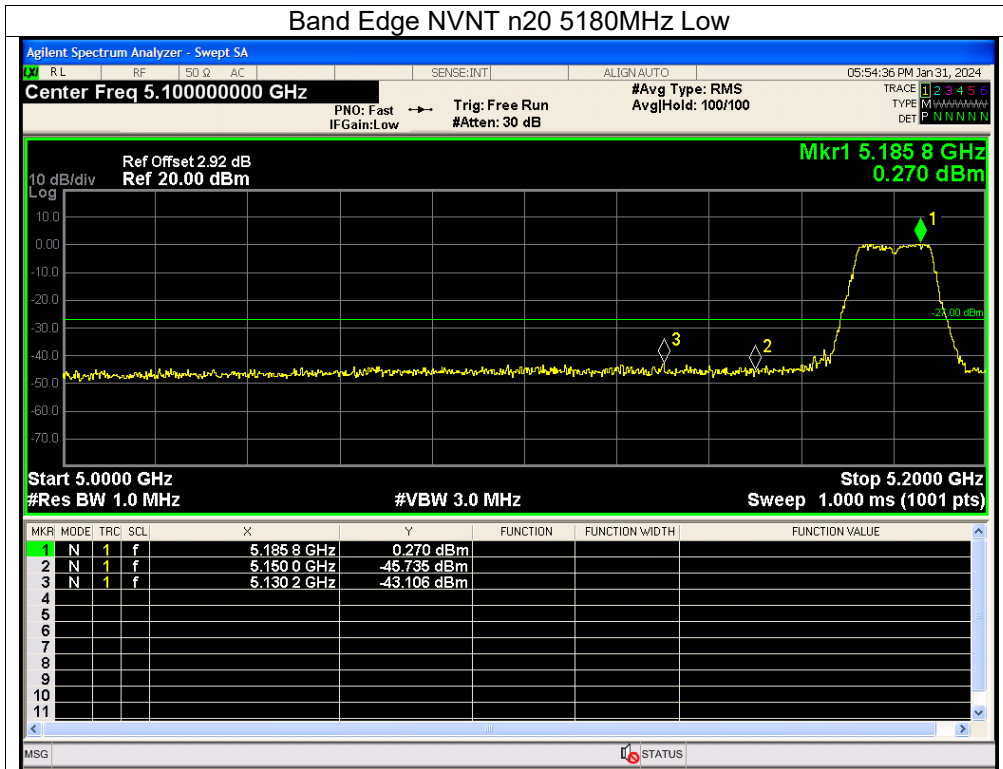

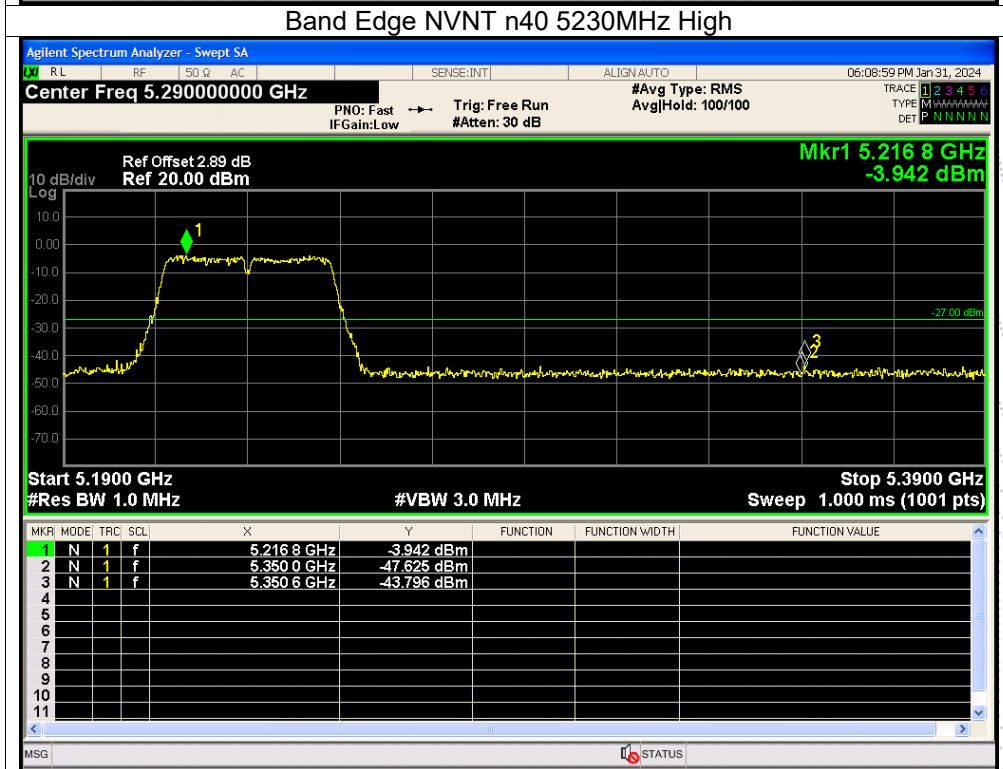
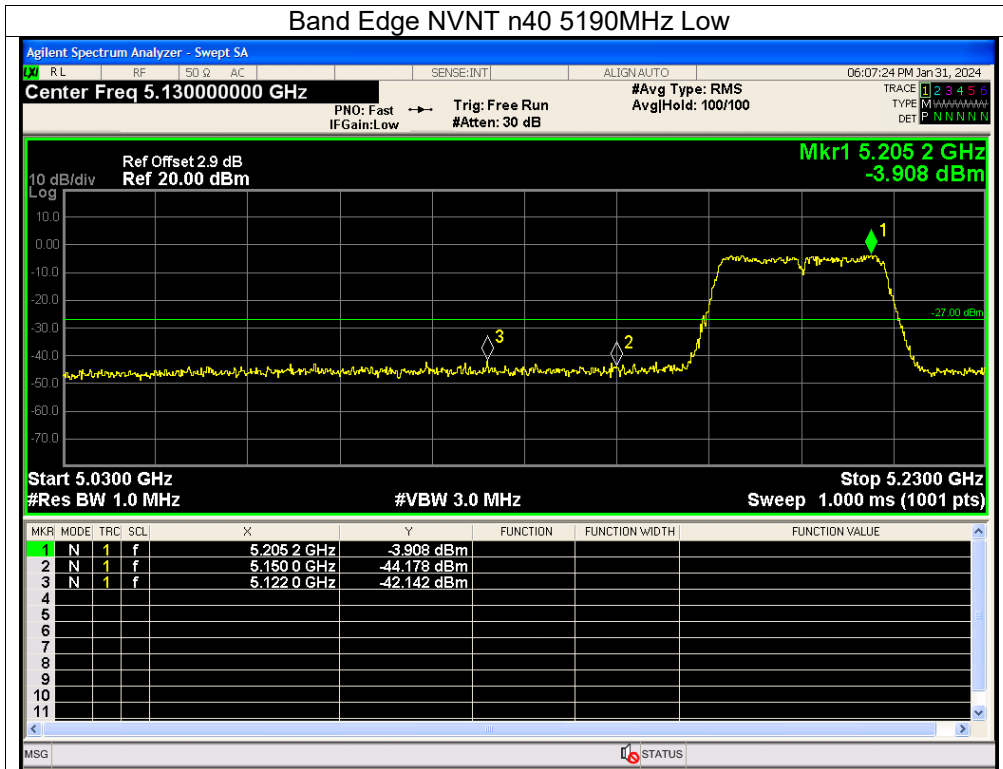

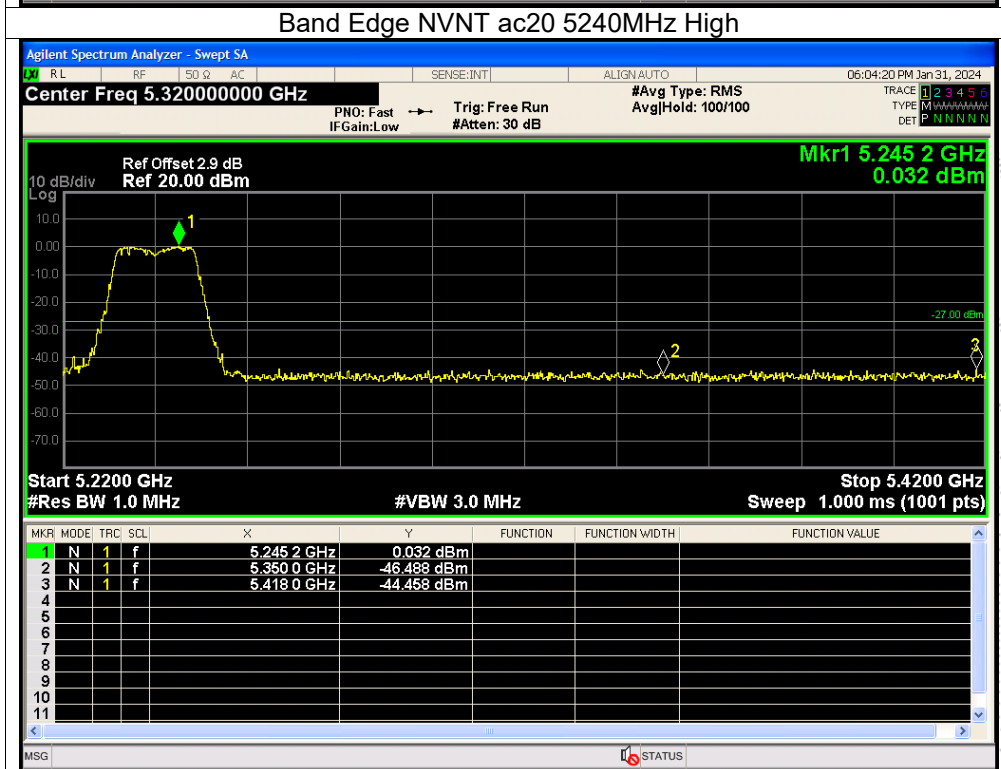
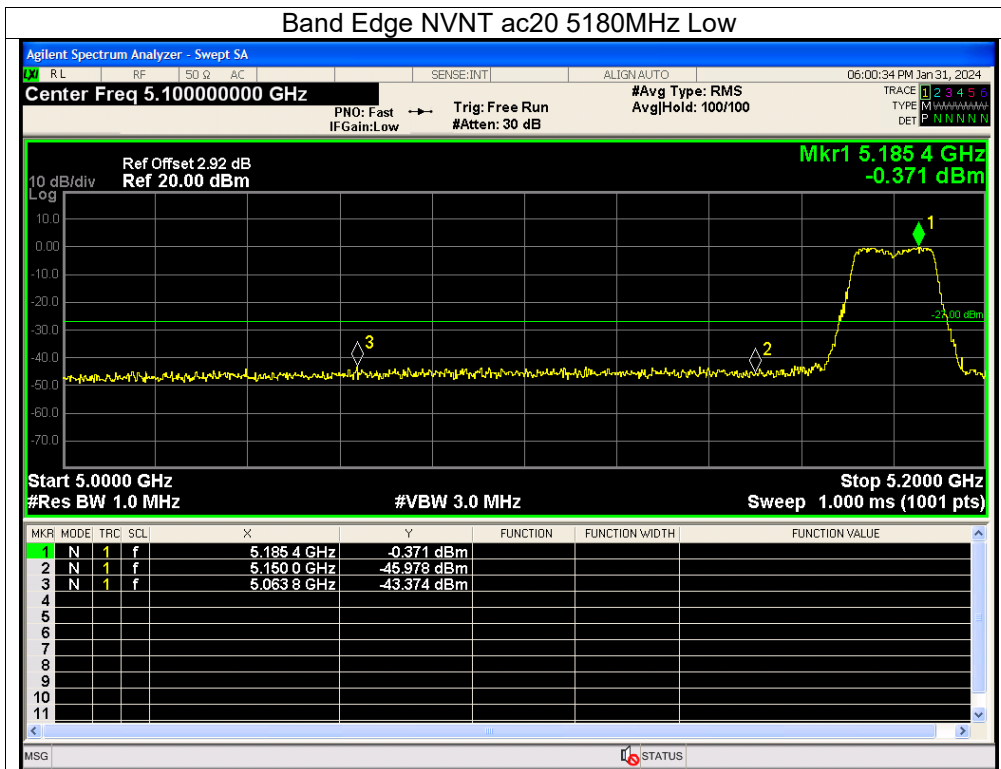

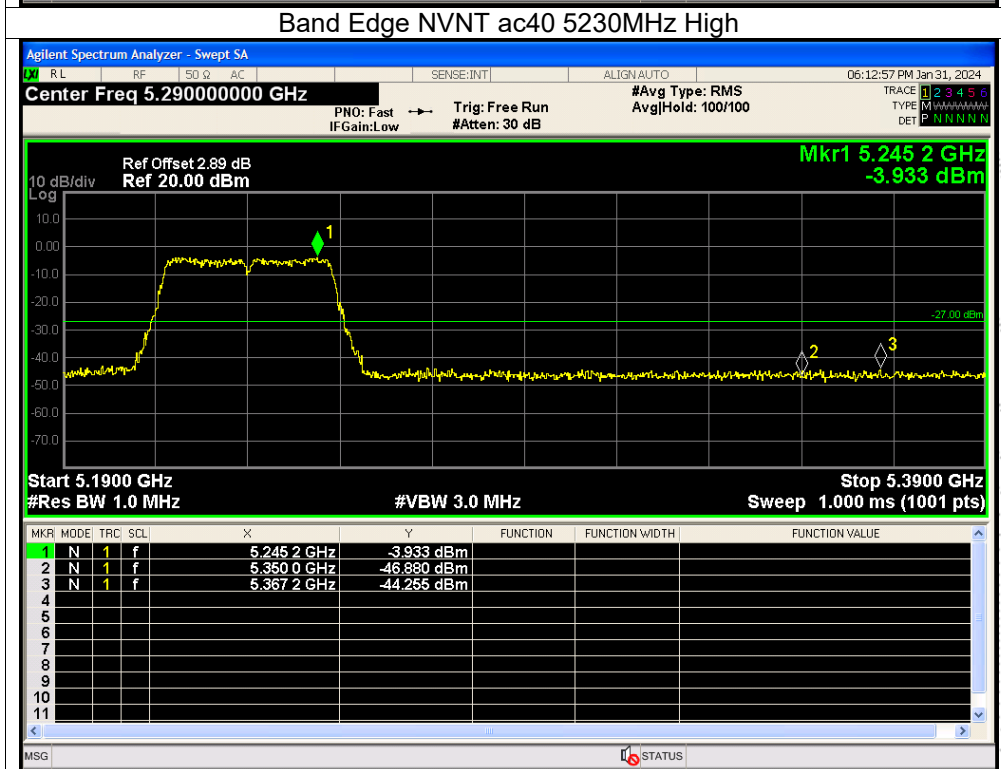
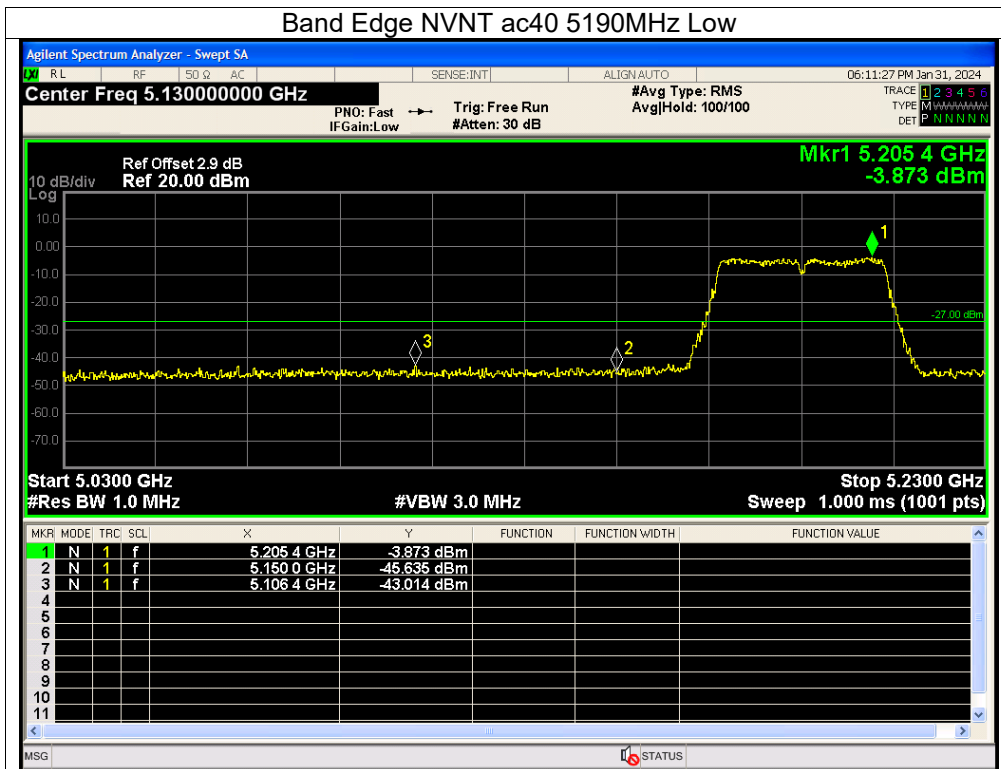

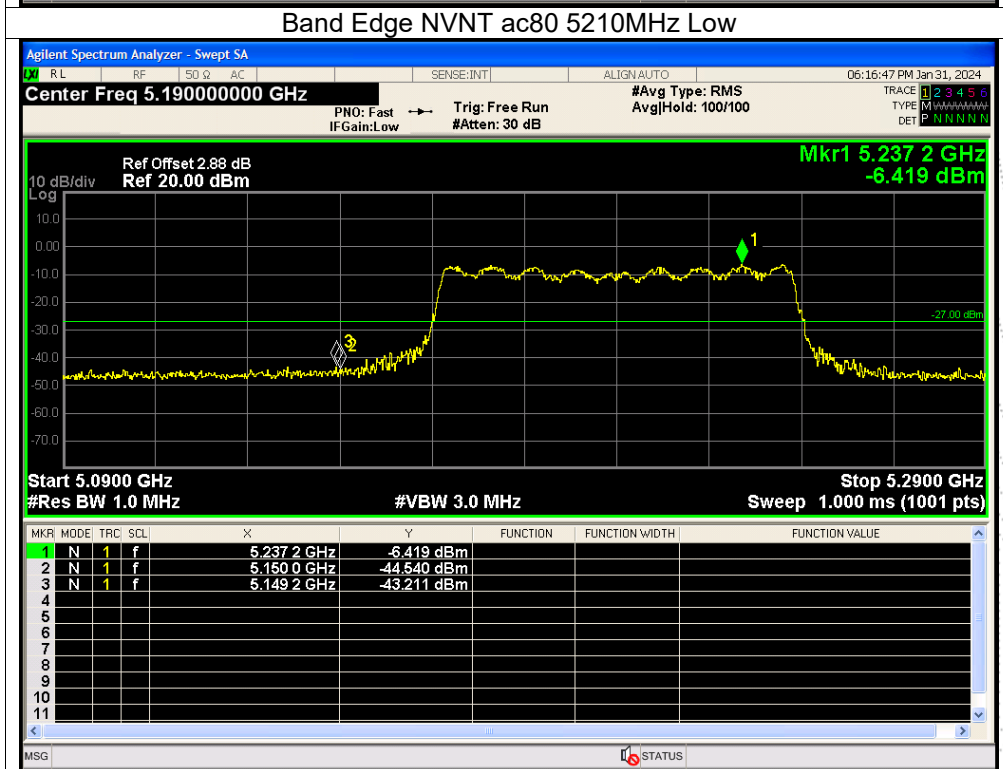
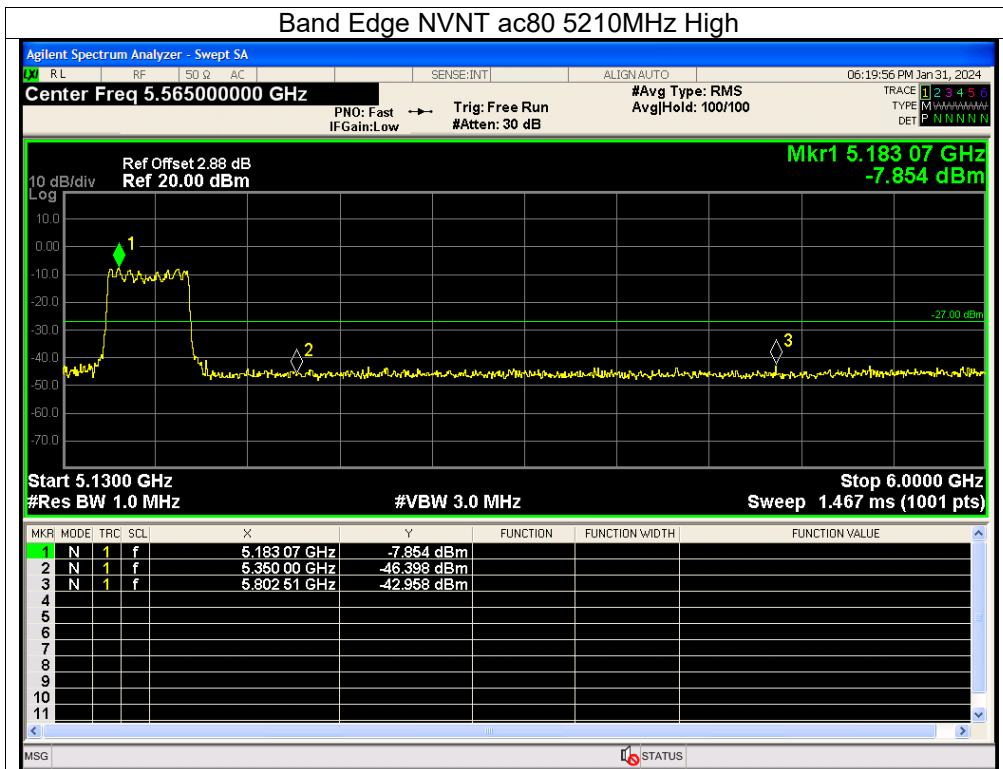

Note: A(B) Represent the value of antenna A and B. The worst data is Antenna A, only shown Antenna A  
 Antenna B: 5745-58250MHz

