



<b>Test Report No.:</b>		<b>16041502.fcc01</b>	Page 1 of 45		
Client:	Tacx b.v. Rijksstraatweg 52, 2241BW Wassenaar, Netherlands				
Test Item:	<b>Digital Transmission System (DTS)</b> <b>ANT+</b>				
Identification:	<b>T2900</b>	Serial Numbers:	<b>86160008 (conducted tests) and 861600013 and 861600019 (radiated tests)</b>		
Project No.:	<b>16041502</b>	Date of Receipt:	<b>September 08, 2016</b>		
Testing Location:	<b>TÜV Rheinland Nederland B.V.</b> Eiberkamp 10 9351VT Leek				
Test Specification:	FCC 47 CFR Part 15, Subpart C, Section 15.247 (10-1-15 Edition) RSS-Gen (Issue 4, November 2014) and RSS-247 (Issue 1, May 2015) ANSI C63.10-2013				
<p>This report shall not be reproduced, except in full, without the written permission of TÜV Rheinland Nederland B.V.          The test results relate only to the item(s) tested.</p>					
Test Result:	The test item <b>passed</b> the test specification(s).				
Testing Laboratory:	<b>TÜV Rheinland Nederland B.V.</b> Eiberkamp 10 9351 VT Leek				
Tested by:		Reviewed by:			
2016-10-10	R. van der Meer / Inspector	2016-10-10	P. de Beer / Reviewer		
Date	Name/Position	Signature	Date	Name/Position	Signature
Other Aspects:-.					
Abbreviations: P(ass) = passed F(ail) = failed N/A = not applicable N/T = not tested					

Test Report No.:

**16041502.fcc01**

Page 2 of 45

## TEST SUMMARY

### **5.1.1 CONDUCTED MEASUREMENTS AT ANTENNA PORT**

*RESULT: Pass*

### **5.1.2 6dB AND 99% BANDWIDTH**

*RESULT: Pass*

### **5.1.3 PEAK POWER SPECTRAL DENSITY**

*RESULT: Pass*

### **5.1.4 BAND EDGE CONDUCTED EMISSIONS**

*RESULT: Pass*

### **5.1.5 RADIATED SPURIOUS EMISSIONS OF TRANSMITTER**

*RESULT: Pass*

### **5.2.1 AC POWER LINE CONDUCTED EMISSION OF TRANSMITTER**

*RESULT: Pass*

## Contents

<b>1.</b>	<b>GENERAL REMARKS .....</b>	<b>4</b>
<b>1.1</b>	<b>COMPLEMENTARY MATERIALS .....</b>	<b>4</b>
<b>2.</b>	<b>TEST SITES .....</b>	<b>4</b>
<b>2.1</b>	<b>TEST FACILITIES .....</b>	<b>4</b>
<b>2.2</b>	<b>LIST OF TEST AND MEASUREMENT INSTRUMENTS TABLE 1: LIST OF TEST AND MEASUREMENT EQUIPMENT.....</b>	<b>5</b>
<b>2.3</b>	<b>MEASUREMENT UNCERTAINTY .....</b>	<b>6</b>
<b>3.</b>	<b>GENERAL PRODUCT INFORMATION.....</b>	<b>7</b>
<b>3.1</b>	<b>PRODUCT FUNCTION AND INTENDED USE.....</b>	<b>7</b>
<b>3.2</b>	<b>SYSTEM DETAILS .....</b>	<b>7</b>
<b>3.3</b>	<b>COUNTERMEASURES TO ACHIEVE EMC COMPLIANCE.....</b>	<b>8</b>
<b>4.</b>	<b>TEST SET-UP AND OPERATION MODES .....</b>	<b>9</b>
<b>4.1</b>	<b>TEST METHODOLOGY .....</b>	<b>9</b>
<b>4.2</b>	<b>OPERATION MODES .....</b>	<b>9</b>
<b>4.3</b>	<b>PHYSICAL CONFIGURATION FOR TESTING .....</b>	<b>10</b>
<b>4.4</b>	<b>TEST SOFTWARE .....</b>	<b>12</b>
<b>4.5</b>	<b>SPECIAL ACCESSORIES AND AUXILIARY EQUIPMENT .....</b>	<b>13</b>
<b>5.</b>	<b>TEST RESULTS .....</b>	<b>14</b>
<b>5.1</b>	<b>CONDUCTED MEASUREMENTS AT ANTENNA PORT.....</b>	<b>14</b>
5.1.1	<i>Conducted Output Power.....</i>	<i>14</i>
5.1.2	<i>6dB and 99% Bandwidth.....</i>	<i>18</i>
5.1.3	<i>Peak Power Spectral Density .....</i>	<i>25</i>
5.1.4	<i>Band Edge Conducted Emissions .....</i>	<i>29</i>
5.1.5	<i>Radiated Spurious Emissions of Transmitter.....</i>	<i>32</i>
<b>5.2</b>	<b>AC POWER LINE CONDUCTED MEASUREMENTS.....</b>	<b>41</b>
5.2.1	<i>AC Power Line Conducted Emission of Transmitter.....</i>	<i>42</i>
5.2.2	<i>Plots of the AC Power-line Conducted Emissions.....</i>	<i>43</i>

Test Report No.:

**16041502.fcc01**

Page 4 of 45

## **1. General Remarks**

### **1.1 Complementary Materials**

There is no attachment to this test report.

## **2. Test Sites**

### **2.1 Test Facilities**

The Federal Communications Commission and Industry Canada has reviewed the technical characteristics of the test facilities at TÜV Rheinland Nederland B.V., located in Leek, 9351VT Eiberkamp 10, The Netherlands, and has found these test facilities to be in compliance with the requirements of 47 CFR Part 15, section 2.948.

The description of the test facilities has been filed at the Office of the Federal Communications Commission under registration number 90828. The facility has been added to the list of laboratories performing these test services for the public on a fee basis.

The description of the test facilities has been filed to Industry Canada under registration number 2932G-2. The facility has been added to the list of laboratories performing these test services for the public on a fee basis.

Normal test conditions:

Temperature (\*) : +15°C to +35°C  
Relative humidity(\*) : 20 % to 75 %  
Supply voltage : 120 VAC.

When it was impracticable to carry out the tests under these conditions, a note to this effect stating the ambient temperature and relative humidity during the tests are stated separately.

Test Report No.:

**16041502.fcc01**

Page 5 of 45

## 2.2 List of Test and Measurement Instruments

**Table 1: List of Test and Measurement Equipment**

Kind of Equipment	Manufacturer	Model Name	Inventory number	Calibration date (mm/yyyy)	Calibration due date (mm/yyyy)
<b>For Antenna Port Conducted Emissions</b>					
Temperature-Humiditymeter	Extech	SD500	A00446	04/2016	04/2017
Spectrum Analyzer	Rohde & Schwarz	FSV	A01744	07/2016	07/2017
RF Cable	Huber + Suhner	Sucoflex 102	A00347	05/2016	05/2017
<b>For Radiated Emissions</b>					
Measurement Receiver	Rohde & Schwarz	ESCI	A00314	03/2016	03/2017
RF Cable S-AR	Gigalink	APG0500	A00447	01/2016	01/2017
Controller	Maturo	SCU/088/ 8090811	A00450	N/A	N/A
Controller	EMCS	DOC202	A00257	N/A	N/A
Test facility	Comtest	FCC listed: 90828 IC: 2932G-2	A00235	04/2014	04/2017
Spectrum Analyzer	Rohde & Schwarz	FSV	A00337	06/2016	06/2017
Antenna mast	EMCS	AP-4702C	A00258	N/A	N/A
Temperature-Humiditymeter	Extech	SD500	A00444	04/2016	04/2017
Guidehorn 1-18 GHz	EMCO	3115	A00009	04/2016	04/2017
Guidehorn 18-40 GHz	EMCO	RA42-K-F-4B-C	A00012	04/2016	04/2017
Biconilog Testantenna	Teseq	CBL 6111D	A00466	06/2016	06/2017
2.4 GHz bandreject filter	BSC	XN-1783	A00065	N/A	N/A
Bandpass filter 4-10 GHz	Reactel	7AS-7G-6G- 511	A00131	N/A	N/A
Bandpass filter 10-26 GHz	Reactel	9HS- 10G/26.5G- S11	A00151	N/A	N/A
Preamplifier 0.5 - 18 GHz	Miteq	AMF-5D- 005180-28- 13p	A00247	N/A	N/A
Filterbox	EMCS	RFS06S	A00255	02/2016	02/2017

Test Report No.:

**16041502.fcc01**

Page 6 of 45

Kind of Equipment	Manufacturer	Model Name	Inventory number	Calibration date (mm/yyyy)	Calibration due date (mm/yyyy)
<b>For AC Powerline Conducted Emissions</b>					
Pulse limiter	R&S	ESH3-Z2	A00051	01/2016	01/2017
Variac	RFT	LSS020	A00171	NA	NA
LISN	EMCO	3625/2	A00022	01/2016	01/2018
Measurement Receiver	Rohde & Schwarz	ESCS30	A00726	10/2015	10/2016
RF Cable	-	-	A01844	NA	NA
Shielded room for Conducted emissions	--	--	A00437	NA	NA
Temperature-Humidity meter	Extech	SD500	A00441	04/2016	04/2017

Conformance of the used measurement and test equipment with the requirements of ISO/IEC 17025:2005 has been confirmed before testing. NA= Not Applicable

## 2.3 Measurement Uncertainty

**Table 2: Emission Measurement Uncertainty**

Measurement Type	Frequency	Uncertainty
Antenna Port Conducted Emission	< 6GHz	±2.5dB
	> 6GHz	±2.7 to ± 4.2
Radiated Emission		
	30MHz - 1GHz	±5.22dB
	> 1GHz	±5.22dB
AC Power Line Conducted Emissions	150kHz - 30MHz	±3.6dB

### 3. General Product Information

#### 3.1 Product Function and Intended Use

The brand Tacx model T2900, hereafter referred to as EUT, is a transmitter used in an Interactive Smart Trainer with Electric Motor Brake for bicycles to transmit performance data to PC, Tablet or smartphone. The transmitter will support and utilizes GFSK modulation techniques. Although the chip used is capable of multiple data-rates only 1 Mbps is used. The system also incorporates a BLE transceiver but both transmitters never transmit at the same time. The BLE transceiver is covered in a separate test report.

The content of this report and measurement results have not been changed other than the way of presenting the data.

#### 3.2 System Details

Details and an overview of the system and all of its components, as it has been tested, may be found below.

EUT	:	Digital Transmission System, ANT
Manufacturer	:	Tacx b.v.
Brand	:	Tacx
Model(s)	:	T2900
Serial Number	:	861600008 (conducted tests) and 861600013 and 861600019 (radiated tests)
Voltage input rating	:	40 Vac (through AUX3)
Voltage output rating	:	--
Current input rating	:	--
Antenna	:	Internal, integrated on the PCB
Antenna Gain	:	+ 2.0 dBi
Operating frequency	:	2403 MHz-2480 MHz.
Modulation	:	GFSK
Data-rate	:	1 Mbps
Remarks	:	n.a.

*Test Report No.:*

**16041502.fcc01**

*Page 8 of 45*

**Table 3: Interfaces present on the EUT**

There are no interface ports present on the EUT.

**3.3 Countermeasures to achieve compliance**

No additional measures were employed to achieve compliance.



## **4. Test Set-up and Operation Modes**

### **4.1 Test Methodology**

The test methodology used is based on the requirements of RSS-GEN, RSS-247, 47 CFR Part 15, Sections 15.31, 15.33, 15.35, 15.205, 15.207, 15.209, 15.247.

The test methods, which have been used, are based on ANSI C63.10-2013.

### **4.2 Operation Modes**

Testing was performed at the lowest operating frequency (2403 MHz), at the operating frequency in the middle of the specified frequency band (2442 MHz) and at the highest operating frequency (2480 MHz). These operation modes were selected after review of the capabilities and characteristics of the EUT. The test software as mentioned in section 4.4 enabled the settings of these modes.

The EUT has been tested in the modes as described in table below

<b>Operation Mode</b>	<b>EUT Status</b>	<b>Frequency (MHz)</b>	<b>TX power control setting</b>
Transmit (Tx)	On	2403	4
Transmit (Tx)	On	2442	4
Transmit (Tx)	On	2480	4

### 4.3 Physical Configuration for Testing

For programming purposes only the EUT was connected to the usb port of a laptop computer. The laptop computer was used to configure the EUT to continuously transmit at a specified output power and channel as specified in the test data. See section 4.5 for Auxiliary details.

The EUT was tested on a stand-alone basis and the test system was configured in a way that a load condition was emulated by a bicycle wheel that was spun by a controllable speed.

The justification and manipulation of cables and equipment in order to simulate a worst-case behavior of the test setup has been carried out as prescribed in ANSI C63.10-2013.

**Figure 1a: Test Setup Diagram – antenna port conducted tests and programming.**

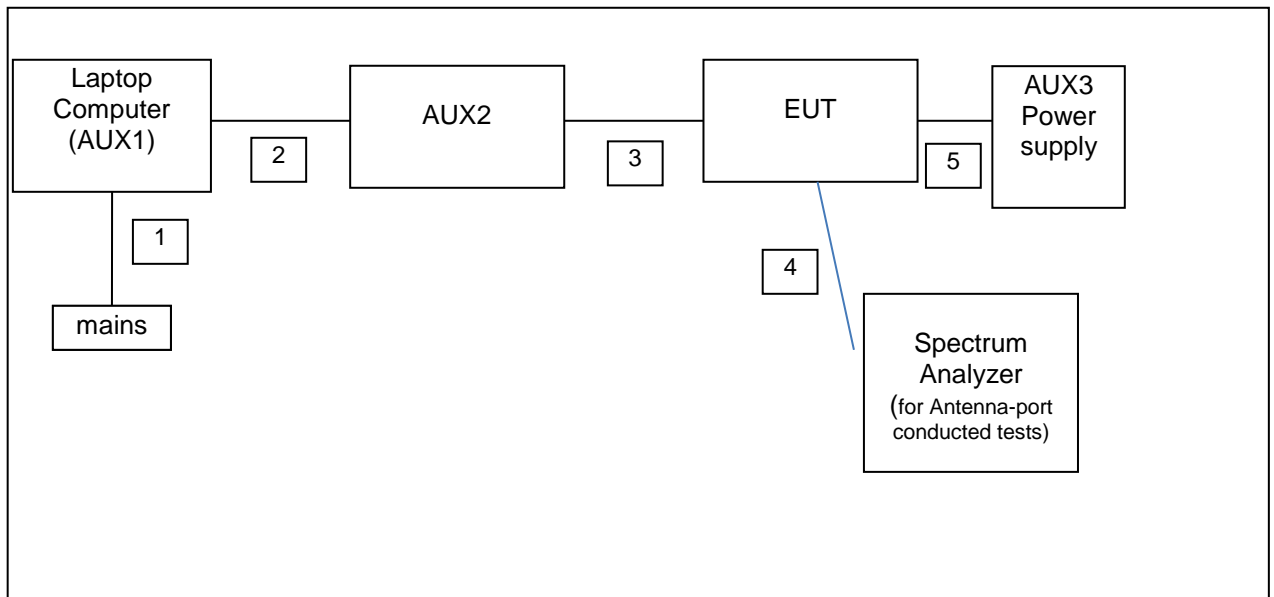

No.	Port	From	To	Remarks
1.	Mains	Mains	Laptop (AUX1)	Through a power supply
2.	Data com.	Laptop USB	AUX2	--
3.	Data com.	AUX2	EUT	--
4.	Antenna port	EUT	Spectrum analyzer	Conducted tests
5.	Power supply	AUX3	EUT	40 Vac

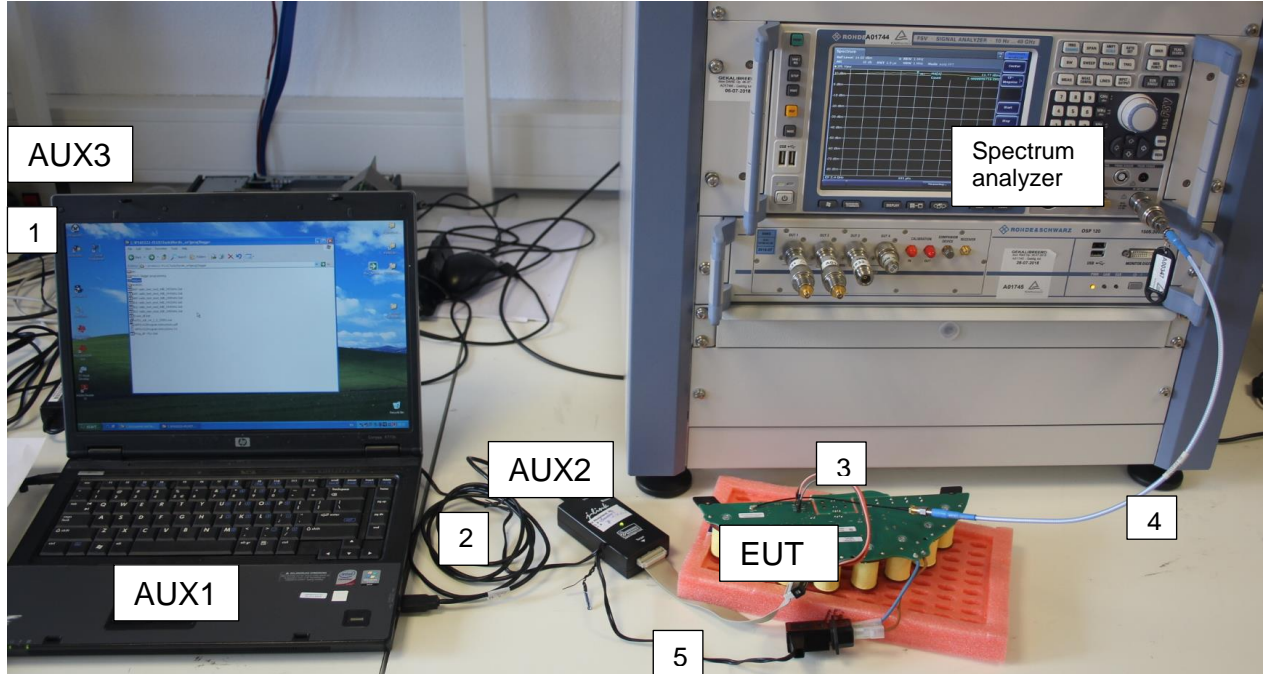

Figure 2b: Test Setup Photos – conducted tests and programming.

## 4.4 Test Software

A continuous transmit mode could be initiated by using test software as supplied by the applicant. The test software was used to define various different operational modes of the EUT for the purpose of compliance testing. The version of the test software, as supplied by the applicant and used during all tests is:

Test software : nRFTools 51422 v1.0.0

Batch files programmed by the applicant are used to make the required settings.

This software was running on a laptop computer (AUX1). It was used to enable the test operation modes listed in section 4.2 as appropriate.

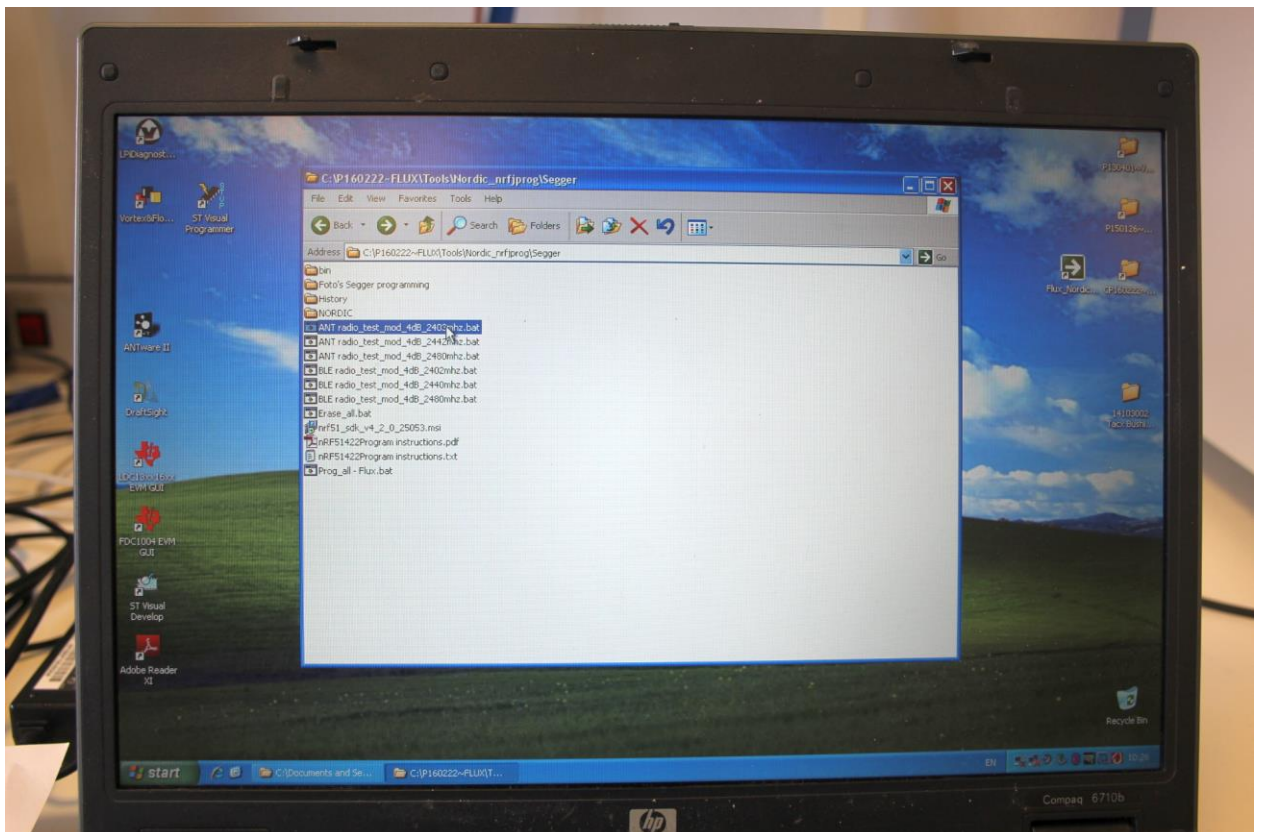

Photograph of the software (and settings) as used on AUX1

## 4.5 Special Accessories and Auxiliary Equipment

The product has been tested together with the following additional accessories:

The auxiliary items were not used during testing, but instead are only used to make the required settings for testing. For setting the transmit frequency, enable modulation etc.

1. AUX1  
Product: Laptop Computer  
Brand: HP  
Model: Compaq 6710b  
Serial Number: CNU8150MD3  
Remark: host for test software, property applicant
  
2. AUX2  
Product: Programming interface  
Brand: Segger  
Model: J-Link Base version 9.3  
Serial Number: 59307055  
Remark: property applicant
  
3. AUX3  
Product: Power Supply Adapter  
Brand: --  
Model: FW 6299  
Serial Number: 4197  
Input voltage: 230 Vac 50 Hz  
Output voltage: 40 Vac  
Remark: property applicant



Test Report No.:

**16041502.fcc01**

Page 14 of 45

## 5. Test Results

### 5.1 Conducted Measurements at Antenna Port

#### 5.1.1 Conducted Output Power

**RESULT: PASS**

Date of testing: 2016-09-14

Requirements:

FCC 15.247(b)(3)

For systems using digital modulation in the 2400-2483.5 MHz band, the maximum peak output power is 1W (+30dBm).

RSS-247 section 5.4(4): the e.i.r.p. shall not exceed 4 W (+36 dBm).

Test procedure:

The Peak Conducted Output Power was measured using the method according to section 11.9.1.1 in ANSI C63.10-2013.

The maximum peak output power (conducted) was measured at the antenna connector with a spectrum analyzer. The final measurement takes into account the loss generated by all the involved cables.

Measurement uncertainty is +/- 2.5 dB.

Notes:  $mW = 10^{(dBm/10)}$   
 $dBm = 10 \times \log(mW)$

**plots : Peak power plots,**

Figures 1a, 1b and 1c show plots of the Peak Power outputs, correction factors (= 0.8dB Cableloss) included in the reading.

Test Report No.:

**16041502.fcc01**

Page 15 of 45

**Conducted Output Power**

Frequency [MHz]	Output Power [dBm]	Limit [dBm]	Verdict [Pass/Fail]	Antenna Gain (dBi)	EIRP (dBm)	EIRP (mW)	Plot number
2403	2.78 (1.90 mW)	+30	Pass	+2.0	4.78	3.00	1A
2442	2.55 (1.80 mW)	+30	Pass	+2.0	4.55	2.85	1B
2480	2.09 (1.62 mW)	+30	Pass	+2.0	4.09	2.56	1C

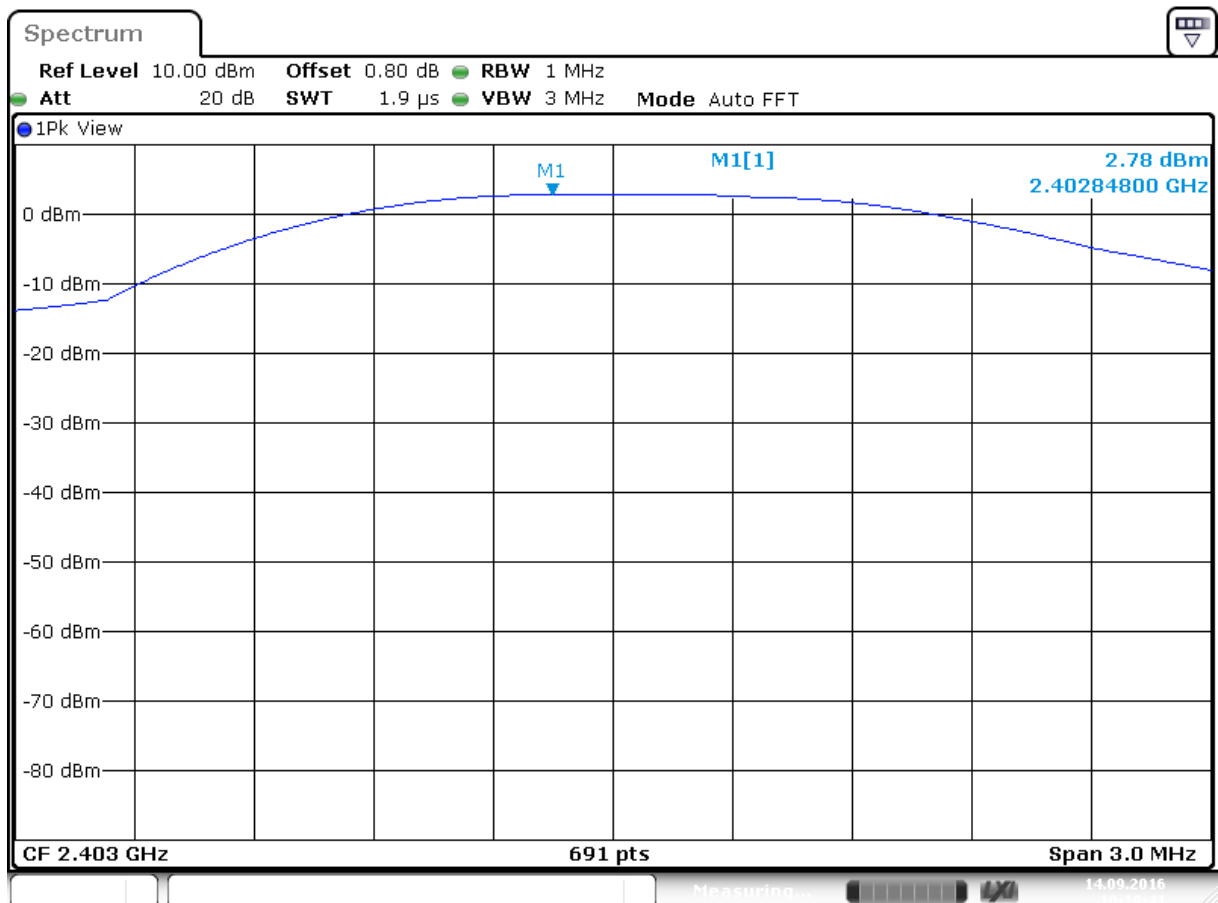

Date: 14.SEP.2016 10:19:41

Plot A

Test Report No.:

**16041502.fcc01**

Page 16 of 45



Date: 14 SEP 2016 10:21:15

Plot B



Test Report No.:

**16041502.fcc01**

Page 17 of 45

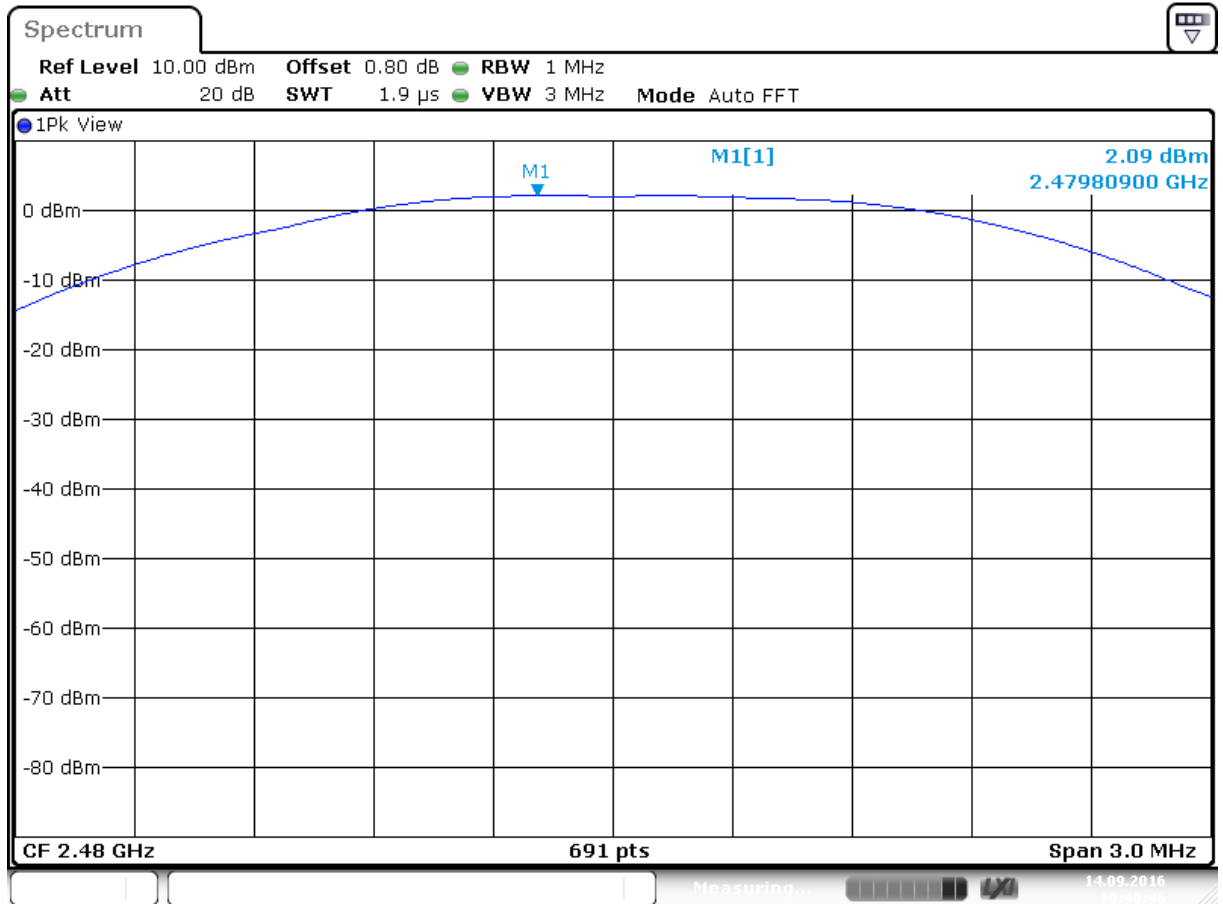

Date: 14 SEP 2016 10:40:45

Plot C

Test Report No.:

**16041502.fcc01**

Page 18 of 45

## 5.1.2 6dB and 99% Bandwidth

### RESULT: Pass

Date of testing: 2016-09-14

#### Requirements:

FCC 15.247(a)(2) and RSS-247 Section 5.2(1)

For systems using digital modulation in the 2400-2483.5MHz band, the 6dB bandwidth shall be at least 500kHz.

For 99% Bandwidth: RSS-Gen Section 4.6.1: No requirement is given.

#### Test procedure 6dB bandwidth:

ANSI C63.10-2013 section 11.8.1 Option 1

A spectrum analyzer was connected to the antenna port of the EUT. The spectrum analyzer resolution bandwidth was set to 100kHz, video bandwidth to 300kHz and the span wide enough to capture the modulated carrier.

#### For 99% Bandwidth:

RSS-Gen.

The transmitter shall be operated at its maximum carrier power measured under normal test conditions. The span of the analyzer shall be set to capture all products of the modulation process, including the emission skirts. The resolution bandwidth shall be set as close to 1% of the selected span as is possible without being below 1%. The video bandwidth shall be set to 3 times the resolution bandwidth. Video averaging is not permitted. Where practical, a sampling detector shall be used given that a peak or peak hold may produce a wider bandwidth than actual.

A spectrum analyzer was connected to the antenna port of the EUT. The spectrum analyzer resolution bandwidth was set to 1% of the selected span, Video bandwidth was set to 3 times the resolution bandwidth. The span was set to capture the whole modulation process. The Spectrum analyzers automated function for 99% BW was used.  
Measurement uncertainty is +/- 26kHz.

Plots A1,B1 and C1 shown on the next pages are of the 6 dB bandwidth.  
Plots A2,B2 and C2 shown on the next pages are of the 99% bandwidth

Test Report No.:

**16041502.fcc01**

Page 19 of 45

**6dB Bandwidth**

Operating Frequency [MHz]	99% Bandwidth [kHz]	6dB Bandwidth [kHz]	Limit [kHz]	Verdict [Pass/Fail]	Plot number
2403	2040.52	600.6	>500	Pass	A1/A2
2442	1808.97	629.5	>500	Pass	B1/B2
2480	1396.50	578.9	>500	Pass	C1/C2

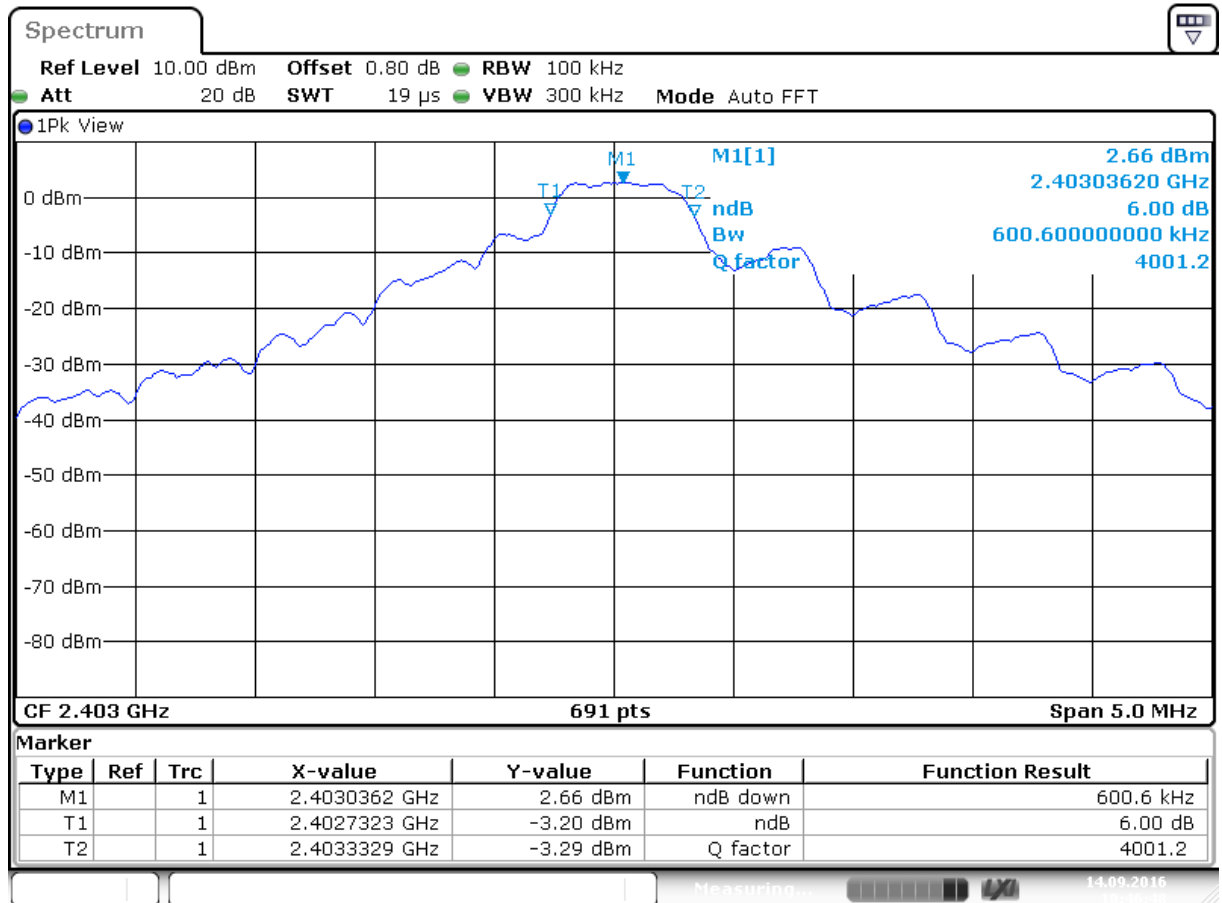

Date: 14 SEP 2016 10:46:48

Plot A1





Test Report No.:

**16041502.fcc01**

Page 22 of 45

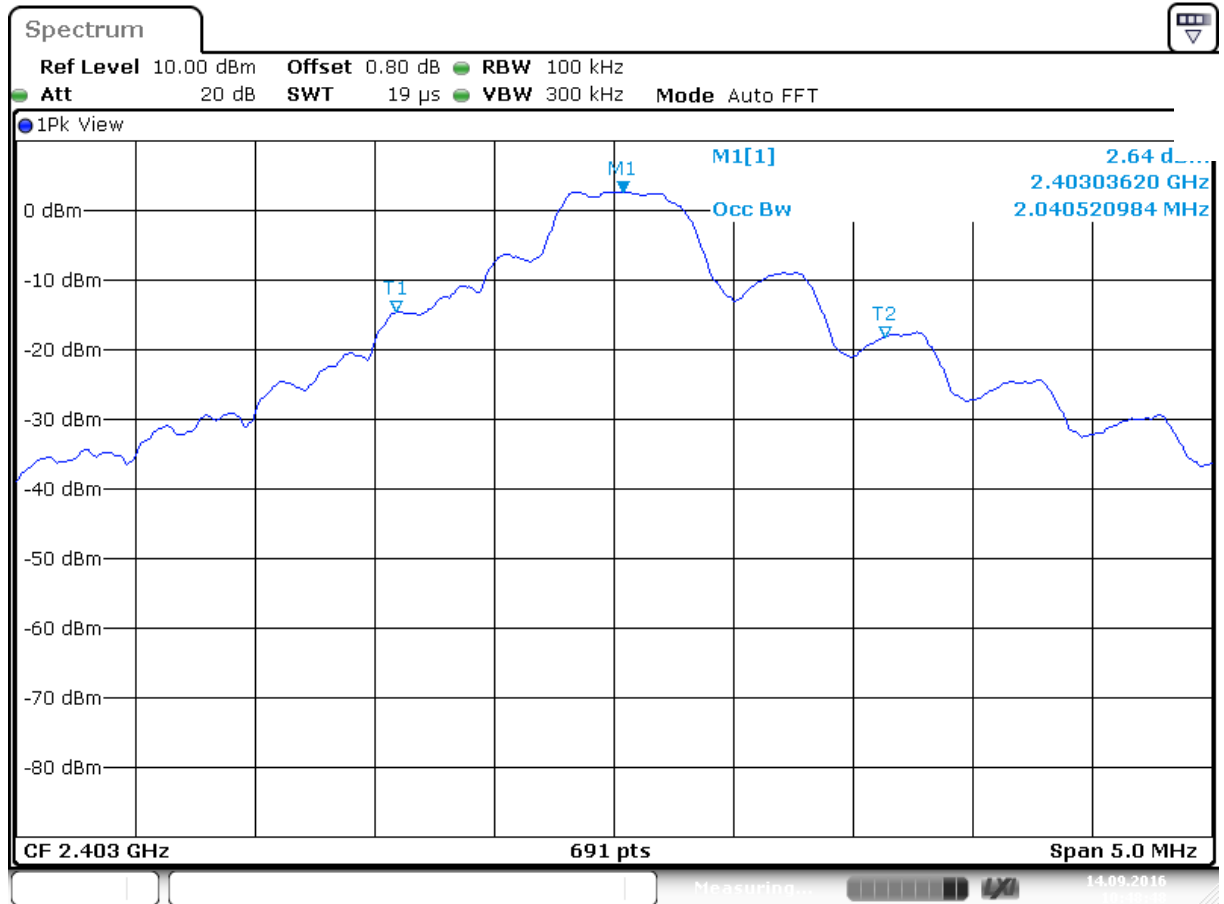

Date: 14 SEP 2016 10:48:48

Plot A2

Test Report No.:

**16041502.fcc01**

Page 23 of 45

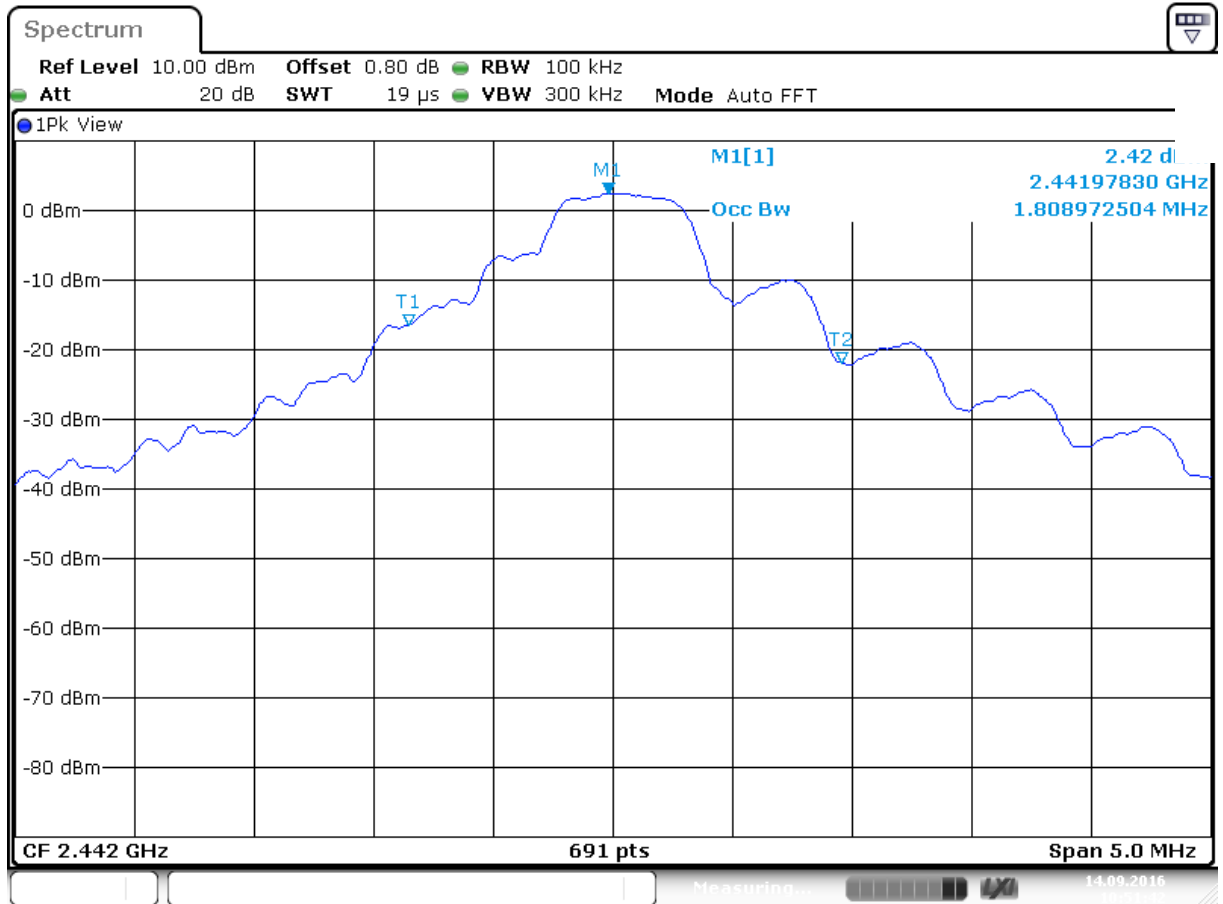

Date: 14 SEP 2016 10:51:42

Plot B2

Test Report No.:

**16041502.fcc01**

Page 24 of 45

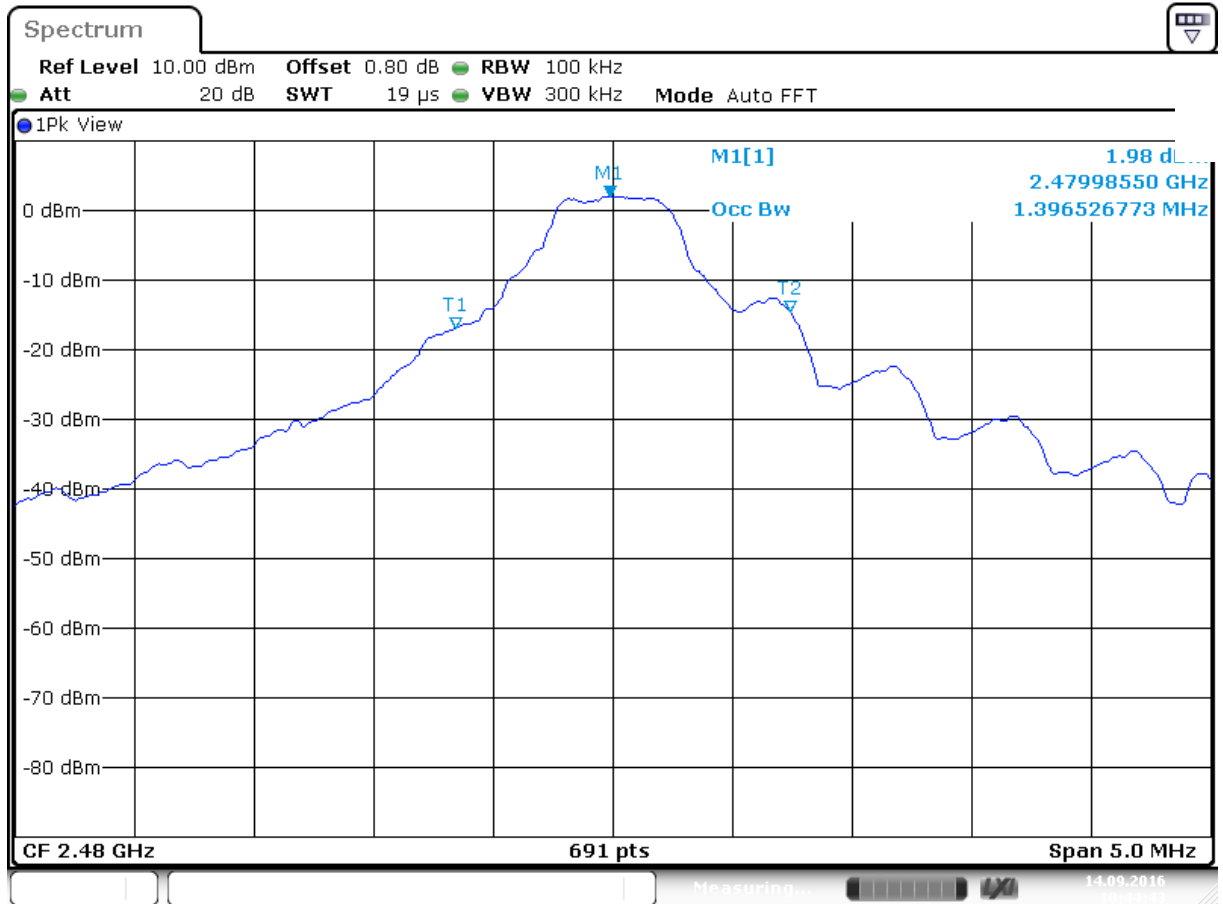

Date: 14 SEP 2016 10:44:43

Plot C2



Test Report No.:

**16041502.fcc01**

Page 25 of 45

### **5.1.3 Peak Power Spectral Density**

**RESULT: Pass**

Date of testing: 2016-09-14

Requirements:

FCC 15.247(e) and RSS-247 section 5.2(2)

For digitally modulated systems, the power spectral density (PSD) conducted from the intentional radiator to the antenna shall not be greater than 8dBm in any 3kHz band during any time interval of continuous transmission.

Test procedure:

ANSI C63.10-2013

The section 11.10.2 PKPSD peak PSD procedure was used. A spectrum analyzer was connected to the antenna port of the EUT. The analyzer resolution bandwidth was set to 3kHz and the video bandwidth was set to 10kHz. The sweep time was set to auto couple and the trace was allowed to stabilize before making the final measurement. By using the Peak marker function the maximum amplitude was determined. The final measurement takes into account the loss generated by all the involved cables (0.8 dB).

Measurement uncertainty is +/- 1.1 dB.

Test Report No.:

**16041502.fcc01**

Page 26 of 45

**Peak Power Spectral Density**

Operating Frequency [MHz]	Max PSD [dBm]	Limit [dBm]	Verdict [Pass/Fail]	Plot
2403	-6.51	8	Pass	A
2442	-8.36	8	Pass	B
2480	-7.51	8	Pass	C

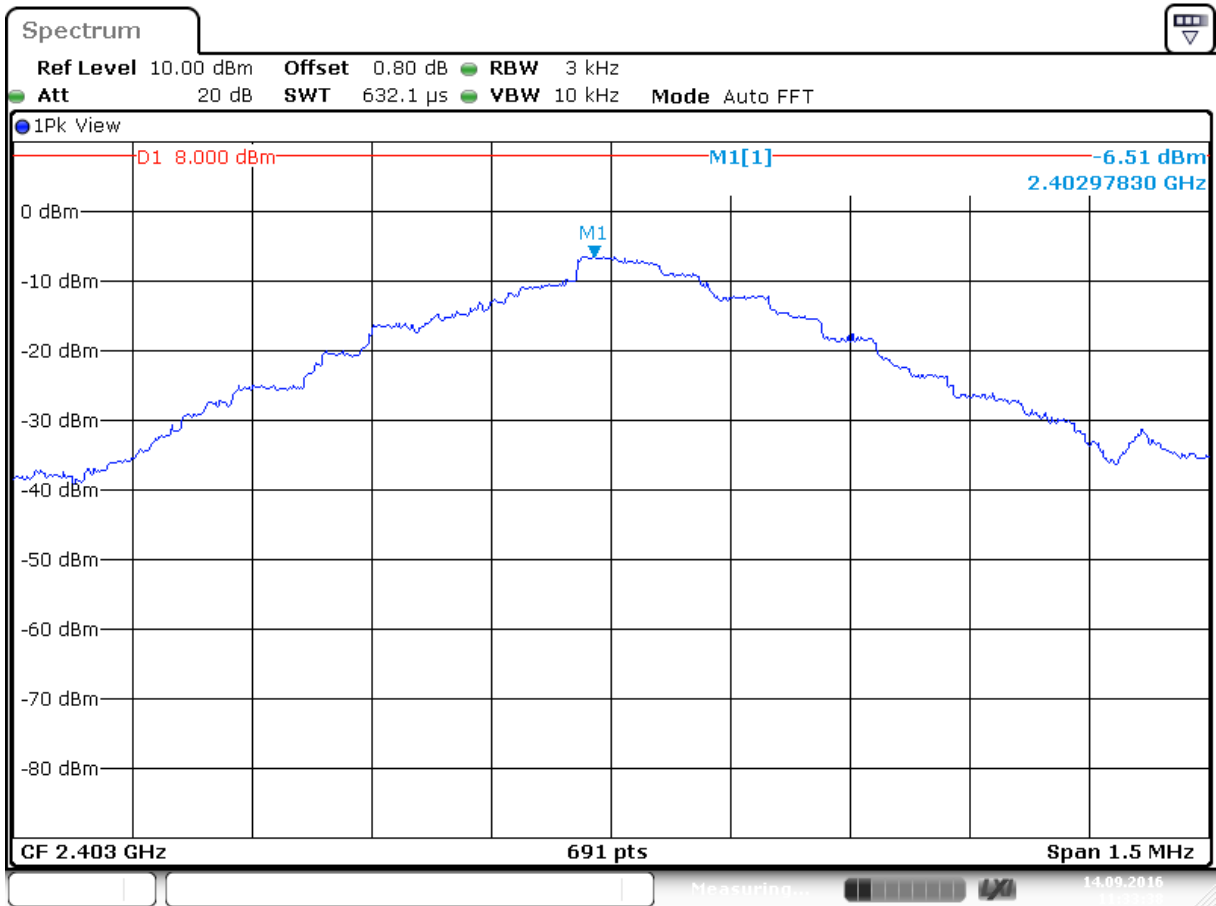

Date: 14.SEP.2016 11:33:38

Plot A

Test Report No.:

**16041502.fcc01**

Page 27 of 45

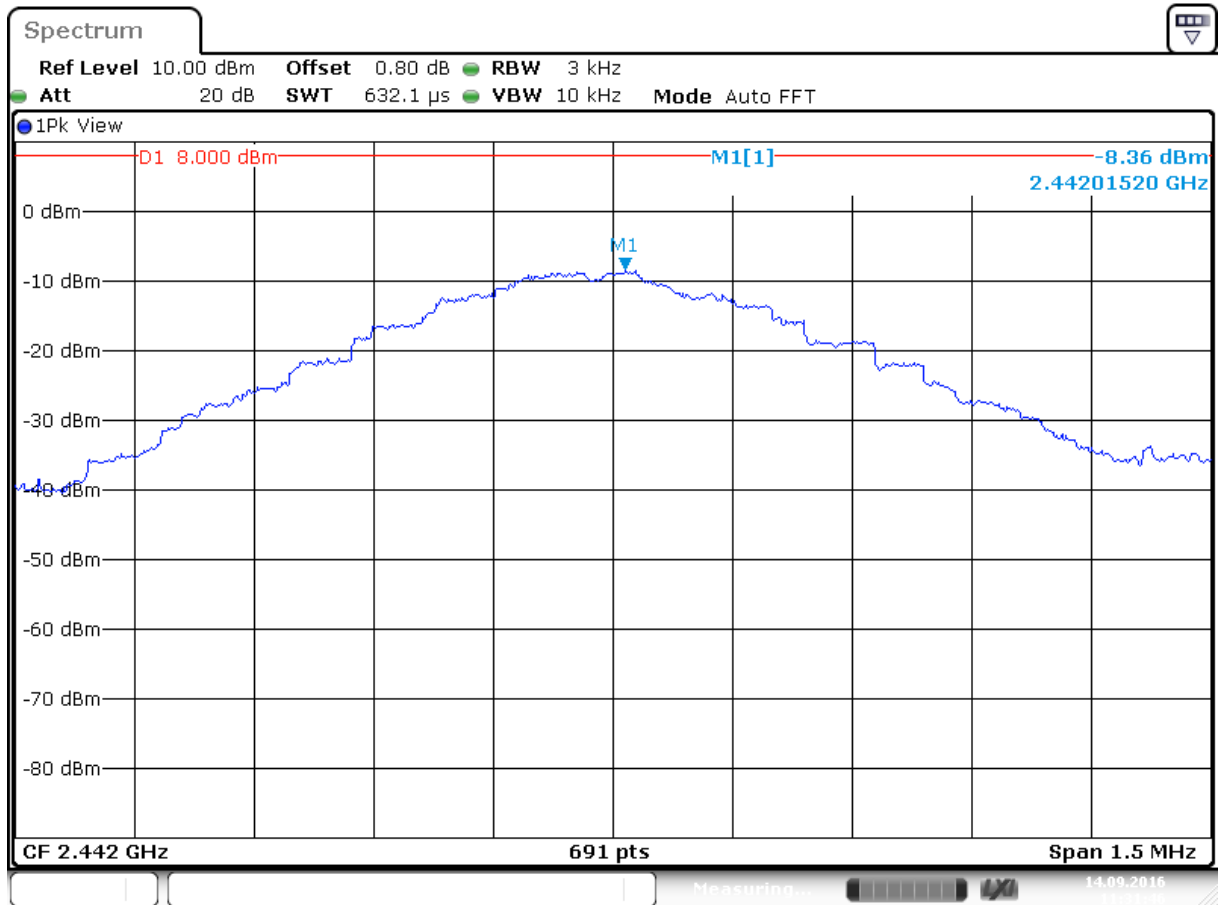

Date: 14 SEP 2016 11:31:46

Plot B

Test Report No.:

**16041502.fcc01**

Page 28 of 45

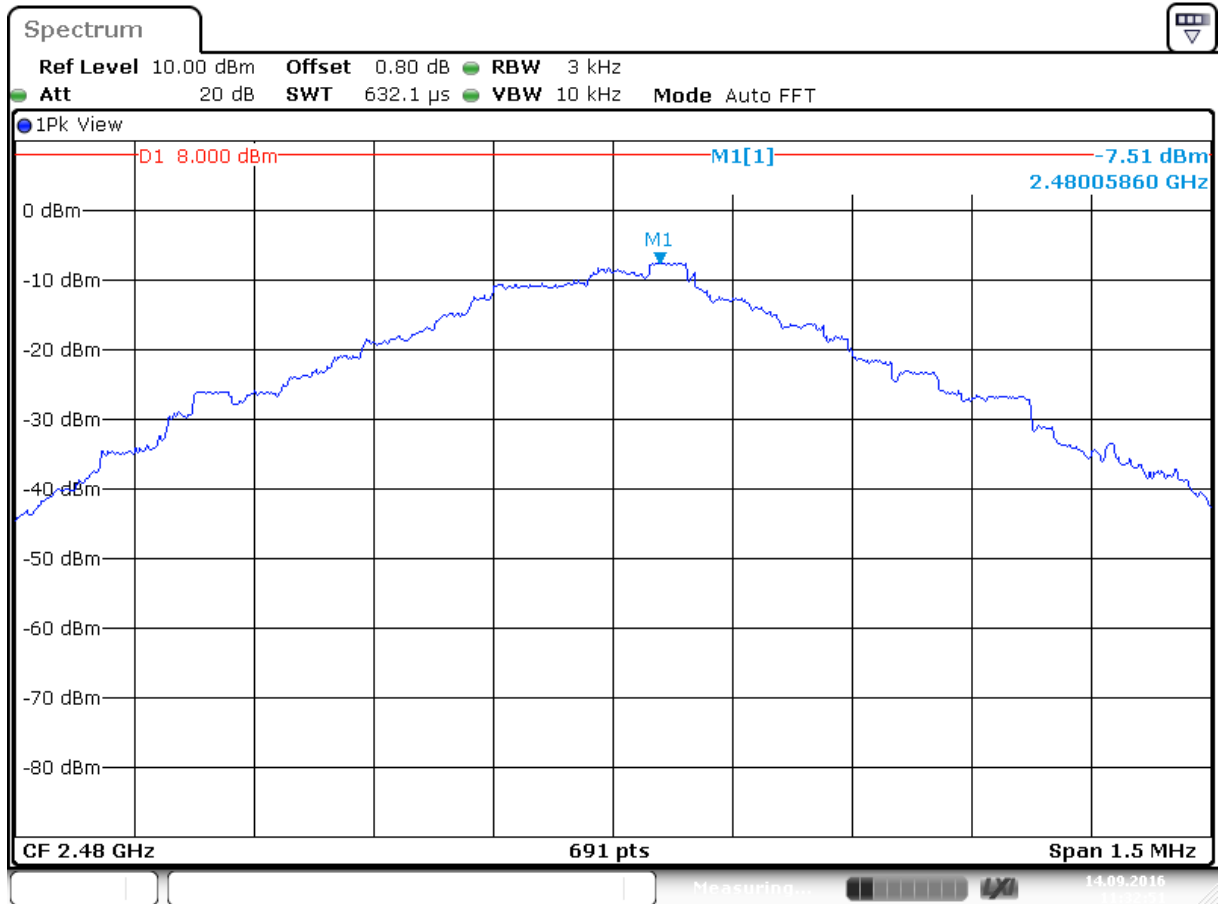

Date: 14 SEP 2016 11:32:51

Plot C

Test Report No.:

**16041502.fcc01**

Page 29 of 45

## 5.1.4 Band Edge Conducted Emissions

**RESULT: Pass**

Date of testing: 2016-09-14

Requirements:

FCC 15.205, FCC 15.209, FCC 15.247(d) and RSS-247 section 5.5

In any 100 kHz bandwidth outside the frequency band in which the spread spectrum or digitally modulated intentional radiator is operating, the radio frequency power that is produced by the intentional radiator shall be at least 20 dB below that in the 100 kHz bandwidth within the band that contains the highest level of the desired power, based on either an RF conducted or a radiated measurement, provided the transmitter demonstrates compliance with the peak conducted power limits.

Test procedure:

ANSI C63.10-2013  
Section 11.13

The marker-delta method, as described in ANSI C63.10 was used.

Measurements were performed using a spectrum analyzer with a suitable span to encompass the peak of the fundamental and using the following settings:  
RBW = 100kHz, VBW = 300kHz.

The highest emission amplitudes relative to the appropriate limit were measured and recorded in this report.

Measurement uncertainty is +/- 2.5 dB.

Results: All out of band spurious emissions are more than 20 dB below the fundamental. See the figures on the following pages.

Test Report No.:

**16041502.fcc01**

Page 30 of 45

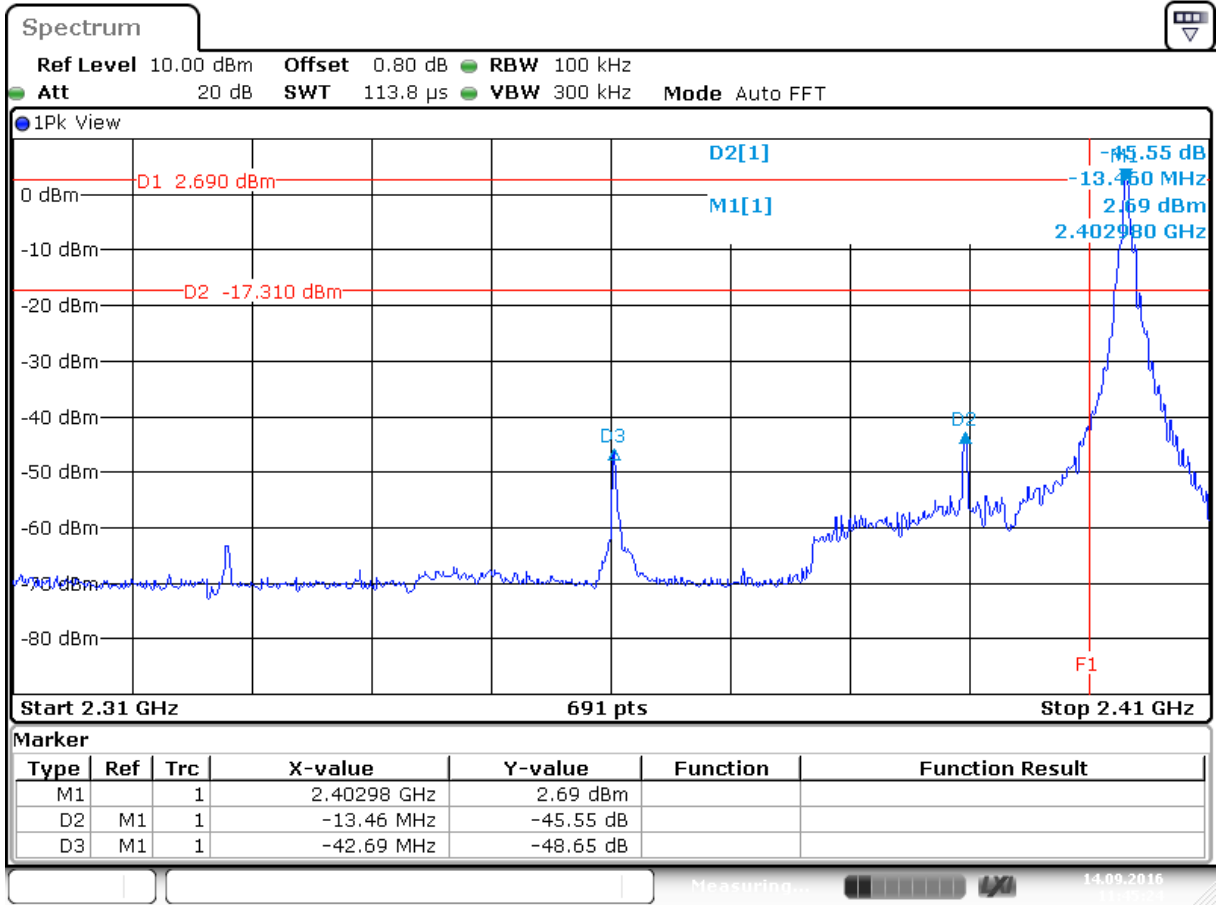

Date: 14 SEP 2016 11:45:24

Plot: Band Edge Conducted Emission, Spectral Diagram, 2403 MHz

Plot showing more than 20 dB band edge attenuation.

F1 shows the band edge frequency of 2400 MHz.

Test Report No.:

**16041502.fcc01**

Page 31 of 45

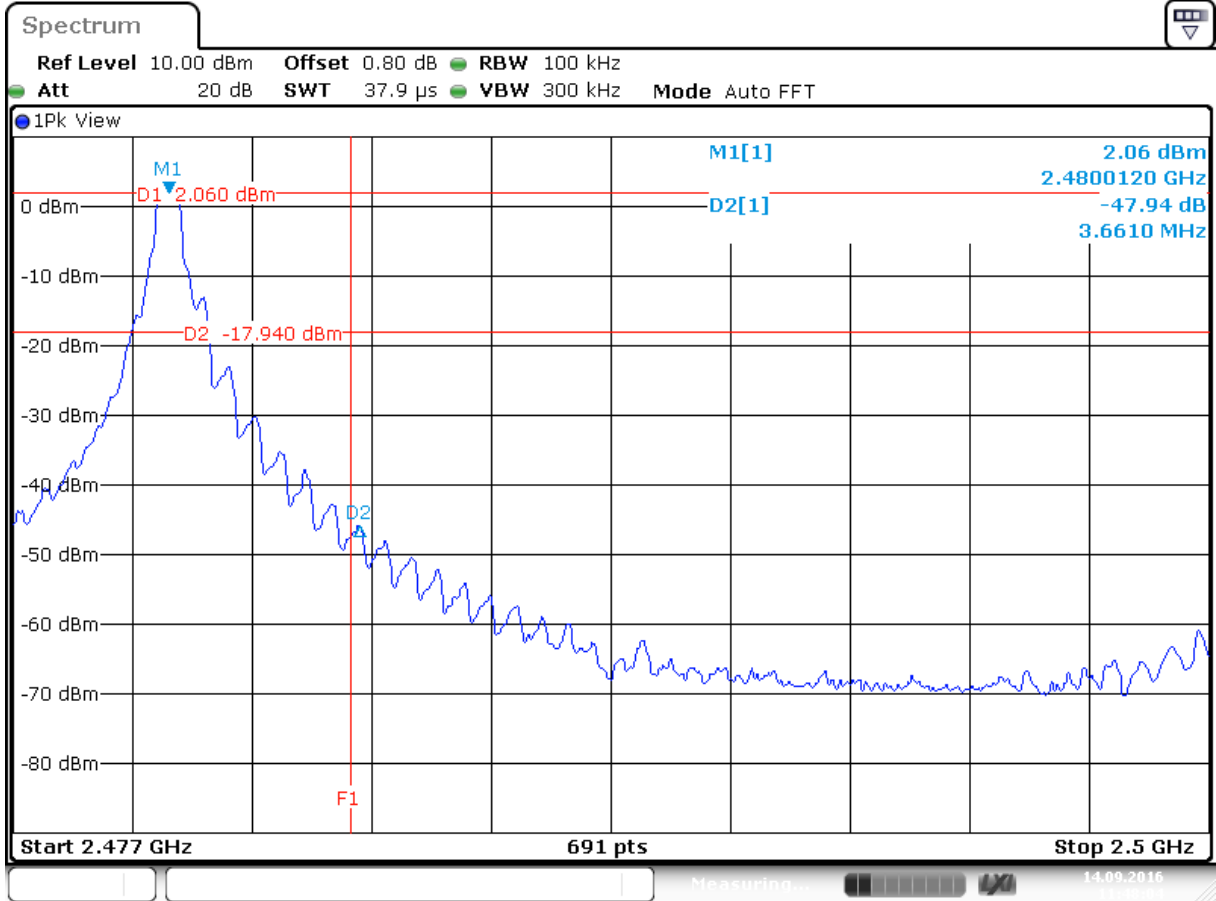

Date: 14.SEP.2016 11:48:05

Plot: Band Edge Conducted Emission, Spectral Diagram, 2480 MHz.  
Plot showing more than 20 dB band edge attenuation.  
F1 shows the band edge frequency of 2483.5 MHz.

Test Report No.:

**16041502.fcc01**

Page 32 of 45

## 5.1.5 Radiated Spurious Emissions of Transmitter

### RESULT: Pass

Date of testing: 2016-09-19 and 30

Frequency range: 30MHz - 25GHz

#### Requirements:

FCC 15.209 and FCC 15.247(d) and RSS-Gen

Radiated emissions which fall outside the operation frequency band and outside restricted bands shall either meet the limit specified in FCC 15.209(a) or be attenuated at least 20dB below the power level in the 100kHz bandwidth within the band that contains the highest level of the desired power (the less severe limit applies).

Radiated emissions which fall in the restricted bands, as defined in FCC 15.205(a) and RSS-Gen Table 6, must comply with the radiated emission limits specified in FCC 15.209(a) and RSS-Gen Table 4.

#### Test procedure:

ANSI C63.10-2013

The EUT is considered as floor-standing equipment not typically installed with its base in direct electrical contact with, or connected to, a metal floor or grid. The EUT was placed on the test site turntable with insulation material in-between of 4mm thickness to prevent electric contact.

Before final measurements of radiated emissions were performed, the EUT was scanned to determine its emission spectrum profile. The physical arrangement of the test system, the associated cabling were varied in order to ensure that maximum emission amplitudes were attained.

The spectrum was examined from 30MHz to the 10th harmonic of the highest fundamental transmitter frequency (25GHz). Final radiated emission measurements were made at 3m distance.

At each frequency where a spurious emission was found, the EUT was rotated 360° and the antenna was raised and lowered from 1 to 4m in order to determine the emission's maximum level. Measurements were taken using both horizontal and vertical antenna polarizations.

The highest emission amplitudes relative to the appropriate limit were recorded in this report. Field strength values of radiated emissions at frequencies not listed in the tables are more than 20 dB below the applicable limit. The levels are expressed in dBm which are derived from  $\text{dBm} = E(\text{dB}\mu\text{V}/\text{m}) - 95.2\text{dB}$ . Where Peak (Pk) values were at least 6 dB under the Average (Av) limits, Av value was not tested. Where Average values were tested, Average values were measured using a 10Hz Video Bandwidth.



Test Report No.:

**16041502.fcc01**

Page 33 of 45

**Radiated Emissions, 30MHz - 1GHz, Horizontal and Vertical Antenna Orientations**

Frequency [MHz]	Antenna Orientation	Level QP [dBµV/m]	Limit QP [dBµV/m]	Verdict [Pass/Fail]
33.88	Vertical	20.0	40.0	Pass
47.46	Vertical	24.1	40.0	Pass
82.23	Vertical	14.8	40.0	Pass
95.96	Vertical	16.7	43.5	Pass
127.00	Vertical	17.7	43.5	Pass
427.00	Vertical	16.4	46.0	Pass

- Note:
- Level QP = Reading QP + Factor
  - Tested in modes as described in section 4.2, the 6 highest values noted. Preliminary measurements indicated that the radiated emissions from EUT were not affected by the EUT's operating mode or frequency.
  - \*R refers to a frequency in a restricted band
  - Quasi Peak detector used with a bandwidth of 120 kHz.
  - Measurement uncertainty is +/- 5.22 dB.

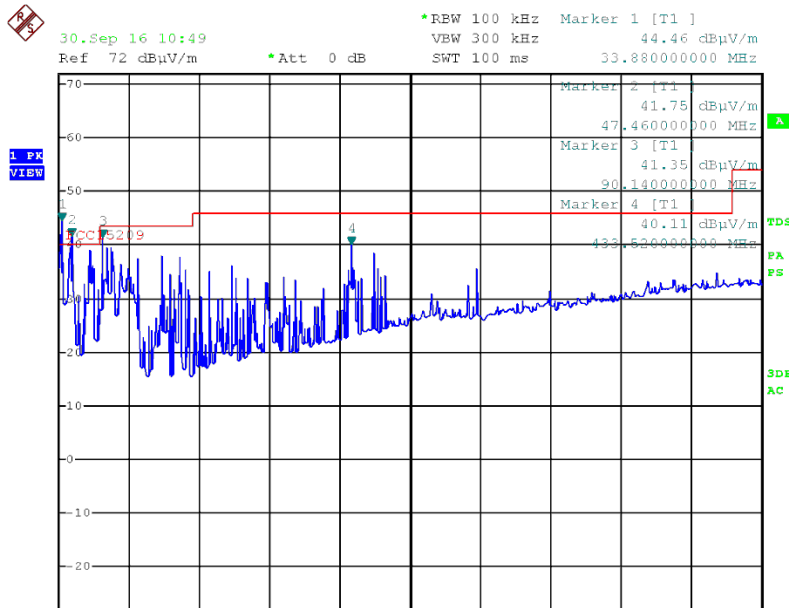

ORI  
 Date: 30.SEP.2016 10:49:58

Plot of the emissions in the frequency range 30 – 1000 MHz  
 (example shown: EUT set at 2480MHz, Peak detector values)

Test Report No.:

**16041502.fcc01**

Page 34 of 45

**Radiated Emissions, 1 - 25GHz, Horizontal and Vertical Antenna Orientations, 2403 MHz.**

Frequency [MHz]	Antenna Orientation	Detector	Bandwidth (MHz)	Level [dBm]	Limit [dBm]	Result
2306	Vertical	Pk	1	-56.6	-21.2	Pass
4801 <sup>H</sup>	Vertical	Pk	1	-51.6	-21.2	Pass
6510	Vertical	Pk	1	-53.2	-41.2 (Av) -21.2 (Pk)	Pass
11512 <sup>*R</sup>	Vertical	Pk	1	-47.5	-41.2 (Av) -21.2 (Pk)	Pass
17691.8 <sup>*R</sup>	Vertical	Pk	1	-40.3	-21.2	Pass
17691.8 <sup>*R</sup>	Vertical	Av	1	-49.3	-41.2	Pass
17822 <sup>*R</sup>	Vertical	Pk	1	-39.6	-21.2 (Pk)	Pass
17822 <sup>*R</sup>	Vertical	Av	1	-46.2	-41.2 (Av)	Pass

**Radiated Emissions, 1 - 25GHz, Horizontal and Vertical Antenna Orientations, 2442 MHz.**

Frequency [MHz]	Antenna Orientation	Detector	Bandwidth (MHz)	Level [dBm]	Limit [dBm]	Result
1370 <sup>*R</sup>	Horizontal	Pk	1	-61.0	-41.2 (Av) -21.2 (Pk)	Pass
4882 <sup>*H</sup>	Vertical	Pk	1	-54.4	-41.2 (Av) -21.2 (Pk)	Pass
8881	Vertical	Pk	1	-53.6	-41.2 (Av) -21.2 (Pk)	Pass
11394 <sup>*R</sup>	Vertical	Pk	1	-48.3	-41.2 (Av) -21.2 (Pk)	Pass
14236	Vertical	Pk	1	-46.6	-41.2 (Av) -21.2 (Pk)	Pass
17709 <sup>*R</sup>	Vertical	Pk	1	-39.8	-21.2 (Pk)	Pass
17709 <sup>*R</sup>	Vertical	Av	1	-46.5	-41.2 (Av)	Pass

Test Report No.:

**16041502.fcc01**

Page 35 of 45

**Radiated Emissions, 1 - 25GHz, Horizontal and Vertical Antenna Orientations, 2480 MHz.**

Frequency [MHz]	Antenna Orientation	Detector	Bandwidth (MHz)	Level [dBm]	Limit [dBm]	Result
4960 <sup>*H</sup>	Vertical	Pk	1	-50.7	-41.2 (Av) -21.2 (Pk)	Pass
6419	Vertical	Pk	1	-54.1	-41.2 (Av) -21.2 (Pk)	Pass
11525 <sup>*R</sup>	Vertical	Pk	1	-48.4	-41.2 (Av) -21.2 (Pk)	Pass
13793	Vertical	Pk	1	-47.1	-41.2 (Av) -21.2 (Pk)	Pass
17952 <sup>*R</sup> (noise)	Vertical	Pk	1	-39.9	-21.2 (Pk)	Pass
17952 <sup>*R</sup> (noise)	Vertical	Av	1	-48.2	-41.2 (Av)	Pass

**Radiated field strength measurements (1 - 25 GHz, E-field), EUT normal operation**

Frequency [MHz]	Antenna Orientation	Detector	Resolution Bandwidth (MHz)	Level [dBm]	Limit [dBm]	Result
1121.4 <sup>*R</sup>	Vertical	Peak	1	-40.8	-21.2	Pass
1121.4 <sup>*R</sup>	Vertical	Average	1	-81.0	-41.2	Pass
1202.2 <sup>*R</sup>	Vertical	Peak	1	-44.6	-41.2 Av -21.2 Pk	Pass
1337 <sup>*R</sup>	Vertical	Peak	1	-38.2	-21.2 Pk	Pass
1337 <sup>*R</sup>	Vertical	Average	1	-81.0	-41.2 Av	Pass
1632	Vertical	Peak	1	-44.0	-41.2 Av -21.2 Pk	Pass
4203.1 <sup>*R</sup>	Vertical	Peak	1	-58.4	-41.2 Av -21.2 Pk	Pass
7338.1 <sup>*R</sup>	Vertical	Peak	1	-52.6	-41.2 Av -21.2 Pk	Pass

- Notes:
- \*R refers to a frequency in a restricted band,
  - \*H refers to a frequency which is a harmonic of the fundamental.
  - Field strength values of radiated emissions not listed in the tables above are more than 20 dB below the applicable limit.
  - Measurement uncertainty is +/- 5.5 dB.
  - a selection of plots is provided on the next pages.

Test Report No.:

**16041502.fcc01**

Page 36 of 45

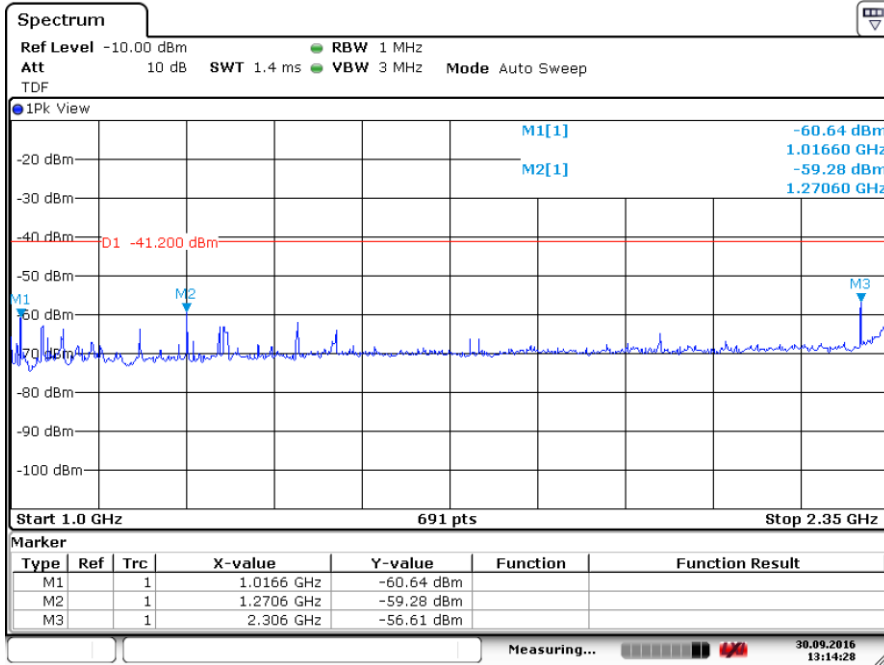

Date: 30.SEP.2016 13:14:29

Plot of the emissions at 2403 MHz, Vertical polarization, Peak values shown

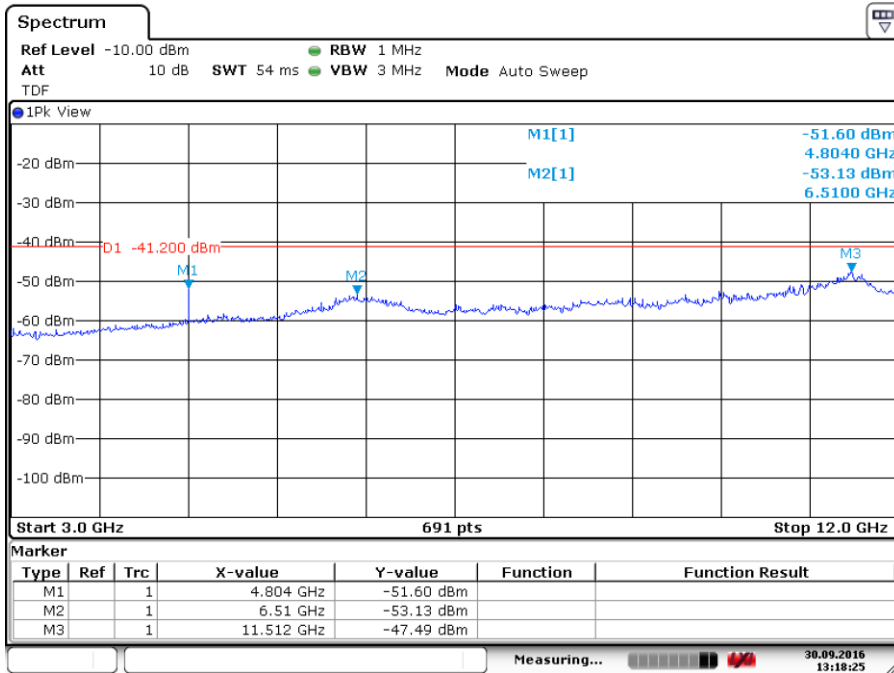

Date: 30.SEP.2016 13:18:25

Plot of the emissions at 2403 MHz, Vertical polarization, Peak values shown

Test Report No.:

**16041502.fcc01**

Page 37 of 45

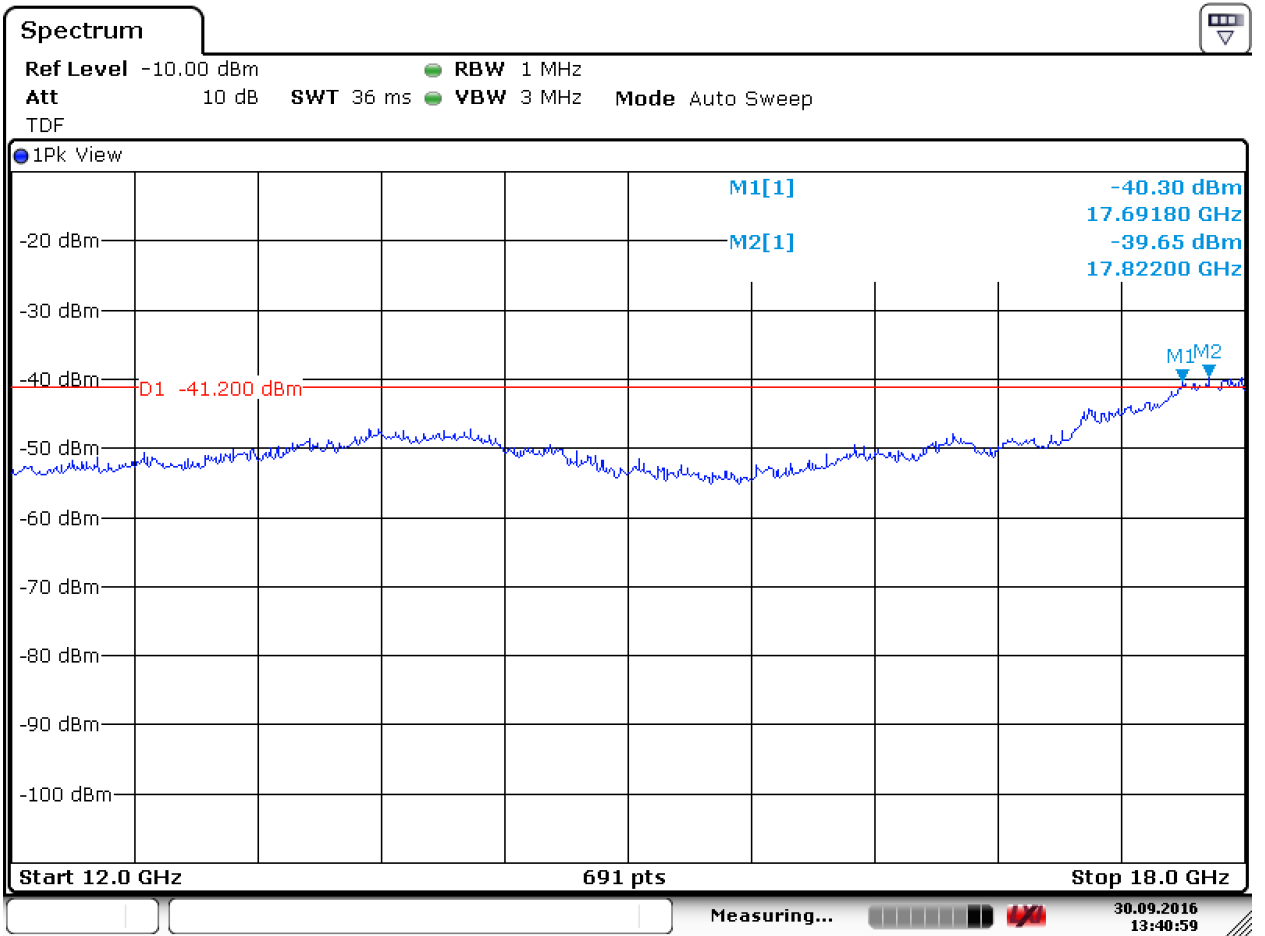

Date: 30.SEP.2016 13:40:59

Plot of the emissions at 2403 MHz, Vertical polarization, Peak values shown

Test Report No.:

**16041502.fcc01**

Page 38 of 45

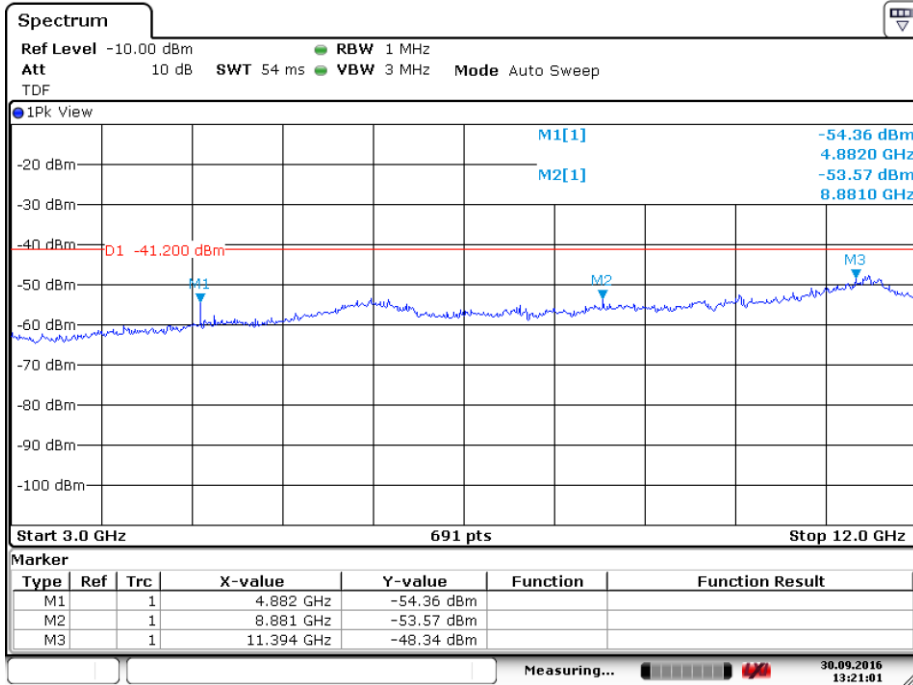

Date: 30.SEP.2016 13:21:01

Plot of the emissions at 2442 MHz, Vertical polarization, Peak values shown

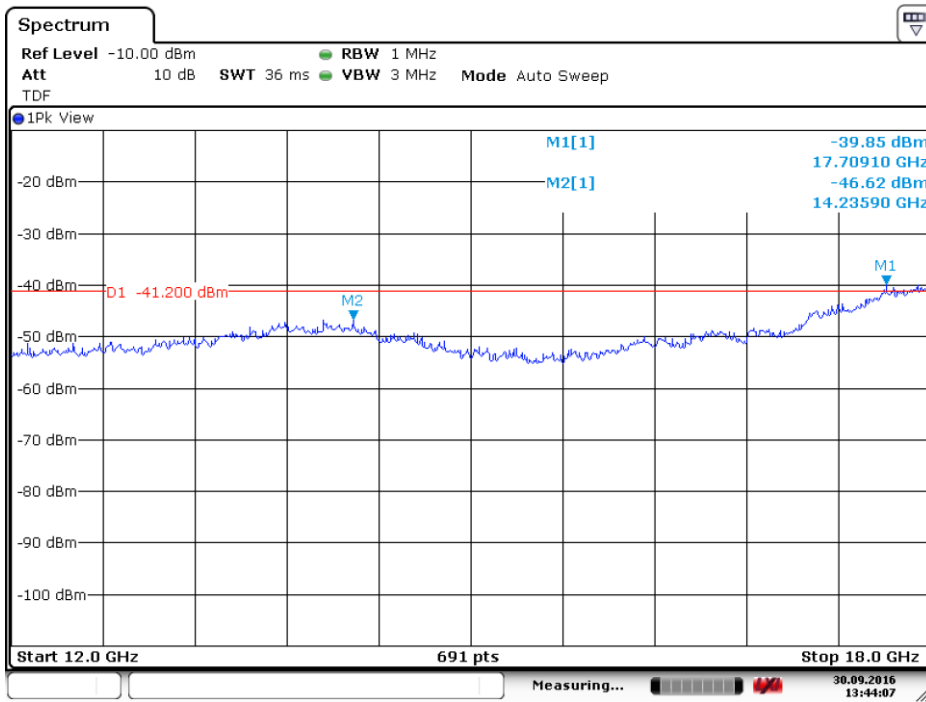

Date: 30.SEP.2016 13:44:07

Plot of the emissions at 2442 MHz, Vertical polarization, Peak values shown

Test Report No.:

**16041502.fcc01**

Page 39 of 45

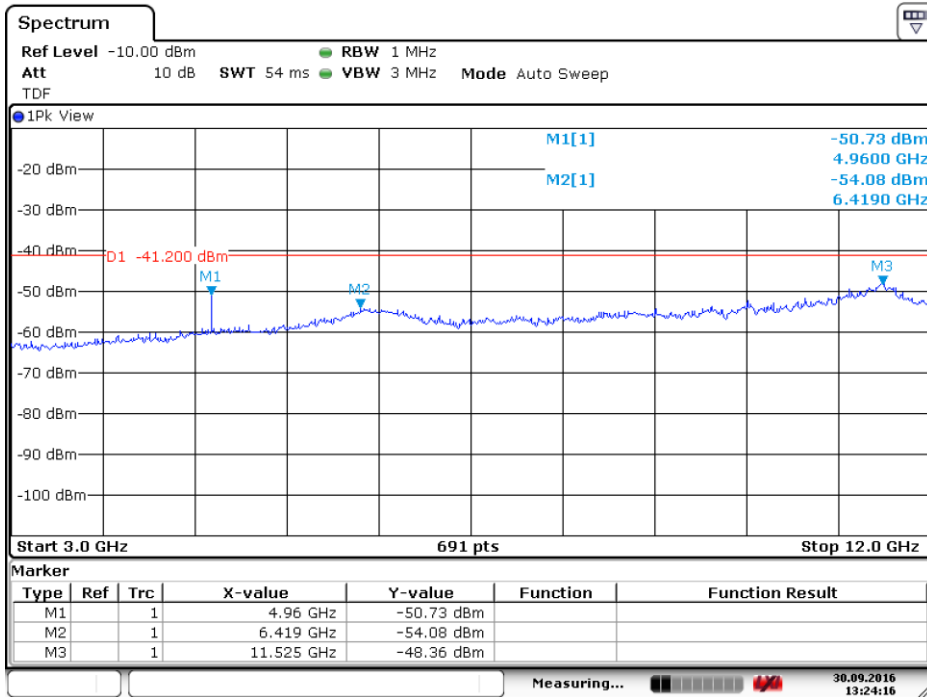

Date: 30.SEP.2016 13:24:16

Plot of the emissions at 2480 MHz, Vertical polarization, Peak values shown

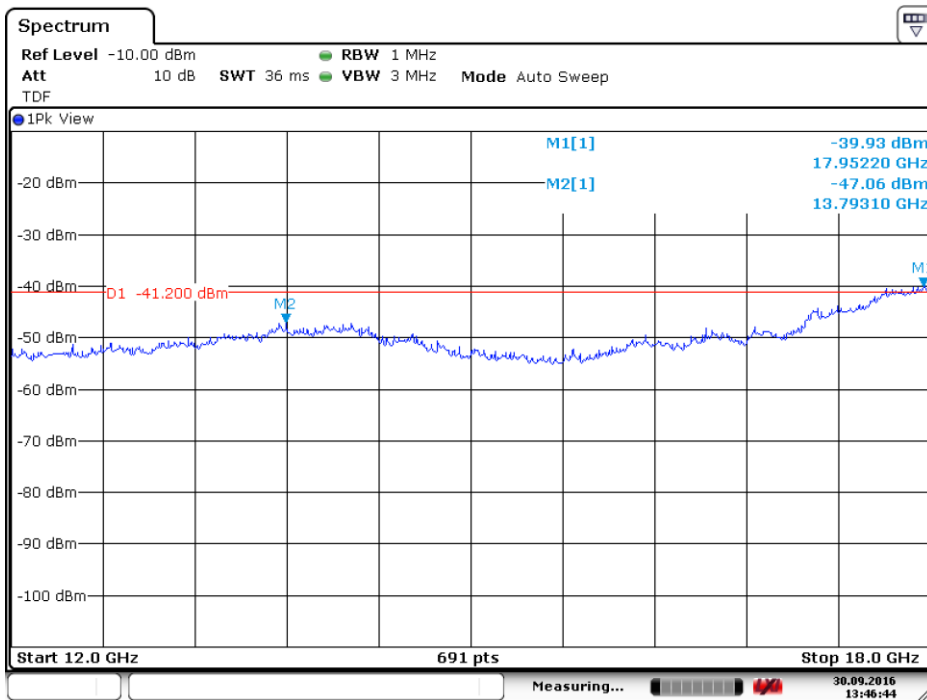

Date: 30.SEP.2016 13:46:44

Plot of the emissions at 2480 MHz, Vertical polarization, Peak values shown

Test Report No.:

**16041502.fcc01**

Page 40 of 45

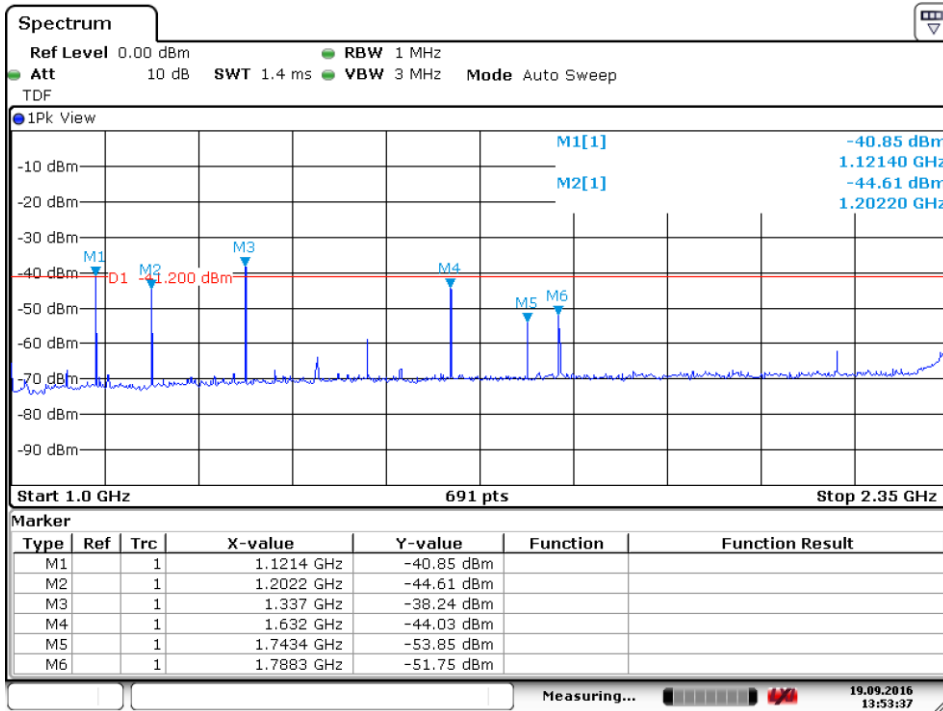

Date: 19.SEP.2016 13:53:37

Plot of the emissions in Normal operation, Vertical polarization, Peak values shown

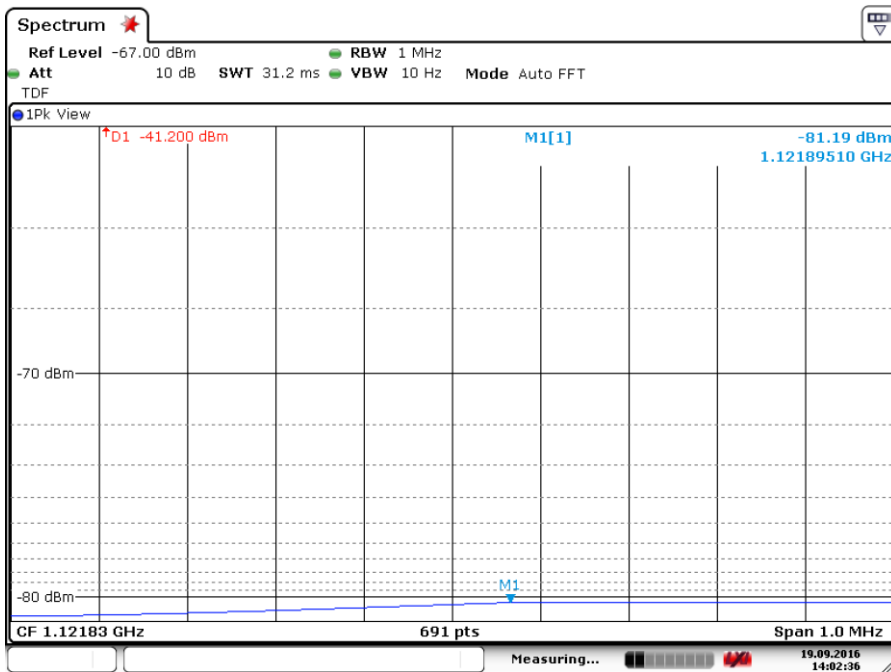

Date: 19.SEP.2016 14:02:36

Plot of the emissions in Normal operation, Average value of the emission at 1214 MHz shown



Test Report No.:

**16041502.fcc01**

Page 41 of 45

## 5.2 AC Power Line Conducted Measurements

**RESULT: Pass.**

Date of testing: 2016-09-22

Requirements: for equipment that is designed to be connected to the public utility (AC) power line, the radio frequency voltage that is conducted back onto the AC power line on any frequency or frequencies within the band 150 kHz to 30 MHz shall not exceed the limits in the following table, as measured using a 50  $\mu$ H/50 ohms line impedance stabilization network (LISN). Compliance with the provisions of this paragraph shall be based on the measurement of the radio frequency voltage between each power line and ground at the power terminal. The lower limit applies at the band edges.

Frequency of Emission (MHz)	Conducted Limit (dB $\mu$ V) Quasi-Peak	Conducted Limit (dB $\mu$ V) Average
0.15 – 0.5	66 to 56*	56 to 46*
0.5 – 5	56	46
5 - 30	46	50

\*Decreases with the logarithm of the frequency.

Test procedure:

ANSI C63.10-2013.

Each phase and neutral of the AC power line were measured with respect to ground. Measurements were performed using a 50  $\mu$ H / 50  $\Omega$  LISN. The frequency range from 150kHz to 30MHz was searched. The six highest EUT emissions relative to the limit were noted. The EUT is considered a floor-standing device. The EUT is placed on a non-conductive plate of 5mm thick above the ground plane, so to isolate it from the ground plane because the EUT normally does not make electrical contact with a ground plane. The EUT was positioned at least 80cm from the LISN. The power cable was routed over the non-conductive plate to the LISN.

Test Report No.:

**16041502.fcc01**

Page 42 of 45

**5.2.1 AC Power Line Conducted Emission of Transmitter**

Frequency (MHz)	Measurement results (dBµV) L1		Measurement results (dBµV) L2/Neutral		Limits (dBµV)		Verdict (Pass/Fail)
	QP	AV	QP	AV	QP	AV	
0.150	55.2	27.0	54.9	28.2	66.0	56.0	Pass
0.160	53.5	25.0	53.5	24.3	65.5	55.5	Pass
0.170	52.5	22.0	52.3	22.0	65.0	55.0	Pass
0.180	51.2	21.8	51.0	21.6	64.5	54.5	Pass
0.190	49.0	24.0	49.4	26.6	64.0	54.0	Pass
0.200	48.0	17.4	47.9	17.0	63.6	53.6	Pass

The results of the AC power line conducted emission tests, carried out in accordance with 47 CFR Part 15 section 15.207(a) and RSS-Gen section 8.8, at the 120 Volts/ 60 Hz AC mains connection terminals of the EUT, are depicted in the table above.

Notes:

1. The resolution bandwidth used was 9 kHz.
2. Pre-test proved that the transmitting frequency of the ANT was not of influence on the results. BLE was not operational. Worst case values noted.
3. Measurement uncertainty is +/- 3.6 dB.
4. Plots are provided on the next pages.

### 5.2.2 Plots of the AC Power-line Conducted Emissions

22. Sep 16 09:27

Scan Settings (1 Range)  
:----- Frequencies -----: Receiver Settings :-----:  
Start Stop Step IF BW Detector M-Time Atten Preamp  
150k 30M 5k 9k PK 100ms 0dBLN OFF

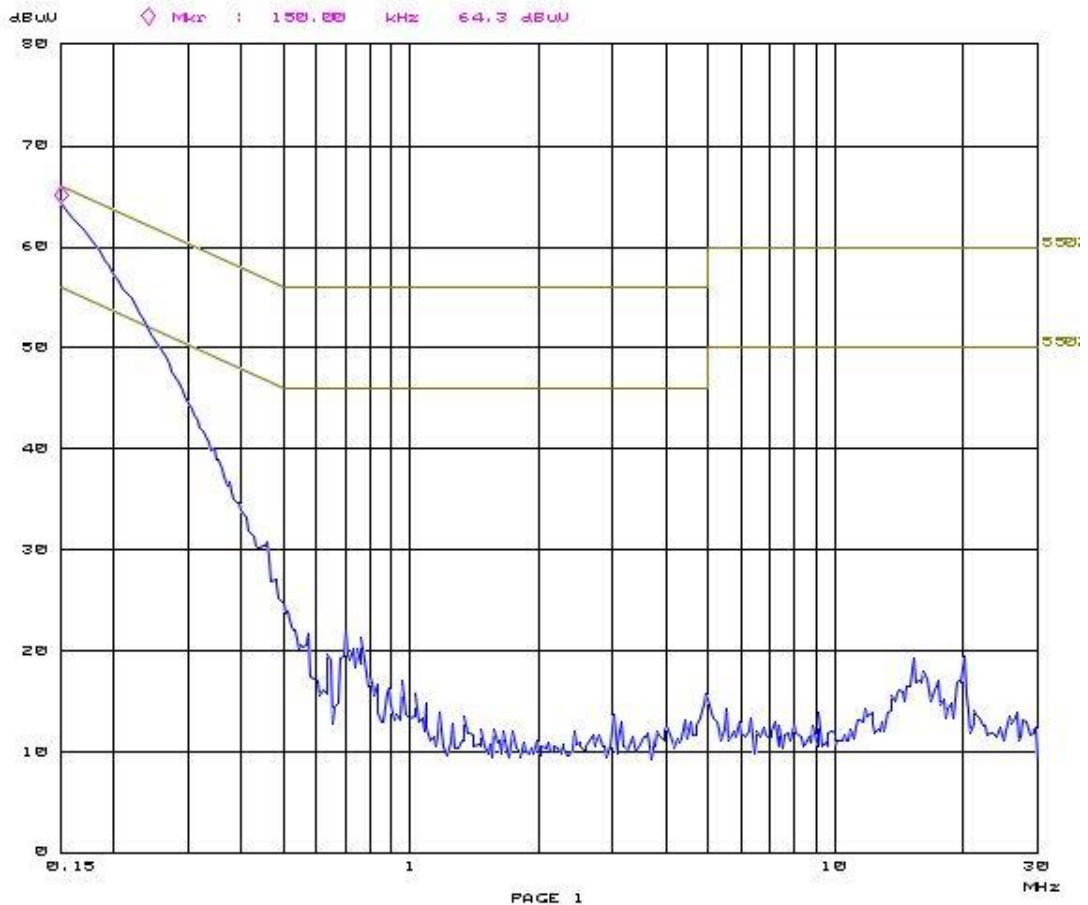

Plot of the AC Power-line Conducted emissions on L1

Test Report No.:

**16041502.fcc01**

Page 44 of 45

22. Sep 16 09:42

Scan Settings (1 Range)  
:----- Frequencies -----: Receiver Settings -----:  
Start Stop Step IF BW Detector M-Time Atten Preamp  
150k 30M 5k 9k PK 20ms 0dBLN OFF

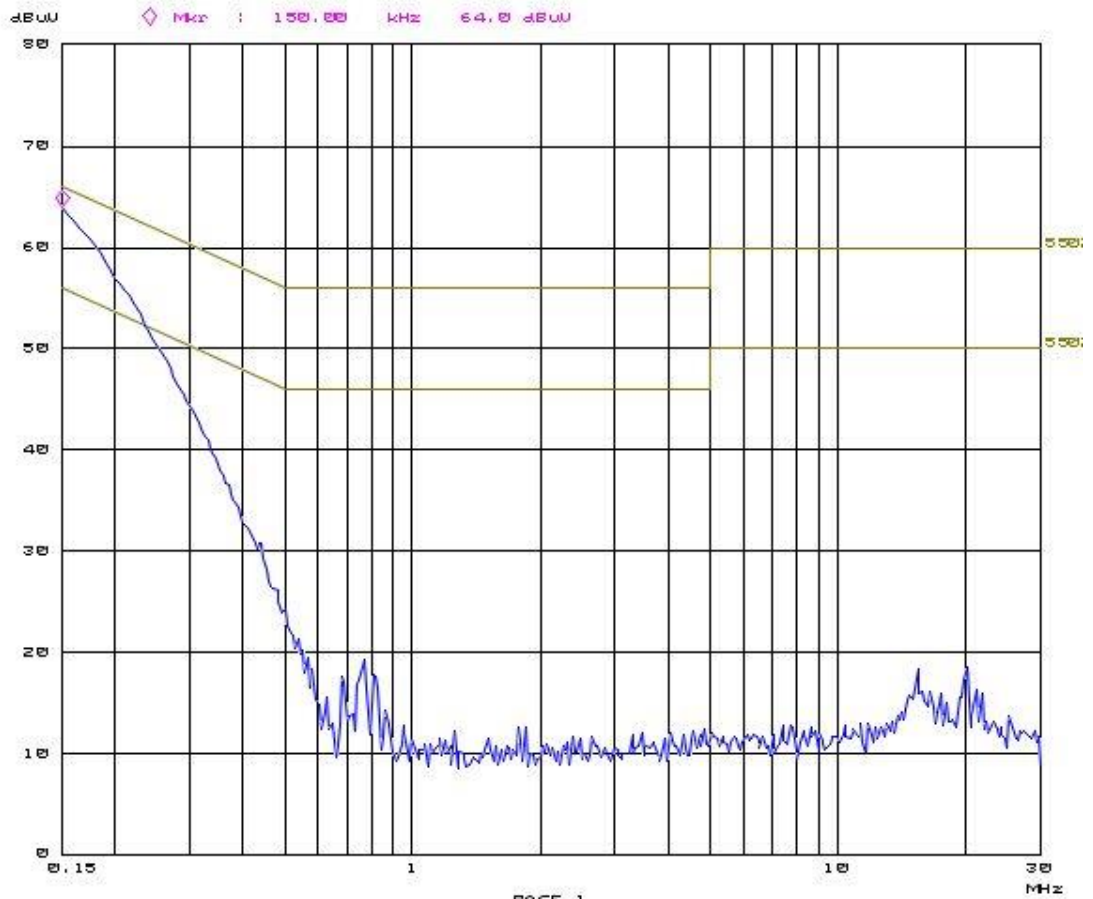

Plot of the AC Power-line Conducted emissions on L2

*Test Report No.:*

**16041502.fcc01**

*Page 45 of 45*

**End of report**