

FCC TEST REPORT  
for  
Shenzhen Newidea Technology Co., Limited

Wireless Mouse  
Model No.: Rockstick2, SK-RFG71

Prepared for : Shenzhen Newidea Technology Co., Limited  
Address : Blg 31, Cuigang Industrial Zone 5, Huaide Road, Fuyong Town,  
Bao' an District, Shenzhen, China

Prepared By : Shenzhen Anbotek Compliance Laboratory Limited  
Address : 1/F., Building 1, SEC Industrial Park, No.0409 Qianhai Road,  
Nanshan District, Shenzhen, Guangdong, China  
Tel: (86) 755-26066544  
Fax: (86) 755-26014772

Report Number : R0116051040I  
Date of Test : May 30~Jun. 15, 2016  
Date of Report : Jun. 16, 2016

## TABLE OF CONTENTS

Description

Page

Test Report

<b>1. GENERAL INFORMATION.....</b>	<b>4</b>
1.1. Description of Device (EUT).....	4
1.2. Auxiliary Equipment Used during Test.....	5
1.3. Description of Test Facility.....	5
1.4. Measurement Uncertainty.....	5
<b>2. TEST METHODOLOGY.....</b>	<b>6</b>
2.1. Summary of Test Results.....	6
2.2. Description of Test Modes.....	6
<b>3. TEST PROCEDURE.....</b>	<b>7</b>
<b>4. RADIATION INTERFERENCE.....</b>	<b>8</b>
4.1. Requirements (15.249, 15.209):.....	8
4.2. Test Procedure.....	8
4.3 Test Configuration.....	8
4.4 Test Equipment.....	10
4.5. Test Results.....	10
<b>5. BANDEGE.....</b>	<b>19</b>
5.1. Requirements (15.249):.....	19
5.2. Test Procedure.....	19
5.3. Test Configuration:.....	19
5.4. Test Results.....	20
<b>6. OCCUPIED BANDWIDTH.....</b>	<b>29</b>
6.1. Requirements :.....	29
6.2. Test SET-UP.....	29
6.3 Test Equipment.....	29
6.4. Test Results.....	29
<b>7. ANTENNA APPLICATION.....</b>	<b>32</b>
7.1. Antenna requirement.....	32
7.2. Result.....	32
<b>8. PHOTOGRAPH.....</b>	<b>33</b>
8.1. Photo of Radiation Emission Test.....	33
<b>APPENDIX II (INTERNAL PHOTOS).....</b>	<b>38</b>

## TEST REPORT

Applicant : Shenzhen Newidea Technology Co., Limited  
Manufacturer : Shenzhen Newidea Technology Co., Limited  
EUT : Wireless Mouse  
Model No. : Rockstick2, SK-RFG71  
Serial No. : N.A.  
Trade Mark : Trust  
Rating : DC 3V

Measurement Procedure Used:

FCC Part15 Subpart C, Paragraph 15.207, 15.249 & 15.209

The device described above is tested by Shenzhen Anbotek Compliance Laboratory Limited to determine the maximum emission levels emanating from the device and the severe levels of the device can endure and its performance criterion. The measurement results are contained in this test report and Shenzhen Anbotek Compliance Laboratory Limited is assumed full of responsibility for the accuracy and completeness of these measurements. Also, this report shows that the EUT (Equipment Under Test) is technically compliant with the FCC Part 15 Subpart C requirements.

This report applies to above tested sample only and shall not be reproduced in part without written approval of Shenzhen Anbotek Compliance Laboratory Limited.

Date of Test : May 30~Jun. 15, 2016

Prepared by : Kebo Zhang  
(Tested Engineer / Kebo Zhang)

Reviewer : Dolly Mo  
(Project Manager / Dolly Mo)

Approved & Authorized Signer : Tom Chen  
(Manager / Tom Chen)

## 1. GENERAL INFORMATION

### 1.1. Description of Device (EUT)

EUT : Wireless Mouse

Model Number : Rockstick2, SK-RFG71  
(Note: All samples are the same except the model number and colour, so we prepare "Rockstick2" for test only.)

Test Power Supply : DC 3V

Frequency : 2403~2477MHz

No. of Channels : 16 Channels

Channel	Frequency (MHz)	Channel	Frequency (MHz)
1	2403	9	2442
2	2407	10	2447
3	2412	11	2452
4	2417	12	2457
5	2422	13	2462
6	2427	14	2467
7	2432	15	2472
8	2437	16	2477

Antenna Specification : PCB Antenna: -1 dBi

Applicant Address : Shenzhen Newidea Technology Co., Limited  
Blg 31, Cuigang Industrial Zone 5, Huaide Road, Fuyong Town, Bao' an District, Shenzhen, China

Manufacturer Address : Shenzhen Newidea Technology Co., Limited  
Blg 31, Cuigang Industrial Zone 5, Huaide Road, Fuyong Town, Bao' an District, Shenzhen, China

Factory Address : Shenzhen Newidea Technology Co., Limited  
Blg 31, Cuigang Industrial Zone 5, Huaide Road, Fuyong Town, Bao' an District, Shenzhen, China

Date of receipt : May 30, 2016

Date of Test : May 30~Jun. 15, 2016

## 1.2. Auxiliary Equipment Used during Test

N/A

## 1.3. Description of Test Facility

The test facility is recognized, certified, or accredited by the following organizations:

### **FCC-Registration No.: 752021**

Shenzhen Anbotek Compliance Laboratory Limited, EMC Laboratory has been registered and fully described in a report filed with the (FCC) Federal Communications Commission. The acceptance letter from the FCC is maintained in our files. Registration 752021, July 10, 2013.

### **IC-Registration No.: 8058A-1**

Shenzhen Anbotek Compliance Laboratory Limited., EMC Laboratory has been registered and fully described in a report filed with the (IC) Industry Canada. The acceptance letter from the IC is maintained in our files. Registration 8058A-1, June 13, 2016.

### **Test Location**

All Emissions tests were performed at  
Shenzhen Anbotek Compliance Laboratory Limited. at 1/F., Building 1, SEC Industrial Park, No.0409 Qianhai Road, Nanshan District, Shenzhen, Guangdong, China

## 1.4. Measurement Uncertainty

Radiation Uncertainty	:	Ur = 4.1 dB (Horizontal) Ur = 4.3 dB (Vertical)
Conduction Uncertainty	:	Uc = 3.4dB

## 2. TEST METHODOLOGY

The tests documented in this report were performed in accordance with ANSI C63.10: 2013 and FCC Part 15, Paragraph 15.249.

### 2.1. Summary of Test Results

The EUT has been tested according to the following specifications:

Standard	Test Type	Result	Notes
§15.207 (a)	Conducted Emission	-	N/A
§15.205	Restricted Band of Operation	PASS	Complies
§15.209 §15.249(a)	Radiated Emission	PASS	Complies
§15.215(c)	20dB Bandwidth Test	PASS	Complies
§15.203	Antenna Requirement	PASS	Complies

Note: This product is low voltage products. It is using the battery as a power source.

### 2.2. Description of Test Modes

The EUT has been tested under operating condition.

Manual control the EUT for staying in continuous transmitting mode.

Channel Low(2403MHz), Channel Middle(2442MHz) and Channel High(2477MHz) are chosen for the final testing.

### 3. Test Procedure

**GENERAL:** This report shall NOT be reproduced except in full without the written approval of Shenzhen Anbotek Compliance Laboratory Limited. The EUT was transmitting a test signal during the testing.

**RADIATION INTERFERENCE:** The test procedure used was ANSI STANDARD C63.10-2013 using a spectrum analyzer with a pre-selector. The analyzer was calibrated in dB above a microvolt at the output of the antenna. The resolution bandwidth was 100KHz and the video bandwidth was 300KHz up to 1.0GHz and 1.0MHz with a video BW of 3.0MHz above 1.0GHz. The ambient temperature of the EUT was 74.3oF with a humidity of 69%.

**FORMULA OF CONVERSION FACTORS:** The Field Strength at 3m was established by adding the meter reading of the spectrum analyzer (which is set to read in units of dBuV) to the antenna correction factor supplied by the antenna manufacturer. The antenna correction factors are stated in terms of dB. The gain of the Preselector was accounted for in the Spectrum Analyzer Meter Reading.

**Example:**

Freq (MHz) METER READING + ACF = FS  
20 dBuV + 10.36 dB = 30.36 dBuV/m @ 3m

**ANSI STANDARD C63.10-2013 10.1.7 MEASUREMENT PROCEDURES:** The EUT was placed on a table 80 cm high and with dimensions of 1m by 1.5m. The EUT was placed in the center of the table (1.5m side). The table used for radiated measurements is capable of continuous rotation.

When an emission was found, the table was rotated to produce the maximum signal strength. At this point, the antenna was raised and lowered from 1m to 4m. The antenna was placed in both the horizontal and vertical planes.

## 4. Radiation Interference

### 4.1. Requirements (15.249, 15.209):

FIELD STRENGTH of Fundamental: @3M 902-928 MHZ 2.4-2.4835 GHz 94 dB $\mu$ V/m @3m	FIELD STRENGTH of Harmonics 54 dB $\mu$ V/m @3m	S15.209 30 - 88 MHz 88 - 216 MHz 216 - 960 MHz ABOVE 960 MHz	40 dBuV/m 43.5 46 54dBuV/m
--	---	--	-------------------------------------

Emissions radiated outside of the specified frequency bands, except for harmonics, shall be attenuated by at least 50 dB below the level of the fundamental or to the general radiated emission limits in 15.209, whichever is the lesser attenuation.

### 4.2. Test Procedure

For below 1GHz, the EUT is placed on a turn table which is 0.8 meter high above the ground. For above 1GHz, the EUT is placed on a turn table which is 1.5 meter high above the ground. The turn table can rotate 360 degrees to determine the position of the maximum emission level. The EUT is set 3 meters away from the receiving antenna which is mounted on a antenna tower. The antenna can be moved up and down from 1 to 4 meters to find out the maximum emission level. Both horizontal and vertical polarization of the antenna are set on test.

All readings from 9kHz to 150kHz are quasi-peak values with a resolution bandwidth of 200Hz. All readings from 150MHz to 30MHz are quasi-peak values with a resolution bandwidth of 9KHz. All readings from 30MHz to 1GHz are quasi-peak values with a resolution bandwidth of 120kHz. All reading are above 1GHz, peak & average values with a resolution bandwidth of 1MHz. The EUT is tested in 9\*6\*6 Chamber. The device is evaluated in xyz orientation. The test results are listed in Section 4.5.

### 4.3 Test Configuration

#### 4.3.1. 9k to 30MHz emissions:

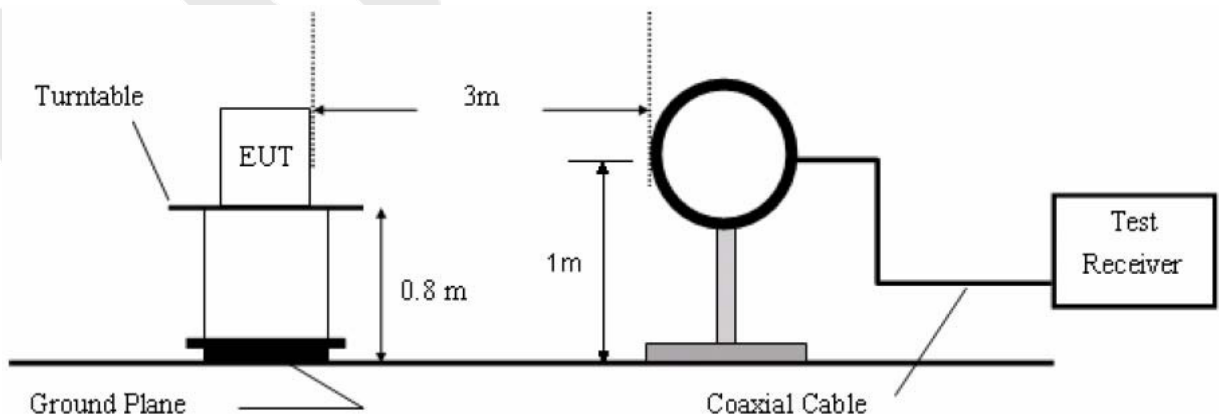



4.3.2. 30M to 1G emissions:

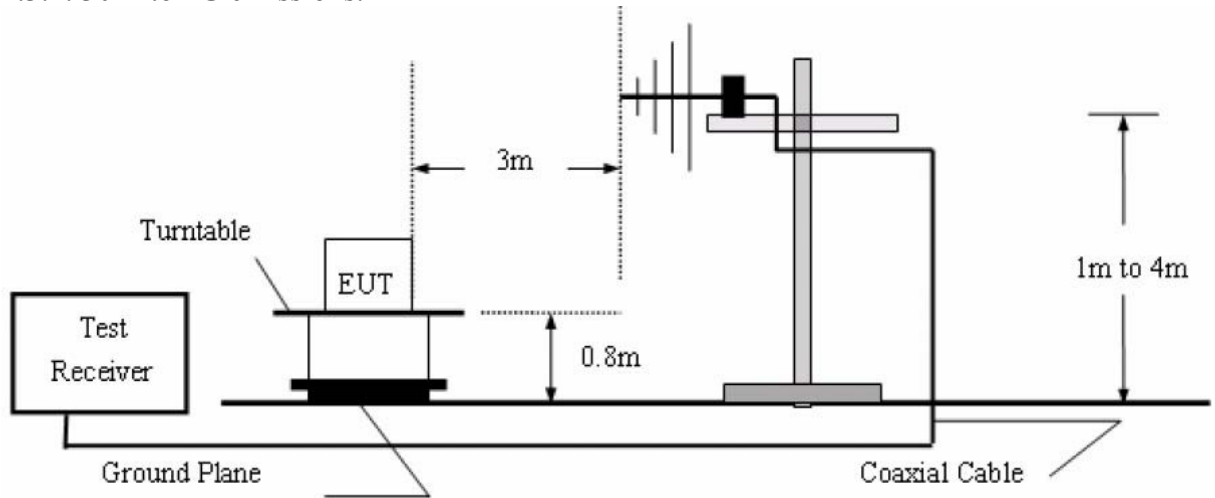

4.3.3. 1G to 40G emissions:

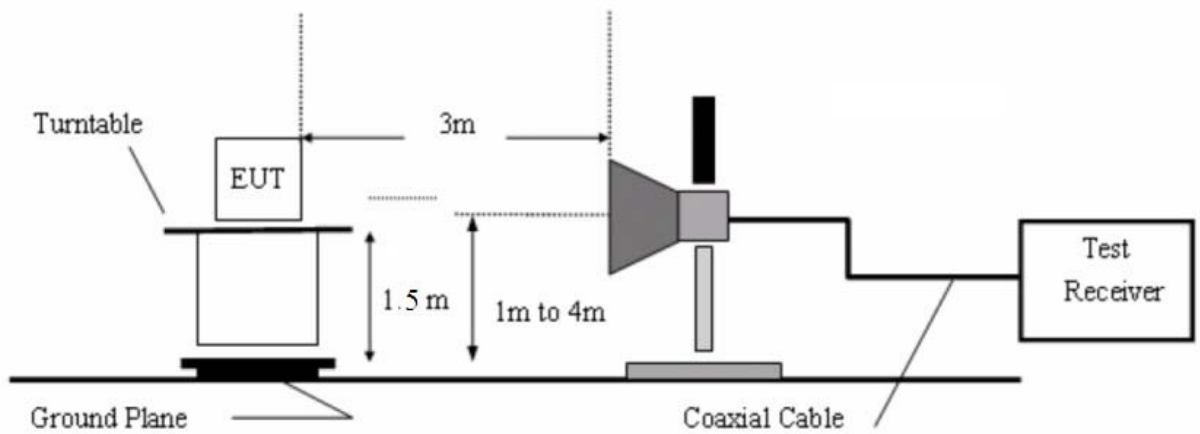

#### 4.4 Test Equipment

Item	Equipment	Manufacturer	Model No.	Serial No.	Last Cal.	Cal. Interval
1.	Spectrum Analysis	Agilent	E4407B	US39390582	Apr. 17, 2016	1 Year
2.	Preamplifier	Instruments corporation	EMC011830	980100	Apr. 17, 2016	1 Year
3.	EMI Test Receiver	Rohde & Schwarz	ESPI	101604	Apr. 17, 2016	1 Year
4.	Double Ridged Horn Antenna	Instruments corporation	GTH-0118	351600	Apr. 20, 2016	1 Year
5.	Bilog Broadband Antenna	Schwarzbeck	VULB9163	VULB 9163-289	Apr. 20, 2016	1 Year
6.	Pre-amplifier	SONOMA	310N	186860	Apr. 17, 2016	1 Year
7.	EMI Test Software EZ-EMC	SHURPLE	N/A	N/A	N/A	N/A
8	Power Sensor	DAER	RPR3006W	15I00041SN046	Jun 30, 2015	1 Year
9	MXA Spectrum Analysis	Agilent	N9020A	MY51170037	Jun 30, 2015	1 Year
10	MXG RF Vector Signal Generator	Agilent	N5182A	MY48180656	Jun 30, 2015	1 Year
11	Signal Generator	Agilent	E4421B	MY41000743	Jun 30, 2015	1 Year
12	DC Power supply	IV	IV-8080	YQSB0096	Jun 30, 2015	1 Year
13	TEMP&HUMI PROGRAMMABLE CHAMBER	Bell Group	BE-THK-150M8	SE-0137	Mar 16, 2016	1 Year
14.	Active Loop Antenna	SCHWARZBECK	FMZB1519	1519-037	May 19, 2016	1 Year

#### 4.5. Test Results

PASS.

Please refer the following pages. Only the worst case (x orientation).

Below 30MHz reading of emission are attenuated more than 20dB below the permissible limits, so the results do not record in the report

**Below 1GHz:**

<b>Job No.:</b>	<b>0116051040I</b>	<b>Polazriation:</b>	<b>Horizontal</b>
<b>Standard:</b>	<b>(RE)FCC PART15 C _3m</b>	<b>Power Source:</b>	<b>DC 3V</b>
<b>Test item:</b>	<b>Radiation Test</b>	<b>Temp.(C)/Hum.(%RH):</b>	<b>24.3( C)/55%RH</b>
<b>Mode:</b>	<b>Keeping TX mode</b>	<b>Distance:</b>	<b>3m</b>
<b>Note:</b>	<b>30-1000MHz</b>		

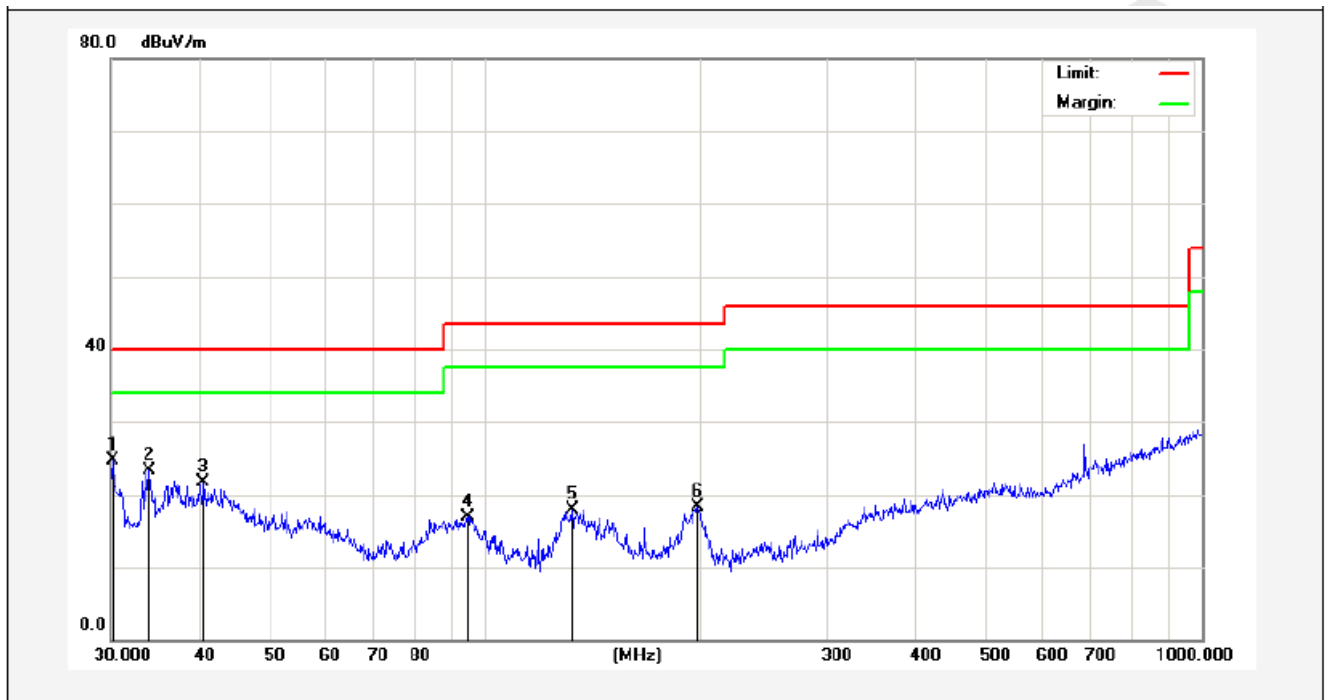

No.	Freq. (MHz)	Reading (dBuV/m)	Factor (dB/m)	Result (dBuV/m)	Limit (dBuV/)	Over Limit (dB)	Detector	Height (cm)	degree (deg)	Remark
1	30.2111	41.51	-16.84	24.67	40.00	-15.33	peak			
2	33.9174	38.24	-14.86	23.38	40.00	-16.62	peak			
3	40.4172	32.14	-10.53	21.61	40.00	-18.39	peak			
4	94.4284	38.19	-21.22	16.97	43.50	-26.53	peak			
5	132.2206	40.78	-22.96	17.82	43.50	-25.68	peak			
6	197.8928	39.24	-20.88	18.36	43.50	-25.14	peak			

Job No.:	0116051040I	Polarziation:	Vertical
Standard:	(RE)FCC PART15 C_3m	Power Source:	DC 3V
Test item:	Radiation Test	Temp.(C)/Hum.(%RH):	24.3( C)/55%RH
Mode:	Keeping TX mode	Distance:	3m
Note:	30-1000MHz		

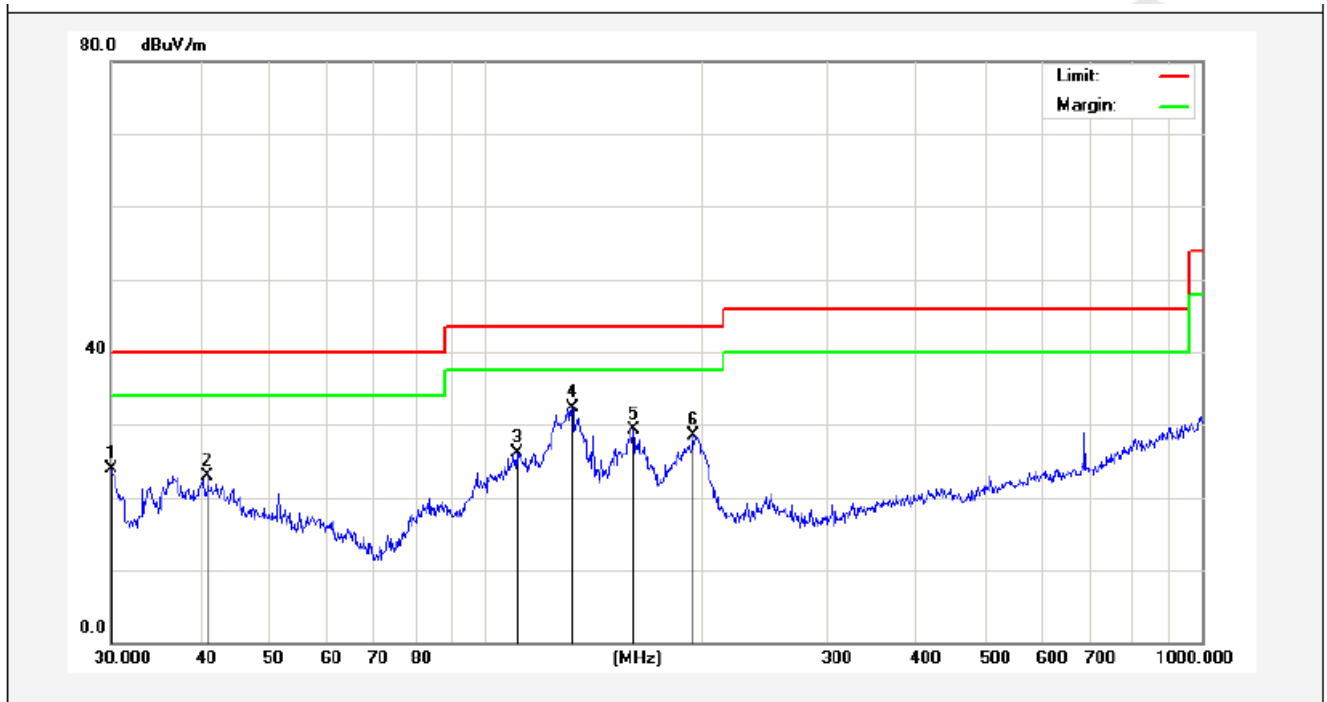

No.	Freq. (MHz)	Reading (dBuV/m)	Factor (dB/m)	Result (dBuV/m)	Limit (dBuV/)	Over Limit (dB)	Detector	Height (cm)	degree (deg)	Remark
1	30.0000	40.86	-16.95	23.91	40.00	-16.09	peak			
2	40.9881	33.64	-10.77	22.87	40.00	-17.13	peak			
3	110.5687	41.71	-15.66	26.05	43.50	-17.45	peak			
4	132.2205	50.24	-17.96	32.28	43.50	-11.22	peak			
5	160.9088	47.22	-17.84	29.38	43.50	-14.12	peak			
6	195.1365	44.48	-15.89	28.59	43.50	-14.91	peak			

**Above 1 GHz:**

<b>Job No.:</b>	<b>0116051040I</b>	<b>Polarization:</b>	<b>Horizontal</b>
<b>Standard:</b>	<b>(RE)FCC PART15 C _3m</b>	<b>Power Source:</b>	<b>DC 3V</b>
<b>Test item:</b>	<b>Radiation Test</b>	<b>Temp.(C)/Hum.(%RH):</b>	<b>24.3( C)/55%RH</b>
<b>Note:</b>	<b>2403MHz</b>	<b>Distance:</b>	<b>3m</b>

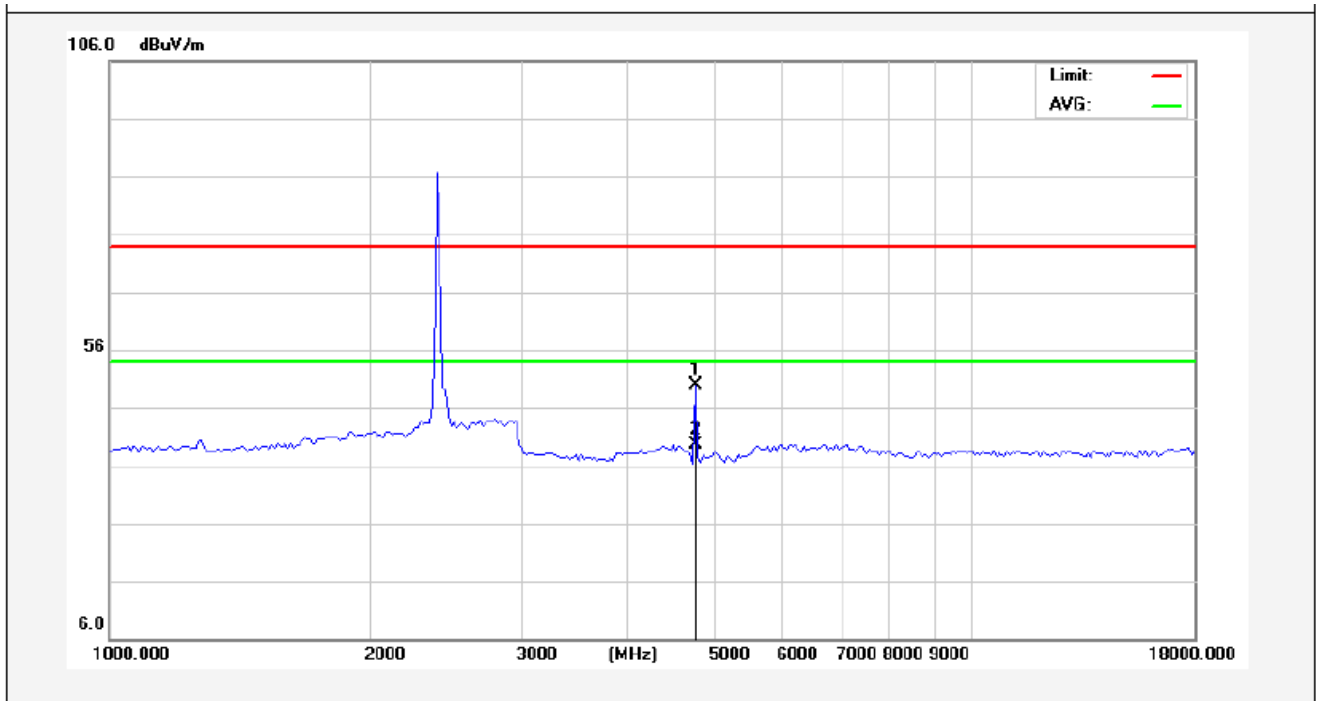

No.	Freq. (MHz)	Reading (dBuV/m)	Factor (dB/m)	Result (dBuV/m)	Limit (dBuV/)	Over Limit (dB)	Detector	Height (cm)	degree (deg)	Remark
1	4806.500	46.65	3.26	49.91	74.00	-24.09	peak			
2	4806.500	36.35	3.26	39.61	54.00	-14.39	AVG			



<b>Job No.:</b>	<b>0116051040I</b>	<b>Polarization:</b>	<b>Vertical</b>
<b>Standard:</b>	<b>(RE)FCC PART15 C _3m</b>	<b>Power Source:</b>	<b>DC 3V</b>
<b>Test item:</b>	<b>Radiation Test</b>	<b>Temp.(C)/Hum.(%RH):</b>	<b>24.3( C)/55%RH</b>
<b>Note:</b>	<b>2403MHz</b>	<b>Distance:</b>	<b>3m</b>

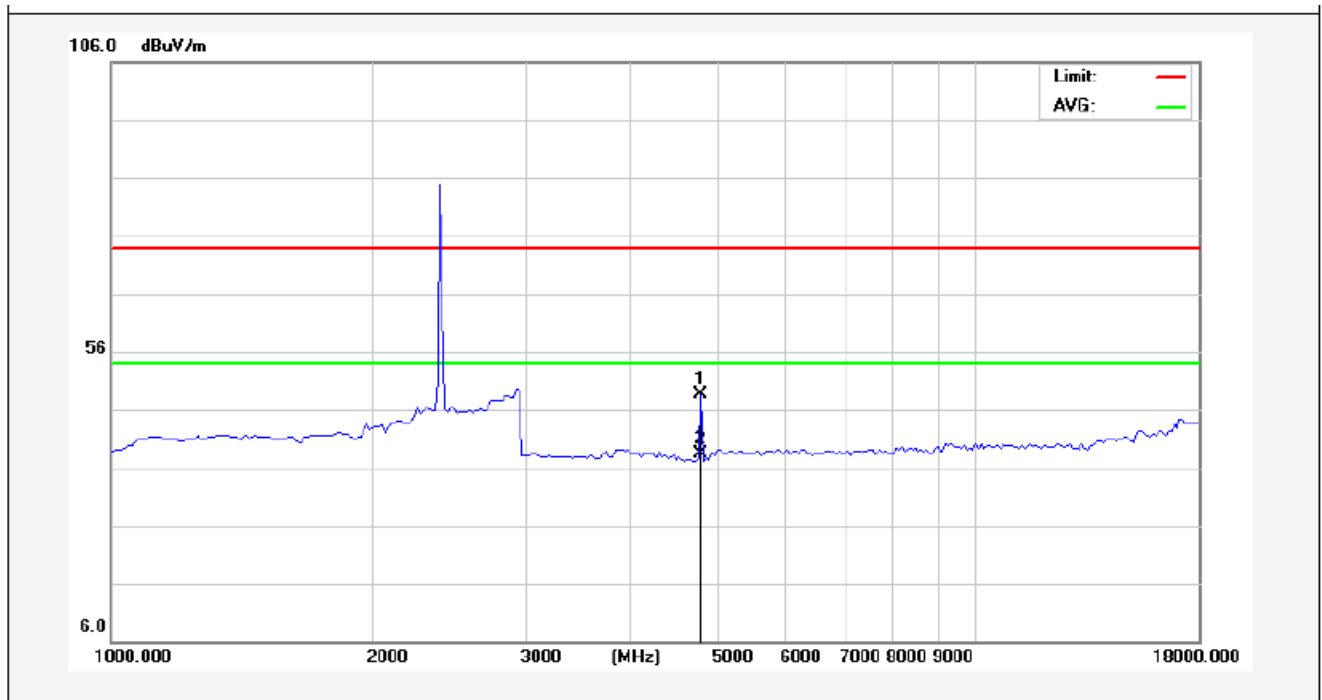

No.	Freq. (MHz)	Reading (dBuV/m)	Factor (dB/m)	Result (dBuV/m)	Limit (dBuV/)	Over Limit (dB)	Detector	Height (cm)	degree (deg)	Remark
1	4806.000	45.23	3.34	48.57	74.00	-25.43	peak			
2	4806.000	35.14	3.34	38.48	54.00	-15.52	AVG			

AAMA

Job No.:	0116051040I	Polarization:	Horizontal
Standard:	(RE)FCC PART15 C_3m	Power Source:	DC 3V
Test item:	Radiation Test	Temp.(C)/Hum.(%RH):	24.3( C)/55% RH
Note:	2442MHz	Distance:	3m

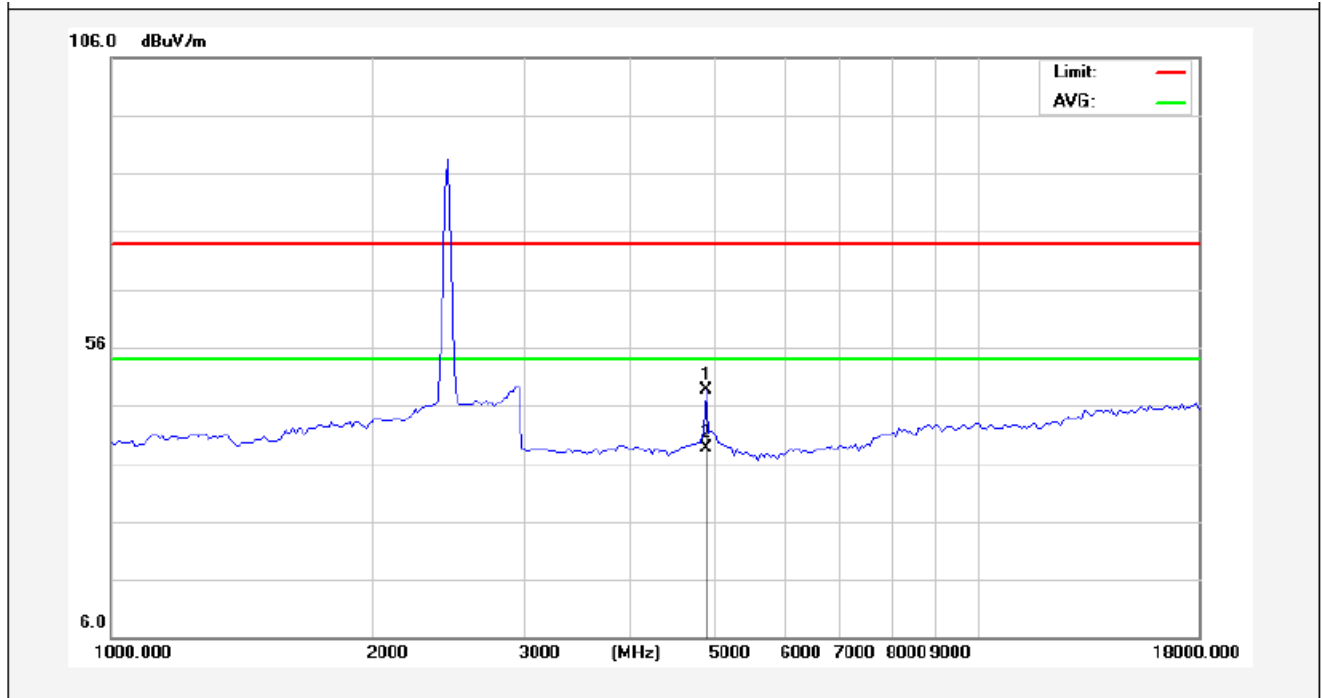

No.	Freq. (MHz)	Reading (dBuV/m)	Factor (dB/m)	Result (dBuV/m)	Limit (dBuV/)	Over Limit (dB)	Detector	Height (cm)	degree (deg)	Remark
1	4884.500	45.12	3.41	48.53	74.00	-25.47	peak			
2	4884.500	35.33	3.41	38.74	54.00	-15.26	AVG			

<b>Job No.:</b>	<b>0116051040I</b>	<b>Polarization:</b>	<b>Vertical</b>
<b>Standard:</b>	<b>(RE)FCC PART15 C _3m</b>	<b>Power Source:</b>	<b>DC 3V</b>
<b>Test item:</b>	<b>Radiation Test</b>	<b>Temp.(C)/Hum.(%RH):</b>	<b>24.3( C)/55% RH</b>
<b>Note:</b>	<b>2442MHz</b>	<b>Distance:</b>	<b>3m</b>

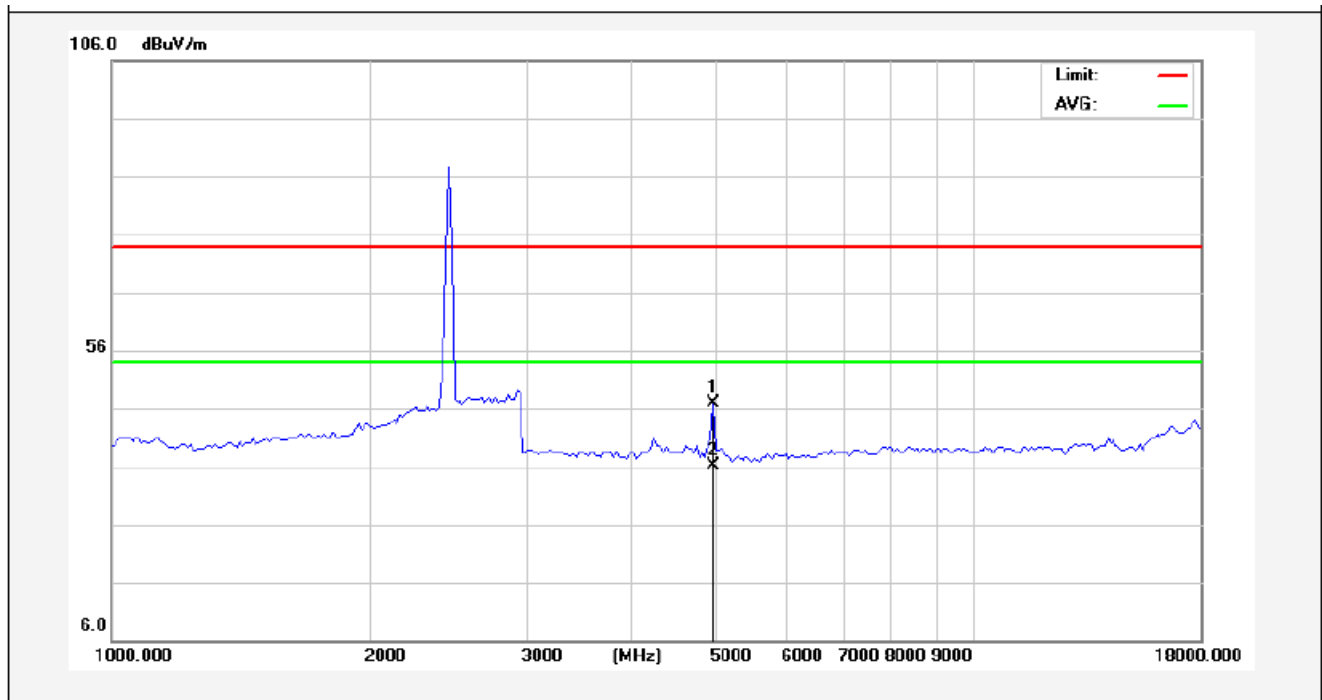

No.	Freq. (MHz)	Reading (dBuV/m)	Factor (dB/m)	Result (dBuV/m)	Limit (dBuV/)	Over Limit (dB)	Detector	Height (cm)	degree (deg)	Remark
1	4884.500	43.26	3.57	46.83	74.00	-27.17	peak			
2	4884.500	32.57	3.57	36.14	54.00	-17.86	AVG			

AAMA



<b>Job No.:</b>	<b>0116051040I</b>	<b>Polarization:</b>	<b>Horizontal</b>
<b>Standard:</b>	<b>(RE)FCC PART15 C_3m</b>	<b>Power Source:</b>	<b>DC 3V</b>
<b>Test item:</b>	<b>Radiation Test</b>	<b>Temp.(C)/Hum.(%RH):</b>	<b>24.3( C)/55% RH</b>
<b>Note:</b>	<b>2477MHz</b>	<b>Distance:</b>	<b>3m</b>

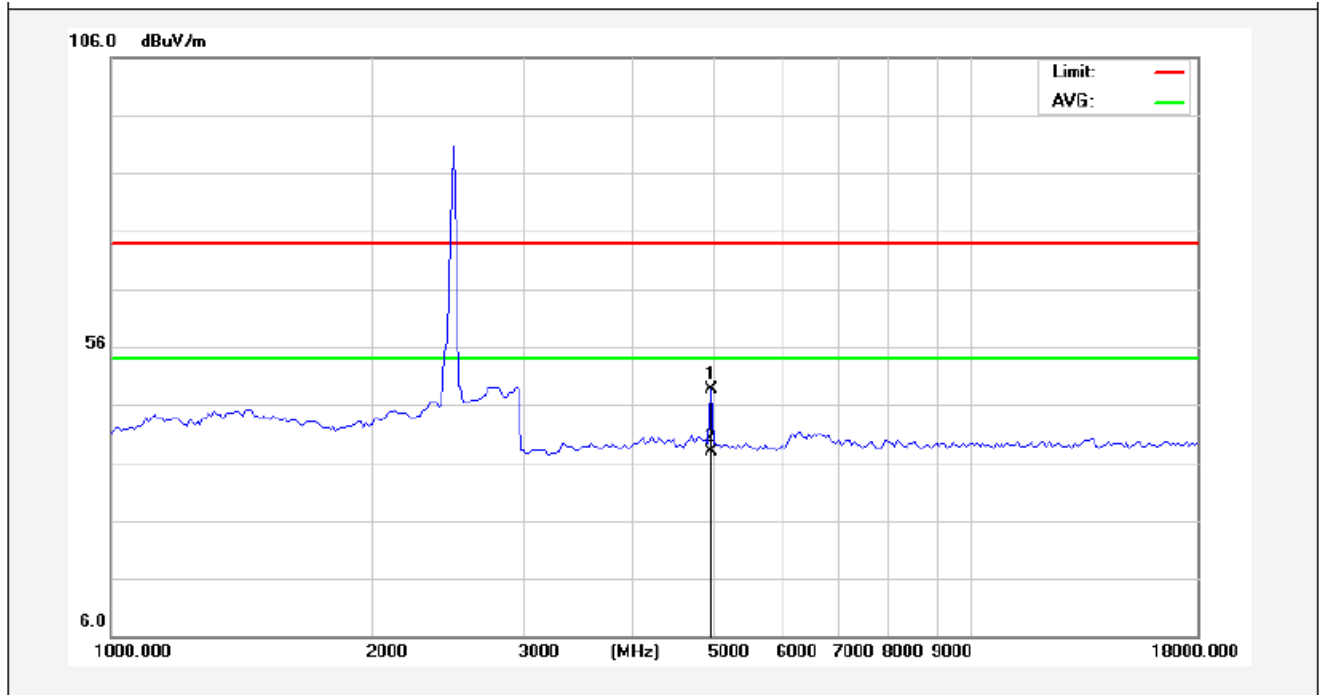

No.	Freq. (MHz)	Reading (dBuV/m)	Factor (dB/m)	Result (dBuV/m)	Limit (dBuV/)	Over Limit (dB)	Detector	Height (cm)	degree (deg)	Remark
1	4954.500	45.13	3.57	48.70	74.00	-25.30	peak			
2	4954.500	34.43	3.57	38.00	54.00	-16.00	AVG			

AAMA

Job No.:	0116051040I	Polarization:	Vertical
Standard:	(RE)FCC PART15 C _3m	Power Source:	DC 3V
Test item:	Radiation Test	Temp.(C)/Hum.(%RH):	24.3( C)/55%RH
Note:	2477MHz	Distance:	3m

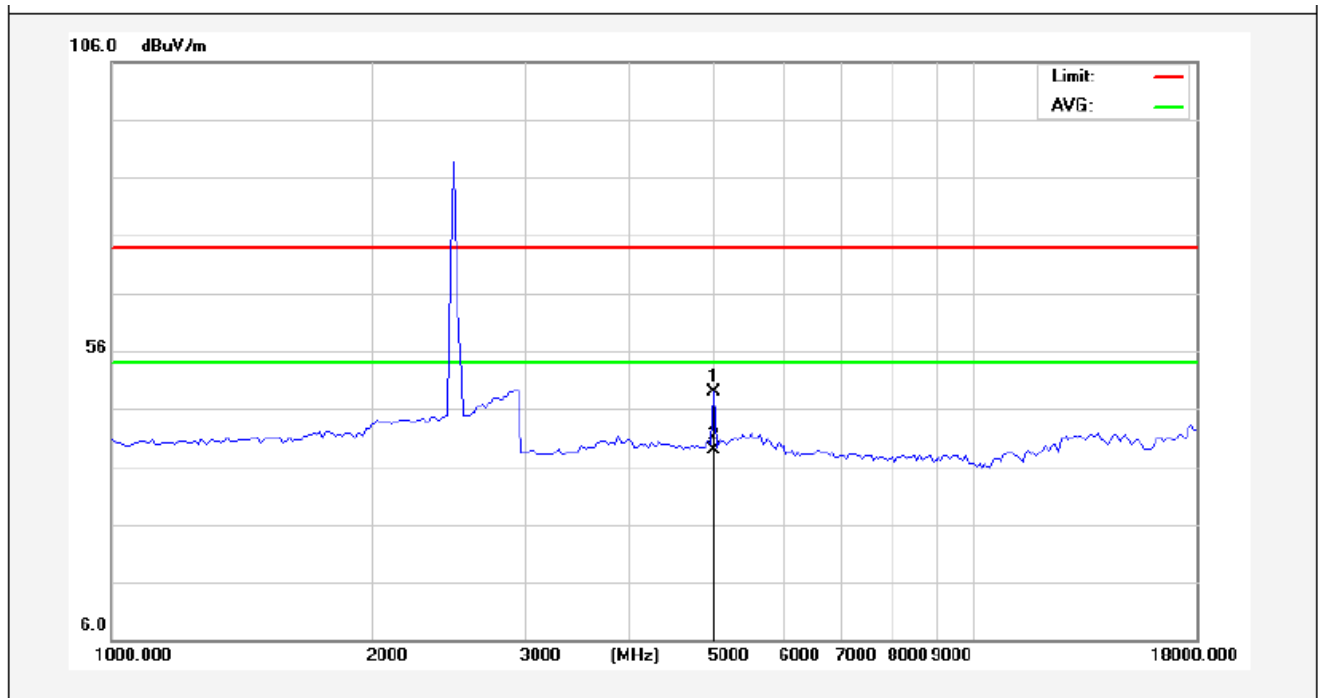

No.	Freq. (MHz)	Reading (dBuV/m)	Factor (dB/m)	Result (dBuV/m)	Limit (dBuV/)	Over Limit (dB)	Detector	Height (cm)	degree (deg)	Remark
1	4954.000	45.17	3.64	48.81	74.00	-25.19	peak			
2	4954.000	35.13	3.64	38.77	54.00	-15.23	AVG			

**NOTE: “ --- ” in the table above means the reading of emissions are attenuated more than 20dB below the permissible limits or the field strength is too small to be measured. The results of different modulations are the same.**

## 5. Bandedge

### 5.1. Requirements (15.249):

The field strength of any emissions appearing outside the band edges and up to 10 kHz above and below the band edges shall be attenuated at least 50 dB below the level of the carrier or to the general limits of 15.249.

### 5.2. Test Procedure

The EUT is placed on a turn table which is 1.5 meter high above the ground. The turn table can rotate 360 degrees to determine the position of the maximum emission level. The EUT is set 3 meters away from the receiving antenna which is mounted on a antenna tower. The antenna can be moved up and down from 1 to 4 meters to find out the maximum emission level. Both horizontal and vertical polarization of the antenna are set on test. The device is evaluated in xyz orientation.

#### Test Equipment

Same as the equipment listed in 5.3.

### 5.3. Test Configuration:

30M to 1G emissions:

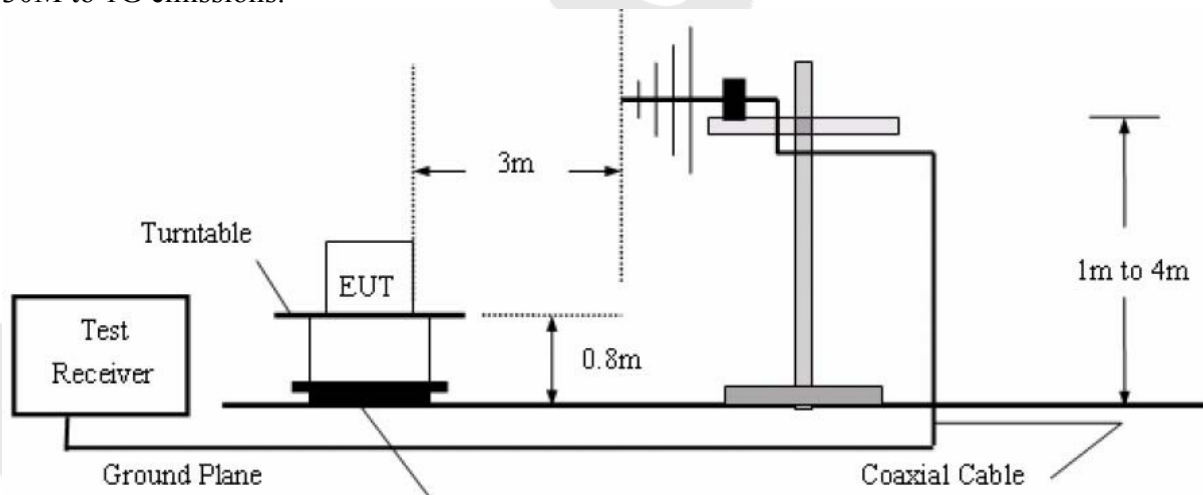

1G to 40G emissions:

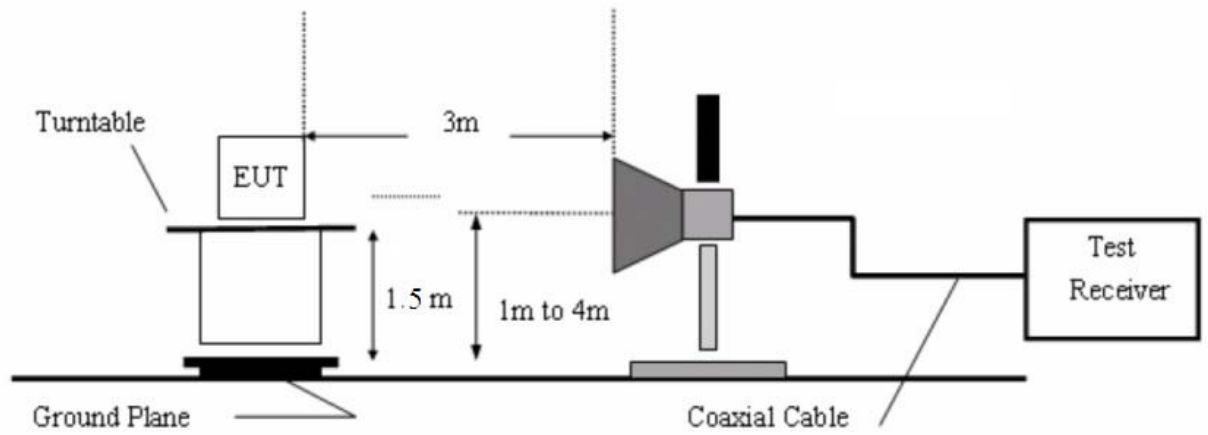

#### 5.4. Test Results

Pass.

Please refer the following plot. Only the worst case (x orientation).

Anbotek

Job No.:	0116051040I	Polarization:	Horizontal
Standard:	(RE)FCC PART15 C _3m	Power Source:	DC 3V
Test item:	Radiation Test	Temp.(C)/Hum.(%RH):	24.3( C)/55% RH
Note:	PEAK	Distance:	3m

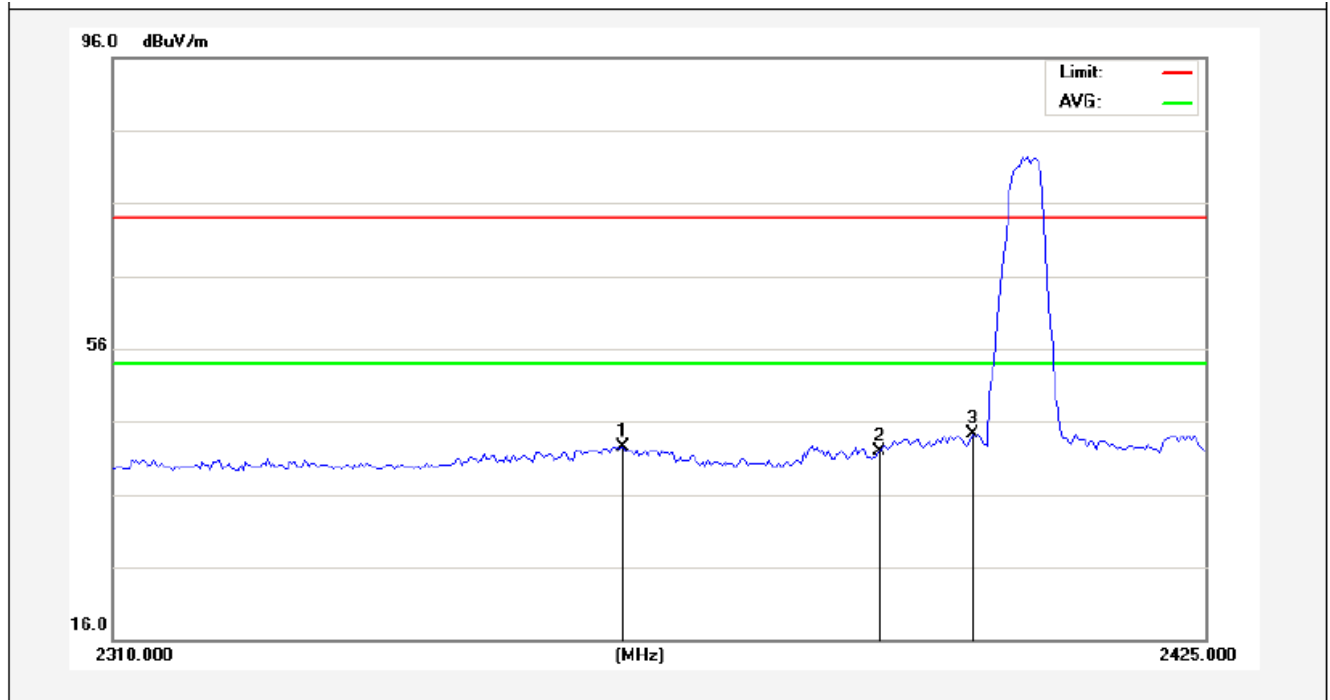

No.	Freq. (MHz)	Reading (dBuV/m)	Factor (dB/m)	Result (dBuV/m)	Limit (dBuV/)	Over Limit (dB)	Detector	Height (cm)	degree (deg)	Remark
1	2363.188	44.98	-2.57	42.41	74.00	-31.59	peak			
2	2390.000	44.40	-2.51	41.89	74.00	-32.11	peak			
3	2400.000	46.71	-2.49	44.22	74.00	-29.78	peak			

AAMA

Job No.:	01160510401	Polarization:	Vertical
Standard:	(RE)FCC PART15 C _3m	Power Source:	DC 3V
Test item:	Radiation Test	Temp.(C)/Hum.(%RH):	24.3( C)/55%RH
Note:	PEAK	Distance:	3m

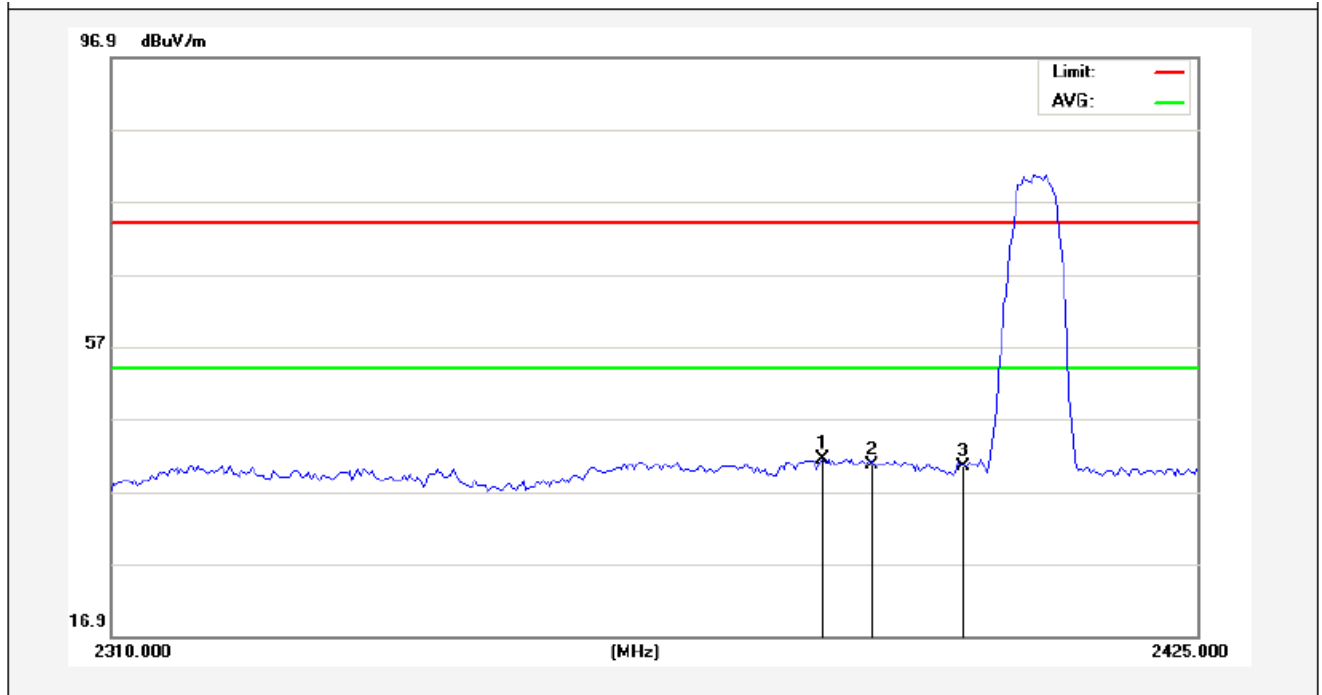

No.	Freq. (MHz)	Reading (dBuV/m)	Factor (dB/m)	Result (dBuV/m)	Limit (dBuV/)	Over Limit (dB)	Detector	Height (cm)	degree (deg)	Remark
1	2384.750	43.84	-2.53	41.31	74.00	-32.69	peak			
2	2390.000	43.11	-2.51	40.60	74.00	-33.40	peak			
3	2400.000	42.84	-2.49	40.35	74.00	-33.65	peak			

Job No.:	0116051040I	Polarization:	Horizontal
Standard:	(RE)FCC PART15 C _3m	Power Source:	DC 3V
Test item:	Radiation Test	Temp.(C)/Hum.(%RH):	24.3( C)/55% RH
Note:	AV	Distance:	3m

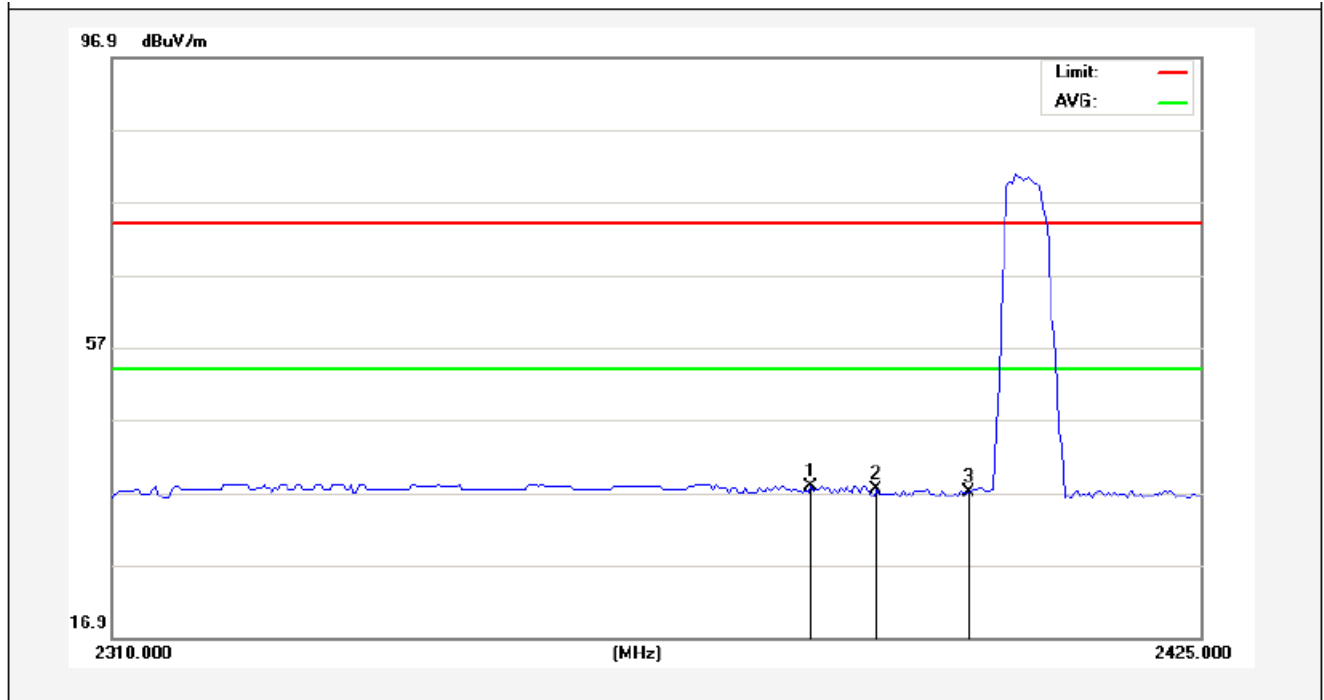

No.	Freq. (MHz)	Reading (dBuV/m)	Factor (dB/m)	Result (dBuV/m)	Limit (dBuV/)	Over Limit (dB)	Detector	Height (cm)	degree (deg)	Remark
1	2383.313	40.38	-2.53	37.85	54.00	-16.15	AVG			
2	2390.000	39.91	-2.51	37.40	54.00	-16.60	AVG			
3	2400.000	39.42	-2.49	36.93	54.00	-17.07	AVG			



Job No.:	0116051040I	Polarization:	Vertical
Standard:	(RE)FCC PART15 C_3m	Power Source:	DC 3V
Test item:	Radiation Test	Temp.(C)/Hum.(%RH):	24.3( C)/55% RH
Note:	AV	Distance:	3m

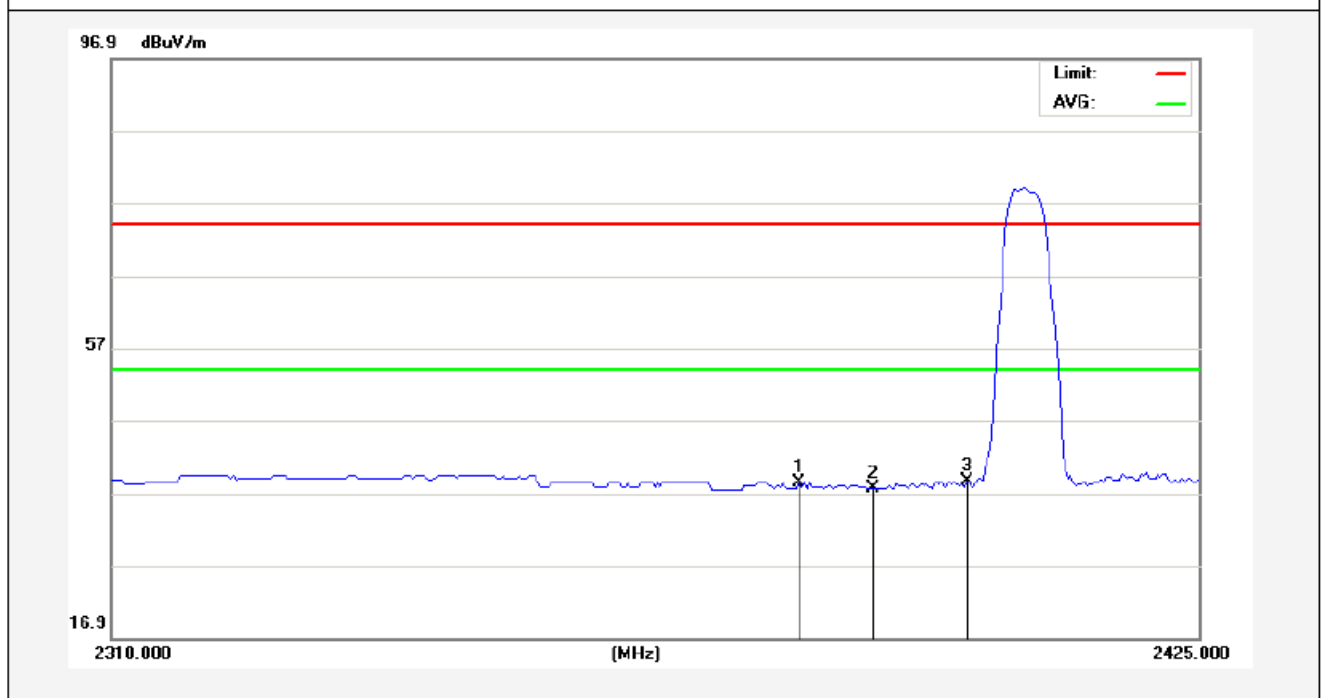

No.	Freq. (MHz)	Reading (dBuV/m)	Factor (dB/m)	Result (dBuV/m)	Limit (dBuV/)	Over Limit (dB)	Detector	Height (cm)	degree (deg)	Remark
1	2382.162	41.03	-2.53	38.50	54.00	-15.50	AVG			
2	2390.000	40.13	-2.51	37.62	54.00	-16.38	AVG			
3	2400.000	41.04	-2.49	38.55	54.00	-15.45	AVG			



Job No.:	0116051040I	Polarization:	Horizontal
Standard:	(RE)FCC PART15 C_3m	Power Source:	DC 3V
Test item:	Radiation Test	Temp.(C)/Hum.(%RH):	24.3( C)/55% RH
Note:	PEAK	Distance:	3m

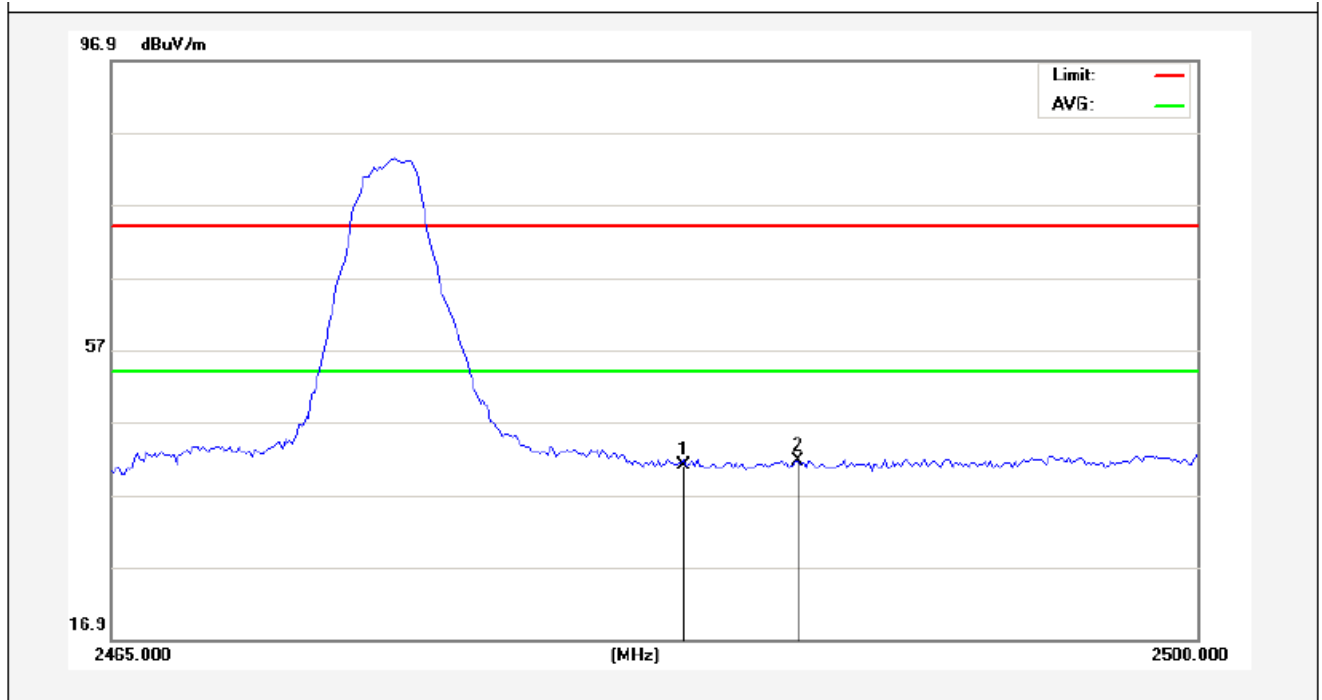

No.	Freq. (MHz)	Reading (dBuV/m)	Factor (dB/m)	Result (dBuV/m)	Limit (dBuV/)	Over Limit (dB)	Detector	Height (cm)	degree (deg)	Remark
1	2483.500	43.38	-2.31	41.07	74.00	-32.93	peak			
2	2487.137	43.93	-2.30	41.63	74.00	-32.37	peak			

AAMA

Job No.:	0116051040I	Polarization:	Vertical
Standard:	(RE)FCC PART15 C _3m	Power Source:	DC 3V
Test item:	Radiation Test	Temp.(C)/Hum.(%RH):	24.3( C)/55%RH
Note:	PEAK	Distance:	3m

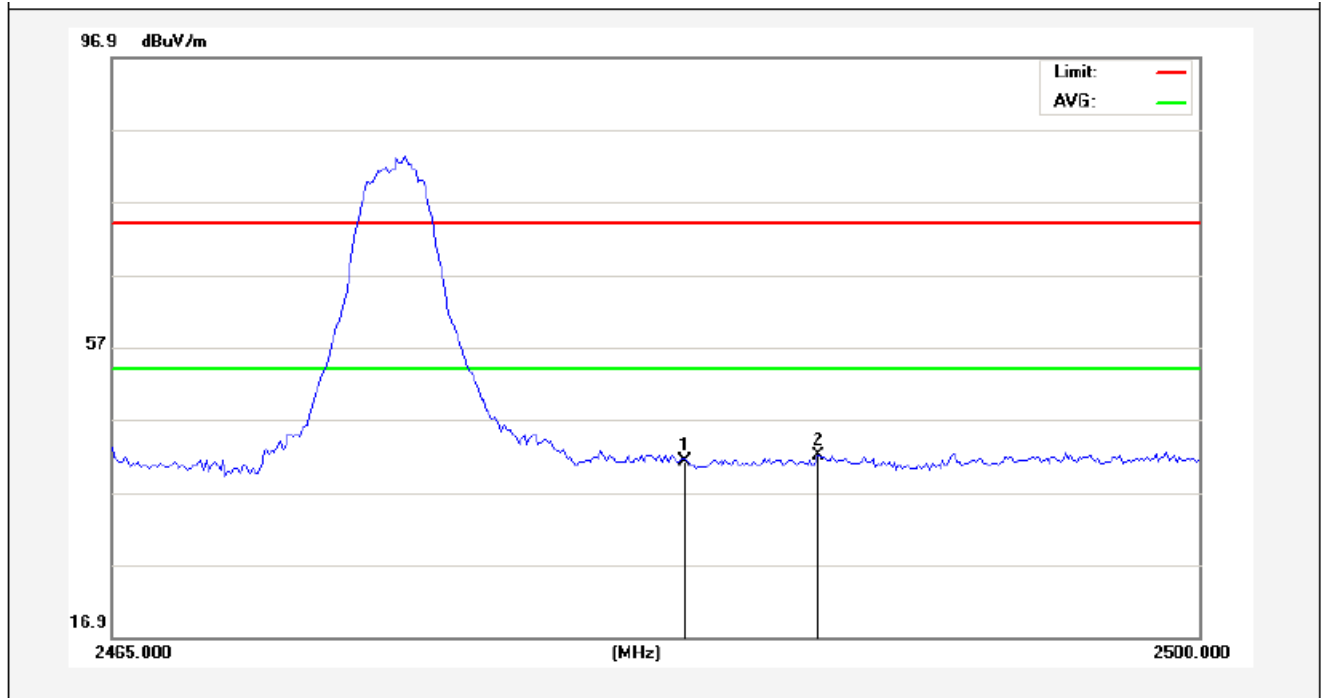

No.	Freq. (MHz)	Reading (dBuV/m)	Factor (dB/m)	Result (dBuV/m)	Limit (dBuV/)	Over Limit (dB)	Detector	Height (cm)	degree (deg)	Remark
1	2483.500	43.52	-2.31	41.21	74.00	-32.79	peak			
2	2487.750	44.36	-2.30	42.06	74.00	-31.94	peak			

AAMA

Job No.:	0116051040I	Polarization:	Horizontal
Standard:	(RE)FCC PART15 C _3m	Power Source:	DC 3V
Test item:	Radiation Test	Temp.(C)/Hum.(%RH):	24.3( C)/55% RH
Note:	AV	Distance:	3m

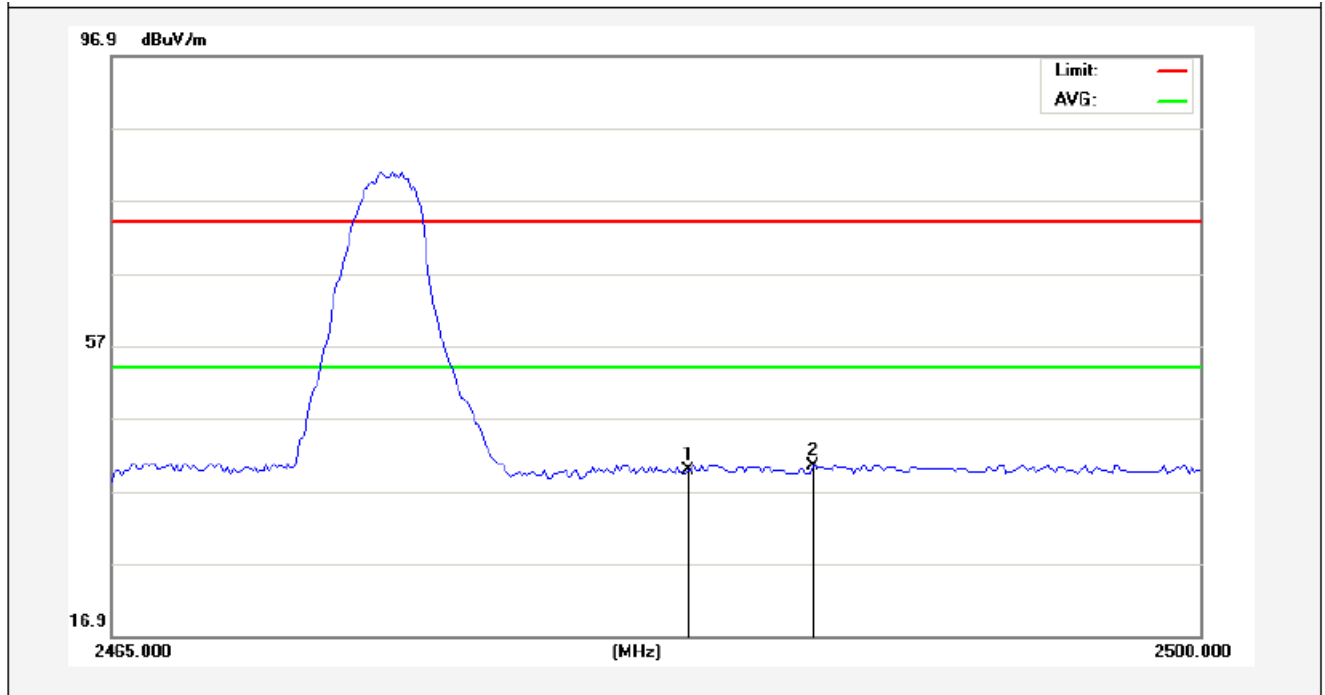

No.	Freq. (MHz)	Reading (dBuV/m)	Factor (dB/m)	Result (dBuV/m)	Limit (dBuV/)	Over Limit (dB)	Detector	Height (cm)	degree (deg)	Remark
1	2483.500	42.19	-2.31	39.88	54.00	-14.12	AVG			
2	2487.575	42.64	-2.30	40.34	54.00	-13.66	AVG			

Job No.:	0116051040I	Polarization:	Vertical
Standard:	(RE)FCC PART15 C_3m	Power Source:	DC 3V
Test item:	Radiation Test	Temp.(C)/Hum.(%RH):	24.3( C)/55% RH
Note:	AV	Distance:	3m

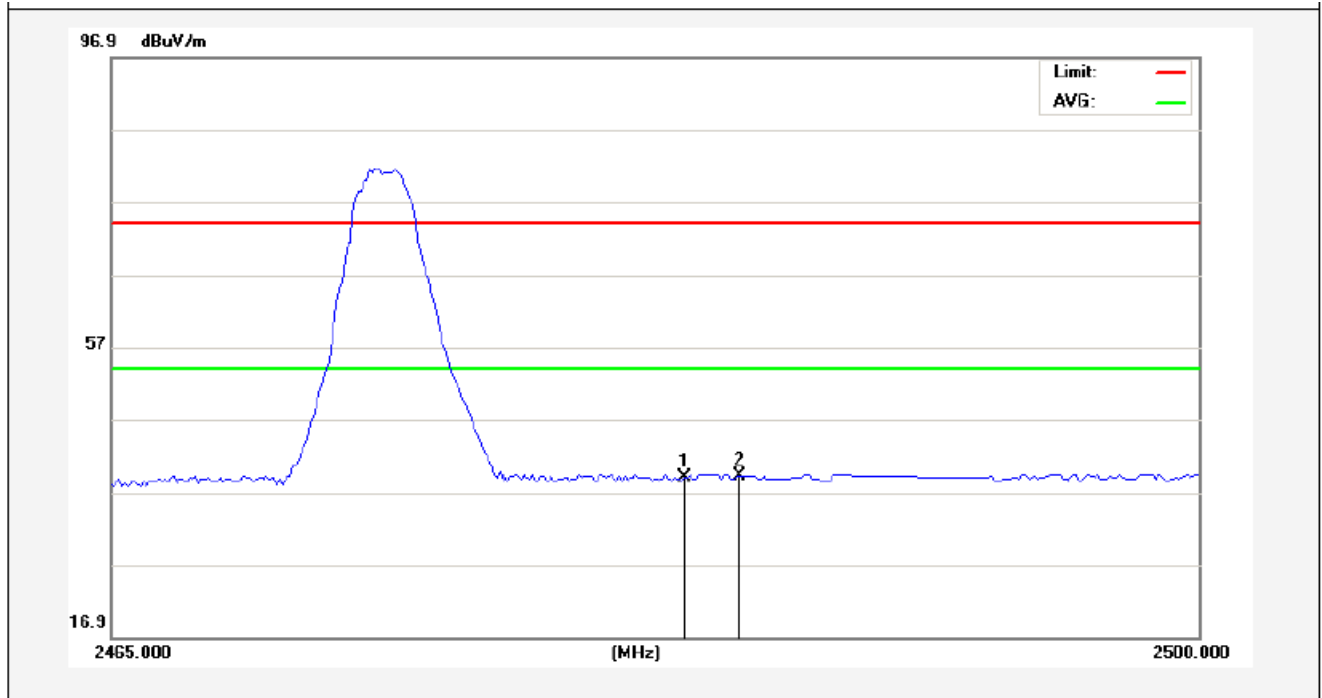

No.	Freq. (MHz)	Reading (dBuV/m)	Factor (dB/m)	Result (dBuV/m)	Limit (dBuV/)	Over Limit (dB)	Detector	Height (cm)	degree (deg)	Remark
1	2483.500	41.29	-2.31	38.98	54.00	-15.02	AVG			
2	2485.213	41.57	-2.30	39.27	54.00	-14.73	AVG			

## 6. Occupied Bandwidth

### 6.1. Requirements :

According to 15.215 (c), intentional radiators operating under the alternative provisions to the general emission limits, as contained in §§15.217 through 15.257 and in Subpart E of this part, must be designed to ensure that the 20 dB bandwidth of the emission, or whatever bandwidth may otherwise be specified in the specific rule section under which the equipment operates, is contained within the frequency band designated in the rule section under which the equipment is operated. The requirement to contain the designated bandwidth of the emission within the specified frequency band includes the effects from frequency sweeping, frequency hopping and other modulation techniques that may be employed as well as the frequency stability of the transmitter over expected variations in temperature and supply voltage. If a frequency stability is not specified in the regulations, it is recommended that the fundamental emission be kept within at least the central 80% of the permitted band in order to minimize the possibility of out-of-band operation.

### 6.2. Test SET-UP

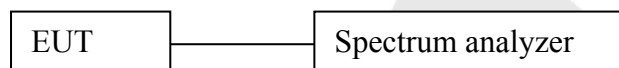

### 6.3 Test Equipment

Same as the equipment listed in 4.3.

### 6.4. Test Results

Pass.

Please refer the following plot.

20dB Down:

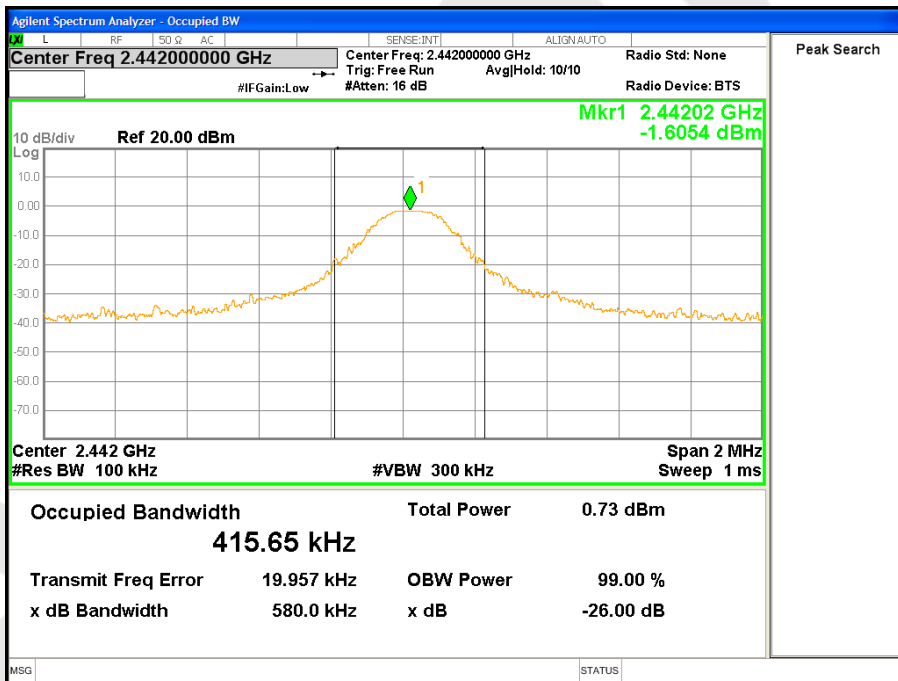
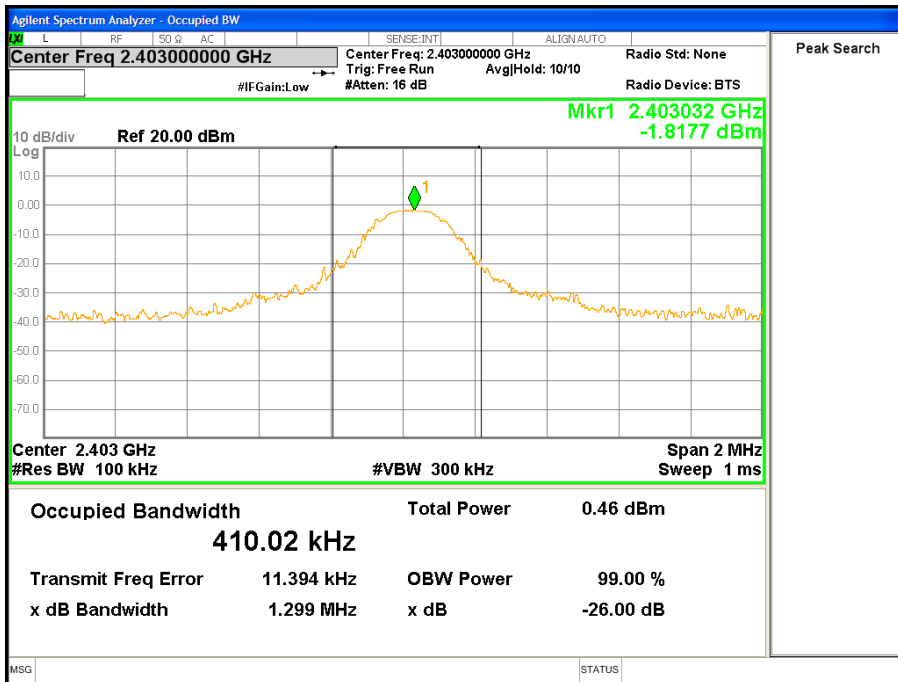

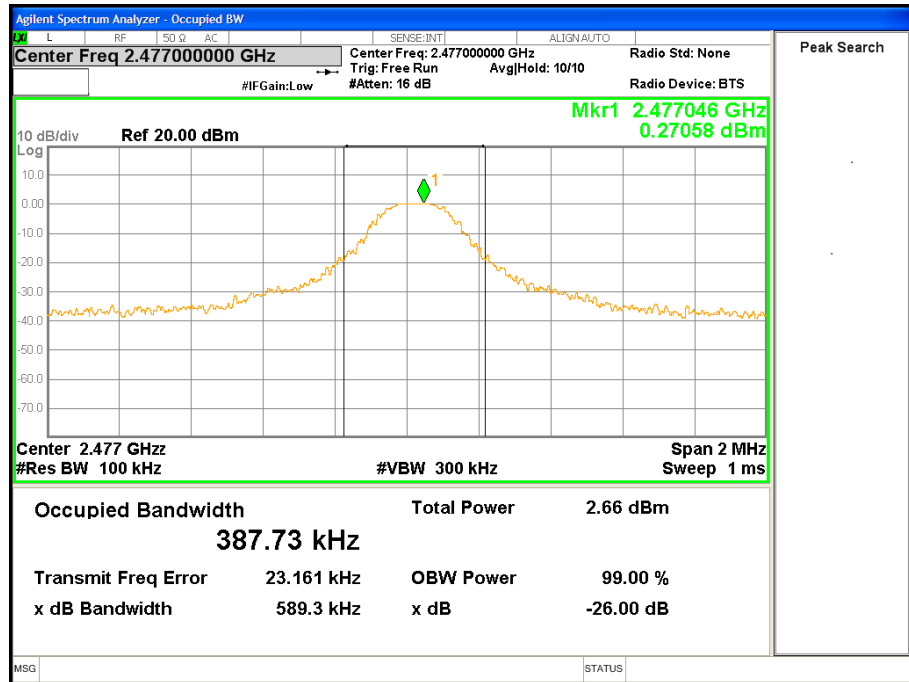

Anbotek

## 7. ANTENNA APPLICATION

### 7.1. Antenna requirement

The EUT'S antenna is met the requirement of FCC part 15C section 15.203.

An intentional radiator shall be designed to ensure that no antenna other than that furnished by the responsible party shall be used with the device. The use of a permanently attached antenna or of an antenna that uses a unique coupling to the intentional radiator shall be considered sufficient to comply with the provisions of this section. The manufacturer may design the unit so that a broken antenna can be replaced by the user, but the use of a standard antenna jack or electrical connector is prohibited. This requirement does not apply to carrier current devices or to devices operated under the provisions of §15.211, §15.213, §15.217, §15.219, or §15.221. Further, this requirement does not apply to intentional radiators that must be professionally installed, such as perimeter protection systems and some field disturbance sensors, or to other intentional radiators which, in accordance with §15.31(d), must be measured at the installation site. However, the installer shall be responsible for ensuring that the proper antenna is employed so that the limits in this part are not exceeded.

### 7.2. Result

The EUT's antenna used a PCB antenna which is permanently attached, The antenna's gain is -1.0dBi and meets the requirement.

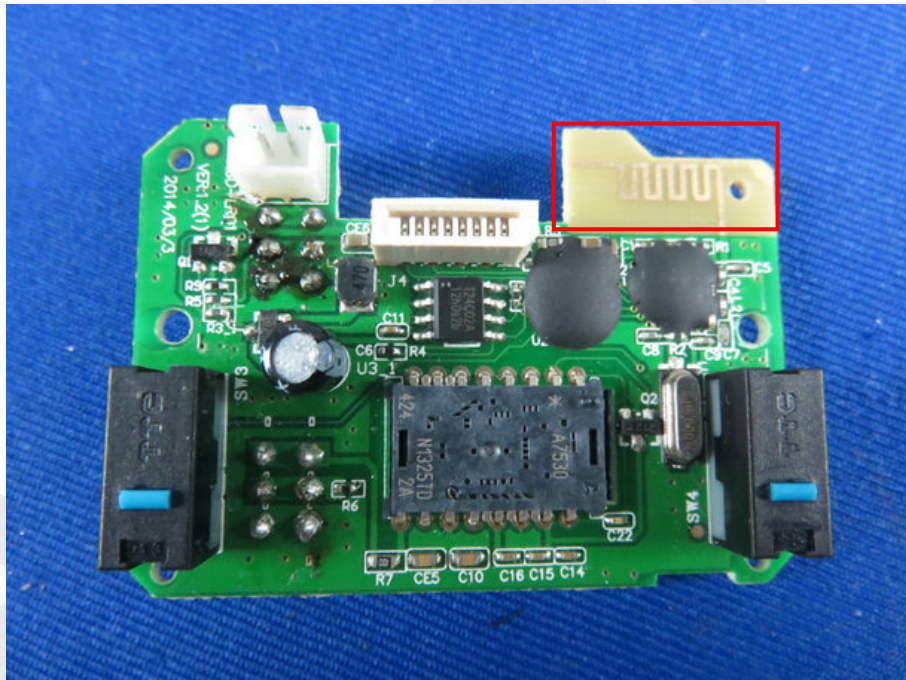



## 8. PHOTOGRAPH

### 8.1. Photo of Radiation Emission Test

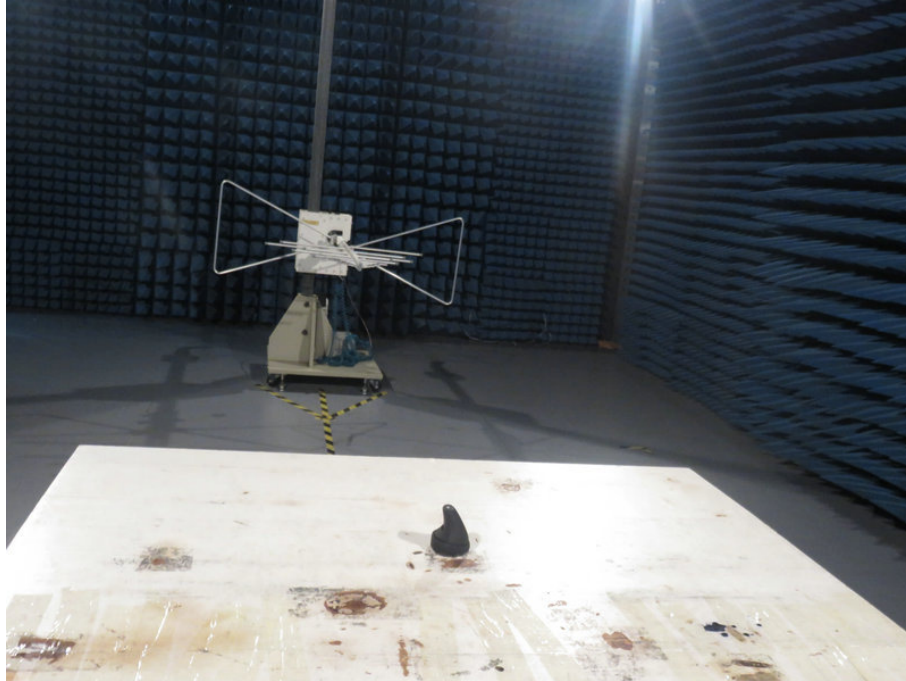

### APPENDIX I (External Photos)

1. Figure  
The EUT-Overall View

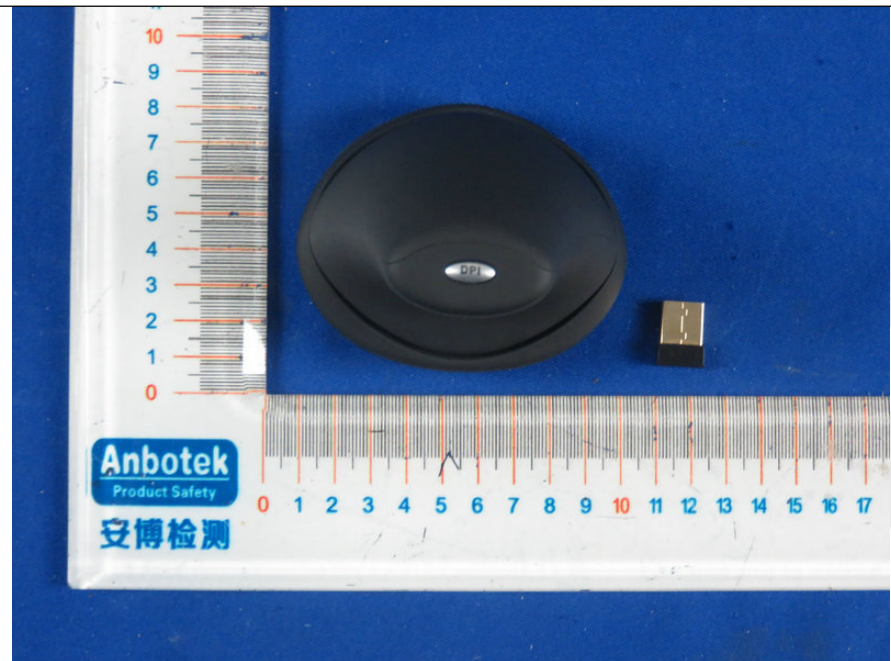

2. Figure  
The EUT-Top View

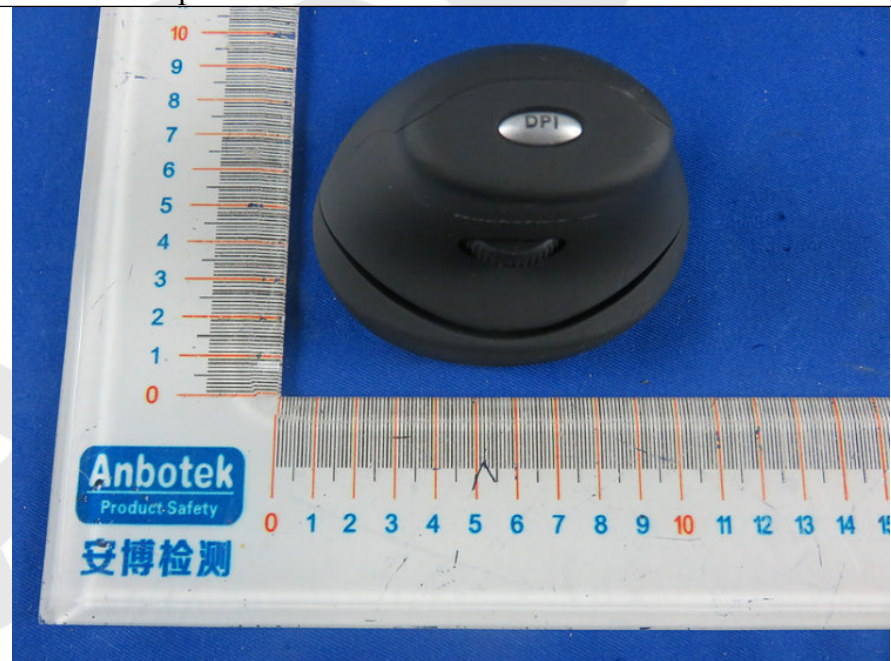



3. Figure  
The EUT-Bottom View

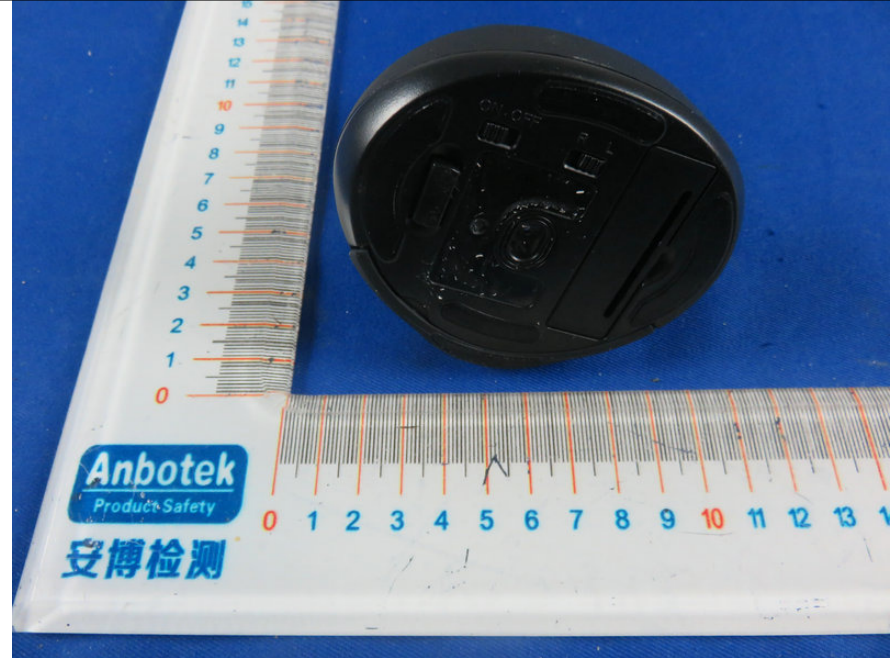

4. Figure  
The EUT-Front View



5. Figure  
The EUT-Back View

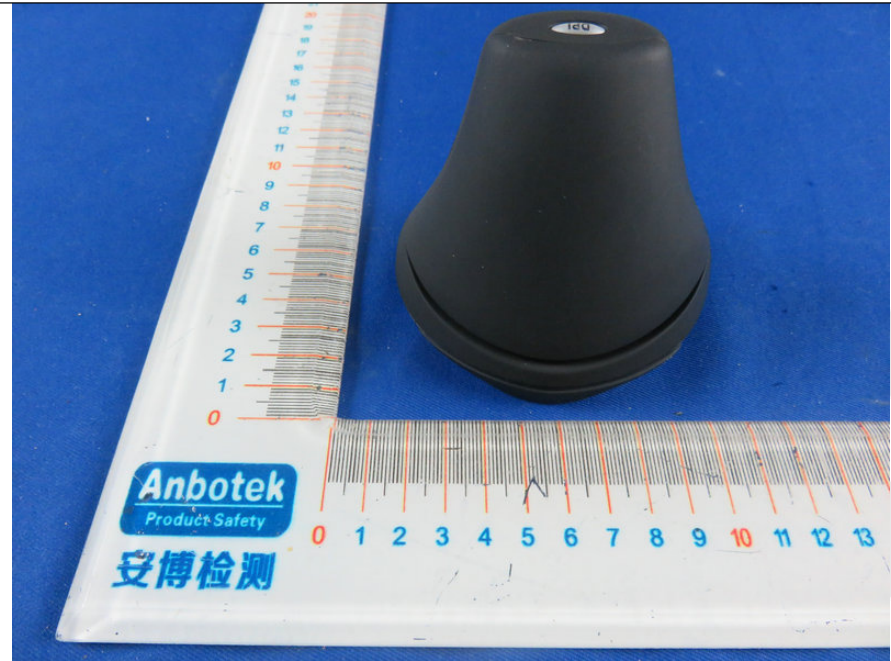

6. Figure  
The EUT- Right View



7. Figure  
The EUT- Left View



Anbotek



## APPENDIX II (INTERNAL PHOTOS)

1. Figure  
The EUT-Inside View



2. Figure  
The EUT-Inside View



3. Figure  
PCB of the EUT-Front View



4. Figure  
PCB of the EUT-Back View

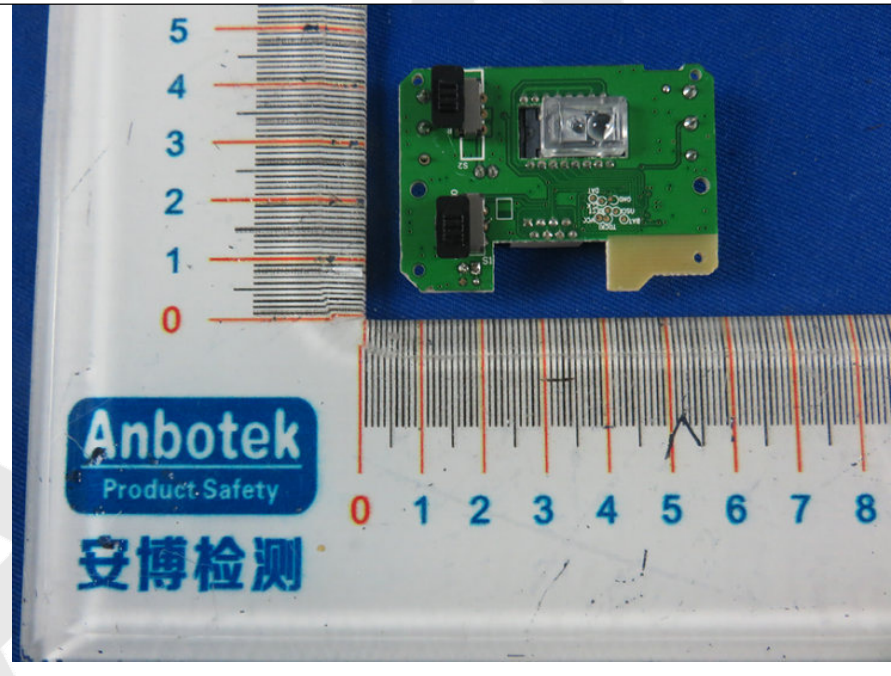



5. Figure  
PCB of the EUT-Front View

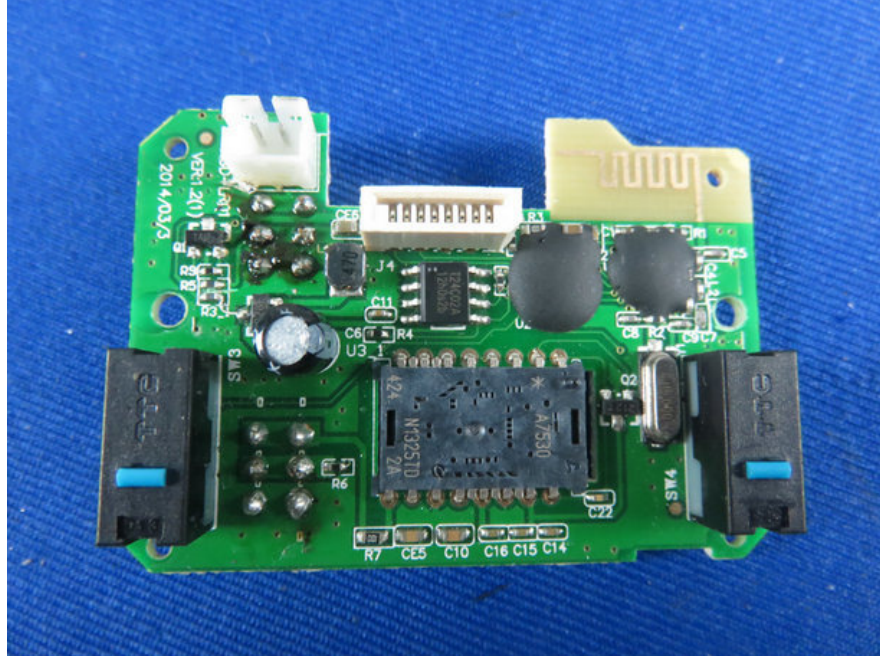

6. Figure  
PCB of the EUT-Back View

