

SAR Test Report

Product Name : SMART PHONE
Model No. : Syreni 50DC II
FCC ID : 2AAM3SYRENI50DCII

Applicant : Bulltech Electronic Products S.L.
Address : Gran Via, 64, 2-I, 28013 Madrid, Spain.

Date of Receipt : Apr. 01, 2014
Date of Test : Apr. 01, 2014
Issued Date : Apr. 03, 2014
Report No. : 1440095R-HP-US-P03V01
Report Version : V1.2



The test results relate only to the samples tested.

The test report shall not be reproduced except in full without the written approval of QuieTek Corporation.

Test Report Certification

Issued Date: Apr. 03, 2014

Report No.: 1440095R-HP-US-P03V01



Product Name : SMART PHONE

Applicant : Bulltech Electronic Products S.L.

Address : Gran Via, 64, 2-I, 28013 Madrid, Spain.

Manufacturer : Shenzhen ODX Telecom Equipment Co., Ltd.

Address : 2nd Floor of Building B, HongLianYing Technology Park, No.286
of SiLi Road, DaBuXiang Community, Longhua New District,
Shenzhen, China

Model No. : Syreni 50DC II

FCC ID : 2AAM3SYRENI50DCII

Brand Name : SZENIO

EUT Voltage : DC 3.7V

Applicable Standard : IEEE Std. 1528-2013, 47CFR § 2.1093
FCC KDB Publication 447498 D01v05r02
FCC KDB Publication 648474 D04v01r02
FCC KDB Publication 865664 D01v01r03
FCC KDB Publication 941225 D01~D06

Test Result : Max. SAR Measurement (1g)
Head: 0.313 W/kg; Body-worn: 0.459 W/kg
Hotspot: 1.11 W/kg; Simultaneous transmission: 1.3 W/kg

Performed Location : Suzhou EMC Laboratory
No.99 Hongye Rd., Suzhou Industrial Park Loufeng
Hi-TechDevelopment Zone., Suzhou, China
TEL: +86-512-6251-5088 / FAX: +86-512-6251-5098
FCC Registration Number: 800392

Documented By : Alice Ni

Reviewed By : James Yuan

Approved By : Jeff Chen

Laboratory Information

We, **QuieTek Corporation**, are an independent EMC and safety consultancy that was established the whole facility in our laboratories. The test facility has been accredited/accepted(audited or listed) by the following related bodies in compliance with ISO 17025, EN 45001 and specified testing scope:

Taiwan R.O.C.	:	BSMI, NCC, TAF
Germany	:	TUV Rheinland
Norway	:	Nemko, DNV
USA	:	FCC
Japan	:	VCCI
China	:	CNAS

The related certificate for our laboratories about the test site and management system can be downloaded from QuieTek Corporation's Web Site :<http://www.quietek.com/tw/ctg/cts/accreditations.htm>

The address and introduction of QuieTek Corporation's laboratories can be founded in our Web site :

<http://www.quietek.com/>

If you have any comments, Please don't hesitate to contact us. Our contact information is as below:

HsinChu Testing Laboratory :

No.75-2, 3rd Lin, Wangye Keng, Yonghxing Tsuen, Qionglin Shiang, Hsinchu County 307, Taiwan, R.O.C.
TEL:+886-3-592-8858 / FAX:+886-3-592-8859 E-Mail : service@quietek.com

LinKou Testing Laboratory :

No.5-22, Ruishukeng, Linkou Dist., New Taipei City 24451, Taiwan, R.O.C.
TEL : 886-2-8601-3788 / FAX : 886-2-8601-3789 E-Mail : service@quietek.com

Suzhou Testing Laboratory :

No.99 Hongye Rd., Suzhou Industrial Park Loufeng Hi-Tech Development Zone., SuZhou, China
TEL : +86-512-6251-5088 / FAX : 86-512-6251-5098 E-Mail : service@quietek.com

TABLE OF CONTENTS

Description	Page
1. General Information	6
1.1. EUT Description	6
1.2. Test Environment.....	8
1.3. EUT Antenna Locations.....	8
1.4. Simultaneous Transmission Configurations.....	9
1.5. SAR Test Exclusions Applied.....	10
1.6. Power Reduction for SAR.....	10
1.7. Guidance Documents.....	10
2. SAR Measurement System	11
2.1. DASY5 System Description.....	11
2.1.1. Applications	12
2.1.2. Area Scans	12
2.1.3. Zoom Scan (Cube Scan Averaging)	12
2.1.4. Uncertainty of Inter-/Extrapolation and Averaging	12
2.2. DASY5 E-Field Probe.....	13
2.2.1. Isotropic E-Field Probe Specification	13
2.3. Boundary Detection Unit and Probe Mounting Device	14
2.4. DATA Acquisition Electronics (DAE) and Measurement Server.....	14
2.5. Robot.....	15
2.6. Light Beam Unit.....	15
2.7. Device Holder.....	16
2.8. SAM Twin Phantom.....	16
3. Tissue Simulating Liquid	17
3.1. The composition of the tissue simulating liquid	17
3.2. Tissue Calibration Result.....	18
3.3. Tissue Dielectric Parameters for Head and Body Phantoms.....	19
4. SAR Measurement Procedure	20
4.1. SAR System Validation.....	20
4.1.1. Validation Dipoles	20
4.1.2. Validation Result.....	21
4.2. SAR Measurement Procedure.....	22
4.3. Body-Worn Accessory Configurations.....	23

4.4.	Wireless Router Configurations	24
4.5.	SAR Measurement Conditions for UMTS	25
4.5.1.	Output Power Verification	25
4.5.2.	Head SAR Measurements for Handsets	25
4.5.3.	Body SAR Measurements.....	25
4.5.4.	SAR Measurements for Handsets with Rel 5 HSDPA.....	25
4.5.5.	SAR Measurements for Handsets with Rel 6 HSUPA.....	26
5.	SAR Exposure Limits	27
6.	Test Equipment List.....	28
7.	Measurement Uncertainty.....	29
8.	Conducted Power Measurement	30
9.	Test Results.....	35
9.1.	SAR Test Results Summary	35
9.2.	SAR Test Notes	41
Appendix A.	SAR System Validation Data	45
Appendix B.	SAR measurement Data	49
Appendix C.	Test Setup Photographs & EUT Photographs.....	86
Appendix D.	Probe Calibration Data	94
Appendix E.	Dipole Calibration Data.....	105
Appendix F.	DAE Calibration Data.....	121

1. General Information

1.1. EUT Description

Product Name	SMART PHONE
Model No.	Syreni 50DC II
IMEI 1:	358392044937091
IMEI 2:	358392044937109
Hardware Version	8068-MB-V0.3
Software Version	8068-01C_K77W_OTD_A999W_BULLTECH_QHD_V00 8_20140117_1240
Device Category	Portable
RF Exposure Environment	Uncontrolled
Antenna Type	Internal
GPS	
Class of SRD	Class 3
2G	
Support Band	GSM850/PCS1900
GPRS Class	Class 12
Uplink	GSM 850: 824~849MHz PCS 1900: 1850~1910MHz
Downlink	GSM 850: 869~894MHz PCS 1900: 1930~1990MHz
Release Version	R99
Type of modulation	GMSK for GSM/GPRS 8PSK for EGSM/EGPRS
Antenna Gain	GSM 850: -2.0dBi PCS1900: -1.0dBi
3G	
Support Band	WCDMA Band V
Uplink	WCDMA Band V: 824~849MHz
Downlink	WCDMA Band V: 869~894MHz
Release Version	Rel-6
Type of modulation	QPSK for Uplink
Antenna Gain	WCDMA Band V: -2.0dBi
Wi-Fi	
Wi-Fi Frequency	802.11b/g/n(20MHz): 2412 ~ 2462 MHz 802.11n(40MHz): 2422 ~ 2452 MHz

Type of modulation	802.11b: DSSS; 802.11g/n: OFDM
Data Rate	802.11b: 1/2/5.5/11 Mbps
	802.11g: 6/9/12/18/24/36/48/54 Mbps
	802.11n: up to 135 Mbps
Peak Antenna Gain	0dBi
Bluetooth	
Bluetooth Frequency	2402~2480MHz
Bluetooth Version	V4.0
Type of modulation	GFSK
Data Rate	1Mbps(GFSK)
Antenna Gain	0dBi

1.2. Test Environment

Ambient conditions in the laboratory:

Items	Required	Actual
Temperature (°C)	18-25	21.5± 2
Humidity (%RH)	30-70	52

1.3. EUT Antenna Locations

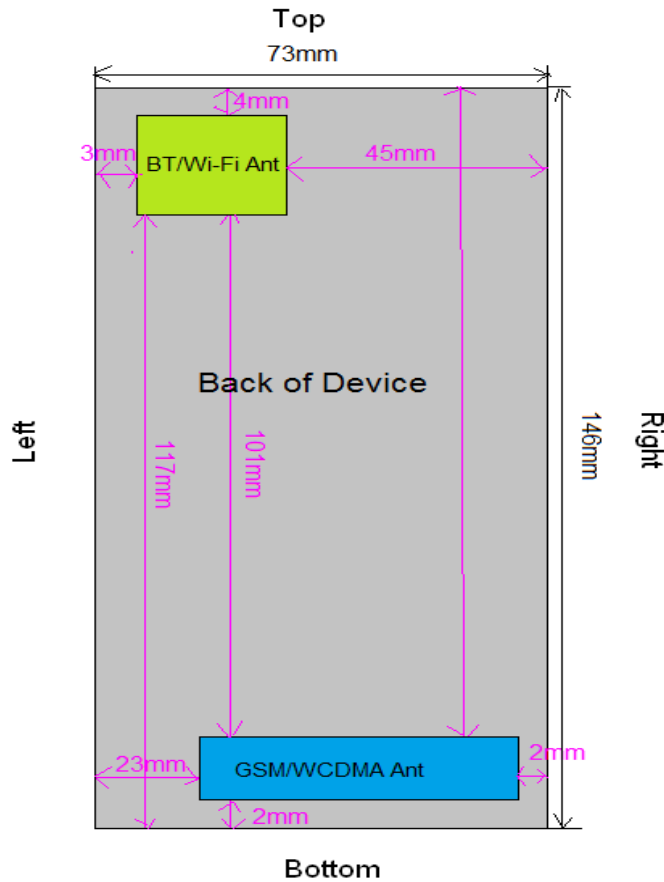

Mobile Hotspot Sides for SAR Testing

Mode	Back	Front	Top	Bottom	Right	Left
GPRS850	Yes	Yes	No	Yes	Yes	Yes
GPRS1900	Yes	Yes	No	Yes	Yes	Yes
WCDMA Band V	Yes	Yes	No	Yes	Yes	Yes
2.4GHz WLAN	Yes	Yes	Yes	No	No	Yes

Note: Particular DUT edges were not required to be evaluated for Wireless Router SAR if the edges were greater than 2.5 cm from the transmitting antenna according to FCC KDB Publication 941225 D06v01r01 guidance, page 2. The antenna photo shows the distances between the transmit antennas and the edges of the device.

1.4. Simultaneous Transmission Configurations

According to FCC KDB Publication 447498 D01v05r02, transmitters are considered to be transmitting simultaneously when there is overlapping transmission, with the exception of transmissions during network hand-offs with maximum hand-off duration less than 30 seconds. This device contains multiple transmitters that may operate simultaneously, and therefore requires a simultaneously transmission analysis according to FCC KDB Publication 447498 D01v05r02 3) procedures.

Table 1-1
Simultaneous Transmission Scenarios

Ref.	Simultaneous Transmit Configurations	Head	Body-Worn Accessory	Hotspot	Note
		IEEE1528 Supp C	FCC KDB447498 D01v05r02	FCC KDB941225 D06v01r01	
1	GSM850 Voice + BT	Yes	Yes	No	
2	GPRS850 Data + BT	No	Yes	No	
3	PCS1900 Voice + BT	Yes	Yes	No	
4	GPRS1900 Data + BT	No	Yes	No	
5	WCDMA Band V Voice + BT	Yes	Yes	No	
6	WCDMA Band V Data + BT	No	Yes	No	
7	GSM850 Voice + 2.4GHz Wi-Fi	Yes	Yes	No	
8	PCS1900 Voice + 2.4GHz Wi-Fi	Yes	Yes	No	
9	GPRS850 Data + 2.4GHz Wi-Fi	No	No	Yes	GPRS + Wi-Fi Hotspot
10	GPRS1900 Data + 2.4GHz Wi-Fi	No	No	Yes	GPRS + Wi-Fi Hotspot
11	WCDMA Band V Voice + 2.4GHz Wi-Fi	Yes	Yes	No	
12	WCDMA Band V Data + 2.4GHz Wi-Fi	No	No	Yes	WCDMA + Wi-Fi Hotspot

Note: Bluetooth and Wi-Fi share the same antenna and cannot transmit simultaneously.

1.5. SAR Test Exclusions Applied

(A) Wi-Fi/Bluetooth

Per FCC KDB 447498 D01v05R02, the SAR exclusion threshold for distances < 50mm is defined by the following equation:

$$\frac{\text{Max Power of Channel (mW)}}{\text{Test Separation Dist (mm)}} * \sqrt{\text{Frequency(GHz)}} \leq 3.0$$

Based on the maximum conducted power of Wi-Fi and the antenna to use separation distance, Wi-Fi SAR was not required;

$$[(9.12\text{mW}/5) * \sqrt{2.437}] = 2.85 < 3.0 \text{ for Head}; [(9.12\text{mW}/10) * \sqrt{2.437}] = 1.42 < 3.0 \text{ for Body.}$$

Based on the maximum conducted power of Bluetooth and the antenna to use separation distance,

Bluetooth SAR was not required;

$$[(2.0\text{mW}/5) * \sqrt{2.441}] = 0.624 < 3.0 \text{ for Head}; [(2.0\text{mW}/10) * \sqrt{2.441}] = 0.312 < 3.0 \text{ for Body.}$$

(B) Licensed Transmitter(s)

GSM/GPRS DTM is not supported for US bands. Therefore, the GSM Voice modes in this report do not transmit simultaneously with GPRS Data.

This device is only capable of QPSK HSPA in the uplink. Therefore, no additional SAR tests are required beyond that described for devices with HSPA in KDB 941225 D01v02.

When the user utilizes multiple services in UMTS 3G mode it uses multi-Radio Access Bearer or multi-RAB. The power control is based on a physical control channel (Dedicated Physical Control Channel [DPCCH]) and power control will be adjusted to meet the needs of both services. Therefore, the UMTS+WLAN scenario also represents the UMTS Voice/DATA + WLAN Hotspot scenario.

1.6. Power Reduction for SAR

There is no power reduction used for any band/mode implemented in this device for SAR purposes.

1.7. Guidance Documents

- 1) FCC KDB Publication 941225 D01-D06 (2G, 3G and Hotspot)
- 2) FCC KDB Publication 447498 D01v05r02 (General SAR Guidance)
- 3) FCC KDB Publication 865664 D01v01r03 (SAR measurement 100 MHz to 6 GHz)
- 4) FCC KDB Publication 648474 D04v01r02 (SAR Evaluation Considerations for Wireless Handsets)

2. SAR Measurement System

2.1. DASY5 System Description

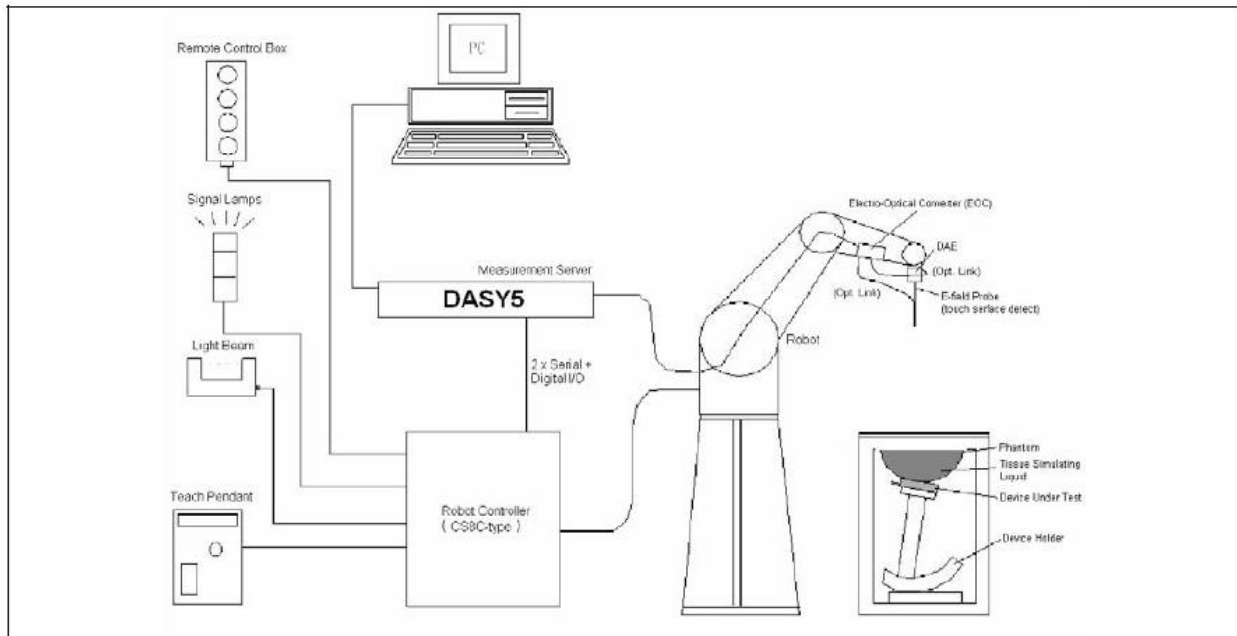

The DASY5 system for performing compliance tests consists of the following items:

- A standard high precision 6-axis robot with controller, teach pendant and software. An arm extension for accommodating the data acquisition electronics (DAE).
- A data acquisition electronics (DAE) which performs the signal amplification, signal multiplexing, AD-conversion, offset measurements, mechanical surface detection, collision detection, etc. The unit is battery powered with standard or rechargeable batteries. The signal is optically transmitted to the EOC.
- The Electro-optical converter (EOC) performs the conversion from optical to electrical signals for the digital communication to the DAE. To use optical surface detection, a special version of the EOC is required. The EOC signal is transmitted to the measurement server.
- The Light Beam used is for probe alignment. This improves the (absolute) accuracy of the probe positioning.
- A computer running WinXP and the DASY5 software.
- Remote control and teach pendant as well as additional circuitry for robot safety such as warning lamps, etc.
- The phantom, the device holder and other accessories according to the targeted measurement.

2.1.1. Applications

Predefined procedures and evaluations for automated compliance testing with all worldwide standards, e.g., IEEE 1528, IEC 62209-1, IEC 62209-2, EN 50360, EN 50383 and others.

2.1.2. Area Scans

Area scans are defined prior to the measurement process being executed with a user defined variable spacing between each measurement point (integral) allowing low uncertainty measurements to be conducted. Scans defined for FCC applications utilize a 10mm² step integral, with 1mm interpolation used to locate the peak SAR area used for zoom scan assessments.

When an Area Scan has measured all reachable points, it computes the field maxima found in the scanned area, within a range of the global maximum. The range (in dB) is specified in the standards for compliance testing. For example, a 2 dB range is required in IEEE 1528-2013 and IEC 62209 standards, whereby 3 dB is a requirement when compliance is assessed in accordance with the ARIB standard (Japan).

2.1.3. Zoom Scan (Cube Scan Averaging)

Zoom Scans are used to assess the peak spatial SAR values within a cubic averaging volume containing 1 g and 10 g of simulated tissue. A density of 1000 kg/m³ is used to represent the head and body tissue density and not the phantom liquid density, in order to be consistent with the definition of the liquid dielectric properties, i.e. the side length of the 1 g cube is 10mm, with the side length of the 10 g cube 21,5mm.

The zoom scan integer steps can be user defined so as to reduce uncertainty, but normal practice for typical test applications utilize a physical step of 7x7x7 (5mmx5mmx5mm) providing a volume of 30mm in the X & Y axis, and 30mm in the Z axis.

2.1.4. Uncertainty of Inter-/Extrapolation and Averaging

In order to evaluate the uncertainty of the interpolation, extrapolation and averaged SAR calculation algorithms of the Postprocessor, DASY5 allows the generation of measurement grids which are artificially predefined by analytically based test functions. Therefore, the grids of area scans and zoom scans can be filled with uncertainty test data, according to the SAR benchmark functions of IEEE 1528. The three analytical functions shown in equations as below are used to describe the possible range of the expected SAR distributions for the tested handsets. The field gradients are covered by the spatially flat distribution f1, the spatially steep distribution f3 and f2 accounts for H-field cancellation on the phantom/tissue surface.

$$f_1(x, y, z) = Ae^{-\frac{z}{2a}} \cos^2 \left(\frac{\pi \sqrt{x'^2 + y'^2}}{2 \cdot 5a} \right)$$

$$f_2(x, y, z) = Ae^{-\frac{z}{a}} \frac{a^2}{a^2 + x'^2} \left(3 - e^{-\frac{2z}{a}} \right) \cos^2 \left(\frac{\pi y'}{2 \cdot 3a} \right)$$

$$f_3(x, y, z) = A \frac{a^2}{\frac{a^2}{4} + x'^2 + y'^2} \left(e^{-\frac{2z}{a}} + \frac{a^2}{2(a + 2z)^2} \right)$$

2.2. DASY5 E-Field Probe

The SAR measurement is conducted with the dosimetric probe manufactured by SPEAG. The probe is specially designed and calibrated for use in liquid with high permittivity. The dosimetric probe has special calibration in liquid at different frequency. SPEAG conducts the probe calibration in compliance with international and national standards (e.g. IEEE 1528, EN 62209-1, IEC 62209, etc.) under ISO 17025. The calibration data are in Appendix D.

2.2.1. Isotropic E-Field Probe Specification

Model	EX3DV4	
Construction	Symmetrical design with triangular core Built-in shielding against static charges PEEK enclosure material (resistant to organic solvents, e.g., DGBE)	
Frequency	10 MHz to 6 GHz Linearity: ± 0.2 dB (30 MHz to 6 GHz)	
Directivity	± 0.3 dB in HSL (rotation around probe axis) ± 0.5 dB in tissue material (rotation normal to probe axis)	
Dynamic Range	10 µW/g to 100 mW/g Linearity: ± 0.2 dB (noise: typically < 1 µW/g)	
Dimensions	Overall length: 330 mm (Tip: 20 mm) Tip diameter: 2.5 mm (Body: 12 mm) Typical distance from probe tip to dipole centers: 1 mm	
Application	High precision dosimetric measurements in any exposure scenario (e.g., very strong gradient fields). Only probe which enables compliance testing for frequencies up to 6 GHz with precision of better 30%.	

2.3. Boundary Detection Unit and Probe Mounting Device

The DASY5 probes use a precise connector and an additional holder for the probe, consisting of a plastic tube and a flexible silicon ring to center the probe. The connector at the DAE is flexibly mounted and held in the default position with magnets and springs. Two switching systems in the connector mount detect frontal and lateral probe collisions and trigger the necessary software response.

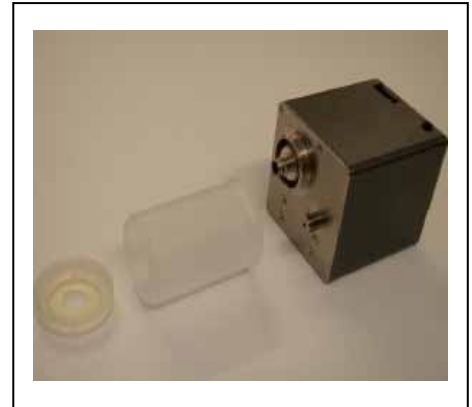

2.4. DATA Acquisition Electronics (DAE) and Measurement Server

The data acquisition electronics (DAE) consists of a highly sensitive electrometer-grade preamplifier with auto-zeroing, a channel and gain-switching multiplexer, a fast 16 bit AD-converter and a command decoder and control logic unit.

Transmission to the measurement server is accomplished through an optical downlink for data and status information as well as an optical uplink for commands and the clock.

The input impedance of the DAE4 is 200M Ohm; the inputs are symmetrical and floating. Common mode rejection is above 80dB.

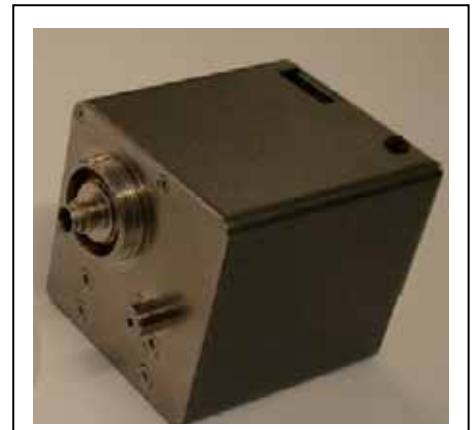

The DASY5 measurement server is based on a PC/104 CPU board with a 400MHz intel ULV Celeron, 128MB chipdisk and 128MB RAM. The necessary circuits for communication with the DAE electronics box, as well as the 16 bit AD converter system for optical detection and digital I/O interface are contained on the DASY5 I/O board, which is directly connected to the PC/104 bus of the CPU board.



2.5. Robot

The DASY5 system uses the high precision robots TX90 XL type out of the newer series from Stäubli SA (France). For the 6-axis controller DASY5 system, the CS8C robot controller version from Stäubli is used.

The XL robot series have many features that are important for our application:

- High precision (repeatability 0.02 mm)
- High reliability (industrial design)
- Jerk-free straight movements
- Low ELF interference (the closed metallic construction shields against motor control fields)
- 6-axis controller



2.6. Light Beam Unit

The light beam switch allows automatic "tooling" of the probe. During the process, the actual position of the probe tip with respect to the robot arm is measured, as well as the probe length and the horizontal probe offset. The software then corrects all movements, such that the robot coordinates are valid for the probe tip.

The repeatability of this process is better than 0.1 mm. If a position has been taught with an aligned probe, the same position will be reached with another aligned probe within 0.1 mm, even if the other probe has different dimensions. During probe rotations, the probe tip will keep its actual position.



2.7. Device Holder

The DASY5 device holder is designed to cope with different positions given in the standard. It has two scales for the device rotation (with respect to the body axis) and the device inclination (with respect to the line between the ear reference points). The rotation center for both scales is the ear reference point (EPR).

Thus the device needs no repositioning when changing the angles.

The DASY5 device holder has been made out of low-loss POM material having the following dielectric parameters: relative permittivity $\epsilon_r = 3$ and loss tangent $\delta = 0.02$. The amount of dielectric material has been reduced in the closest vicinity of the device, since measurements have suggested that the influence of the clamp on the test results could thus be lowered.



2.8. SAM Twin Phantom

The SAM twin phantom is a fiberglass shell phantom with 2mm shell thickness (except the ear region where shell thickness increases to 6mm). It has three measurement areas:

- Left head
- Right head
- Flat phantom



The bottom plate contains three pair of bolts for locking the device holder. The device holder positions are adjusted to the standard measurement positions in the three sections. A white cover is provided to tap the phantom during off-periods to prevent water evaporation and changes in the liquid parameters. On the phantom top, three reference markers are provided to identify the phantom position with respect to the robot.

3. Tissue Simulating Liquid

3.1. The composition of the tissue simulating liquid

INGREDIENT (% Weight)	835MHz Head	835MHz Body	1900MHz Head	1900MHz Body
Water	40.45	52.4	54.90	40.5
Salt	1.45	1.40	0.18	0.50
Sugar	57.6	45.0	0.00	58.0
HEC	0.40	1.00	0.00	0.50
Preventol	0.10	0.20	0.00	0.50
DGBE	0.00	0.00	44.92	0.00

3.2. Tissue Calibration Result

The dielectric parameters of the liquids were verified prior to the SAR evaluation using DASY5 Dielectric Probe Kit and Agilent Vector Network Analyzer E5071C

Head Tissue Simulant Measurement				
Frequency [MHz]	Description	Dielectric Parameters		Tissue Temp. [°C]
		ϵ_r	σ [s/m]	
835 MHz	Reference result ± 5% window	41.50 39.43 to 43.58	0.90 0.86 to 0.95	N/A
	01-04-2014	40.79	0.88	21.0
1900 MHz	Reference result ± 5% window	40.00 38.00 to 42.00	1.40 1.33 to 1.47	N/A
	01-04-2014	38.69	1.47	21.0

Body Tissue Simulant Measurement				
Frequency [MHz]	Description	Dielectric Parameters		Tissue Temp. [°C]
		ϵ_r	σ [s/m]	
835 MHz	Reference result ± 5% window	55.2 52.44 to 57.96	0.97 0.92 to 1.02	N/A
	01-04-2014	53.72	0.99	21.0
1900 MHz	Reference result ± 5% window	53.3 50.64 to 55.97	1.52 1.44 to 1.60	N/A
	01-04-2014	52.49	1.56	21.0

3.3. Tissue Dielectric Parameters for Head and Body Phantoms

The head tissue dielectric parameters recommended by the IEEE SCC-34/SC-2 in P1528 have been incorporated in the following table. These head parameters are derived from planar layer models simulating the highest expected SAR for the dielectric properties and tissue thickness variations in a human head. Other head and body tissue parameters that have not been specified in P1528 are derived from the tissue dielectric parameters computed from the 4-Cole-Cole equations described in Reference [12] and extrapolated according to the head parameters specified in P1528.

Target Frequency (MHz)	Head		Body	
	ϵ_r	σ (S/m)	ϵ_r	σ (S/m)
150	52.3	0.76	61.9	0.80
300	45.3	0.87	58.2	0.92
450	43.5	0.87	56.7	0.94
835	41.5	0.90	55.2	0.97
900	41.5	0.97	55.0	1.05
915	41.5	0.98	55.0	1.06
1450	40.5	1.20	54.0	1.30
1610	40.3	1.29	53.8	1.40
1800 – 2000	40.0	1.40	53.3	1.52
2450	39.2	1.80	52.7	1.95
3000	38.5	2.40	52.0	2.73
5800	35.3	5.27	48.2	6.00

(ϵ_r = relative permittivity, σ = conductivity and $\rho = 1000 \text{ kg/m}^3$)

4. SAR Measurement Procedure

4.1. SAR System Validation

4.1.1. Validation Dipoles

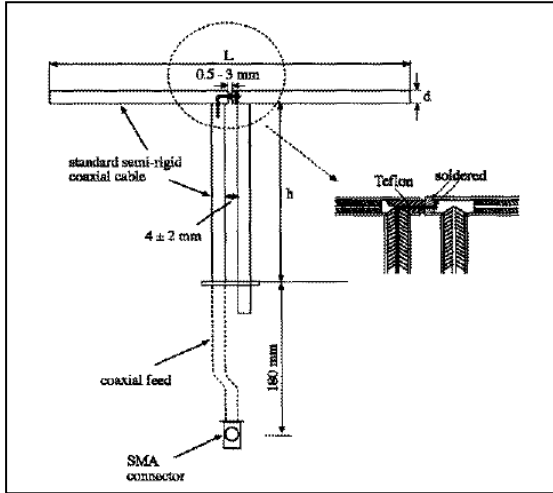

The dipoles used is based on the IEEE-1528 standard, and is complied with mechanical and electrical specifications in line with the requirements of both IEEE and FCC Supplement C. the table below provides details for the mechanical and electrical specifications for the dipoles.

Frequency	L (mm)	h (mm)	d (mm)
835MHz	161.0	89.8	3.6
1900MHz	68.0	39.5	3.6

4.1.2. Validation Result

System Performance Check at 835MHz, 1900MHz for Head				
Validation Kit: D835V2-SN 4d094				
Frequency [MHz]	Description	SAR [w/kg] 1g	SAR [w/kg] 10g	Tissue Temp. [°C]
835 MHz	Reference result ± 10% window	9.41 8.47 to 10.35	6.15 5.54 to 6.77	N/A
	01-04-2014	9.72	6.40	21.0
Validation Kit: D1900V2-SN 5d121				
Frequency [MHz]	Description	SAR [w/kg] 1g	SAR [w/kg] 10g	Tissue Temp. [°C]
1900 MHz	Reference result ± 10% window	39.4 35.46 to 43.34	20.8 18.72 to 22.88	N/A
	01-04-2014	39.84	20.32	21.0
Note: All SAR values are normalized to 1W forward power.				
System Performance Check at 835MHz, 1900MHz for Body				
Validation Kit: D835V2-SN 4d094				
Frequency [MHz]	Description	SAR [w/kg] 1g	SAR [w/kg] 10g	Tissue Temp. [°C]
835 MHz	Reference result ± 10% window	9.57 8.61 to 10.53	6.33 5.70 to 6.96	N/A
	01-04-2014	10.12	6.60	21.0
Validation Kit: D1900V2-SN 5d121				
Frequency [MHz]	Description	SAR [w/kg] 1g	SAR [w/kg] 10g	Tissue Temp. [°C]
1900 MHz	Reference result ± 10% window	38.7 34.83 to 42.57	20.4 18.36 to 22.44	N/A
	01-04-2014	39.92	20.68	21.0
Note: All SAR values are normalized to 1W forward power.				

4.2. SAR Measurement Procedure

The DASY5 calculates SAR using the following equation,

$$SAR = \frac{\sigma |E|^2}{\rho}$$

σ : represents the simulated tissue conductivity

ρ : represents the tissue density

The EUT is set to transmit at the required power in line with product specification, at each frequency relating to the LOW, MID, and HIGH channel settings.

Pre-scans are made on the device to establish the location for the transmitting antenna, using a large area scan in either air or tissue simulation fluid.

The EUT is placed against the Universal Phantom where the maximum area scan dimensions are larger than the physical size of the resonating antenna. When the scan size is not large enough to cover the peak SAR distribution, it is modified by either extending the area scan size in both the X and Y directions, or the device is shifted within the predefined area.

The area scan is then run to establish the peak SAR location (interpolated resolution set at 1mm²) which is then used to orient the center of the zoom scan. The zoom scan is then executed and the 1g and 10g averages are derived from the zoom scan volume (interpolated resolution set at 1mm³).

4.3. Body-Worn Accessory Configurations

Body-worn operating configurations are tested with the belt-clips and holsters attached to the device and positioned against a flat phantom in a normal use configuration. Per FCC KDB Publication 648474 D04 v01r02, Body-worn accessory exposure is typically related to voice mode operations when handsets are carried in body-worn accessories. The body-worn accessory procedures in FCC KDB Publication 447498 D01 v05r02 should be used to test for body-worn accessory SAR compliance, without a headset connected to it. This enables the test results for such configuration to be compatible with that required for hotspot mode when the body-worn accessory test separation distance is greater than or equal to that required for hotspot mode, when applicable. When the reported SAR for a body-worn accessory, measured without a headset connected to the handset, is > 1.2 W/kg, the highest reported SAR configuration for that wireless mode and frequency band should be repeated for that body-worn accessory with a headset attached to the handset.

Accessories for Body-worn operation configurations are divided into two categories: those that do not contain metallic components and those that do contain metallic components. When multiple accessories that do not contain metallic components are supplied with the device, the device is tested with only the accessory that dictates the closest spacing to the body. Then multiple accessories that contain metallic components are tested with the device with each accessory. If multiple accessories share an identical metallic component (i.e. the same metallic belt-clip used with different holsters with no other metallic components) only the accessory that dictates the closest spacing to the body is tested.

Body-worn accessories may not always be supplied or available as options for some devices intended to be authorized for body-worn use. In this case, a test configuration with a separation distance between the back of the device and the flat phantom is used. Test position spacing was documented. Transmitters that are designed to operate in front of a person's face, as in push-to-talk configurations, are tested for SAR compliance with the front of the device positioned to face the flat phantom in head fluid. For devices that are carried next to the body such as a shoulder, waist or chest-worn transmitters, SAR compliance is tested with the accessories, including headsets and microphones, attached to the device and positioned against a flat phantom in a normal use configuration.

4.4. Wireless Router Configurations

Some battery-operated handsets have the capability to transmit and receive user data through simultaneous transmission of Wi-Fi simultaneously with a separate licensed transmitter. The FCC has provided guidance in FCC KDB Publication 941225 D06 v01r01 where SAR test considerations for handsets ($L \times W \geq 9 \text{ cm} \times 5 \text{ cm}$) are based on a composite test separation distance of 10 mm from the front, back and edges of the device containing transmitting antennas within 2.5 cm of their edges, determined from general mixed use conditions for this type of devices. Since the hotspot SAR results may overlap with the body-worn accessory SAR requirements, the more conservative configurations can be considered, thus excluding some body-worn accessory SAR tests.

When the user enables the personal wireless router functions for the handset, actual operations include simultaneous transmission of both the Wi-Fi transmitter and another licensed transmitter. Both transmitters often do not transmit at the same transmitting frequency and thus cannot be evaluated for SAR under actual use conditions due to the limitations of the SAR assessment probes. Therefore, SAR must be evaluated for each frequency transmission and mode separately and spatially summed with the Wi-Fi transmitter according to FCC KDB Publication 447498 D01v05r02 publication procedures. The “Portable Hotspot” feature on the handset was NOT activated during SAR assessments, to ensure the SAR measurements were evaluated for a single transmission frequency RF signal at a time.

4.5. SAR Measurement Conditions for UMTS

4.5.1. Output Power Verification

Maximum output power is measured on the High, Middle and Low channels for each applicable transmission band according to the general descriptions in section 5.2 of 3GPP TS 34.121, using the appropriate RMC or AMR with TPC (transmit power control) set to all “1s”.

Maximum output power is verified on the High, Middle and Low channels according to the general descriptions in section 5.2 of 3GPP TS 34.121 (release 5), using the appropriate RMC with TPC (transmit power control) set to all “1s” or applying the required inner loop power control procedures to maintain maximum output power while HSUPA is active. Results for all applicable physical channel configurations (DPCCH, DPDCHn and spreading codes, HS-DPCCH etc) are tabulated in this test report. All configurations that are not supported by the DUT or cannot be measured due to technical or equipment limitations are identified.

4.5.2. Head SAR Measurements for Handsets

SAR for head exposure configurations is measured using the 12.2 kbps RMC with TPC bits configured to all “1s”. SAR in AMR configurations is not required when the maximum average output of each RF channel for 12.2 kbps AMR is less than 0.25 dB higher than that measured in 12.2 kbps RMC. Otherwise, SAR is measured on the maximum output channel in 12.2 AMR with a 3.4 kbps SRB (signaling radio bearer) using the exposure configuration that resulted in the highest SAR for that RF channel in the 12.2 kbps RMC mode.

4.5.3. Body SAR Measurements

SAR for body exposure configurations is measured using the 12.2 kbps RMC with the TPC bits all “1s”.

4.5.4. SAR Measurements for Handsets with Rel 5 HSDPA

Body SAR for HSDPA is not required for handsets with HSDPA capabilities when the maximum average output power of each RF channel with HSDPA active is less than 0.25 dB higher than that measured without HSDPA using 12.2 kbps RMC and the maximum SAR for 12.2 kbps RMC is $\leq 75\%$ of the SAR limit. Otherwise, SAR is measured for HSDPA, using an FRC with H-Set 1 in Sub-test 1 and a 12.2 kbps RMC configured in Test Loop Mode 1, using the highest body SAR configuration measured in 12.2 kbps RMC without HSDPA, on the maximum output channel with the body exposure configuration that resulted in the highest SAR in 12.2 kbps RMC mode for that RF channel.

The H-set used in FRC for HSDPA should be configured according to the UE category of a test device. The number of HS-DSCH/HSPDSCHs, HARQ processes, minimum inter-TTI interval, transport block sizes and RV coding sequence are defined by the applicable H-set. To maintain a consistent test configuration and stable transmission conditions, QPSK is used in the FRC for SAR testing. HS-DPCCH should be configured with a CQI feedback cycle of 2 ms to maintain a constant rate of active CQI slots. DPCCH and DPDCH gain factors of $\beta_c=9$ and $\beta_d=15$, and power offset parameters of $\Delta_{ACK}=\Delta_{NACK}=5$ and $\Delta_{CQI}=2$ is used. The CQI value is determined by the UE category, transport block size, number of HS-PDSCHs and modulation used in the FRC.

4.5.5. SAR Measurements for Handsets with Rel 6 HSUPA

Body SAR for HSUPA is not required when the maximum average output of each RF channel with HSUPA/HSDPA active is less than 0.25 dB higher than as measured without HSUPA/HSDPA using 12.2 kbps RMC and maximum SAR for 12.2 kbps RMC is $\leq 75\%$ of the SAR limit. Otherwise SAR is measured on the maximum output channel for the body exposure configuration produced highest SAR in 12.2 kbps RMC for that RF channel, using the additional procedures under “Release 6 HSPA data devices”

Head SAR for VOIP operations under HSPA is not required when maximum average output of each RF channel with HSPA is less than 0.25 dB higher than as measured using 12.2 kbps RMC. Otherwise SAR is measured using same HSPA configuration as used for body SAR.

Sub-test	β_c	β_d	β_d (SF)	β_c/β_d	$\beta_{1w}^{(1)}$	β_{ec}	β_{ed}	β_{ed} (SF)	β_{ed} (codes)	CM ⁽²⁾ (dB)	MPR (dB)	AG ⁽⁴⁾ Index	E-TFCI
1	11/15 ⁽³⁾	15/15 ⁽³⁾	64	11/15 ⁽³⁾	22/15	209/225	1039/225	4	1	1.0	0.0	20	75
2	6/15	15/15	64	6/15	12/15	12/15	94/75	4	1	3.0	2.0	12	67
3	15/15	9/15	64	15/9	30/15	30/15	$\beta_{ed1}: 47/15$ $\beta_{ed2}: 47/15$	4	2	2.0	1.0	15	92
4	2/15	15/15	64	2/15	4/15	2/15	56/75	4	1	3.0	2.0	17	71
5	15/15 ⁽⁴⁾	15/15 ⁽⁴⁾	64	15/15 ⁽⁴⁾	30/15	24/15	134/15	4	1	1.0	0.0	21	81

Note 1: $\Delta_{ACK}, \Delta_{NACK}$ and $\Delta_{CQI} = 8 \Leftrightarrow A_{1w} = \beta_{1w}/\beta_c = 30/15 \Leftrightarrow \beta_{1w} = 30/15 * \beta_c$.

Note 2: CM = 1 for $\beta_c/\beta_d = 12/15, \beta_{1w}/\beta_c = 24/15$. For all other combinations of DPDCH, DPCCH, HS-DPCCH, E-DPDCH and E-DPCCH the MPR is based on the relative CM difference.

Note 3: For subtest 1 the β_c/β_d ratio of 11/15 for the TFC during the measurement period (TF1, TF0) is achieved by setting the signaled gain factors for the reference TFC (TF1, TF1) to $\beta_c = 10/15$ and $\beta_d = 15/15$.

Note 4: For subtest 5 the β_c/β_d ratio of 15/15 for the TFC during the measurement period (TF1, TF0) is achieved by setting the signaled gain factors for the reference TFC (TF1, TF1) to $\beta_c = 14/15$ and $\beta_d = 15/15$.

Note 5: Testing UE using E-DPDCH Physical Layer category 1 Sub-test 3 is not required according to TS 25.306 Table 5.1g.

Note 6: β_{ed} can not be set directly; it is set by Absolute Grant Value.

5. SAR Exposure Limits

SAR assessments have been made in line with the requirements of IEEE-1528, FCC Supplement C, and comply with ANSI/IEEE C95.1-1992 “Uncontrolled Environments” limits. These limits apply to a location which is deemed as “Uncontrolled Environment” which can be described as a situation where the general public may be exposed to an RF source with no prior knowledge or control over their exposure.

Limits for General Population/Uncontrolled Exposure (W/kg)

Type Exposure	Uncontrolled Environment Limit
Spatial Peak SAR (1g cube tissue for brain or body)	1.60 W/kg
Spatial Average SAR (whole body)	0.08 W/kg
Spatial Peak SAR (10g for hands, feet, ankles and wrist)	4.00 W/kg

6. Test Equipment List

Instrument	Manufacturer	Model No.	Serial No.	Cali. Due Date
Stäubli Robot TX60L	Stäubli	TX60L	F10/5C90A1/A/01	N/A
Controller	Stäubli	SP1	S-0034	N/A
Dipole Validation Kits	Speag	D835V2	4d094	2016.02.27
Dipole Validation Kits	Speag	D1900V2	5d121	2016.02.27
SAM Twin Phantom	Speag	SAM	TP-1561/1562	N/A
Device Holder	Speag	SD 000 H01 HA	N/A	N/A
Data Acquisition Electronic	Speag	DAE4	1220	2015.01.22
E-Field Probe	Speag	EX3DV4	3710	2015.03.04
SAR Software	Speag	DASY5	V5.2 Build 162	N/A
Power Amplifier	Mini-Circuit	ZVA-183-S+	N657400950	N/A
Directional Coupler	Agilent	778D	20160	N/A
Universal Radio Communication Tester	R&S	CMU 200	117088	2015.03.28
Vector Network	Agilent	E5071C	MY48367267	2015.03.28
Signal Generator	Agilent	E4438C	MY49070163	2015.03.28
Power Meter	Anritsu	ML2495A	0905006	2014.11.01
Wide Bandwidth Sensor	Anritsu	MA2411B	0846014	2014.11.01

7. Measurement Uncertainty

DASY5 Uncertainty								
Measurement uncertainty for 300 MHz to 3 GHz averaged over 1 gram / 10 gram.								
Error Description	Uncert. value	Prob. Dist.	Div.	(ci) 1g	(ci) 10g	Std.Unc. (1g)	Std. nc. (10g)	(vi) V _{eff}
Measurement System								
Probe Calibration	±6.0%	N	1	1	1	±6.0%	±6.0%	∞
Axial Isotropy	±4.7%	R	$\sqrt{3}$	0.7	0.7	±1.9%	±1.9%	∞
Hemispherical Isotropy	±9.6%	R	$\sqrt{3}$	0.7	0.7	±3.9%	±3.9%	∞
Boundary Effects	±1.0%	R	$\sqrt{3}$	1	1	±0.6%	±0.6%	∞
Linearity	±4.7%	R	$\sqrt{3}$	1	1	±2.7%	±2.7%	∞
System Detection Limits	±1.0%	R	$\sqrt{3}$	1	1	±0.6%	±0.6%	∞
Readout Electronics	±0.3%	N	1	1	1	±0.3%	±0.3%	∞
Response Time	±0.8%	R	$\sqrt{3}$	1	1	±0.5%	±0.5%	∞
Integration Time	±2.6%	R	$\sqrt{3}$	1	1	±1.5%	±1.5%	∞
RF Ambient Noise	±3.0%	R	$\sqrt{3}$	1	1	±1.7%	±1.7%	∞
RF Ambient Reflections	±3.0%	R	$\sqrt{3}$	1	1	±1.7%	±1.7%	∞
Probe Positioner	±0.4%	R	$\sqrt{3}$	1	1	±0.2%	±0.2%	∞
Probe Positioning	±2.9%	R	$\sqrt{3}$	1	1	±1.7%	±1.7%	∞
Max. SAR Eval.	±1.0%	R	$\sqrt{3}$	1	1	±0.6%	±0.6%	∞
Test Sample Related								
Device Positioning	±2.9%	N	1	1	1	±2.9%	±2.9%	145
Device Holder	±3.6%	N	1	1	1	±3.6%	±3.6%	5
Power Drift	±5.0%	R	$\sqrt{3}$	1	1	±2.9%	±2.9%	∞
Phantom and Setup								
Phantom Uncertainty	±4.0%	R	$\sqrt{3}$	1	1	±2.3%	±2.3%	∞
Liquid Conductivity (target)	±5.0%	R	$\sqrt{3}$	0.64	0.43	±1.8%	±1.2%	∞
Liquid Conductivity (meas.)	±2.5%	N	1	0.64	0.43	±1.6%	±1.1%	∞
Liquid Permittivity (target)	±5.0%	R	$\sqrt{3}$	0.6	0.49	±1.7%	±1.4%	∞
Liquid Permittivity (meas.)	±2.5%	N	1	0.6	0.49	±1.5%	±1.2%	∞
Combined Std. Uncertainty						±11.0%	±10.8%	387
Expanded STD Uncertainty						±22.0%	±21.5%	

8. Conducted Power Measurement

Mode	Frequency (MHz)	Avg. Burst Power (dBm)	Duty Cycle Factor (dB)	Frame Power (dBm)	Max. Power (dBm)	Scaling Factor
Max. Power <SIM 1>						
GSM850	824.2	32.58	-9	23.58	33.0	1.102
	836.4	32.79	-9	23.79	33.0	1.050
	848.8	32.85	-9	23.85	33.0	1.035
GPRS850(1 Slot)	824.2	32.57	-9	23.57	33.0	1.104
	836.4	32.78	-9	23.78	33.0	1.052
	848.8	32.84	-9	23.84	33.0	1.038
GPRS850(2 Slot)	824.2	31.82	-6	25.82	32.2	1.091
	836.4	32.05	-6	26.05	32.2	1.035
	848.8	32.12	-6	26.12	32.2	1.019
GPRS850(3 Slot)	824.2	30.05	-4.25	25.80	30.5	1.109
	836.4	30.25	-4.25	26.00	30.5	1.059
	848.8	30.44	-4.25	26.19	30.5	1.014
GPRS850(4 Slot)	824.2	28.97	-3	25.97	29.5	1.130
	836.4	29.20	-3	26.20	29.5	1.072
	848.8	29.40	-3	26.40	29.5	1.023
EDGE850(1 slot)	824.2	26.51	-9	17.51	27.0	1.119
	836.4	26.73	-9	17.73	27.0	1.064
	848.8	26.81	-9	17.81	27.0	1.045
EDGE850(2 slot)	824.2	25.27	-6	19.27	26.0	1.183
	836.4	25.41	-6	19.41	26.0	1.146
	848.8	25.56	-6	19.56	26.0	1.107
EDGE850(3 slot)	824.2	23.67	-4.25	19.42	24.0	1.079
	836.4	23.84	-4.25	19.59	24.0	1.038
	848.8	23.95	-4.25	19.70	24.0	1.012
EDGE850(4 slot)	824.2	22.52	-3	19.52	23.0	1.117
	836.4	22.61	-3	19.61	23.0	1.094
	848.8	22.88	-3	19.88	23.0	1.028
PCS1900	1850.2	29.81	-9	20.81	30.5	1.172
	1880.0	29.97	-9	20.97	30.5	1.130
	1909.8	30.16	-9	21.16	30.5	1.081
GPRS1900(1 Slot)	1850.2	29.79	-9	20.79	30.5	1.178
	1880.0	29.95	-9	20.95	30.5	1.135
	1909.8	30.15	-9	21.15	30.5	1.084

GPRS1900(2 Slot)	1850.2	29.02	-6	23.02	29.5	1.117
	1880.0	29.23	-6	23.23	29.5	1.064
	1909.8	29.46	-6	23.46	29.5	1.009
GPRS1900(3 Slot)	1850.2	27.12	-4.25	22.87	27.8	1.169
	1880.0	27.34	-4.25	23.09	27.8	1.112
	1909.8	27.61	-4.25	23.36	27.8	1.045
GPRS1900(4 Slot)	1850.2	26.03	-3	23.03	26.6	1.140
	1880.0	26.25	-3	23.25	26.6	1.084
	1909.8	26.57	-3	23.57	26.6	1.007
EGPRS1900(1 Slot)	1850.2	25.75	-9	16.75	26.2	1.109
	1880.0	25.97	-9	16.97	26.2	1.054
	1909.8	26.14	-9	17.14	26.2	1.014
EGPRS1900(2 Slot)	1850.2	24.77	-6	18.77	25.2	1.104
	1880.0	24.92	-6	18.92	25.2	1.067
	1909.8	25.01	-6	19.01	25.2	1.045
EGPRS1900(3 Slot)	1850.2	22.89	-4.25	18.64	23.2	1.074
	1880.0	22.96	-4.25	18.71	23.2	1.057
	1909.8	23.11	-4.25	18.86	23.2	1.021
EGPRS1900(4 Slot)	1850.2	21.93	-3	18.93	22.5	1.140
	1880.0	22.06	-3	19.06	22.5	1.107
	1909.8	22.27	-3	19.27	22.5	1.054
Max. Power <SIM 2>						
GSM850	836.4	32.79	-9	23.79	33.0	1.050
PCS1900	1880.0	29.97	-9	20.97	30.5	1.130

Note 1: Scaling Factor = Max. Power(mW) / Avg. Burst Power(mW)

2: This device operates using the following maximum and nominal output power specifications. SAR values were scaled to the maximum allowed power to determine compliance per KDB Publication 447498 D01v05r02.

3: Both burst-averaged and calculated frame-averaged powers are included. Frame-averaged powers were calculated from the measured burst-averaged power by converting the slot powers into linear units and calculating the energy over 8 timeslots.

4: The bolded GPRS modes were selected for SAR testing according to the highest frame-averaged output power table per KDB 941225 D03v01.

5: GPRS(GMSK) output powers were measured with coding scheme setting of 1 (CS1) on the base station simulator. CS1 was configured to measure GPRS output power measurements and SAR to ensure GMSK modulation in the signal. Our Investigation has shown that CS1 - CS4 settings do not have any impact on the output levels or modulation in the GPRS modes.

6: EDGE (8-PSK) output powers were measured with MCS7 on the base station simulator. MCS7

coding scheme was used to measure the output powers for EDGE since investigation has shown that choosing MCS7 coding scheme will ensure 8-PSK modulation. It has been shown that MCS levels that produce 8PSK modulation do not have an impact on output power.

WCDMA/HSDPA/HSUPA

Mode	3GPP Subtest	Band V (835MHz) Channel			MPR
		Conducted Power (dBm)			
		4132	4182	4233	
WCDMA R99	1	22.66	22.89	22.50	N/A
Rel5 HSDPA	1	21.64	21.84	21.46	0
	2	21.31	21.48	21.29	0
	3	21.38	21.46	21.32	0.5
	4	21.36	21.41	21.32	0.5
Rel6 HSUPA	1	21.87	21.87	21.43	0.0
	2	20.16	20.13	19.89	2.0
	3	20.21	20.19	20.16	1.0
	4	20.15	20.19	20.03	2.0
	5	21.12	21.15	21.01	0.0

Note: UMTS SAR was tested under RMC 12.2 kbps with HSPA Inactive per KDB Publication 941225 D01v02. HSPA SAR was not required since the average output power of the HSPA subtests was not more than 0.25 dB higher than the RMC level and SAR was less than 1.2 W/kg.

Mode	Band V (835MHz) Channel	Normal Power (dBm)	Max. Power (dBm)	Scaling Factor
WCDMA R99	4132	22.66	23.0	1.081
	4182	22.89	23.0	1.026
	4233	22.50	23.0	1.122

WLAN output power

Test Mode	Channel No.	Frequency (MHz)	Average Power (dBm)	Max. Power (dBm)
802.11b	01	2412	9.38	9.6
	06	2437	9.55	9.6
	11	2462	9.47	9.6
802.11g	01	2412	9.13	9.3
	06	2437	9.28	9.3
	11	2462	9.21	9.3
802.11n (20MHz)	01	2412	8.67	9.0
	06	2437	8.86	9.0
	11	2462	8.82	9.0
802.11n (40MHz)	03	2422	8.64	9.0
	06	2437	8.79	9.0
	09	2452	8.71	9.0

BT output power

Test Mode	Channel No.	Frequency (MHz)	Average Power (dBm)	Max. Power (dBm)
DH5	00	2402	2.55	3.0
	39	2441	2.69	3.0
	79	2480	2.49	3.0
2DH5	00	2402	1.88	2.0
	39	2441	1.92	2.0
	79	2480	1.81	2.0
3DH5	00	2402	0.39	0.5
	39	2441	0.45	0.5
	79	2480	0.35	0.5
BLE	00	2402	-4.87	-4.5
	19	2440	-4.78	-4.5
	39	2480	-4.82	-4.5

9. Test Results

9.1. SAR Test Results Summary

SAR MEASUREMENT									
Ambient Temperature (°C) : 21.5 ± 2					Relative Humidity (%): 52				
Liquid Temperature (°C) : 21.0 ± 2					Depth of Liquid (cm):>15				
Product: SMART PHONE									
Test Mode: GSM850 <SIM 1>									
Test Position Head	Antenna Position	Frequency		Frame Power (dBm)	Power Drift (<±0.2)	SAR 1g (W/kg)	Scaling Factor	Scaled SAR 1g (W/kg)	Limit (W/kg)
		Channel	MHz						
Left-Cheek	Fixed	128	824.2	23.58	--	--	1.102	--	1.6
Left-Cheek	Fixed	189	836.4	23.79	0.08	0.131	1.050	0.138	1.6
Left-Cheek	Fixed	251	848.8	23.85	--	--	1.035	--	1.6
Left-Tilted	Fixed	189	836.4	23.79	0.15	0.075	1.050	0.079	1.6
Right-Cheek	Fixed	128	824.2	23.58	--	--	1.102	--	1.6
Right-Cheek	Fixed	189	836.4	23.79	0.03	0.137	1.050	0.144	1.6
Right-Cheek	Fixed	251	848.8	23.85	--	--	1.035	--	1.6
Right-Tilted	Fixed	189	836.4	23.79	0.11	0.081	1.050	0.085	1.6
Test Mode: GSM850 <SIM 2>									
Right-Cheek	Fixed	189	836.4	23.79	0.13	0.137	1.050	0.144	1.6
Note: when the 1-g SAR is ≤ 0.8 W/kg, testing for low and high channel is optional, refer to KDB 447498.									

SAR MEASUREMENT									
Ambient Temperature (°C) : 21.5 ± 2					Relative Humidity (%): 52				
Liquid Temperature (°C) : 21.0 ± 2					Depth of Liquid (cm):>15				
Product: SMART PHONE									
Body-worn Accessory SAR Configurations									
Test Mode: GSM850									
Test Position Body (10mm gap)	Antenna Position	Frequency		Frame Power (dBm)	Power Drift (<±0.2)	SAR 1g (W/kg)	Scaling Factor	Scaled SAR 1g (W/kg)	Limit (W/kg)
		Channel	MHz						
Body-worn	Fixed	128	824.2	23.58	--	--	1.102	--	1.6
Body-worn	Fixed	189	836.4	23.79	0.06	0.437	1.050	0.459	1.6
Body-worn	Fixed	251	848.8	23.85	--	--	1.035	--	1.6
Hotspot SAR Configurations									
Test Mode: GPRS850-4slot									
Back	Fixed	128	824.2	25.97	0.16	0.661	1.130	0.747	1.6
Back	Fixed	189	836.4	26.20	0.14	0.822	1.072	0.881	1.6
Back*	Fixed	189	836.4	26.20	-0.05	1.04	1.072	1.11	1.6
Back	Fixed	251	848.8	26.40	0.17	1.02	1.023	1.04	1.6
Front	Fixed	189	836.4	26.20	0.17	0.182	1.072	0.195	1.6
Right side	Fixed	189	836.4	26.20	0.03	0.200	1.072	0.214	1.6
Left side	Fixed	189	836.4	26.20	-0.02	0.229	1.072	0.245	1.6
Bottom	Fixed	189	836.4	26.20	-0.13	0.130	1.072	0.139	1.6
Note 1: when the 1-g SAR is ≤ 0.8 W/kg, testing for low and high channel is optional, refer to KDB 447498.									
2: * - repeated at the highest SAR measurement according to the FCC KDB 865664									

SAR MEASUREMENT									
Ambient Temperature (°C) : 21.5 ± 2					Relative Humidity (%): 52				
Liquid Temperature (°C) : 21.0 ± 2					Depth of Liquid (cm):>15				
Product: SMART PHONE									
Test Mode: PCS1900 <SIM 1>									
Test Position Head	Antenna Position	Frequency		Frame Power (dBm)	Power Drift (<±0.2)	SAR 1g (W/kg)	Scaling Factor	Scaled SAR 1g (W/kg)	Limit (W/kg)
		Channel	MHz						
Left-Cheek	Fixed	512	1850.2	20.81	--	--	1.172	--	1.6
Left-Cheek	Fixed	661	1880.0	20.97	0.07	0.277	1.130	0.313	1.6
Left-Cheek	Fixed	810	1909.8	21.16	--	--	1.081	--	1.6
Left-Tilted	Fixed	661	1880.0	20.97	-0.10	0.081	1.130	0.092	1.6
Right-Cheek	Fixed	512	1850.2	20.81	--	--	1.172	--	1.6
Right-Cheek	Fixed	661	1880.0	20.97	0.11	0.128	1.130	0.145	1.6
Right-Cheek	Fixed	810	1909.8	21.16	--	--	1.081	--	1.6
Right-Tilted	Fixed	661	1880.0	20.97	0.04	0.106	1.130	0.120	1.6
Test Mode: PCS1900 <SIM 2>									
Left-Cheek	Fixed	661	1880.0	20.97	-0.18	0.262	1.130	0.296	1.6
Note: when the 1-g SAR is ≤ 0.8 W/kg, testing for low and high channel is optional, refer to KDB 447498.									

SAR MEASUREMENT									
Ambient Temperature (°C) : 21.5 ± 2					Relative Humidity (%): 52				
Liquid Temperature (°C) : 21.0 ± 2					Depth of Liquid (cm):>15				
Product: SMART PHONE									
Body-worn Accessory SAR Configurations									
Test Mode: PCS1900									
Test Position Body (10mm gap)	Antenna Position	Frequency		Frame Power (dBm)	Power Drift (<±0.2)	SAR 1g (W/kg)	Scaling Factor	Scaled SAR 1g (W/kg)	Limit (W/kg)
		Channel	MHz						
Body-worn	Fixed	512	1850.2	20.81	--	--	1.172	--	1.6
Body-worn	Fixed	661	1880.0	20.97	-0.06	0.396	1.130	0.447	1.6
Body-worn	Fixed	810	1909.8	21.16	--	--	1.081	--	1.6
Hotspot SAR Configurations									
Test Mode: GPRS1900-4slot									
Back	Fixed	512	1850.2	23.03	--	--	1.140	--	1.6
Back	Fixed	661	1880.0	23.25	-0.06	0.676	1.084	0.733	1.6
Back	Fixed	810	1909.8	23.57	--	--	1.007	--	1.6
Front	Fixed	661	1880.0	23.25	0.03	0.249	1.084	0.270	1.6
Right side	Fixed	661	1880.0	23.25	0.03	0.092	1.084	0.100	1.6
Left side	Fixed	661	1880.0	23.25	-0.07	0.417	1.084	0.452	1.6
Bottom	Fixed	661	1880.0	23.25	0.09	0.347	1.084	0.376	1.6
Note: when the 1-g SAR is ≤ 0.8 W/kg, testing for low and high channel is optional, refer to KDB 447498.									

SAR MEASUREMENT									
Ambient Temperature (°C) : 21.5 ± 2					Relative Humidity (%) : 52				
Liquid Temperature (°C) : 21.0 ± 2					Depth of Liquid (cm) : >15				
Product: SMART PHONE									
Test Mode: WCDMA Band V									
Test Position Head	Antenna Position	Frequency		Conducted Power (dBm)	Power Drift (<±0.2)	SAR 1g (W/kg)	Scaling Factor	Scaled SAR 1g (W/kg)	Limit (W/kg)
		Channel	MHz						
Left-Cheek	Fixed	4132	826.4	22.66	--	--	1.081	--	1.6
Left-Cheek	Fixed	4182	836.4	22.89	0.19	0.081	1.026	0.083	1.6
Left-Cheek	Fixed	4233	846.6	22.50	--	--	1.122	--	1.6
Left-Tilt	Fixed	4182	836.4	22.89	-0.04	0.046	1.026	0.047	1.6
Right-Cheek	Fixed	4132	826.4	22.66	--	--	1.081	--	1.6
Right-Cheek	Fixed	4182	836.4	22.89	0.07	0.082	1.026	0.084	1.6
Right-Cheek	Fixed	4233	846.6	22.50	--	--	1.122	--	1.6
Right-Tilt	Fixed	4182	836.4	22.89	0.04	0.055	1.026	0.056	1.6

Note: when the 1-g SAR is ≤ 0.8 W/kg, testing for low and high channel is optional, refer to KDB 447498.

SAR MEASUREMENT									
Ambient Temperature (°C): 21.5 ± 2					Relative Humidity (%): 52				
Liquid Temperature (°C): 21.0 ± 2					Depth of Liquid (cm):>15				
Product: SMART PHONE									
Body-worn Accessory SAR Configurations									
Test Mode: WCDMA Band V									
Test Position Body (10mm gap)	Antenna Position	Frequency		Conducted Power (dBm)	Power Drift (<±0.2)	SAR 1g (W/kg)	Scaling Factor	Scaled SAR 1g (W/kg)	Limit (W/kg)
		Channel	MHz						
Body-worn	Fixed	4132	826.4	22.66	--	--	1.081	--	1.6
Body-worn	Fixed	4182	836.4	22.89	-0.18	0.330	1.026	0.339	1.6
Body-worn	Fixed	4233	846.6	22.50	--	--	1.122	--	1.6
Hotspot SAR Configurations									
Test Mode: WCDMA Band V									
Back	Fixed	4132	826.4	22.66	--	--	1.081	--	1.6
Back	Fixed	4182	836.4	22.89	-0.18	0.330	1.026	0.339	1.6
Back	Fixed	4233	846.6	22.50	--	--	1.122	--	1.6
Front	Fixed	4182	836.4	22.89	0.14	0.107	1.026	0.110	1.6
Right side	Fixed	4182	836.4	22.89	0.08	0.063	1.026	0.065	1.6
Left side	Fixed	4182	836.4	22.89	0.06	0.067	1.026	0.069	1.6
Bottom	Fixed	4182	836.4	22.89	0.10	0.048	1.026	0.049	1.6
Note: when the 1-g SAR is ≤ 0.8 W/kg, testing for low and high channel is optional, refer to KDB 447498.									

9.2. SAR Test Notes

9.2.1. Test position and configuration

Head SAR was performed with the device configured in the positions according to IEEE1528. Device was tested using a fixed spacing for body-worn accessory testing. A separation distance of 10 mm was considered because the manufacturer has determined that there will be body-worn accessories available in the marketplace for users to support this separation distance.

9.2.2. Body SAR with Headset

Per FCC KDB Publication 648474 D04v01r02, SAR was evaluated without a headset connected to the device. Since the standalone reported SAR was ≤ 1.2 W/kg, no additional SAR evaluations using a headset cable were required.

9.2.3. Hotspot Operation Mode

During SAR Testing for the Wireless Router conditions per FCC KDB Publication 941225 D06v01r01, the actual Portable Hotspot operation (with actual simultaneous transmission of a transmitter with Wi-Fi) was not activated.

9.2.4. Simultaneous Transmission Procedures

This device contains transmitters that may operate simultaneously. Therefore simultaneous transmission analysis is required. Per FCC KDB 447498 D01v05r02 IV.C.1.iii, simultaneous transmission SAR test exclusion may be applied when the sum of the 1-g SAR for all the simultaneous transmitting antennas in a specific a physical test configuration is ≤ 1.6 W/kg. When standalone SAR is not required to be measured, per FCC KDB 447498 D01v05r02 4.3.2 2, the following equation must be used to estimate the standalone 1g SAR for simultaneous transmission assessment involving that transmitter.

$$\text{Estimated SAR} = \frac{\sqrt{f(\text{GHz})}}{7.5} * \frac{(\text{Max Power of channel, mW})}{\text{Min. Separation Distance, mm}}$$

Estimated SAR for Bluetooth

Mode	Frequency	Maximum Allowed Power	Separation Distance (Head)	Estimated SAR (Held-to-Ear)	Separation Distance (Body)	Estimated SAR (Body)
	[MHz]	[dBm]	[mm]	[W/kg]	[mm]	[W/kg]
Bluetooth	2441	3.0	5	0.083	10	0.042

Estimated SAR for Wi-Fi

Mode	Frequency	Maximum Allowed Power	Separation Distance (Head)	Estimated SAR (Held-to-Ear)	Separation Distance (Body)	Estimated SAR (Body)
	[MHz]	[dBm]	[mm]	[W/kg]	[mm]	[W/kg]
Wi-Fi	2437	9.6	5	0.380	10	0.190

9.2.5. Simultaneous Transmission Analysis

Simultaneous Transmission Scenario with Wi-Fi

Configuration	Mode	Max. Scaled SAR (W/kg)	Wi-Fi SAR (W/kg)	Σ SAR (W/kg)
Head	GSM850	0.144	0.380	0.524
Head	PCS1900	0.313	0.380	0.693
Head	WCDMA Band V	0.084	0.380	0.464
Body-Worn	GSM850	0.459	0.190	0.649
Body-Worn	PCS1900	0.447	0.190	0.637
Body-Worn	WCDMA Band V	0.339	0.190	0.529

Note 1: Wi-Fi SAR was not required to be measured per FCC KDB 447498. Estimated SAR results were used in the above table to determine simultaneous transmission SAR test exclusion.

2: Body worn at 10mm.

Simultaneous Transmission Scenario with Bluetooth

Configuration	Mode	Max. Scaled SAR (W/kg)	Bluetooth SAR (W/kg)	Σ SAR (W/kg)
Head	GSM850	0.144	0.083	0.227
Head	PCS1900	0.313	0.083	0.396
Head	WCDMA Band V	0.084	0.083	0.167
Body-Worn	GSM850	0.459	0.042	0.501
Body-Worn	PCS1900	0.447	0.042	0.489
Body-Worn	WCDMA Band V	0.339	0.042	0.381

Note 1: Bluetooth SAR was not required to be measured per FCC KDB 447498. Estimated SAR results were used in the above table to determine simultaneous transmission SAR test exclusion.

2: Body worn at 10mm.

Simultaneous Transmission Scenario (Hotspot)

Simult Tx	Configuration	GPRS850 SAR (W/kg)	Wi-Fi SAR (W/kg)	Σ SAR (W/kg)
Body	Back	1.11	0.190	1.300
	Front	0.195	0.190	0.385
	Top	--	0.190	0.190
	Bottom	0.139	0.190	0.329
	Left	0.245	0.190	0.435
	Right	0.214	0.190	0.404
Simult Tx	Configuration	GPRS1900 SAR (W/kg)	Wi-Fi SAR (W/kg)	Σ SAR (W/kg)
Body	Back	0.733	0.190	0.923
	Front	0.270	0.190	0.460
	Top	--	0.190	0.190
	Bottom	0.376	0.190	0.566
	Left	0.452	0.190	0.642
	Right	0.100	0.190	0.290
Simult Tx	Configuration	WCDMA Band V SAR (W/kg)	Wi-Fi SAR (W/kg)	Σ SAR (W/kg)
Body	Back	0.339	0.190	0.529
	Front	0.110	0.190	0.300
	Top	--	0.190	0.190
	Bottom	0.049	0.190	0.239
	Left	0.069	0.190	0.259
	Right	0.065	0.190	0.255

9.2.6. Simultaneous Transmission Conclusion

The above numerical summed SAR results for all the worst-case simultaneous transmission conditions were below the SAR limit. Therefore, the above analysis is sufficient to determine that simultaneous transmission cases will not exceed the SAR limit and therefore no measured volumetric simultaneous SAR summation is required per FCC KDB Publication 447498 D01v05r02.

Appendix A. SAR System Validation Data

Date/Time: 01-04-2014

Test Laboratory: QuieTek Lab

System Check Head 835MHz

DUT: Dipole 835 MHz D835V2; Type: D835V2

Communication System: CW; Communication System Band: D835(835.0MHz); Duty Cycle: 1:1; Frequency: 835 MHz; Medium parameters used: $f = 835 \text{ MHz}$; $\sigma = 0.88 \text{ S/m}$; $\epsilon_r = 40.79$; $\rho = 1000 \text{ kg/m}^3$; Phantom section: Flat Section ; Input Power=250mW

Ambient temperature (°C): 21.5, Liquid temperature (°C): 21.0

DASY5 Configuration:

- Probe: EX3DV4 - SN3710; ConvF(9.56, 9.56, 9.56); Calibrated: 04/03/2014;
- Sensor-Surface: 4mm (Mechanical Surface Detection)
- Electronics: DAE4 Sn1220; Calibrated: 22/01/2014
- Phantom: SAM2; Type: SAM; Serial: TP1562
- Measurement SW: DASY52, Version 52.8 (7); SEMCAD X Version 14.6.10 (7164)

Configuration/System Check Head 835MHz/Area Scan (6x19x1): Measurement grid: dx=10mm, dy=10mm, Maximum value of SAR (measured) = 2.49 W/kg

Configuration/System Check Head 835MHz/Zoom Scan (7x7x7)/Cube 0: Measurement grid: dx=5mm, dy=5mm, dz=5mm, Reference Value = 54.175 V/m; Power Drift = 0.12 dB

Peak SAR (extrapolated) = 3.64 W/kg

SAR(1 g) = 2.43 W/kg; SAR(10 g) = 1.6 W/kg Maximum value of SAR (measured) = 2.61 W/kg

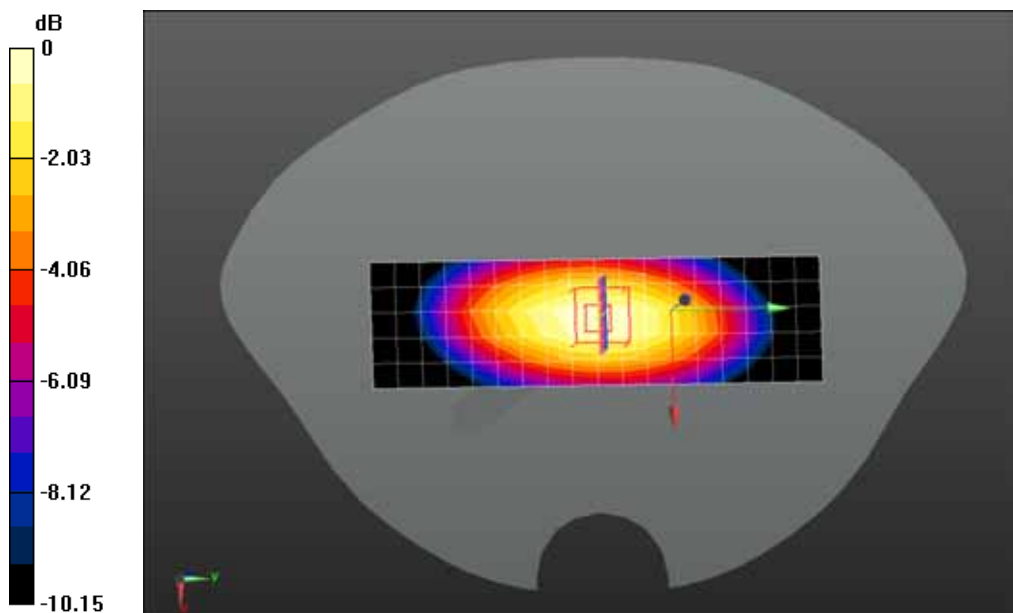

0 dB = 2.61 W/kg = 4.17 dBW/kg

Date/Time: 01-04-2014

Test Laboratory: QuieTek Lab

System Check Body 835MHz

DUT: Dipole 835 MHz D835V2; Type: D835V2

Communication System: CW; Communication System Band: D835 (835.0 MHz); Duty Cycle: 1:1;

Frequency: 835 MHz; Medium parameters used: $f = 835 \text{ MHz}$; $\sigma = 0.99 \text{ S/m}$; $\epsilon_r = 53.72$; $\rho = 1000 \text{ kg/m}^3$;

Phantom section: Flat Section ; Input Power=250mW

Ambient temperature (°C): 21.5, Liquid temperature (°C): 21.0

DASY5 Configuration:

- Probe: EX3DV4 - SN3710; ConvF(9.22, 9.22, 9.22); Calibrated: 04/03/2014;
- Sensor-Surface: 4mm (Mechanical Surface Detection)
- Electronics: DAE4 Sn1220; Calibrated: 22/01/2014
- Phantom: SAM2; Type: SAM; Serial: TP1562
- Measurement SW: DASY52, Version 52.8 (7); SEMCAD X Version 14.6.10 (7164)

Configuration/System Check Body 835MHz/Area Scan (8x17x1): Measurement grid: dx=10mm, dy=10mm

Maximum value of SAR (measured) = 2.53 W/kg

Configuration/System Check Body 835MHz/Zoom Scan (7x7x7)/Cube 0: Measurement grid: dx=5mm, dy=5mm, dz=5mm, Reference Value = 52.328 V/m; Power Drift = 0.03 dB

Peak SAR (extrapolated) = 3.82 W/kg

SAR(1 g) = 2.53 W/kg; SAR(10 g) = 1.65 W/kg Maximum value of SAR (measured) = 2.73 W/kg

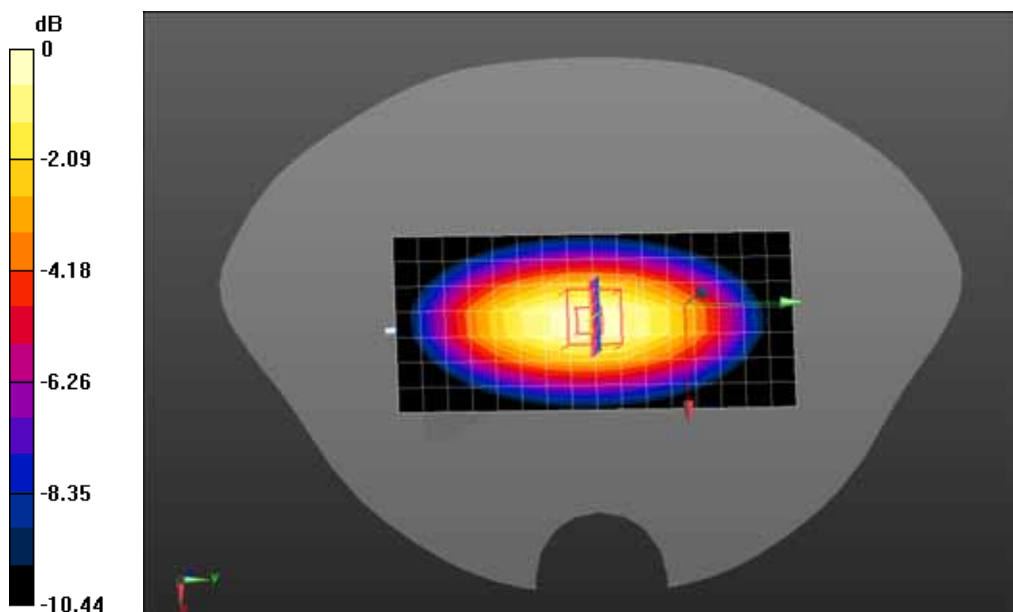

0 dB = 2.73 W/kg = 4.36 dBW/kg

Date/Time: 01-04-2014

Test Laboratory: QuieTek Lab

System Check Head 1900MHz

DUT: Dipole 1900 MHz D1900V2; Type: D1900V2

Communication System: CW; Communication System Band: D1900 (1900.0 MHz); Duty Cycle: 1:1;

Frequency: 1900 MHz; Medium parameters used: $f = 1900$ MHz; $\sigma = 1.47$ S/m; $\epsilon_r = 38.69$; $\rho = 1000$ kg/m³ ;

Phantom section: Flat Section ; Input Power=250mW

Ambient temperature (°C): 21.5, Liquid temperature (°C): 21.0

DASY5 Configuration:

- Probe: EX3DV4 - SN3710; ConvF(7.72, 7.72, 7.72); Calibrated: 04/03/2014;
- Sensor-Surface: 4mm (Mechanical Surface Detection)
- Electronics: DAE4 Sn1220; Calibrated: 22/01/2014
- Phantom: SAM1; Type: SAM; Serial: TP1561
- Measurement SW: DASY52, Version 52.8 (7); SEMCAD X Version 14.6.10 (7164)

Configuration/System Check Head 1900MHz/Area Scan (6x11x1): Measurement grid: dx=10mm, dy=10mm

Maximum value of SAR (measured) = 9.83 W/kg

Configuration/System Check Head 1900MHz/Zoom Scan (7x7x7)/Cube 0: Measurement grid: dx=5mm, dy=5mm, dz=5mm, Reference Value = 85.802 V/m; Power Drift = 0.05 dB

Peak SAR (extrapolated) = 19.0 W/kg

SAR(1 g) = 9.96 W/kg; SAR(10 g) = 5.08 W/kg Maximum value of SAR (measured) = 11.2 W/kg

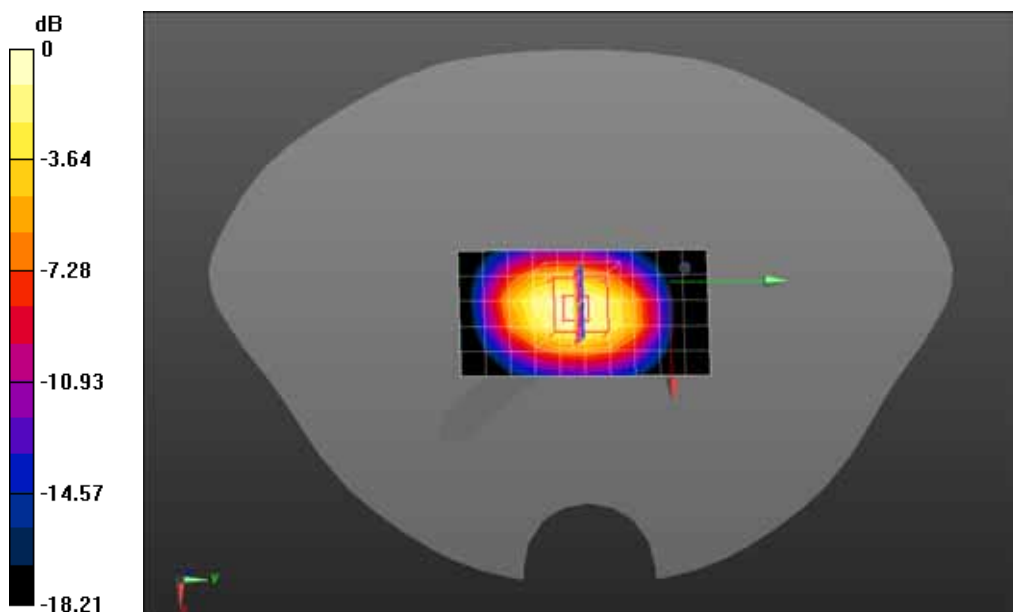

0 dB = 11.2 W/kg = 10.49 dBW/kg

Date/Time: 01-04-2014

Test Laboratory: QuieTek Lab

System Check Body 1900MHz

DUT: Dipole 1900 MHz D1900V2; Type: D1900V2

Communication System: CW; Communication System Band: D1900 (1900.0 MHz); Duty Cycle: 1:1;

Frequency: 1900 MHz; Medium parameters used: $f = 1900$ MHz; $\sigma = 1.56$ S/m; $\epsilon_r = 52.49$; $\rho = 1000$ kg/m³ ;

Phantom section: Flat Section ; Input Power=250mW

Ambient temperature (°C): 21.5, Liquid temperature (°C): 21.0

DASY5 Configuration:

- Probe: EX3DV4 - SN3710; ConvF(7.25, 7.25, 7.25); Calibrated: 04/03/2014;
- Sensor-Surface: 4mm (Mechanical Surface Detection)
- Electronics: DAE4 Sn1220; Calibrated: 22/01/2014
- Phantom: SAM1; Type: SAM; Serial: TP1561
- Measurement SW: DASY52, Version 52.8 (7); SEMCAD X Version 14.6.10 (7164)

Configuration/System Check PCS1900 Body/Area Scan (7x11x1): Measurement grid: dx=10mm, dy=10mm

Maximum value of SAR (measured) = 11.0 W/kg

Configuration/System Check PCS1900 Body/Zoom Scan (7x7x7)/Cube 0: Measurement grid: dx=5mm, dy=5mm, dz=5mm, Reference Value = 84.280 V/m; Power Drift = 0.06 dB

Peak SAR (extrapolated) = 18.2 W/kg

SAR(1 g) = 9.98 W/kg; SAR(10 g) = 5.17 W/kg Maximum value of SAR (measured) = 11.3 W/kg

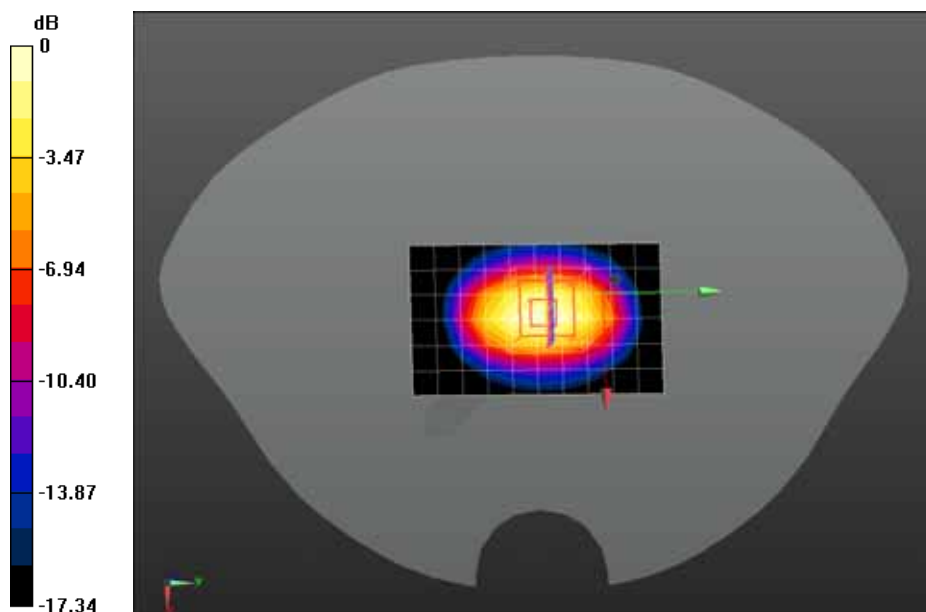

0 dB = 11.3 W/kg = 10.53 dBW/kg

Appendix B. SAR measurement Data

Date/Time: 01-04-2014

Test Laboratory: QuieTek Lab

GSM850 Mid Touch-Left

DUT: SMART PHONE; Type: Syreni 50DC II

Communication System: Generic GSM; Communication System Band: GSM850; Duty Cycle: 1:8.3;

Frequency: 836.4 MHz; Medium parameters used: $f = 836.4$ MHz; $\sigma = 0.89$ S/m; $\epsilon_r = 40.77$; $\rho = 1000$ kg/m³ ;

Phantom section: Left Section

Ambient temperature (°C): 21.5, Liquid temperature (°C): 21.0

DASY5 Configuration:

- Probe: EX3DV4 - SN3710; ConvF(9.56, 9.56, 9.56); Calibrated: 04/03/2014;
- Sensor-Surface: 4mm (Mechanical Surface Detection)
- Electronics: DAE4 Sn1220; Calibrated: 22/01/2014
- Phantom: SAM2; Type: SAM; Serial: TP1562
- Measurement SW: DASY52, Version 52.8 (7); SEMCAD X Version 14.6.10 (7164)

Configuration/GSM850 Mid Touch-Left/Area Scan (7x12x1): Measurement grid: dx=15mm, dy=15mm

Maximum value of SAR (measured) = 0.132 W/kg

Configuration/GSM850 Mid Touch-Left/Zoom Scan (5x5x7)/Cube 0: Measurement grid: dx=8mm,

dy=8mm, dz=5mm, Reference Value = 2.959 V/m; Power Drift = 0.08 dB

Peak SAR (extrapolated) = 0.158 W/kg

SAR(1 g) = 0.131 W/kg; SAR(10 g) = 0.103 W/kg Maximum value of SAR (measured) = 0.137 W/kg

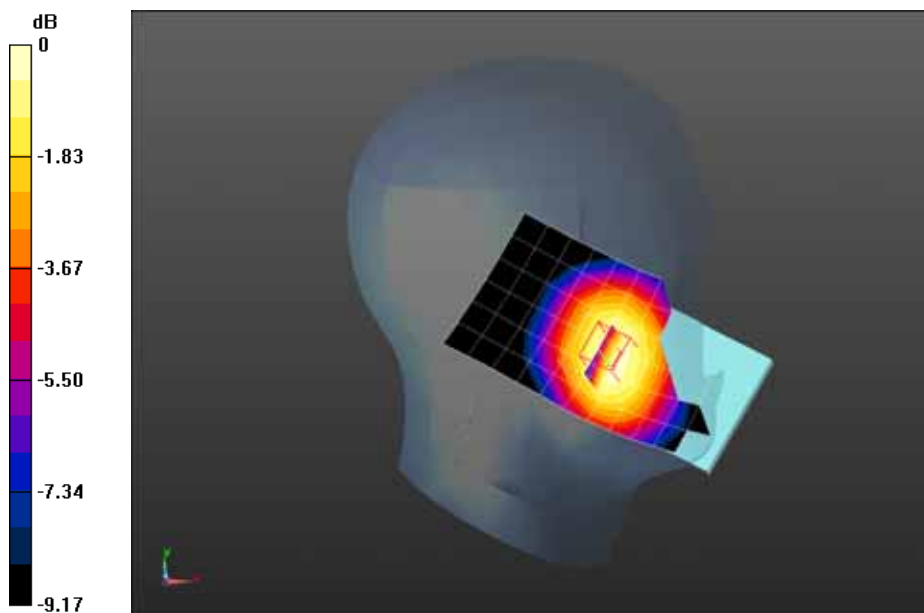

0 dB = 0.137 W/kg = -8.63 dBW/kg

Date/Time: 01-04-2014

Test Laboratory: QuieTek Lab

GSM850 Mid Tilt-Left

DUT: SMART PHONE; Type: Syreni 50DC II

Communication System: Generic GSM; Communication System Band: GSM850; Duty Cycle: 1:8.3;

Frequency: 836.4 MHz; Medium parameters used: $f = 836.4$ MHz; $\sigma = 0.89$ S/m; $\epsilon_r = 40.77$; $\rho = 1000$ kg/m³ ;

Phantom section: Left Section

Ambient temperature (°C): 21.5, Liquid temperature (°C): 21.0

DASY5 Configuration:

- Probe: EX3DV4 - SN3710; ConvF(9.56, 9.56, 9.56); Calibrated: 04/03/2014;
- Sensor-Surface: 4mm (Mechanical Surface Detection)
- Electronics: DAE4 Sn1220; Calibrated: 22/01/2014
- Phantom: SAM2; Type: SAM; Serial: TP1562
- Measurement SW: DASY52, Version 52.8 (7); SEMCAD X Version 14.6.10 (7164)

Configuration/GSM850 Mid Tilt-Left/Area Scan (7x12x1): Measurement grid: dx=15mm, dy=15mm

Maximum value of SAR (measured) = 0.0769 W/kg

Configuration/GSM850 Mid Tilt-Left/Zoom Scan (5x5x7)/Cube 0: Measurement grid: dx=8mm, dy=8mm, dz=5mm, Reference Value = 5.051 V/m; Power Drift = 0.15 dB

Peak SAR (extrapolated) = 0.0900 W/kg

SAR(1 g) = 0.075 W/kg; SAR(10 g) = 0.059 W/kg Maximum value of SAR (measured) = 0.0778 W/kg

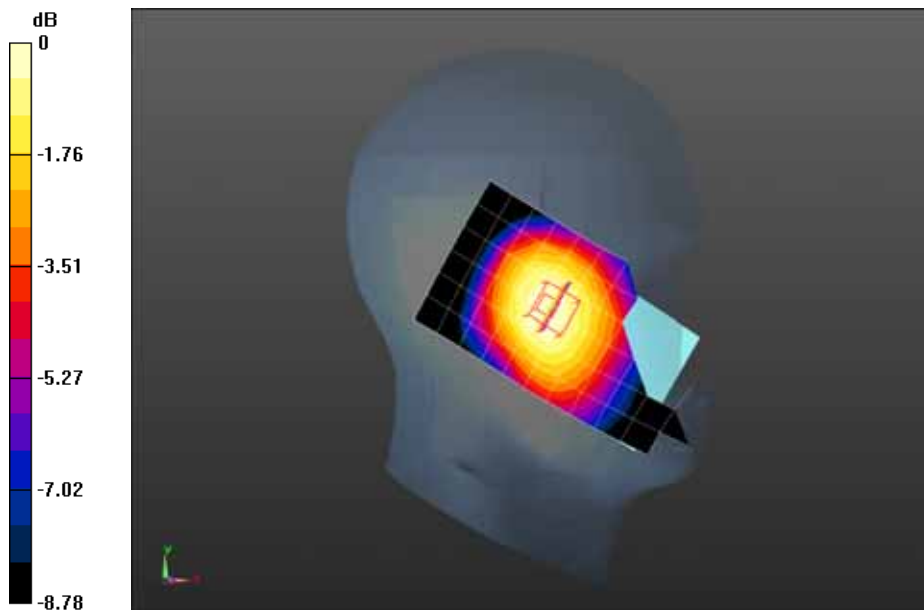

0 dB = 0.0778 W/kg = -11.09 dBW/kg

Date/Time: 01-04-2014

Test Laboratory: QuieTek Lab

GSM850 Mid Touch-Right

DUT: SMART PHONE; Type: Syreni 50DC II

Communication System: Generic GSM; Communication System Band: GSM850; Duty Cycle: 1:8.3;

Frequency: 836.4 MHz; Medium parameters used: $f = 836.4$ MHz; $\sigma = 0.89$ S/m; $\epsilon_r = 40.77$; $\rho = 1000$ kg/m³ ;

Phantom section: Right Section

Ambient temperature (°C): 21.5, Liquid temperature (°C): 21.0

DASY5 Configuration:

- Probe: EX3DV4 - SN3710; ConvF(9.56, 9.56, 9.56); Calibrated: 04/03/2014;
- Sensor-Surface: 4mm (Mechanical Surface Detection)
- Electronics: DAE4 Sn1220; Calibrated: 22/01/2014
- Phantom: SAM2; Type: SAM; Serial: TP1562
- Measurement SW: DASY52, Version 52.8 (7); SEMCAD X Version 14.6.10 (7164)

Configuration/GSM850 Mid Touch-Right/Area Scan (7x12x1): Measurement grid: dx=15mm, dy=15mm

Maximum value of SAR (measured) = 0.139 W/kg

Configuration/GSM850 Mid Touch-Right/Zoom Scan (5x5x7)/Cube 0: Measurement grid: dx=8mm,

dy=8mm, dz=5mm, Reference Value = 2.919 V/m; Power Drift = 0.03 dB

Peak SAR (extrapolated) = 0.166 W/kg

SAR(1 g) = 0.137 W/kg; SAR(10 g) = 0.107 W/kg Maximum value of SAR (measured) = 0.143 W/kg

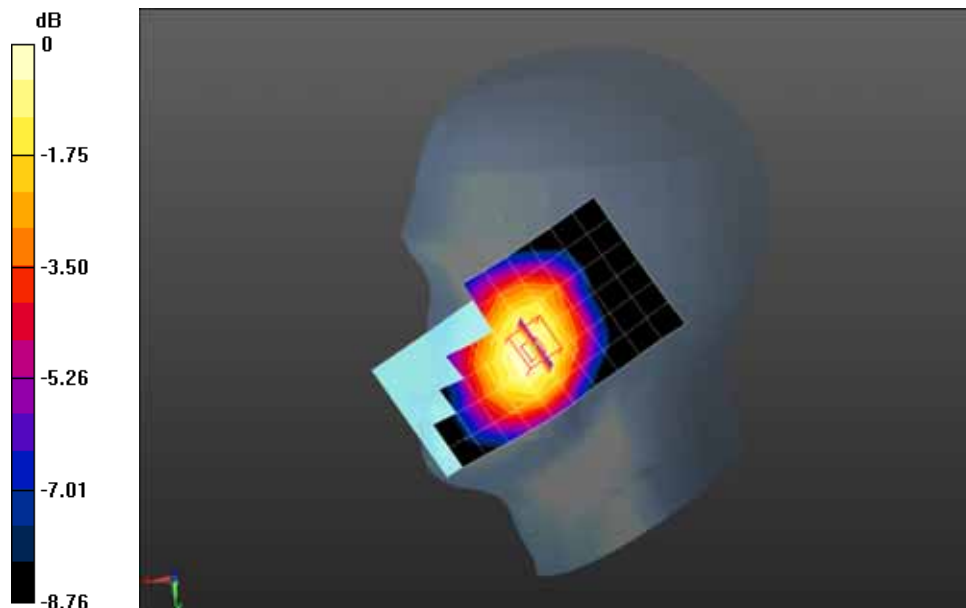

0 dB = 0.143 W/kg = -8.45 dBW/kg

Date/Time: 01-04-2014

Test Laboratory: QuieTek Lab

GSM850 Mid Tilt-Right

DUT: SMART PHONE; Type: Syreni 50DC II

Communication System: Generic GSM; Communication System Band: GSM850; Duty Cycle: 1:8.3;

Frequency: 836.4 MHz; Medium parameters used: $f = 836.4$ MHz; $\sigma = 0.89$ S/m; $\epsilon_r = 40.77$; $\rho = 1000$ kg/m³ ;

Phantom section: Right Section

Ambient temperature (°C): 21.5, Liquid temperature (°C): 21.0

DASY5 Configuration:

- Probe: EX3DV4 - SN3710; ConvF(9.56, 9.56, 9.56); Calibrated: 04/03/2014;
- Sensor-Surface: 4mm (Mechanical Surface Detection)
- Electronics: DAE4 Sn1220; Calibrated: 22/01/2014
- Phantom: SAM2; Type: SAM; Serial: TP1562
- Measurement SW: DASY52, Version 52.8 (7); SEMCAD X Version 14.6.10 (7164)

Configuration/GSM850 Mid Tilt-Right/Area Scan (7x12x1): Measurement grid: dx=15mm, dy=15mm

Maximum value of SAR (measured) = 0.0834 W/kg

Configuration/GSM850 Mid Tilt-Right/Zoom Scan (5x5x7)/Cube 0: Measurement grid: dx=8mm, dy=8mm, dz=5mm, Reference Value = 5.822 V/m; Power Drift = 0.11 dB

Peak SAR (extrapolated) = 0.0980 W/kg

SAR(1 g) = 0.081 W/kg; SAR(10 g) = 0.063 W/kg Maximum value of SAR (measured) = 0.0836 W/kg

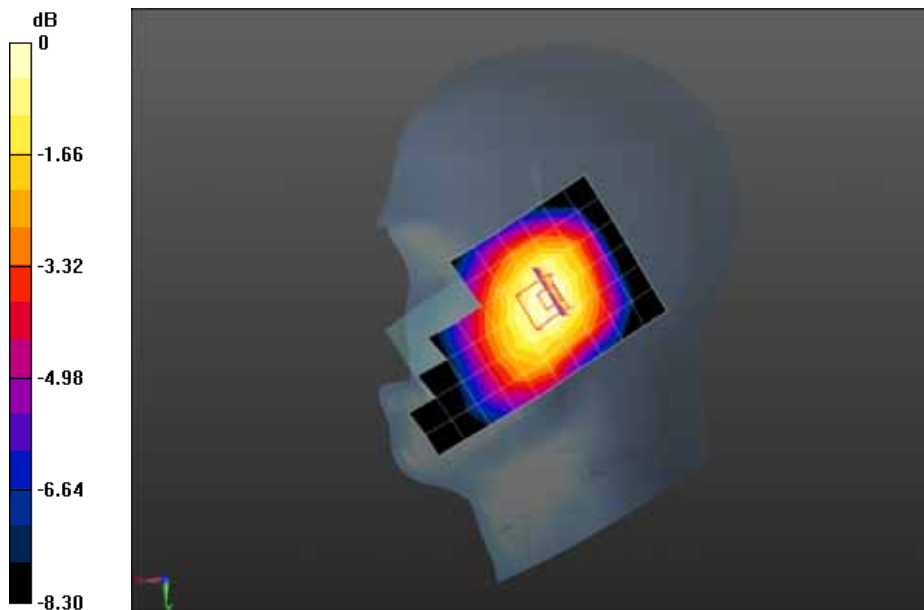

0 dB = 0.0836 W/kg = -10.78 dBW/kg

Date/Time: 01-04-2014

Test Laboratory: QuieTek Lab

GSM850 Mid Touch-Right <SIM 2>

DUT: SMART PHONE; Type: Syreni 50DC II

Communication System: Generic GSM; Communication System Band: GSM850; Duty Cycle: 1:8.3;

Frequency: 836.4 MHz; Medium parameters used: $f = 836.4$ MHz; $\sigma = 0.89$ S/m; $\epsilon_r = 40.77$; $\rho = 1000$ kg/m³ ;

Phantom section: Right Section

Ambient temperature (°C): 21.5, Liquid temperature (°C): 21.0

DASY5 Configuration:

- Probe: EX3DV4 - SN3710; ConvF(9.56, 9.56, 9.56); Calibrated: 04/03/2014;
- Sensor-Surface: 4mm (Mechanical Surface Detection)
- Electronics: DAE4 Sn1220; Calibrated: 22/01/2014
- Phantom: SAM2; Type: SAM; Serial: TP1562
- Measurement SW: DASY52, Version 52.8 (7); SEMCAD X Version 14.6.10 (7164)

Configuration/GSM850 Mid Touch-Right/Area Scan (7x12x1): Measurement grid: dx=15mm, dy=15mm

Maximum value of SAR (measured) = 0.139 W/kg

Configuration/GSM850 Mid Touch-Right/Zoom Scan (5x5x7)/Cube 0: Measurement grid: dx=8mm, dy=8mm, dz=5mm, Reference Value = 2.919 V/m; Power Drift = 0.13 dB

Peak SAR (extrapolated) = 0.166 W/kg

SAR(1 g) = 0.137 W/kg; SAR(10 g) = 0.107 W/kg Maximum value of SAR (measured) = 0.143 W/kg

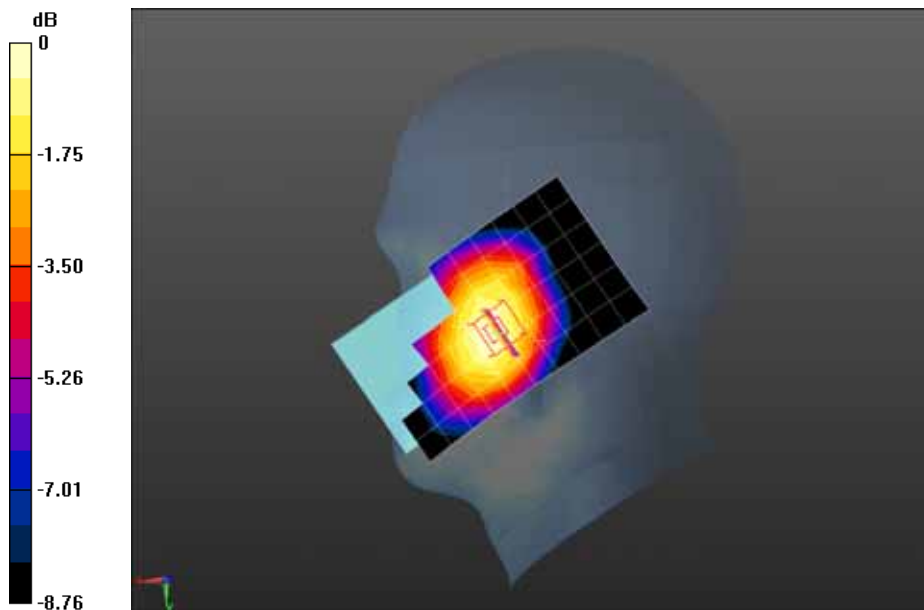

0 dB = 0.143 W/kg = -8.45 dBW/kg

Date/Time: 01-04-2014

Test Laboratory: QuieTek Lab

GSM850 Mid Body-Back

DUT: SMART PHONE; Type: Syreni 50DC II

Communication System: Generic GSM; Communication System Band: GSM850; Duty Cycle: 1:8.3;

Frequency: 836.4 MHz; Medium parameters used: $f = 836.4$ MHz; $\sigma = 0.99$ S/m; $\epsilon_r = 53.71$; $\rho = 1000$ kg/m³ ;

Phantom section: Flat Section

Ambient temperature (°C): 21.5, Liquid temperature (°C): 21.0

DASY5 Configuration:

- Probe: EX3DV4 - SN3710; ConvF(9.22, 9.22, 9.22); Calibrated: 04/03/2014;
- Sensor-Surface: 4mm (Mechanical Surface Detection)
- Electronics: DAE4 Sn1220; Calibrated: 22/01/2014
- Phantom: SAM2; Type: SAM; Serial: TP1562
- Measurement SW: DASY52, Version 52.8 (7); SEMCAD X Version 14.6.10 (7164)

Configuration/GSM850 Mid Body-Back/Area Scan (7x12x1): Measurement grid: dx=15mm, dy=15mm

Maximum value of SAR (measured) = 0.444 W/kg

Configuration/GSM850 Mid Body-Back/Zoom Scan (5x5x7)/Cube 0: Measurement grid: dx=8mm, dy=8mm, dz=5mm, Reference Value = 16.821 V/m; Power Drift = 0.06 dB

Peak SAR (extrapolated) = 0.542 W/kg

SAR(1 g) = 0.437 W/kg; SAR(10 g) = 0.337 W/kg Maximum value of SAR (measured) = 0.455 W/kg

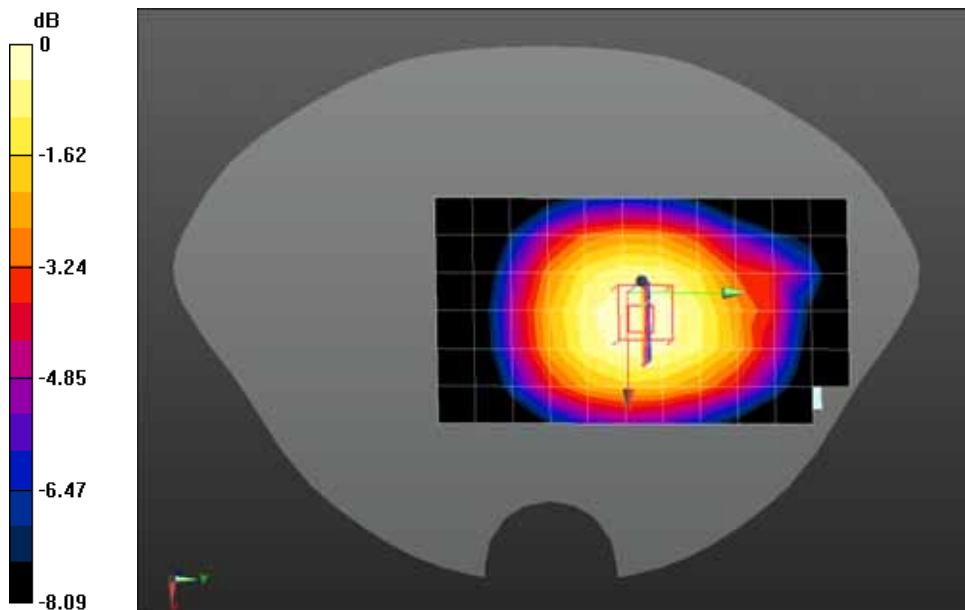

0 dB = 0.455 W/kg = -3.42 dBW/kg

Date/Time: 01-04-2014

Test Laboratory: QuieTek Lab

GPRS850 Low Body-Back(4up)

DUT: SMART PHONE; Type: Syreni 50DC II

Communication System: GPRS/EGPRS-4 Slot; Communication System Band: GSM 850; Duty Cycle: 1:2.1 ;
 Frequency: 824.2 MHz; Medium parameters used: $f = 824.2$ MHz; $\sigma = 0.98$ S/m; $\epsilon_r = 53.83$; $\rho = 1000$ kg/m³ ;
 Phantom section: Flat Section

Ambient temperature (°C): 21.5, Liquid temperature (°C): 21.0

DASY5 Configuration:

- Probe: EX3DV4 - SN3710; ConvF(9.22, 9.22, 9.22); Calibrated: 04/03/2014;
- Sensor-Surface: 4mm (Mechanical Surface Detection)
- Electronics: DAE4 Sn1220; Calibrated: 22/01/2014
- Phantom: SAM2; Type: SAM; Serial: TP1562
- Measurement SW: DASY52, Version 52.8 (7); SEMCAD X Version 14.6.10 (7164)

Configuration/GPRS850 Low Body-Back/Area Scan (7x12x1): Measurement grid: dx=15mm, dy=15mm

Maximum value of SAR (measured) = 0.631 W/kg

Configuration/GPRS850 Low Body-Back/Zoom Scan (5x5x7)/Cube 0: Measurement grid: dx=8mm, dy=8mm, dz=5mm, Reference Value = 20.339 V/m; Power Drift = 0.16 dB

Peak SAR (extrapolated) = 0.840 W/kg

SAR(1 g) = 0.661 W/kg; SAR(10 g) = 0.508 W/kg Maximum value of SAR (measured) = 0.691 W/kg

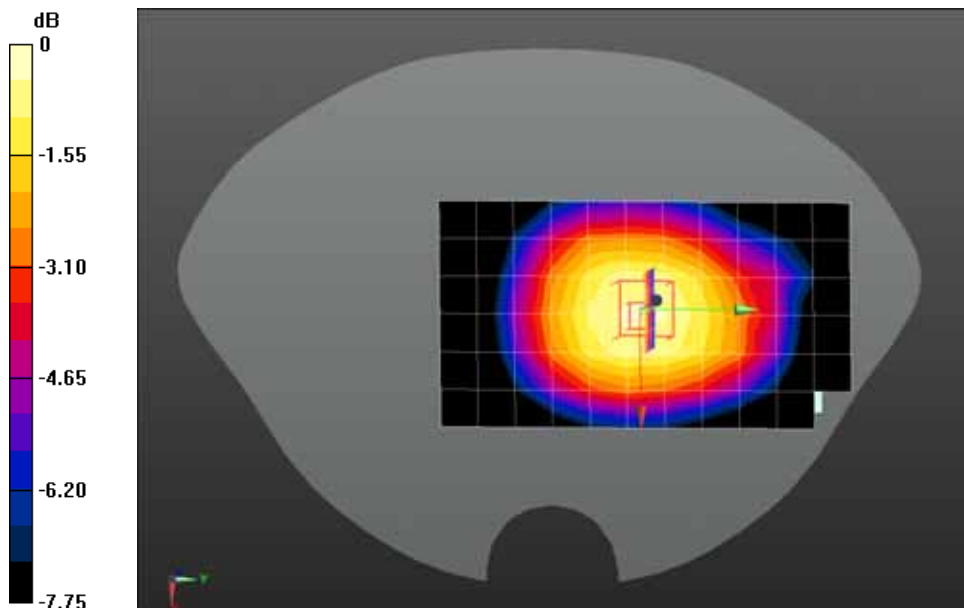

0 dB = 0.691 W/kg = -1.61 dBW/kg

Date/Time: 01-04-2014

Test Laboratory: QuieTek Lab

GPRS850 Mid Body-Back(4up)

DUT: SMART PHONE; Type: Syreni 50DC II

Communication System: GPRS/EGPRS-4 Slot; Communication System Band: GSM 850; Duty Cycle: 1:2.1 ;
 Frequency: 836.4 MHz; Medium parameters used: $f = 836.4$ MHz; $\sigma = 0.99$ S/m; $\epsilon_r = 53.71$; $\rho = 1000$ kg/m³ ;
 Phantom section: Flat Section

Ambient temperature (°C): 21.5, Liquid temperature (°C): 21.0

DASY5 Configuration:

- Probe: EX3DV4 - SN3710; ConvF(9.22, 9.22, 9.22); Calibrated: 04/03/2014;
- Sensor-Surface: 4mm (Mechanical Surface Detection)
- Electronics: DAE4 Sn1220; Calibrated: 22/01/2014
- Phantom: SAM2; Type: SAM; Serial: TP1562
- Measurement SW: DASY52, Version 52.8 (7); SEMCAD X Version 14.6.10 (7164)

Configuration/GPRS850 Mid Body-Back/Area Scan (7x12x1): Measurement grid: dx=15mm, dy=15mm

Maximum value of SAR (measured) = 0.840 W/kg

Configuration/GPRS850 Mid Body-Back/Zoom Scan (5x5x7)/Cube 0: Measurement grid: dx=8mm, dy=8mm, dz=5mm, Reference Value = 23.130 V/m; Power Drift = 0.14 dB

Peak SAR (extrapolated) = 1.03 W/kg

SAR(1 g) = 0.822 W/kg; SAR(10 g) = 0.634 W/kg Maximum value of SAR (measured) = 0.856 W/kg

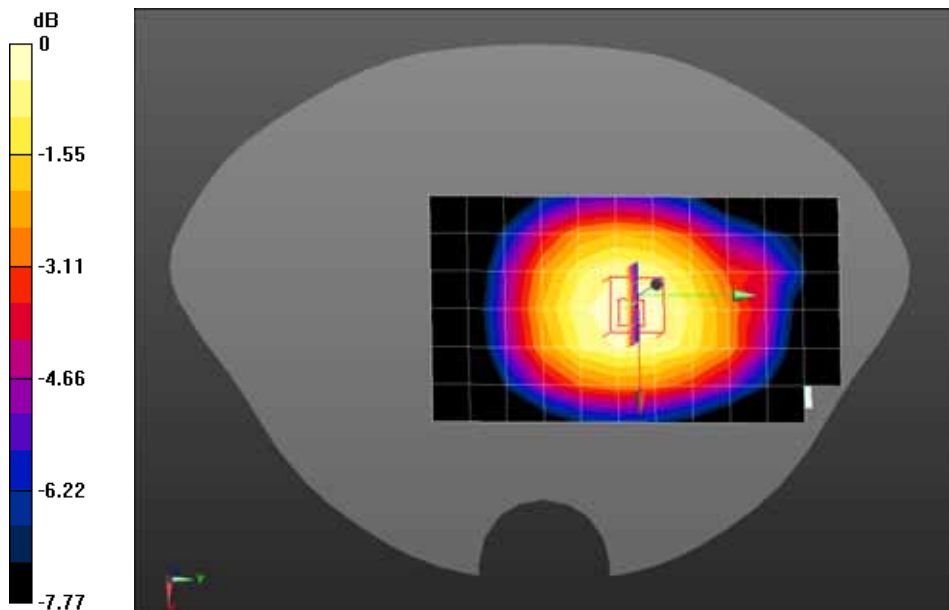

0 dB = 0.856 W/kg = -0.68 dBW/kg

Date/Time: 01-04-2014

Test Laboratory: QuieTek Lab

GPRS850 High Body-Back(4up)

DUT: SMART PHONE; Type: Syreni 50DC II

Communication System: GPRS/EGPRS-4 Slot; Communication System Band: GSM 850; Duty Cycle: 1:2.1 ;

Frequency: 848.8 MHz; Medium parameters used: $f = 848.8 \text{ MHz}$; $\sigma = 1 \text{ S/m}$; $\epsilon_r = 53.58$; $\rho = 1000 \text{ kg/m}^3$;

Phantom section: Flat Section

Ambient temperature (°C): 21.5, Liquid temperature (°C): 21.0

DASY5 Configuration:

- Probe: EX3DV4 - SN3710; ConvF(9.22, 9.22, 9.22); Calibrated: 04/03/2014;
- Sensor-Surface: 4mm (Mechanical Surface Detection)
- Electronics: DAE4 Sn1220; Calibrated: 22/01/2014
- Phantom: SAM2; Type: SAM; Serial: TP1562
- Measurement SW: DASY52, Version 52.8 (7); SEMCAD X Version 14.6.10 (7164)

Configuration/GPRS850 High Body-Back/Area Scan (7x12x1): Measurement grid: dx=15mm, dy=15mm

Maximum value of SAR (measured) = 1.09 W/kg

Configuration/GPRS850 High Body-Back/Zoom Scan (5x5x7)/Cube 0: Measurement grid: dx=8mm,

dy=8mm, dz=5mm, Reference Value = 21.085 V/m; Power Drift = -0.05 dB

Peak SAR (extrapolated) = 1.29 W/kg

SAR(1 g) = 1.04 W/kg; SAR(10 g) = 0.799 W/kg Maximum value of SAR (measured) = 1.08 W/kg

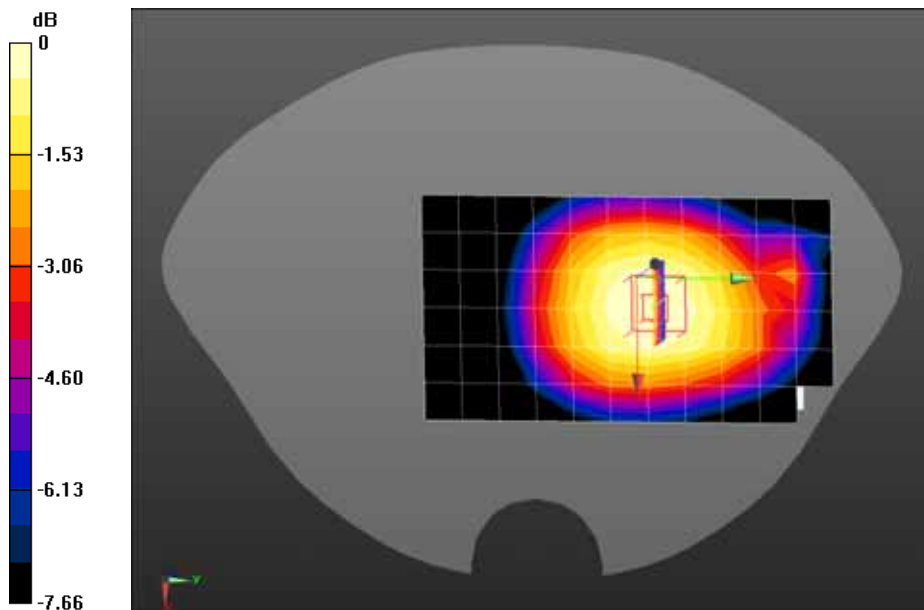

0 dB = 1.08 W/kg = 0.33 dBW/kg

Z-Axis Plot

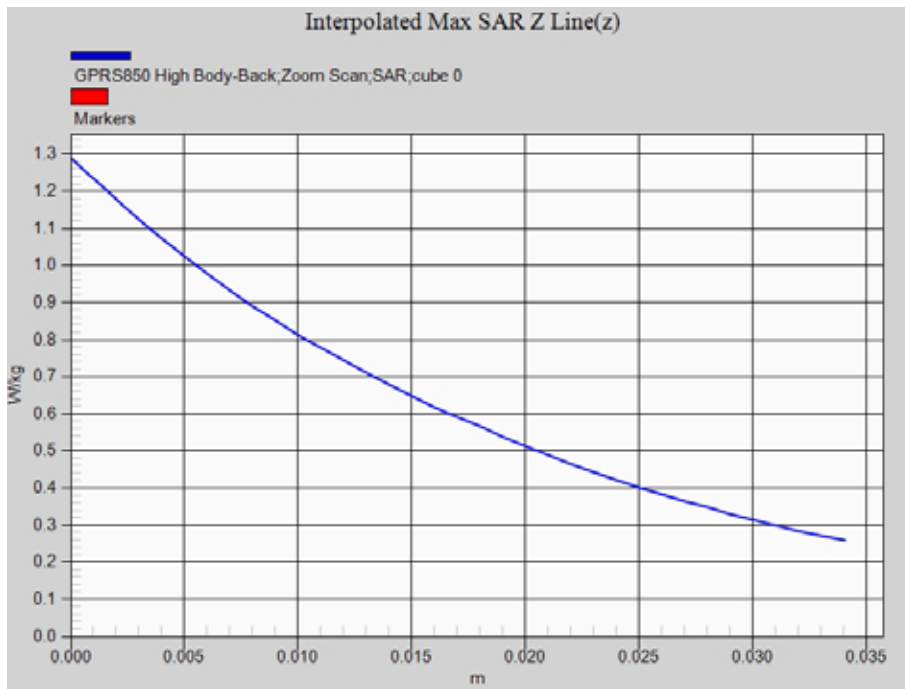

Date/Time: 01-04-2014

Test Laboratory: QuieTek Lab

GPRS850 High Body-Back(4up)*

DUT: SMART PHONE; Type: Syreni 50DC II

Communication System: GPRS/EGPRS-4 Slot; Communication System Band: GSM 850; Duty Cycle: 1:2.1 ;

Frequency: 848.8 MHz; Medium parameters used: $f = 848.8 \text{ MHz}$; $\sigma = 1 \text{ S/m}$; $\epsilon_r = 53.58$; $\rho = 1000 \text{ kg/m}^3$;

Phantom section: Flat Section

Ambient temperature (°C): 21.5, Liquid temperature (°C): 21.0

DASY5 Configuration:

- Probe: EX3DV4 - SN3710; ConvF(9.22, 9.22, 9.22); Calibrated: 04/03/2014;
- Sensor-Surface: 4mm (Mechanical Surface Detection)
- Electronics: DAE4 Sn1220; Calibrated: 22/01/2014
- Phantom: SAM2; Type: SAM; Serial: TP1562
- Measurement SW: DASY52, Version 52.8 (7); SEMCAD X Version 14.6.10 (7164)

Configuration/GPRS850 High Body-Back/Area Scan (7x12x1): Measurement grid: dx=15mm, dy=15mm

Maximum value of SAR (measured) = 1.07 W/kg

Configuration/GPRS850 High Body-Back/Zoom Scan (5x5x7)/Cube 0: Measurement grid: dx=8mm,

dy=8mm, dz=5mm, Reference Value = 20.782 V/m; Power Drift = 0.17 dB

Peak SAR (extrapolated) = 1.30 W/kg

SAR(1 g) = 1.02 W/kg; SAR(10 g) = 0.789 W/kg Maximum value of SAR (measured) = 1.06 W/kg

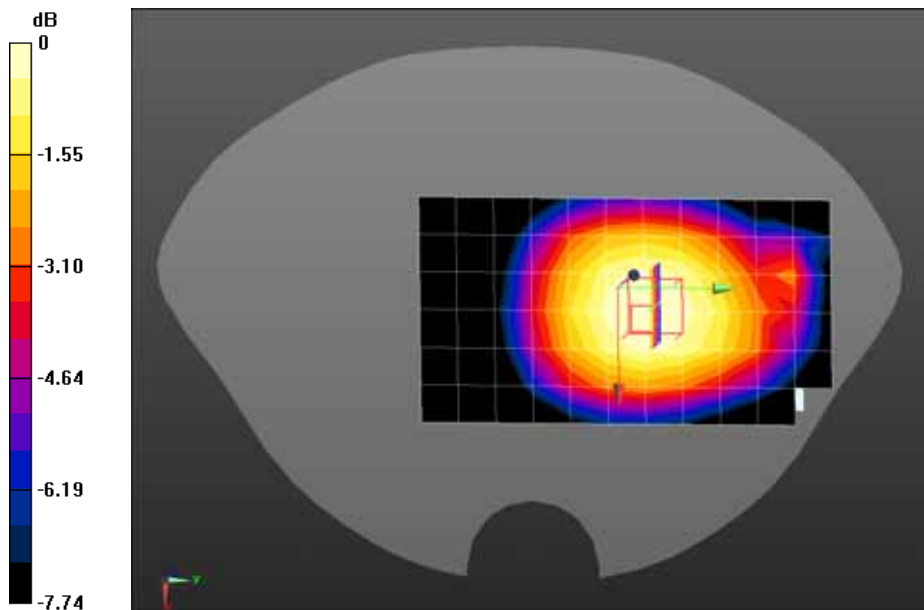

0 dB = 1.06 W/kg = 0.25 dBW/kg

Date/Time: 01-04-2014

Test Laboratory: QuieTek Lab

GPRS850 Mid Body-Front(4up)

DUT: SMART PHONE; Type: Syreni 50DC II

Communication System: GPRS/EGPRS-4 Slot; Communication System Band: GSM 850; Duty Cycle: 1:2.1 ;
 Frequency: 836.4 MHz; Medium parameters used: $f = 836.4$ MHz; $\sigma = 0.99$ S/m; $\epsilon_r = 53.71$; $\rho = 1000$ kg/m³ ;
 Phantom section: Flat Section

Ambient temperature (°C): 21.5, Liquid temperature (°C): 21.0

DASY5 Configuration:

- Probe: EX3DV4 - SN3710; ConvF(9.22, 9.22, 9.22); Calibrated: 04/03/2014;
- Sensor-Surface: 4mm (Mechanical Surface Detection)
- Electronics: DAE4 Sn1220; Calibrated: 22/01/2014
- Phantom: SAM2; Type: SAM; Serial: TP1562
- Measurement SW: DASY52, Version 52.8 (7); SEMCAD X Version 14.6.10 (7164)

Configuration/GPRS850 Mid Body-Front/Area Scan (7x12x1): Measurement grid: dx=15mm, dy=15mm

Maximum value of SAR (measured) = 0.180 W/kg

Configuration/GPRS850 Mid Body-Front/Zoom Scan (5x5x7)/Cube 0: Measurement grid: dx=8mm, dy=8mm, dz=5mm, Reference Value = 10.359 V/m; Power Drift = 0.17 dB

Peak SAR (extrapolated) = 0.242 W/kg

SAR(1 g) = 0.182 W/kg; SAR(10 g) = 0.143 W/kg Maximum value of SAR (measured) = 0.190 W/kg

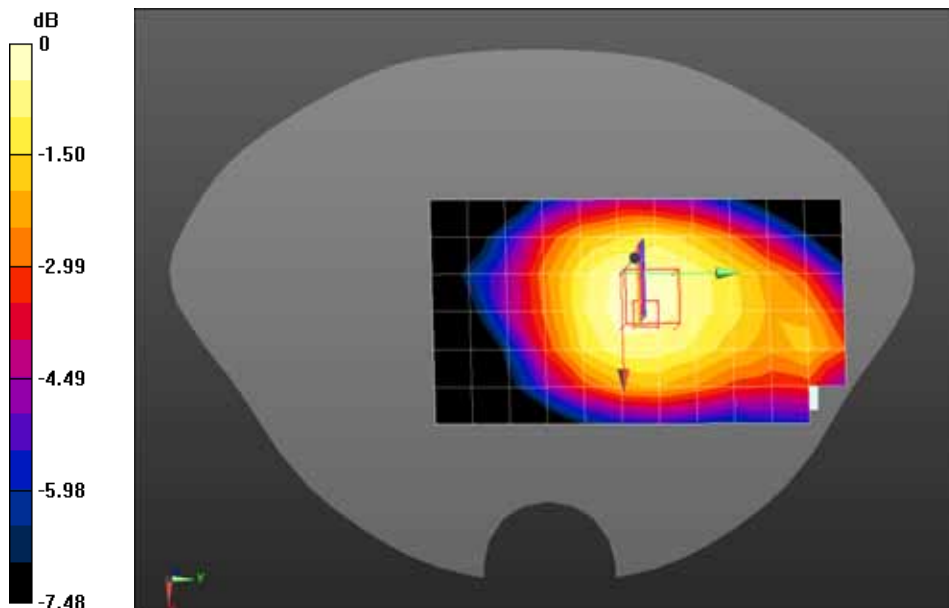

0 dB = 0.190 W/kg = -7.21 dBW/kg

Date/Time: 01-04-2014

Test Laboratory: QuieTek Lab

GPRS850 Mid Body-Right side(4up)

DUT: SMART PHONE; Type: Syreni 50DC II

Communication System: GPRS/EGPRS-4 Slot; Communication System Band: GSM 850; Duty Cycle: 1:2.1 ;
 Frequency: 836.4 MHz; Medium parameters used: $f = 836.4$ MHz; $\sigma = 0.99$ S/m; $\epsilon_r = 53.71$; $\rho = 1000$ kg/m³ ;
 Phantom section: Flat Section

Ambient temperature (°C): 21.5, Liquid temperature (°C): 21.0

DASY5 Configuration:

- Probe: EX3DV4 - SN3710; ConvF(9.22, 9.22, 9.22); Calibrated: 04/03/2014;
- Sensor-Surface: 4mm (Mechanical Surface Detection)
- Electronics: DAE4 Sn1220; Calibrated: 22/01/2014
- Phantom: SAM2; Type: SAM; Serial: TP1562
- Measurement SW: DASY52, Version 52.8 (7); SEMCAD X Version 14.6.10 (7164)

Configuration/GPRS850 Mid Body-Right side/Area Scan (5x12x1): Measurement grid: dx=15mm, dy=15mm

Maximum value of SAR (measured) = 0.210 W/kg

Configuration/GPRS850 Mid Body-Right side/Zoom Scan (5x5x7)/Cube 0: Measurement grid: dx=8mm, dy=8mm, dz=5mm, Reference Value = 12.451 V/m; Power Drift = 0.03 dB

Peak SAR (extrapolated) = 0.279 W/kg

SAR(1 g) = 0.200 W/kg; SAR(10 g) = 0.141 W/kg Maximum value of SAR (measured) = 0.211 W/kg

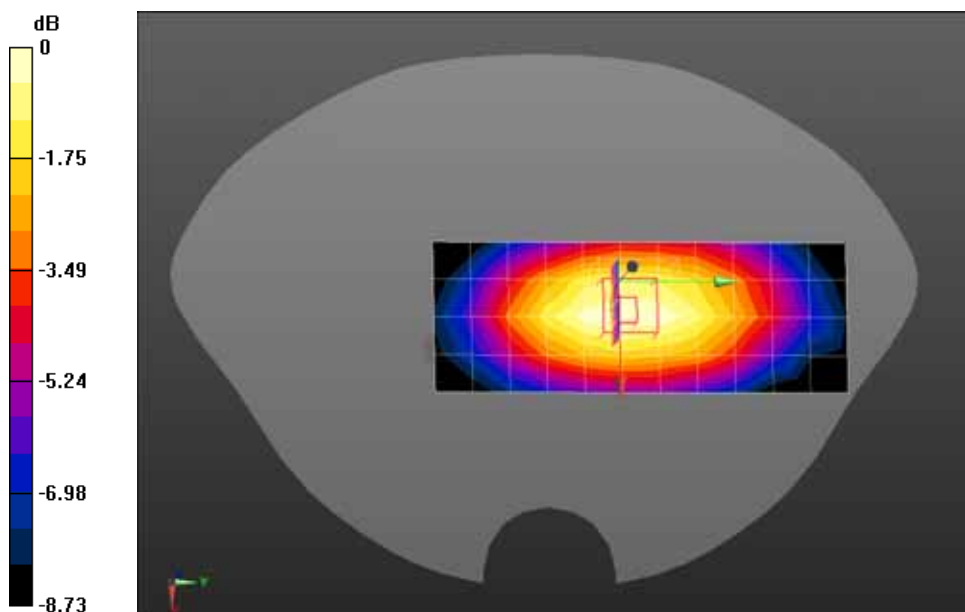

0 dB = 0.211 W/kg = -6.76 dBW/kg

Date/Time: 01-04-2014

Test Laboratory: QuieTek Lab

GPRS850 Mid Body-Left side(4up)

DUT: SMART PHONE; Type: Syreni 50DC II

Communication System: GPRS/EGPRS-4 Slot; Communication System Band: GSM 850; Duty Cycle: 1:2.1 ;
 Frequency: 836.4 MHz; Medium parameters used: $f = 836.4$ MHz; $\sigma = 0.99$ S/m; $\epsilon_r = 53.71$; $\rho = 1000$ kg/m³ ;
 Phantom section: Flat Section

Ambient temperature (°C): 21.5, Liquid temperature (°C): 21.0

DASY5 Configuration:

- Probe: EX3DV4 - SN3710; ConvF(9.22, 9.22, 9.22); Calibrated: 04/03/2014;
- Sensor-Surface: 4mm (Mechanical Surface Detection)
- Electronics: DAE4 Sn1220; Calibrated: 22/01/2014
- Phantom: SAM2; Type: SAM; Serial: TP1562
- Measurement SW: DASY52, Version 52.8 (7); SEMCAD X Version 14.6.10 (7164)

Configuration/GPRS850 Mid Body-Left side/Area Scan (5x12x1): Measurement grid: dx=15mm, dy=15mm

Maximum value of SAR (measured) = 0.242 W/kg

Configuration/GPRS850 Mid Body-Left side/Zoom Scan (5x5x7)/Cube 0: Measurement grid: dx=8mm, dy=8mm, dz=5mm, Reference Value = 13.424 V/m; Power Drift = -0.02 dB

Peak SAR (extrapolated) = 0.316 W/kg

SAR(1 g) = 0.229 W/kg; SAR(10 g) = 0.162 W/kg Maximum value of SAR (measured) = 0.244 W/kg

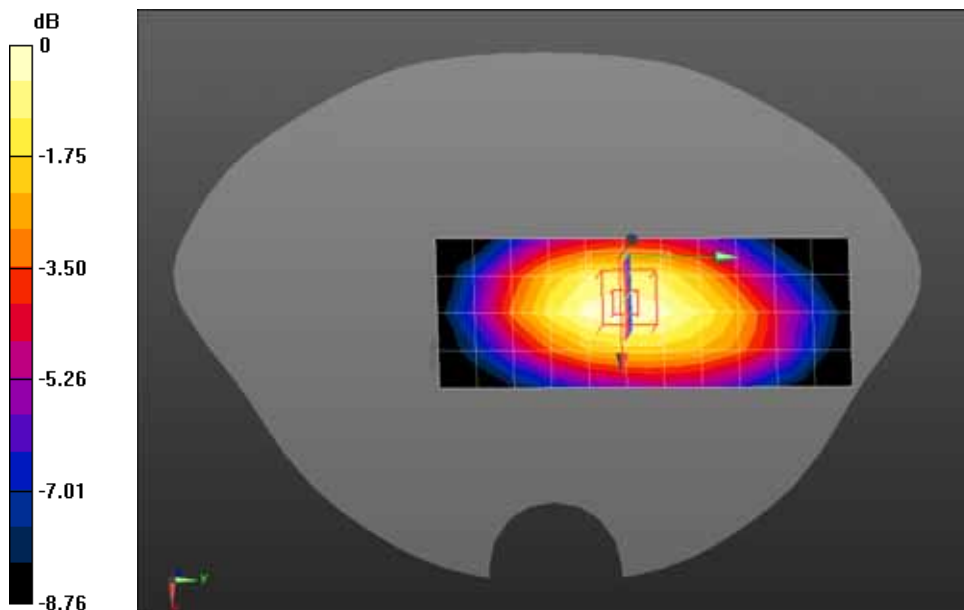

0 dB = 0.244 W/kg = -6.13 dBW/kg

Date/Time: 01-04-2014

Test Laboratory: QuieTek Lab

GPRS850 Mid Body-Bottom(4up)

DUT: SMART PHONE; Type: Syreni 50DC II

Communication System: GPRS/EGPRS-4 Slot; Communication System Band: GSM 850; Duty Cycle: 1:2.1 ;
 Frequency: 836.4 MHz; Medium parameters used: $f = 836.4$ MHz; $\sigma = 0.99$ S/m; $\epsilon_r = 53.71$; $\rho = 1000$ kg/m³ ;
 Phantom section: Flat Section

Ambient temperature (°C): 21.5, Liquid temperature (°C): 21.0

DASY5 Configuration:

- Probe: EX3DV4 - SN3710; ConvF(9.22, 9.22, 9.22); Calibrated: 04/03/2014;
- Sensor-Surface: 4mm (Mechanical Surface Detection)
- Electronics: DAE4 Sn1220; Calibrated: 22/01/2014
- Phantom: SAM2; Type: SAM; Serial: TP1562
- Measurement SW: DASY52, Version 52.8 (7); SEMCAD X Version 14.6.10 (7164)

Configuration/GPRS850 Mid Body-Bottom/Area Scan (5x7x1): Measurement grid: dx=15mm, dy=15mm

Maximum value of SAR (measured) = 0.137 W/kg

Configuration/GPRS850 Mid Body-Bottom/Zoom Scan (5x5x7)/Cube 0: Measurement grid: dx=8mm, dy=8mm, dz=5mm, Reference Value = 11.250 V/m; Power Drift = -0.13 dB

Peak SAR (extrapolated) = 0.225 W/kg

SAR(1 g) = 0.130 W/kg; SAR(10 g) = 0.080 W/kg Maximum value of SAR (measured) = 0.139 W/kg

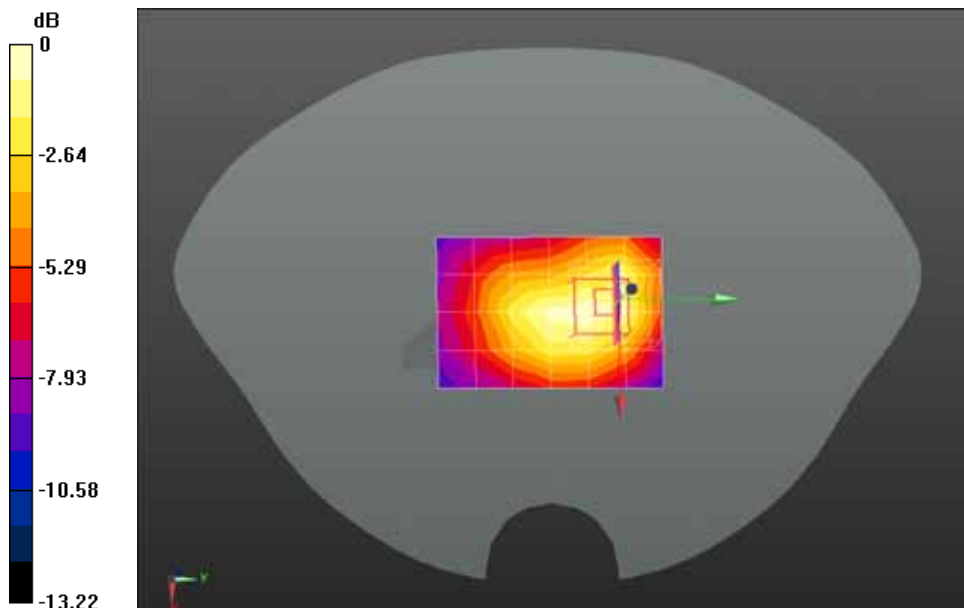

0 dB = 0.139 W/kg = -8.57 dBW/kg

Date/Time: 01-04-2014

Test Laboratory: QuieTek Lab

PCS1900 Mid Touch-Left

DUT: SMART PHONE; Type: Syreni 50DC II

Communication System: Generic GSM; Communication System Band: PCS1900; Duty Cycle: 1:8.3;

Frequency: 1880 MHz; Medium parameters used: $f = 1880$ MHz; $\sigma = 1.45$ S/m; $\epsilon_r = 38.78$; $\rho = 1000$ kg/m³ ;

Phantom section: Left Section

Ambient temperature (°C): 21.5, Liquid temperature (°C): 21.0

DASY5 Configuration:

- Probe: EX3DV4 - SN3710; ConvF(7.72, 7.72, 7.72); Calibrated: 04/03/2014;
- Sensor-Surface: 4mm (Mechanical Surface Detection)
- Electronics: DAE4 Sn1220; Calibrated: 22/01/2014
- Phantom: SAM1; Type: SAM; Serial: TP1561
- Measurement SW: DASY52, Version 52.8 (7); SEMCAD X Version 14.6.10 (7164)

Configuration/PCS1900 Mid Touch-Left/Area Scan (7x12x1): Measurement grid: dx=15mm, dy=15mm

Maximum value of SAR (measured) = 0.243 W/kg

Configuration/PCS1900 Mid Touch-Left/Zoom Scan (5x5x7)/Cube 0: Measurement grid: dx=8mm, dy=8mm, dz=5mm, Reference Value = 4.985 V/m; Power Drift = 0.07 dB

Peak SAR (extrapolated) = 0.441 W/kg

SAR(1 g) = 0.277 W/kg; SAR(10 g) = 0.167 W/kg Maximum value of SAR (measured) = 0.301 W/kg

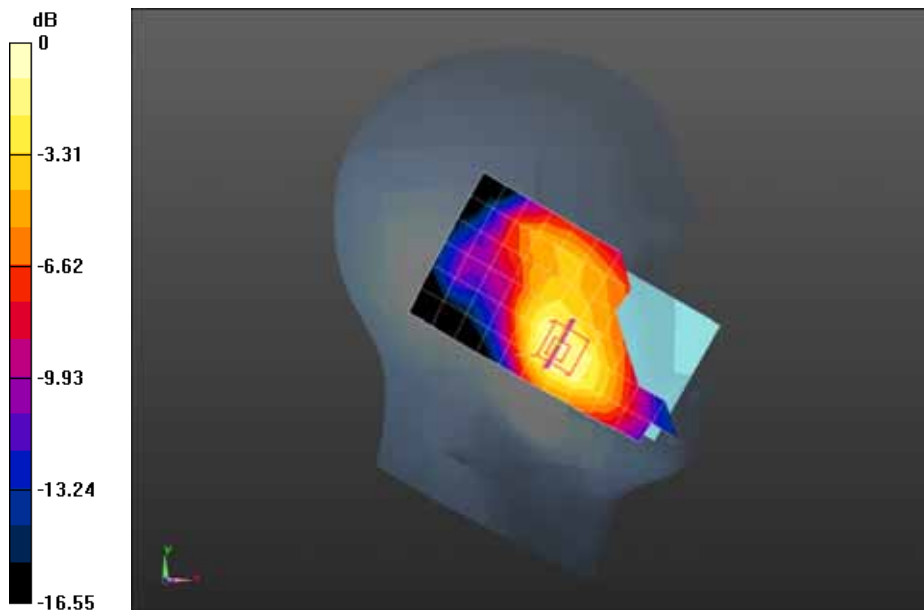

0 dB = 0.301 W/kg = -5.21 dBW/kg

Date/Time: 01-04-2014

Test Laboratory: QuieTek Lab

PCS1900 Mid Tilt-Left

DUT: SMART PHONE; Type: Syreni 50DC II

Communication System: Generic GSM; Communication System Band: PCS1900; Duty Cycle: 1:8.3;

Frequency: 1880 MHz; Medium parameters used: $f = 1880$ MHz; $\sigma = 1.45$ S/m; $\epsilon_r = 38.78$; $\rho = 1000$ kg/m³ ;

Phantom section: Left Section

Ambient temperature (°C): 21.5, Liquid temperature (°C): 21.0

DASY5 Configuration:

- Probe: EX3DV4 - SN3710; ConvF(7.72, 7.72, 7.72); Calibrated: 04/03/2014;
- Sensor-Surface: 4mm (Mechanical Surface Detection)
- Electronics: DAE4 Sn1220; Calibrated: 22/01/2014
- Phantom: SAM1; Type: SAM; Serial: TP1561
- Measurement SW: DASY52, Version 52.8 (7); SEMCAD X Version 14.6.10 (7164)

Configuration/PCS1900 Mid Tilt-Left/Area Scan (7x12x1): Measurement grid: dx=15mm, dy=15mm

Maximum value of SAR (measured) = 0.0758 W/kg

Configuration/PCS1900 Mid Tilt-Left/Zoom Scan (5x5x7)/Cube 0: Measurement grid: dx=8mm, dy=8mm, dz=5mm, Reference Value = 8.003 V/m; Power Drift = -0.10 dB

Peak SAR (extrapolated) = 0.131 W/kg

SAR(1 g) = 0.081 W/kg; SAR(10 g) = 0.048 W/kg Maximum value of SAR (measured) = 0.0899 W/kg

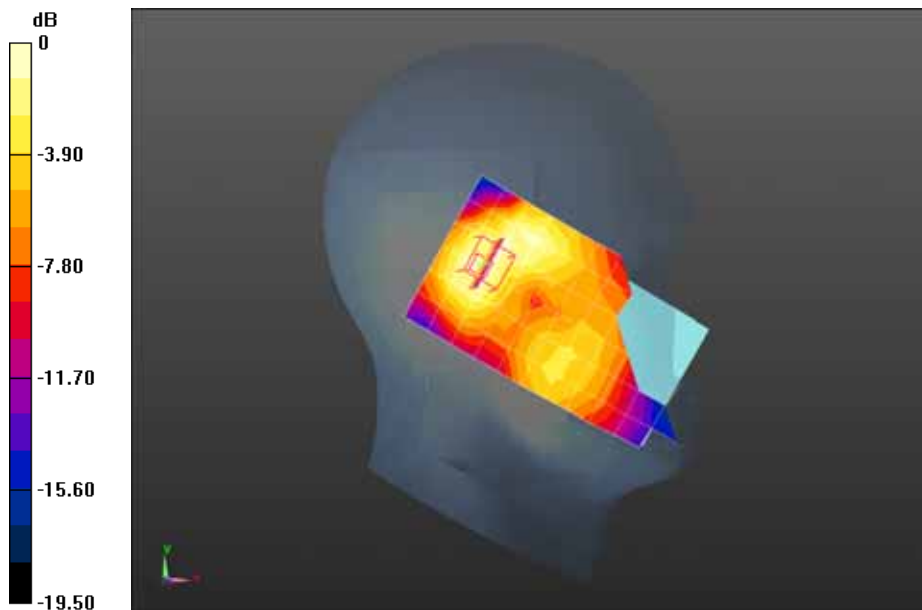

0 dB = 0.0899 W/kg = -10.46 dBW/kg

Date/Time: 01-04-2014

Test Laboratory: QuieTek Lab

PCS1900 Mid Touch-Right

DUT: SMART PHONE; Type: Syreni 50DC II

Communication System: Generic GSM; Communication System Band: PCS1900; Duty Cycle: 1:8.3;

Frequency: 1880 MHz; Medium parameters used: $f = 1880$ MHz; $\sigma = 1.45$ S/m; $\epsilon_r = 38.78$; $\rho = 1000$ kg/m³ ;

Phantom section: Right Section

Ambient temperature (°C): 21.5, Liquid temperature (°C): 21.0

DASY5 Configuration:

- Probe: EX3DV4 - SN3710; ConvF(7.72, 7.72, 7.72); Calibrated: 04/03/2014;
- Sensor-Surface: 4mm (Mechanical Surface Detection)
- Electronics: DAE4 Sn1220; Calibrated: 22/01/2014
- Phantom: SAM1; Type: SAM; Serial: TP1561
- Measurement SW: DASY52, Version 52.8 (7); SEMCAD X Version 14.6.10 (7164)

Configuration/PCS1900 Mid Touch-Right/Area Scan (7x12x1): Measurement grid: dx=15mm, dy=15mm

Maximum value of SAR (measured) = 0.137 W/kg

Configuration/PCS1900 Mid Touch-Right/Zoom Scan (5x5x7)/Cube 0: Measurement grid: dx=8mm,

dy=8mm, dz=5mm, Reference Value = 5.586 V/m; Power Drift = 0.11 dB

Peak SAR (extrapolated) = 0.193 W/kg

SAR(1 g) = 0.128 W/kg; SAR(10 g) = 0.082 W/kg Maximum value of SAR (measured) = 0.135 W/kg

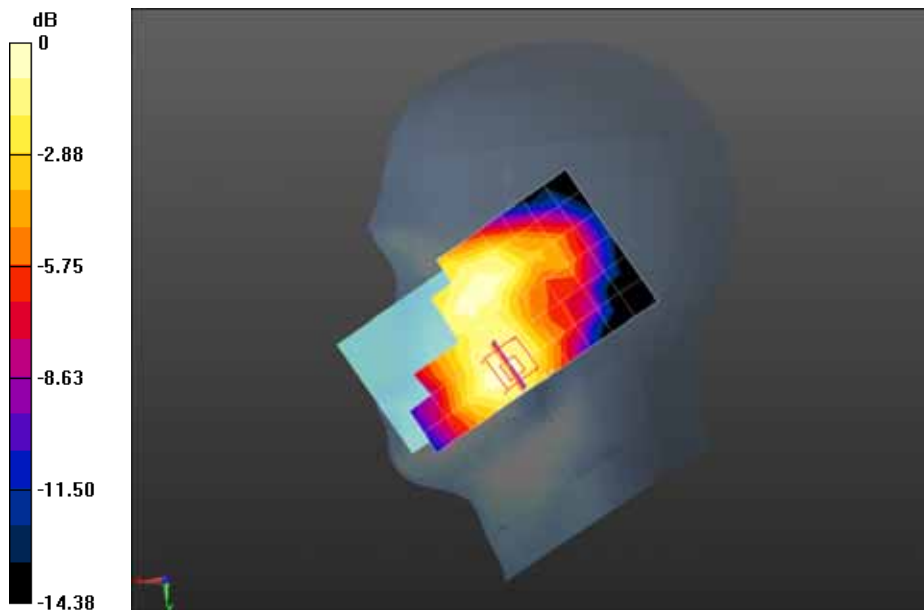

0 dB = 0.135 W/kg = -8.70 dBW/kg

Date/Time: 01-04-2014

Test Laboratory: QuieTek Lab

PCS1900 Mid Tilt-Right

DUT: SMART PHONE; Type: Syreni 50DC II

Communication System: Generic GSM; Communication System Band: PCS1900; Duty Cycle: 1:8.3;

Frequency: 1880 MHz; Medium parameters used: $f = 1880$ MHz; $\sigma = 1.45$ S/m; $\epsilon_r = 38.78$; $\rho = 1000$ kg/m³ ;

Phantom section: Right Section

Ambient temperature (°C): 21.5, Liquid temperature (°C): 21.0

DASY5 Configuration:

- Probe: EX3DV4 - SN3710; ConvF(7.72, 7.72, 7.72); Calibrated: 04/03/2014;
- Sensor-Surface: 4mm (Mechanical Surface Detection)
- Electronics: DAE4 Sn1220; Calibrated: 22/01/2014
- Phantom: SAM1; Type: SAM; Serial: TP1561
- Measurement SW: DASY52, Version 52.8 (7); SEMCAD X Version 14.6.10 (7164)

Configuration/PCS1900 Mid Tilt-Right/Area Scan (7x12x1): Measurement grid: dx=15mm, dy=15mm

Maximum value of SAR (measured) = 0.104 W/kg

Configuration/PCS1900 Mid Tilt-Right/Zoom Scan (5x5x7)/Cube 0: Measurement grid: dx=8mm, dy=8mm, dz=5mm, Reference Value = 8.456 V/m; Power Drift = 0.04 dB

Peak SAR (extrapolated) = 0.175 W/kg

SAR(1 g) = 0.106 W/kg; SAR(10 g) = 0.060 W/kg Maximum value of SAR (measured) = 0.111 W/kg

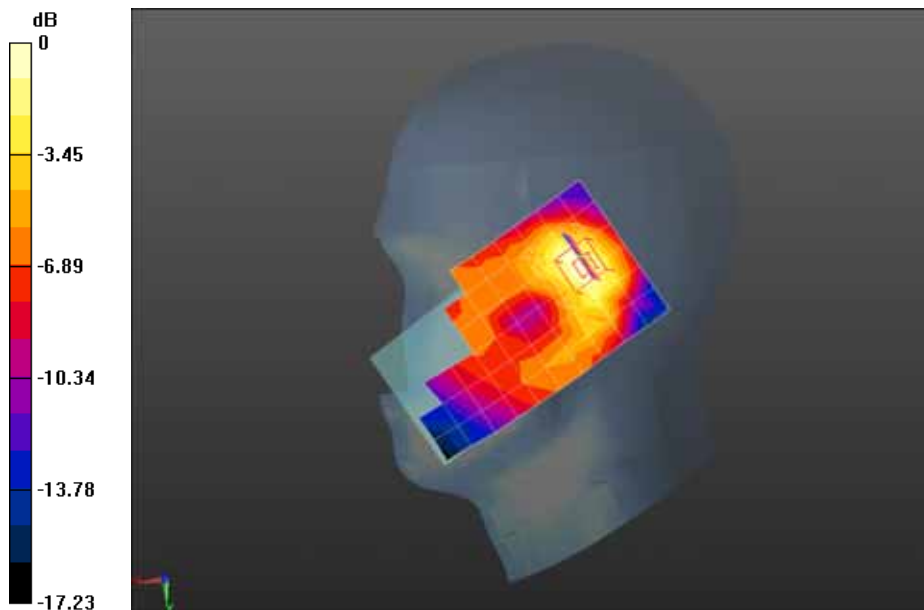

0 dB = 0.111 W/kg = -9.55 dBW/kg

Date/Time: 01-04-2014

Test Laboratory: QuieTek Lab

PCS1900 Mid Touch-Left <SIM 2>

DUT: SMART PHONE; Type: Syreni 50DC II

Communication System: Generic GSM; Communication System Band: PCS1900; Duty Cycle: 1:8.3;

Frequency: 1880 MHz; Medium parameters used: $f = 1880$ MHz; $\sigma = 1.45$ S/m; $\epsilon_r = 38.78$; $\rho = 1000$ kg/m³ ;

Phantom section: Left Section

Ambient temperature (°C): 21.5, Liquid temperature (°C): 21.0

DASY5 Configuration:

- Probe: EX3DV4 - SN3710; ConvF(7.72, 7.72, 7.72); Calibrated: 04/03/2014;
- Sensor-Surface: 4mm (Mechanical Surface Detection)
- Electronics: DAE4 Sn1220; Calibrated: 22/01/2014
- Phantom: SAM1; Type: SAM; Serial: TP1561
- Measurement SW: DASY52, Version 52.8 (7); SEMCAD X Version 14.6.10 (7164)

Configuration/PCS1900 Mid Touch-Left/Area Scan (7x12x1): Measurement grid: dx=15mm, dy=15mm

Maximum value of SAR (measured) = 0.252 W/kg

Configuration/PCS1900 Mid Touch-Left/Zoom Scan (5x5x7)/Cube 0: Measurement grid: dx=8mm, dy=8mm, dz=5mm, Reference Value = 5.123 V/m; Power Drift = -0.18 dB

Peak SAR (extrapolated) = 0.422 W/kg

SAR(1 g) = 0.262 W/kg; SAR(10 g) = 0.157 W/kg Maximum value of SAR (measured) = 0.287 W/kg

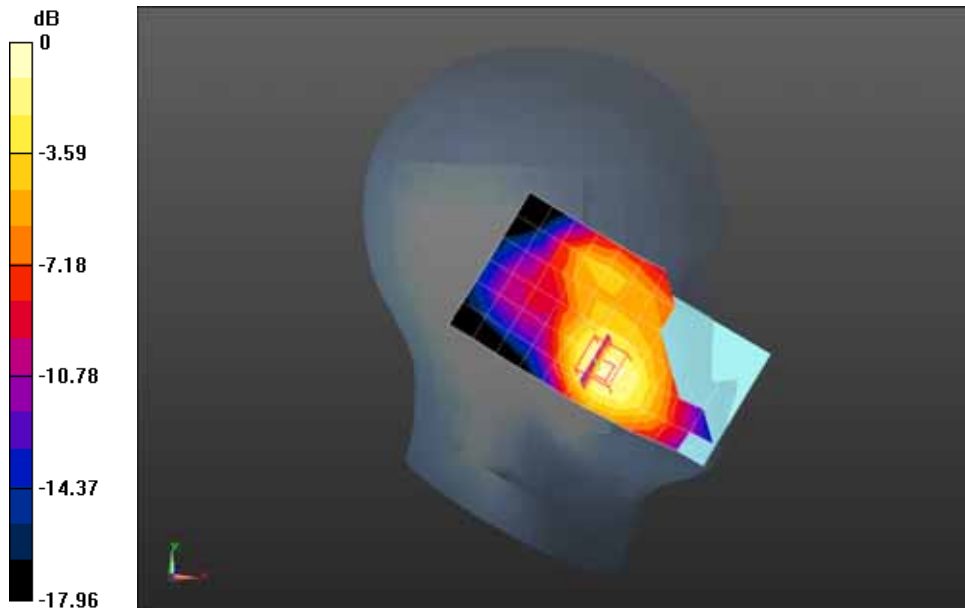

0 dB = 0.287 W/kg = -5.42 dBW/kg

Date/Time: 01-04-2014

Test Laboratory: QuieTek Lab

PCS1900 Mid Body-Back

DUT: SMART PHONE; Type: Syreni 50DC II

Communication System: Generic GSM; Communication System Band: PCS1900; Duty Cycle: 1:8.3;

Frequency: 1880 MHz; Medium parameters used: $f = 1880$ MHz; $\sigma = 1.53$ S/m; $\epsilon_r = 52.51$; $\rho = 1000$ kg/m³ ;

Phantom section: Flat Section

Ambient temperature (°C): 21.5, Liquid temperature (°C): 21.0

DASY5 Configuration:

- Probe: EX3DV4 - SN3710; ConvF(7.25, 7.25, 7.25); Calibrated: 04/03/2014;
- Sensor-Surface: 4mm (Mechanical Surface Detection)
- Electronics: DAE4 Sn1220; Calibrated: 22/01/2014
- Phantom: SAM1; Type: SAM; Serial: TP1561
- Measurement SW: DASY52, Version 52.8 (7); SEMCAD X Version 14.6.10 (7164)

Configuration/PCS1900 Mid Body-Back/Area Scan (7x13x1): Measurement grid: dx=15mm, dy=15mm

Maximum value of SAR (measured) = 0.405 W/kg

Configuration/PCS1900 Mid Body-Back/Zoom Scan (5x5x7)/Cube 0: Measurement grid: dx=8mm,

dy=8mm, dz=5mm, Reference Value = 9.323 V/m; Power Drift = -0.06 dB

Peak SAR (extrapolated) = 0.607 W/kg

SAR(1 g) = 0.396 W/kg; SAR(10 g) = 0.259 W/kg Maximum value of SAR (measured) = 0.422 W/kg

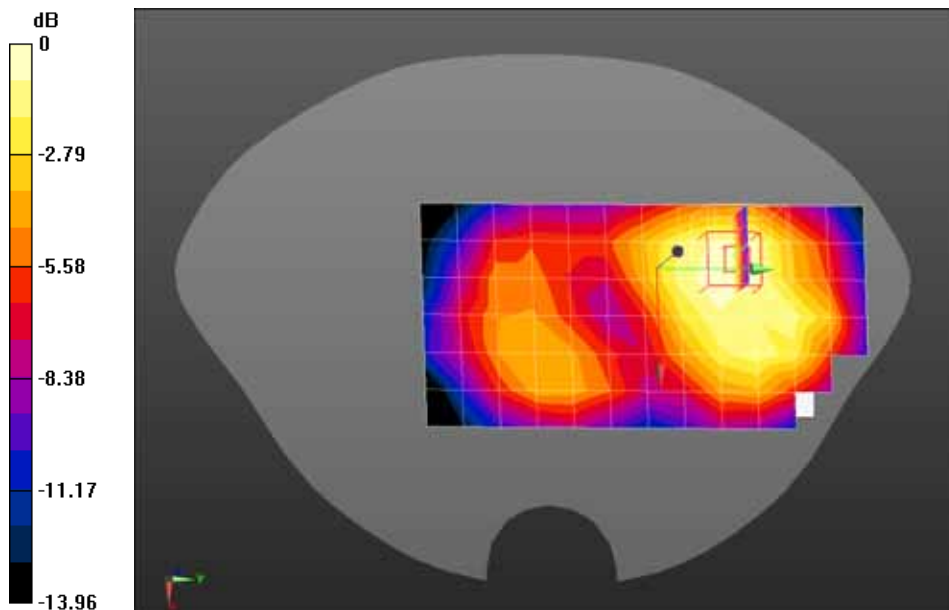

0 dB = 0.422 W/kg = -3.75 dBW/kg

Date/Time: 01-04-2014

Test Laboratory: QuieTek Lab

GPRS1900 Mid Body-Back(4up)

DUT: SMART PHONE; Type: Syreni 50DC II

Communication System: GPRS/EGPRS-4 Slot; Communication System Band: PCS 1900; Duty Cycle:

1:2.1 ; Frequency: 1880 MHz; Medium parameters used: $f = 1880 \text{ MHz}$; $\sigma = 1.53 \text{ S/m}$; $\epsilon_r = 52.51$; $\rho = 1000 \text{ kg/m}^3$; Phantom section: Flat Section

Ambient temperature (°C): 21.5, Liquid temperature (°C): 21.0

DASY5 Configuration:

- Probe: EX3DV4 - SN3710; ConvF(7.25, 7.25, 7.25); Calibrated: 04/03/2014;
- Sensor-Surface: 4mm (Mechanical Surface Detection)
- Electronics: DAE4 Sn1220; Calibrated: 22/01/2014
- Phantom: SAM1; Type: SAM; Serial: TP1561
- Measurement SW: DASY52, Version 52.8 (7); SEMCAD X Version 14.6.10 (7164)

Configuration/GPRS1900 Mid Body-Back/Area Scan (7x13x1): Measurement grid: dx=15mm, dy=15mm

Maximum value of SAR (measured) = 0.672 W/kg

Configuration/GPRS1900 Mid Body-Back/Zoom Scan (5x5x7)/Cube 1: Measurement grid: dx=8mm, dy=8mm, dz=5mm, Reference Value = 12.260 V/m; Power Drift = -0.06 dB

Peak SAR (extrapolated) = 0.853 W/kg

SAR(1 g) = 0.542 W/kg; SAR(10 g) = 0.354 W/kg Maximum value of SAR (measured) = 0.600 W/kg

Configuration/GPRS1900 Mid Body-Back/Zoom Scan (5x5x7)/Cube 0: Measurement grid: dx=8mm, dy=8mm, dz=5mm, Reference Value = 12.260 V/m; Power Drift = -0.06 dB

Peak SAR (extrapolated) = 1.02 W/kg

SAR(1 g) = 0.676 W/kg; SAR(10 g) = 0.444 W/kg Maximum value of SAR (measured) = 0.715 W/kg

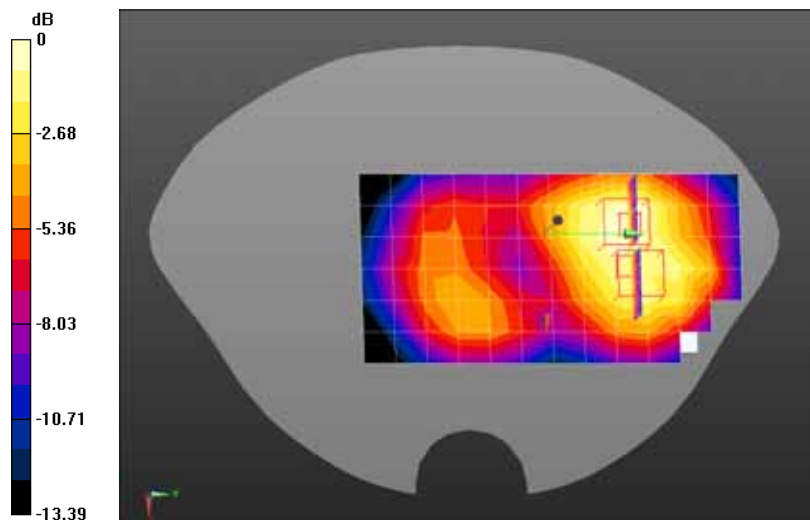

0 dB = 0.715 W/kg = -1.46 dBW/kg

Z-Axis Plot

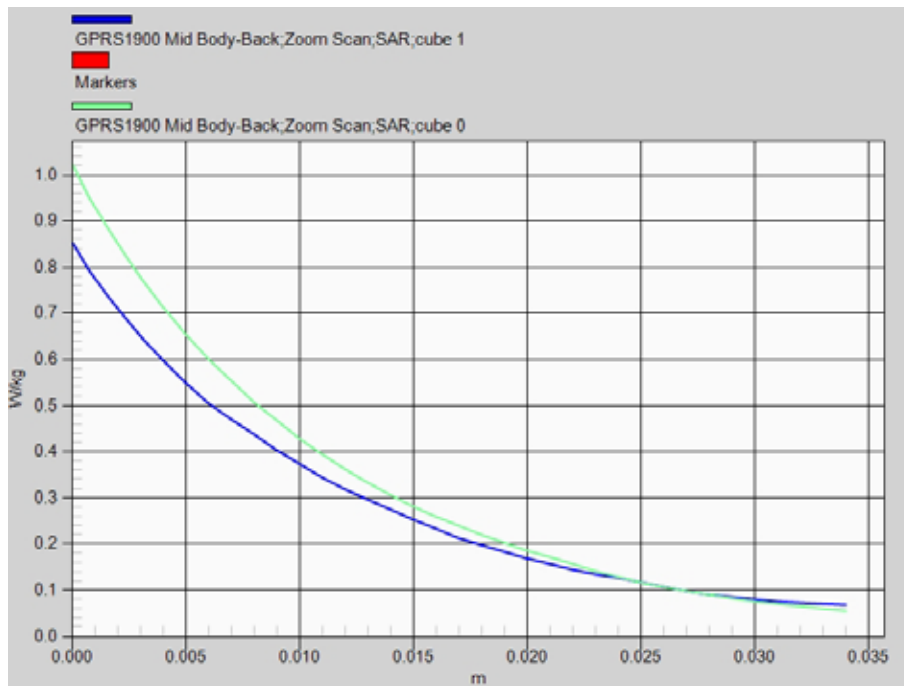

Date/Time: 01-04-2014

Test Laboratory: QuieTek Lab

GPRS1900 Mid Body-Front(4up)

DUT: SMART PHONE; Type: Syreni 50DC II

Communication System: GPRS/EGPRS-4 Slot; Communication System Band: PCS 1900; Duty Cycle:

1:2.1 ; Frequency: 1880 MHz; Medium parameters used: $f = 1880 \text{ MHz}$; $\sigma = 1.53 \text{ S/m}$; $\epsilon_r = 52.51$; $\rho = 1000 \text{ kg/m}^3$; Phantom section: Flat Section

Ambient temperature (°C): 21.5, Liquid temperature (°C): 21.0

DASY5 Configuration:

- Probe: EX3DV4 - SN3710; ConvF(7.25, 7.25, 7.25); Calibrated: 04/03/2014;
- Sensor-Surface: 4mm (Mechanical Surface Detection)
- Electronics: DAE4 Sn1220; Calibrated: 22/01/2014
- Phantom: SAM1; Type: SAM; Serial: TP1561
- Measurement SW: DASY52, Version 52.8 (7); SEMCAD X Version 14.6.10 (7164)

Configuration/GPRS1900 Mid Body-Front/Area Scan (7x13x1): Measurement grid: dx=15mm, dy=15mm

Maximum value of SAR (measured) = 0.243 W/kg

Configuration/GPRS1900 Mid Body-Front/Zoom Scan (5x5x7)/Cube 0: Measurement grid: dx=8mm, dy=8mm, dz=5mm, Reference Value = 8.001 V/m; Power Drift = 0.03 dB

Peak SAR (extrapolated) = 0.418 W/kg

SAR(1 g) = 0.249 W/kg; SAR(10 g) = 0.154 W/kg Maximum value of SAR (measured) = 0.273 W/kg

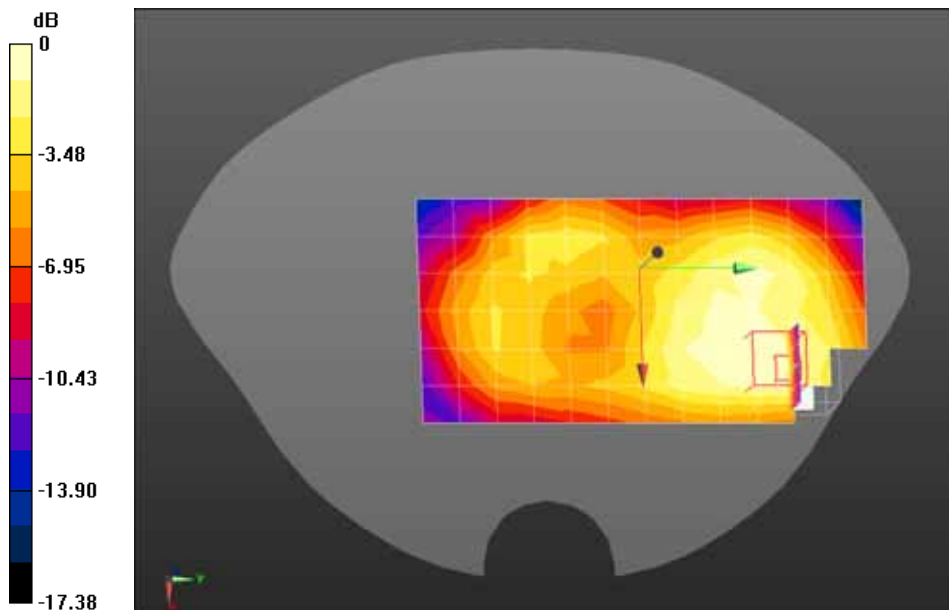

0 dB = 0.273 W/kg = -5.64 dBW/kg

Date/Time: 01-04-2014

Test Laboratory: QuieTek Lab

GPRS1900 Mid Body-Right side(4up)

DUT: SMART PHONE; Type: Syreni 50DC II

Communication System: GPRS/EGPRS-4 Slot; Communication System Band: PCS 1900; Duty Cycle:

1:2.1 ; Frequency: 1880 MHz; Medium parameters used: $f = 1880 \text{ MHz}$; $\sigma = 1.53 \text{ S/m}$; $\epsilon_r = 52.51$; $\rho = 1000 \text{ kg/m}^3$; Phantom section: Flat Section

Ambient temperature (°C): 21.5, Liquid temperature (°C): 21.0

DASY5 Configuration:

- Probe: EX3DV4 - SN3710; ConvF(7.25, 7.25, 7.25); Calibrated: 04/03/2014;
- Sensor-Surface: 4mm (Mechanical Surface Detection)
- Electronics: DAE4 Sn1220; Calibrated: 22/01/2014
- Phantom: SAM1; Type: SAM; Serial: TP1561
- Measurement SW: DASY52, Version 52.8 (7); SEMCAD X Version 14.6.10 (7164)

Configuration/GPRS1900 Mid Body-Right side/Area Scan (5x13x1): Measurement grid: $dx=15\text{mm}$, $dy=15\text{mm}$

Maximum value of SAR (measured) = 0.100 W/kg

Configuration/GPRS1900 Mid Body-Right side/Zoom Scan (5x5x7)/Cube 0: Measurement grid:

$dx=8\text{mm}$, $dy=8\text{mm}$, $dz=5\text{mm}$, Reference Value = 7.331 V/m; Power Drift = 0.03 dB

Peak SAR (extrapolated) = 0.141 W/kg

SAR(1 g) = 0.092 W/kg; SAR(10 g) = 0.057 W/kg Maximum value of SAR (measured) = 0.100 W/kg

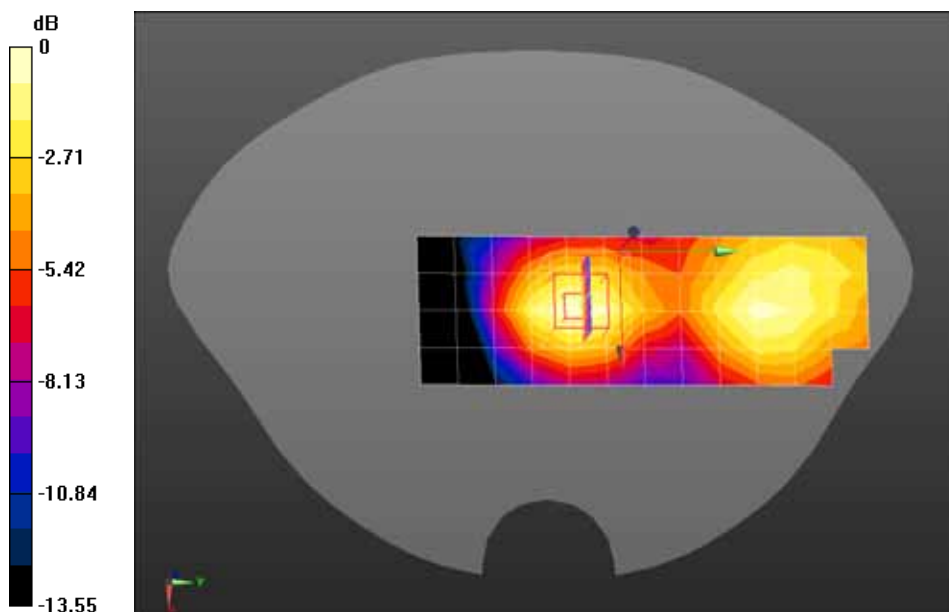

0 dB = 0.100 W/kg = -10.00 dBW/kg

Date/Time: 01-04-2014

Test Laboratory: QuieTek Lab

GPRS1900 Mid Body-Left side(4up)

DUT: SMART PHONE; Type: Syreni 50DC II

Communication System: GPRS/EGPRS-4 Slot; Communication System Band: PCS 1900; Duty Cycle:

1:2.1 ; Frequency: 1880 MHz; Medium parameters used: $f = 1880$ MHz; $\sigma = 1.53$ S/m; $\epsilon_r = 52.51$; $\rho = 1000$ kg/m³ ; Phantom section: Flat Section

Ambient temperature (°C): 21.5, Liquid temperature (°C): 21.0

DASY5 Configuration:

- Probe: EX3DV4 - SN3710; ConvF(7.25, 7.25, 7.25); Calibrated: 04/03/2014;
- Sensor-Surface: 4mm (Mechanical Surface Detection)
- Electronics: DAE4 Sn1220; Calibrated: 22/01/2014
- Phantom: SAM1; Type: SAM; Serial: TP1561
- Measurement SW: DASY52, Version 52.8 (7); SEMCAD X Version 14.6.10 (7164)

Configuration/GPRS1900 Mid Body-Left side/Area Scan (5x13x1): Measurement grid: dx=15mm, dy=15mm

Maximum value of SAR (measured) = 0.414 W/kg

Configuration/GPRS1900 Mid Body-Left side/Zoom Scan (5x5x7)/Cube 0: Measurement grid: dx=8mm, dy=8mm, dz=5mm, Reference Value = 12.744 V/m; Power Drift = -0.07 dB

Peak SAR (extrapolated) = 0.664 W/kg

SAR(1 g) = 0.417 W/kg; SAR(10 g) = 0.248 W/kg Maximum value of SAR (measured) = 0.459 W/kg

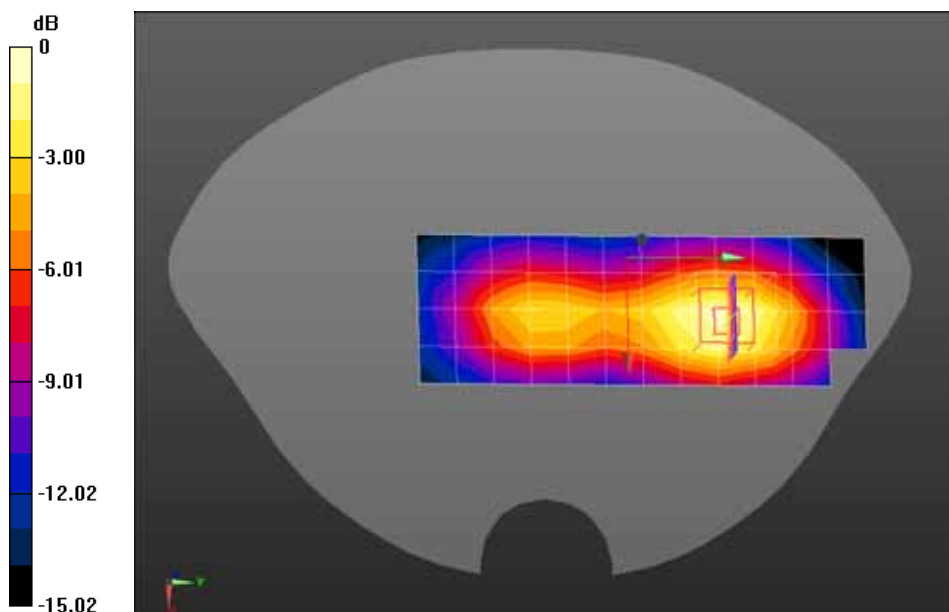

0 dB = 0.459 W/kg = -3.38 dBW/kg

Date/Time: 01-04-2014

Test Laboratory: QuieTek Lab

GPRS1900 Mid Body-Bottom(4up)

DUT: SMART PHONE; Type: Syreni 50DC II

Communication System: GPRS/EGPRS-4 Slot; Communication System Band: PCS 1900; Duty Cycle:

1:2.1 ; Frequency: 1880 MHz; Medium parameters used: $f = 1880$ MHz; $\sigma = 1.53$ S/m; $\epsilon_r = 52.51$; $\rho = 1000$ kg/m³ ; Phantom section: Flat Section

Ambient temperature (°C): 21.5, Liquid temperature (°C): 21.0

DASY5 Configuration:

- Probe: EX3DV4 - SN3710; ConvF(7.25, 7.25, 7.25); Calibrated: 04/03/2014;
- Sensor-Surface: 4mm (Mechanical Surface Detection)
- Electronics: DAE4 Sn1220; Calibrated: 22/01/2014
- Phantom: SAM1; Type: SAM; Serial: TP1561
- Measurement SW: DASY52, Version 52.8 (7); SEMCAD X Version 14.6.10 (7164)

Configuration/GPRS1900 Mid Body-Bottom/Area Scan (5x8x1): Measurement grid: dx=15mm, dy=15mm

Maximum value of SAR (measured) = 0.309 W/kg

Configuration/GPRS1900 Mid Body-Bottom/Zoom Scan (5x5x7)/Cube 0: Measurement grid: dx=8mm, dy=8mm, dz=5mm, Reference Value = 13.838 V/m; Power Drift = 0.09 dB

Peak SAR (extrapolated) = 0.535 W/kg

SAR(1 g) = 0.347 W/kg; SAR(10 g) = 0.209 W/kg Maximum value of SAR (measured) = 0.384 W/kg

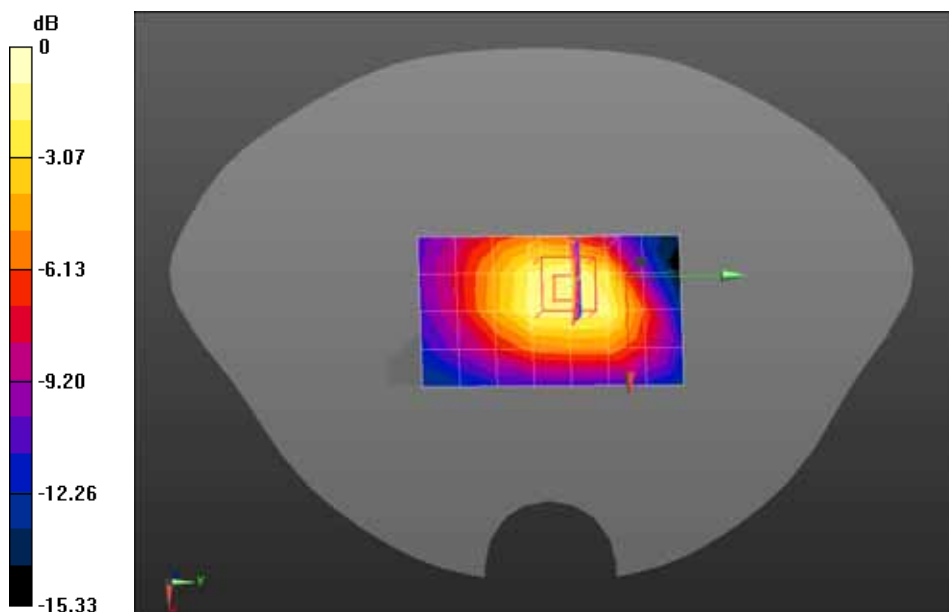

0 dB = 0.384 W/kg = -4.16 dBW/kg

Date/Time: 01-04-2014

Test Laboratory: QuieTek Lab

WCDMA Band V Mid Touch-Left

DUT: SMART PHONE; Type: Syreni 50DC II

Communication System: UMTS; Communication System Band: Band V UTRA/FDD; Duty Cycle: 1:1;

Frequency: 836.4 MHz; Medium parameters used: $f = 836.4$ MHz; $\sigma = 0.89$ S/m; $\epsilon_r = 40.77$; $\rho = 1000$ kg/m³ ;

Phantom section: Left Section

Ambient temperature (°C): 21.5, Liquid temperature (°C): 21.0

DASY5 Configuration:

- Probe: EX3DV4 - SN3710; ConvF(9.56, 9.56, 9.56); Calibrated: 04/03/2014;
- Sensor-Surface: 4mm (Mechanical Surface Detection)
- Electronics: DAE4 Sn1220; Calibrated: 22/01/2014
- Phantom: SAM2; Type: SAM; Serial: TP1562
- Measurement SW: DASY52, Version 52.8 (7); SEMCAD X Version 14.6.10 (7164)

Configuration/WCDMA Band V Mid Touch-Left/Area Scan (7x13x1): Measurement grid: dx=15mm, dy=15mm

Maximum value of SAR (measured) = 0.0851 W/kg

Configuration/WCDMA Band V Mid Touch-Left/Zoom Scan (5x5x7)/Cube 0: Measurement grid:

dx=8mm, dy=8mm, dz=5mm, Reference Value = 2.389 V/m; Power Drift = 0.19 dB

Peak SAR (extrapolated) = 0.0980 W/kg

SAR(1 g) = 0.081 W/kg; SAR(10 g) = 0.064 W/kg Maximum value of SAR (measured) = 0.0855 W/kg

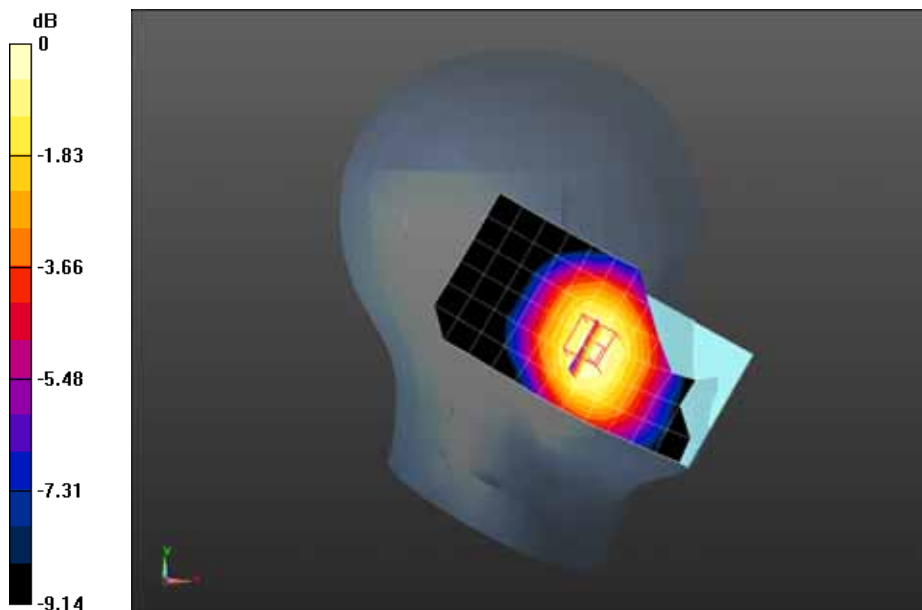

0 dB = 0.0855 W/kg = -10.68 dBW/kg

Date/Time: 01-04-2014

Test Laboratory: QuieTek Lab

WCDMA Band V Mid Tilt-Left

DUT: SMART PHONE; Type: Syreni 50DC II

Communication System: UMTS; Communication System Band: Band V UTRA/FDD; Duty Cycle: 1:1;

Frequency: 836.4 MHz; Medium parameters used: $f = 836.4$ MHz; $\sigma = 0.89$ S/m; $\epsilon_r = 40.77$; $\rho = 1000$ kg/m³ ;

Phantom section: Left Section

Ambient temperature (°C): 21.5, Liquid temperature (°C): 21.0

DASY5 Configuration:

- Probe: EX3DV4 - SN3710; ConvF(9.56, 9.56, 9.56); Calibrated: 04/03/2014;
- Sensor-Surface: 4mm (Mechanical Surface Detection)
- Electronics: DAE4 Sn1220; Calibrated: 22/01/2014
- Phantom: SAM2; Type: SAM; Serial: TP1562
- Measurement SW: DASY52, Version 52.8 (7); SEMCAD X Version 14.6.10 (7164)

Configuration/WCDMA Band V Mid Tilt-Left/Area Scan (7x13x1): Measurement grid: dx=15mm, dy=15mm

Maximum value of SAR (measured) = 0.0469 W/kg

Configuration/WCDMA Band V Mid Tilt-Left/Zoom Scan (5x5x7)/Cube 0: Measurement grid: dx=8mm, dy=8mm, dz=5mm, Reference Value = 4.161 V/m; Power Drift = -0.04 dB

Peak SAR (extrapolated) = 0.0550 W/kg

SAR(1 g) = 0.046 W/kg; SAR(10 g) = 0.036 W/kg Maximum value of SAR (measured) = 0.0475 W/kg

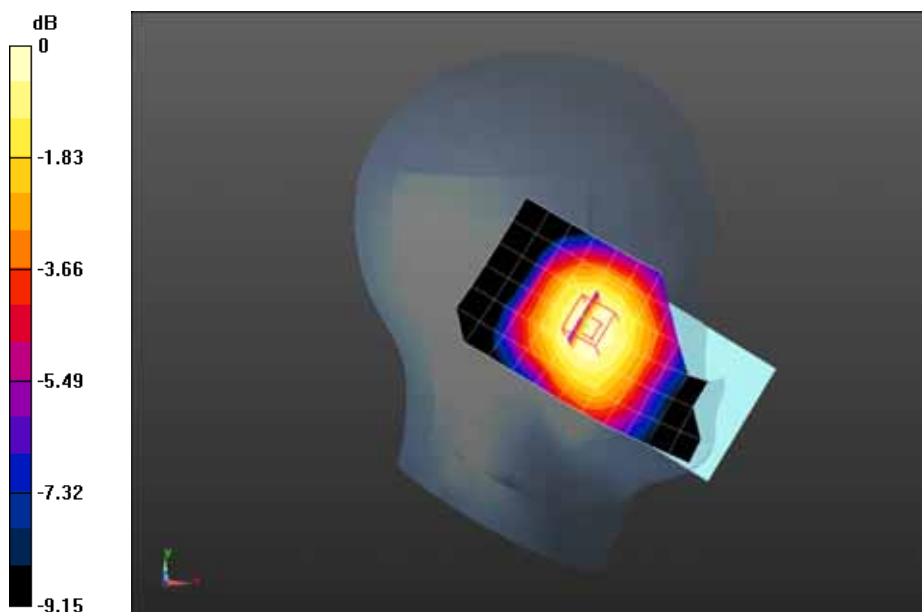

0 dB = 0.0475 W/kg = -13.23 dBW/kg

Date/Time: 01-04-2014

Test Laboratory: QuieTek Lab

WCDMA Band V Mid Touch-Right

DUT: SMART PHONE; Type: Syreni 50DC II

Communication System: UMTS; Communication System Band: Band V UTRA/FDD; Duty Cycle: 1:1;

Frequency: 836.4 MHz; Medium parameters used: $f = 836.4$ MHz; $\sigma = 0.89$ S/m; $\epsilon_r = 40.77$; $\rho = 1000$ kg/m³ ;

Phantom section: Right Section

Ambient temperature (°C): 21.5, Liquid temperature (°C): 21.0

DASY5 Configuration:

- Probe: EX3DV4 - SN3710; ConvF(9.56, 9.56, 9.56); Calibrated: 04/03/2014;
- Sensor-Surface: 4mm (Mechanical Surface Detection)
- Electronics: DAE4 Sn1220; Calibrated: 22/01/2014
- Phantom: SAM2; Type: SAM; Serial: TP1562
- Measurement SW: DASY52, Version 52.8 (7); SEMCAD X Version 14.6.10 (7164)

Configuration/WCDMA Band V Mid Touch-Right/Area Scan (7x13x1): Measurement grid: dx=15mm, dy=15mm

Maximum value of SAR (measured) = 0.0831 W/kg

Configuration/WCDMA Band V Mid Touch-Right/Zoom Scan (5x5x7)/Cube 0: Measurement grid:

dx=8mm, dy=8mm, dz=5mm, Reference Value = 2.558 V/m; Power Drift = 0.07 dB

Peak SAR (extrapolated) = 0.100 W/kg

SAR(1 g) = 0.082 W/kg; SAR(10 g) = 0.064 W/kg Maximum value of SAR (measured) = 0.0852 W/kg

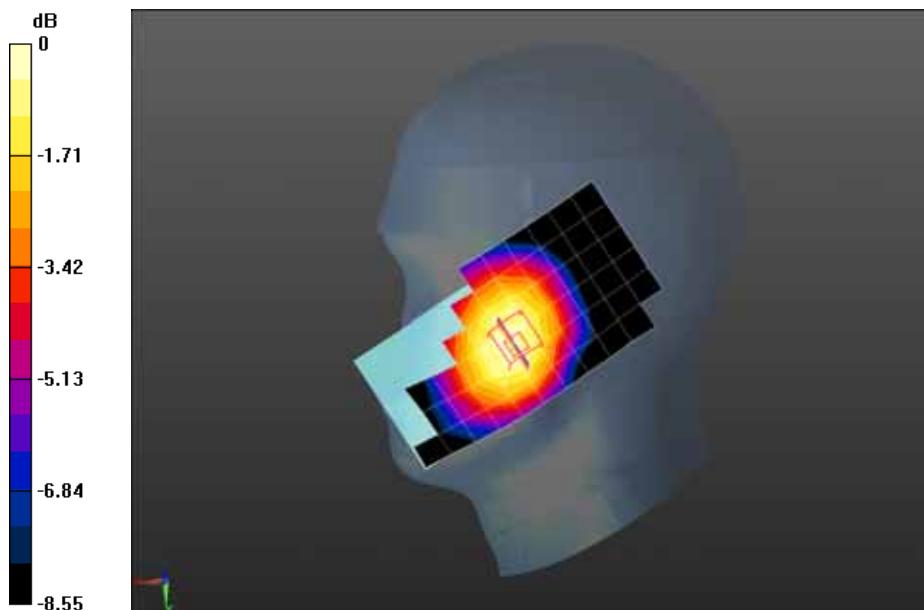

0 dB = 0.0852 W/kg = -10.70 dBW/kg

Date/Time: 01-04-2014

Test Laboratory: QuieTek Lab

WCDMA Band V Mid Tilt-Right

DUT: SMART PHONE; Type: Syreni 50DC II

Communication System: UMTS; Communication System Band: Band V UTRA/FDD; Duty Cycle: 1:1;

Frequency: 836.4 MHz; Medium parameters used: $f = 836.4$ MHz; $\sigma = 0.89$ S/m; $\epsilon_r = 40.77$; $\rho = 1000$ kg/m³ ;

Phantom section: Right Section

Ambient temperature (°C): 21.5, Liquid temperature (°C): 21.0

DASY5 Configuration:

- Probe: EX3DV4 - SN3710; ConvF(9.56, 9.56, 9.56); Calibrated: 04/03/2014;
- Sensor-Surface: 4mm (Mechanical Surface Detection)
- Electronics: DAE4 Sn1220; Calibrated: 22/01/2014
- Phantom: SAM2; Type: SAM; Serial: TP1562
- Measurement SW: DASY52, Version 52.8 (7); SEMCAD X Version 14.6.10 (7164)

Configuration/WCDMA Band V Mid Tilt-Right/Area Scan (7x13x1): Measurement grid: dx=15mm, dy=15mm

Maximum value of SAR (measured) = 0.0572 W/kg

Configuration/WCDMA Band V Mid Tilt-Right/Zoom Scan (5x5x7)/Cube 0: Measurement grid: dx=8mm, dy=8mm, dz=5mm, Reference Value = 4.805 V/m; Power Drift = 0.04 dB

Peak SAR (extrapolated) = 0.0650 W/kg

SAR(1 g) = 0.055 W/kg; SAR(10 g) = 0.043 W/kg Maximum value of SAR (measured) = 0.0574 W/kg

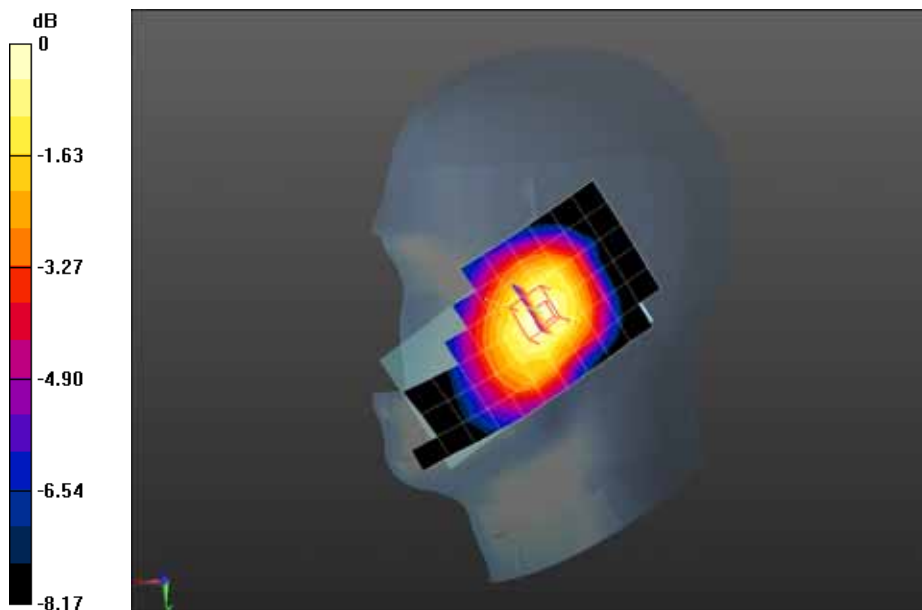

0 dB = 0.0574 W/kg = -12.41 dBW/kg

Date/Time: 01-04-2014

Test Laboratory: QuieTek Lab

WCDMA Band V Mid Body-Back

DUT: SMART PHONE; Type: Syreni 50DC II

Communication System: UMTS; Communication System Band: Band V UTRA/FDD; Duty Cycle: 1:1;

Frequency: 836.4 MHz; Medium parameters used: $f = 836.4$ MHz; $\sigma = 0.99$ S/m; $\epsilon_r = 53.71$; $\rho = 1000$ kg/m³ ;

Phantom section: Flat Section

Ambient temperature (°C): 21.5, Liquid temperature (°C): 21.0

DASY5 Configuration:

- Probe: EX3DV4 - SN3710; ConvF(9.22, 9.22, 9.22); Calibrated: 04/03/2014;
- Sensor-Surface: 4mm (Mechanical Surface Detection)
- Electronics: DAE4 Sn1220; Calibrated: 22/01/2014
- Phantom: SAM2; Type: SAM; Serial: TP1562
- Measurement SW: DASY52, Version 52.8 (7); SEMCAD X Version 14.6.10 (7164)

Configuration/WCDMA Band V Mid Body-Back/Area Scan (7x13x1): Measurement grid: dx=15mm, dy=15mm

Maximum value of SAR (measured) = 0.345 W/kg

Configuration/WCDMA Band V Mid Body-Back/Zoom Scan (5x5x7)/Cube 0: Measurement grid:

dx=8mm, dy=8mm, dz=5mm, Reference Value = 15.147 V/m; Power Drift = -0.18 dB

Peak SAR (extrapolated) = 0.410 W/kg

SAR(1 g) = 0.330 W/kg; SAR(10 g) = 0.255 W/kg Maximum value of SAR (measured) = 0.346 W/kg

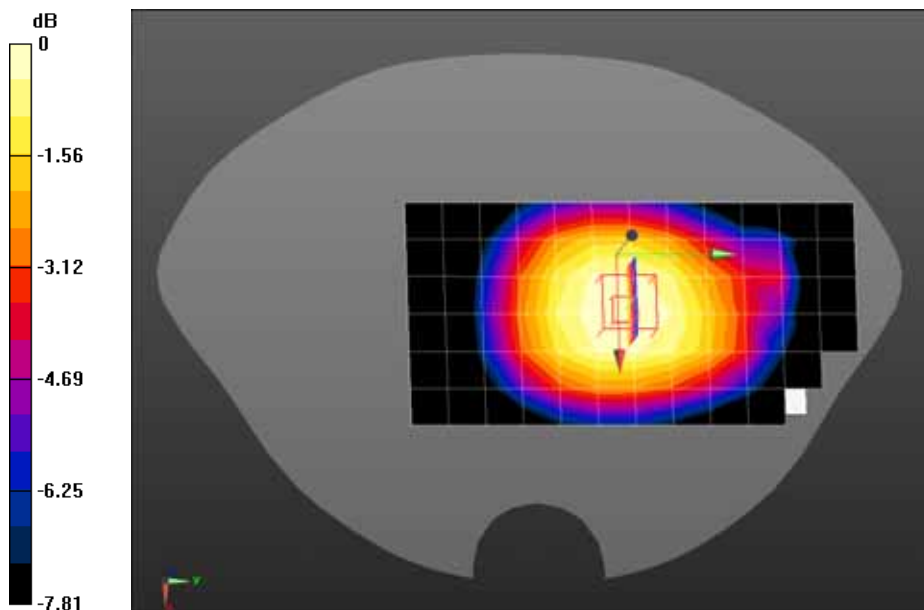

0 dB = 0.346 W/kg = -4.61 dBW/kg

Z-Axis Plot

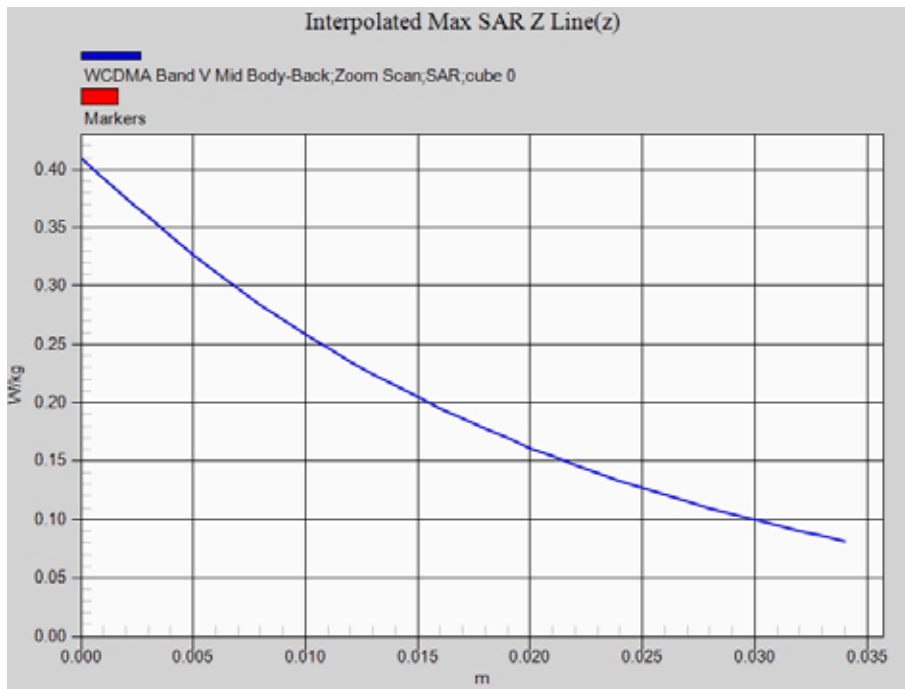

Date/Time: 01-04-2014

Test Laboratory: QuieTek Lab

WCDMA Band V Mid Body-Front

DUT: SMART PHONE; Type: Syreni 50DC II

Communication System: UMTS; Communication System Band: Band V UTRA/FDD; Duty Cycle: 1:1;

Frequency: 836.4 MHz; Medium parameters used: $f = 836.4$ MHz; $\sigma = 0.99$ S/m; $\epsilon_r = 53.71$; $\rho = 1000$ kg/m³ ;

Phantom section: Flat Section

Ambient temperature (°C): 21.5, Liquid temperature (°C): 21.0

DASY5 Configuration:

- Probe: EX3DV4 - SN3710; ConvF(9.22, 9.22, 9.22); Calibrated: 04/03/2014;
- Sensor-Surface: 4mm (Mechanical Surface Detection)
- Electronics: DAE4 Sn1220; Calibrated: 22/01/2014
- Phantom: SAM2; Type: SAM; Serial: TP1562
- Measurement SW: DASY52, Version 52.8 (7); SEMCAD X Version 14.6.10 (7164)

Configuration/WCDMA Band V Mid Body-Front/Area Scan (7x13x1): Measurement grid: dx=15mm, dy=15mm

Maximum value of SAR (measured) = 0.107 W/kg

Configuration/WCDMA Band V Mid Body-Front/Zoom Scan (5x5x7)/Cube 0: Measurement grid:

dx=8mm, dy=8mm, dz=5mm, Reference Value = 8.266 V/m; Power Drift = 0.14 dB

Peak SAR (extrapolated) = 0.133 W/kg

SAR(1 g) = 0.107 W/kg; SAR(10 g) = 0.083 W/kg Maximum value of SAR (measured) = 0.112 W/kg

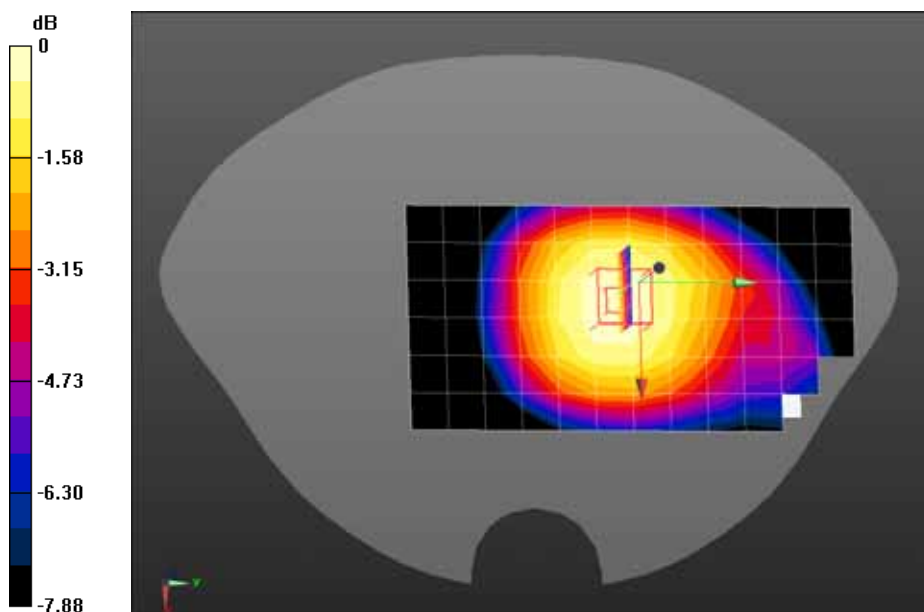

0 dB = 0.112 W/kg = -9.51 dBW/kg

Date/Time: 01-04-2014

Test Laboratory: QuieTek Lab

WCDMA Band V Mid Body-Right side

DUT: SMART PHONE; Type: Syreni 50DC II

Communication System: UMTS; Communication System Band: Band V UTRA/FDD; Duty Cycle: 1:1;

Frequency: 836.4 MHz; Medium parameters used: $f = 836.4$ MHz; $\sigma = 0.99$ S/m; $\epsilon_r = 53.71$; $\rho = 1000$ kg/m³ ;

Phantom section: Flat Section

Ambient temperature (°C): 21.5, Liquid temperature (°C): 21.0

DASY5 Configuration:

- Probe: EX3DV4 - SN3710; ConvF(9.22, 9.22, 9.22); Calibrated: 04/03/2014;
- Sensor-Surface: 4mm (Mechanical Surface Detection)
- Electronics: DAE4 Sn1220; Calibrated: 22/01/2014
- Phantom: SAM2; Type: SAM; Serial: TP1562
- Measurement SW: DASY52, Version 52.8 (7); SEMCAD X Version 14.6.10 (7164)

Configuration/WCDMA Band V Mid Body-Right side/Area Scan (5x13x1): Measurement grid: dx=15mm, dy=15mm

Maximum value of SAR (measured) = 0.0668 W/kg

Configuration/WCDMA Band V Mid Body-Right side/Zoom Scan (5x5x7)/Cube 0: Measurement grid: dx=8mm, dy=8mm, dz=5mm, Reference Value = 6.240 V/m; Power Drift = 0.08 dB

Peak SAR (extrapolated) = 0.0870 W/kg

SAR(1 g) = 0.063 W/kg; SAR(10 g) = 0.044 W/kg Maximum value of SAR (measured) = 0.0661 W/kg

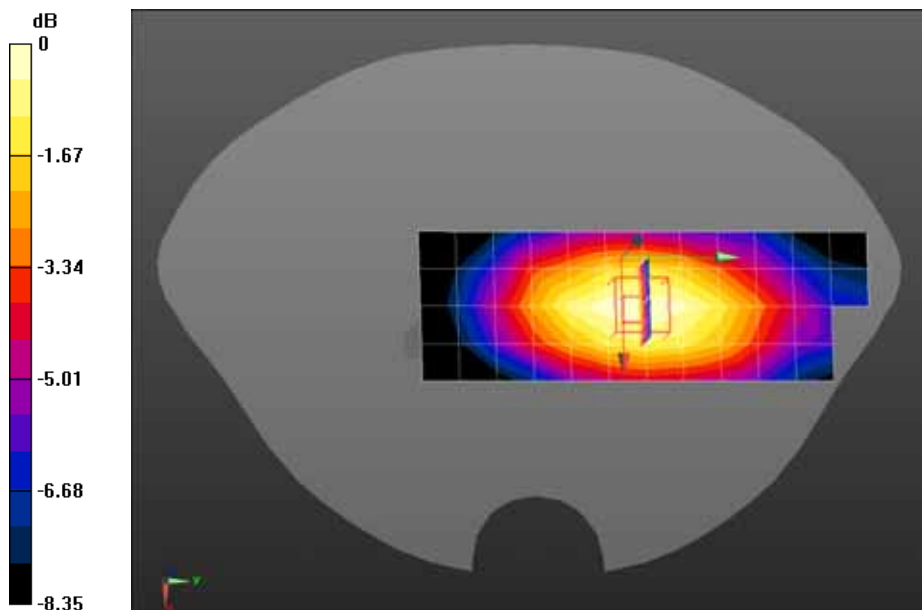

0 dB = 0.0661 W/kg = -11.80 dBW/kg

Date/Time: 01-04-2014

Test Laboratory: QuieTek Lab

WCDMA Band V Mid Body-Left side

DUT: SMART PHONE; Type: Syreni 50DC II

Communication System: UMTS; Communication System Band: Band V UTRA/FDD; Duty Cycle: 1:1;

Frequency: 836.4 MHz; Medium parameters used: $f = 836.4$ MHz; $\sigma = 0.99$ S/m; $\epsilon_r = 53.71$; $\rho = 1000$ kg/m³ ;

Phantom section: Flat Section

Ambient temperature (°C): 21.5, Liquid temperature (°C): 21.0

DASY5 Configuration:

- Probe: EX3DV4 - SN3710; ConvF(9.22, 9.22, 9.22); Calibrated: 04/03/2014;
- Sensor-Surface: 4mm (Mechanical Surface Detection)
- Electronics: DAE4 Sn1220; Calibrated: 22/01/2014
- Phantom: SAM2; Type: SAM; Serial: TP1562
- Measurement SW: DASY52, Version 52.8 (7); SEMCAD X Version 14.6.10 (7164)

Configuration/WCDMA Band V Mid Body-Left side/Area Scan (5x13x1): Measurement grid: dx=15mm, dy=15mm

Maximum value of SAR (measured) = 0.0698 W/kg

Configuration/WCDMA Band V Mid Body-Left side/Zoom Scan (5x5x7)/Cube 0: Measurement grid: dx=8mm, dy=8mm, dz=5mm, Reference Value = 6.816 V/m; Power Drift = 0.06 dB

Peak SAR (extrapolated) = 0.0940 W/kg

SAR(1 g) = 0.067 W/kg; SAR(10 g) = 0.047 W/kg Maximum value of SAR (measured) = 0.0701 W/kg

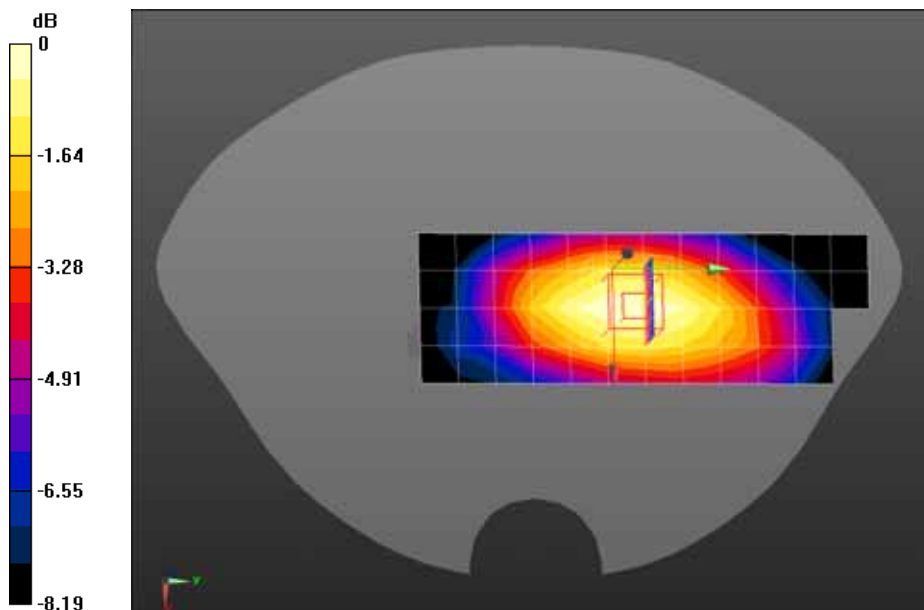

0 dB = 0.0701 W/kg = -11.54 dBW/kg

Date/Time: 01-04-2014

Test Laboratory: QuieTek Lab

WCDMA Band V Mid Body-Bottom

DUT: SMART PHONE; Type: Syreni 50DC II

Communication System: UMTS; Communication System Band: Band V UTRA/FDD; Duty Cycle: 1:1;

Frequency: 836.4 MHz; Medium parameters used: $f = 836.4$ MHz; $\sigma = 0.99$ S/m; $\epsilon_r = 53.71$; $\rho = 1000$ kg/m³ ;

Phantom section: Flat Section

Ambient temperature (°C): 21.5, Liquid temperature (°C): 21.0

DASY5 Configuration:

- Probe: EX3DV4 - SN3710; ConvF(9.22, 9.22, 9.22); Calibrated: 04/03/2014;
- Sensor-Surface: 4mm (Mechanical Surface Detection)
- Electronics: DAE4 Sn1220; Calibrated: 22/01/2014
- Phantom: SAM2; Type: SAM; Serial: TP1562
- Measurement SW: DASY52, Version 52.8 (7); SEMCAD X Version 14.6.10 (7164)

Configuration/WCDMA Band V Mid Body-Bottom/Area Scan (5x7x1): Measurement grid: dx=15mm, dy=15mm

Maximum value of SAR (measured) = 0.0492 W/kg

Configuration/WCDMA Band V Mid Body-Bottom/Zoom Scan (5x5x7)/Cube 0: Measurement grid:

dx=8mm, dy=8mm, dz=5mm, Reference Value = 6.629 V/m; Power Drift = 0.10 dB

Peak SAR (extrapolated) = 0.0790 W/kg

SAR(1 g) = 0.048 W/kg; SAR(10 g) = 0.030 W/kg Maximum value of SAR (measured) = 0.0523 W/kg

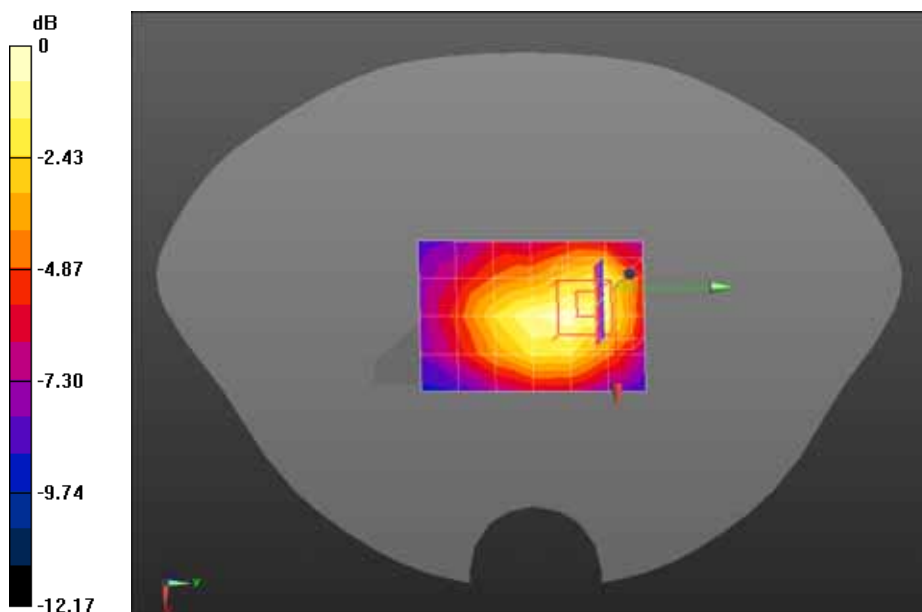

0 dB = 0.0523 W/kg = -12.81 dBW/kg

Appendix C. Test Setup Photographs & EUT Photographs

Test Setup Photographs



Left-Cheek Touch



Left-Tilt 15°

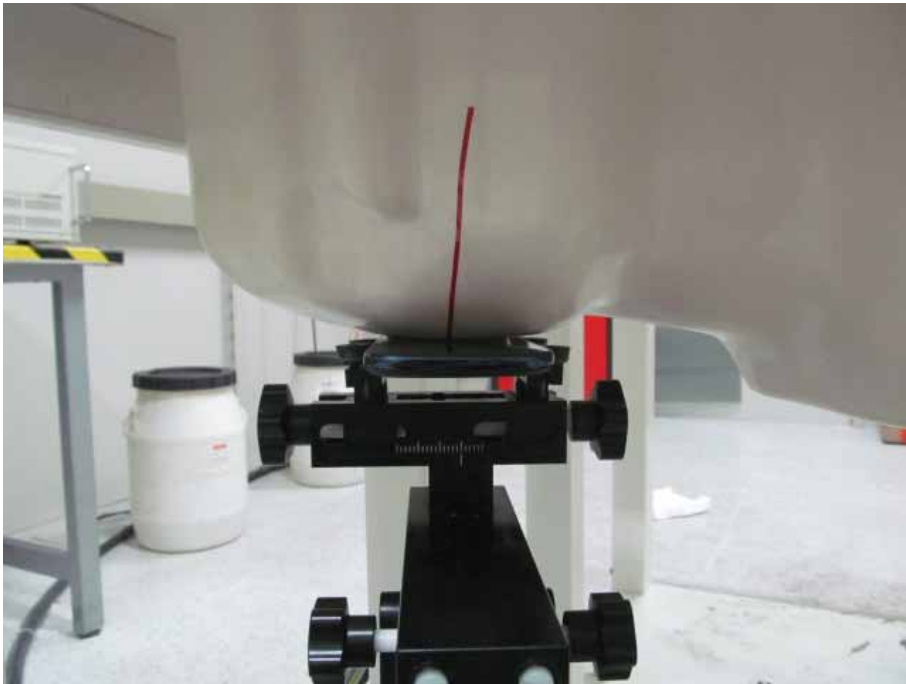

Right-Cheek Touch

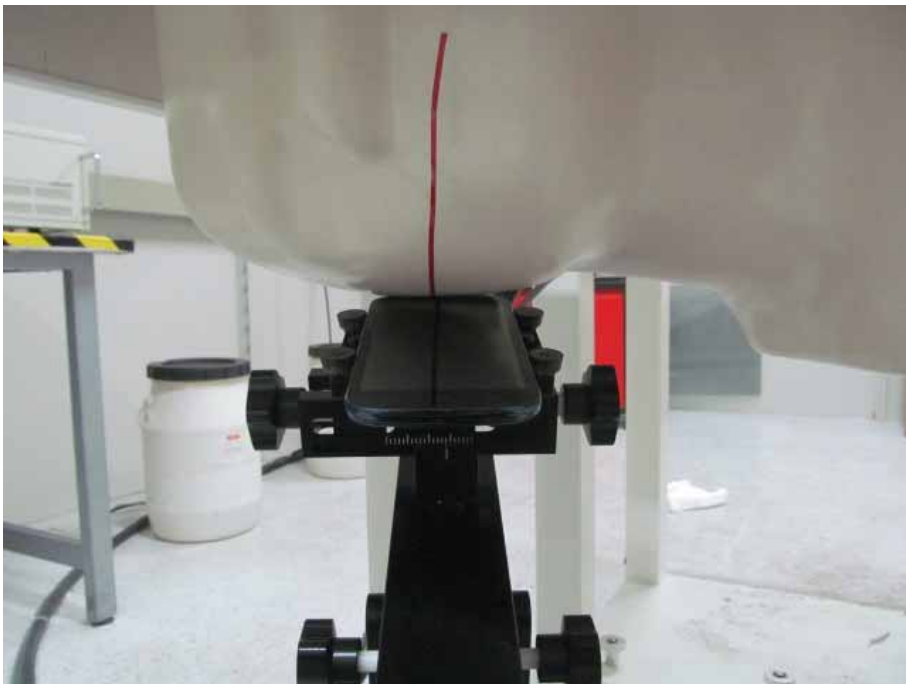

Right-Tilt 15°



Body SAR Back 10mm



Body SAR Front 10mm



Body SAR Bottom 10mm for GSM/UMTS



Body SAR Right Side 10mm for GSM/UMTS



Body SAR Left Side 10mm for GSM/UMTS

Depth of the liquid in the phantom – Zoom in

Note: The position used in the measurements were according to IEEE 1528 - 2003

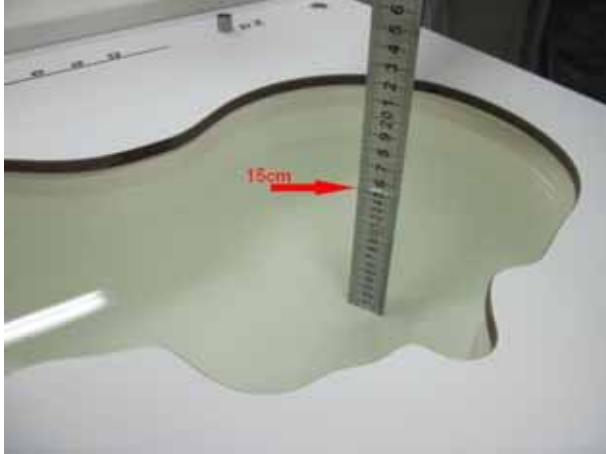

EUT Photographs

(1) EUT Photo



(2) EUT Photo



(3) EUT Photo



(4) EUT Photo



Appendix D. Probe Calibration Data

**Calibration Laboratory of
Schmid & Partner
Engineering AG**
Zeughausstrasse 43, 8004 Zurich, Switzerland



S Schweizerischer Kalibrierdienst
C Service suisse d'étalonnage
S Servizio svizzero di taratura
S Swiss Calibration Service

Accredited by the Swiss Accreditation Service (SAS)
The Swiss Accreditation Service is one of the signatories to the EA
Multilateral Agreement for the recognition of calibration certificates

Accreditation No.: **SCS 108**

Client **Quietek (Auden)**

Certificate No: **EX3-3710_Mar14**

CALIBRATION CERTIFICATE

Object **EX3DV4 - SN:3710**

Calibration procedure(s) **QA CAL-01.v9, QA CAL-12.v9, QA CAL-14.v4, QA CAL-23.v5,
QA CAL-25.v6
Calibration procedure for dosimetric E-field probes**

Calibration date: **March 4, 2014**

This calibration certificate documents the traceability to national standards, which realize the physical units of measurements (SI).
The measurements and the uncertainties with confidence probability are given on the following pages and are part of the certificate.

All calibrations have been conducted in the closed laboratory facility: environment temperature (22 ± 3)°C and humidity < 70%.

Calibration Equipment used (M&TE critical for calibration)

Primary Standards	ID	Cal Date (Certificate No.)	Scheduled Calibration
Power meter E4419B	GB41293874	04-Apr-13 (No. 217-01733)	Apr-14
Power sensor E4412A	MY41498087	04-Apr-13 (No. 217-01733)	Apr-14
Reference 3 dB Attenuator	SN: S5054 (3c)	04-Apr-13 (No. 217-01737)	Apr-14
Reference 20 dB Attenuator	SN: S5277 (20x)	04-Apr-13 (No. 217-01735)	Apr-14
Reference 30 dB Attenuator	SN: S5129 (30b)	04-Apr-13 (No. 217-01738)	Apr-14
Reference Probe ES3DV2	SN: 3013	30-Dec-13 (No. ES3-3013_Dec13)	Dec-14
DAE4	SN: 660	13-Dec-13 (No. DAE4-660_Dec13)	Dec-14
Secondary Standards	ID	Check Date (in house)	Scheduled Check
RF generator HP 8648C	US3642U01700	4-Aug-99 (in house check Apr-13)	In house check: Apr-16
Network Analyzer HP 8753E	US37390585	18-Oct-01 (in house check Oct-13)	In house check: Oct-14

Calibrated by:	Name Jeton Kastrati	Function Laboratory Technician	Signature
Approved by:	Name Katja Pokovic	Function Technical Manager	Signature

Issued: March 4, 2014

This calibration certificate shall not be reproduced except in full without written approval of the laboratory.

**Calibration Laboratory of
Schmid & Partner
Engineering AG**
Zeughausstrasse 43, 8004 Zurich, Switzerland



S Schweizerischer Kalibrierdienst
S Service suisse d'étalonnage
S Servizio svizzero di taratura
S Swiss Calibration Service

Accredited by the Swiss Accreditation Service (SAS)
The Swiss Accreditation Service is one of the signatories to the EA
Multilateral Agreement for the recognition of calibration certificates

Accreditation No.: **SCS 108**

Glossary:

TSL	tissue simulating liquid
NORM _{x,y,z}	sensitivity in free space
ConvF	sensitivity in TSL / NORM _{x,y,z}
DCP	diode compression point
CF	crest factor (1/duty_cycle) of the RF signal
A, B, C, D	modulation dependent linearization parameters
Polarization φ	φ rotation around probe axis
Polarization ϑ	ϑ rotation around an axis that is in the plane normal to probe axis (at measurement center), i.e., $\vartheta = 0$ is normal to probe axis
Connector Angle	information used in DASY system to align probe sensor X to the robot coordinate system

Calibration is Performed According to the Following Standards:

- a) IEEE Std 1528-2013, "IEEE Recommended Practice for Determining the Peak Spatial-Averaged Specific Absorption Rate (SAR) in the Human Head from Wireless Communications Devices: Measurement Techniques", June 2013
- b) IEC 62209-1, "Procedure to measure the Specific Absorption Rate (SAR) for hand-held devices used in close proximity to the ear (frequency range of 300 MHz to 3 GHz)", February 2005

Methods Applied and Interpretation of Parameters:

- **NORM_{x,y,z}:** Assessed for E-field polarization $\vartheta = 0$ ($f \leq 900$ MHz in TEM-cell; $f > 1800$ MHz: R22 waveguide). NORM_{x,y,z} are only intermediate values, i.e., the uncertainties of NORM_{x,y,z} does not affect the E²-field uncertainty inside TSL (see below ConvF).
- **NORM(f)_{x,y,z} = NORM_{x,y,z} * frequency_response** (see Frequency Response Chart). This linearization is implemented in DASY4 software versions later than 4.2. The uncertainty of the frequency response is included in the stated uncertainty of ConvF.
- **DCP_{x,y,z}:** DCP are numerical linearization parameters assessed based on the data of power sweep with CW signal (no uncertainty required). DCP does not depend on frequency nor media.
- **PAR:** PAR is the Peak to Average Ratio that is not calibrated but determined based on the signal characteristics
- **A_{x,y,z}; B_{x,y,z}; C_{x,y,z}; D_{x,y,z}; VR_{x,y,z}:** A, B, C, D are numerical linearization parameters assessed based on the data of power sweep for specific modulation signal. The parameters do not depend on frequency nor media. VR is the maximum calibration range expressed in RMS voltage across the diode.
- **ConvF and Boundary Effect Parameters:** Assessed in flat phantom using E-field (or Temperature Transfer Standard for $f \leq 800$ MHz) and inside waveguide using analytical field distributions based on power measurements for $f > 800$ MHz. The same setups are used for assessment of the parameters applied for boundary compensation (alpha, depth) of which typical uncertainty values are given. These parameters are used in DASY4 software to improve probe accuracy close to the boundary. The sensitivity in TSL corresponds to NORM_{x,y,z} * ConvF whereby the uncertainty corresponds to that given for ConvF. A frequency dependent ConvF is used in DASY version 4.4 and higher which allows extending the validity from ± 50 MHz to ± 100 MHz.
- **Spherical isotropy (3D deviation from isotropy):** in a field of low gradients realized using a flat phantom exposed by a patch antenna.
- **Sensor Offset:** The sensor offset corresponds to the offset of virtual measurement center from the probe tip (on probe axis). No tolerance required.
- **Connector Angle:** The angle is assessed using the information gained by determining the NORM_x (no uncertainty required).

EX3DV4 – SN:3710

March 4, 2014

Probe EX3DV4

SN:3710

Manufactured: July 21, 2009
Calibrated: March 4, 2014

Calibrated for DASY/EASY Systems
(Note: non-compatible with DASY2 system!)

EX3DV4- SN:3710

March 4, 2014

DASY/EASY - Parameters of Probe: EX3DV4 - SN:3710

Basic Calibration Parameters

	Sensor X	Sensor Y	Sensor Z	Unc (k=2)
Norm ($\mu\text{V}/(\text{V}/\text{m})^2$) ^A	0.51	0.56	0.44	± 10.1 %
DCP (mV) ^B	100.3	97.6	101.3	

Modulation Calibration Parameters

UID	Communication System Name		A dB	B dB $\sqrt{\mu\text{V}}$	C	D dB	VR mV	Unc ^E (k=2)
0	CW	X	0.0	0.0	1.0	0.00	137.9	±3.5 %
		Y	0.0	0.0	1.0		136.7	
		Z	0.0	0.0	1.0		139.8	

The reported uncertainty of measurement is stated as the standard uncertainty of measurement multiplied by the coverage factor k=2, which for a normal distribution corresponds to a coverage probability of approximately 95%.

^A The uncertainties of NormX,Y,Z do not affect the E²-field uncertainty inside TSL (see Pages 5 and 6).

^B Numerical linearization parameter: uncertainty not required.

^E Uncertainty is determined using the max. deviation from linear response applying rectangular distribution and is expressed for the square of the field value.

EX3DV4- SN:3710

March 4, 2014

DASY/EASY - Parameters of Probe: EX3DV4 - SN:3710

Calibration Parameter Determined in Head Tissue Simulating Media

f (MHz) ^C	Relative Permittivity ^F	Conductivity (S/m) ^F	ConvF X	ConvF Y	ConvF Z	Alpha ^G	Depth ^G (mm)	Unct. (k=2)
450	43.5	0.87	10.42	10.42	10.42	0.17	2.22	± 13.3 %
750	41.9	0.89	9.76	9.76	9.76	0.62	0.69	± 12.0 %
835	41.5	0.90	9.56	9.56	9.56	0.57	0.69	± 12.0 %
900	41.5	0.97	9.42	9.42	9.42	0.53	0.72	± 12.0 %
1810	40.0	1.40	7.74	7.74	7.74	0.41	0.94	± 12.0 %
1900	40.0	1.40	7.72	7.72	7.72	0.49	0.85	± 12.0 %
2450	39.2	1.80	7.04	7.04	7.04	0.39	1.03	± 12.0 %
2600	39.0	1.96	6.87	6.87	6.87	0.60	0.80	± 12.0 %
3500	37.9	2.91	6.82	6.82	6.82	0.55	0.88	± 13.1 %
5200	36.0	4.66	4.91	4.91	4.91	0.40	1.80	± 13.1 %
5500	35.6	4.96	4.63	4.63	4.63	0.40	1.80	± 13.1 %
5800	35.3	5.27	4.43	4.43	4.43	0.40	1.80	± 13.1 %

^C Frequency validity of ± 100 MHz only applies for DASY v4.4 and higher (see Page 2), else it is restricted to ± 50 MHz. The uncertainty is the RSS of the ConvF uncertainty at calibration frequency and the uncertainty for the indicated frequency band.

^F At frequencies below 3 GHz, the validity of tissue parameters (ϵ and σ) can be relaxed to ± 10% if liquid compensation formula is applied to measured SAR values. At frequencies above 3 GHz, the validity of tissue parameters (ϵ and σ) is restricted to ± 5%. The uncertainty is the RSS of the ConvF uncertainty for indicated target tissue parameters.

^G Alpha/Depth are determined during calibration. SPEAG warrants that the remaining deviation due to the boundary effect after compensation is always less than ± 1% for frequencies below 3 GHz and below ± 2% for frequencies between 3-6 GHz at any distance larger than half the probe tip diameter from the boundary.

EX3DV4- SN:3710

March 4, 2014

DASY/EASY - Parameters of Probe: EX3DV4 - SN:3710

Calibration Parameter Determined in Body Tissue Simulating Media

f (MHz) ^C	Relative Permittivity ^F	Conductivity (S/m) ^F	ConvF X	ConvF Y	ConvF Z	Alpha ^G	Depth (mm) ^G	Unct. (k=2)
450	56.7	0.94	10.53	10.53	10.53	0.10	1.00	± 13.3 %
750	55.5	0.96	9.28	9.28	9.28	0.39	0.93	± 12.0 %
835	55.2	0.97	9.22	9.22	9.22	0.65	0.72	± 12.0 %
900	55.0	1.05	9.04	9.04	9.04	0.75	0.67	± 12.0 %
1810	53.3	1.52	7.36	7.36	7.36	0.80	0.62	± 12.0 %
1900	53.3	1.52	7.25	7.25	7.25	0.55	0.76	± 12.0 %
2450	52.7	1.95	6.88	6.88	6.88	0.80	0.58	± 12.0 %
2600	52.5	2.16	6.67	6.67	6.67	0.80	0.50	± 12.0 %
3500	51.3	3.31	6.29	6.29	6.29	0.44	1.02	± 13.1 %
5200	49.0	5.30	4.22	4.22	4.22	0.50	1.90	± 13.1 %
5500	48.6	5.65	3.91	3.91	3.91	0.50	1.90	± 13.1 %
5800	48.2	6.00	4.00	4.00	4.00	0.50	1.90	± 13.1 %

^C Frequency validity of ± 100 MHz only applies for DASY v4.4 and higher (see Page 2), else it is restricted to ± 50 MHz. The uncertainty is the RSS of the ConvF uncertainty at calibration frequency and the uncertainty for the indicated frequency band.

^F At frequencies below 3 GHz, the validity of tissue parameters (ϵ and σ) can be relaxed to ± 10% if liquid compensation formula is applied to measured SAR values. At frequencies above 3 GHz, the validity of tissue parameters (ϵ and σ) is restricted to ± 5%. The uncertainty is the RSS of the ConvF uncertainty for indicated target tissue parameters.

^G Alpha/Depth are determined during calibration. SPEAG warrants that the remaining deviation due to the boundary effect after compensation is always less than ± 1% for frequencies below 3 GHz and below ± 2% for frequencies between 3-6 GHz at any distance larger than half the probe tip diameter from the boundary.

EX3DV4-SN:3710

March 4, 2014

Frequency Response of E-Field (TEM-Cell: ifi1110 EXX, Waveguide: R22)

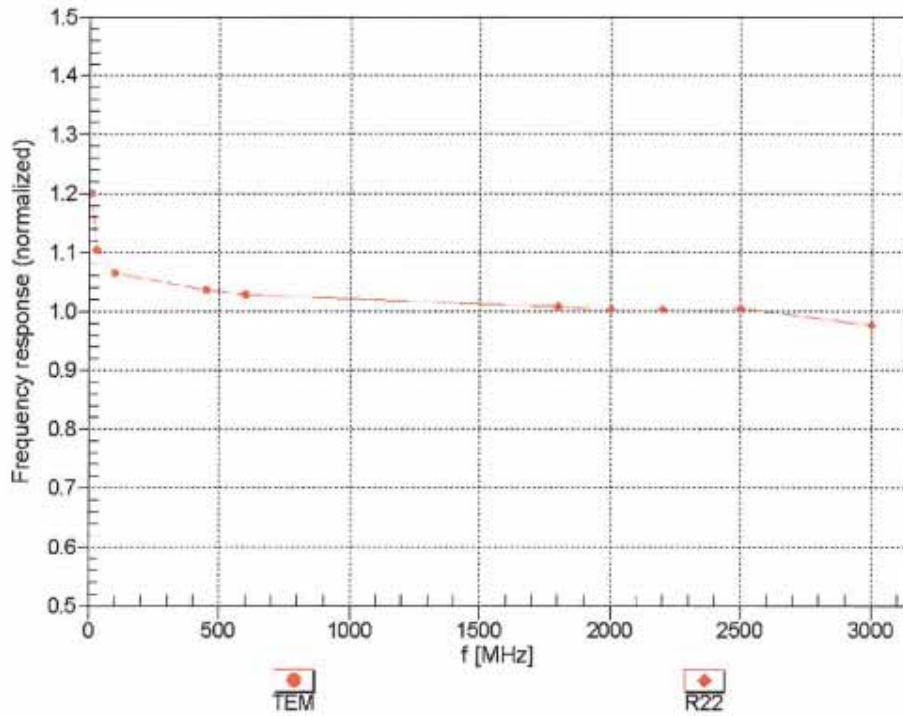

Uncertainty of Frequency Response of E-field: $\pm 6.3\%$ (k=2)

EX3DV4- SN:3710

March 4, 2014

Receiving Pattern (ϕ), $\theta = 0^\circ$

f=600 MHz,TEM

f=1800 MHz,R22

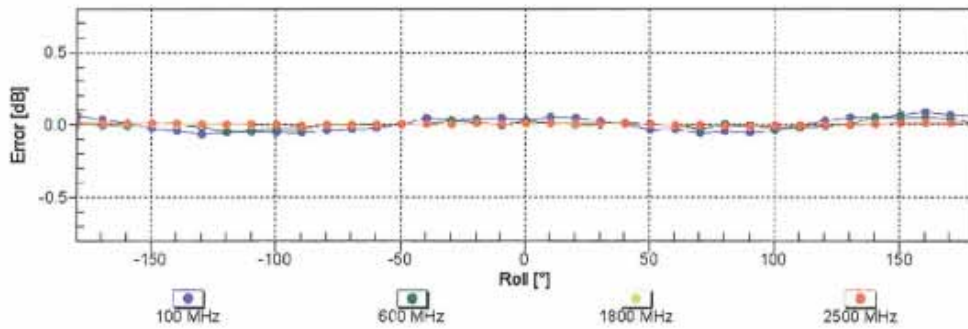
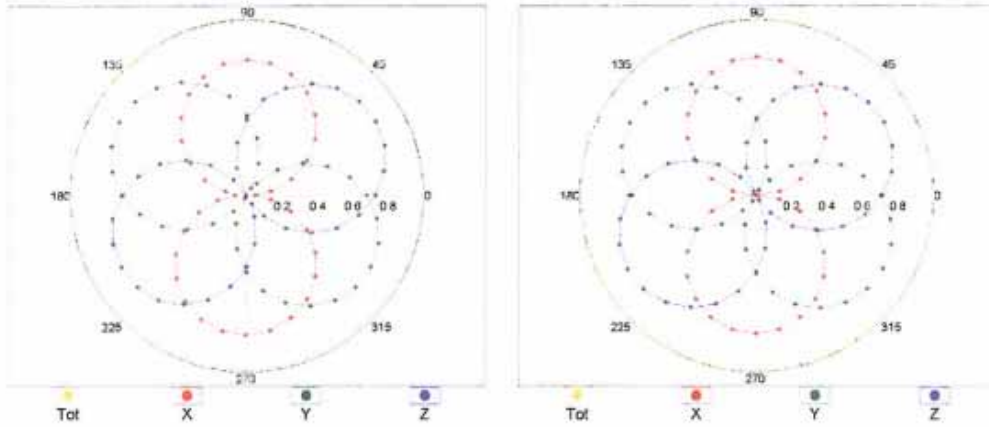

Uncertainty of Axial Isotropy Assessment: $\pm 0.5\%$ (k=2)

EX3DV4- SN:3710

March 4, 2014

Dynamic Range $f(SAR_{head})$
 (TEM cell , $f_{eval}=1900$ MHz)

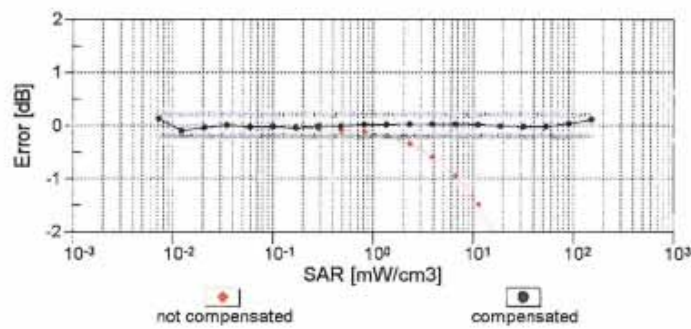
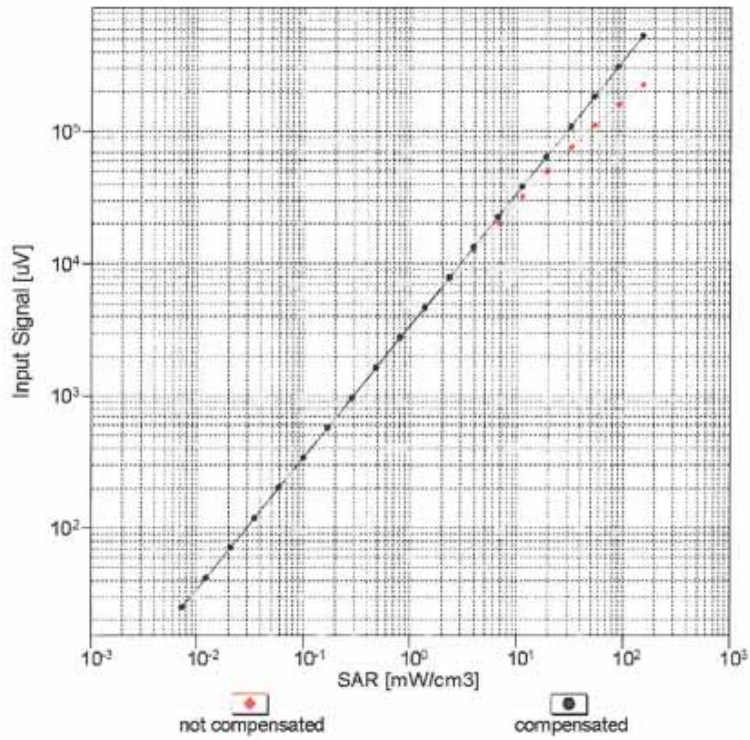

Uncertainty of Linearity Assessment: $\pm 0.6\%$ ($k=2$)

EX3DV4- SN:3710

March 4, 2014

Conversion Factor Assessment

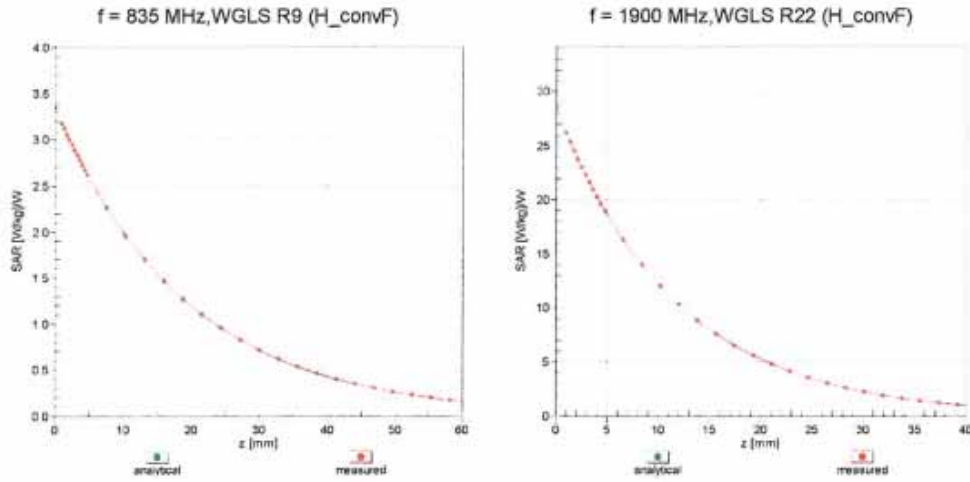

Deviation from Isotropy in Liquid Error (ϕ, θ), f = 900 MHz

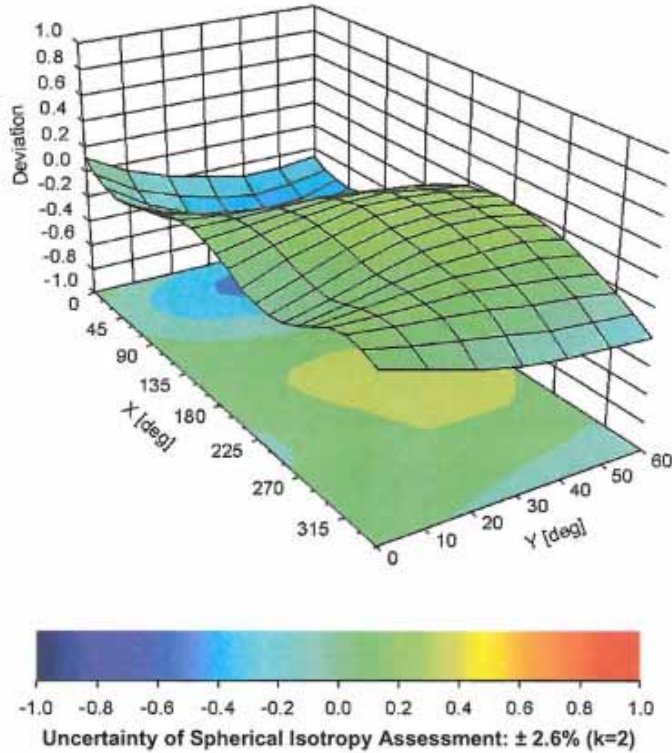

EX3DV4- SN:3710

March 4, 2014

DASY/EASY - Parameters of Probe: EX3DV4 - SN:3710

Other Probe Parameters

Sensor Arrangement	Triangular
Connector Angle (°)	-19.6
Mechanical Surface Detection Mode	enabled
Optical Surface Detection Mode	disabled
Probe Overall Length	337 mm
Probe Body Diameter	10 mm
Tip Length	9 mm
Tip Diameter	2.5 mm
Probe Tip to Sensor X Calibration Point	1 mm
Probe Tip to Sensor Y Calibration Point	1 mm
Probe Tip to Sensor Z Calibration Point	1 mm
Recommended Measurement Distance from Surface	2 mm

Appendix E. Dipole Calibration Data

**Calibration Laboratory of
Schmid & Partner
Engineering AG**
Zeughausstrasse 43, 8004 Zurich, Switzerland



S Schweizerischer Kalibrierdienst
C Service suisse d'étalonnage
S Servizio svizzero di taratura
S Swiss Calibration Service

Accredited by the Swiss Accreditation Service (SAS)
The Swiss Accreditation Service is one of the signatories to the EA
Multilateral Agreement for the recognition of calibration certificates

Accreditation No.: **SCS 108**

Client **Quietek-CN (Auden)**

Certificate No: **D835V2-4d094_Feb14**

CALIBRATION CERTIFICATE																																															
Object	D835V2 - SN: 4d094																																														
Calibration procedure(s)	QA CAL-05.v9 Calibration procedure for dipole validation kits above 700 MHz																																														
Calibration date:	February 27, 2014																																														
<p>This calibration certificate documents the traceability to national standards, which realize the physical units of measurements (SI). The measurements and the uncertainties with confidence probability are given on the following pages and are part of the certificate.</p> <p>All calibrations have been conducted in the closed laboratory facility: environment temperature (22 ± 3)°C and humidity < 70%.</p> <p>Calibration Equipment used (M&TE critical for calibration)</p> <table border="1"> <thead> <tr> <th>Primary Standards</th> <th>ID #</th> <th>Cal Date (Certificate No.)</th> <th>Scheduled Calibration</th> </tr> </thead> <tbody> <tr> <td>Power meter EPM-442A</td> <td>GB37480704</td> <td>09-Oct-13 (No. 217-01827)</td> <td>Oct-14</td> </tr> <tr> <td>Power sensor HP 8481A</td> <td>US37292783</td> <td>09-Oct-13 (No. 217-01827)</td> <td>Oct-14</td> </tr> <tr> <td>Power sensor HP 8481A</td> <td>MY41092317</td> <td>09-Oct-13 (No. 217-01828)</td> <td>Oct-14</td> </tr> <tr> <td>Reference 20 dB Attenuator</td> <td>SN: 5058 (20k)</td> <td>04-Apr-13 (No. 217-01736)</td> <td>Apr-14</td> </tr> <tr> <td>Type-N mismatch combination</td> <td>SN: 5047.3 / 06327</td> <td>04-Apr-13 (No. 217-01739)</td> <td>Apr-14</td> </tr> <tr> <td>Reference Probe ES3DV3</td> <td>SN: 3205</td> <td>30-Dec-13 (No. ES3-3205_Dec13)</td> <td>Dec-14</td> </tr> <tr> <td>DAE4</td> <td>SN: 601</td> <td>25-Apr-13 (No. DAE4-601_Apr13)</td> <td>Apr-14</td> </tr> </tbody> </table> <table border="1"> <thead> <tr> <th>Secondary Standards</th> <th>ID #</th> <th>Check Date (in house)</th> <th>Scheduled Check</th> </tr> </thead> <tbody> <tr> <td>RF generator R&S SMT-06</td> <td>100005</td> <td>04-Aug-99 (in house check Oct-13)</td> <td>In house check: Oct-16</td> </tr> <tr> <td>Network Analyzer HP 8753E</td> <td>US37390585 S4206</td> <td>18-Oct-01 (in house check Oct-13)</td> <td>In house check: Oct-14</td> </tr> </tbody> </table>				Primary Standards	ID #	Cal Date (Certificate No.)	Scheduled Calibration	Power meter EPM-442A	GB37480704	09-Oct-13 (No. 217-01827)	Oct-14	Power sensor HP 8481A	US37292783	09-Oct-13 (No. 217-01827)	Oct-14	Power sensor HP 8481A	MY41092317	09-Oct-13 (No. 217-01828)	Oct-14	Reference 20 dB Attenuator	SN: 5058 (20k)	04-Apr-13 (No. 217-01736)	Apr-14	Type-N mismatch combination	SN: 5047.3 / 06327	04-Apr-13 (No. 217-01739)	Apr-14	Reference Probe ES3DV3	SN: 3205	30-Dec-13 (No. ES3-3205_Dec13)	Dec-14	DAE4	SN: 601	25-Apr-13 (No. DAE4-601_Apr13)	Apr-14	Secondary Standards	ID #	Check Date (in house)	Scheduled Check	RF generator R&S SMT-06	100005	04-Aug-99 (in house check Oct-13)	In house check: Oct-16	Network Analyzer HP 8753E	US37390585 S4206	18-Oct-01 (in house check Oct-13)	In house check: Oct-14
Primary Standards	ID #	Cal Date (Certificate No.)	Scheduled Calibration																																												
Power meter EPM-442A	GB37480704	09-Oct-13 (No. 217-01827)	Oct-14																																												
Power sensor HP 8481A	US37292783	09-Oct-13 (No. 217-01827)	Oct-14																																												
Power sensor HP 8481A	MY41092317	09-Oct-13 (No. 217-01828)	Oct-14																																												
Reference 20 dB Attenuator	SN: 5058 (20k)	04-Apr-13 (No. 217-01736)	Apr-14																																												
Type-N mismatch combination	SN: 5047.3 / 06327	04-Apr-13 (No. 217-01739)	Apr-14																																												
Reference Probe ES3DV3	SN: 3205	30-Dec-13 (No. ES3-3205_Dec13)	Dec-14																																												
DAE4	SN: 601	25-Apr-13 (No. DAE4-601_Apr13)	Apr-14																																												
Secondary Standards	ID #	Check Date (in house)	Scheduled Check																																												
RF generator R&S SMT-06	100005	04-Aug-99 (in house check Oct-13)	In house check: Oct-16																																												
Network Analyzer HP 8753E	US37390585 S4206	18-Oct-01 (in house check Oct-13)	In house check: Oct-14																																												
Calibrated by:	Name Jeton Kastrati	Function Laboratory Technician	Signature 																																												
Approved by:	Name Katja Pokovic	Function Technical Manager	Signature 																																												
			Issued: February 28, 2014																																												
This calibration certificate shall not be reproduced except in full without written approval of the laboratory.																																															

**Calibration Laboratory of
Schmid & Partner
Engineering AG**
Zeughausstrasse 43, 8004 Zurich, Switzerland



S Schweizerischer Kalibrierdienst
C Service suisse d'étalonnage
S Servizio svizzero di taratura
S Swiss Calibration Service

Accredited by the Swiss Accreditation Service (SAS)
The Swiss Accreditation Service is one of the signatories to the EA
Multilateral Agreement for the recognition of calibration certificates

Accreditation No.: **SCS 108**

Glossary:

TSL	tissue simulating liquid
ConvF	sensitivity in TSL / NORM x,y,z
N/A	not applicable or not measured

Calibration is Performed According to the Following Standards:

- a) IEEE Std 1528-2013, "IEEE Recommended Practice for Determining the Peak Spatial-Averaged Specific Absorption Rate (SAR) in the Human Head from Wireless Communications Devices: Measurement Techniques", June 2013
- b) IEC 62209-1, "Procedure to measure the Specific Absorption Rate (SAR) for hand-held devices used in close proximity to the ear (frequency range of 300 MHz to 3 GHz)", February 2005
- c) KDB 865664, "SAR Measurement Requirements for 100 MHz to 6 GHz"

Additional Documentation:

- d) DASY4/5 System Handbook

Methods Applied and Interpretation of Parameters:

- *Measurement Conditions:* Further details are available from the Validation Report at the end of the certificate. All figures stated in the certificate are valid at the frequency indicated.
- *Antenna Parameters with TSL:* The dipole is mounted with the spacer to position its feed point exactly below the center marking of the flat phantom section, with the arms oriented parallel to the body axis.
- *Feed Point Impedance and Return Loss:* These parameters are measured with the dipole positioned under the liquid filled phantom. The impedance stated is transformed from the measurement at the SMA connector to the feed point. The Return Loss ensures low reflected power. No uncertainty required.
- *Electrical Delay:* One-way delay between the SMA connector and the antenna feed point. No uncertainty required.
- *SAR measured:* SAR measured at the stated antenna input power.
- *SAR normalized:* SAR as measured, normalized to an input power of 1 W at the antenna connector.
- *SAR for nominal TSL parameters:* The measured TSL parameters are used to calculate the nominal SAR result.

The reported uncertainty of measurement is stated as the standard uncertainty of measurement multiplied by the coverage factor $k=2$, which for a normal distribution corresponds to a coverage probability of approximately 95%.

Measurement Conditions

DASY system configuration, as far as not given on page 1.

DASY Version	DASY5	V52.8.7
Extrapolation	Advanced Extrapolation	
Phantom	Modular Flat Phantom	
Distance Dipole Center - TSL	15 mm	with Spacer
Zoom Scan Resolution	dx, dy, dz = 5 mm	
Frequency	835 MHz ± 1 MHz	

Head TSL parameters

The following parameters and calculations were applied.

	Temperature	Permittivity	Conductivity
Nominal Head TSL parameters	22.0 °C	41.5	0.90 mho/m
Measured Head TSL parameters	(22.0 ± 0.2) °C	40.5 ± 6 %	0.93 mho/m ± 6 %
Head TSL temperature change during test	< 0.5 °C	----	----

SAR result with Head TSL

SAR averaged over 1 cm ³ (1 g) of Head TSL	Condition	
SAR measured	250 mW input power	2.47 W/kg
SAR for nominal Head TSL parameters	normalized to 1W	9.59 W/kg ± 17.0 % (k=2)

SAR averaged over 10 cm ³ (10 g) of Head TSL	condition	
SAR measured	250 mW input power	1.59 W/kg
SAR for nominal Head TSL parameters	normalized to 1W	6.21 W/kg ± 16.5 % (k=2)

Body TSL parameters

The following parameters and calculations were applied.

	Temperature	Permittivity	Conductivity
Nominal Body TSL parameters	22.0 °C	55.2	0.97 mho/m
Measured Body TSL parameters	(22.0 ± 0.2) °C	54.0 ± 6 %	1.00 mho/m ± 6 %
Body TSL temperature change during test	< 0.5 °C	----	----

SAR result with Body TSL

SAR averaged over 1 cm ³ (1 g) of Body TSL	Condition	
SAR measured	250 mW input power	2.42 W/kg
SAR for nominal Body TSL parameters	normalized to 1W	9.42 W/kg ± 17.0 % (k=2)

SAR averaged over 10 cm ³ (10 g) of Body TSL	condition	
SAR measured	250 mW input power	1.57 W/kg
SAR for nominal Body TSL parameters	normalized to 1W	6.15 W/kg ± 16.5 % (k=2)

Appendix

Antenna Parameters with Head TSL

Impedance, transformed to feed point	51.4 Ω - 2.8 j Ω
Return Loss	- 30.2 dB

Antenna Parameters with Body TSL

Impedance, transformed to feed point	46.9 Ω - 5.0 j Ω
Return Loss	- 24.3 dB

General Antenna Parameters and Design

Electrical Delay (one direction)	1.386 ns
----------------------------------	----------

After long term use with 100W radiated power, only a slight warming of the dipole near the feedpoint can be measured.

The dipole is made of standard semirigid coaxial cable. The center conductor of the feeding line is directly connected to the second arm of the dipole. The antenna is therefore short-circuited for DC-signals. On some of the dipoles, small end caps are added to the dipole arms in order to improve matching when loaded according to the position as explained in the "Measurement Conditions" paragraph. The SAR data are not affected by this change. The overall dipole length is still according to the Standard.

No excessive force must be applied to the dipole arms, because they might bend or the soldered connections near the feedpoint may be damaged.

Additional EUT Data

Manufactured by	SPEAG
Manufactured on	September 15, 2009

DASY5 Validation Report for Head TSL

Date: 27.02.2014

Test Laboratory: SPEAG, Zurich, Switzerland

DUT: Dipole 835 MHz; Type: D835V2; Serial: D835V2 - SN: 4d094

Communication System: UID 0 - CW; Frequency: 835 MHz

Medium parameters used: $f = 835$ MHz; $\sigma = 0.93$ S/m; $\epsilon_r = 40.5$; $\rho = 1000$ kg/m³

Phantom section: Flat Section

Measurement Standard: DASY5 (IEEE/IEC/ANSI C63.19-2007)

DASY52 Configuration:

- Probe: ES3DV3 - SN3205; ConvF(6.22, 6.22, 6.22); Calibrated: 30.12.2013;
- Sensor-Surface: 3mm (Mechanical Surface Detection)
- Electronics: DAE4 Sn601; Calibrated: 25.04.2013
- Phantom: Flat Phantom 4.9L; Type: QD000P49AA; Serial: 1001
- DASY52 52.8.7(1137); SEMCAD X 14.6.10(7164)

Dipole Calibration for Head Tissue/Pin=250 mW, d=15mm/Zoom Scan (7x7x7)/Cube 0:

Measurement grid: dx=5mm, dy=5mm, dz=5mm

Reference Value = 59.179 V/m; Power Drift = -0.01 dB

Peak SAR (extrapolated) = 3.80 W/kg

SAR(1 g) = 2.47 W/kg; SAR(10 g) = 1.59 W/kg

Maximum value of SAR (measured) = 2.91 W/kg

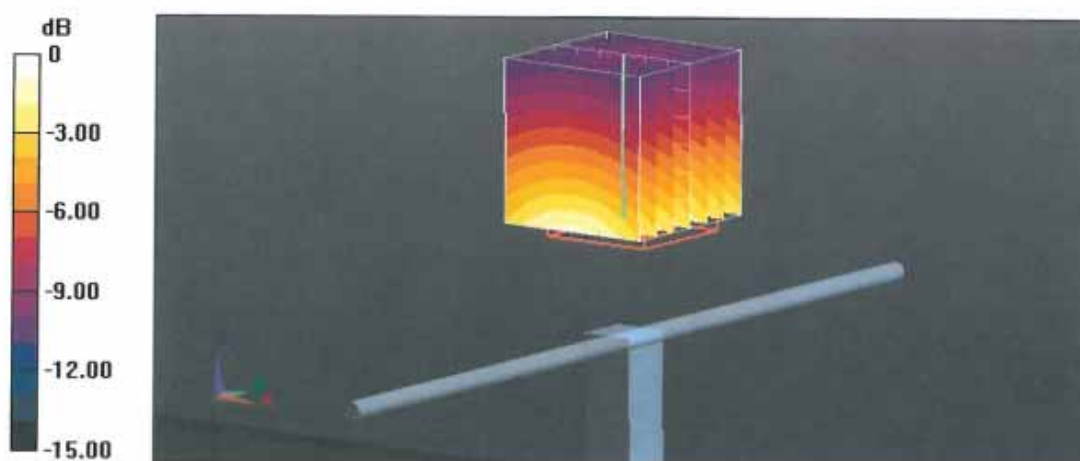

0 dB = 2.91 W/kg = 4.64 dBW/kg

Impedance Measurement Plot for Head TSL

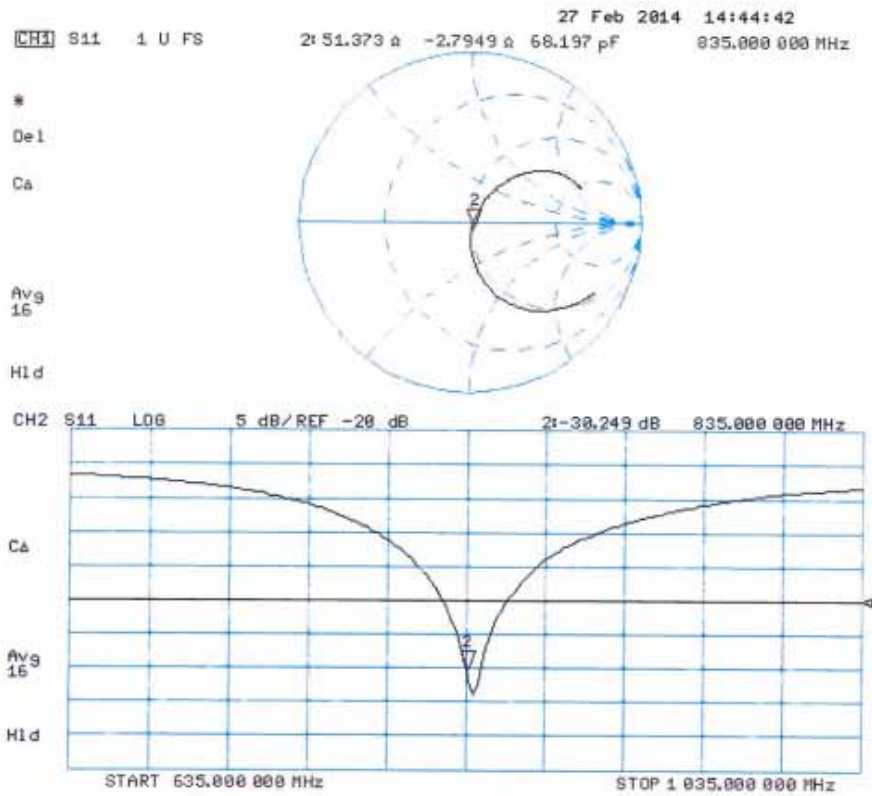

DASY5 Validation Report for Body TSL

Date: 27.02.2014

Test Laboratory: SPEAG, Zurich, Switzerland

DUT: Dipole 835 MHz; Type: D835V2; Serial: D835V2 - SN: 4d094

Communication System: UID 0 - CW; Frequency: 835 MHz

Medium parameters used: $f = 835$ MHz; $\sigma = 1$ S/m; $\epsilon_r = 54$; $\rho = 1000$ kg/m³

Phantom section: Flat Section

Measurement Standard: DASY5 (IEEE/IEC/ANSI C63.19-2007)

DASY52 Configuration:

- Probe: ES3DV3 - SN3205; ConvF(6.09, 6.09, 6.09); Calibrated: 30.12.2013;
- Sensor-Surface: 3mm (Mechanical Surface Detection)
- Electronics: DAE4 Sn601; Calibrated: 25.04.2013
- Phantom: Flat Phantom 4.9L; Type: QD000P49AA; Serial: 1001
- DASY52 52.8.7(1137); SEMCAD X 14.6.10(7164)

Dipole Calibration for Body Tissue/Pin=250 mW, d=15mm/Zoom Scan (7x7x7)/Cube 0:

Measurement grid: dx=5mm, dy=5mm, dz=5mm

Reference Value = 55.012 V/m; Power Drift = 0.01 dB

Peak SAR (extrapolated) = 3.62 W/kg

SAR(1 g) = 2.42 W/kg; SAR(10 g) = 1.57 W/kg

Maximum value of SAR (measured) = 2.82 W/kg

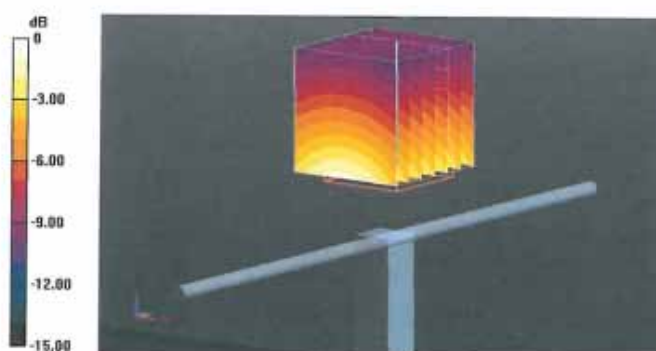

0 dB = 2.82 W/kg = 4.50 dBW/kg

Impedance Measurement Plot for Body TSL

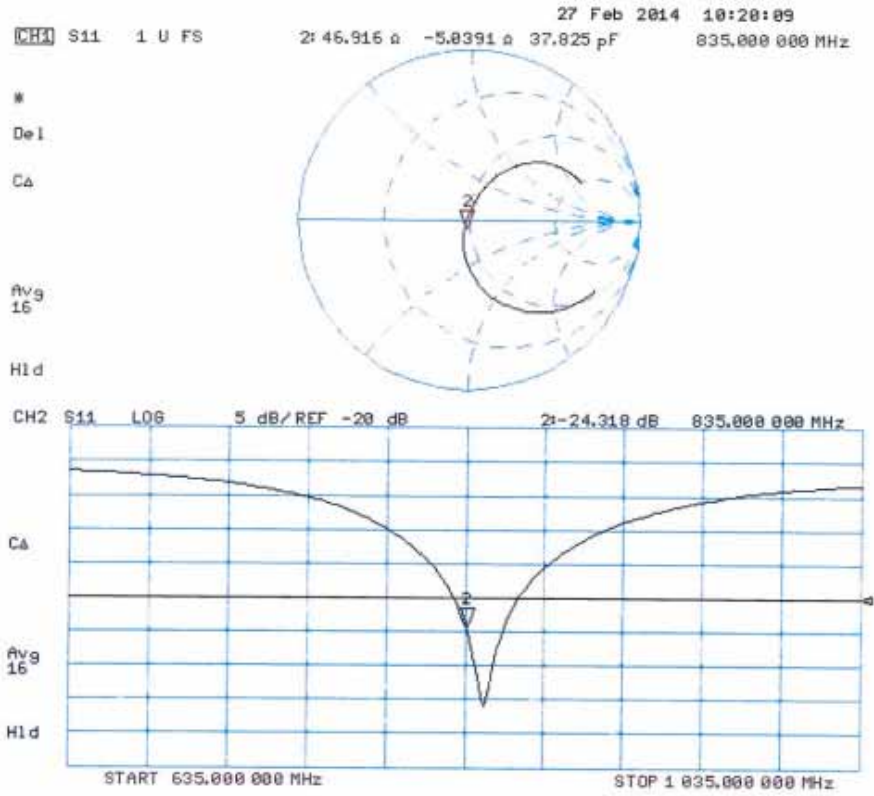

**Calibration Laboratory of
Schmid & Partner
Engineering AG**
Zeughausstrasse 43, 8004 Zurich, Switzerland



S Schweizerischer Kalibrierdienst
C Service suisse d'étalonnage
S Servizio svizzero di taratura
S Swiss Calibration Service

Accredited by the Swiss Accreditation Service (SAS)
The Swiss Accreditation Service is one of the signatories to the EA
Multilateral Agreement for the recognition of calibration certificates

Accreditation No.: **SCS 108**

Client **Quietek-CN (Auden)**

Certificate No: **D1900V2-5d121_Feb14**

CALIBRATION CERTIFICATE

Object: **D1900V2 - SN: 5d121**

Calibration procedure(s): **QA CAL-05.v9
Calibration procedure for dipole validation kits above 700 MHz**

Calibration date: **February 27, 2014**

This calibration certificate documents the traceability to national standards, which realize the physical units of measurements (SI).
The measurements and the uncertainties with confidence probability are given on the following pages and are part of the certificate.

All calibrations have been conducted in the closed laboratory facility: environment temperature (22 ± 3)°C and humidity < 70%.

Calibration Equipment used (M&TE critical for calibration)

Primary Standards	ID #	Cal Date (Certificate No.)	Scheduled Calibration
Power meter EPM-442A	GB37480704	09-Oct-13 (No. 217-01827)	Oct-14
Power sensor HP 8481A	US37292783	09-Oct-13 (No. 217-01827)	Oct-14
Power sensor HP 8481A	MY41092317	09-Oct-13 (No. 217-01828)	Oct-14
Reference 20 dB Attenuator	SN: 5058 (20k)	04-Apr-13 (No. 217-01736)	Apr-14
Type-N mismatch combination	SN: 5047.3 / 06327	04-Apr-13 (No. 217-01739)	Apr-14
Reference Probe ES3DV3	SN: 3205	30-Dec-13 (No. ES3-3205_Dec13)	Dec-14
DAE4	SN: 601	25-Apr-13 (No. DAE4-601_Apr13)	Apr-14
Secondary Standards	ID #	Check Date (in house)	Scheduled Check
RF generator R&S SMT-06	100005	04-Aug-99 (in house check Oct-13)	In house check: Oct-16
Network Analyzer HP 8753E	US37390585 S4206	18-Oct-01 (in house check Oct-13)	In house check: Oct-14

Calibrated by:	Name Jeton Kastrati	Function Laboratory Technician	Signature
Approved by:	Name Katja Pokovic	Technical Manager	

Issued: February 28, 2014

This calibration certificate shall not be reproduced except in full without written approval of the laboratory.

**Calibration Laboratory of
Schmid & Partner
Engineering AG**
Zeughausstrasse 43, 8004 Zurich, Switzerland



S Schweizerischer Kalibrierdienst
C Service suisse d'étalonnage
S Servizio svizzero di taratura
S Swiss Calibration Service

Accredited by the Swiss Accreditation Service (SAS)
The Swiss Accreditation Service is one of the signatories to the EA
Multilateral Agreement for the recognition of calibration certificates

Accreditation No.: **SCS 108**

Glossary:

TSL	tissue simulating liquid
ConvF	sensitivity in TSL / NORM x,y,z
N/A	not applicable or not measured

Calibration is Performed According to the Following Standards:

- IEEE Std 1528-2013, "IEEE Recommended Practice for Determining the Peak Spatial-Averaged Specific Absorption Rate (SAR) in the Human Head from Wireless Communications Devices: Measurement Techniques", June 2013
- IEC 62209-1, "Procedure to measure the Specific Absorption Rate (SAR) for hand-held devices used in close proximity to the ear (frequency range of 300 MHz to 3 GHz)", February 2005
- KDB 865664, "SAR Measurement Requirements for 100 MHz to 6 GHz"

Additional Documentation:

- DASY4/5 System Handbook

Methods Applied and Interpretation of Parameters:

- Measurement Conditions:* Further details are available from the Validation Report at the end of the certificate. All figures stated in the certificate are valid at the frequency indicated.
- Antenna Parameters with TSL:* The dipole is mounted with the spacer to position its feed point exactly below the center marking of the flat phantom section, with the arms oriented parallel to the body axis.
- Feed Point Impedance and Return Loss:* These parameters are measured with the dipole positioned under the liquid filled phantom. The impedance stated is transformed from the measurement at the SMA connector to the feed point. The Return Loss ensures low reflected power. No uncertainty required.
- Electrical Delay:* One-way delay between the SMA connector and the antenna feed point. No uncertainty required.
- SAR measured:* SAR measured at the stated antenna input power.
- SAR normalized:* SAR as measured, normalized to an input power of 1 W at the antenna connector.
- SAR for nominal TSL parameters:* The measured TSL parameters are used to calculate the nominal SAR result.

The reported uncertainty of measurement is stated as the standard uncertainty of measurement multiplied by the coverage factor $k=2$, which for a normal distribution corresponds to a coverage probability of approximately 95%.

Measurement Conditions

DASY system configuration, as far as not given on page 1.

DASY Version	DASY5	V52.8.7
Extrapolation	Advanced Extrapolation	
Phantom	Modular Flat Phantom	
Distance Dipole Center - TSL	10 mm	with Spacer
Zoom Scan Resolution	dx, dy, dz = 5 mm	
Frequency	1900 MHz ± 1 MHz	

Head TSL parameters

The following parameters and calculations were applied.

	Temperature	Permittivity	Conductivity
Nominal Head TSL parameters	22.0 °C	40.0	1.40 mho/m
Measured Head TSL parameters	(22.0 ± 0.2) °C	38.9 ± 6 %	1.39 mho/m ± 6 %
Head TSL temperature change during test	< 0.5 °C	----	----

SAR result with Head TSL

SAR averaged over 1 cm ³ (1 g) of Head TSL	Condition	
SAR measured	250 mW input power	10.3 W/kg
SAR for nominal Head TSL parameters	normalized to 1W	41.1 W/kg ± 17.0 % (k=2)

SAR averaged over 10 cm ³ (10 g) of Head TSL	condition	
SAR measured	250 mW input power	5.34 W/kg
SAR for nominal Head TSL parameters	normalized to 1W	21.3 W/kg ± 16.5 % (k=2)

Body TSL parameters

The following parameters and calculations were applied.

	Temperature	Permittivity	Conductivity
Nominal Body TSL parameters	22.0 °C	53.3	1.52 mho/m
Measured Body TSL parameters	(22.0 ± 0.2) °C	52.8 ± 6 %	1.49 mho/m ± 6 %
Body TSL temperature change during test	< 0.5 °C	----	----

SAR result with Body TSL

SAR averaged over 1 cm ³ (1 g) of Body TSL	Condition	
SAR measured	250 mW input power	9.83 W/kg
SAR for nominal Body TSL parameters	normalized to 1W	39.7 W/kg ± 17.0 % (k=2)

SAR averaged over 10 cm ³ (10 g) of Body TSL	condition	
SAR measured	250 mW input power	5.20 W/kg
SAR for nominal Body TSL parameters	normalized to 1W	20.9 W/kg ± 16.5 % (k=2)

Appendix

Antenna Parameters with Head TSL

Impedance, transformed to feed point	50.8 Ω + 6.6 j Ω
Return Loss	- 23.6 dB

Antenna Parameters with Body TSL

Impedance, transformed to feed point	46.3 Ω + 7.2 j Ω
Return Loss	- 21.6 dB

General Antenna Parameters and Design

Electrical Delay (one direction)	1.202 ns
----------------------------------	----------

After long term use with 100W radiated power, only a slight warming of the dipole near the feedpoint can be measured.

The dipole is made of standard semirigid coaxial cable. The center conductor of the feeding line is directly connected to the second arm of the dipole. The antenna is therefore short-circuited for DC-signals. On some of the dipoles, small end caps are added to the dipole arms in order to improve matching when loaded according to the position as explained in the "Measurement Conditions" paragraph. The SAR data are not affected by this change. The overall dipole length is still according to the Standard.

No excessive force must be applied to the dipole arms, because they might bend or the soldered connections near the feedpoint may be damaged.

Additional EUT Data

Manufactured by	SPEAG
Manufactured on	August 25, 2009

DASY5 Validation Report for Head TSL

Date: 27.02.2014

Test Laboratory: SPEAG, Zurich, Switzerland

DUT: Dipole 1900 MHz; Type: D1900V2; Serial: D1900V2 - SN: 5d121

Communication System: UID 0 - CW; Frequency: 1900 MHz

Medium parameters used: $f = 1900$ MHz; $\sigma = 1.39$ S/m; $\epsilon_r = 38.9$; $\rho = 1000$ kg/m³

Phantom section: Flat Section

Measurement Standard: DASY5 (IEEE/IEC/ANSI C63.19-2007)

DASY52 Configuration:

- Probe: ES3DV3 - SN3205; ConvF(5.06, 5.06, 5.06); Calibrated: 30.12.2013;
- Sensor-Surface: 3mm (Mechanical Surface Detection)
- Electronics: DAE4 Sn601; Calibrated: 25.04.2013
- Phantom: Flat Phantom 5.0 (front); Type: QD000P50AA; Serial: 1001
- DASY52 52.8.7(1137); SEMCAD X 14.6.10(7164)

Dipole Calibration for Head Tissue/Pin=250 mW, d=10mm/Zoom Scan (7x7x7)/Cube 0:

Measurement grid: dx=5mm, dy=5mm, dz=5mm

Reference Value = 98.487 V/m; Power Drift = 0.04 dB

Peak SAR (extrapolated) = 19.0 W/kg

SAR(1 g) = 10.3 W/kg; SAR(10 g) = 5.34 W/kg

Maximum value of SAR (measured) = 12.8 W/kg

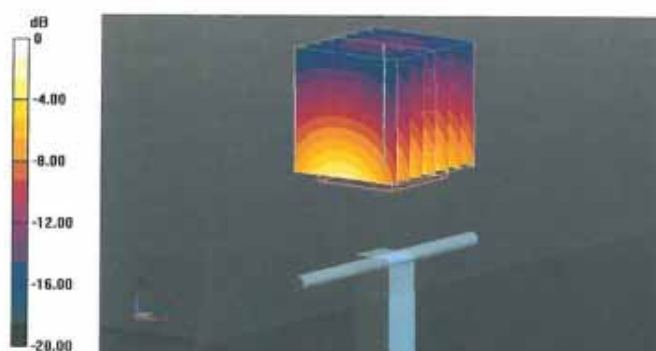

0 dB = 12.8 W/kg = 11.07 dBW/kg

Impedance Measurement Plot for Head TSL

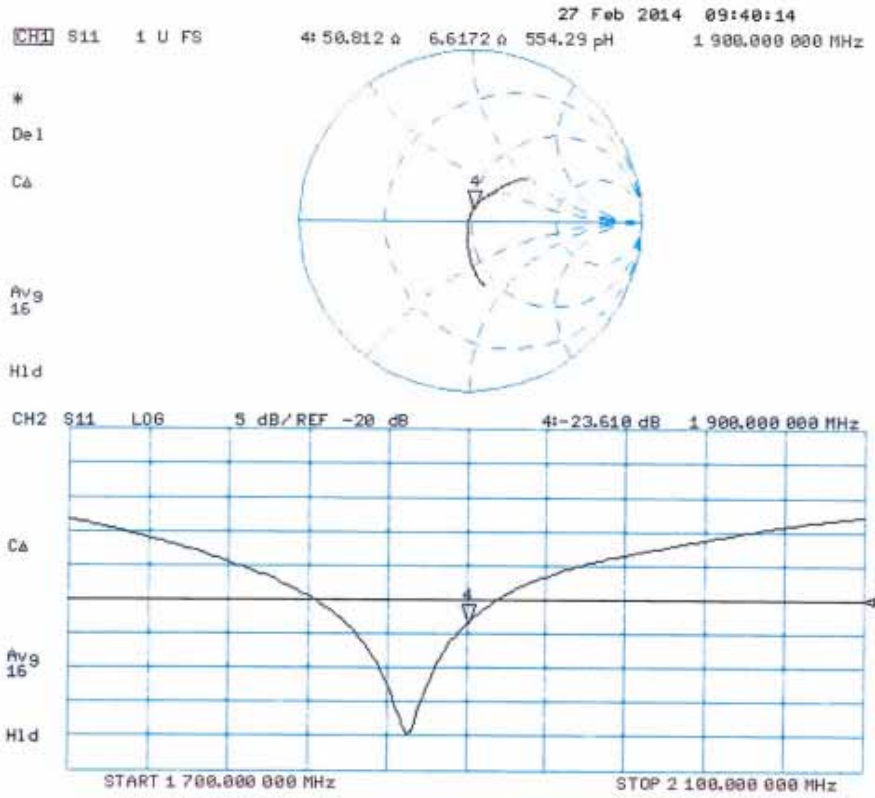

DASY5 Validation Report for Body TSL

Date: 27.02.2014

Test Laboratory: SPEAG, Zurich, Switzerland

DUT: Dipole 1900 MHz; Type: D1900V2; Serial: D1900V2 - SN: 5d121

Communication System: UID 0 - CW; Frequency: 1900 MHz

Medium parameters used: $f = 1900$ MHz; $\sigma = 1.49$ S/m; $\epsilon_r = 52.8$; $\rho = 1000$ kg/m³

Phantom section: Flat Section

Measurement Standard: DASY5 (IEEE/IEC/ANSI C63.19-2007)

DASY52 Configuration:

- Probe: ES3DV3 - SN3205; ConvF(4.76, 4.76, 4.76); Calibrated: 30.12.2013;
- Sensor-Surface: 3mm (Mechanical Surface Detection)
- Electronics: DAE4 Sn601; Calibrated: 25.04.2013
- Phantom: Flat Phantom 5.0 (back); Type: QD000P50AA; Serial: 1002
- DASY52 52.8.7(1137); SEMCAD X 14.6.10(7164)

Dipole Calibration for Body Tissue/Pin=250 mW, d=10mm/Zoom Scan (7x7x7)/Cube 0:

Measurement grid: dx=5mm, dy=5mm, dz=5mm

Reference Value = 95.066 V/m; Power Drift = -0.01 dB

Peak SAR (extrapolated) = 17.1 W/kg

SAR(1 g) = 9.83 W/kg; SAR(10 g) = 5.2 W/kg

Maximum value of SAR (measured) = 12.4 W/kg



0 dB = 12.4 W/kg = 10.93 dBW/kg

Impedance Measurement Plot for Body TSL

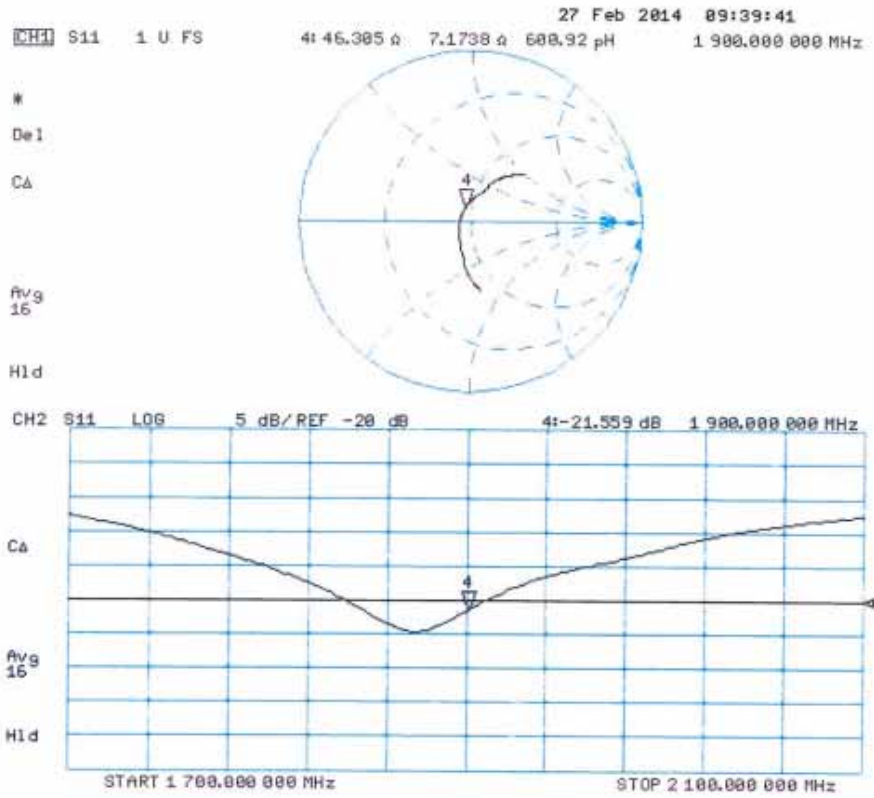

Appendix F. DAE Calibration Data

**Calibration Laboratory of
Schmid & Partner
Engineering AG**
Zeughausstrasse 43, 8004 Zurich, Switzerland



S Schweizerischer Kalibrierdienst
C Service suisse d'étalonnage
S Servizio svizzero di taratura
S Swiss Calibration Service

Accredited by the Swiss Accreditation Service (SAS)
The Swiss Accreditation Service is one of the signatories to the EA
Multilateral Agreement for the recognition of calibration certificates

Accreditation No.: **SCS 108**

Client **Quietek-CN (Auden)**

Certificate No: **DAE4-1220_Jan14**

CALIBRATION CERTIFICATE

Object **DAE4 - SD 000 D04 BM - SN: 1220**

Calibration procedure(s) **QA CAL-06.v26
Calibration procedure for the data acquisition electronics (DAE)**

Calibration date: **January 22, 2014**

This calibration certificate documents the traceability to national standards, which realize the physical units of measurements (SI).
The measurements and the uncertainties with confidence probability are given on the following pages and are part of the certificate.

All calibrations have been conducted in the closed laboratory facility: environment temperature (22 ± 3)°C and humidity < 70%.

Calibration Equipment used (M&TE critical for calibration)

Primary Standards	ID #	Cal Date (Certificate No.)	Scheduled Calibration
Keithley Multimeter Type 2001	SN: 0810278	01-Oct-13 (No:13976)	Oct-14
Secondary Standards	ID #	Check Date (in house)	Scheduled Check
Auto DAE Calibration Unit	SE UWS 053 AA 1001	07-Jan-14 (in house check)	In house check: Jan-15
Calibrator Box V2.1	SE UMS 006 AA 1002	07-Jan-14 (in house check)	In house check: Jan-15

	Name	Function	Signature
Calibrated by:	R.Mayoraz	Technician	<i>R. Mayoraz</i>
Approved by:	Fin Bomholt	Deputy Technical Manager	<i>F. Bomholt</i>

Issued: January 22, 2014

This calibration certificate shall not be reproduced except in full without written approval of the laboratory.

**Calibration Laboratory of
Schmid & Partner
Engineering AG**
Zeughausstrasse 43, 8004 Zurich, Switzerland



S Schweizerischer Kalibrierdienst
C Service suisse d'étalonnage
S Servizio svizzero di taratura
S Swiss Calibration Service

Accredited by the Swiss Accreditation Service (SAS)
The Swiss Accreditation Service is one of the signatories to the EA
Multilateral Agreement for the recognition of calibration certificates

Accreditation No.: **SCS 108**

Glossary

DAE data acquisition electronics
Connector angle information used in DASY system to align probe sensor X to the robot coordinate system.

Methods Applied and Interpretation of Parameters

- **DC Voltage Measurement:** Calibration Factor assessed for use in DASY system by comparison with a calibrated instrument traceable to national standards. The figure given corresponds to the full scale range of the voltmeter in the respective range.
- **Connector angle:** The angle of the connector is assessed measuring the angle mechanically by a tool inserted. Uncertainty is not required.
- The following parameters as documented in the Appendix contain technical information as a result from the performance test and require no uncertainty.
 - **DC Voltage Measurement Linearity:** Verification of the Linearity at +10% and -10% of the nominal calibration voltage. Influence of offset voltage is included in this measurement.
 - **Common mode sensitivity:** Influence of a positive or negative common mode voltage on the differential measurement.
 - **Channel separation:** Influence of a voltage on the neighbor channels not subject to an input voltage.
 - **AD Converter Values with inputs shorted:** Values on the internal AD converter corresponding to zero input voltage
 - **Input Offset Measurement:** Output voltage and statistical results over a large number of zero voltage measurements.
 - **Input Offset Current:** Typical value for information; Maximum channel input offset current, not considering the input resistance.
 - **Input resistance:** Typical value for information: DAE input resistance at the connector, during internal auto-zeroing and during measurement.
 - **Low Battery Alarm Voltage:** Typical value for information. Below this voltage, a battery alarm signal is generated.
 - **Power consumption:** Typical value for information. Supply currents in various operating modes.

DC Voltage Measurement

A/D - Converter Resolution nominal

High Range: 1LSB = 6.1μV , full range = -100...+300 mV

Low Range: 1LSB = 61nV , full range = -1.....+3mV

DASY measurement parameters: Auto Zero Time: 3 sec; Measuring time: 3 sec

Calibration Factors	X	Y	Z
High Range	405.217 ± 0.02% (k=2)	404.944 ± 0.02% (k=2)	404.170 ± 0.02% (k=2)
Low Range	3.97747 ± 1.50% (k=2)	3.99640 ± 1.50% (k=2)	3.98639 ± 1.50% (k=2)

Connector Angle

Connector Angle to be used in DASY system	176.5 ° ± 1 °
---	---------------

Appendix

1. DC Voltage Linearity

High Range	Reading (μ V)	Difference (μ V)	Error (%)
Channel X + Input	199996.00	0.76	0.00
Channel X + Input	20002.66	1.98	0.01
Channel X - Input	-19998.07	2.88	-0.01
Channel Y + Input	199996.91	1.60	0.00
Channel Y + Input	20001.20	0.56	0.00
Channel Y - Input	-20001.74	-0.74	0.00
Channel Z + Input	199994.91	-0.44	-0.00
Channel Z + Input	20000.27	-0.23	-0.00
Channel Z - Input	-20001.65	-0.63	0.00

Low Range	Reading (μ V)	Difference (μ V)	Error (%)
Channel X + Input	2001.09	0.27	0.01
Channel X + Input	202.00	0.81	0.40
Channel X - Input	-197.89	0.69	-0.35
Channel Y + Input	2000.99	0.22	0.01
Channel Y + Input	200.07	-1.02	-0.50
Channel Y - Input	-201.19	-2.34	1.18
Channel Z + Input	2000.92	0.16	0.01
Channel Z + Input	200.20	-0.82	-0.41
Channel Z - Input	-199.32	-0.45	0.23

2. Common mode sensitivity

DASY measurement parameters: Auto Zero Time: 3 sec; Measuring time: 3 sec

	Common mode Input Voltage (mV)	High Range Average Reading (μ V)	Low Range Average Reading (μ V)
Channel X	200	10.55	8.63
	- 200	-6.76	-8.77
Channel Y	200	-9.89	-10.34
	- 200	7.59	7.71
Channel Z	200	12.72	12.38
	- 200	-13.94	-14.25

3. Channel separation

DASY measurement parameters: Auto Zero Time: 3 sec; Measuring time: 3 sec

	Input Voltage (mV)	Channel X (μ V)	Channel Y (μ V)	Channel Z (μ V)
Channel X	200	-	1.02	-3.16
Channel Y	200	8.35	-	2.35
Channel Z	200	10.56	5.06	-

4. AD-Converter Values with inputs shorted

DASY measurement parameters: Auto Zero Time: 3 sec; Measuring time: 3 sec

	High Range (LSB)	Low Range (LSB)
Channel X	15888	15493
Channel Y	16012	15900
Channel Z	15706	16099

5. Input Offset Measurement

DASY measurement parameters: Auto Zero Time: 3 sec; Measuring time: 3 sec

Input 10MΩ

	Average (μV)	min. Offset (μV)	max. Offset (μV)	Std. Deviation (μV)
Channel X	1.13	-0.62	2.79	0.50
Channel Y	-0.89	-2.63	0.76	0.48
Channel Z	-0.60	-2.36	0.94	0.50

6. Input Offset Current

Nominal Input circuitry offset current on all channels: <25fA

7. Input Resistance (Typical values for information)

	Zeroing (kOhm)	Measuring (MOhm)
Channel X	200	200
Channel Y	200	200
Channel Z	200	200

8. Low Battery Alarm Voltage (Typical values for information)

Typical values	Alarm Level (VDC)
Supply (+ Vcc)	+7.9
Supply (- Vcc)	-7.6

9. Power Consumption (Typical values for information)

Typical values	Switched off (mA)	Stand by (mA)	Transmitting (mA)
Supply (+ Vcc)	+0.01	+6	+14
Supply (- Vcc)	-0.01	-8	-9