



---

# SAR Test Report

---

Report No.: AGC01388131202FH01

**FCC ID** : 2AAM3MP40DC

**APPLICATION PURPOSE** : Original Equipment

**PRODUCT DESIGNATION** : Smart Phone

**BRAND NAME** : Szenio

**MODEL NAME** : Syreni 40DC

**CLIENT** : Bulltech Electronic Products S.L.

**DATE OF ISSUE** : Dec.12, 2013

**STANDARD(S)** : IEEE Std. 1528:2003  
47CFR § 2.1093  
IEEE/ANSI C95.1

**REPORT VERSION** : V1.0

Attestation of Global Compliance(Shenzhen) Co., Ltd.



**CAUTION:**

This report shall not be reproduced except in full without the written permission of the test laboratory and shall not be quoted out of context.

### Report Revise Record

Report Version	Revise Time	Issued Date	Valid Version	Notes
V1.0	/	Dec.12, 2013	Valid	Original Report

The test plans were performed in accordance with IEEE Std. 1528:2003; 47CFR § 2.1093; IEEE/ANSI C95.1 and the following specific FCC Test Procedures:

- KDB 447498 D01 General RF Exposure Guidance v05r01
- KDB 648474 D04 SAR Handsets Multi Xmitter and Ant v01
- KDB 865664 D01 SAR measurement 100 MHz to 6 GHz v01
- KDB 941225 D01 SAR test for 3G devices v02
- KDB 941225 D02 Guidance for 3GPP R6 and R7 HSPA v02v01
- KDB 941225 D03 SAR Test Reduction GSM GPRS EDGE v01
- KDB 941225 D06 Hot Spot SAR v01
- KDB 248227 D01 SAR meas for 802 11 a b g v01r02

<h1>Test Report Certification</h1>	
Applicant Name	: Bulltech Electronic Products S.L.
Applicant Address	: Gran Via, 64, 2-I, 28013 Madrid, Spain.
Manufacturer Name	: LONG AN TECHNOLOGY CO., LTD.
Manufacturer Address	: Room 318, Building Shanmei Xincun, PingAn Road, Songgang, BaoAn, Shenzhen, 518000, China
Product Designation	: Smart Phone
Brand Name	: Szenio
Model Name	: Syreni 40DC
Different Description	: N/A
EUT Voltage	: DC3.7V by battery
Applicable Standard	: IEEE Std. 1528:2003 47CFR § 2.1093 IEEE/ANSI C95.1
Test Date	: Dec.12, 2013
Performed Location	: Attestation of Global Compliance(Shenzhen) Co., Ltd.
	: 2 F, Building 2, No.1-No.4, Chaxi Sanwei Technical Industrial Park, Gushu, Xixiang Street, Bao'an District, Shenzhen, China
Report Template	: AGCRT-US-3G/SAR (2013-03-01)

Tested By Sun YIN  
Sun Yin                      Dec.12, 2013

Checked By Angela Li  
Angela Li                      Dec.12, 2013

Authorized By Solger Zhang  
Solger Zhang                      Dec.12, 2013

## TABLE OF CONTENTS

<b>1. SUMMARY OF MAXIMUM SAR VALUE</b>	<b>5</b>
<b>2. GENERAL INFORMATION</b>	<b>7</b>
2.1. EUT DESCRIPTION	7
2.2. TEST PROCEDURE	9
2.3. TEST ENVIRONMENT	9
2.4. TEST CONFIGURATION AND SETTING	10
<b>3. SAR MEASUREMENT SYSTEM</b>	<b>11</b>
3.1. SPECIFIC ABSORPTION RATE (SAR)	11
3.2. SAR MEASUREMENT PROCEDURE	12
3.3. COMOSAR SYSTEM DESCRIPTION	13
3.4. COMOSAR E-FIELD PROBE	15
3.5. ISOTROPIC E-FIELD PROBE SPECIFICATION	15
3.6. ROBOT	15
3.7. VIDEO POSITIONING SYSTEM	16
3.8. DEVICE HOLDER	16
3.9. SAM TWIN PHANTOM	17
<b>4. TISSUE SIMULATING LIQUID</b>	<b>18</b>
4.1. THE COMPOSITION OF THE TISSUE SIMULATING LIQUID	18
4.2. TISSUE CALIBRATION RESULT	19
4.3. TISSUE DIELECTRIC PARAMETERS FOR HEAD AND BODY PHANTOMS	20
<b>5. SAR MEASUREMENT PROCEDURE</b>	<b>21</b>
5.1. SAR SYSTEM VALIDATION PROCEDURES	21
5.2. SAR SYSTEM VALIDATION	22
<b>6. EUT TEST POSITION</b>	<b>24</b>
6.1. DEFINE TWO IMAGINARY LINES ON THE HANDSET	24
6.2. CHEEK POSITION	25
6.3. TITLE POSITION	25
6.4. BODY WORN POSITION	26
<b>7. SAR EXPOSURE LIMITS</b>	<b>27</b>
<b>8. TEST EQUIPMENT LIST</b>	<b>28</b>
<b>9. CONDUCTED POWER MEASUREMENT</b>	<b>29</b>
<b>10. TEST RESULTS</b>	<b>33</b>
10.1. SAR TEST RESULTS SUMMARY	33
<b>APPENDIX A. SAR SYSTEM VALIDATION DATA</b>	<b>48</b>
<b>APPENDIX B. SAR MEASUREMENT DATA</b>	<b>54</b>
<b>APPENDIX C. TEST SETUP PHOTOGRAPHS &amp;EUT PHOTOGRAPHS</b>	<b>132</b>
<b>APPENDIX D. PROBE CALIBRATION DATA</b>	<b>145</b>
<b>APPENDIX E. DIPOLE CALIBRATION DATA</b>	<b>155</b>

## 1. SUMMARY OF MAXIMUM SAR VALUE

The maximum results of Specific Absorption Rate (SAR) found during testing for EUT are as follows:

### Highest Report standalone SAR Summary

Exposure Position	Frequency Band	Highest Reported 1g-SAR(W/Kg)	Highest Reported 1g-SAR(W/Kg)
Head	GSM 835	0.304	<b>0.364</b>
	PCS 1900	0.364	
	WCDMA Band V	0.484	<b>0.484</b>
Body- worn	GSM 835	0.683	<b>0.688</b>
	PCS 1900	0.688	
	WCDMA Band V	1.107	<b>1.107</b>

Exposure Position	Test Mode	Highest Reported 1g-SAR(W/Kg)	Highest Reported 1g-SAR(W/Kg)
Head	802.11b	0.267	<b>0.267</b>
	HOTSPOT	0.142	
Body	802.11b	0.268	<b>0.268</b>
	HOTSPOT	0.175	

### Maximum Scaling standalone SAR Summary

Exposure Position	Frequency Band	Frequency(MHz)	Maximum Scaling 1g-SAR(W/Kg)
Body Back	WCDMA Band V	826.4	<b>1.268</b>

**Highest Simultaneous transmission SAR Summary**

<b>Exposure Position</b>	<b>Frequency Band</b>	<b>Highest Reported 1g-SAR(W/Kg)</b>	<b>Highest Reported 1g-SAR(W/Kg)</b>
<b>Head</b>	GSM 835+Bluetooth	0.400	<b>0.751</b>
	GSM 835+WLAN	0.571	
	GSM 835+ HOTSPOT	0.446	
	PCS 1900+Bluetooth	0.460	
	PCS 1900+WLAN	0.631	
	PCS 1900+ HOTSPOT	0.506	
	WCDMA Band V +Bluetooth	0.580	
	WCDMA Band V+WLAN	0.751	
	WCDMA Band V+ HOTSPOT	0.626	
<b>Body- worn</b>	GSM 835+Bluetooth	0.779	<b>1.375</b>
	GSM 835+WLAN	0.951	
	GSM 835+ HOTSPOT	0.858	
	PCS 1900+Bluetooth	0.784	
	PCS 1900+WLAN	0.956	
	PCS 1900+ HOTSPOT	0.863	
	WCDMA Band V +Bluetooth	1.203	
	WCDMA Band V+WLAN	1.375	
	WCDMA Band V+ HOTSPOT	1.282	

This device is compliance with Specific Absorption Rate (SAR) for general population/uncontrolled exposure limits (1.6W/Kg) specified in FCC 47 CFR part 2 (2.1093) and ANSI/IEEE C95.1, and had been tested in accordance with measurement methods and procedures specified in IEEE 1528-2003 and the relevant KDB files like KDB 941225 D01 , KDB 941225 D03 ,KDB 865664 D02....etc.

## 2. General Information

### 2.1. EUT Description

<b>General Information</b>	
Product Designation	Smart Phone
Test Model	Syreni 40DC
Hardware Version	K278_P3_V0004
Software Version	2780Q0Q4_SY_V001
Device Category	Portable
RF Exposure Environment	Uncontrolled
Antenna Type	Internal
<b>GSM and GPRS</b>	
Support Band	<input checked="" type="checkbox"/> GSM 850 <input checked="" type="checkbox"/> PCS 1900 (U.S. Bands) <input checked="" type="checkbox"/> GSM 900 <input checked="" type="checkbox"/> DCS 1800 (Non-U.S. Bands)
GPRS Type	Class B
GPRS Class	Class 12(1Tx+4Rx, 2Tx+3Rx, 3Tx+2Rx, 4Tx+1Rx)
TX Frequency Range	GSM 850 : 824.2~848.8MHz; PCS 1900: 1850.2~1909.8MHz;
RX Frequency Range	GSM 850 : 869~894MHz PCS 1900: 1930~1990MHz
Release Version	R99
Type of modulation	GMSK for GSM/GPRS
Antenna Gain	1.0dBi
Max. Average Power (Max. Peak Power)	GSM850: 31.42dBm(32.13dBm- Peak Power) PCS1900: 28.41dBm(29.32dBm-Peak Power)
<b>WCDMA</b>	
Support Band	U.S. Bands: <input type="checkbox"/> UMTS FDD Band II <input checked="" type="checkbox"/> UMTS FDD Band V Non-U.S. Bands: <input checked="" type="checkbox"/> UMTS FDD Band I <input type="checkbox"/> UMTS FDD Band III <input type="checkbox"/> UMTS FDD Band VIII
HS Type	HSPA(HSUPA/HSDPA)
TX Frequency Range	WCDMA FDD Band V: 826.4-846.6MHz

RX Frequency Range	WCDMA FDD Band V: 869-894MHz
Release Version	Rel-6
Type of modulation	QPSK
Antenna Gain	0.8dBi
Max. Average Power (Max. Peak Power)	Band V: 23.24dBm (23.41dBm- Peak Power)
<b>Bluetooth</b>	
Bluetooth Version	<input type="checkbox"/> V2.0 <input type="checkbox"/> V2.1 <input type="checkbox"/> V2.1+EDR <input checked="" type="checkbox"/> V3.0 <input type="checkbox"/> V3.0+HS <input checked="" type="checkbox"/> V4.0
Operation Frequency	2402~2480MHz
Type of modulation	<input checked="" type="checkbox"/> GFSK <input checked="" type="checkbox"/> π/4-DQPSK <input checked="" type="checkbox"/> 8-DPSK
Avg. Burst Power	3.59dBm
Antenna Gain	1.2dBi
<b>WIFI</b>	
WIFI Specification	<input type="checkbox"/> 802.11a <input checked="" type="checkbox"/> 802.11b <input checked="" type="checkbox"/> 802.11g <input checked="" type="checkbox"/> 802.11n(20) <input checked="" type="checkbox"/> 802.11n(40)
Operation Frequency	2412~2462MHz
Avg. Burst Power	11b:15.72dBm,11g:11.92dBm,11n(20):12.92dBm,11n(40):10.02dBm
Antenna Gain	1.2dBi
<b>Accessories</b>	
Battery	Brand name: Szenio Model No. : Syreni 40DC Voltage and Capacitance: 3.7 V & 1400mAh
Adapter	Brand name: Szenio Model No. : Syreni 40DC Input: AC 100-240V, 50/60Hz, 0.4A    Output: DC 5V, 1000mA
Earphone	Brand name: Szenio Model No. : Syreni 40DC

Note: The sample used for testing is end product.



## 2.2. Test Procedure

1	Setup the EUT and simulators as shown on above.
2	Turn on the power of all equipment.
3	EUT Communicate with 8960, and test them respectively at U.S. bands

## 2.3. Test Environment

Ambient conditions in the laboratory:

Items	Required	Actual
Temperature (°C)	18-25	21± 2
Humidity (%RH)	30-70	55±2

## 2.4. Test Configuration and setting

The EUT is a model of GSM Portable Mobile Station (MS). It supports GSM/GPRS, BT, WIFI, and support hot spot mode.

For WWAN SAR testing, the device was controlled by using a base station emulator. Communication between The device and the emulator were established by air link. The distance between the EUT and the antenna is larger than 50cm, and the output power radiated from the emulator antenna is at least 30db smaller than the output power of EUT.

For WLAN testing, the EUT is configured with the WLAN continuous TX tool through engineering command.

### Antenna Location:

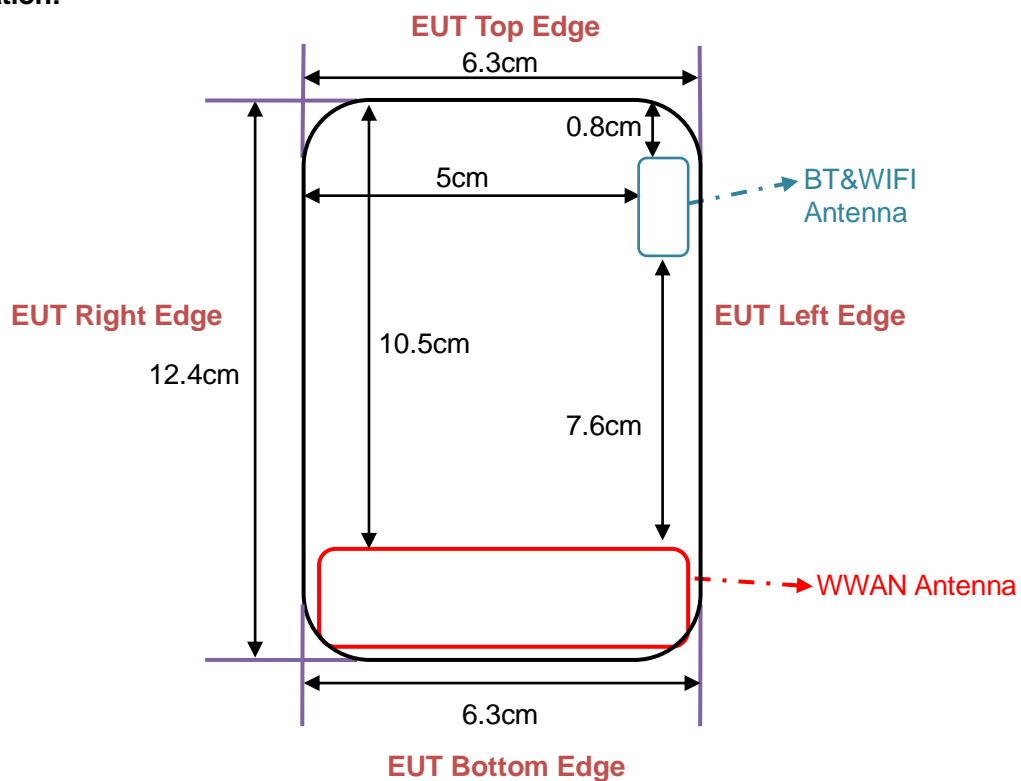

The separation distance for antenna to edge:

Antenna	To Top Side(cm)	To Bottom Side(cm)	To Left Side(cm)	To Right Side(cm)
WWAN	10.5	0	0	0
BT/WIFI	0.8	9.5	0	5

The simultaneous transmission possibilities are listed as below:

Simultaneous TX Combination	Configuration	Head	Body	Hotspot
1	GSM835(Voice)+ BT/WIFI	Yes	Yes	Yes
2	PCS 1900(Voice)+ BT/WIFI	Yes	Yes	Yes
3	WCDMA Band V(Voice)+ BT/WIFI	Yes	Yes	Yes

### 3. SAR MEASUREMENT SYSTEM

#### 3.1. Specific Absorption Rate (SAR)

SAR is related to the rate at which energy is absorbed per unit mass in object exposed to a radio field. The SAR distribution in a biological body is complicated and is usually carried out by experimental techniques or numerical modeling. The standard recommends limits for two tiers of groups, occupational/controlled and occupational/uncontrolled, based on a person's awareness and ability to exercise control over his or her exposure. In general, occupational/controlled exposure limits are higher than the limits for general population/uncontrolled.

The SAR definition is the time derivative (rate) of the incremental energy (dW) absorbed by (dissipated in) an incremental mass (dm) contained in a volume (dv) of given mass density ( $\rho$ ). The equation description is as below:

$$SAR = \frac{d}{dt} \left( \frac{dW}{dm} \right) = \frac{d}{dt} \left( \frac{dW}{\rho dV} \right)$$

SAR is expressed in units of Watts per kilogram (W/Kg)

SAR can be obtained using either of the following equations:

$$SAR = \frac{\sigma E^2}{\rho}$$

$$SAR = c_h \left. \frac{dT}{dt} \right|_{t=0}$$

Where

SAR	is the specific absorption rate in watts per kilogram;
E	is the r.m.s. value of the electric field strength in the tissue in volts per meter;
$\sigma$	is the conductivity of the tissue in siemens per metre;
$\rho$	is the density of the tissue in kilograms per cubic metre;
$c_h$	is the heat capacity of the tissue in joules per kilogram and Kelvin;

$\left. \frac{dT}{dt} \right|_{t=0}$  is the initial time derivative of temperature in the tissue in kelvins per second

### **3.2. SAR Measurement Procedure**

The EUT is set to transmit at the required power in line with product specification, at each frequency relating to the LOW, MID, and HIGH channel settings.

Pre-scans are made on the device to establish the location for the transmitting antenna, using a large area scan in either air or tissue simulation fluid.

The EUT is placed against the Universal Phantom where the maximum area scan dimensions are larger than the physical size of the resonating antenna. When the scan size is not large enough to cover the peak SAR distribution, it is modified by either extending the area scan size in both the X and Y directions, or the device is shifted within the predefined area.

The area scan is then run to establish the peak SAR location (interpolated resolution set at  $1\text{mm}^2$ ) which is then used to orient the center of the zoom scan. The zoom scan is then executed and the 1g and 10g averages are derived from the zoom scan volume (interpolated resolution set at  $1\text{mm}^3$ ).

When multiple peak SAR location were found during the same configuration or test mode, Zoom scan shall performed on each peak SAR location, only the peak point with maximum SAR value will be reported for the configuration or test mode.

### 3.3. COMOSAR System Description

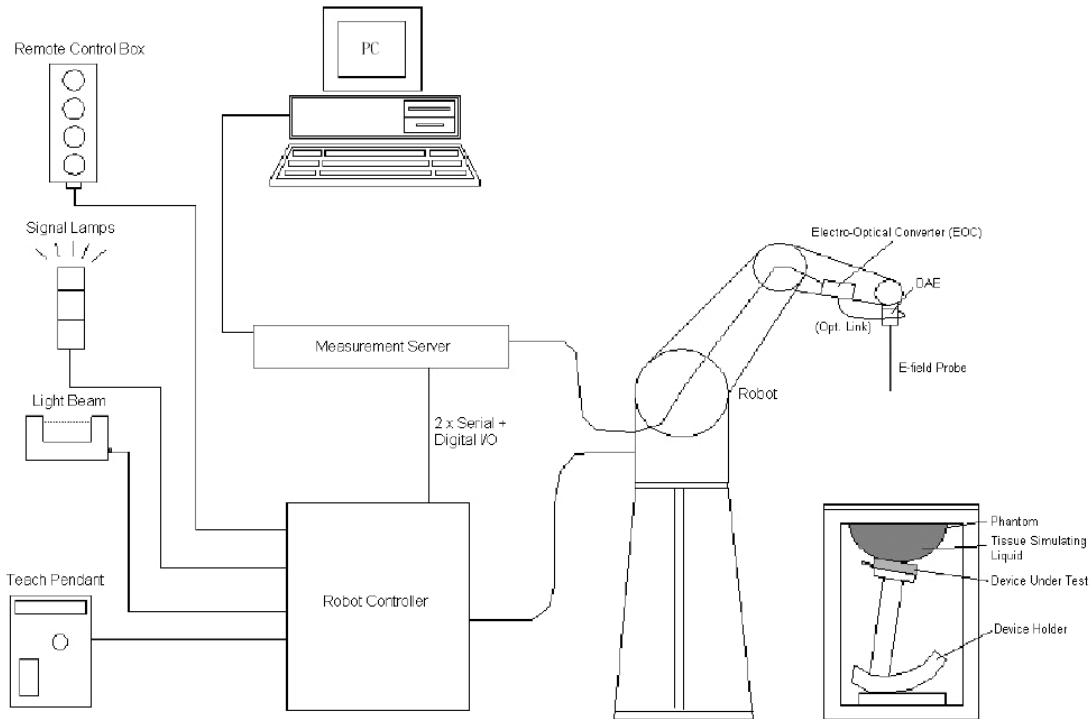

The COMOSAR system for performing compliance tests consists of the following items:

- A standard high precision 6axis robot with controller, teach pendant and software. An arm extension for accommodating the data acquisition electronics (DAE).
- A data acquisition electronics (DAE) which performs the signal amplification, signal multiplexing, AD-conversion, offset measurements, mechanical surface detection, collision detection, etc. The unit is battery powered with standard or rechargeable batteries. The signal is optically transmitted to the EOC.
- The Electro-optical converter (EOC) performs the conversion from optical to electrical signals for the digital Communicate to the DAE. To use optical surface detection, a special version of the EOC is required. The EOC signal is transmitted to the measurement server.
- The Light Beam used is for probe alignment. This improves the (absolute) accuracy of the probe positioning.
- A computer running WinXP and the Opensar software.
- Remote control and teach pendant as well as additional circuitry for robot safety such as warning lamps, etc.
- The phantom, the device holder and other accessories according to the targeted measurement.

#### 3.3.1. Applications

Predefined procedures and evaluations for automated compliance testing with all worldwide standards, e.g., IEEE 1528, OET 65, IEC 62209-1, IEC 62209-2, EN 50360, EN 50383 and others.

### 3.3.2. Area Scans

Area scans are defined prior to the measurement process being executed with a user defined variable spacing between each measurement point (integral) allowing low uncertainty measurements to be conducted. Scans defined for FCC applications utilize a 10mm<sup>2</sup> step integral, with 1mm interpolation used to locate the peak SAR area used for zoom scan assessments.

When an Area Scan has measured all reachable points, it computes the field maxima found in the scanned area, within a range of the global maximum. The range (in dB) is specified in the standards for compliance testing. For example, a 2 dB range is required in IEEE 1528-2003, EN 50361 and IEC 62209 standards, whereby 3 dB is a requirement when compliance is assessed in accordance with the ARIB standard (Japan).

### 3.3.3. Zoom Scan (Cube Scan Averaging)

Zoom Scans are used to assess the peak spatial SAR values within a cubic averaging volume containing 1 g and 10 g of simulated tissue. A density of 1000 kg/m<sup>3</sup> is used to represent the head and body tissue density and not the phantom liquid density, in order to be consistent with the definition of the liquid dielectric properties, i.e. the side length of the 1 g cube is 10mm, with the side length of the 10 g cube 21,5mm.

The zoom scan integer steps can be user defined so as to reduce uncertainty, but normal practice for typical test applications utilize a physical step of 7x7x7 (5mmx5mmx5mm) providing a volume of 30mm in the X & Y axis, and 30mm in the Z axis.

### 3.3.4. Uncertainty of Inter-/Extrapolation and Averaging

In order to evaluate the uncertainty of the interpolation, extrapolation and averaged SAR calculation algorithms of the Post processor, COMOSAR allows the generation of measurement grids which are artificially predefined by analytically based test functions. Therefore, the grids of area scans and zoom scans can be filled with uncertainty test data, according to the SAR benchmark functions of IEEE 1528. The three analytical functions shown in equations as below are used to describe the possible range of the expected SAR distributions for the tested handsets. The field gradients are covered by the spatially flat distribution f1, the spatially steep distribution f3 and f2 accounts for H-field cancellation on the phantom/tissue surface.

$$f_1(x, y, z) = Ae^{-\frac{z}{2a}} \cos^2 \left( \frac{\pi \sqrt{x'^2 + y'^2}}{2 \cdot 5a} \right)$$

$$f_2(x, y, z) = Ae^{-\frac{z}{a}} \frac{a^2}{a^2 + x'^2} \left( 3 - e^{-\frac{2z}{a}} \right) \cos^2 \left( \frac{\pi y'}{2 \cdot 3a} \right)$$

$$f_3(x, y, z) = A \frac{a^2}{\frac{a^2}{4} + x'^2 + y'^2} \left( e^{-\frac{2z}{a}} + \frac{a^2}{2(a + 2z)^2} \right)$$

### 3.4. COMOSAR E-Field Probe

The SAR measurement is conducted with the dissymmetric probe manufactured by SATIMO. The probe is specially designed and calibrated for use in liquid with high permittivity. The dissymmetric probe has special calibration in liquid at different frequency. SATIMO conducts the probe calibration in compliance with international and national standards (e.g. IEEE 1528, EN62209-1, IEC 62209, etc.) Under ISO17025. The calibration data are in Appendix D.

### 3.5. Isotropic E-Field Probe Specification

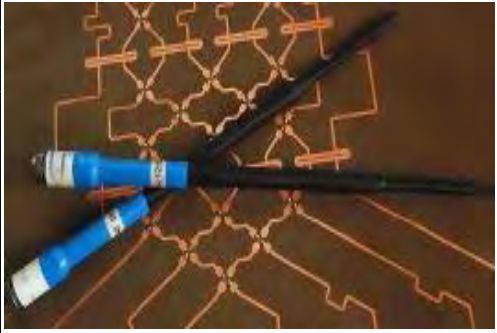
<b>Model</b>	EP165	
<b>Manufacture</b>	SATIMO	
<b>Frequency</b>	0.03GHz-3 GHz Linearity:±0.2dB(30 MHz-3 GHz)	
<b>Dynamic Range</b>	0.01W/Kg-100W/Kg Linearity:±0.2dB	
<b>Dimensions</b>	Overall length:330mm Length of individual dipoles:4.5mm Maximum external diameter:8mm Probe Tip external diameter:5mm Distance between dipoles/ probe extremity:2.7mm	
<b>Application</b>	High precision dosimetric measurements in any exposure scenario (e.g., very strong gradient fields). Only probe which enables compliance testing for frequencies up to 3 GHz with precision of better 30%.	

### 3.6. Robot

The COMOSAR system uses the KUKA robot from SATIMO SA (France).For the 6-axis controller COMOSAR system, the KUKA robot controller version from SATIMO is used. The XL robot series have many features that are important for our application:

- High precision (repeatability 0.02 mm)
- High reliability (industrial design)
- Jerk-free straight movements
- Low ELF interference (the closed metallic construction shields against motor control fields)
- 6-axis controller



### 3.7. Video Positioning System

The video positioning system is used in OpenSAR to check the probe. Which is composed of a camera, LED, mirror and mechanical parts. The camera is piloted by the main computer with firewire link.

During the process, the actual position of the probe tip with respect to the robot arm is measured, as well as the probe length and the horizontal probe offset. The software then corrects all movements, such that the robot coordinates are valid for the probe tip.

The repeatability of this process is better than 0.1 mm. If a position has been taught with an aligned probe, the same position will be reached with another aligned probe within 0.1 mm, even if the other probe has different dimensions. During probe rotations, the probe tip will keep its actual position.

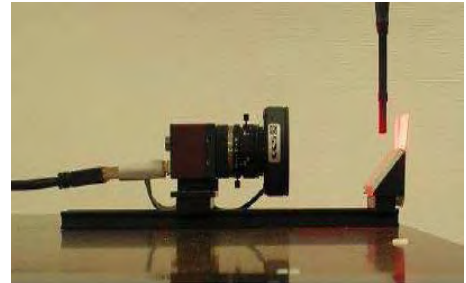

### 3.8. Device Holder

The COMOSAR device holder is designed to cope with different positions given in the standard. It has two scales for the device rotation (with respect to the body axis) and the device inclination (with respect to the line between the ear reference points). The rotation center for both scales is the ear reference point (EPR).

Thus the device needs no repositioning when changing the angles.

The COMOSAR device holder has been made out of low-loss POM material having the following dielectric parameters: relative permittivity  $\epsilon_r = 3$  and loss tangent  $\delta = 0.02$ . The amount of dielectric material has been reduced in the closest vicinity of the device, since measurements have suggested that the influence of the clamp on the test results could thus be lowered.

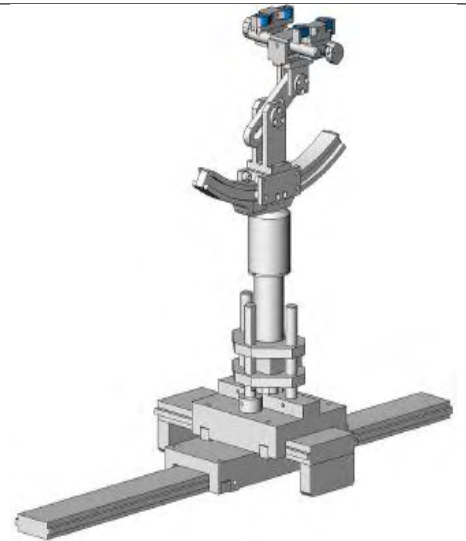



### 3.9. SAM Twin Phantom

The SAM twin phantom is a fiberglass shell phantom with 2mm shell thickness (except the ear region where shell thickness increases to 6mm). It has three measurement areas:

- Left head
- Right head
- Flat phantom



The bottom plate contains three pair of bolts for locking the device holder. The device holder positions are adjusted to the standard measurement positions in the three sections. A white cover is provided to tap the phantom during off-periods to prevent water evaporation and changes in the liquid parameters. On the phantom top, three reference markers are provided to identify the phantom position with respect to the robot.



## 4.2. Tissue Calibration Result

The dielectric parameters of the liquids were verified prior to the SAR evaluation using COMOSAR Dielectric Probe Kit and R&S Network Analyzer ZVL6 .

Tissue Stimulant Measurement for GSM 835					
Frequency (MHz)	Parts	Description	Dielectric Parameters		Tissue Temp [°C]
835MHz	Head	Reference result ±5% window	$\epsilon_r$ 41.50 39.425-43.575	$\delta$ [s/m] 0.90 0.855-0.945	N/A
		Dec.12, 2013	40.26	0.84	21
835MHz	Body	Reference result ±5% window	$\epsilon_r$ 55.20 52.44-57.96	$\delta$ [s/m] 0.97 0.9215-1.0185	N/A
		Dec.12, 2013	53.26	0.95	21

Tissue Stimulant Measurement for PCS 1900					
Frequency (MHz)	Parts	Description	Dielectric Parameters		Tissue Temp [°C]
1900MHz	Head	Reference result ±5% window	$\epsilon_r$ 40.00 38.00-42.00	$\delta$ [s/m] 1.40 1.33-1.47	N/A
		Dec.12, 2013	40.51	1.36	21
1900MHz	Body	Reference result ±5% window	$\epsilon_r$ 53.30 50.635-55.965	$\delta$ [s/m] 1.52 1.444-1.596	N/A
		Dec.12, 2013	54.62	1.47	21

Tissue Stimulant Measurement for 2450MHz					
Frequency (MHz)	Parts	Description	Dielectric Parameters		Tissue Temp [°C]
2450MHz	Head	Reference result ±5% window	$\epsilon_r$ 39.2 37.24-41.16	$\delta$ [s/m] 1.80 1.71-1.89	N/A
		Dec.12, 2013	38.54	1.84	21
2450MHz	Body	Reference result ±5% window	$\epsilon_r$ 52.7 50.065-55.335	$\delta$ [s/m] 1.95 1.8525-2.0475	N/A
		Dec.12, 2013	53.45	1.88	21

### 4.3. Tissue Dielectric Parameters for Head and Body Phantoms

The head tissue dielectric parameters recommended by the IEEE SCC-34/SC-2 in P1528 have been incorporated in the following table. These head parameters are derived from planar layer models simulating the highest expected SAR for the dielectric properties and tissue thickness variations in a human head. Other head and body tissue parameters that have not been specified in P1528 are derived from the tissue dielectric parameters computed from the 4-Cole-Cole equations described in Reference [12] and extrapolated according to the head parameters specified in P1528.

Target Frequency (MHz)	head		body	
	$\epsilon_r$	$\sigma$ (S/m)	$\epsilon_r$	$\sigma$ (S/m)
300	45.3	0.87	58.2	0.92
450	43.5	0.87	56.7	0.94
<b>835</b>	<b>41.5</b>	<b>0.90</b>	<b>55.2</b>	<b>0.97</b>
900	41.5	0.97	55.0	1.05
915	41.5	1.01	55.0	1.06
1450	40.5	1.20	54.0	1.30
1610	40.3	1.29	53.8	1.40
<b>1800 – 2000</b>	<b>40.0</b>	<b>1.40</b>	<b>53.3</b>	<b>1.52</b>
<b>2450</b>	<b>39.2</b>	<b>1.80</b>	<b>52.7</b>	<b>1.95</b>
3000	38.5	2.40	52.0	2.73
5800	35.3	5.27	48.2	6.00

( $\epsilon_r$  = relative permittivity,  $\sigma$  = conductivity and  $\rho = 1000$  kg/m<sup>3</sup>)

## 5. SAR MEASUREMENT PROCEDURE

### 5.1. SAR System Validation Procedures

Each SATIMO system is equipped with one or more system validation kits. These units, together with the predefined measurement procedures within the SATIMO software, enable the user to conduct the system performance check and system validation. System kit includes a dipole, and dipole device holder.

The system check verifies that the system operates within its specifications. It's performed daily or before every SAR measurement. The system check uses normal SAR measurement in the flat section of the phantom with a matched dipole at a specified distance. The system validation setup is shown as below.

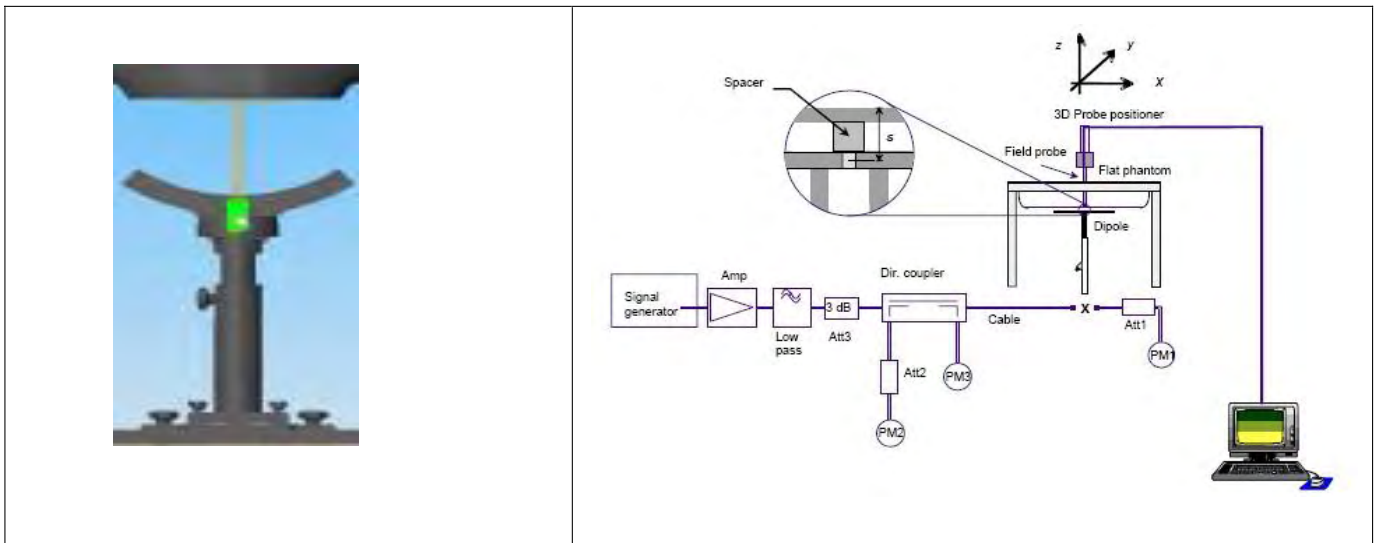

**5.2. SAR System Validation**  
**5.2.1. Validation Dipoles**

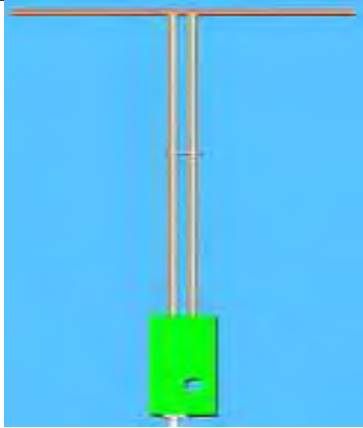

The dipoles used is based on the IEEE-1528 standard, and is complied with mechanical and electrical specifications in line with the requirements of both IEEE and FCC Supplement C. the table below provides details for the mechanical and electrical Specifications for the dipoles.

Frequency	L (mm)	h (mm)	d (mm)
900 MHz	149	83.3	3.6
1900MHz	68	39.5	3.6
2450MHz	51.5	30.4	3.6

### 5.2.2. Validation Result

<b>System Performance Check at 835 MHz &amp;1900MHz &amp; 2450MHz for Head</b>				
<b>Validation Kit: SN 46/11DIP 0G900-185</b>				
Frequency [MHz]	Description	SAR [w/kg] 1g	SAR [w/kg] 10g	Tissue Temp.[°C]
835 MHz	Reference result ± 10% window	10.9 9.81 to 11.99	6.99 6.29 to 7.69	N/A
	Dec.12, 2013	10.96	6.83	21.0
<b>Validation Kit: SN 46/11DIP 1G900-187</b>				
Frequency [MHz]	Description	SAR [w/kg] 1g	SAR [w/kg] 10g	Tissue Temp.[°C]
1900 MHz	Reference result ± 10% window	39.7 35.73 to 43.67	20.5 18.45 to 22.55	N/A
	Dec.12, 2013	38.94	20.75	21.0
<b>Validation Kit: SN 46/11DIP 2G450-189</b>				
Frequency [MHz]	Description	SAR [w/kg] 1g	SAR [w/kg] 10g	Tissue Temp.[°C]
2450 MHz	Reference result ± 10% window	52.4 47.16 to 57.64	24.0 21.6 to 26.4	N/A
	Dec.12, 2013	49.57	22.59	21
Note: All SAR values are normalized to 1W forward power.				

## 6. EUT TEST POSITION

This EUT was tested in **Right Cheek, Right Titled, Left Cheek, Left Titled, Front Face and Rear Face.**

### 6.1. Define Two Imaginary Lines on the Handset

(1) The vertical centerline passes through two points on the front side of the handset: the midpoint of the width  $w_t$  of the handset at the level of the acoustic output, and the midpoint of the width  $w_b$  of the handset.

(2) The horizontal line is perpendicular to the vertical centerline and passes through the center of the acoustic output. The horizontal line is also tangential to the face of the handset at point A.

(3) The two lines intersect at point A. Note that for many handsets, point A coincides with the center of the acoustic output; however, the acoustic output may be located elsewhere on the horizontal line. Also note that the vertical centerline is not necessarily to the front face of the handset, especially for clamshell handsets, handsets with flip covers, and other irregularly shaped handsets.

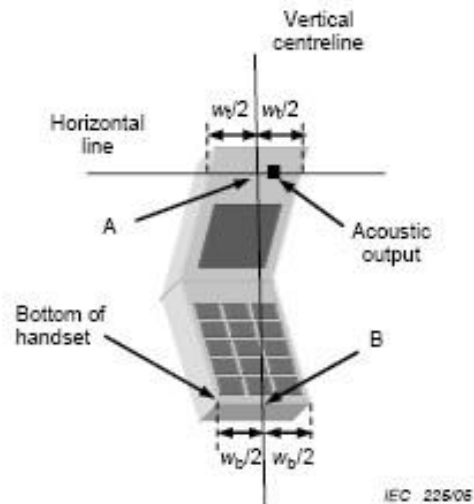
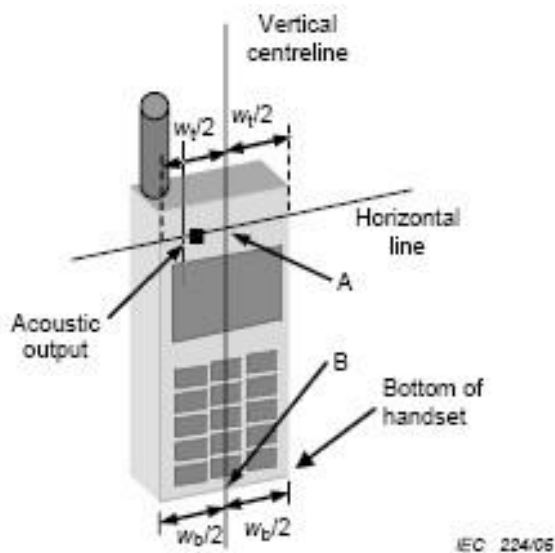



## 6.2. Cheek Position

- (1) To position the device with the vertical center line of the body of the device and the horizontal line crossing the center piece in a plane parallel to the sagittal plane of the phantom. While maintaining the device in this plane, align the vertical center line with the reference plane containing the ear and mouth reference point (M: Mouth, RE: Right Ear, and LE: Left Ear) and align the center of the ear piece with the line RE-LE.
- (2) To move the device towards the phantom with the ear piece aligned with the the line LE-RE until the phone touched the ear. While maintaining the device in the reference plane and maintaining the phone contact with ear, move the bottom of the phone until any point on the front side is in contact with the cheek of the phantom or until contact with the ear is lost



## 6.3. Title Position

- (1) To position the device in the “cheek” position described above.
- (2) While maintaining the device in the reference plane described above and pivoting against the ear, moves it outward away from the mouth by an angle of 15 degrees or until with the ear is lost.



#### 6.4. Body Worn Position

- (1) To position the EUT parallel to the phantom surface.
- (2) To adjust the EUT parallel to the flat phantom.
- (3) To adjust the distance between the EUT surface and the flat phantom to **5mm** (Hotspot mode the distance of **10mm**).

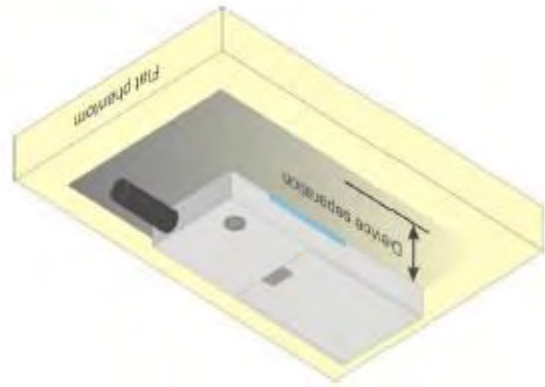
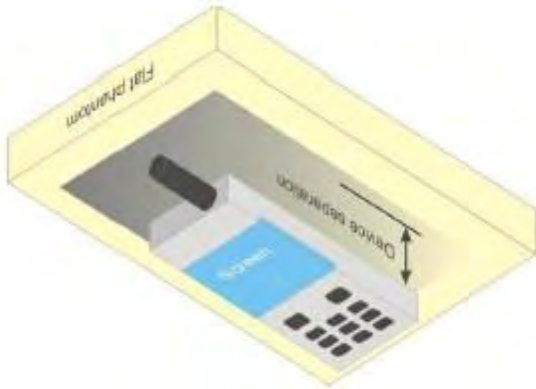

## 7. SAR EXPOSURE LIMITS

SAR assessments have been made in line with the requirements of IEEE-1528, FCC Supplement C, and comply with ANSI/IEEE C95.1-1992 “Uncontrolled Environments” limits. These limits apply to a location which is deemed as “Uncontrolled Environment” which can be described as a situation where the general public may be exposed to an RF source with no prior knowledge or control over their exposure.

### Limits for General Population/Uncontrolled Exposure (W/kg)

Type Exposure	Uncontrolled Environment Limit
Spatial Peak SAR (1g cube tissue for brain or body)	1.60 W/kg

## 8. TEST EQUIPMENT LIST

Equipment description	Manufacturer/ Model	Identification No.	Current calibration date	Next calibration date
SAR Probe	SATIMO	SN 04/13 EP165	01/31/2013	01/30/2014
Phantom	SATIMO	SN_4511_SAM90	Validated. No cal required.	Validated. No cal required.
Liquid	SATIMO	-	Validated. No cal required.	Validated. No cal required.
Comm Tester	R&S - CMU200	069Y7-158-13-712	02/28/2013	02/27/2014
Comm Tester	Agilent-8960	GB46310822	10/22/2013	10/21/2014
Multimeter	Keithley 2000	1188656	02/28/2013	02/27/2014
Dipole	SATIMO SID900	SN46/11 DIP 0G900-185	11/14/2013	11/13/2015
Dipole	SATIMO SID1900	SN46/11 DIP 1G900-187	11/14/2013	11/13/2015
Dipole	SATIMO SID2450	SN46/11 DIP 2G450-189	11/14/2013	11/13/2015
Amplifier	Aethercomm	SN 046	12/08/2013	12/07/2014
Signal Generator	Agilent-E4421B	MY43351603	05/13/2013	05/12/2014
Power Probe	NRP-Z23	US38261498	02/28/2013	02/27/2014
SPECTRUM ANALYZER	Agilent/E4440A	MY44303916	10/22/2013	10/21/2014
Power Attenuator	BED	DLA-5W	07/30/2013	07/29/2014
Network Analyzer	Rhode & Schwarz ZVA	SN100132	02/28/2013	02/27/2014

Note: Per KDB 50824 Dipole SAR Validation Verification, AGC Lab has adopted 3 years calibration intervals. On annual basis, every measurement dipole has been evaluated and is in compliance with the following criteria:

1. There is no physical damage on the dipole;
2. System validation with specific dipole is within 10% of calibrated value;
3. Return-loss is within 20% of calibrated measurement;
4. Impedance is within 5Ω of calibrated measurement.

## 9. CONDUCTED POWER MEASUREMENT

### GSM BAND

Mode	Frequency(MHz)	Avg. Burst Power(dBm)	Duty cycle Factor(dBm)	Frame Power(dBm)
Maximum Power <1>				
GSM 835	824.2	31.27	-9	22.27
	836.6	<b>31.42</b>	-9	22.42
	848.8	31.37	-9	22.37
GPRS 835 (1 Slot)	824.2	31.23	-9	22.23
	836.6	31.27	-9	22.27
	848.8	31.21	-9	22.21
GPRS 835 (2 Slot)	824.2	28.33	-6	22.33
	836.6	28.47	-6	22.47
	848.8	28.35	-6	22.35
GPRS 835 (3 Slot)	824.2	26.52	-4.26	22.26
	836.6	26.37	-4.26	22.11
	848.8	26.43	-4.26	22.17
GPRS 835 (4 Slot)	824.2	25.36	-3	22.36
	836.6	25.22	-3	22.22
	848.8	25.55	-3	22.55
PCS1900	1850.2	<b>28.41</b>	-9	19.41
	1880	28.27	-9	19.27
	1909.8	28.21	-9	19.21
GPRS1900 (1 Slot)	1850.2	28.25	-9	19.25
	1880	28.22	-9	19.22
	1909.8	28.13	-9	19.13
GPRS1900 (2 Slot)	1850.2	25.38	-6	19.38
	1880	25.54	-6	19.54
	1909.8	25.47	-6	19.47
GPRS1900 (3 Slot)	1850.2	24.24	-4.26	19.98
	1880	24.19	-4.26	19.93
	1909.8	24.18	-4.26	19.92
GPRS1900 (4 Slot)	1850.2	22.61	-3	19.61
	1880	22.64	-3	19.64
	1909.8	22.45	-3	19.45
Maximum Power <2>				
GSM 835	836.6	31.37	-9	22.37
PCS1900	1850.2	28.36	-9	19.36

Note 1:

The Frame Power (Source-based time-averaged Power) is scaled the maximum burst average power based on time slots. The calculated methods are show as following:

Frame Power = Max burst power (1 Up Slot) – 9 dB

Frame Power = Max burst power (2 Up Slot) – 6 dB

Frame Power = Max burst power (3 Up Slot) – 4.26 dB

Frame Power = Max burst power (4 Up Slot) – 3 dB

**UMTS BAND V**

<b>Mode</b>	<b>Frequency (MHz)</b>	<b>Avg.Burst Power</b>
WCDMA 835 RMC	826.4	<b>23.24</b>
	835.0	23.19
	846.6	22.99
WCDMA 835 AMR	826.4	23.20
	835.0	23.10
	846.6	22.14
HSDPA Subtest 1	826.4	22.33
	835.0	22.24
	846.6	22.36
HSDPA Subtest 2	826.4	22.3
	835.0	22.34
	846.6	22.30
HSDPA Subtest 3	826.4	22.26
	835.0	22.20
	846.6	22.47
HSDPA Subtest 4	826.4	22.44
	835.0	22.12
	846.6	22.21
HSUPA Subtest 1	826.4	22.14
	835.0	22.03
	846.6	22.06
HSUPA Subtest 2	826.4	22.04
	835.0	21.99
	846.6	22.04
HSUPA Subtest 3	826.4	22.16
	835.0	22.11
	846.6	22.02
HSUPA Subtest 4	826.4	22.28
	835.0	22.07
	846.6	22.09
HSUPA Subtest 5	826.4	21.37
	835.0	21.34
	846.6	21.26

**WIFI**

Mode	Data Rate (Mbps)	Channel	Frequency(MHz)	Avg. Burst Power(dBm)
802.11b	1	01	2412	14.12
		06	2437	15.52
		11	2462	<b>15.72</b>
802.11g	6	01	2412	10.72
		06	2437	<b>11.92</b>
		11	2462	10.82
802.11n(20)	6.5	01	2412	10.92
		06	2437	<b>12.92</b>
		11	2462	11.22
802.11n(40)	13.5	03	2422	8.12
		06	2437	<b>10.02</b>
		09	2452	8.92

**Bluetooth\_V3.0**

Modulation	Channel	Frequency(MHz)	Average Power (dBm)
GFSK	0	2402	3.07
	39	2441	3.48
	78	2480	<b>3.59</b>
$\pi/4$ -DQPSK	0	2402	2.24
	39	2441	2.78
	78	2480	2.84
8-DPSK	0	2402	2.26
	39	2441	2.77
	78	2480	2.81

According to 3GPP 25.101 sub-clause 6.2.2 , the maximum output power is allowed to be reduced by following the table.

Table 6.1aA: UE maximum output power with HS-DPCCH and E-DCH

UE Transmit Channel Configuration	CM(db)	MPR(db)
For all combinations of ,DPDCH,DPCCH HS-DPDCH,E-DPDCH and E-DPCCH	$0 \leq CM \leq 3.5$	$MAX(CM-1,0)$
Note: CM=1 for $\beta_d/\beta_c=12/15$ , $\beta_{hs}/\beta_c=24/15$ .For all other combinations of DPDCH, DPCCH, HS-DPCCH, E-DPDCH and E-DPCCH the MPR is based on the relative CM difference.		

The device supports MPR to solve linearity issues (ACLR or SEM) due to the higher peak-to average ratios (PAR) of the HSUPA signal. This prevents saturating the full range of the TX DAC inside of device and provides a reduced power output to the RF transceiver chip according to the Cubic Metric (a function of the combinations of DPDCH, DPCCH, HS-DPCCH, E-DPDCH and E-DPCCH).

When E-DPDCH channels are present the beta gains on those channels are reduced firsts to try to get the power under the allowed limit. If the beta gains are lowered as far as possible, then a hard limiting is applied at the maximum allowed level.

The SW currently recalculates the cubic metric every time the beta gains on the E-DPDCH are reduced. The cubic metric will likely get lower each time this is done .However, there is no reported reduction of maximum output power in the HSUPA mode since the device also provides a compensation for the power back-off by increasing the gain of TX\_AGC in the transceiver (PA) device.

The end effect is that the DUT output power is identical to the case where there is no MPR in the device.



## 10. TEST RESULTS

### 10.1. SAR Test Results Summary

#### 10.1.1. Test position and configuration

Head SAR was performed with the device configured in the positions according to IEEE1528, and Body SAR was performed with the device 5mm from the phantom; Body SAR was also performed with the headset attached and without. The overall device length and width(12.4cm×6.3cm) are >9cm×5cm, Hotspot mode with a test separation distance of 10mm.

#### 10.1.2. Operation Mode

- According to KDB 447498 D01 v05r01 ,for each exposure position, if the highest 1-g SAR is  $\leq 0.8$  W/kg, testing for low and high channel is optional.
- Per KDB 865664 D01 v01r01,for each frequency band, if the measured SAR is  $\geq 0.8$ W/Kg, testing for repeated SAR measurement is required , that the highest measured SAR is only to be tested. When the SAR results are near the limit, the following procedures are required for each device to verify these types of SAR measurement related variation concerns by repeating the highest measured SAR configuration in each frequency band.
  - (1) When the original highest measured SAR is  $\geq 0.8$ W/Kg, repeat that measurement once.
  - (2) Perform a second repeated measurement only if the ratio of largest to smallest SAR for the original and first repeated measurements is  $> 1.20$  or when the original or repeated measurement is  $\geq 1.45$  W/Kg.
  - (3) Perform a third repeated measurement only if the original, first and second repeated measurement is  $\geq 1.5$  W/Kg and ratio of largest to smallest SAR for the original, first and second measurement is  $\geq 1.20$ .
- Body-worn exposure conditions are intended to voice call operations, therefore GSM voice call mode is selected to be test.
- According to KDB 648474 D04 v01r01,when the reported SAR for a body-worn accessory measured without a headset connected to the handset is  $\leq 1.2$ W/Kg, SAR testing with a headset connected is not required.
- According to 941225 D06, when the overall device length and width are >9cm×5cm, Hotspot mode with a test separation distance of 10mm. For device with form factors smaller than 9cm×5cm, Hotspot mode with a test separation distance of 5mm. Body SAR was also performed with the headset attached and without.
- According to 248227 D01, SAR is not required for 802.11g channels when the maximum average output power is less than 1/4dB higher than measured on the corresponding 802.11b channels.
- Maximum Scaling SAR in order to calculate the Maximum SAR values to test under the standard Peak Power, Calculation method is as follows:  
Maximum Scaling SAR =tested SAR (Max.)  $\times$  [GSM standard Peak Power (mw)/ tested Max. Peak Power (mw) ]

### 10.1.3. SAR Test Results Summary

SAR MEASUREMENT									
Ambient Temperature (°C) : 21 ± 2						Relative Humidity (%): 55			
Liquid Temperature (°C) : 21 ± 2						Depth of Liquid (cm):>15			
Product: Smart Phone									
Test Mode: GSM835 with GMSK modulation									
Configuration			Antenna Position	Frequency		Power Drift (<±5%)	SAR (1g) (W/kg)	Limit (W/kg)	
SIM	Position	Status		channel	MHz				
<1>	Left Head	Cheek	Fixed	128	824.2	--	--	--	
				190	836.6	-0.02	<b>0.304</b>	1.6	
				251	848.8	--	--	--	
		Tilted		Fixed	128	824.2	--	--	--
					190	836.6	-0.02	0.287	1.6
					251	848.8	--	--	--
	Right Head	Cheek	Fixed		128	824.2	--	--	--
					190	836.6	-0.10	0.283	1.6
					251	848.8	--	--	--
		Tilted		Fixed	128	824.2	--	--	--
					190	836.6	-0.03	0.266	1.6
					251	848.8	--	--	--
<2>	Left	Cheek	Fixed		190	836.6	0.47	0.244	1.6

Note: when the 1-g SAR is ≤ 0.8 W/kg, testing for low and high channel is optional. refer to KDB 941225.

SAR MEASUREMENT								
Ambient Temperature (°C) : 21 ± 2						Relative Humidity (%): 55		
Liquid Temperature (°C) : 21 ± 2						Depth of Liquid (cm):>15		
Product: Smart Phone								
Test Mode: GSM835 with GMSK modulation								
Configuration			Antenna Position	Frequency		Power Drift (<±5%)	SAR (1g) (W/kg)	Limit (W/kg)
SIM	Position	Status		channel	MHz			
<1>	Body back	MS	Fixed	128	824.2	--	--	--
				190	836.6	-0.03	<b>0.683</b>	1.6
				251	848.8	--	--	--
	Body Front	MS	Fixed	128	824.2	--	--	--
				190	836.6	-0.01	0.374	1.6
				251	848.8	--	--	--

Note: when the 1-g SAR is ≤ 0.8 W/kg, testing for low and high channel is optional. refer to KDB 941225.

SAR MEASUREMENT								
Ambient Temperature (°C) : 21 ± 2						Relative Humidity (%): 55		
Liquid Temperature (°C) : 21 ± 2						Depth of Liquid (cm):>15		
Product: Smart Phone								
Test Mode: PCS1900 with GMSK modulation								
Configuration			Antenna Position	Frequency		Power Drift (<±5%)	SAR (1g) (W/kg)	Limit (W/kg)
SIM	Position	Status		channel	MHz			
<1>	Left Head	Cheek	Fixed	512	1850.2	--	--	--
				661	1880.0	-0.05	0.264	1.6
				810	1909.8	--	--	--
		Tilted	Fixed	512	1850.2	--	--	--
				661	1880.0	-0.04	0.078	1.6
				810	1909.8	--	--	--
	Right Head	Cheek	Fixed	512	1850.2	--	--	--
				661	1880.0	-0.02	<b>0.364</b>	1.6
				810	1909.8	--	--	--
		Tilted	Fixed	512	1850.2	--	--	--
				661	1880.0	0.01	0.087	1.6
				810	1909.8	--	--	--
<2>	Right	Cheek	Fixed	661	1880.0	0.78	0.309	1.6

Note: when the 1-g SAR is ≤ 0.8 W/kg, testing for low and high channel is optional. refer to KDB 941225.

SAR MEASUREMENT								
Ambient Temperature (°C) : 21 ± 2						Relative Humidity (%): 55		
Liquid Temperature (°C) : 21 ± 2						Depth of Liquid (cm):>15		
Product: Smart Phone								
Test Mode: PCS 1900 with GMSK modulation								
Configuration			Antenna Position	Frequency		Power Drift (<±5%)	SAR (1g) (W/kg)	Limit (W/kg)
SIM	Position	Status		channel	MHz			
<1>	Body Back	MS	Fixed	512	1850.2	--	--	--
				661	1880.0	0.02	<b>0.688</b>	1.6
				810	1909.8	--	--	--
	Body front	MS	Fixed	512	1850.2	--	--	--
				661	1880.0	-0.01	0.532	1.6
				810	1909.8	--	--	--

Note: when the 1-g SAR is ≤ 0.8 W/kg, testing for low and high channel is optional. refer to KDB 941225.

SAR MEASUREMENT								
Ambient Temperature (°C) : 21 ± 2						Relative Humidity (%): 55		
Liquid Temperature (°C) : 21 ± 2						Depth of Liquid (cm):>15		
Product: Smart Phone								
Test Mode: WCDMA Band V with QPSK modulation								
Configuration			Antenna Position	Frequency		Power Drift (<±5%)	SAR (1g) (W/kg)	Limit (W/kg)
SIM	Position	Status		channel	MHz			
<1>	Left Head	Cheek	Fixed	4132	826.4	--	--	--
				4182	835.0	-0.05	0.455	1.6
				4233	846.6	--	--	--
		Tilted	Fixed	4132	826.4	--	--	--
				4182	835.0	-0.06	0.419	1.6
				4233	846.6	--	--	--
	Right Head	Cheek	Fixed	4132	826.4	--	--	--
				4182	835.0	-0.02	0.464	1.6
				4233	846.6	--	--	--
		Tilted	Fixed	4132	826.4	--	--	--
				4182	835.0	0.01	<b>0.484</b>	1.6
				4233	846.6	--	--	--

Note: when the 1-g SAR is ≤ 0.8 W/kg, testing for low and high channel is optional. refer to KDB 941225.

SAR MEASUREMENT								
Ambient Temperature (°C) : 21 ± 2						Relative Humidity (%): 55		
Liquid Temperature (°C) : 21 ± 2						Depth of Liquid (cm):>15		
Product: Smart Phone								
Test Mode: WCDMA Band V with QPSK modulation								
Configuration			Antenna Position	Frequency		Power Drift (<±5%)	SAR (1g) (W/kg)	Limit (W/kg)
SIM	Position	Status		channel	MHz			
<1>	Body	RMC (towards grounds)	Fixed	4132	826.4	0.31	<b>1.107</b>	1.6
				4182	835.0	-0.05	0.884	1.6
				4233	846.6	-1.27	1.104	1.6
		RMC (towards phantom)	Fixed	4132	826.4	-0.09	0.525	1.6
				4182	835.0	--	--	--
				4233	846.6	--	--	--

Note: when the 1-g SAR is ≤ 0.8 W/kg, testing for low and high channel is optional. refer to KDB 941225.

Repeated SAR								
Ambient Temperature (°C) : 21 ± 2						Relative Humidity (%): 55		
Liquid Temperature (°C) : 21 ± 2						Depth of Liquid (cm):>15		
Product: Smart Phone								
Test Mode: GSM835 with GMSK modulation								
Configuration			Antenna Position	Frequency		Power Drift (<±5%)	SAR (1g) (W/kg)	Limit (W/kg)
SIM	Position	Status		channel	MHz			
<1>	Body back	MS	Fixed	128	824.2	--	--	--
				190	836.6	-1.04	<b>0.564</b>	1.6
				251	848.8	--	--	--

Repeated SAR								
Ambient Temperature (°C) : 21 ± 2						Relative Humidity (%): 55		
Liquid Temperature (°C) : 21 ± 2						Depth of Liquid (cm):>15		
Product: Smart Phone								
Test Mode: PCS 1900 with GMSK modulation								
Configuration			Antenna Position	Frequency		Power Drift (<±5%)	SAR (1g) (W/kg)	Limit (W/kg)
SIM	Position	Status		channel	MHz			
<1>	Body Back	MS	Fixed	512	1850.2	--	--	--
				661	1880.0	0.28	<b>0.553</b>	1.6
				810	1909.8	--	--	--

Repeated SAR								
Ambient Temperature (°C) : 21 ± 2						Relative Humidity (%): 55		
Liquid Temperature (°C) : 21 ± 2						Depth of Liquid (cm):>15		
Product: Smart Phone								
Test Mode: WCDMA Band V with QPSK modulation								
Configuration			Antenna Position	Frequency		Power Drift (<±5%)	SAR (1g) (W/kg)	Limit (W/kg)
SIM	Position	Status		channel	MHz			
<1>	Body	RMC (towards grounds)	Fixed	4132	826.4	0.01	<b>1.086</b>	1.6
				4182	835.0	1.56	0.824	1.6
				4233	846.6	-1.84	1.003	1.6



SAR MEASUREMENT								
Ambient Temperature (°C) : 21 ± 2						Relative Humidity (%): 55		
Liquid Temperature (°C) : 21 ± 2						Depth of Liquid (cm):>15		
Product: Smart Phone								
Test Mode: 802.11b								
Configuration			Antenna Position	Frequency		Power Drift (<±5%)	SAR (1g) (W/kg)	Limit (W/kg)
Test Mode	Position	Status		channel	MHz			
802.11b	Left Head	Cheek	Fixed	1	2412	--	--	--
				6	2437	-0.87	0.257	1.6
				11	2462	--	--	--
		Tilted	Fixed	1	2412	--	--	--
				6	2437	-0.52	0.192	1.6
				11	2462	--	--	--
	Right Head	Cheek	Fixed	1	2412	--	--	--
				6	2437	-1.12	<b>0.267</b>	1.6
				11	2462	--	--	--
		Tilted	Fixed	1	2412	--	--	--
				6	2437	0.47	0.232	1.6
				11	2462	--	--	--

Note1: when the 1-g SAR is ≤ 0.8 W/kg, testing for low and high channel is optional.  
Note2: IEEE802.11b support DBPSK, DQPSK, CCK modulation mode, IEEE802.11g/n support OFDM, 16-QAM, 64-QAM modulation mode.

SAR MEASUREMENT								
Ambient Temperature (°C) : 21 ± 2						Relative Humidity (%): 55		
Liquid Temperature (°C) : 21 ± 2						Depth of Liquid (cm):>15		
Product: Smart Phone								
Test Mode: 802.11b								
Configuration			Antenna Position	Frequency		Power Drift (<±5%)	SAR (1g) (W/kg)	Limit (W/kg)
Test Mode	Position	Status		channel	MHz			
802.11b	Body Back	MS	Fixed	1	2412	--	--	--
				6	2437	0.92	<b>0.268</b>	1.6
				11	2462	--	--	--
	Body front	MS	Fixed	1	2412	--	--	--
				6	2437	-0.41	0.156	1.6
				11	2462	--	--	--

Note1: when the 1-g SAR is ≤ 0.8 W/kg, testing for low and high channel is optional.  
Note2: IEEE802.11b support DBPSK, DQPSK, CCK modulation mode, IEEE802.11g/n support OFDM, 16-QAM, 64-QAM modulation mode.

SAR MEASUREMENT								
Ambient Temperature (°C) : 21 ± 2						Relative Humidity (%): 55		
Liquid Temperature (°C) : 21 ± 2						Depth of Liquid (cm):>15		
Product: Smart Phone								
Test Mode: Hotspot								
Configuration			Antenna Position	Frequency		Power Drift (<±5%)	SAR (1g) (W/kg)	Limit (W/kg)
Test Mode	Position	Status		channel	MHz			
Hotspot	Left Head	Cheek	Fixed	1	2412	--	--	--
				6	2437	-0.58	0.119	1.6
				11	2462	--	--	--
		Tilted	Fixed	1	2412	--	--	--
				6	2437	0.35	<b>0.142</b>	1.6
				11	2462	--	--	--
	Right Head	Cheek	Fixed	1	2412	--	--	--
				6	2437	-0.62	0.097	1.6
				11	2462	--	--	--
		Tilted	Fixed	1	2412	--	--	--
				6	2437	1.42	0.103	1.6
				11	2462	--	--	--

Note: when the 1-g SAR is ≤ 0.8 W/kg, testing for low and high channel is optional.

SAR MEASUREMENT								
Ambient Temperature (°C) : 21 ± 2						Relative Humidity (%): 55		
Liquid Temperature (°C) : 21 ± 2						Depth of Liquid (cm):>15		
Product: Smart Phone								
Test Mode: Hotspot								
Configuration			Antenna Position	Frequency		Power Drift (<±5%)	SAR (1g) (W/kg)	Limit (W/kg)
Test Mode	Position	Status		channel	MHz			
Hotspot	Body Back	MS	Fixed	1	2412	--	--	--
				6	2437	0.63	<b>0.175</b>	1.6
				11	2462	--	--	--
	Body front	MS	Fixed	1	2412	--	--	--
				6	2437	-1.02	0.109	1.6
				11	2462	--	--	--

Note: when the 1-g SAR is ≤ 0.8 W/kg, testing for low and high channel is optional.

**Simultaneous Multi-band Transmission Evaluation:  
Application Simultaneous Transmission information:**

Position	Simultaneous state
Head	1.WWAN(voice)+WLAN 2.4GHz band
	2.WWAN(voice)+Bluetooth
	3.WWAN(voice)+ HOTSPOT 2.4GHz band
Body	4. WWAN(voice)+WLAN 2.4GHz band
	5. WWAN(voice)+Bluetooth
	6.WWAN(voice)+ HOTSPOT 2.4GHz band

**NOTE:**

- WLAN and BT share the same antenna, and cannot transmit simultaneously.
- Simultaneous with every transmitter must be the same test position.
- Based upon KDB 447498 D01 v05, BT SAR is excluded as below table.
- Based upon KDB 447498 D01 v05,for handsets the test separation distance is determined by the smallest distance between the outer surface of the device and the user; which is 0mm for head SAR AND 5mm for body-worn SAR.
- If the test separation distance is <5mm, 5mm is used for excluded SAR calculation.
- For minimum test separation distance  $\cong 50\text{mm}$ ,Bluetooth standalone SAR is excluded according to  $[(\text{max. power of channel, including tune-up tolerance, mW}) / (\text{min. test separation distance, mm}) \cdot \sqrt{f \text{ (GHz)}} / x] \cong 3.0$  for 1-g SAR and  $\cong 7.5$  for 10-g extremity SAR
- KDB 447498 / 4.3.2 (2) when standalone SAR test exclusion applies to an antenna that transmits simultaneously with other antennas, the standalone SAR must be estimated according to following to determine simultaneous transmission SAR test exclusion:
  - $(\text{max. power of channel, including tune-up tolerance, mW}) / (\text{min. test separation distance, mm}) \cdot \sqrt{f \text{ (GHz)}} / x$  W/kg for test separation distances  $\leq 50$  mm; Where  $x = 7.5$  for 1-g SAR, and  $x = 18.75$  for 10-g SAR.
  - 0.4W/Kg for 1-g SAR and 1.0W/Kg for 10-g SAR, when the separation distance is >50mm.

		Maximum Average Power		Antenna to user (mm)	SAR exclusion threshold (mW)	SAR testing required (Yes/No)	Head (0mm gap)	Body (5mm gap)
		dBm	mW					
BT	Head	3.59	2.286	5	10	NO	0.0960 W/kg	0.0960 W/kg
	Body			5	10	NO		

**Maximum test results (WWAN) with BT and WIFI/ HOTSPOT SAR:**

**BT:** Head (0 cm gap): 0.0960 W/kg and Body (0.5 cm gap): 0.0960 W/kg  
**WIFI:** Head (0 cm gap): 0.267 W/kg and Body (0.5cm gap): 0.0126 W/kg  
**HOTSPOT:** Head (0 cm gap): 0.142 W/kg and Body (1.0 cm gap): 0.175 W/kg

**WIFI**

Head					
Conditions (SAR1+SAR2)	Position	Max. SAR1	Max. SAR2	SAR Summation	Limit (W/kg)
<b>GSM835 +WIFI (voice)</b>	Left Cheek	0.304	0.257	0.561	1.6
<b>PCS1900 +WIFI (voice)</b>	Right Cheek	0.364	0.267	0.631	1.6
<b>WCDMA Band V +WIFI (voice)</b>	Right Tilt	0.484	0.232	<b>0.716</b>	1.6
Body					
Conditions (SAR1+SAR2)	Position	Max. SAR1	Max. SAR2	SAR Summation	Limit (W/kg)
<b>GSM835 +WIFI (voice)</b>	Body Back (MS)	0.683	0.268	0.951	1.6
<b>PCS1900 +WIFI (voice)</b>	Body Back (MS)	0.688	0.268	0.956	1.6
<b>WCDMA Band V +WIFI(voice)</b>	RMC (towards grounds)	1.107	0.268	<b>1.375</b>	1.6

**HOTSPOT**

Head					
Conditions (SAR1+SAR2)	Position	Max. SAR1	Max. SAR2	SAR Summation	Limit (W/kg)
GSM835 + Hotspot(voice)	Left Cheek	0.304	0.119	0.423	1.6
PCS1900 + Hotspot(voice)	Right Cheek	0.364	0.097	0.461	1.6
WCDMA Band V + Hotspot(voice)	Right Tilt	0.484	0.103	0.587	1.6
Body					
Conditions (SAR1+SAR2)	Position	Max. SAR1	Max. SAR2	SAR Summation	Limit (W/kg)
GSM835 + Hotspot(voice)	Body Back (MS)	0.683	0.175	0.858	1.6
PCS1900 + Hotspot I(voice)	Body Back (MS)	0.688	0.175	0.863	1.6
WCDMA Band V + Hotspot(voice)	RMC (towards grounds)	1.107	0.175	<b>1.282</b>	1.6

## APPENDIX A. SAR SYSTEM VALIDATION DATA

Test Laboratory: AGC Lab

Date: Dec.12, 2013

System Check Head 835 MHz

DUT: Dipole 900 MHz Type: SID 900

Communication System CW; Communication System Band: D835 (835.0 MHz); Duty Cycle: 1:1; Conv.F=5.30

Frequency: 835 MHz; Medium parameters used:  $f = 835$  MHz;  $\sigma=0.84$  mho/m;  $\epsilon_r=40.26$ ;  $\rho= 1000$  kg/m<sup>3</sup> ;

Phantom section: Flat Section ; Input Power=10dBm

Ambient temperature (°C): 21, Liquid temperature (°C): 21

SATIMO Configuration:

Probe: EP165; Calibrated: 01/31/2013

- Sensor-Surface: 4mm (Mechanical Surface Detection)
- Phantom: Flat Phantom; Type: Elliptical Phantom
- Measurement SW: OpenSAR V4\_02\_01

Configuration/System Check GSM 835 Head/Area Scan: Measurement grid: dx=8mm,dy=8mm

Configuration/System Check GSM 835 Head/Zoom Scan: Measurement grid: dx=8mm, dy=8mm, dz=5mm

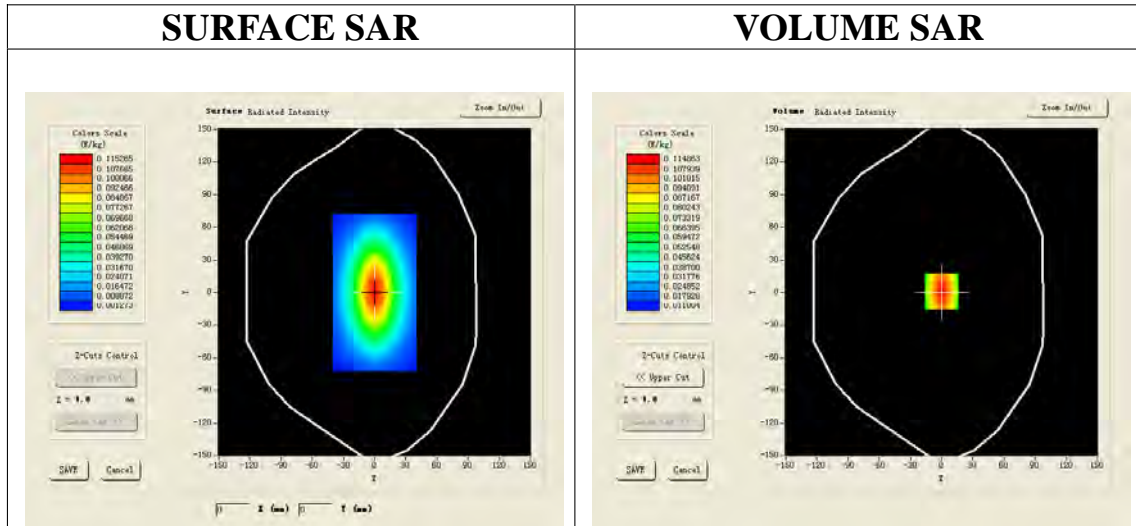

**Maximum location: X=0.00, Y=1.00**

<b>SAR 10g (W/Kg)</b>	0.068256
<b>SAR 1g (W/Kg)</b>	0.109574



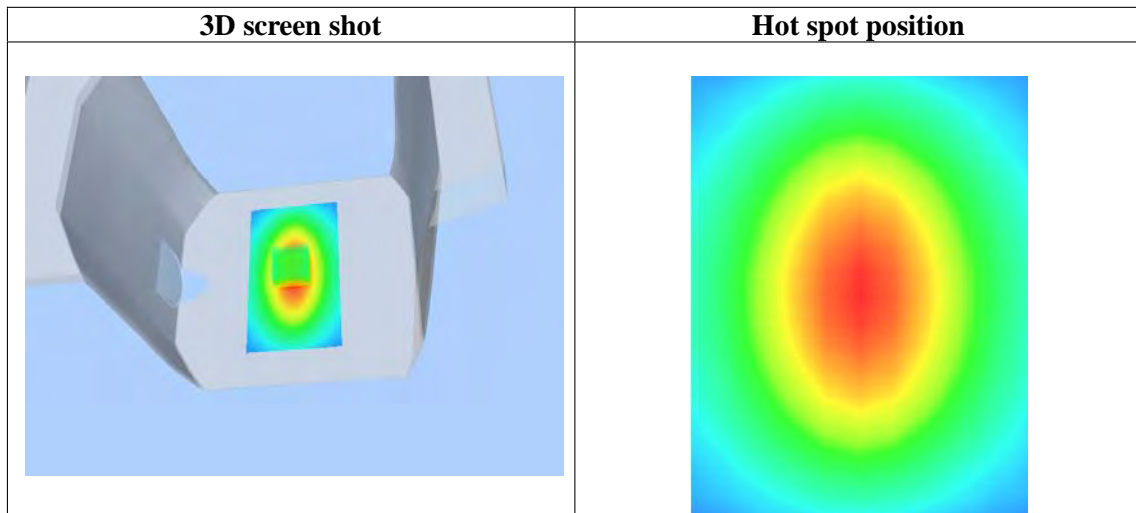
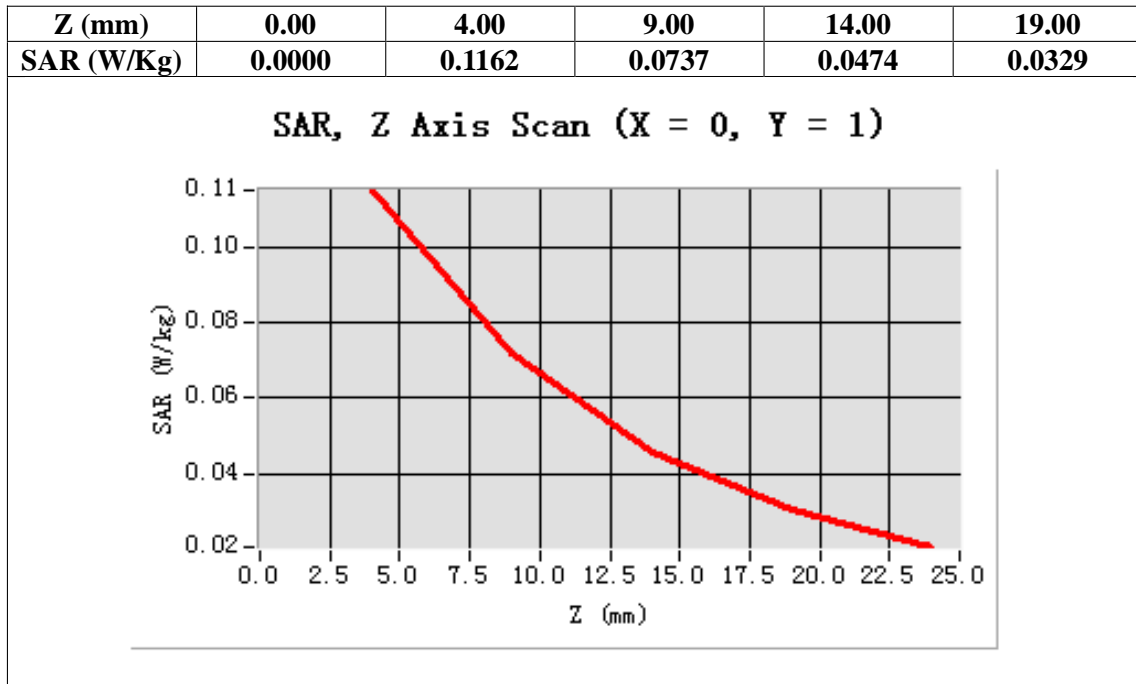

**Test Laboratory: AGC Lab**  
**System Check Head 1900MHz**

**Date: Dec.12, 2013**

**DUT: Dipole 1900 MHz; Type: SID 1900**

Communication System: CW; Communication System Band: D1900 (1900.0 MHz); Duty Cycle:1:1; Conv.F=4.72  
Frequency: 1900 MHz; Medium parameters used:  $f = 1900$  MHz;  $\sigma=1.36$  mho/m;  $\epsilon_r=40.51$ ;  $\rho= 1000$  kg/m<sup>3</sup> ;  
Phantom section: Flat Section ; Input Power=10dBm  
Ambient temperature (°C): 21, Liquid temperature (°C): 21

SATIMO Configuration:

Probe: EP165; Calibrated: 01/31/2013

- Sensor-Surface: 4mm (Mechanical Surface Detection)
- Phantom: Flat Phantom; Type: Elliptical Phantom
- Measurement SW: OpenSAR V4\_02\_01

**Configuration/System Check PCS1900 Head/Area Scan: Measurement grid: dx=8mm,dy=8mm**

**Configuration/System Check PCS1900 Head/Zoom Scan: Measurement grid: dx=8mm, dy=8mm, dz=5mm**

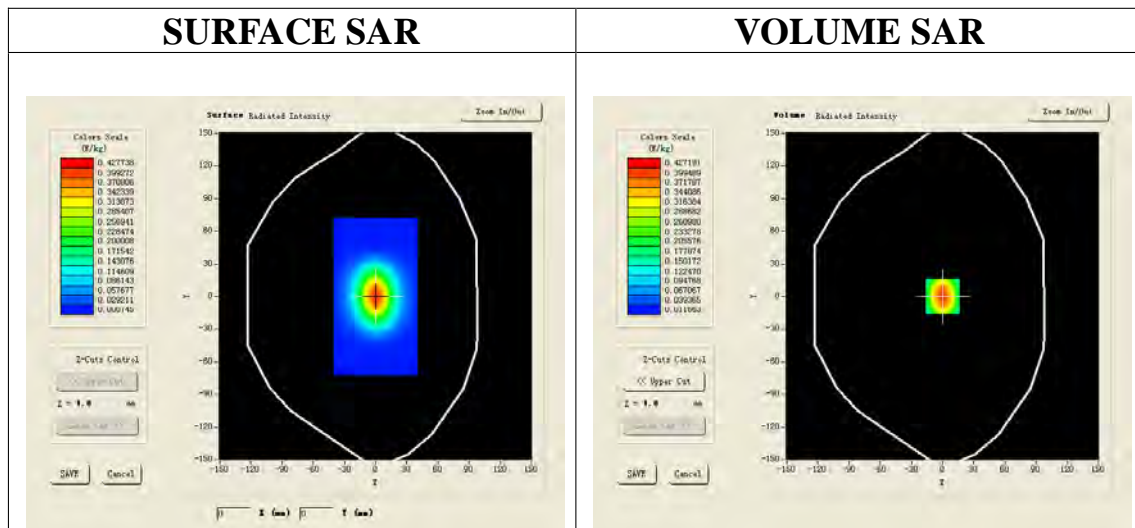

**Maximum location: X=0.00, Y=0.00**

<b>SAR 10g (W/Kg)</b>	0.207458
<b>SAR 1g (W/Kg)</b>	0.389425

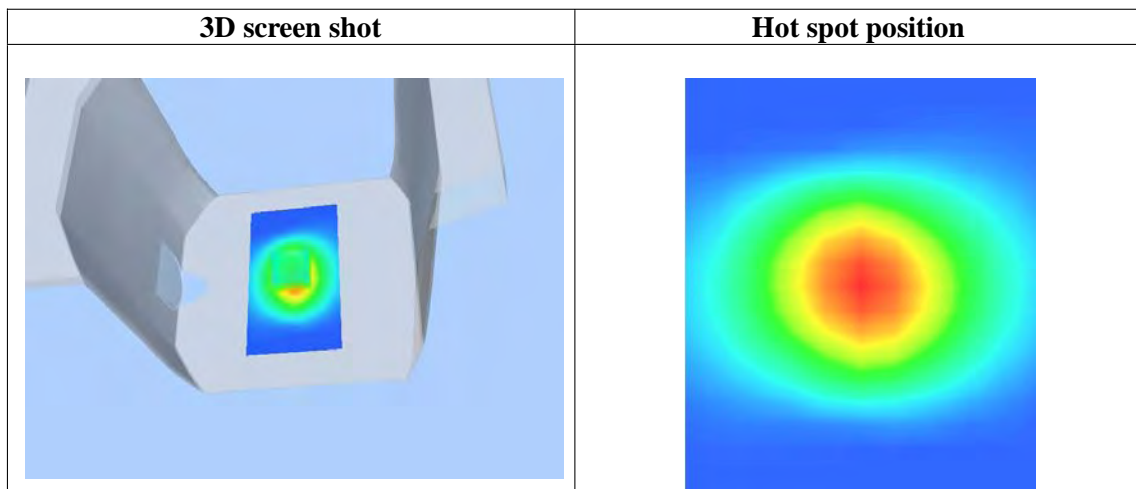
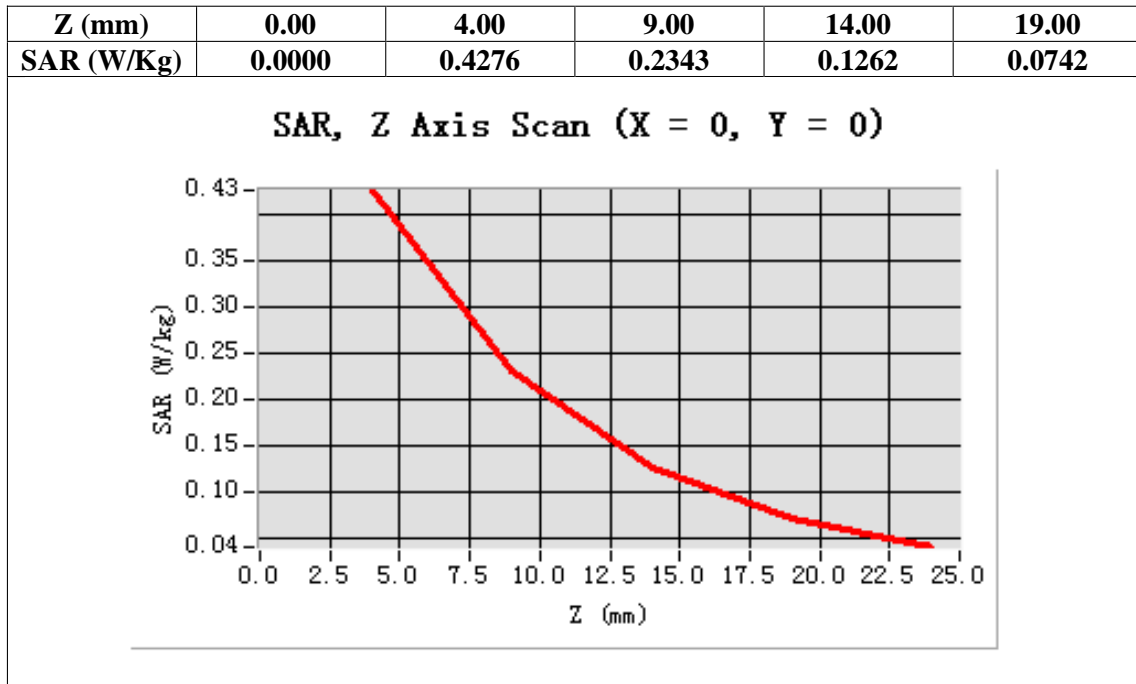

**Test Laboratory: AGC Lab**  
**System Check Head 2450 MHz**

**Date: Dec.12, 2013**

**DUT: Dipole 2450 MHz Type: SID 2450**

Communication System: CW; Communication System Band: D2450 (2450.0 MHz); Duty Cycle: 1:1; Conv.F=4.19  
Frequency: 2450 MHz; Medium parameters used:  $f = 2450$  MHz;  $\sigma = 1.84$  mho/m;  $\epsilon_r = 38.54$ ;  $\rho = 1000$  kg/m<sup>3</sup> ;  
Phantom section: Flat Section; Input Power=10dBm  
Ambient temperature (°C): 21, Liquid temperature (°C): 21

SATIMO Configuration:

Probe: EP165; Calibrated: 01/31/2013

- Sensor-Surface: 4mm (Mechanical Surface Detection)
- Phantom: Flat Phantom; Type: Elliptical Phantom
- Measurement SW: OpenSAR V4\_02\_01

**Configuration/System Check 2450 MHz Head/Area Scan: Measurement grid: dx=8mm,dy=8mm**

**Configuration/System Check 2450 MHz Head/Zoom Scan: Measurement grid: dx=8mm, dy=8mm, dz=5mm**

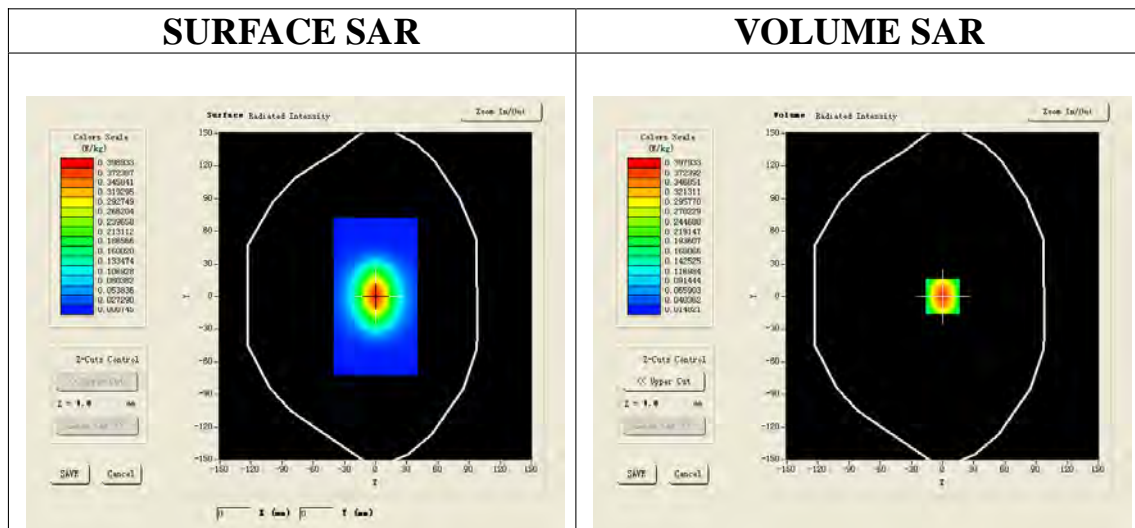

**Maximum location: X=0.00, Y=0.00**

<b>SAR 10g (W/Kg)</b>	<b>0.225876</b>
<b>SAR 1g (W/Kg)</b>	<b>0.495726</b>

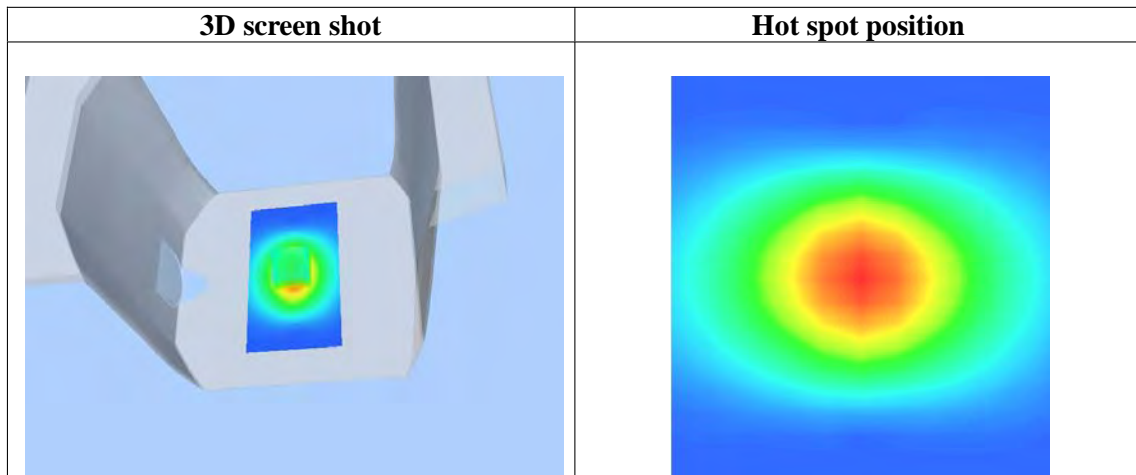
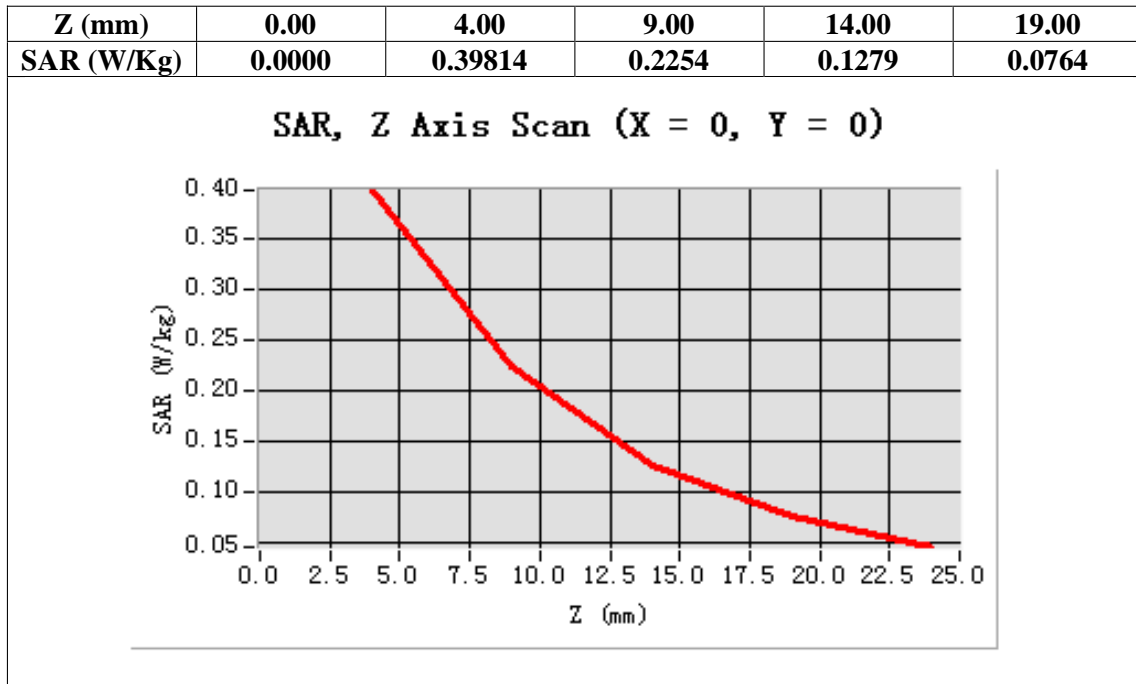

## APPENDIX B. SAR MEASUREMENT DATA

Test Laboratory: AGC Lab  
GSM 835 Mid-Touch-Left <SIM 1>  
DUT: Smart Phone; Type: Syreni 40DC

Date: Dec.12, 2013

Communication System: Generic GSM; Communication System Band: GSM 835; Duty Cycle: 1:8.3; Conv.F=5.30  
Frequency: 836.6 MHz; Medium parameters used:  $f = 835$  MHz;  $\sigma=0.84$  mho/m;  $\epsilon_r = 40.26$ ;  $\rho = 1000$  kg/m<sup>3</sup> ;  
Phantom section: Left Section  
Ambient temperature (°C): 21.0, Liquid temperature (°C): 21.0

### SATIMO Configuration:

- Probe: EP165; Calibrated: 01/31/2013
- Sensor-Surface: 4mm (Mechanical Surface Detection)
- Phantom: Flat Phantom; Type: Elliptical Phantom
- Measurement SW: OpenSAR V4\_02\_01

Configuration/GSM 835 Mid-Touch-Left/Area Scan (6x8x1): Measurement grid: dx=8mm, dy=8mm  
Configuration/GSM 835 Mid-Touch-Left/Zoom Scan (5x5x7)/Cube 0: Measurement grid: dx=8mm, dy=8mm, dz=5mm

Area Scan	sam_direct_droit2_surf8mm.txt
ZoomScan	5x5x7,dx=8mm dy=8mm dz=5mm,Very fast
Phantom	Left head
Device Position	Cheek
Band	GSM 835
Channels	Middle
Signal	TDMA (Crest factor: 8.0)

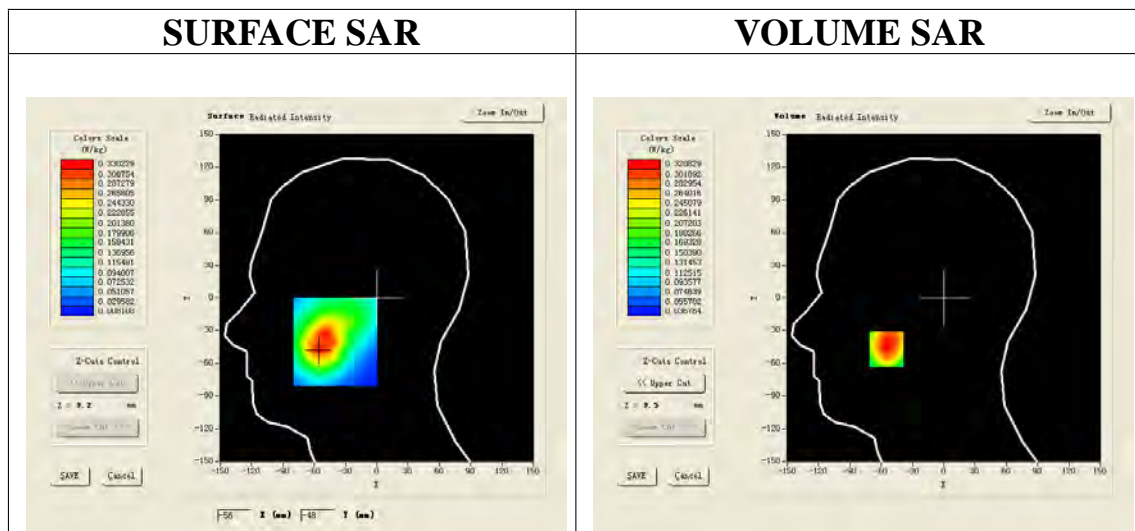

Maximum location: X=-55.00, Y=-47.00

SAR 10g (W/Kg)	0.217158
SAR 1g (W/Kg)	0.303986

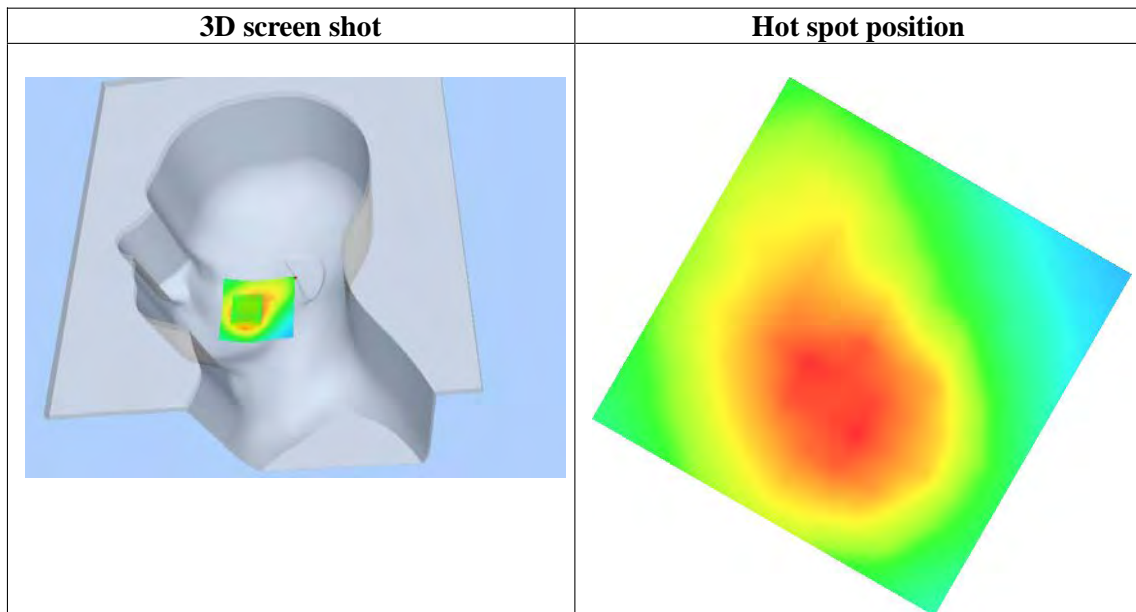
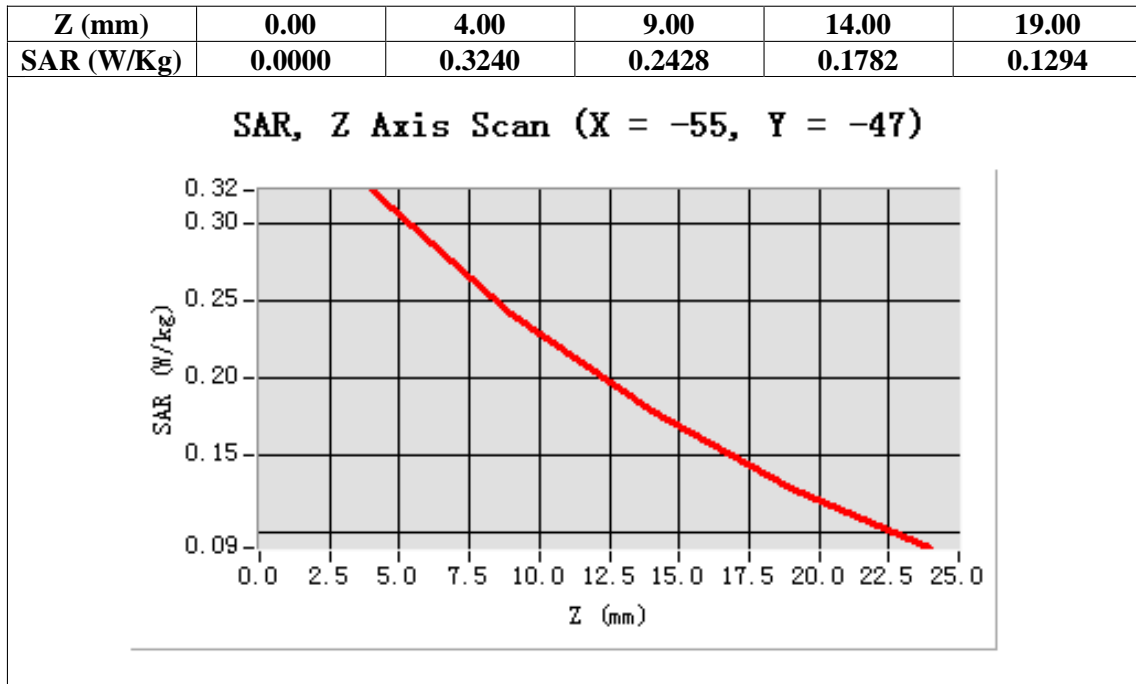

**Test Laboratory: AGC Lab**  
**GSM 835 Mid-Tilt-Left <SIM 1>**  
**DUT: Smart Phone; Type: Syreni 40DC**

**Date: Dec.12, 2013**

Communication System: Generic GSM; Communication System Band: GSM 835; Duty Cycle: 1:8.3; Conv.F=5.30;  
Frequency: 836.6 MHz; Medium parameters used: f = 835 MHz;  $\sigma=0.84$  mho/m;  $\epsilon_r=40.26$  ;  $\rho= 1000$  kg/m<sup>3</sup> ;  
Phantom section: Left Section  
Ambient temperature (°C): 21.0, Liquid temperature(°C): 21.0

**SATIMO Configuration:**

Probe: EP165; Calibrated: 01/31/2013

- Sensor-Surface: 4mm (Mechanical Surface Detection)
- Phantom: Flat Phantom; Type: Elliptical Phantom
- Measurement SW: OpenSAR V4\_02\_01

**Configuration/GSM 835 Mid-Tilt-Left/Area Scan (6x8x1): Measurement grid: dx=8mm, dy=8mm**  
**Configuration/GSM 835 Mid-Tilt-Left/Zoom Scan (5x5x7)/Cube 0: Measurement grid: dx=8mm, dy=8mm,dz=5mm;**

<b>Area Scan</b>	sam_direct_droit2_surf8mm.txt
<b>ZoomScan</b>	5x5x7,dx=8mm dy=8mm dz=5mm,Very fast
<b>Phantom</b>	Left head
<b>Device Position</b>	Tilt
<b>Band</b>	GSM 835
<b>Channels</b>	Middle
<b>Signal</b>	TDMA (Crest factor: 8.0)

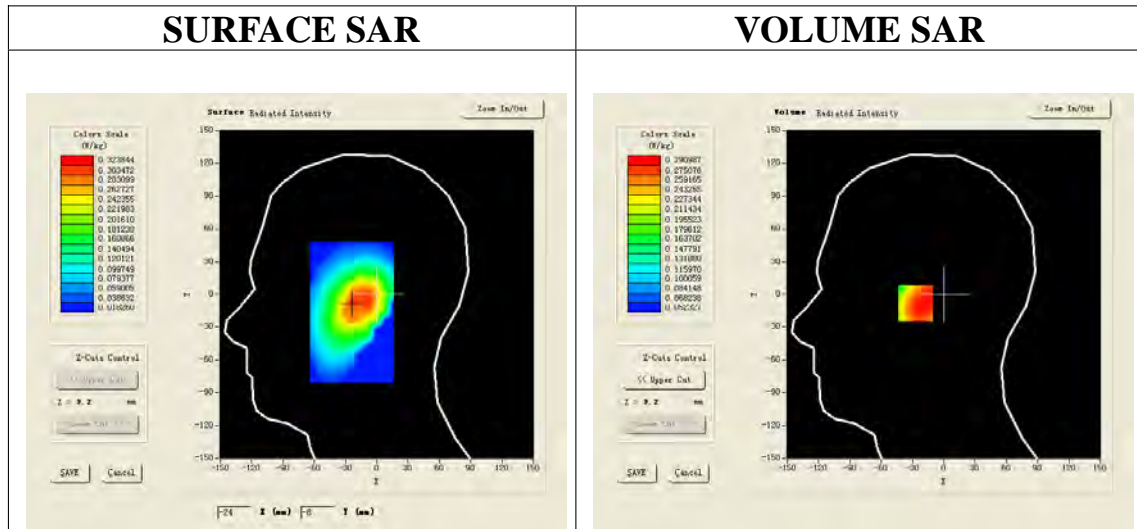

**Maximum location: X=-24.00, Y=-8.00**

<b>SAR 10g (W/Kg)</b>	0.206427
<b>SAR 1g (W/Kg)</b>	0.287238



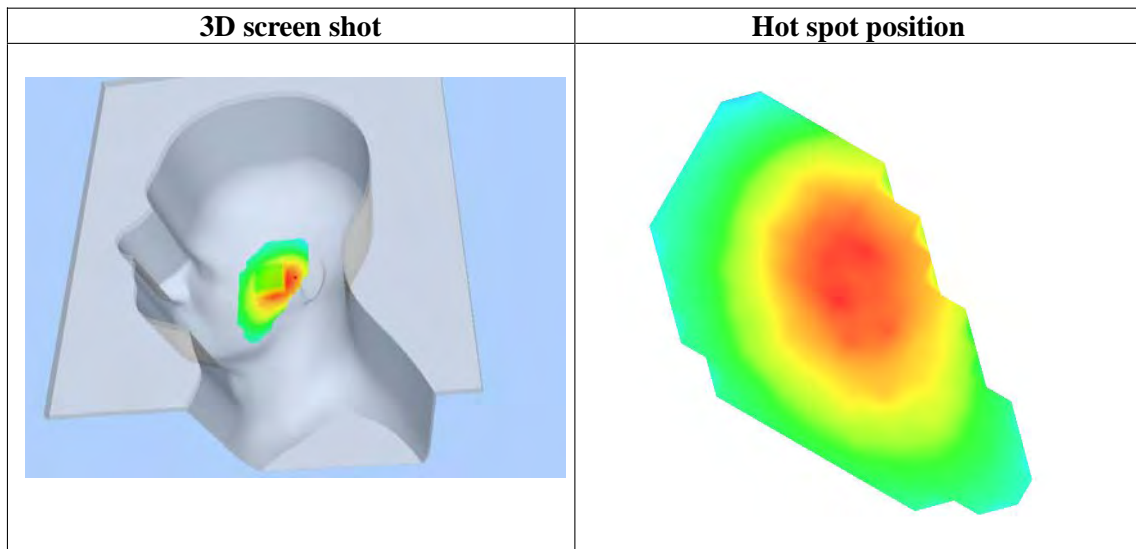
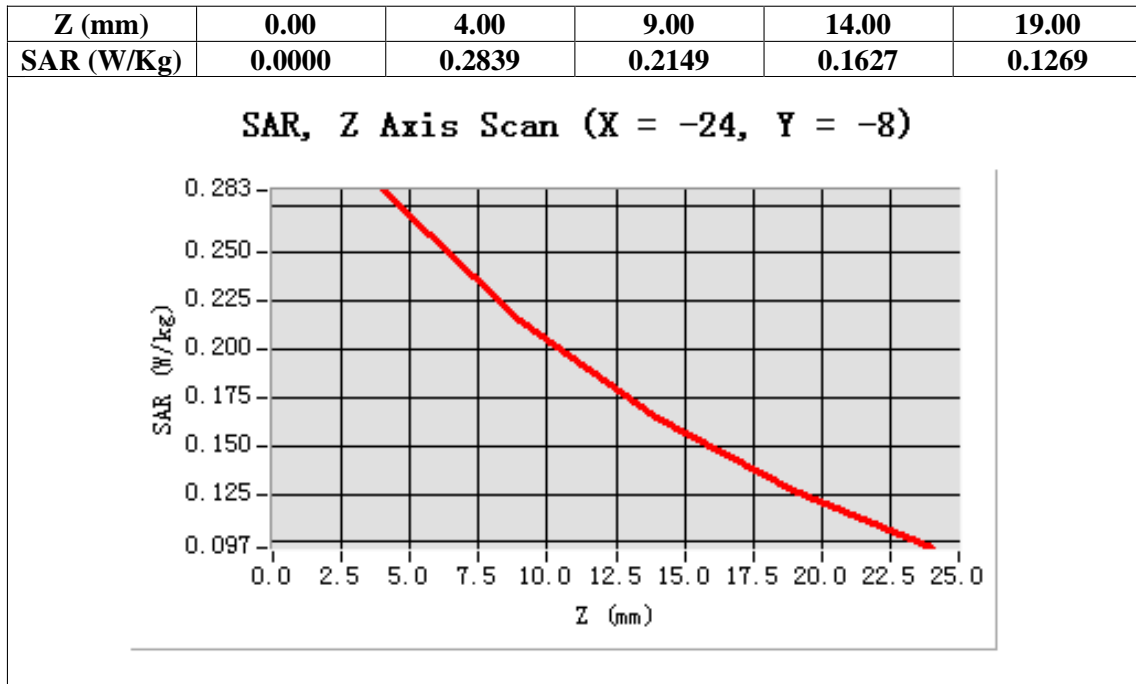

**Test Laboratory: AGC Lab**  
**GSM 835 Mid-Touch-Right <SIM 1>**  
**DUT: Smart Phone; Type: Syreni 40DC**

**Date: Dec.12, 2013**

Communication System: Generic GSM; Communication System Band: GSM 835; Duty Cycle: 1:8.3; Conv.F=5.30;  
Frequency: 836.6 MHz; Medium parameters used:  $f = 835$  MHz;  $\sigma = 0.84$  mho/m;  $\epsilon_r = 40.26$ ;  $\rho = 1000$  kg/m<sup>3</sup> ;  
Phantom section: Right Section  
Ambient temperature (°C): 21.0, Liquid temperature (°C): 21.0

**SATIMO Configuration:**

- Probe: EP165; Calibrated: 01/31/2013
- Sensor-Surface: 4mm (Mechanical Surface Detection)
- Phantom: Flat Phantom; Type: Elliptical Phantom
- Measurement SW: OpenSAR V4\_02\_01

**Configuration/GSM 835 Mid-Touch-Right/Area Scan: Measurement grid: dx=8mm, dy=8mm**  
**Configuration/GSM 835 Mid-Touch-Right/Zoom Scan: Measurement grid: dx=8mm, dy=8mm, dz=5mm;**

<b>Area Scan</b>	sam_direct_droit2_surf8mm.txt
<b>ZoomScan</b>	5x5x7,dx=8mm dy=8mm dz=5mm,Very fast
<b>Phantom</b>	Right head
<b>Device Position</b>	Cheek
<b>Band</b>	GSM 835
<b>Channels</b>	Middle
<b>Signal</b>	TDMA (Crest factor: 8.0)

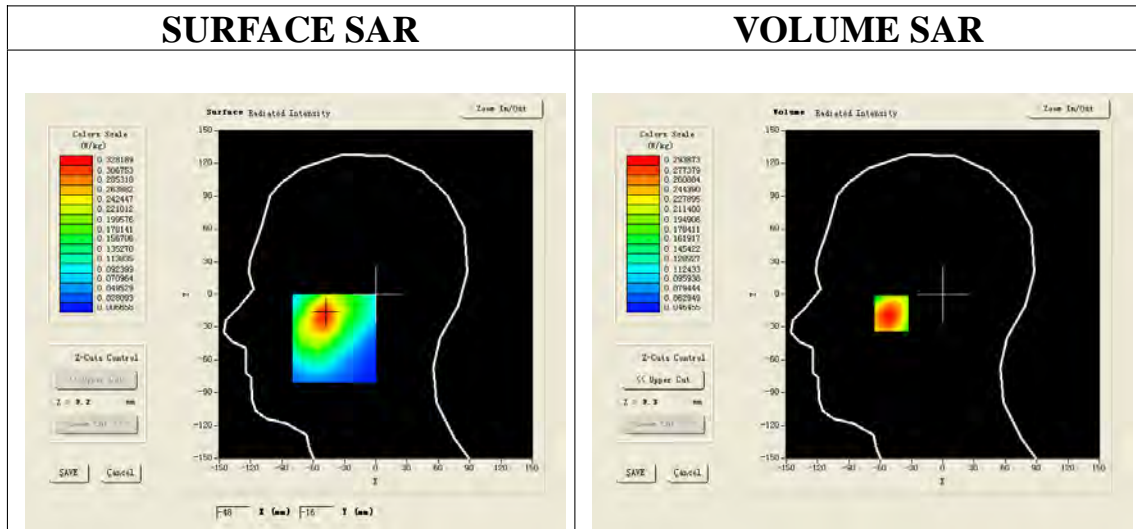

**Maximum location: X=-49.00, Y=-17.00**

<b>SAR 10g (W/Kg)</b>	0.198195
<b>SAR 1g (W/Kg)</b>	0.282871

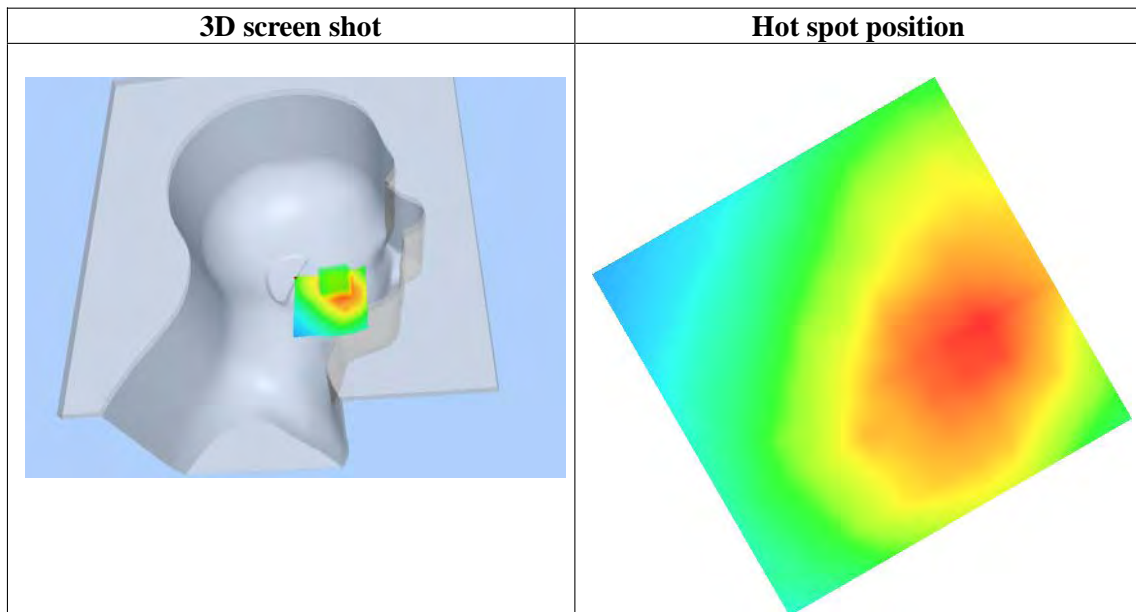
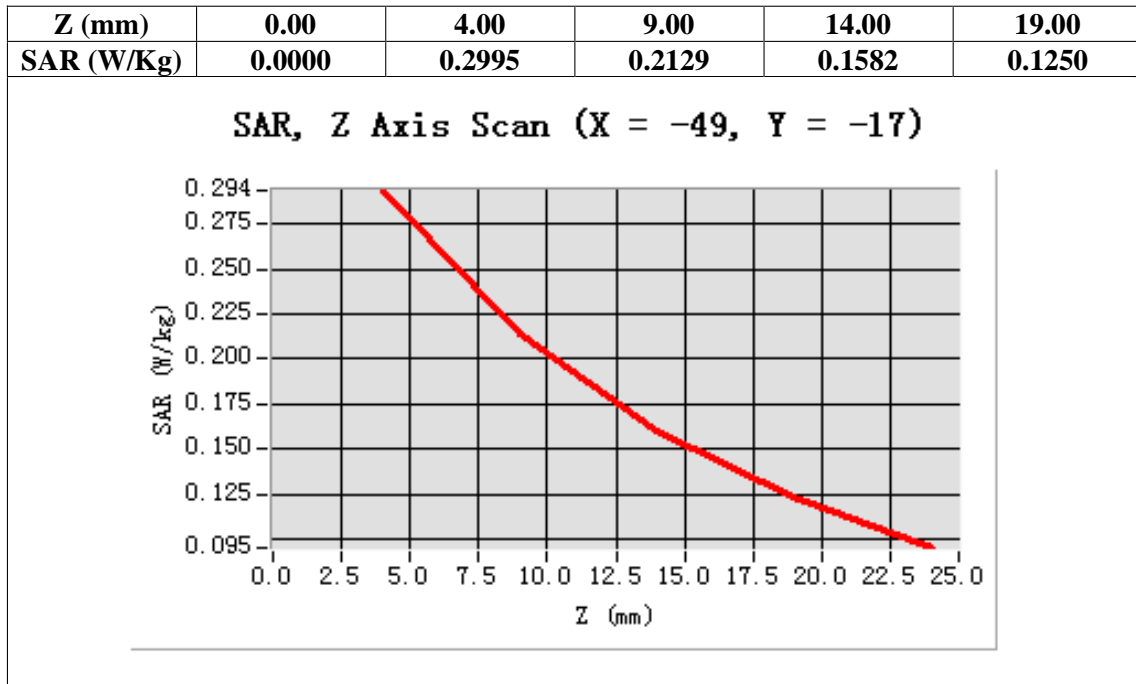

**Test Laboratory: AGC Lab**  
**GSM 835 Mid-Tilt-Right <SIM 1>**  
**DUT: Smart Phone; Type: Syreni 40DC**

**Date: Dec.12, 2013**

Communication System: Generic GSM; Communication System Band: GSM 835; Duty Cycle: 1:8.3; Conv.F=5.30;  
Frequency: 836.6 MHz; Medium parameters used: f = 835 MHz;  $\sigma=0.84$  mho/m;  $\epsilon_r=40.26$  ;  $\rho= 1000$  kg/m<sup>3</sup> ;  
Phantom section: Right Section  
Ambient temperature (°C): 21.0, Liquid temperature (°C): 21.0

SATIMO Configuration:

Probe: EP165; Calibrated: 01/31/2013

- Sensor-Surface: 4mm (Mechanical Surface Detection)
- Phantom: Flat Phantom; Type: Elliptical Phantom
- Measurement SW: OpenSAR V4\_02\_01

**Configuration/GSM 835 Mid-Tilt-Right/Area Scan: Measurement grid: dx=8mm, dy=8mm**  
**Configuration/GSM 835 Mid-Tilt-Right/Zoom Scan: Measurement grid: dx=8mm, dy=8mm, dz=5mm;**

<b>Area Scan</b>	sam_direct_droit2_surf8mm.txt
<b>Zoom Scan</b>	5x5x7,dx=8mm dy=8mm dz=5mm,Very fast
<b>Phantom</b>	Right head
<b>Device Position</b>	Tilt
<b>Band</b>	GSM 835
<b>Channels</b>	Middle
<b>Signal</b>	TDMA (Crest factor: 8.0)

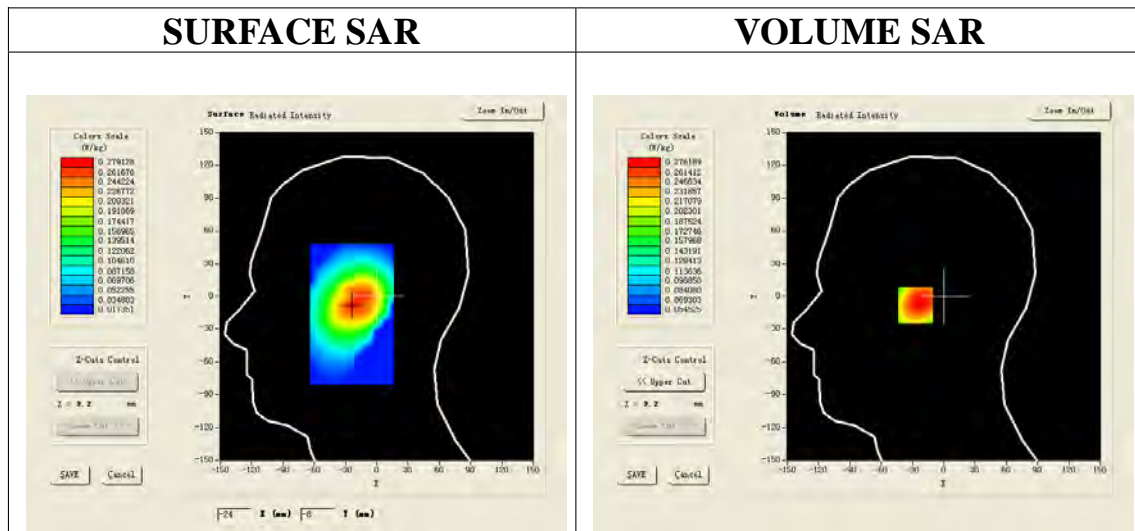

**Maximum location: X=-24.00, Y=-8.00**

<b>SAR 10g (W/Kg)</b>	0.187185
<b>SAR 1g (W/Kg)</b>	0.266369

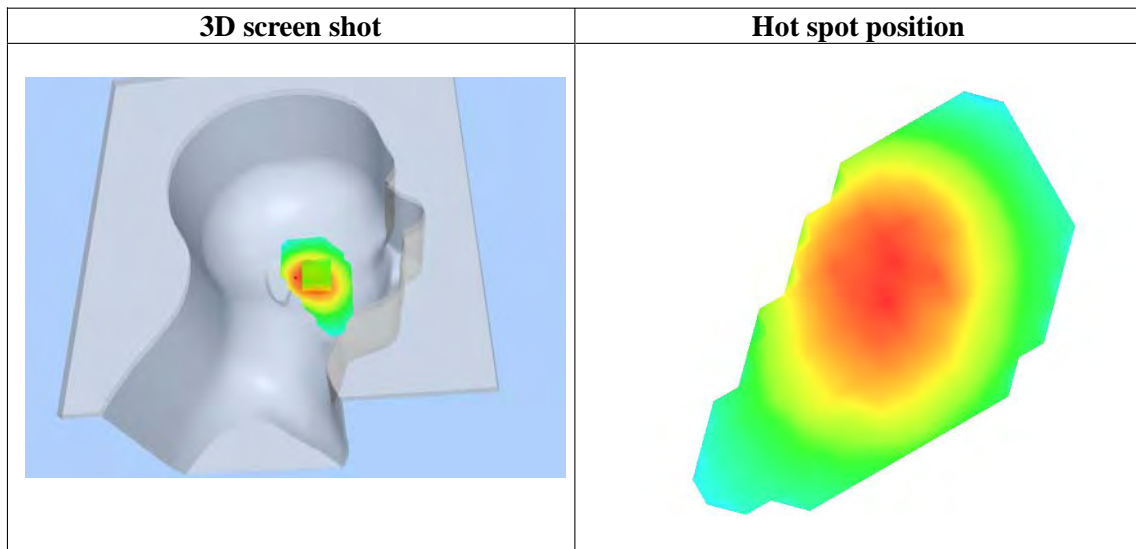
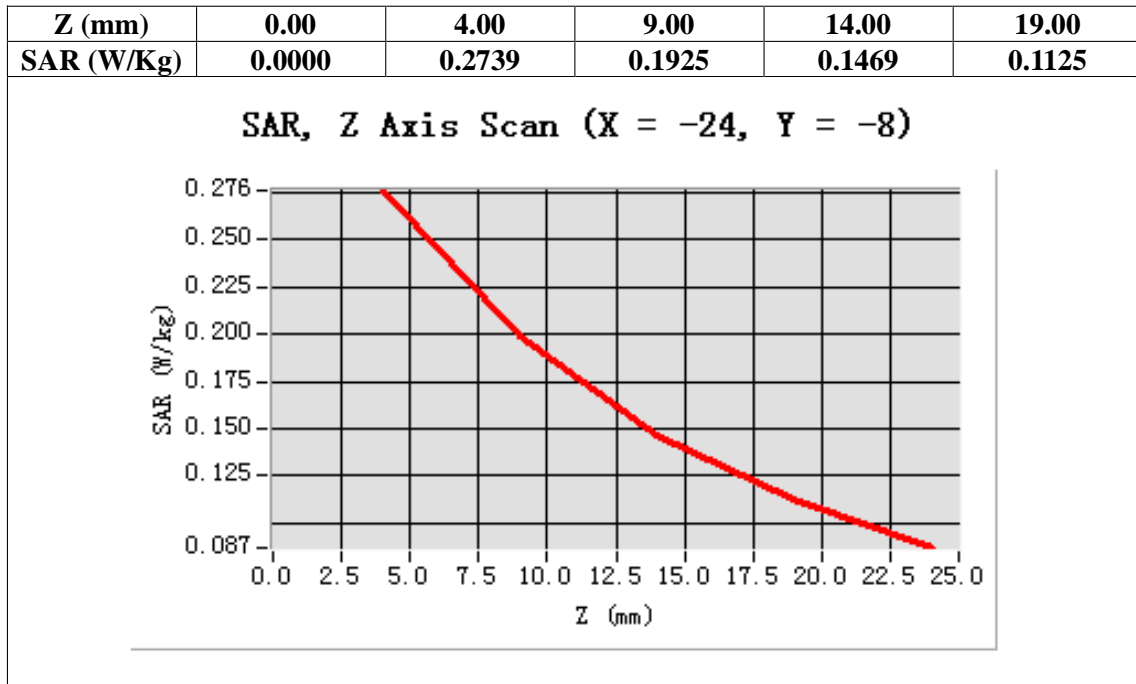

Test Laboratory: AGC Lab  
GSM 835 Mid-Touch-Left <SIM 2>  
DUT: Smart Phone; Type: Syreni 40DC

Date: Dec.12, 2013

Communication System: Generic GSM; Communication System Band: GSM 835; Duty Cycle: 1:8.3; Conv.F=5.30  
Frequency: 836.6 MHz; Medium parameters used:  $f = 835$  MHz;  $\sigma = 0.84$  mho/m;  $\epsilon_r = 40.26$ ;  $\rho = 1000$  kg/m<sup>3</sup> ;  
Phantom section: Left Section  
Ambient temperature (°C): 21.0, Liquid temperature (°C): 21.0

SATIMO Configuration:

Probe: EP165; Calibrated: 01/31/2013

- Sensor-Surface: 4mm (Mechanical Surface Detection)
- Phantom: Flat Phantom; Type: Elliptical Phantom
- Measurement SW: OpenSAR V4\_02\_01

Configuration/GSM 835 Mid-Touch-Left/Area Scan (6x8x1): Measurement grid: dx=8mm, dy=8mm  
Configuration/GSM 835 Mid-Touch-Left/Zoom Scan (5x5x7)/Cube 0: Measurement grid: dx=8mm, dy=8mm, dz=5mm

<b>Area Scan</b>	sam_direct_droit2_surf8mm.txt
<b>ZoomScan</b>	5x5x7,dx=8mm dy=8mm dz=5mm,Very fast
<b>Phantom</b>	Left head
<b>Device Position</b>	Cheek
<b>Band</b>	GSM 835
<b>Channels</b>	Middle
<b>Signal</b>	TDMA (Crest factor: 8.0)

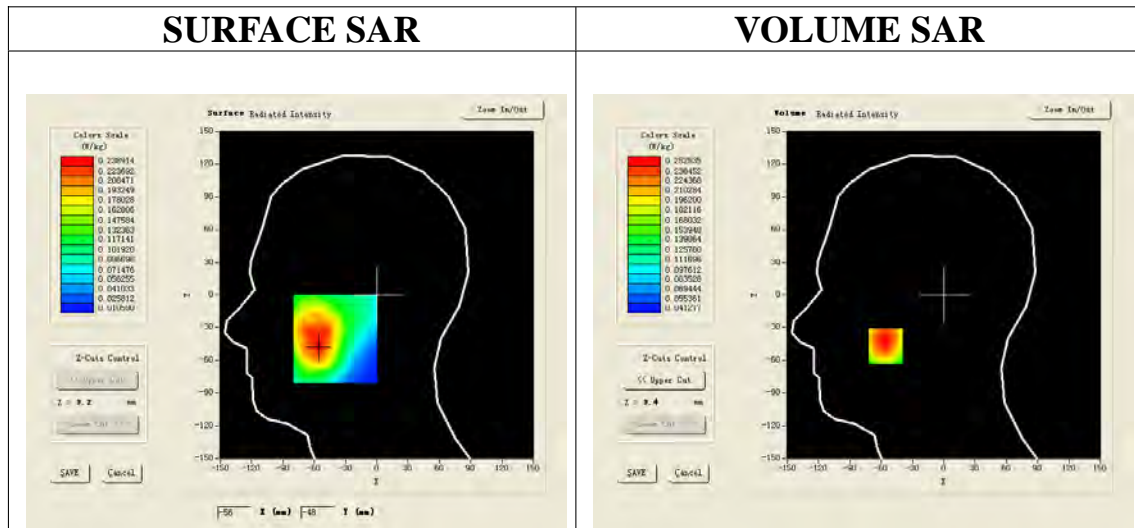

**Maximum location: X=-56.00, Y=-47.00**

<b>SAR 10g (W/Kg)</b>	0.179105
<b>SAR 1g (W/Kg)</b>	0.244409

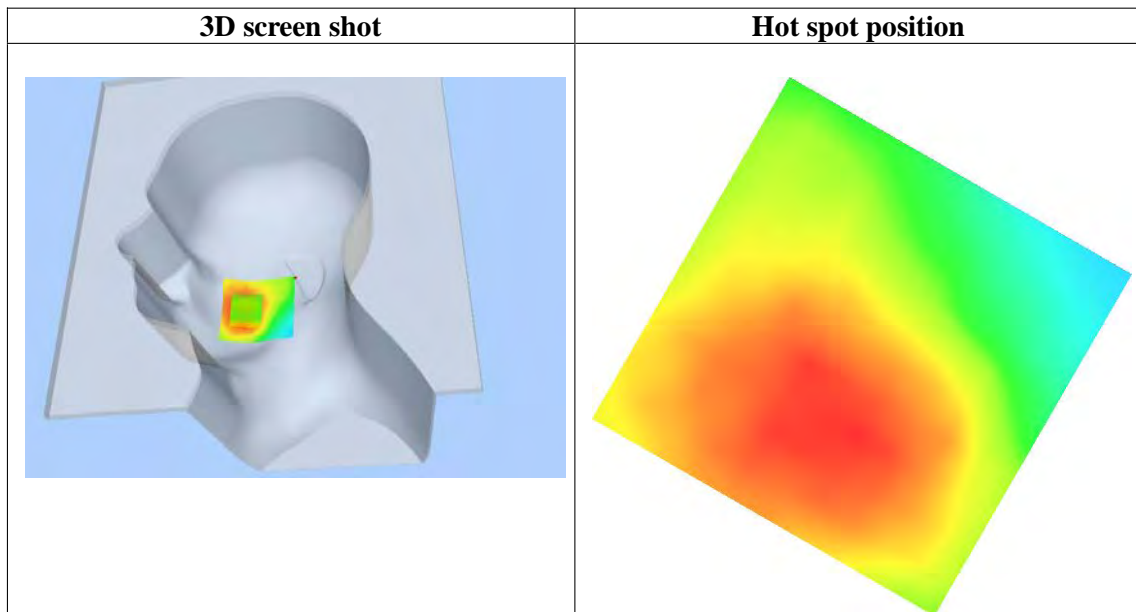
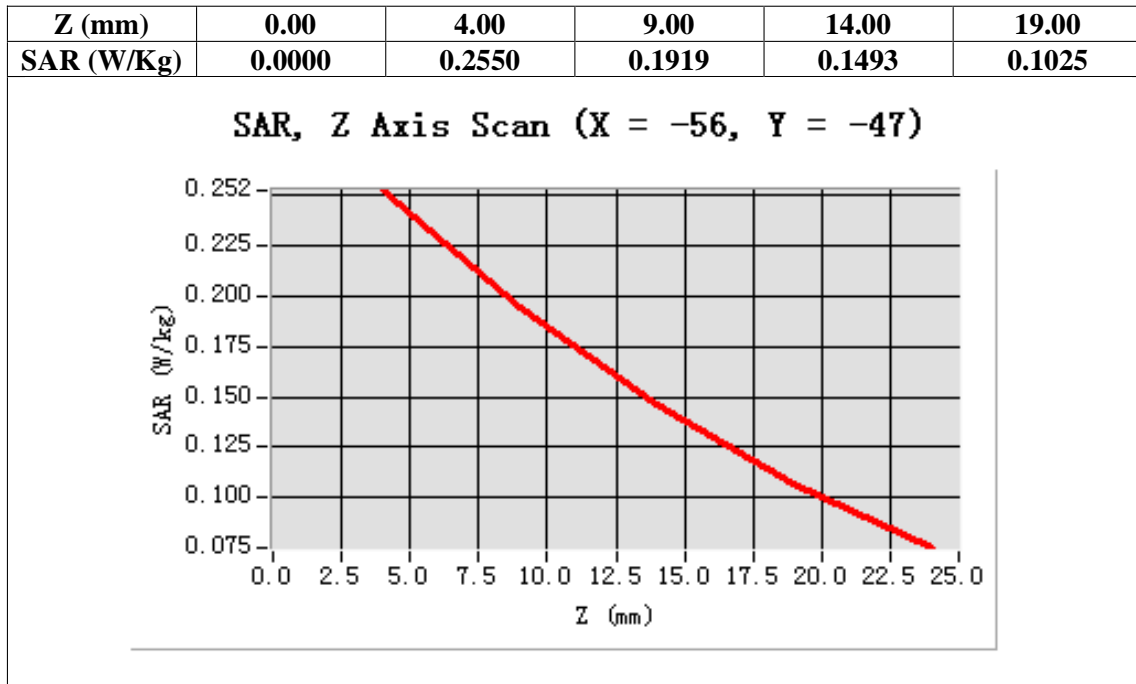



**Test Laboratory: AGC Lab**  
**GSM 835 Mid- Body- Back <SIM 1>**  
**DUT: Smart Phone; Type: Syreni 40DC**

**Date: Dec.12, 2013**

Communication System: Generic GSM; Communication System Band: GSM 835; Duty Cycle: 1:8.3; Conv.F=5.46;  
Frequency: 836.6 MHz; Medium parameters used:  $f = 835$  MHz;  $\sigma = 0.95$  mho/m;  $\epsilon_r = 53.26$ ;  $\rho = 1000$  kg/m<sup>3</sup> ;  
Phantom section: Flat Section  
Ambient temperature (°C): 21.0, Liquid temperature (°C): 21.0

SATIMO Configuration:

Probe: EP165; Calibrated: 01/31/2013

- Sensor-Surface: 4mm (Mechanical Surface Detection)
- Phantom: Flat Phantom; Type: Elliptical Phantom
- Measurement SW: OpenSAR V4\_02\_01

**Configuration/GSM 835 Mid-Body-Back/Area Scan (6x8x1): Measurement grid: dx=8mm, dy=8mm**  
**Configuration/GSM 835 Mid-Body-Back/Zoom Scan (5x5x7)/Cube 0: Measurement grid: dx=8mm, dy=8mm, dz=5mm;**

<b>Area Scan</b>	surf_sam_plan.txt
<b>ZoomScan</b>	5x5x7,dx=8mm dy=8mm dz=5mm,Very fast
<b>Phantom</b>	Validation plane
<b>Device Position</b>	Body Back
<b>Band</b>	GSM 835
<b>Channels</b>	Middle
<b>Signal</b>	TDMA (Crest factor: 8.0)

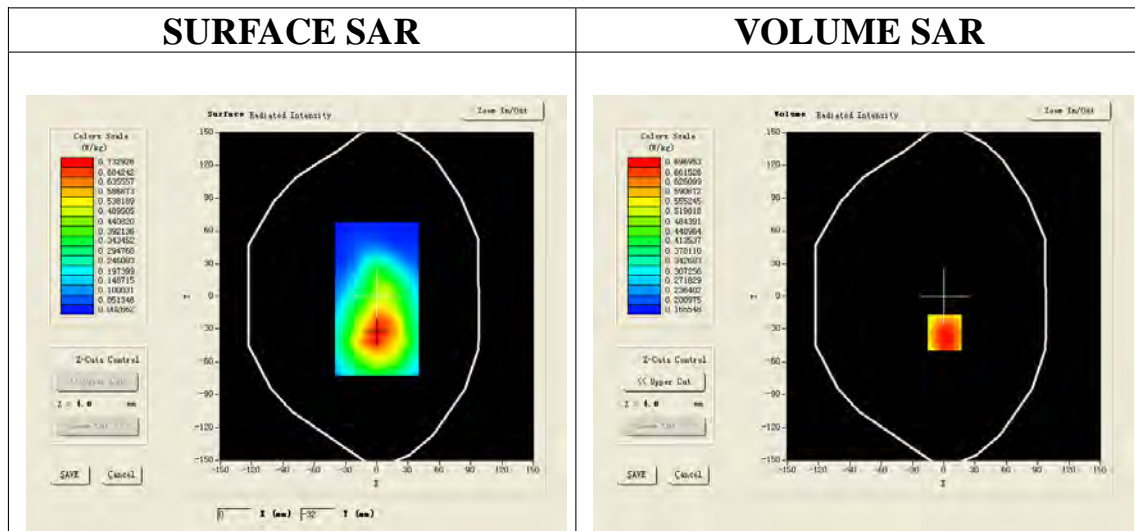

**Maximum location: X=1.00, Y=-33.00**

<b>SAR 10g (W/Kg)</b>	0.506017
<b>SAR 1g (W/Kg)</b>	0.682950



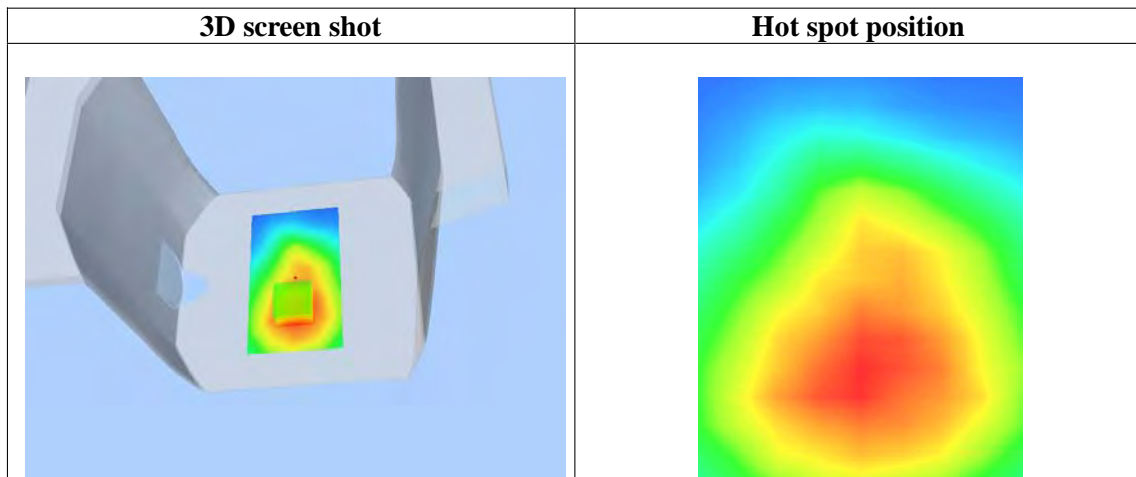
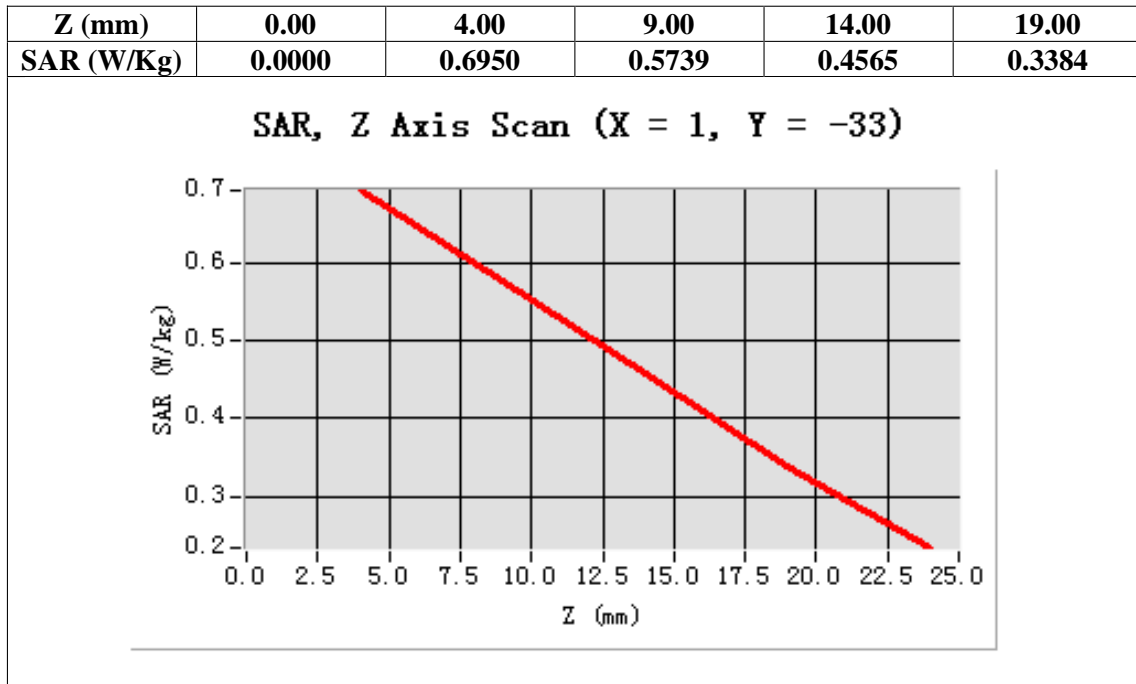

**Test Laboratory: AGC Lab**  
**GSM 835 Mid- Body- Front (MS) <SIM 1>**  
**DUT: Smart Phone; Type: Syreni 40DC**

**Date: Dec.12, 2013**

Communication System: Generic GSM; Communication System Band: GSM 835; Duty Cycle: 1:8.3; Conv.F=5.46;  
Frequency: 836.6 MHz; Medium parameters used:  $f = 835$  MHz;  $\sigma = 0.95$  mho/m;  $\epsilon_r = 53.26$ ;  $\rho = 1000$  kg/m<sup>3</sup> ;  
Phantom section: Flat Section  
Ambient temperature (°C): 21.0, Liquid temperature (°C): 21.0

**SATIMO Configuration:**

Probe: EP165; Calibrated: 01/31/2013

- Sensor-Surface: 4mm (Mechanical Surface Detection)
- Phantom: Flat Phantom; Type: Elliptical Phantom
- Measurement SW: OpenSAR V4\_02\_01

**Configuration/GSM 835 Mid-Body- Front /Area Scan (6x8x1): Measurement grid: dx=8mm, dy=8mm**  
**Configuration/GSM 835 Mid-Body- Front Zoom Scan (5x5x7)/Cube 0: Measurement grid: dx=8mm, dy=8mm, dz=5mm;**

<b>Area Scan</b>	surf_sam_plan.txt
<b>ZoomScan</b>	5x5x7,dx=8mm dy=8mm dz=5mm,Very fast
<b>Phantom</b>	Validation plane
<b>Device Position</b>	Body Front
<b>Band</b>	GSM 835
<b>Channels</b>	Middle
<b>Signal</b>	TDMA (Crest factor: 8.0)

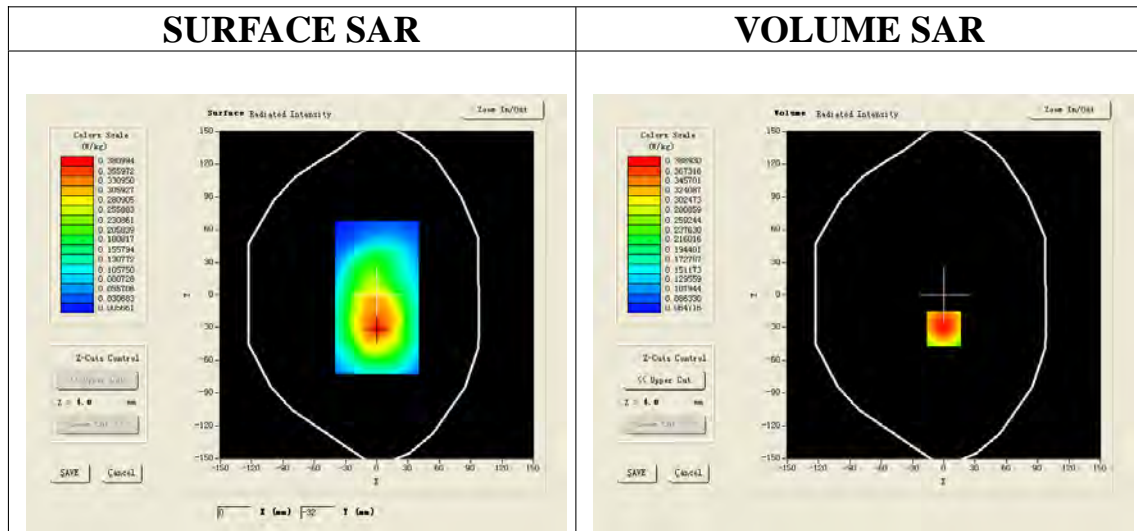

**Maximum location: X=0.00, Y=-31.00**

<b>SAR 10g (W/Kg)</b>	0.268250
<b>SAR 1g (W/Kg)</b>	0.373718

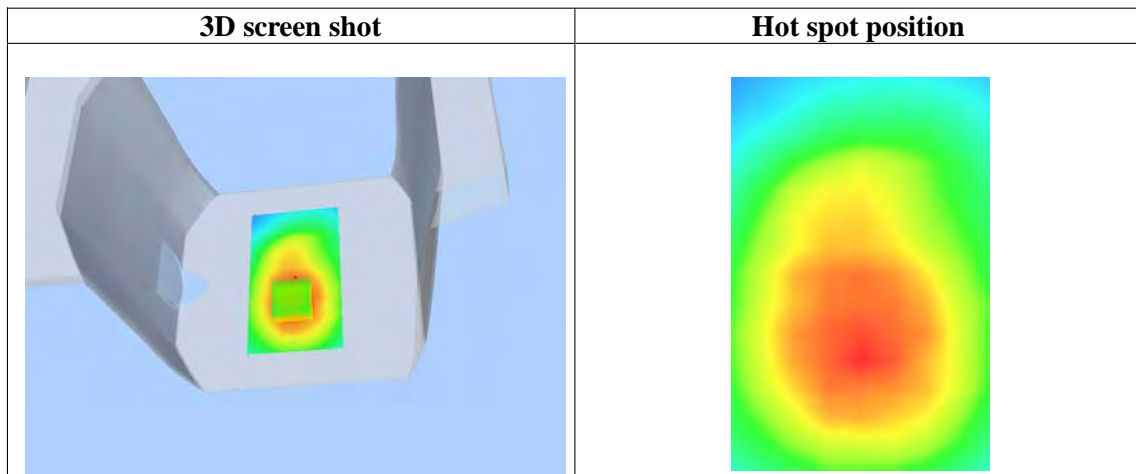
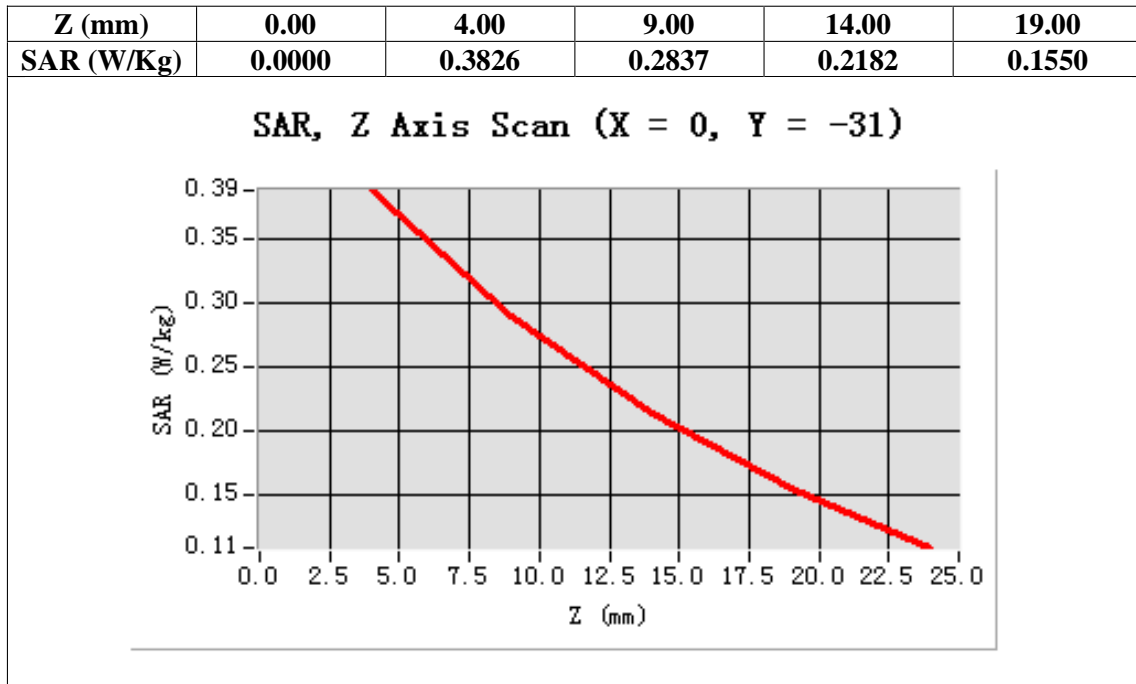

**Test Laboratory: AGC Lab**  
**PCS 1900 Mid-Touch-Left <SIM 1>**  
**DUT: Smart Phone; Type: Syreni 40DC**

**Date: Dec.12, 2013**

Communication System: Generic GSM; Communication System Band: PCS 1900; Duty Cycle: 1:8.3; Conv.F=4.72;  
Frequency: 1880 MHz; Medium parameters used:  $f = 1900$  MHz;  $\sigma = 1.36$  mho/m;  $\epsilon_r = 40.51$ ;  $\rho = 1000$  kg/m<sup>3</sup> ;  
Phantom section: Left Section  
Ambient temperature (°C): 21.0, Liquid temperature (°C): 21.0

SATIMO Configuration:

Probe: EP165; Calibrated: 01/31/2013

- Sensor-Surface: 4mm (Mechanical Surface Detection)
- Phantom: Flat Phantom; Type: Elliptical Phantom
- Measurement SW: OpenSAR V4\_02\_01

**Configuration/PCS1900 Mid-Touch-Left/Area Scan: Measurement grid: dx=8mm, dy=8mm**  
**Configuration/PCS1900 Mid-Touch-Left/Zoom Scan: Measurement grid: dx=8mm, dy=8mm, dz=5mm;**

<b>Area Scan</b>	sam_direct_droit2_surf8mm.txt
<b>ZoomScan</b>	5x5x7,dx=8mm dy=8mm dz=5mm,Very fast
<b>Phantom</b>	Left head
<b>Device Position</b>	Cheek
<b>Band</b>	PCS 1900
<b>Channels</b>	Middle
<b>Signal</b>	TDMA (Crest factor: 8.0)

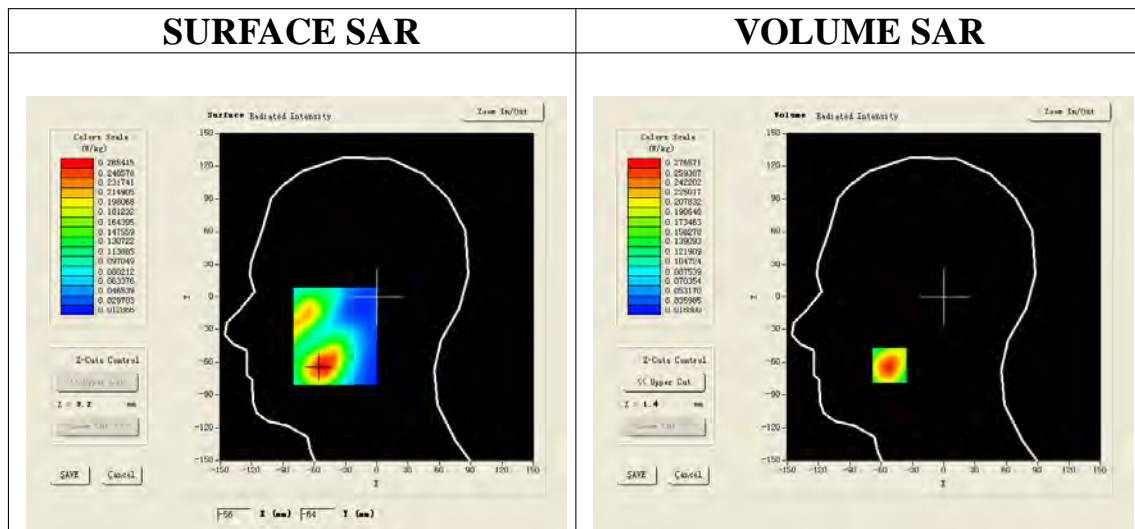

**Maximum location: X=-52.00, Y=-63.00**

<b>SAR 10g (W/Kg)</b>	0.154693
<b>SAR 1g (W/Kg)</b>	0.263528

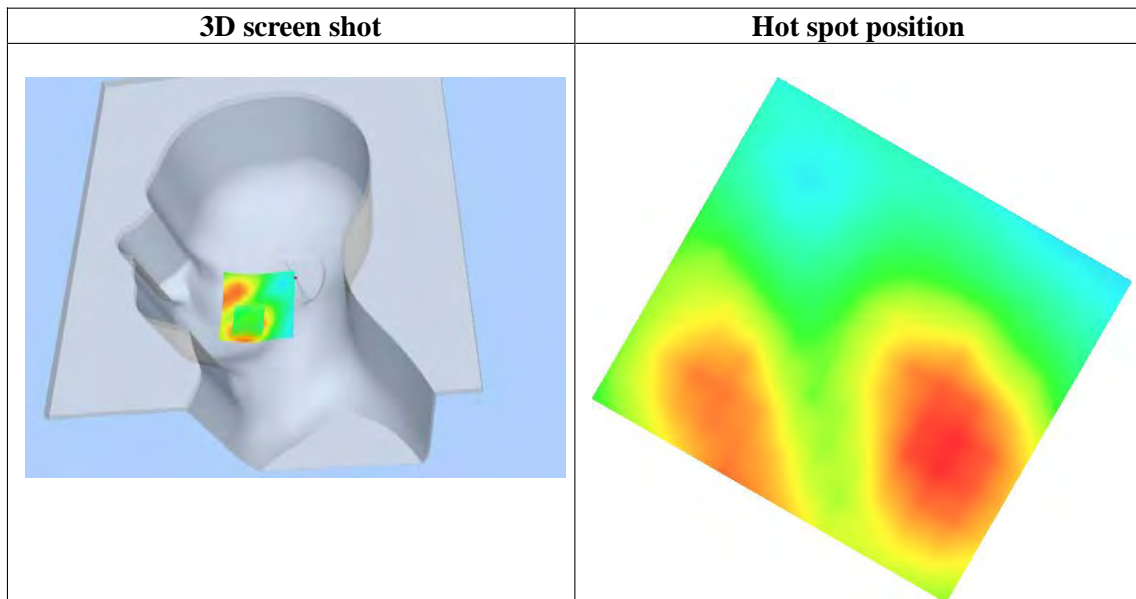
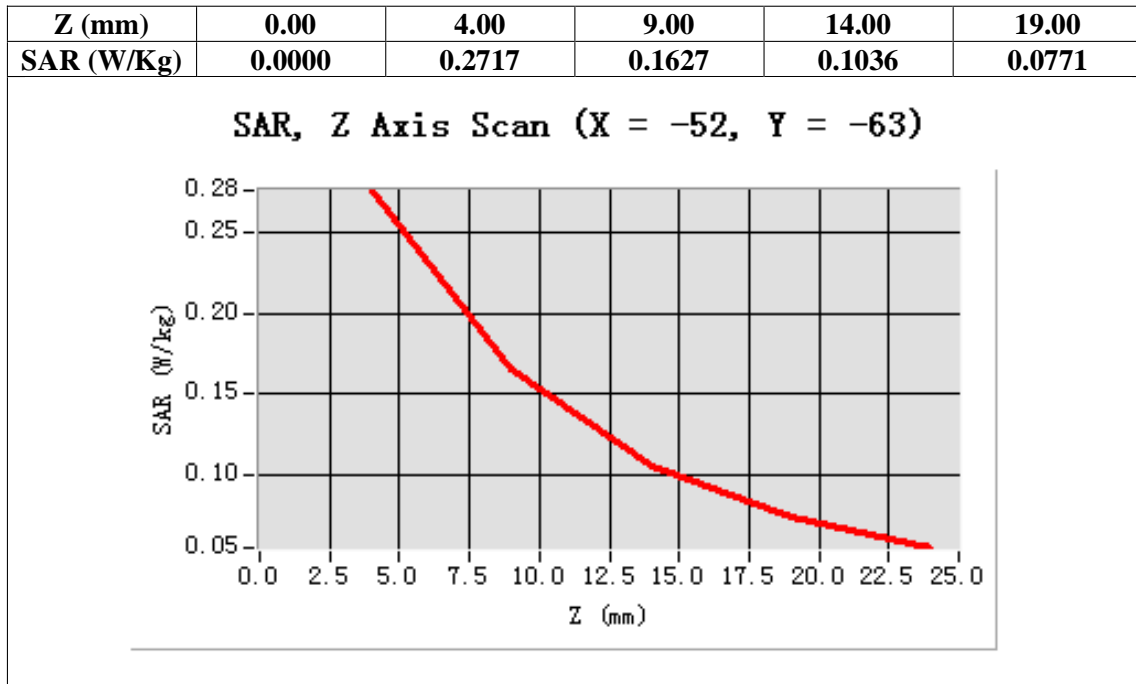

Test Laboratory: AGC Lab  
PCS 1900 Mid-Tilt-Left <SIM 1>  
DUT: Smart Phone; Type: Syreni 40DC

Date: Dec.12, 2013

Communication System: Generic GSM; Communication System Band: PCS 1900; Duty Cycle: 1:8.3; Conv.F=4.72;  
Frequency: 1880 MHz; Medium parameters used:  $f = 1900$  MHz;  $\sigma = 1.36$  mho/m;  $\epsilon_r = 40.51$ ;  $\rho = 1000$  kg/m<sup>3</sup> ;  
Phantom section: Left Section  
Ambient temperature (°C): 21.0, Liquid temperature (°C): 21.0

SATIMO Configuration:

Probe: EP165; Calibrated: 01/31/2013

- Sensor-Surface: 4mm (Mechanical Surface Detection)
- Phantom: Flat Phantom; Type: Elliptical Phantom
- Measurement SW: OpenSAR V4\_02\_01

Configuration/PCS1900 Mid-Tilt-Left/Area Scan: Measurement grid: dx=8mm, dy=8mm  
Configuration/PCS1900 Mid-Tilt-Left/Zoom Scan: Measurement grid: dx=8mm, dy=8mm,dz=5mm;

Area Scan	sam_direct_droit2_surf8mm.txt
ZoomScan	5x5x7,dx=8mm dy=8mm dz=5mm,Very fast
Phantom	Left head
Device Position	Tilt
Band	PCS 1900
Channels	Middle
Signal	TDMA (Crest factor: 8.0)

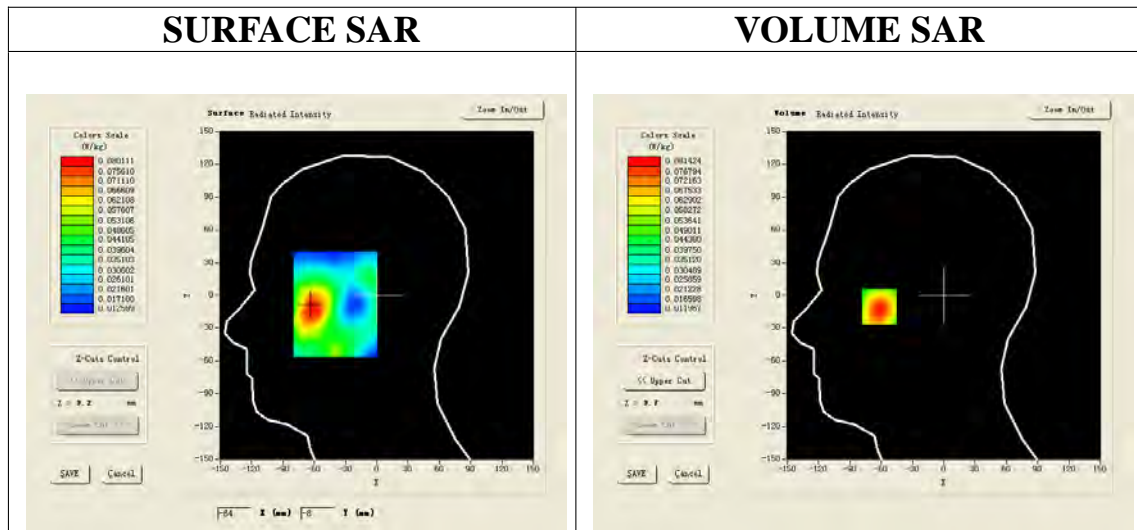

Maximum location: X=-62.00, Y=-9.00

SAR 10g (W/Kg)	0.053950
SAR 1g (W/Kg)	0.077631

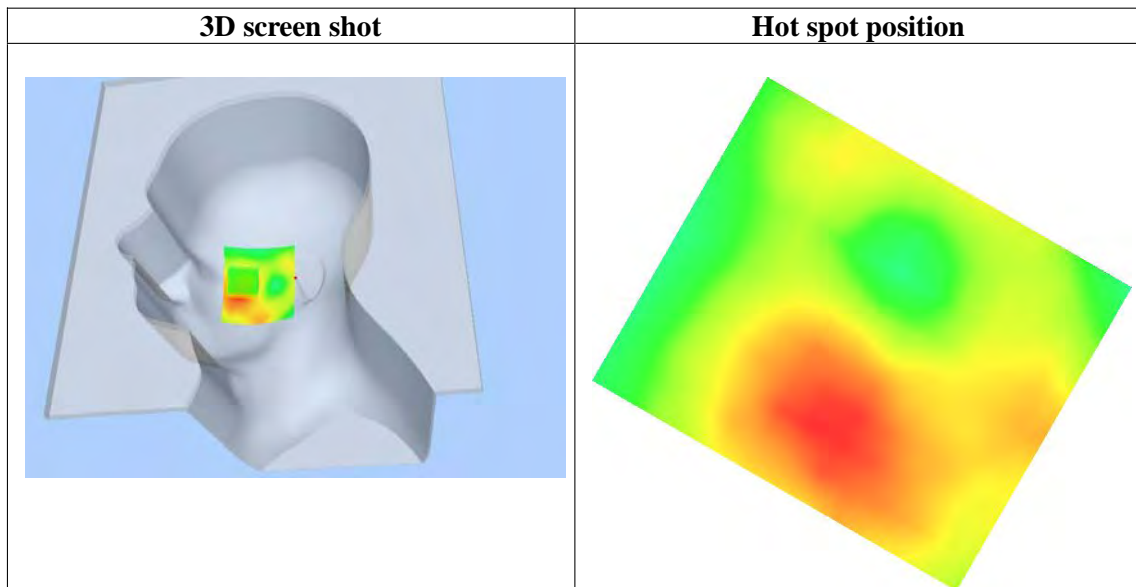
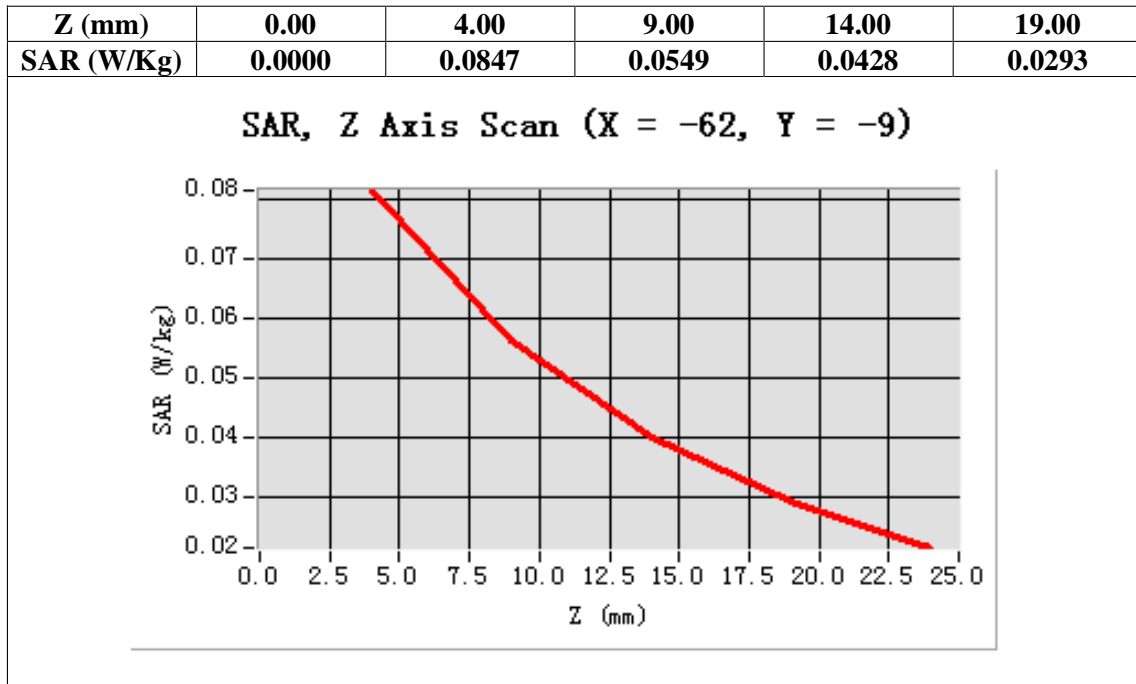



**Test Laboratory: AGC Lab**  
**PCS 1900 Mid-Touch-Right <SIM 1>**  
**DUT: Smart Phone; Type: Syreni 40DC**

**Date: Dec.12, 2013**

Communication System: Generic GSM; Communication System Band: PCS 1900; Duty Cycle: 1:8.3; Conv.F=4.72;  
Frequency: 1880 MHz; Medium parameters used:  $f = 1900$  MHz;  $\sigma = 1.36$  mho/m;  $\epsilon_r = 40.51$ ;  $\rho = 1000$  kg/m<sup>3</sup> ;  
Phantom section: Right Section  
Ambient temperature (°C): 21.0, Liquid temperature (°C): 21.0

SATIMO Configuration:

Probe: EP165; Calibrated: 01/31/2013

- Sensor-Surface: 4mm (Mechanical Surface Detection)
- Phantom: Flat Phantom; Type: Elliptical Phantom
- Measurement SW: OpenSAR V4\_02\_01

**Configuration/PCS1900 Mid-Touch-Right/Area Scan: Measurement grid: dx=8mm, dy=8mm**  
**Configuration/PCS1900 Mid-Touch-Right/Zoom Scan: Measurement grid: dx=8mm, dy=8mm, dz=5mm;**

<b>Area Scan</b>	sam_direct_droit2_surf8mm.txt
<b>ZoomScan</b>	5x5x7,dx=8mm dy=8mm dz=5mm,Very fast
<b>Phantom</b>	Right head
<b>Device Position</b>	Cheek
<b>Band</b>	PCS 1900
<b>Channels</b>	Middle
<b>Signal</b>	TDMA (Crest factor: 8.0)

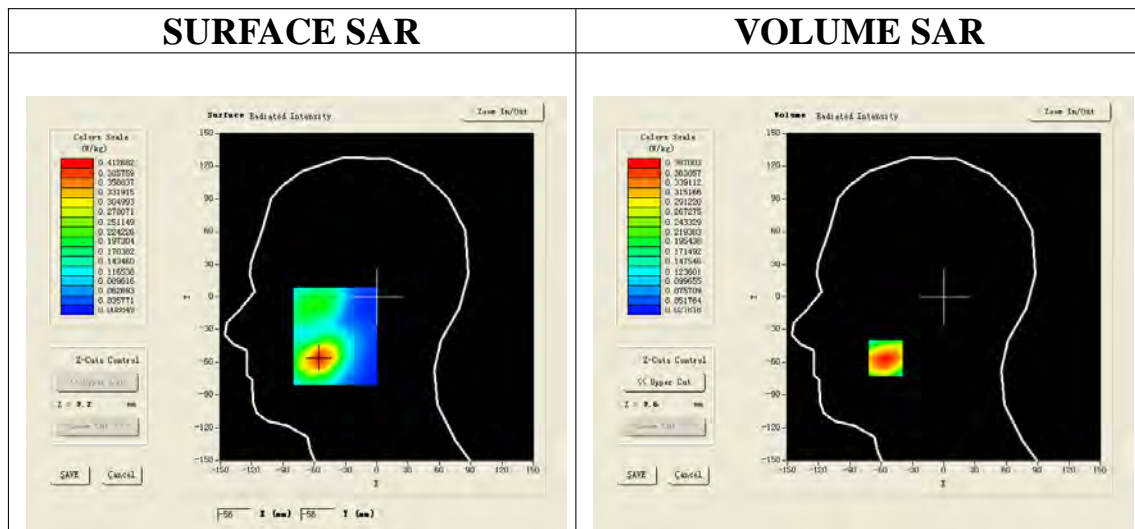

**Maximum location: X=-56.00, Y=-56.00**

<b>SAR 10g (W/Kg)</b>	0.234936
<b>SAR 1g (W/Kg)</b>	0.363582



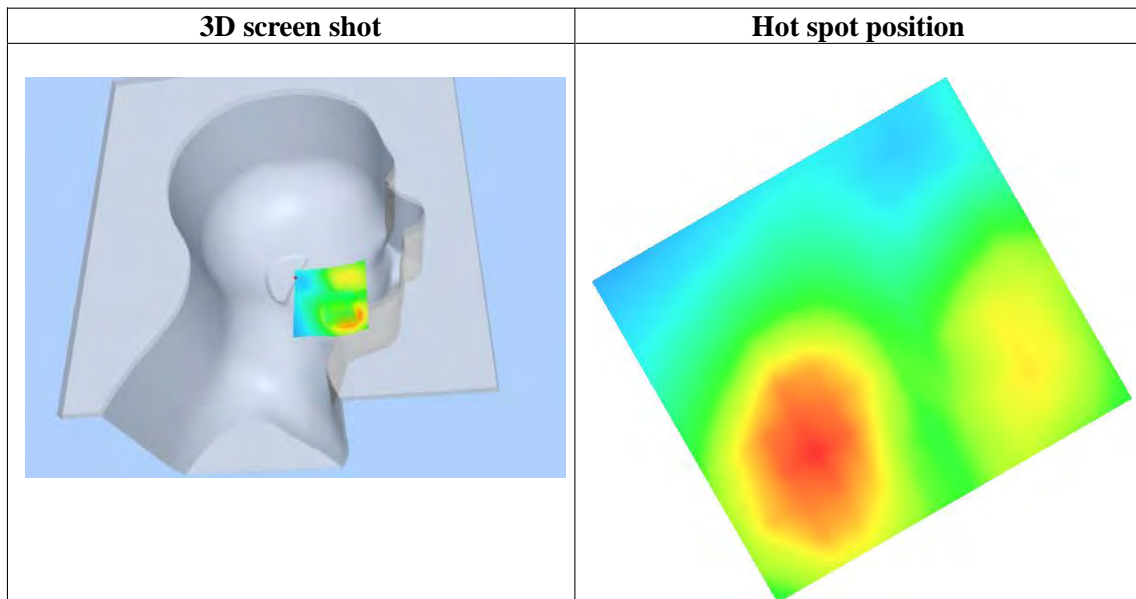
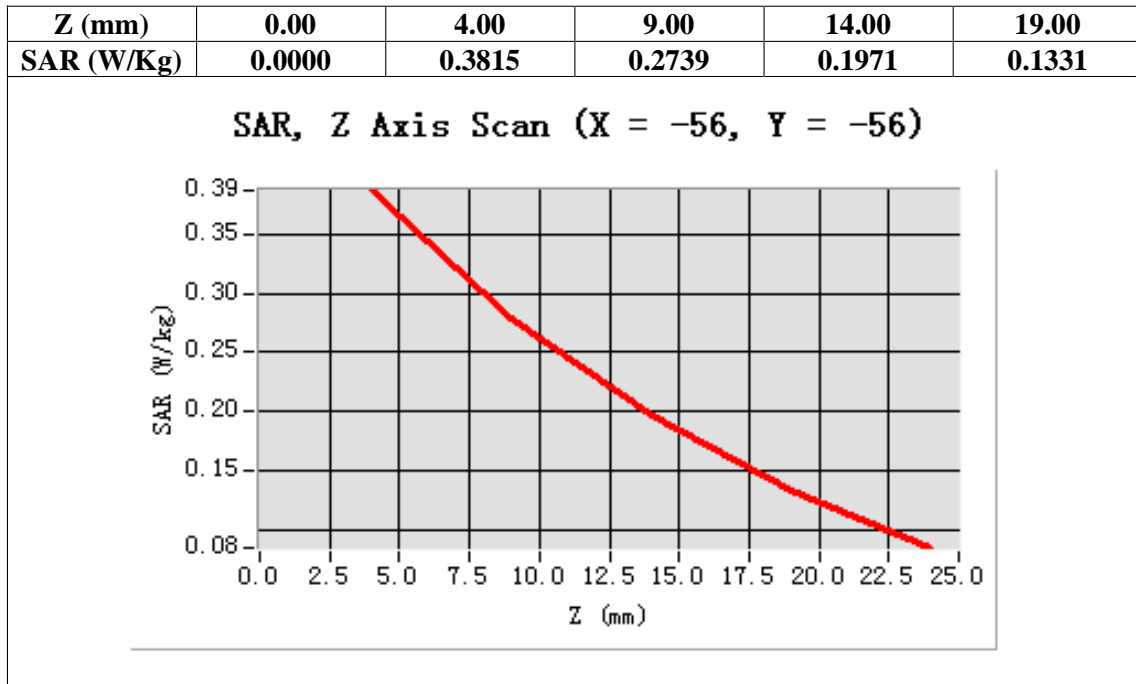

Test Laboratory: AGC Lab  
PCS 1900 Mid-Tilt-Right <SIM 1>  
DUT: Smart Phone; Type: Syreni 40DC

Date: Dec.12, 2013

Communication System: Generic GSM; Communication System Band: PCS 1900; Duty Cycle: 1:8.3; Conv.F=4.72;  
Frequency: 1880 MHz; Medium parameters used:  $f = 1900$  MHz;  $\sigma = 1.36$  mho/m;  $\epsilon_r = 40.51$ ;  $\rho = 1000$  kg/m<sup>3</sup> ;  
Phantom section: Right Section  
Ambient temperature (°C): 21.0, Liquid temperature (°C): 21.0

SATIMO Configuration:

Probe: EP165; Calibrated: 01/31/2013

- Sensor-Surface: 4mm (Mechanical Surface Detection)
- Phantom: Flat Phantom; Type: Elliptical Phantom
- Measurement SW: OpenSAR V4\_02\_01

Configuration/PCS1900 Mid-Tilt-Right/Area Scan: Measurement grid: dx=8mm, dy=8mm  
Configuration/PCS1900 Mid-Tilt-Right/Zoom Scan: Measurement grid: dx=8mm, dy=8mm, dz=5mm;

Area Scan	sam_direct_droit2_surf8mm.txt
ZoomScan	5x5x7,dx=8mm dy=8mm dz=5mm,Very fast
Phantom	Right head
Device Position	Tilt
Band	PCS 1900
Channels	Middle
Signal	TDMA (Crest factor: 8.0)

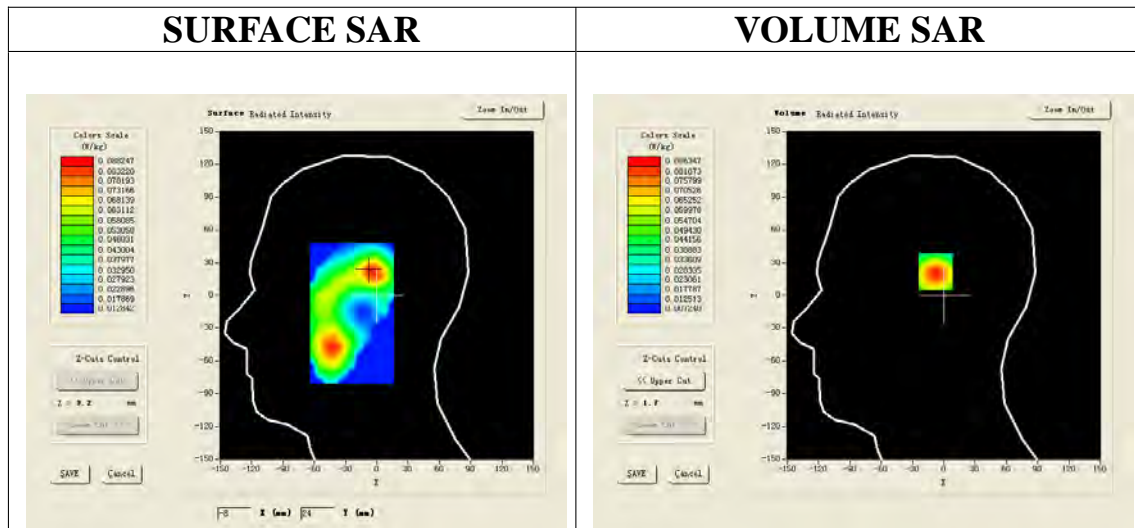

Maximum location: X=-6.00, Y=23.00

SAR 10g (W/Kg)	0.059365
SAR 1g (W/Kg)	0.087028

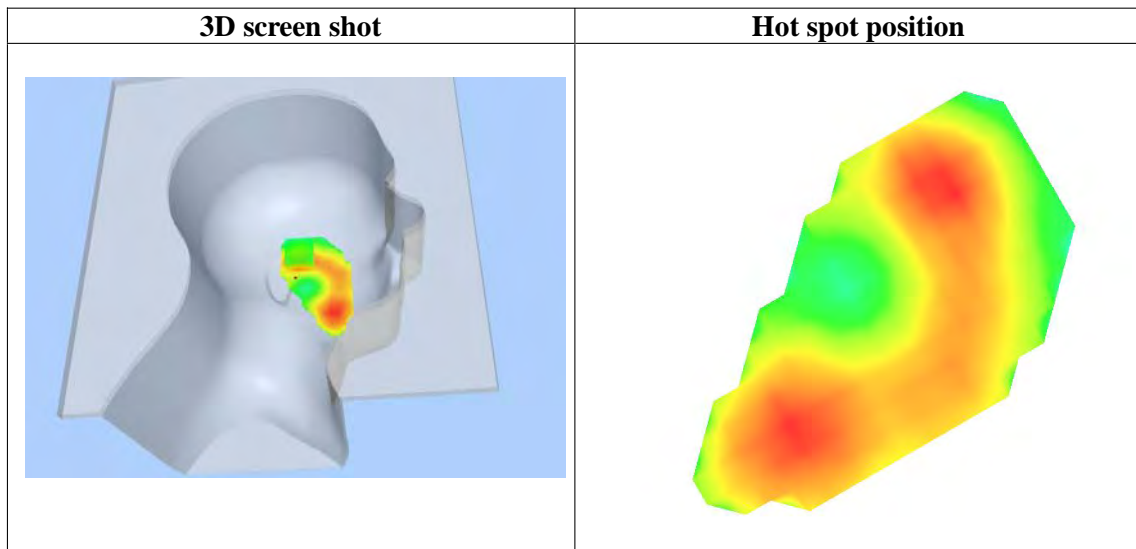
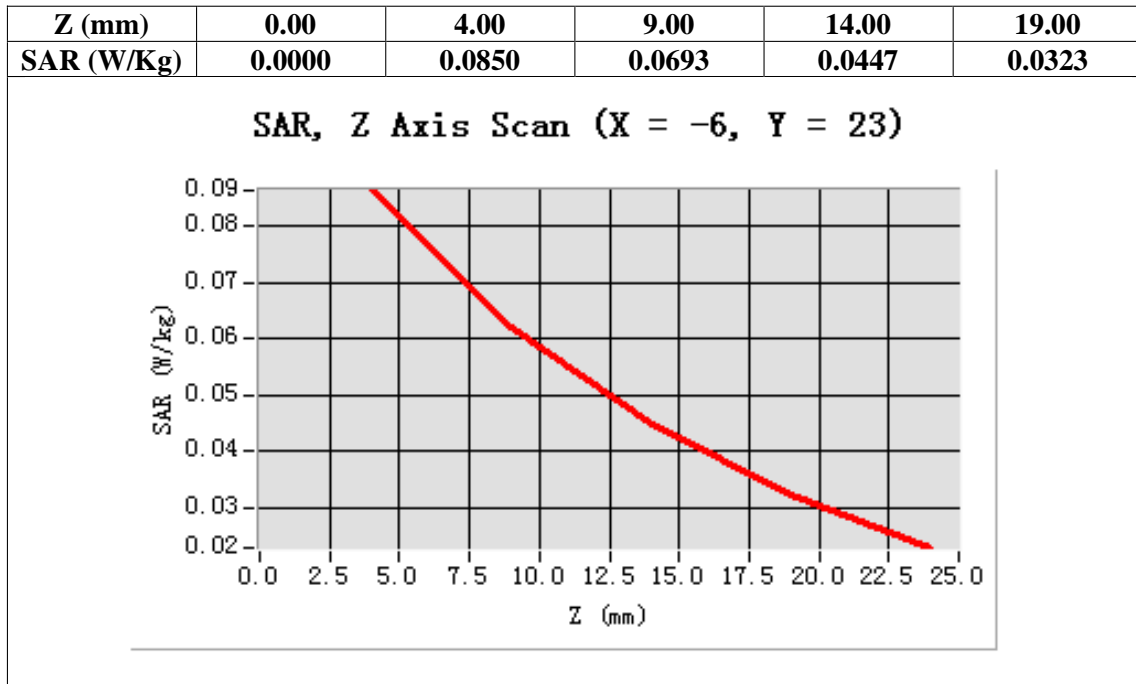

**Test Laboratory: AGC Lab**  
**PCS 1900 Mid-Touch-Right <SIM 2>**  
**DUT: Smart Phone; Type: Syreni 40DC**

**Date: Dec.12, 2013**

Communication System: Generic GSM; Communication System Band: PCS 1900; Duty Cycle: 1:8.3; Conv.F=4.72;  
Frequency: 1880 MHz; Medium parameters used:  $f = 1900$  MHz;  $\sigma = 1.36$  mho/m;  $\epsilon_r = 40.51$ ;  $\rho = 1000$  kg/m<sup>3</sup> ;  
Phantom section: Right Section  
Ambient temperature (°C): 21.0, Liquid temperature (°C): 21.0

SATIMO Configuration:

Probe: EP165; Calibrated: 01/31/2013

- Sensor-Surface: 4mm (Mechanical Surface Detection)
- Phantom: Flat Phantom; Type: Elliptical Phantom
- Measurement SW: OpenSAR V4\_02\_01

**Configuration/PCS1900 Mid-Touch-Right/Area Scan: Measurement grid: dx=8mm, dy=8mm**  
**Configuration/PCS1900 Mid-Touch-Right/Zoom Scan: Measurement grid: dx=8mm, dy=8mm, dz=5mm;**

<b>Area Scan</b>	sam_direct_droit2_surf8mm.txt
<b>ZoomScan</b>	5x5x7,dx=8mm dy=8mm dz=5mm,Very fast
<b>Phantom</b>	Right head
<b>Device Position</b>	Cheek
<b>Band</b>	PCS 1900
<b>Channels</b>	Middle
<b>Signal</b>	TDMA (Crest factor: 8.0)

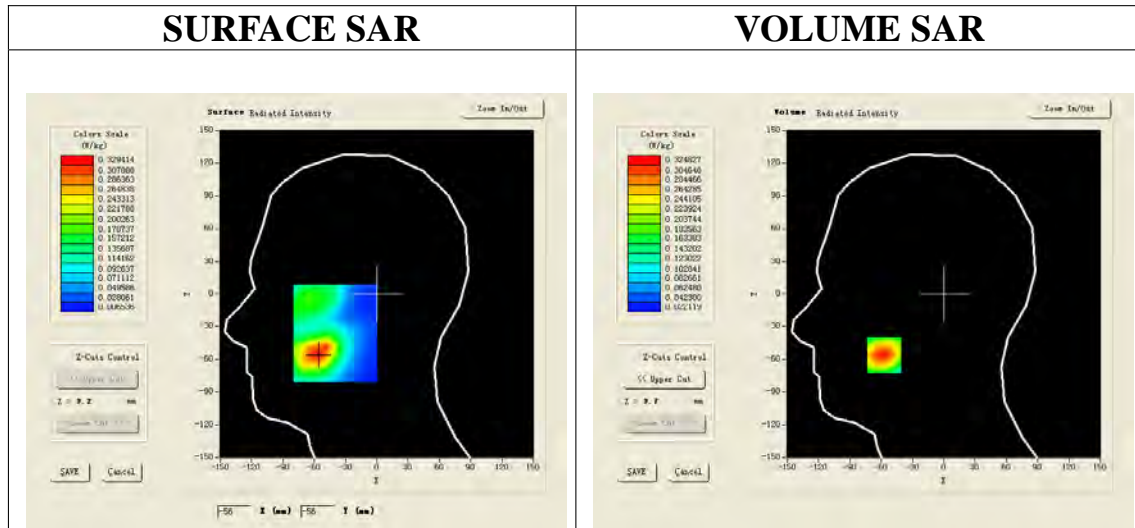

**Maximum location: X=-57.00, Y=-56.00**

<b>SAR 10g (W/Kg)</b>	0.186718
<b>SAR 1g (W/Kg)</b>	0.309364

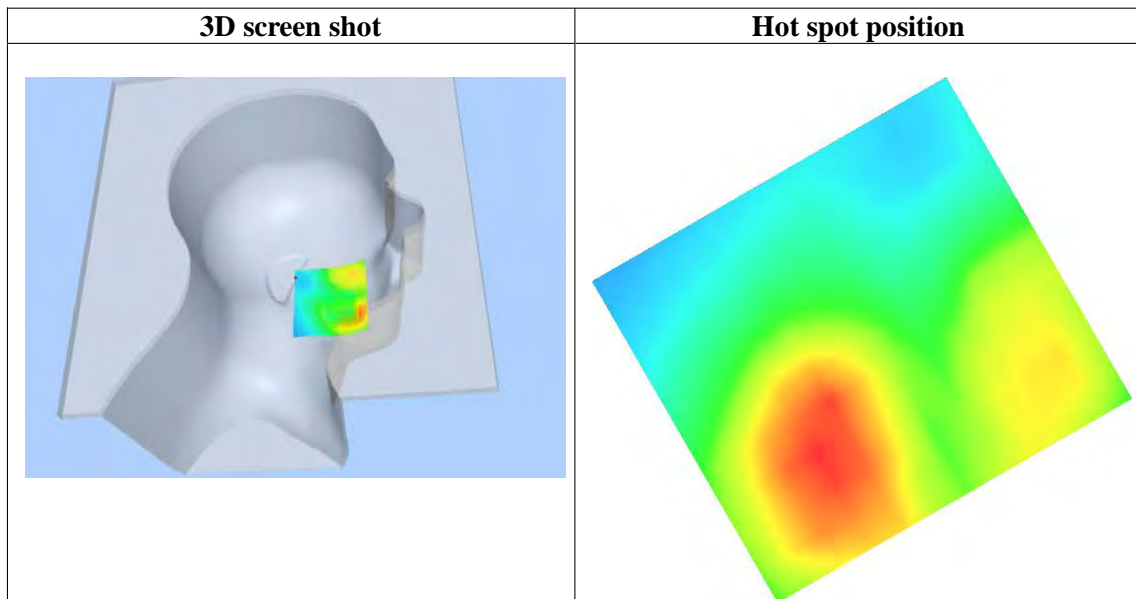
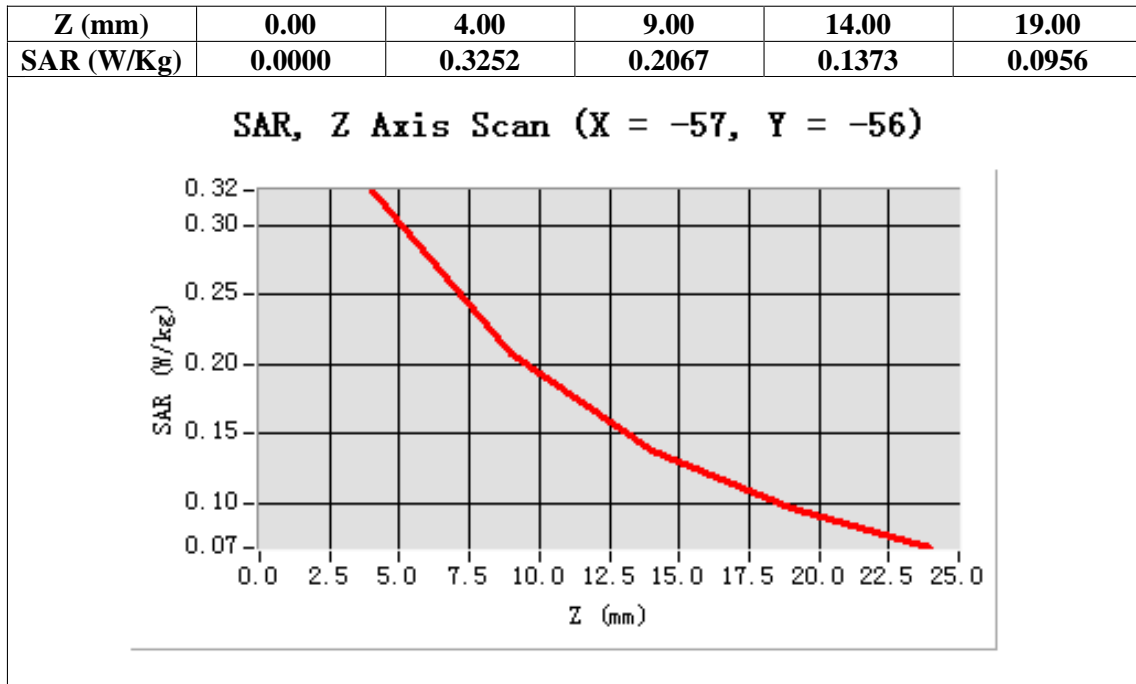

**Test Laboratory: AGC Lab**  
**PCS 1900 Mid-Body- Back <SIM 1>**  
**DUT: Smart Phone; Type: Syreni 40DC**

**Date: Dec.12, 2013**

Communication System: Generic GSM; Communication System Band: PCS 1900; Duty Cycle: 1:8.3; Conv.F=4.84;  
Frequency: 1880 MHz; Medium parameters used:  $f = 1900$  MHz;  $\sigma = 1.47$  mho/m;  $\epsilon_r = 54.62$ ;  $\rho = 1000$  kg/m<sup>3</sup> ;  
Phantom section: Flat Section  
Ambient temperature (°C): 21.0, Liquid temperature (°C): 21.0

**SATIMO Configuration:**

Probe: EP165; Calibrated: 01/31/2013

- Sensor-Surface: 4mm (Mechanical Surface Detection)
- Phantom: Flat Phantom; Type: Elliptical Phantom
- Measurement SW: OpenSAR V4\_02\_01

**Configuration/PCS1900 Mid-Body-Back/Area Scan: Measurement grid: dx=8mm, dy=8mm**  
**Configuration/PCS1900 Mid-Body-Back/Zoom Scan: Measurement grid: dx=8mm, dy=8mm, dz=5mm;**

<b>Area Scan</b>	surf_sam_plan.txt
<b>ZoomScan</b>	5x5x7,dx=8mm dy=8mm dz=5mm,Very fast
<b>Phantom</b>	Validation plane
<b>Device Position</b>	Body Back
<b>Band</b>	PCS 1900
<b>Channels</b>	Middle
<b>Signal</b>	TDMA (Crest factor: 8.0)

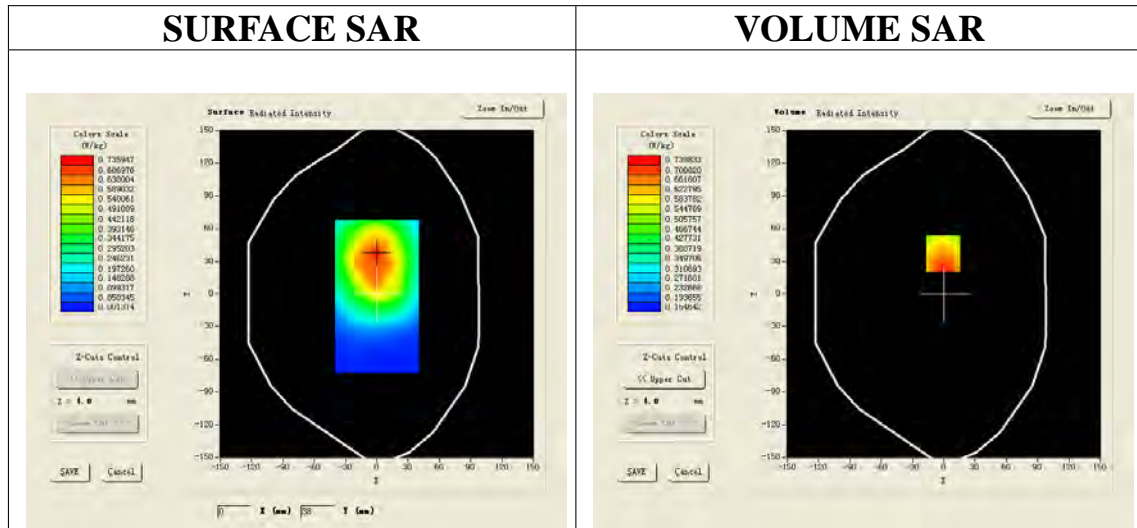

**Maximum location: X=-1.00, Y=37.00**

<b>SAR 10g (W/Kg)</b>	0.502892
<b>SAR 1g (W/Kg)</b>	0.688327

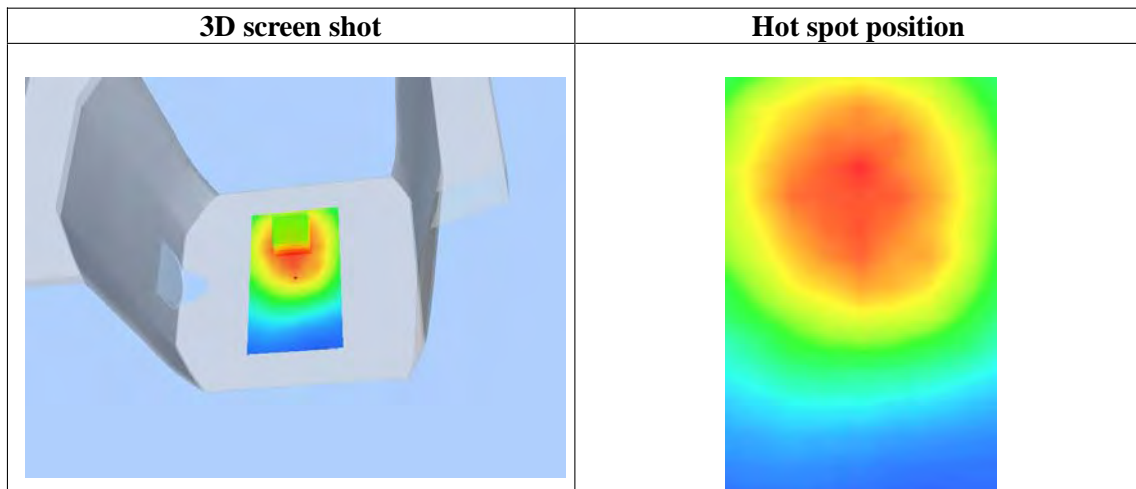
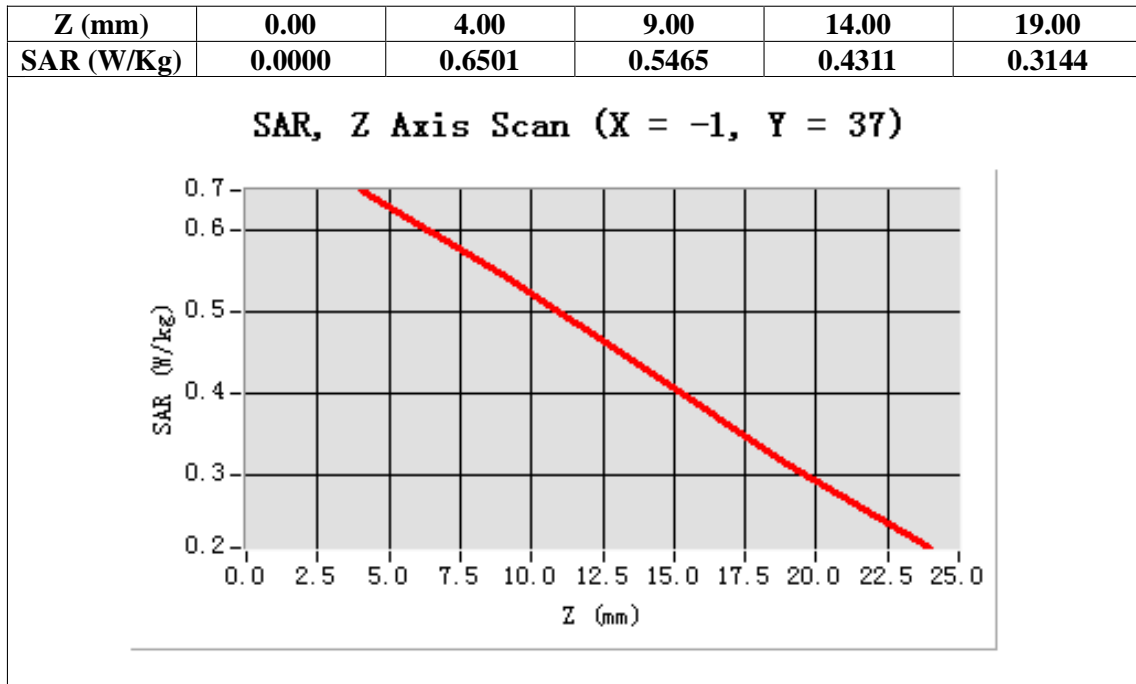



**Test Laboratory: AGC Lab**  
**PCS 1900 Mid-Body -Front (MS) <SIM 1>**  
**DUT: Smart Phone; Type: Syreni 40DC**

**Date: Dec.12, 2013**

Communication System: Generic GSM; Communication System Band: PCS 1900; Duty Cycle: 1:8.3; Conv.F=4.84;  
Frequency: 1880 MHz; Medium parameters used:  $f = 1900$  MHz;  $\sigma = 1.47$  mho/m;  $\epsilon_r = 54.62$ ;  $\rho = 1000$  kg/m<sup>3</sup> ;  
Phantom section: Flat Section  
Ambient temperature (°C): 21.0, Liquid temperature (°C): 21.0

SATIMO Configuration:

Probe: EP165; Calibrated: 01/31/2013

- Sensor-Surface: 4mm (Mechanical Surface Detection)
- Phantom: Flat Phantom; Type: Elliptical Phantom
- Measurement SW: OpenSAR V4\_02\_01

**Configuration/PCS1900 Mid-Body- Front /Area Scan: Measurement grid: dx=8mm, dy=8mm**  
**Configuration/PCS1900 Mid-Body- Front /Zoom Scan: Measurement grid: dx=8mm, dy=8mm, dz=5mm;**

<b>Area Scan</b>	surf_sam_plan.txt
<b>ZoomScan</b>	5x5x7,dx=8mm dy=8mm dz=5mm,Very fast
<b>Phantom</b>	Validation plane
<b>Device Position</b>	Body Front
<b>Band</b>	PCS 1900
<b>Channels</b>	Middle
<b>Signal</b>	TDMA (Crest factor: 8.0)

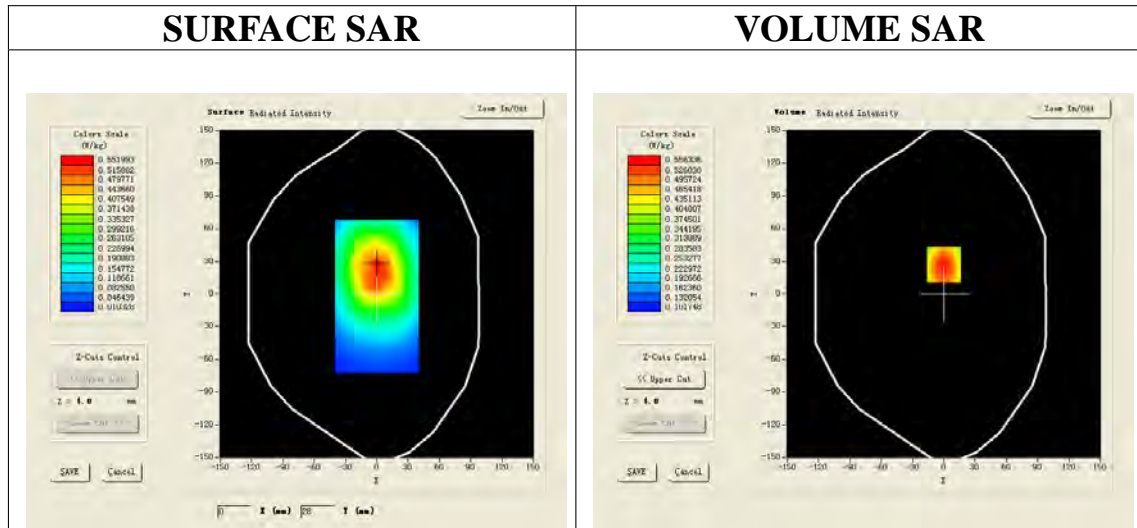

**Maximum location: X=0.00, Y=27.00**

<b>SAR 10g (W/Kg)</b>	0.367291
<b>SAR 1g (W/Kg)</b>	0.532464



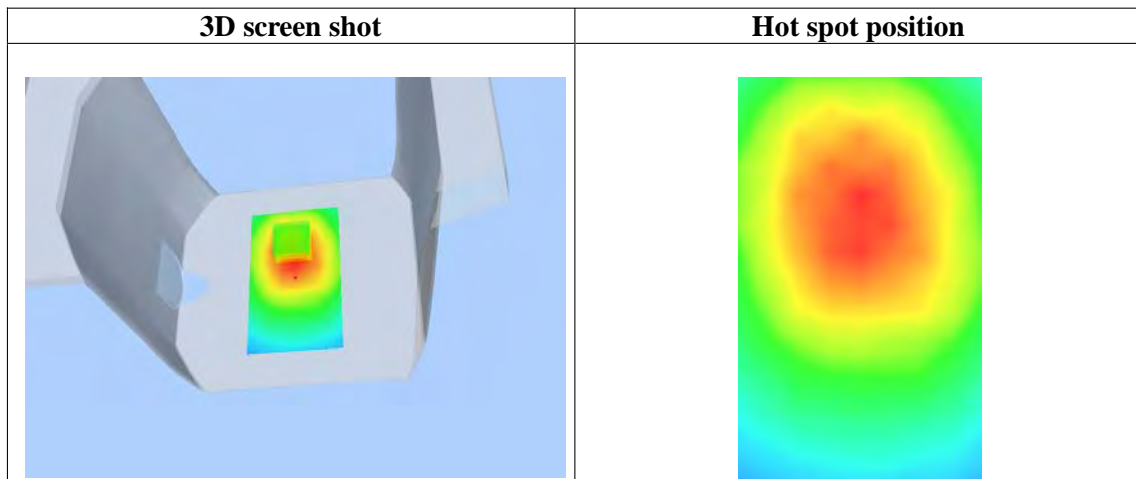
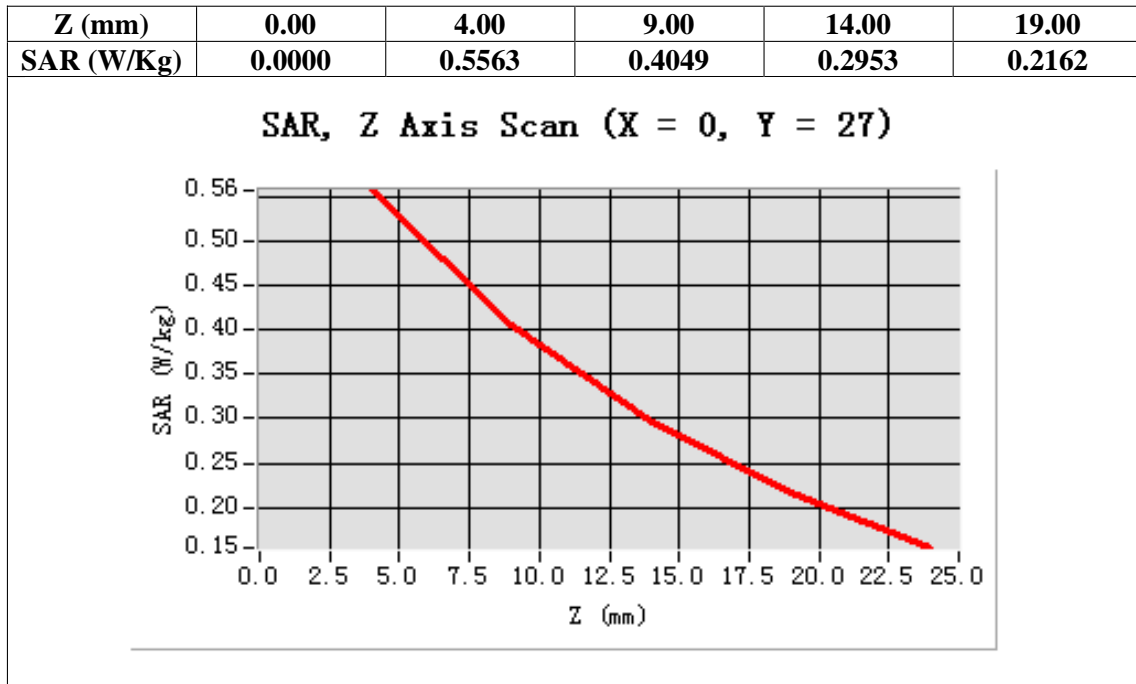

Test Laboratory: AGC Lab

Date: Dec.12, 2013

WCDMA Band V Mid-Touch-Left (RMC )

DUT: Smart Phone; Type: Syreni 40DC

Communication System: UMTS; Communication System Band: BAND V UTRA/FDD ; Duty Cycle:1: 1; Conv.F=5.30  
Frequency: 835 MHz; Medium parameters used: f = 835 MHz;  $\sigma=0.84$  mho/m;  $\epsilon_r=40.26$ ;  $\rho= 1000$  kg/m<sup>3</sup> ;  
Phantom section: Left Section  
Ambient temperature (°C): 21, Liquid temperature (°C): 21

SATIMO Configuration:

Probe: EP165; Calibrated: 01/31/2013

- Sensor-Surface: 4mm (Mechanical Surface Detection)
- Phantom: Flat Phantom; Type: Elliptical Phantom
- Measurement SW: OpenSAR V4\_02\_01

Configuration/ WCDMA Band V Mid-Touch-Left/Area Scan (6x8x1): Measurement grid: dx=8mm, dy=8mm  
Configuration/ WCDMA Band V Mid-Touch-Left/Zoom Scan (5x5x7)/Cube 0: Measurement grid: dx=8mm, dy=8mm, dz=5mm

Area Scan	sam_direct_droit2_surf8mm.txt
ZoomScan	5x5x7,dx=8mm dy=8mm dz=5mm,Very fast
Phantom	Left head
Device Position	Cheek
Band	WCDMA Band V
Channels	Middle
Signal	TDMA (Crest factor: 1.0)

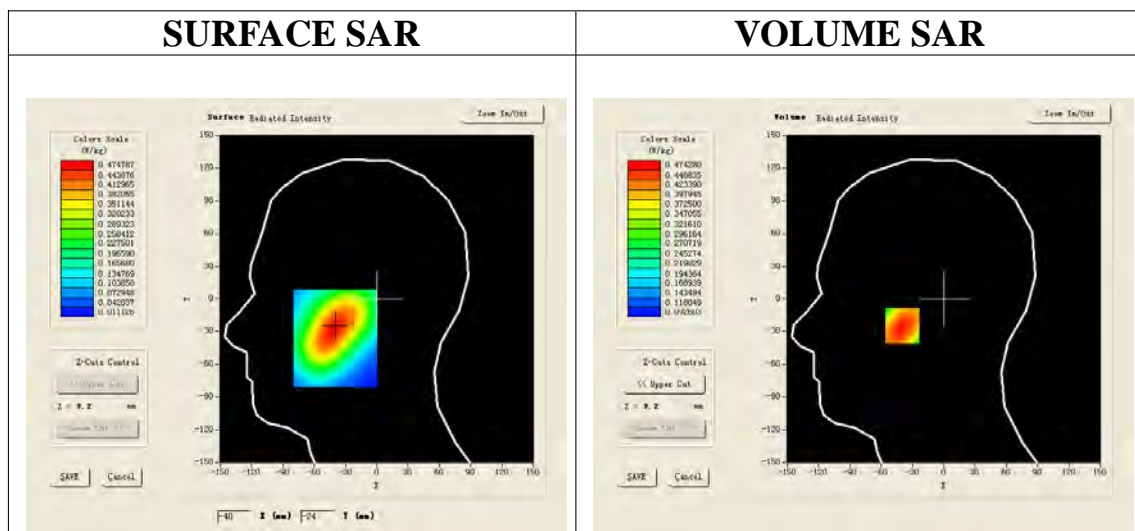

Maximum location: X=-40.00, Y=-25.00

SAR 10g (W/Kg)	0.337139
SAR 1g (W/Kg)	0.455081

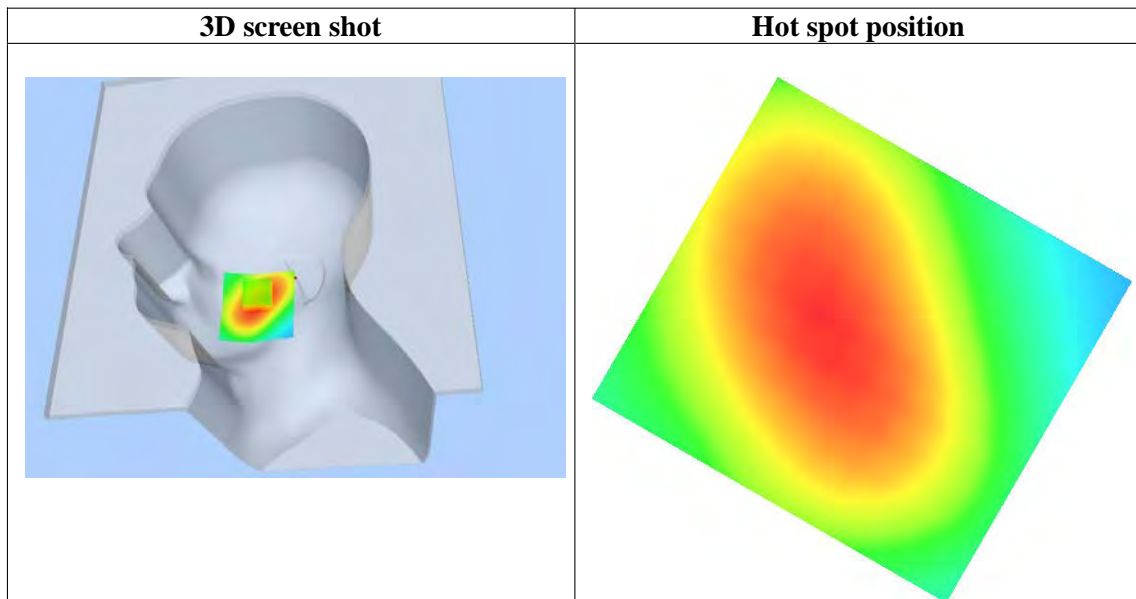
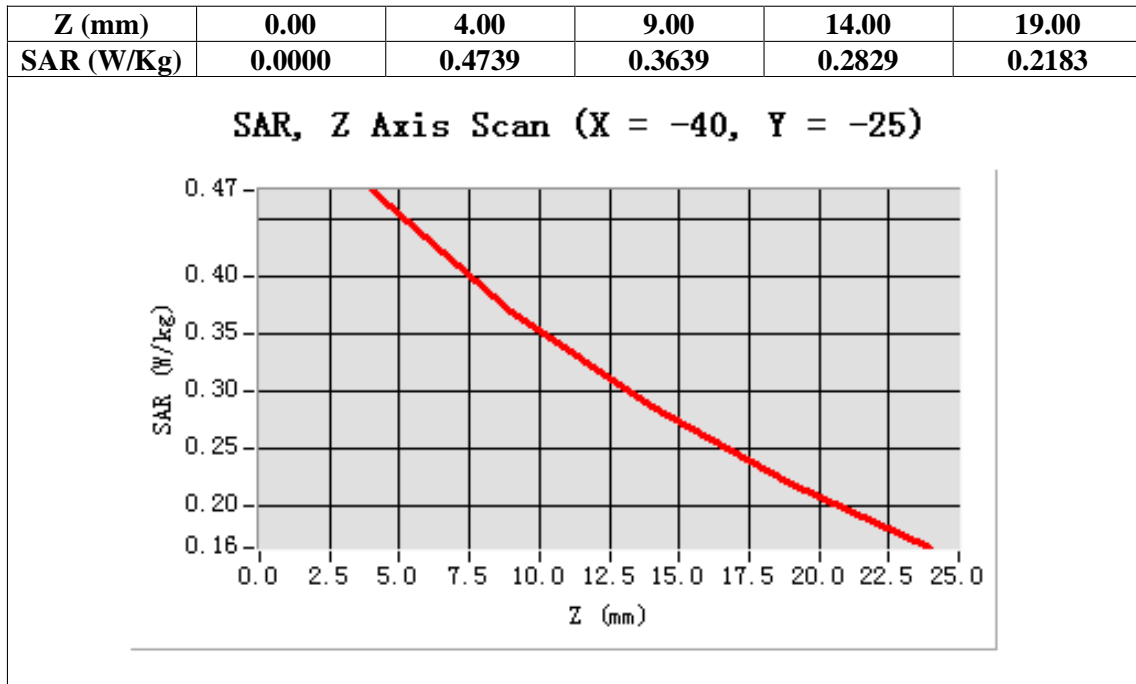

Test Laboratory: AGC Lab

Date: Dec.12, 2013

WCDMA Band V Mid-Tilt-Left (RMC)

DUT: Smart Phone; Type: Syreni 40DC

Communication System: UMTS; Communication System Band: BAND V UTRA/FDD ; Duty Cycle:1: 1; Conv.F=5.30  
Frequency: 835 MHz; Medium parameters used:  $f = 835$  MHz;  $\sigma=0.84$  mho/m;  $\epsilon_r =40.26$ ;  $\rho= 1000$  kg/m<sup>3</sup> ;  
Phantom section: Left Section  
Ambient temperature (°C): 21, Liquid temperature (°C): 21

SATIMO Configuration:

Probe: EP165; Calibrated: 01/31/2013

- Sensor-Surface: 4mm (Mechanical Surface Detection)
- Phantom: Flat Phantom; Type: Elliptical Phantom
- Measurement SW: OpenSAR V4\_02\_01

Configuration/ WCDMA Band V Mid-Tilt-Left/Area Scan (6x8x1): Measurement grid: dx=8mm, dy=8mm  
Configuration/ WCDMA Band V Mid-Tilt-Left/Zoom Scan (5x5x7)/Cube 0: Measurement grid: dx=8mm, dy=8mm, dz=5mm;

Area Scan	sam_direct_droit2_surf8mm.txt
ZoomScan	5x5x7,dx=8mm dy=8mm dz=5mm,Very fast
Phantom	Left head
Device Position	Tilt
Band	WCDMA Band V
Channels	Middle
Signal	TDMA (Crest factor: 1.0)

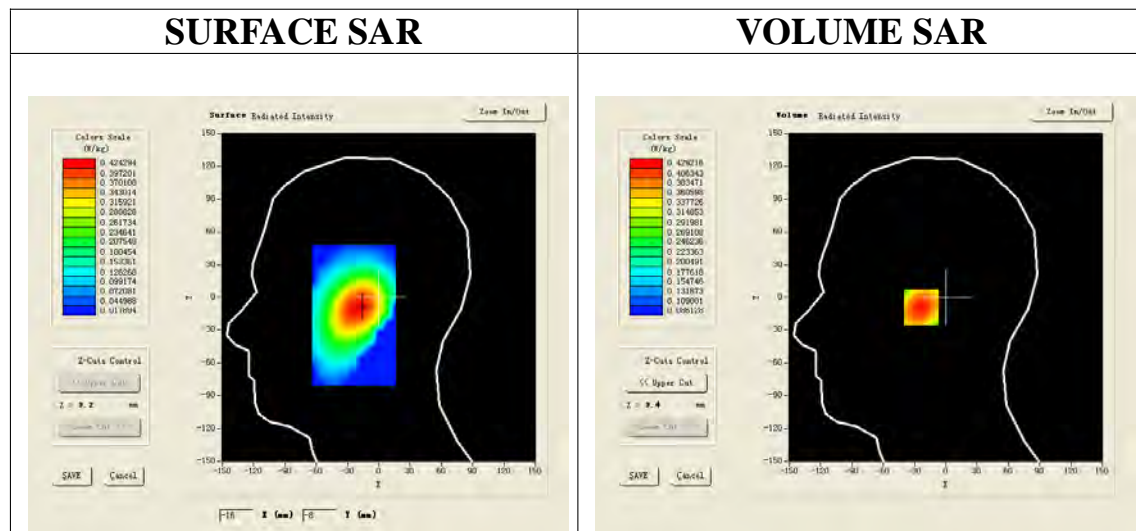

**Maximum location: X=-20.00, Y=-9.00**

SAR 10g (W/Kg)	0.291852
SAR 1g (W/Kg)	0.419153

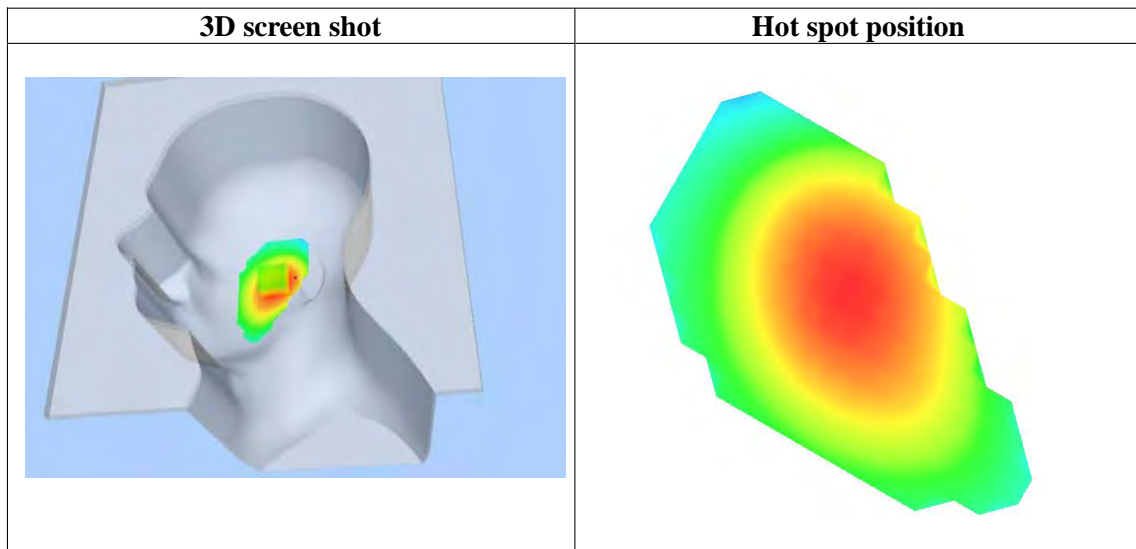
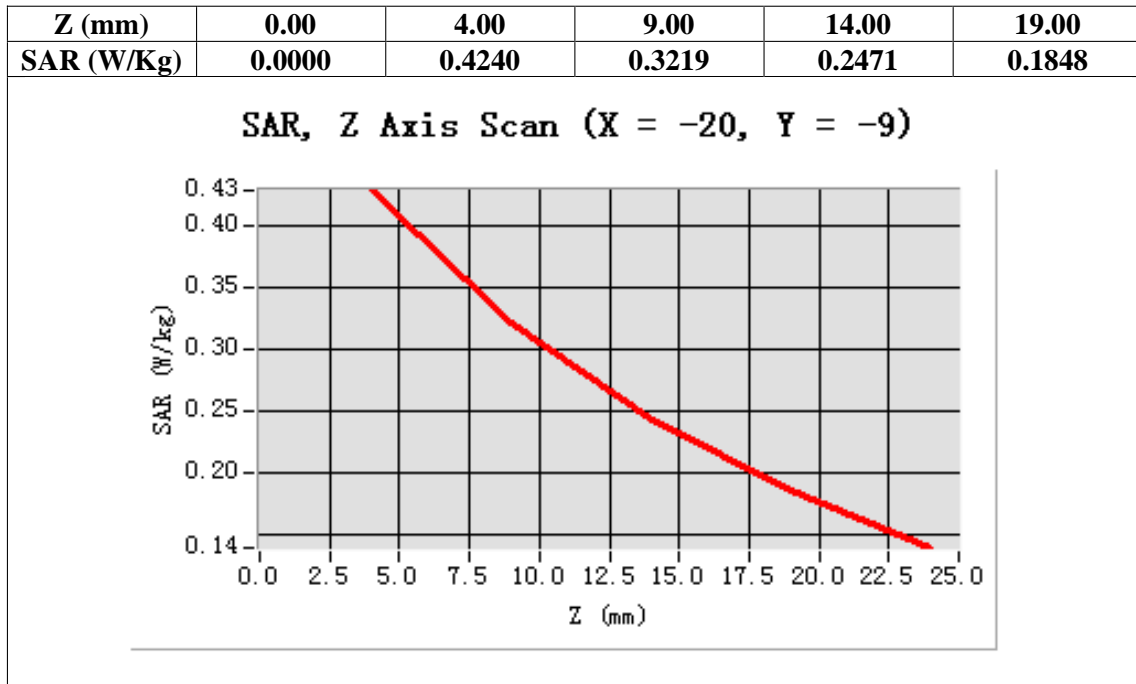

Test Laboratory: AGC Lab

Date: Dec.12, 2013

WCDMA Band V Mid-Touch-Right (RMC)

DUT: Smart Phone; Type: Syreni 40DC

Communication System: UMTS; Communication System Band: BAND V UTRA/FDD ; Duty Cycle:1: 1; Conv.F=5.30  
Frequency: 835 MHz; Medium parameters used: f = 835 MHz;  $\sigma=0.84$  mho/m;  $\epsilon_r=40.26$ ;  $\rho=1000$  kg/m<sup>3</sup> ;  
Phantom section: Right Section  
Ambient temperature (°C): 21, Liquid temperature (°C): 21

SATIMO Configuration:

Probe: EP165; Calibrated: 01/31/2013

- Sensor-Surface: 4mm (Mechanical Surface Detection)
- Phantom: Flat Phantom; Type: Elliptical Phantom
- Measurement SW: OpenSAR V4\_02\_01

Configuration/ WCDMA Band V Mid-Touch-Right/Area Scan: Measurement grid: dx=8mm, dy=8mm

Configuration/ WCDMA Band V Mid-Touch-Right/Zoom Scan: Measurement grid: dx=8mm, dy=8mm, dz=5mm;

Area Scan	sam_direct_droit2_surf8mm.txt
ZoomScan	5x5x7,dx=8mm dy=8mm dz=5mm,Very fast
Phantom	Right head
Device Position	Cheek
Band	WCDMA Band V
Channels	Middle
Signal	TDMA (Crest factor: 1.0)

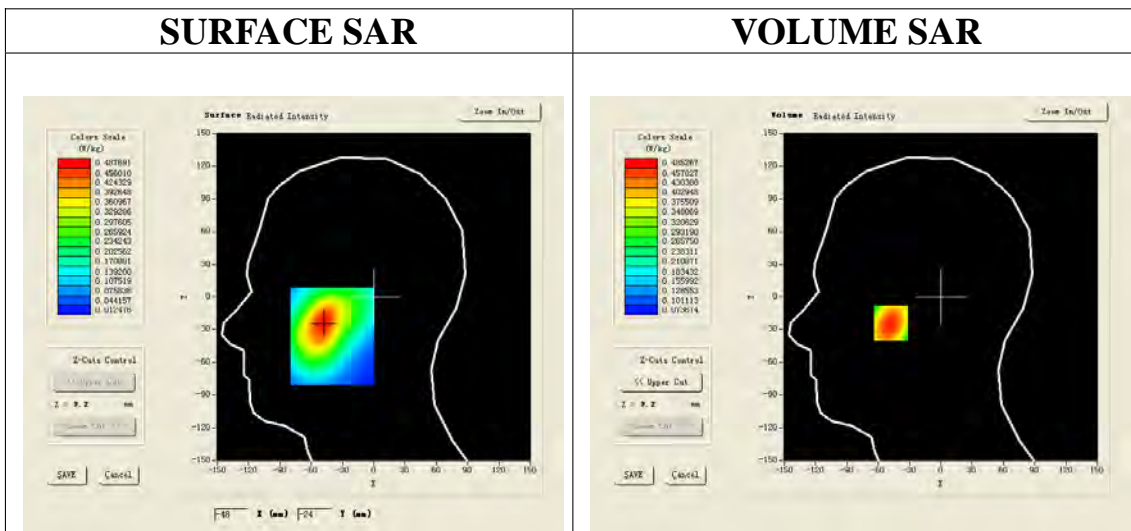

Maximum location: X=-48.00, Y=-24.00

SAR 10g (W/Kg)	0.329376
SAR 1g (W/Kg)	0.464097

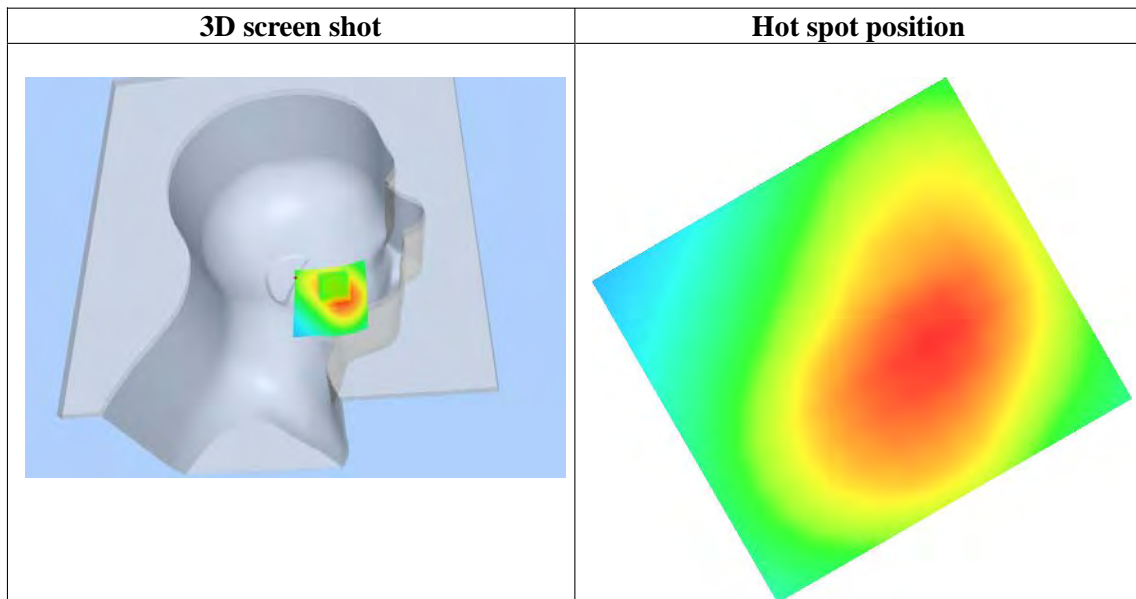
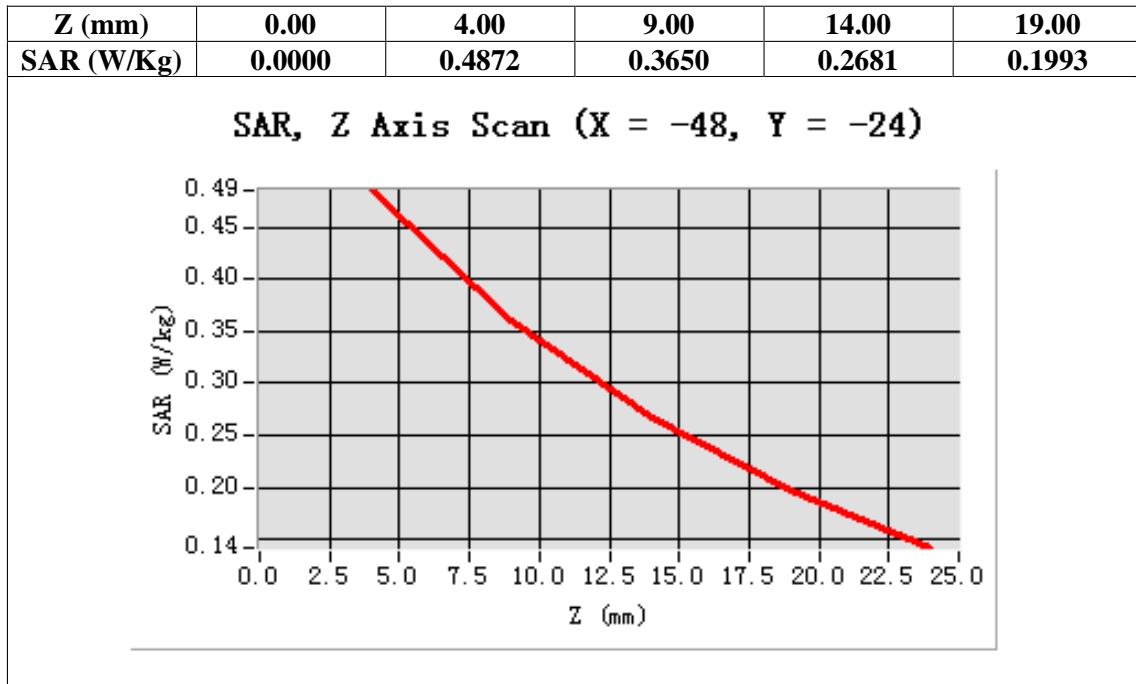



Test Laboratory: AGC Lab

Date: Dec.12, 2013

WCDMA Band V Mid-Tilt-Right (RMC)

DUT: Smart Phone; Type: Syreni 40DC

Communication System: UMTS; Communication System Band: BAND V UTRA/FDD ; Duty Cycle:1: 1; Conv.F=5.30  
Frequency: 835 MHz; Medium parameters used: f = 835 MHz;  $\sigma=0.84$  mho/m;  $\epsilon_r=40.26$ ;  $\rho=1000$  kg/m<sup>3</sup> ;  
Phantom section: Right Section  
Ambient temperature (°C): 21, Liquid temperature (°C): 21

SATIMO Configuration:

Probe: EP165; Calibrated: 01/31/2013

- Sensor-Surface: 4mm (Mechanical Surface Detection)
- Phantom: Flat Phantom; Type: Elliptical Phantom
- Measurement SW: OpenSAR V4\_02\_01

Configuration/ WCDMA Band V Mid-Tilt-Right/Area Scan: Measurement grid: dx=8mm, dy=8mm

Configuration/ WCDMA Band V Mid-Tilt-Right/Zoom Scan: Measurement grid: dx=8mm, dy=8mm, dz=5mm;

Area Scan	sam_direct_droit2_surf8mm.txt
Zoom Scan	5x5x7,dx=8mm dy=8mm dz=5mm,Very fast
Phantom	Right head
Device Position	Tilt
Band	WCDMA Band V
Channels	Middle
Signal	TDMA (Crest factor: 1.0)

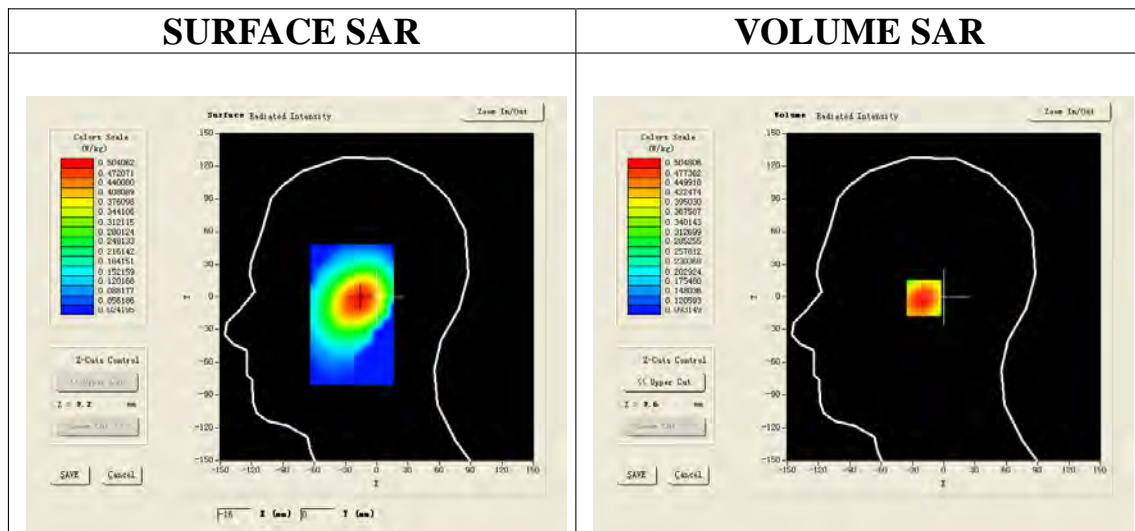

Maximum location: X=-16.00, Y=-1.00

SAR 10g (W/Kg)	0.341868
SAR 1g (W/Kg)	0.483805



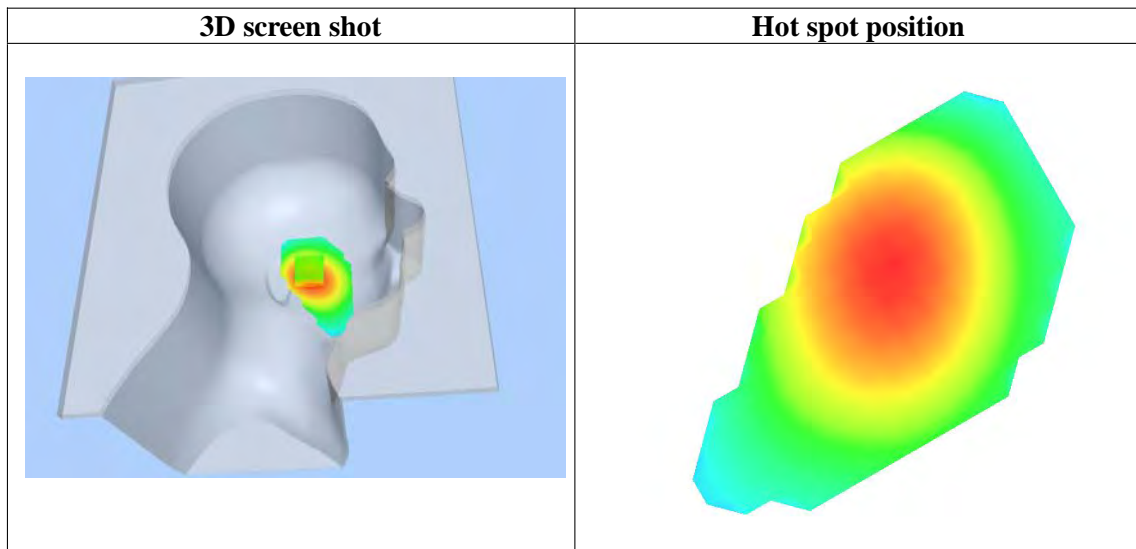
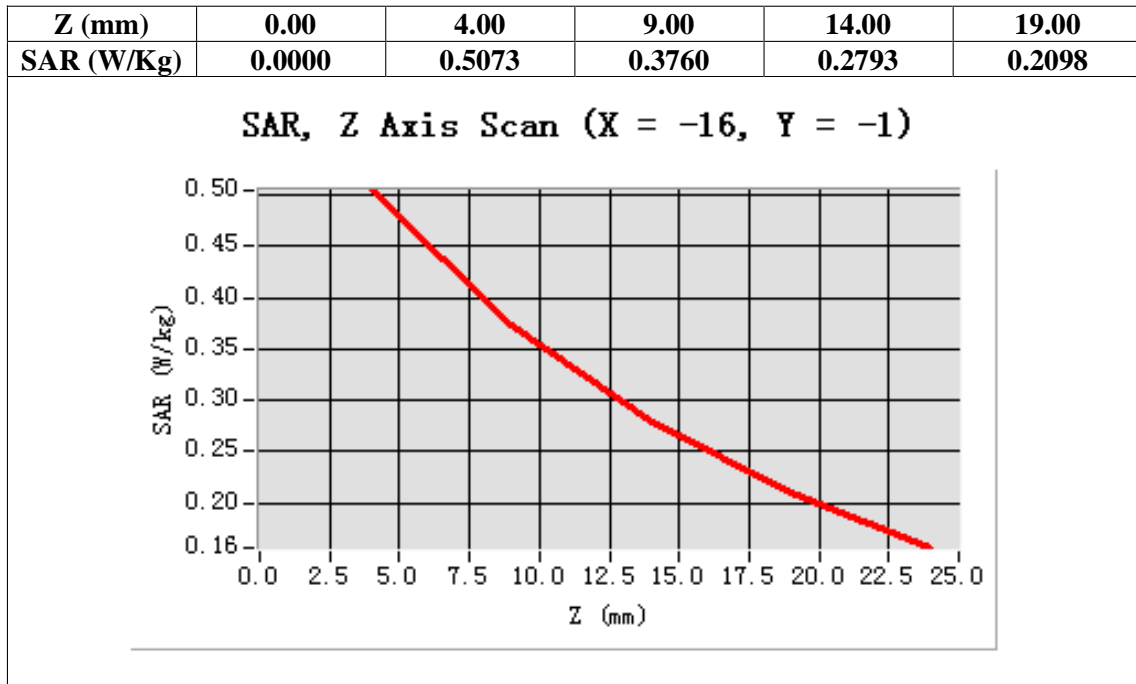

Test Laboratory: AGC Lab

Date: Dec.12, 2013

WCDMA Band V Low-Body-Towards Grounds (RMC)

DUT: Smart Phone; Type: Syreni 40DC

Communication System: UMTS; Communication System Band: BAND V UTRA/FDD; Duty Cycle:1: 1; Conv.F=5.46  
Frequency: 826.4 MHz; Medium parameters used:  $f = 835$  MHz;  $\sigma=0.95$  mho/m;  $\epsilon_r = 53.26$ ;  $\rho= 1000$  kg/m<sup>3</sup> ;  
Phantom section: Flat Section  
Ambient temperature (°C):21, Liquid temperature (°C):21

SATIMO Configuration:

Probe: EP165; Calibrated: 01/31/2013

- Sensor-Surface: 4mm (Mechanical Surface Detection)
- Phantom: Flat Phantom; Type: Elliptical Phantom
- Measurement SW: OpenSAR V4\_02\_01

Configuration/ WCDMA Band V Low-Body-Back/Area Scan (6x8x1): Measurement grid: dx=8mm, dy=8mm  
Configuration/ WCDMA Band V Low-Body-Back/Zoom Scan (5x5x7)/Cube 0: Measurement grid:  
dx=8mm,dy=8mm, dz=5mm;

Area Scan	surf_sam_plan.txt
ZoomScan	5x5x7,dx=8mm dy=8mm dz=5mm,Very fast
Phantom	Validation plane
Device Position	Body Back
Band	WCDMA Band V
Channels	Low
Signal	TDMA (Crest factor: 1.0)

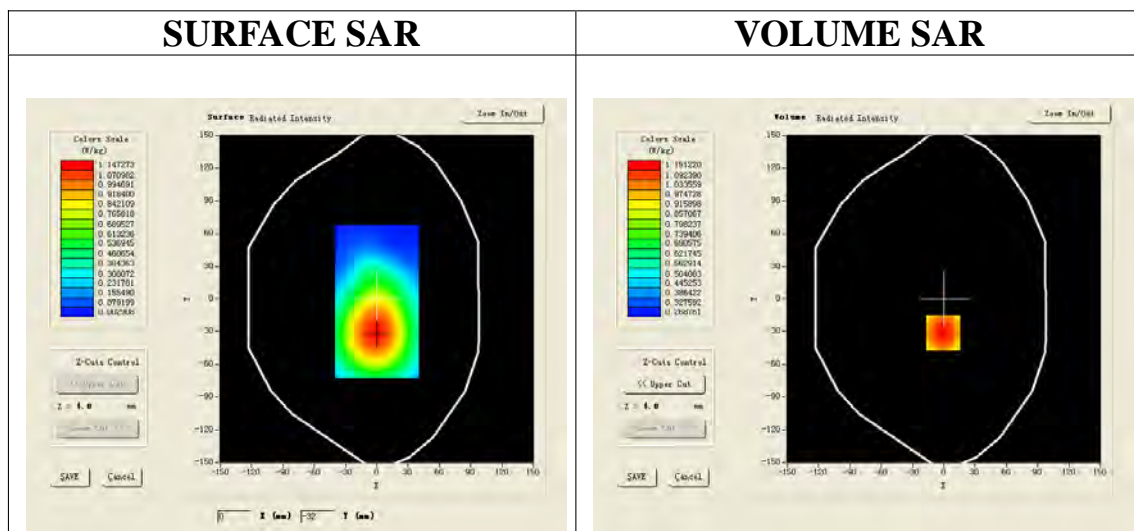

Maximum location: X=-1.00, Y=-31.00

SAR 10g (W/Kg)	0.794371
SAR 1g (W/Kg)	1.106940

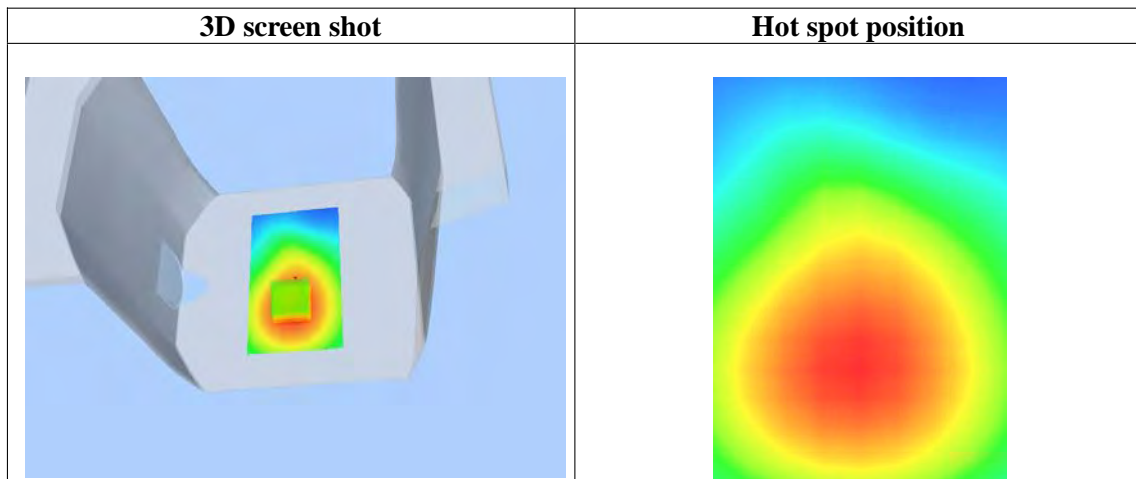
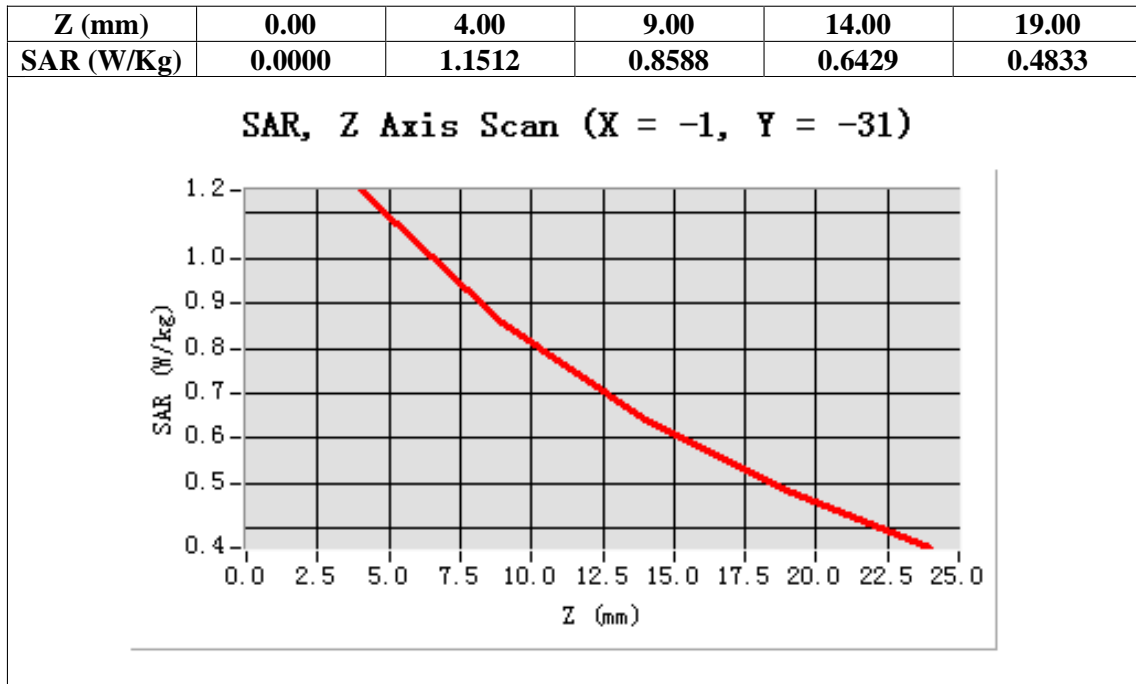

Test Laboratory: AGC Lab

Date: Dec.12, 2013

WCDMA Band V Mid-Body-Towards Grounds (RMC)

DUT: Smart Phone; Type: Syreni 40DC

Communication System: UMTS; Communication System Band: BAND V UTRA/FDD; Duty Cycle:1: 1; Conv.F=5.46  
Frequency: 835 MHz; Medium parameters used:  $f = 835$  MHz;  $\sigma=0.95$  mho/m;  $\epsilon_r =53.26$ ;  $\rho= 1000$  kg/m<sup>3</sup> ;  
Phantom section: Flat Section  
Ambient temperature (°C):21, Liquid temperature (°C):21

SATIMO Configuration:

Probe: EP165; Calibrated: 01/31/2013

- Sensor-Surface: 4mm (Mechanical Surface Detection)
- Phantom: Flat Phantom; Type: Elliptical Phantom
- Measurement SW: OpenSAR V4\_02\_01

Configuration/ WCDMA Band V Mid-Body-Back/Area Scan (6x8x1): Measurement grid: dx=8mm, dy=8mm

Configuration/ WCDMA Band V Mid-Body-Back/Zoom Scan (5x5x7)/Cube 0: Measurement grid:  
dx=8mm,dy=8mm, dz=5mm;

Area Scan	surf_sam_plan.txt
ZoomScan	5x5x7,dx=8mm dy=8mm dz=5mm,Very fast
Phantom	Validation plane
Device Position	Body Back
Band	WCDMA Band V
Channels	Middle
Signal	TDMA (Crest factor: 1.0)

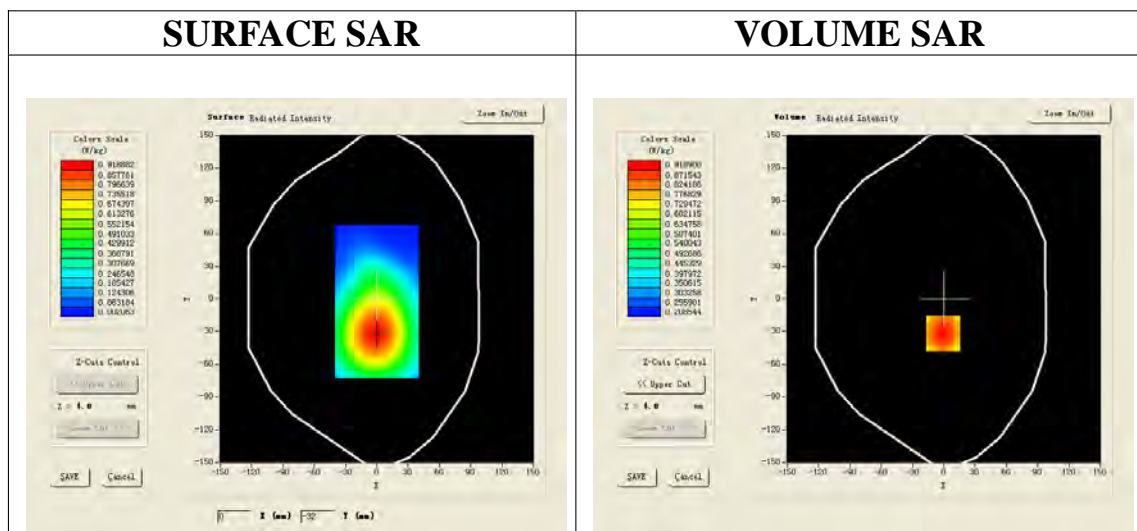

Maximum location: X=-1.00, Y=-32.00

SAR 10g (W/Kg)	0.637175
SAR 1g (W/Kg)	0.883964

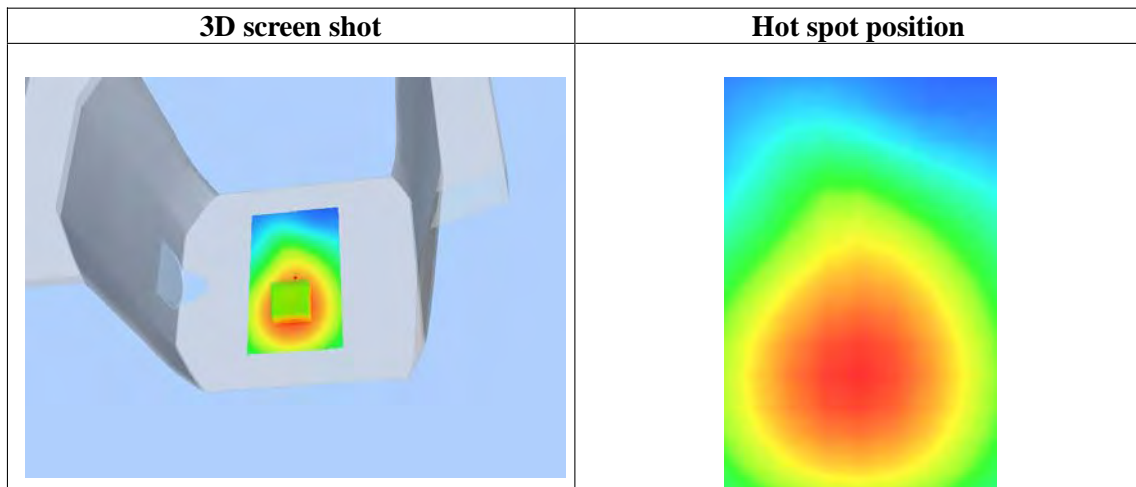
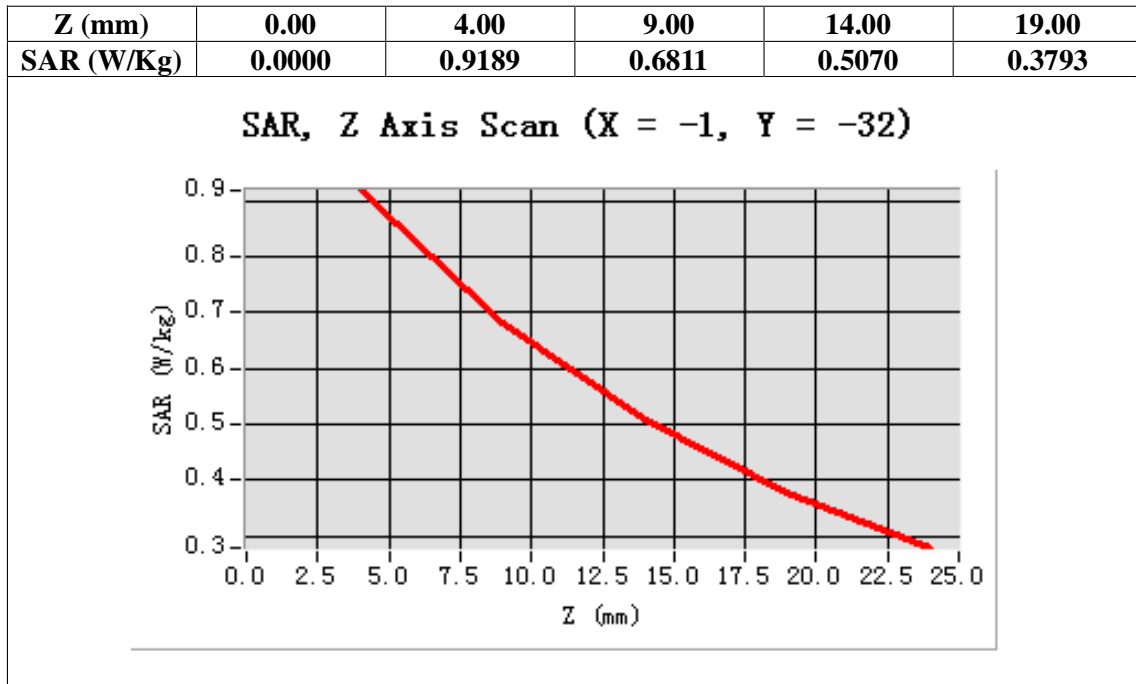

Test Laboratory: AGC Lab

Date: Dec.12, 2013

WCDMA Band V High-Body-Towards Grounds (RMC)

DUT: Smart Phone; Type: Syreni 40DC

Communication System: UMTS; Communication System Band: BAND V UTRA/FDD; Duty Cycle:1: 1; Conv.F=5.46  
Frequency: 846.6 MHz; Medium parameters used:  $f = 835$  MHz;  $\sigma=0.95$  mho/m;  $\epsilon_r = 53.26$ ;  $\rho = 1000$  kg/m<sup>3</sup> ;  
Phantom section: Flat Section  
Ambient temperature (°C):21, Liquid temperature (°C):21

SATIMO Configuration:

Probe: EP165; Calibrated: 01/31/2013

- Sensor-Surface: 4mm (Mechanical Surface Detection)
- Phantom: Flat Phantom; Type: Elliptical Phantom
- Measurement SW: OpenSAR V4\_02\_01

Configuration/ WCDMA Band V High-Body-Back/Area Scan (6x8x1): Measurement grid: dx=8mm, dy=8mm  
Configuration/ WCDMA Band V High-Body-Back/Zoom Scan (5x5x7)/Cube 0: Measurement grid:  
dx=8mm,dy=8mm, dz=5mm;

Area Scan	surf_sam_plan.txt
ZoomScan	5x5x7,dx=8mm dy=8mm dz=5mm,Very fast
Phantom	Validation plane
Device Position	Body Back
Band	WCDMA Band V
Channels	High
Signal	TDMA (Crest factor: 1.0)

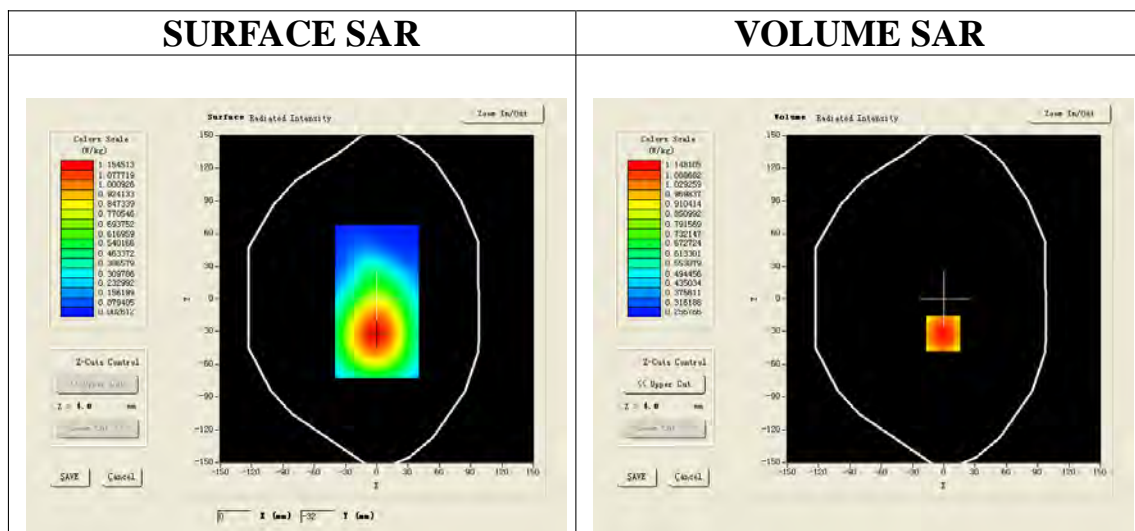

Maximum location: X=-1.00, Y=-32.00

SAR 10g (W/Kg)	0.785893
SAR 1g (W/Kg)	1.103741

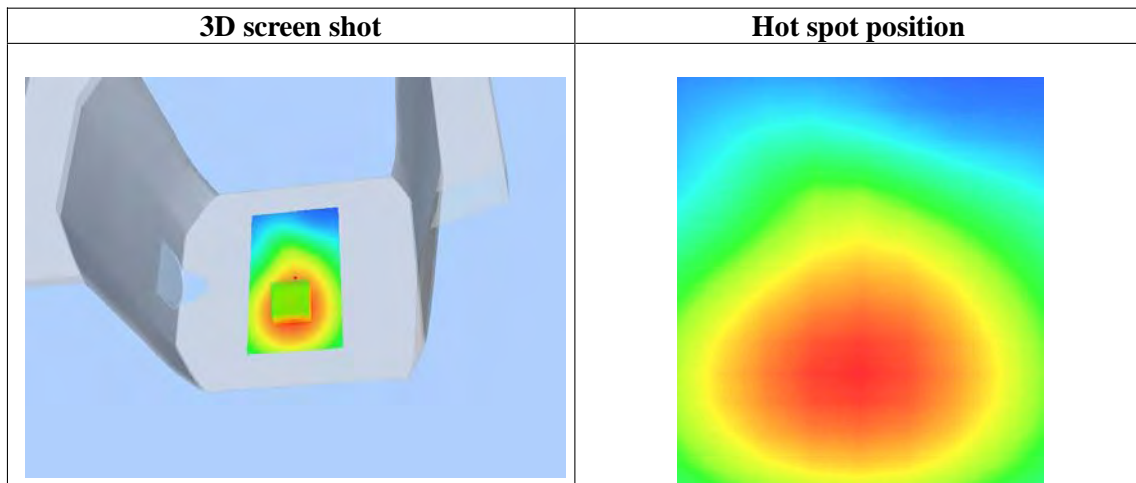
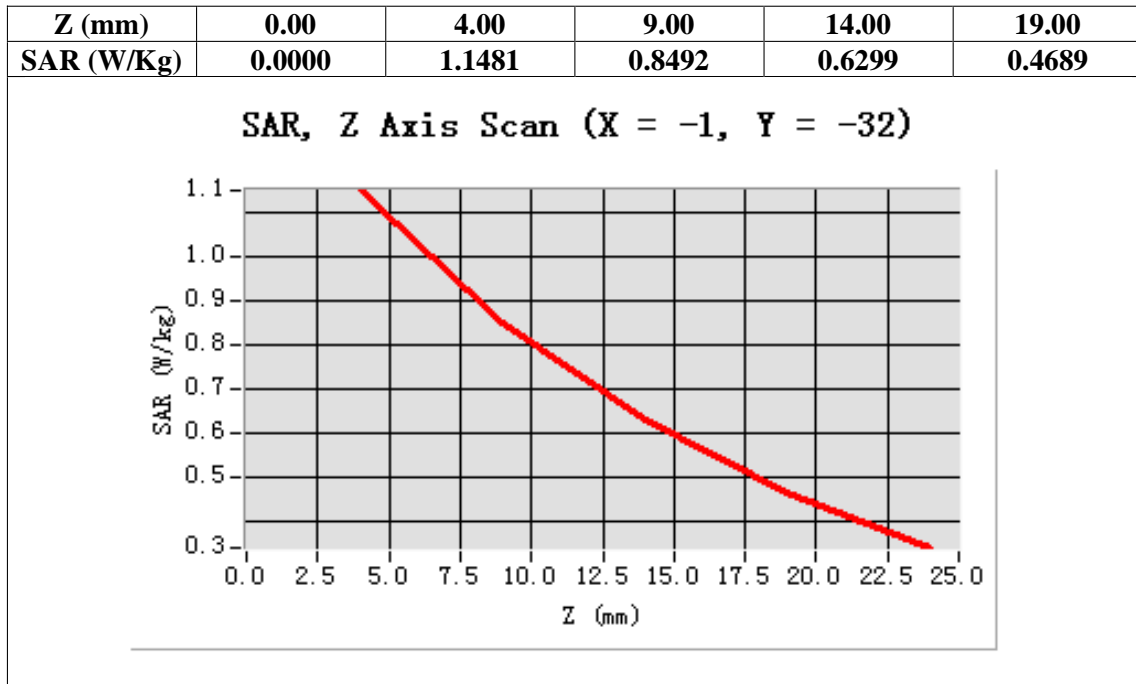

Test Laboratory: AGC Lab

Date: Dec.12, 2013

WCDMA Band V Low- Body - Towards Phantom (RMC)

DUT: Smart Phone; Type: Syreni 40DC

Communication System: UMTS; Communication System Band: BAND V UTRA/FDD ; Duty Cycle:1: 1; Conv.F=5.46  
Frequency: 824.2 MHz; Medium parameters used: f = 835 MHz;  $\sigma=0.95$  mho/m;  $\epsilon_r =53.26$ ;  $\rho= 1000\text{kg/m}^3$  ;  
Phantom section: Flat Section  
Ambient temperature ( $^{\circ}\text{C}$ ):21, Liquid temperature ( $^{\circ}\text{C}$ ):21

SATIMO Configuration:

Probe: EP165; Calibrated: 01/31/2013

- Sensor-Surface: 4mm (Mechanical Surface Detection)
- Phantom: Flat Phantom; Type: Elliptical Phantom
- Measurement SW: OpenSAR V4\_02\_01

Configuration/ WCDMA Band V Low-Body-Front /Area Scan (6x8x1): Measurement grid: dx=8mm, dy=8mm  
Configuration/ WCDMA Band V Low-Body-Front /Zoom Scan (5x5x7)/Cube 0: Measurement grid: dx=8mm, dy=8mm, dz=5mm;

Area Scan	surf_sam_plan.txt
ZoomScan	5x5x7,dx=8mm dy=8mm dz=5mm,Very fast
Phantom	Validation plane
Device Position	Body Front
Band	WCDMA Band V
Channels	Low
Signal	TDMA (Crest factor: 1.0)

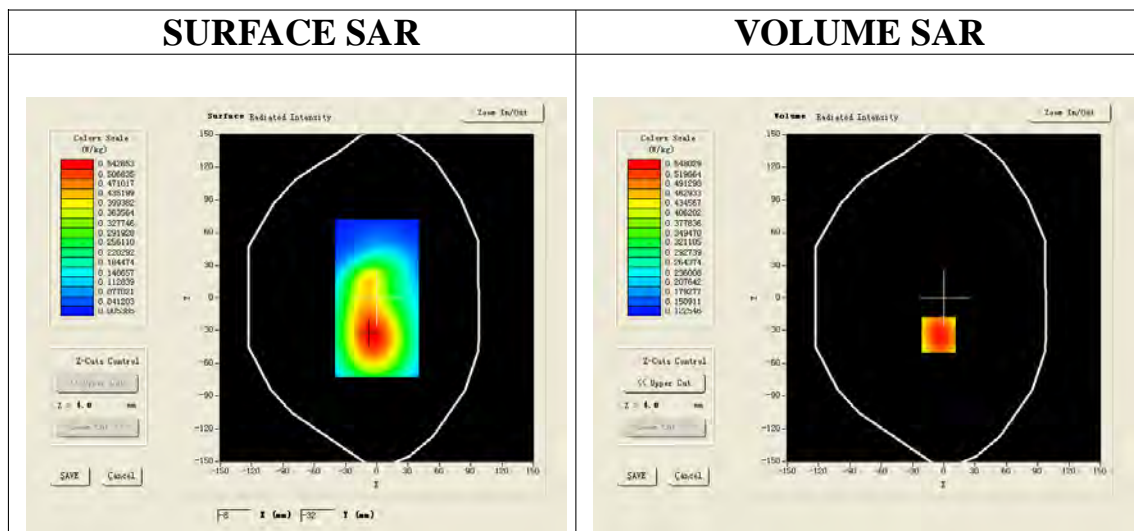

Maximum location: X=-5.00, Y=-34.00

SAR 10g (W/Kg)	0.379362
SAR 1g (W/Kg)	0.525105



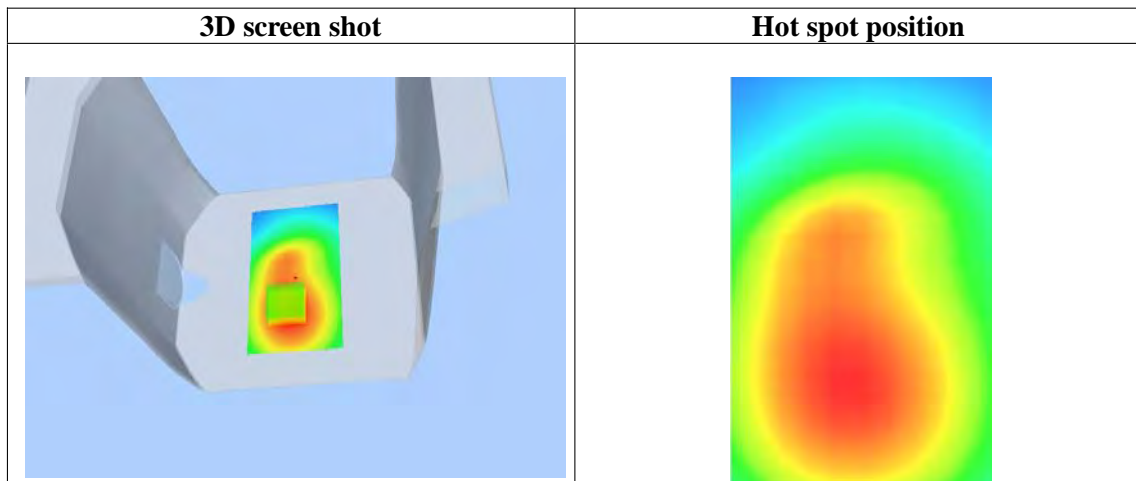
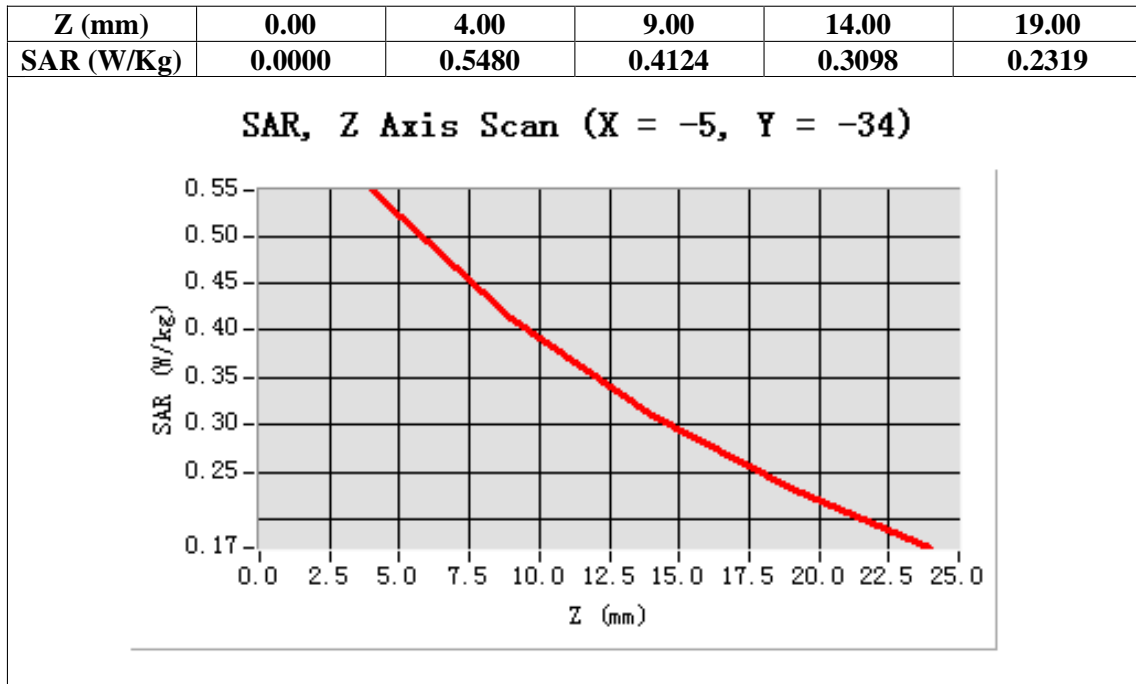

### Repeated SAR

Test Laboratory: AGC Lab  
GSM 835 Mid- Body- Back <SIM 1>  
DUT: Smart Phone; Type: Syreni 40DC

Date: Dec.12, 2013

Communication System: Generic GSM; Communication System Band: GSM 835; Duty Cycle: 1:8.3; Conv.F=5.46;  
Frequency: 836.6 MHz; Medium parameters used:  $f = 835$  MHz;  $\sigma = 0.95$  mho/m;  $\epsilon_r = 53.26$ ;  $\rho = 1000$  kg/m<sup>3</sup> ;  
Phantom section: Flat Section  
Ambient temperature (°C): 21.0, Liquid temperature (°C): 21.0

#### SATIMO Configuration:

- Probe: EP165; Calibrated: 01/31/2013
- Sensor-Surface: 4mm (Mechanical Surface Detection)
- Phantom: Flat Phantom; Type: Elliptical Phantom
- Measurement SW: OpenSAR V4\_02\_01

Configuration/GSM 835 Mid-Body-Back/Area Scan (6x8x1): Measurement grid: dx=8mm, dy=8mm  
Configuration/GSM 835 Mid-Body-Back/Zoom Scan (5x5x7)/Cube 0: Measurement grid: dx=8mm, dy=8mm, dz=5mm;

<b>Area Scan</b>	surf_sam_plan.txt
<b>ZoomScan</b>	5x5x7,dx=8mm dy=8mm dz=5mm,Very fast
<b>Phantom</b>	Validation plane
<b>Device Position</b>	Body Back
<b>Band</b>	GSM 835
<b>Channels</b>	Middle
<b>Signal</b>	TDMA (Crest factor: 8.0)

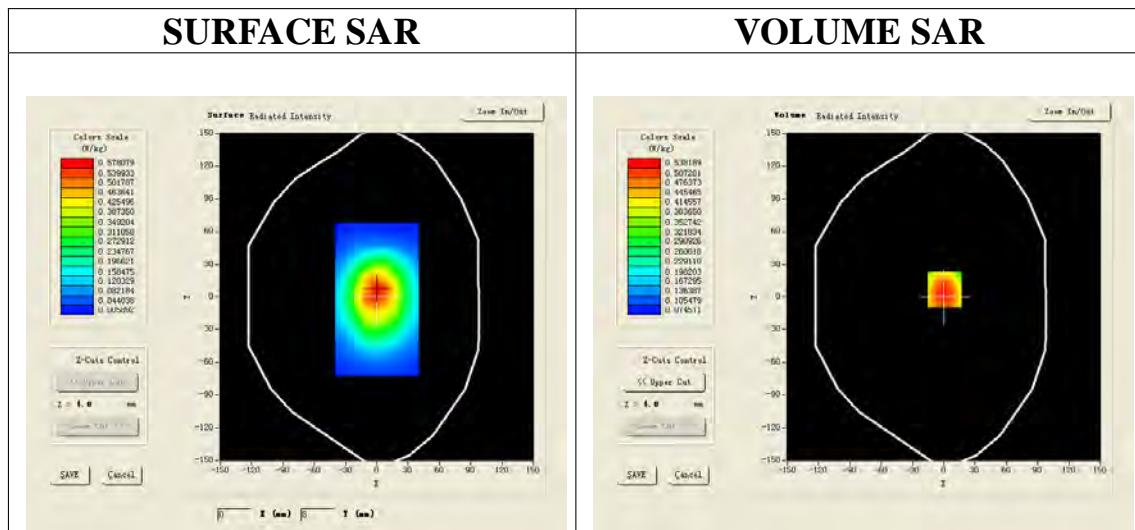

**Maximum location: X=1.00, Y=7.00**

<b>SAR 10g (W/Kg)</b>	0.375801
<b>SAR 1g (W/Kg)</b>	0.563792

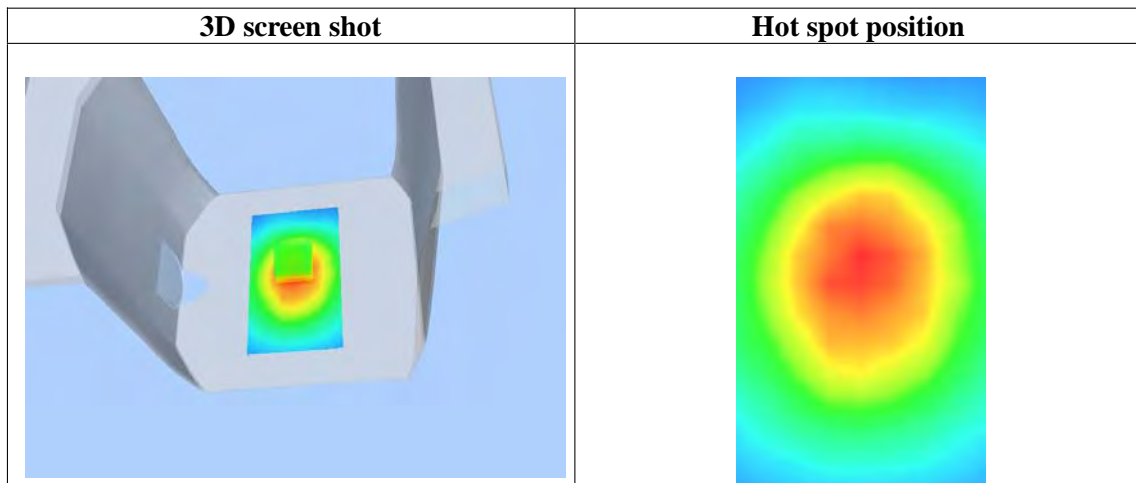
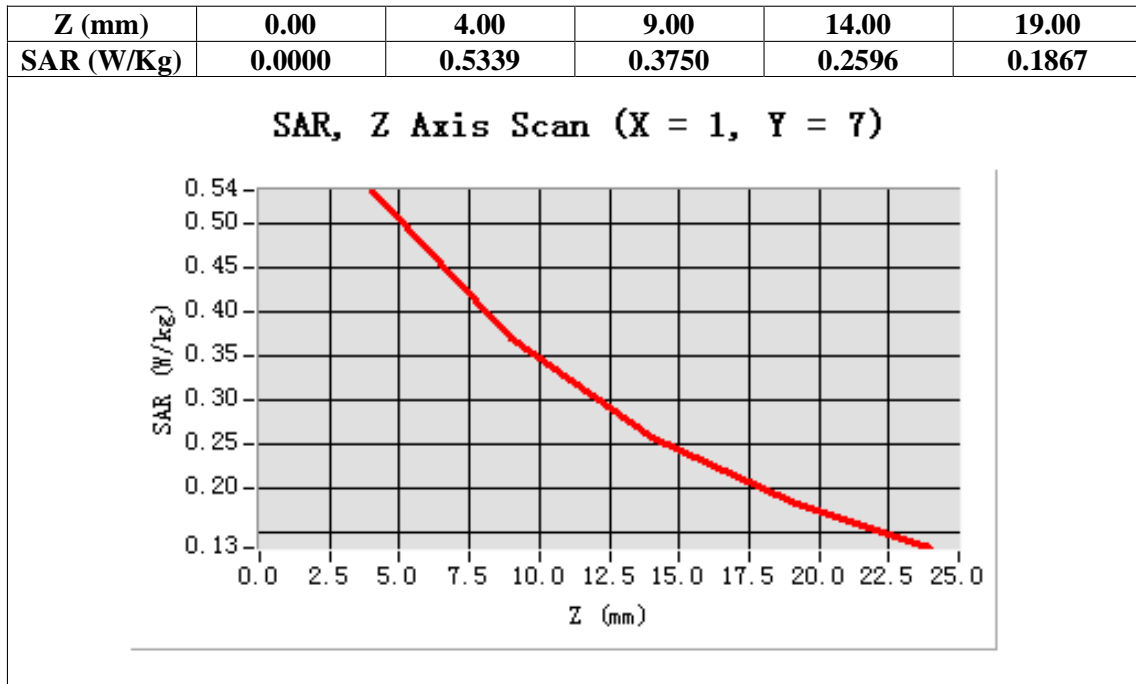

**Test Laboratory: AGC Lab**  
**PCS 1900 Mid-Body- Back <SIM 1>**  
**DUT: Smart Phone; Type: Syreni 40DC**

**Date: Dec.12, 2013**

Communication System: Generic GSM; Communication System Band: PCS 1900; Duty Cycle: 1:8.3; Conv.F=4.84;  
Frequency: 1880 MHz; Medium parameters used:  $f = 1900$  MHz;  $\sigma = 1.47$  mho/m;  $\epsilon_r = 54.62$ ;  $\rho = 1000$  kg/m<sup>3</sup> ;  
Phantom section: Flat Section  
Ambient temperature (°C): 21.0, Liquid temperature (°C): 21.0

SATIMO Configuration:

Probe: EP165; Calibrated: 01/31/2013

- Sensor-Surface: 4mm (Mechanical Surface Detection)
- Phantom: Flat Phantom; Type: Elliptical Phantom
- Measurement SW: OpenSAR V4\_02\_01

**Configuration/PCS1900 Mid-Body-Back/Area Scan: Measurement grid: dx=8mm, dy=8mm**  
**Configuration/PCS1900 Mid-Body-Back/Zoom Scan: Measurement grid: dx=8mm, dy=8mm, dz=5mm;**

<b>Area Scan</b>	surf_sam_plan.txt
<b>ZoomScan</b>	5x5x7,dx=8mm dy=8mm dz=5mm,Very fast
<b>Phantom</b>	Validation plane
<b>Device Position</b>	Body Back
<b>Band</b>	PCS 1900
<b>Channels</b>	Middle
<b>Signal</b>	TDMA (Crest factor: 8.0)

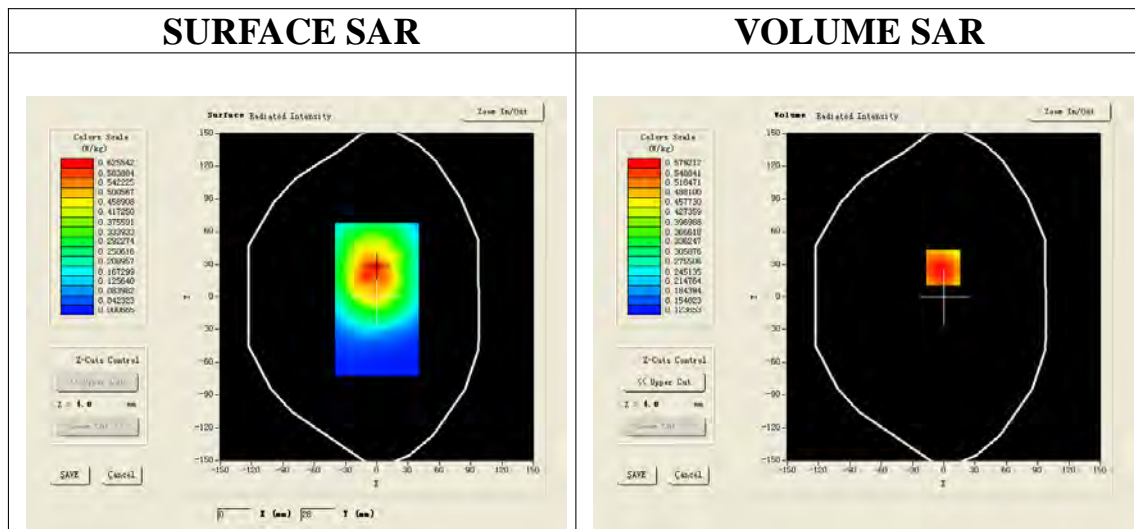

**Maximum location: X=-1.00, Y=27.00**

<b>SAR 10g (W/Kg)</b>	0.393405
<b>SAR 1g (W/Kg)</b>	0.552593

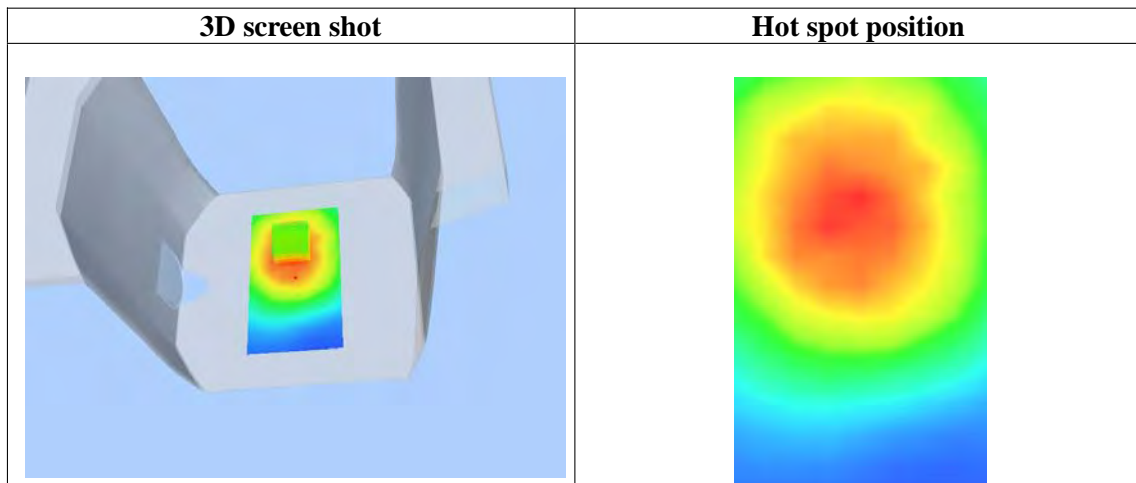
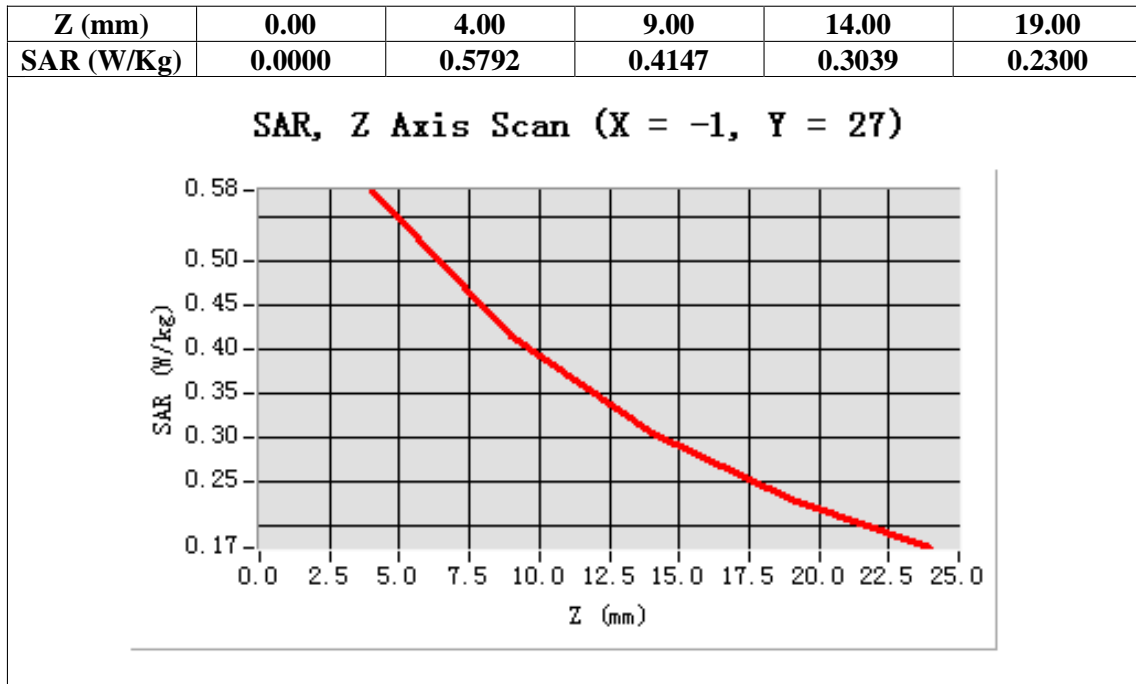

Test Laboratory: AGC Lab

Date: Dec.12, 2013

WCDMA Band V Low-Body-Towards Grounds (RMC)

DUT: Smart Phone; Type: Syreni 40DC

Communication System: UMTS; Communication System Band: BAND V UTRA/FDD; Duty Cycle:1: 1; Conv.F=5.46  
Frequency: 826.4 MHz; Medium parameters used:  $f = 835$  MHz;  $\sigma=0.95$  mho/m;  $\epsilon_r = 53.26$ ;  $\rho = 1000$  kg/m<sup>3</sup> ;  
Phantom section: Flat Section  
Ambient temperature (°C):21, Liquid temperature (°C):21

SATIMO Configuration:

Probe: EP165; Calibrated: 01/31/2013

- Sensor-Surface: 4mm (Mechanical Surface Detection)
- Phantom: Flat Phantom; Type: Elliptical Phantom
- Measurement SW: OpenSAR V4\_02\_01

Configuration/ WCDMA Band V Low-Body-Back/Area Scan (6x8x1): Measurement grid: dx=8mm, dy=8mm  
Configuration/ WCDMA Band V Low-Body-Back/Zoom Scan (5x5x7)/Cube 0: Measurement grid:  
dx=8mm,dy=8mm, dz=5mm;

Area Scan	surf_sam_plan.txt
ZoomScan	5x5x7,dx=8mm dy=8mm dz=5mm,Very fast
Phantom	Validation plane
Device Position	Body Back
Band	WCDMA Band V
Channels	Low
Signal	TDMA (Crest factor: 1.0)

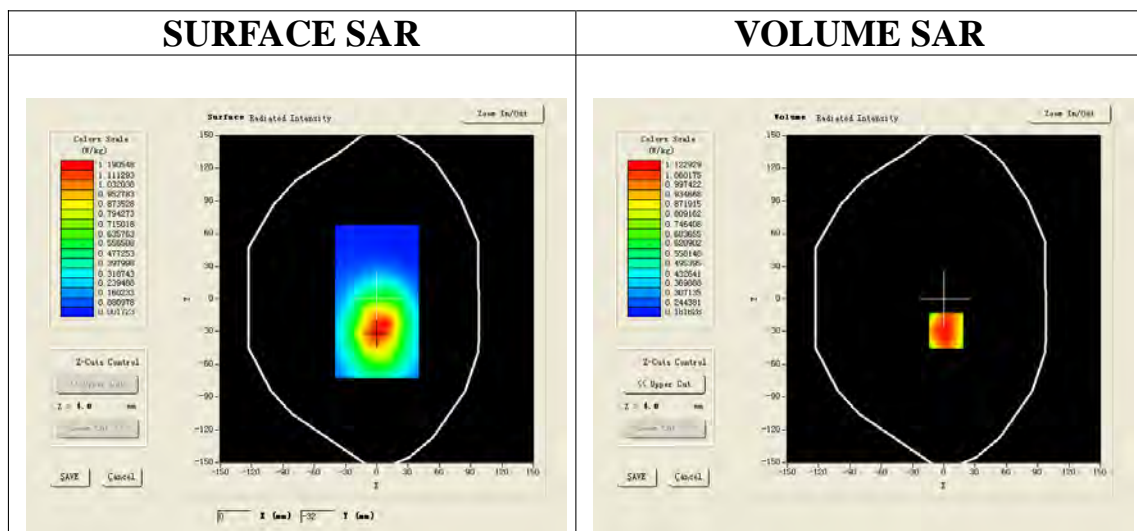

Maximum location: X=2.00, Y=-29.00

SAR 10g (W/Kg)	0.782509
SAR 1g (W/Kg)	1.086418

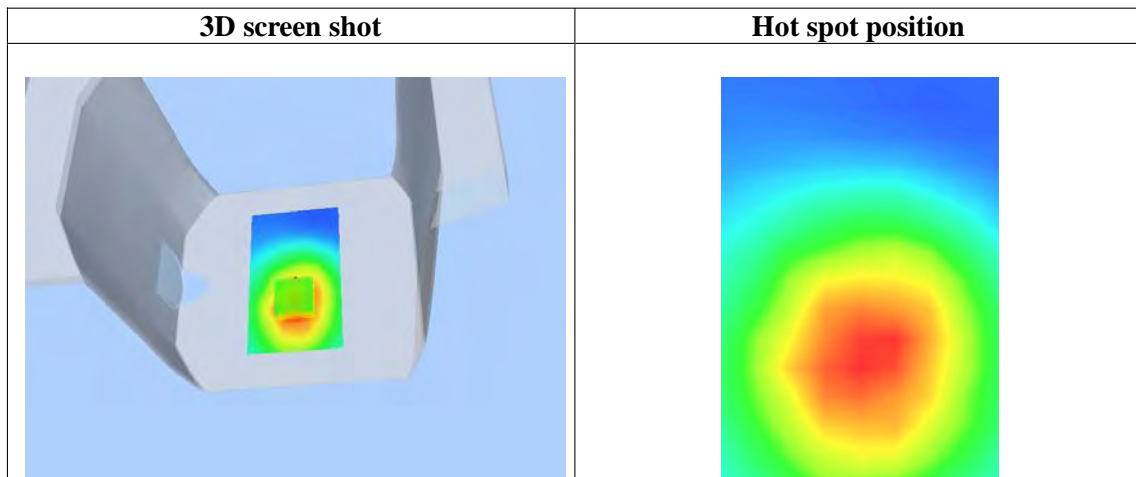
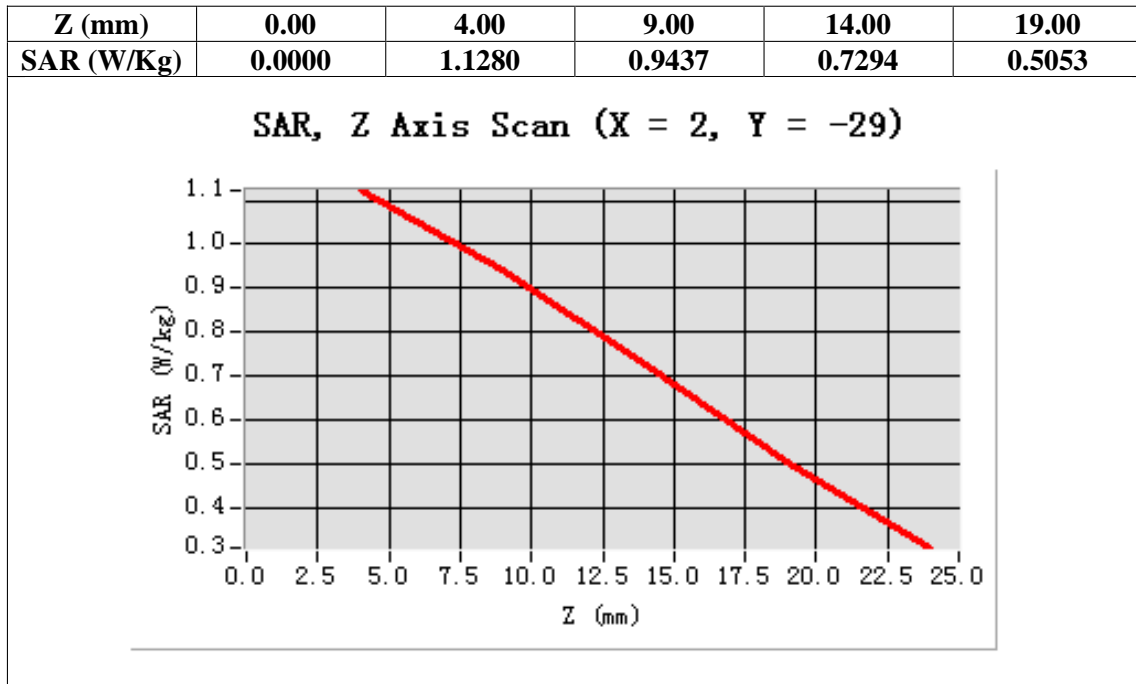

Test Laboratory: AGC Lab

Date: Dec.12, 2013

WCDMA Band V Mid-Body-Towards Grounds (RMC)

DUT: Smart Phone; Type: Syreni 40DC

Communication System: UMTS; Communication System Band: BAND V UTRA/FDD; Duty Cycle:1: 1; Conv.F=5.46  
Frequency: 835 MHz; Medium parameters used:  $f = 835$  MHz;  $\sigma=0.95$  mho/m;  $\epsilon_r =53.26$ ;  $\rho= 1000$  kg/m<sup>3</sup> ;  
Phantom section: Flat Section  
Ambient temperature (°C):21, Liquid temperature (°C):21

SATIMO Configuration:

Probe: EP165; Calibrated: 01/31/2013

- Sensor-Surface: 4mm (Mechanical Surface Detection)
- Phantom: Flat Phantom; Type: Elliptical Phantom
- Measurement SW: OpenSAR V4\_02\_01

Configuration/ WCDMA Band V Mid-Body-Back/Area Scan (6x8x1): Measurement grid: dx=8mm, dy=8mm

Configuration/ WCDMA Band V Mid-Body-Back/Zoom Scan (5x5x7)/Cube 0: Measurement grid: dx=8mm,dy=8mm, dz=5mm;

Area Scan	surf_sam_plan.txt
ZoomScan	5x5x7,dx=8mm dy=8mm dz=5mm,Very fast
Phantom	Validation plane
Device Position	Body Back
Band	WCDMA Band V
Channels	Middle
Signal	TDMA (Crest factor: 1.0)

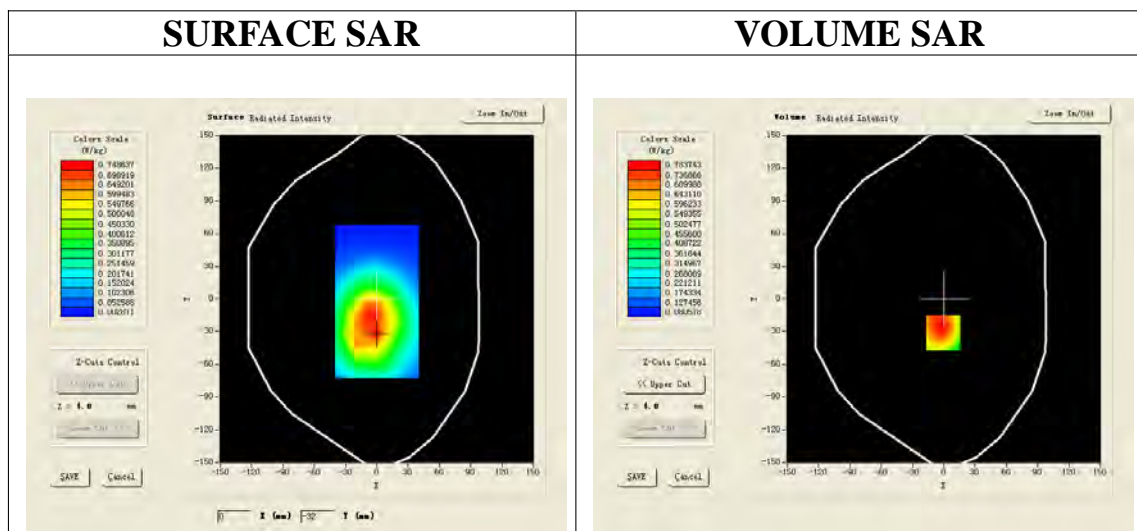

Maximum location: X=-1.00, Y=-31.00

SAR 10g (W/Kg)	0.525027
SAR 1g (W/Kg)	0.823671



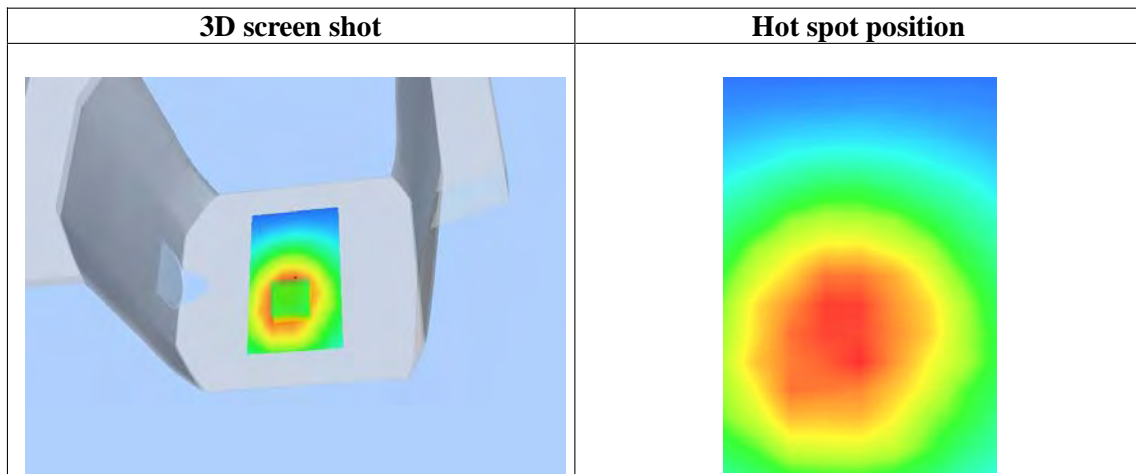
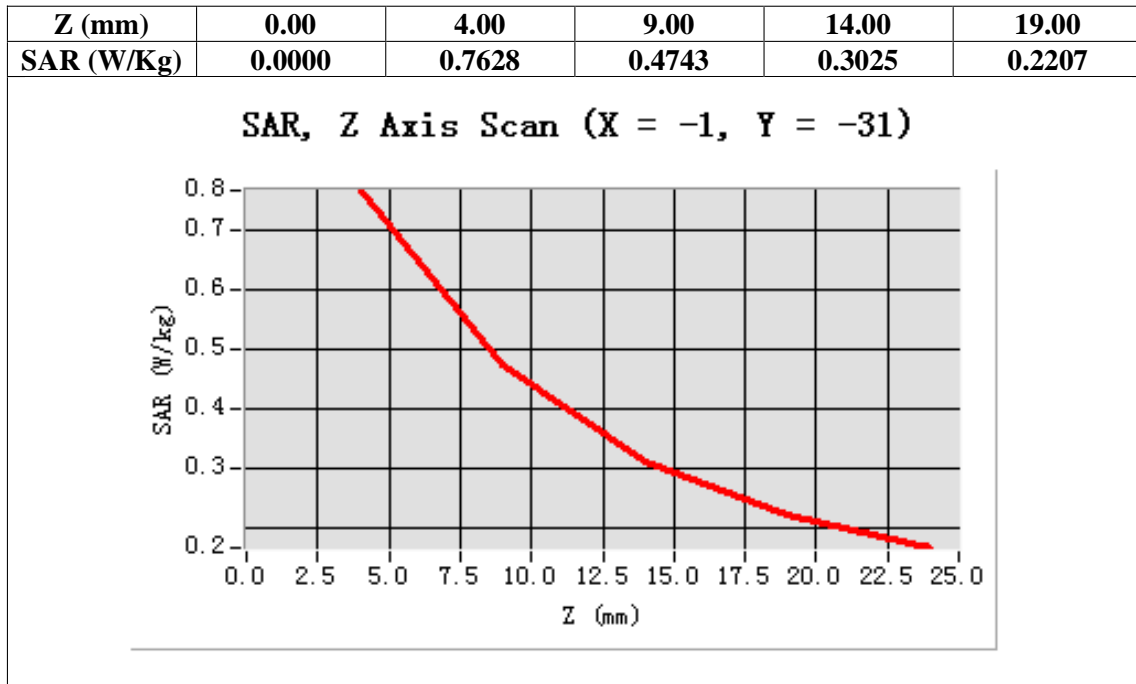

Test Laboratory: AGC Lab

Date: Dec.12, 2013

WCDMA Band V High-Body-Towards Grounds (RMC)

DUT: Smart Phone; Type: Syreni 40DC

Communication System: UMTS; Communication System Band: BAND V UTRA/FDD; Duty Cycle:1: 1; Conv.F=5.46  
Frequency: 846.6 MHz; Medium parameters used:  $f = 835$  MHz;  $\sigma=0.95$  mho/m;  $\epsilon_r = 53.26$ ;  $\rho = 1000$  kg/m<sup>3</sup> ;  
Phantom section: Flat Section  
Ambient temperature (°C):21, Liquid temperature (°C):21

SATIMO Configuration:

Probe: EP165; Calibrated: 01/31/2013

- Sensor-Surface: 4mm (Mechanical Surface Detection)
- Phantom: Flat Phantom; Type: Elliptical Phantom
- Measurement SW: OpenSAR V4\_02\_01

Configuration/ WCDMA Band V High-Body-Back/Area Scan (6x8x1): Measurement grid: dx=8mm, dy=8mm

Configuration/ WCDMA Band V High-Body-Back/Zoom Scan (5x5x7)/Cube 0: Measurement grid:  
dx=8mm,dy=8mm, dz=5mm;

Area Scan	surf_sam_plan.txt
ZoomScan	5x5x7,dx=8mm dy=8mm dz=5mm,Very fast
Phantom	Validation plane
Device Position	Body Back
Band	WCDMA Band V
Channels	High
Signal	TDMA (Crest factor: 1.0)

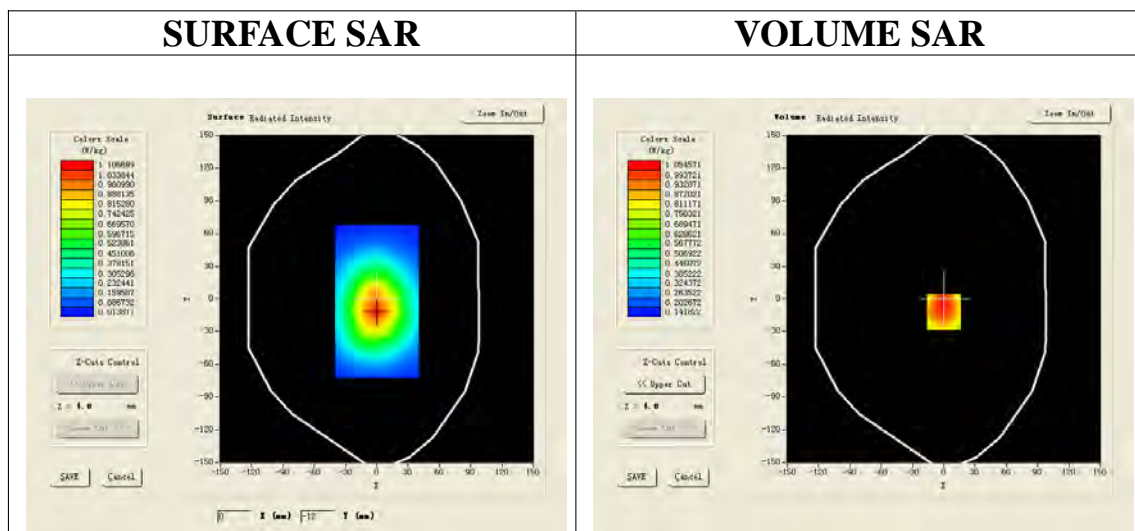

Maximum location: X=0.00, Y=-12.00

SAR 10g (W/Kg)	0.714715
SAR 1g (W/Kg)	1.003405

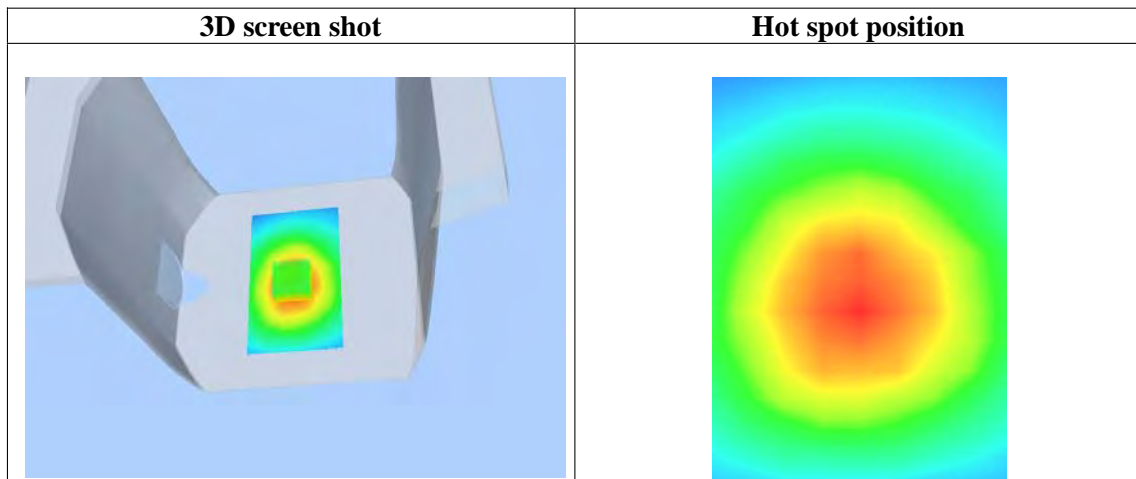
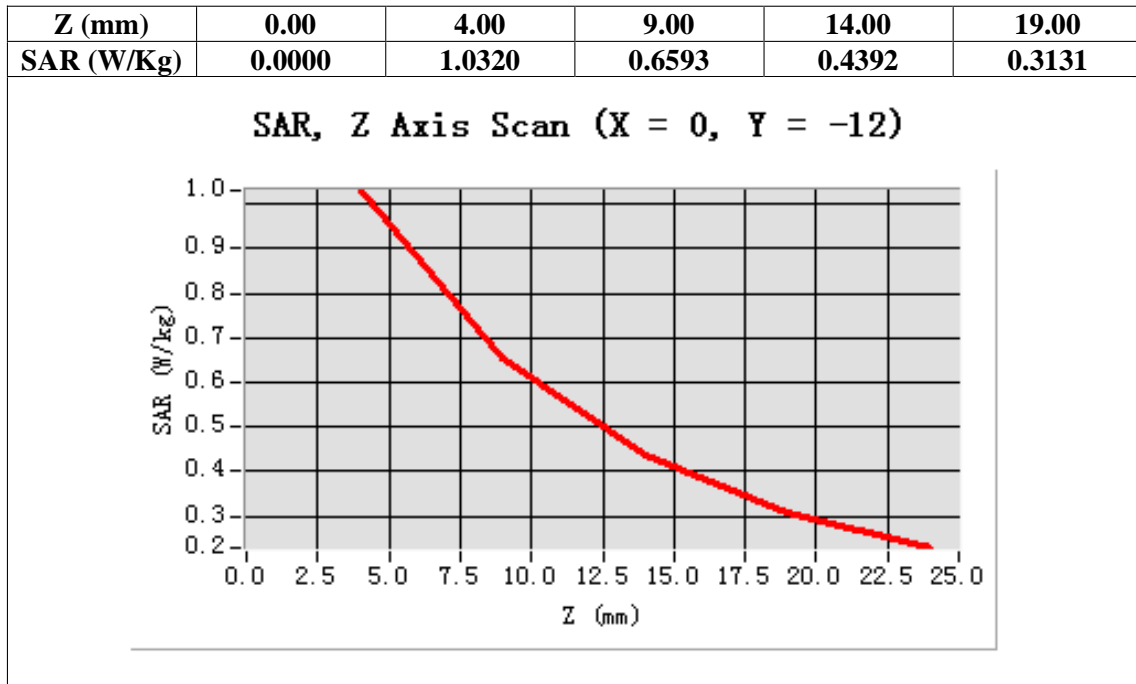

**WIFI MODE**

Test Laboratory: AGC Lab  
802.11b Mid-Touch-Left

Date: Dec.12, 2013

DUT: Smart Phone; Type: Syreni 40DC

Communication System: Wi-Fi; Communication System Band: 802.11b; Duty Cycle: 1:1; Conv.F=4.19;  
Frequency: 2437 MHz; Medium parameters used:  $f = 2450$  MHz;  $\sigma = 1.84$  mho/m;  $\epsilon_r = 38.54$ ;  $\rho = 1000$  kg/m<sup>3</sup> ;  
Phantom section: Left Section  
Ambient temperature (°C): 21, Liquid temperature (°C): 21

SATIMO Configuration:

Probe: EP165; Calibrated: 01/31/2013

- Sensor-Surface: 4mm (Mechanical Surface Detection)
- Phantom: Flat Phantom; Type: Elliptical Phantom
- Measurement SW: OpenSAR V4\_02\_01

Configuration/802.11b Mid- Touch-Left/Area Scan (6x8x1): Measurement grid: dx=8mm, dy=8mm  
Configuration/802.11b Mid- Touch-Left/Zoom Scan (5x5x7)/Cube 0: Measurement grid: dx=8mm, dy=8mm, dz=5mm

Area Scan	sam_direct_droit2_surf8mm.txt
ZoomScan	5x5x7,dx=8mm dy=8mm dz=5mm,Very fast
Phantom	Left head
Device Position	Cheek
Band	2450MHz
Channels	Middle
Signal	TDMA (Crest factor: 8.0)

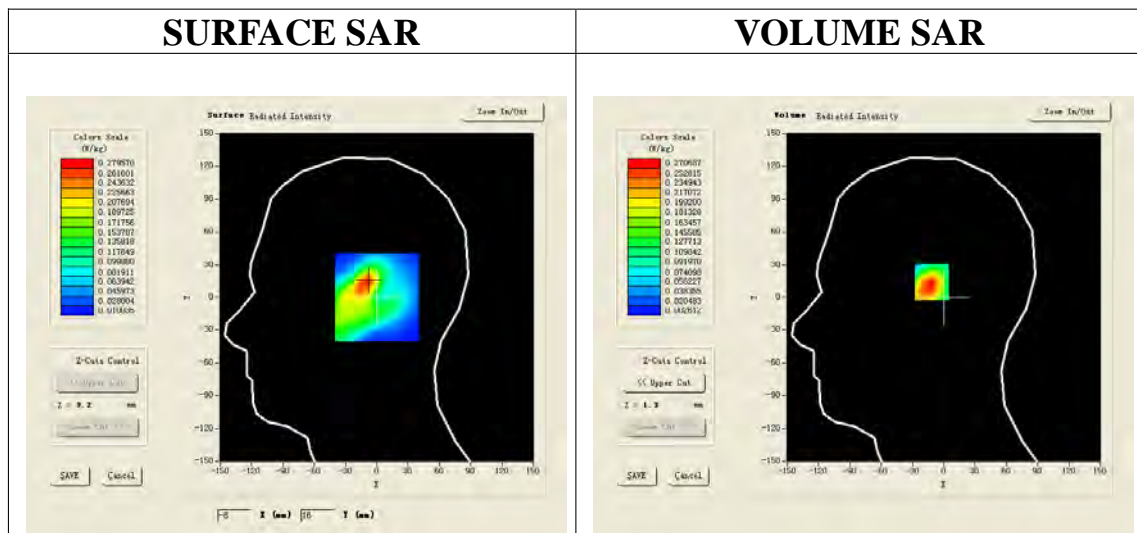

Maximum location: X=-9.00, Y=15.00

SAR 10g (W/Kg)	0.132644
SAR 1g (W/Kg)	0.257356

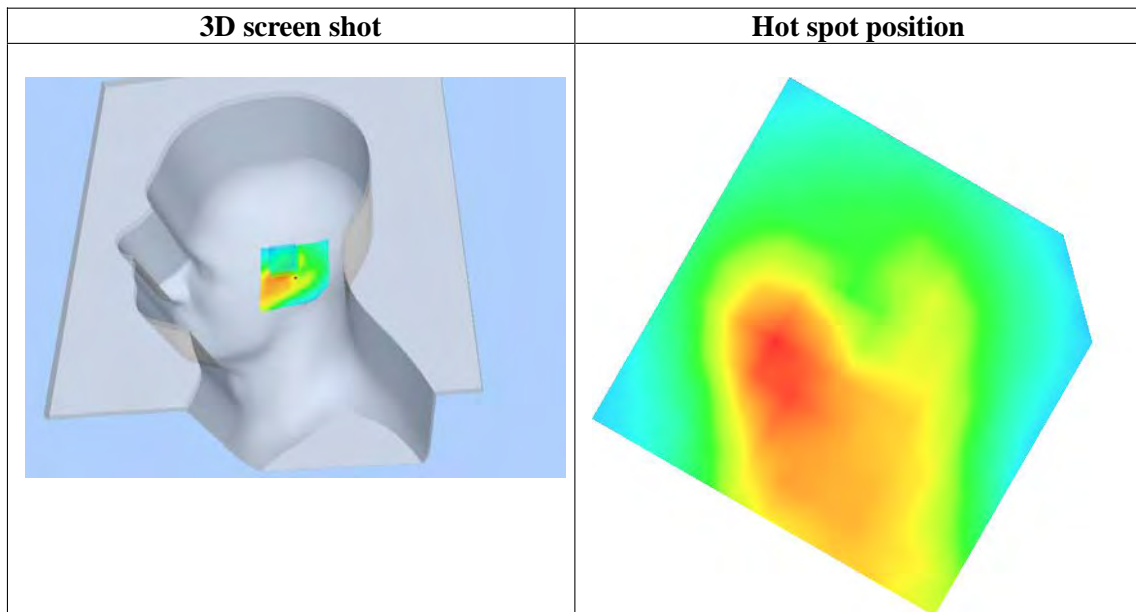
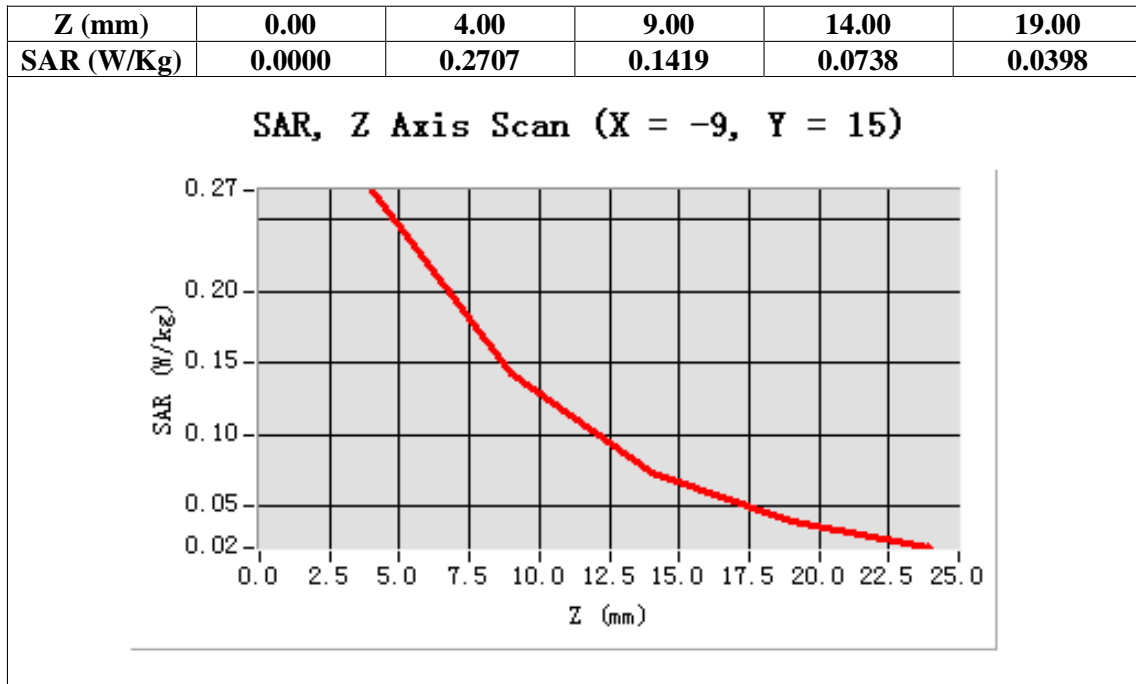

Test Laboratory: AGC Lab  
802.11b Mid -Tilt-Left

Date: Dec.12, 2013

DUT: Smart Phone; Type: Syreni 40DC

Communication System: Wi-Fi; Communication System Band: 802.11b; Duty Cycle: 1:1; Conv.F=4.19;  
Frequency: 2437 MHz; Medium parameters used:  $f = 2450$  MHz;  $\sigma = 1.84$  mho/m;  $\epsilon_r = 38.54$ ;  $\rho = 1000$  kg/m<sup>3</sup> ;  
Phantom section: Left Section  
Ambient temperature (°C): 21, Liquid temperature (°C): 21

SATIMO Configuration:

Probe: EP165; Calibrated: 01/31/2013

- Sensor-Surface: 4mm (Mechanical Surface Detection)
- Phantom: Flat Phantom; Type: Elliptical Phantom
- Measurement SW: OpenSAR V4\_02\_01

Configuration/802.11b Mid- Tilt-Left/Area Scan (6x8x1): Measurement grid: dx=8mm, dy=8mm  
Configuration/802.11b Mid- Tilt-Left/Zoom Scan (5x5x7)/Cube 0: Measurement grid: dx=8mm, dy=8mm,dz=5mm;

<b>Area Scan</b>	sam_direct_droit2_surf8mm.txt
<b>ZoomScan</b>	5x5x7,dx=8mm dy=8mm dz=5mm,Very fast
<b>Phantom</b>	Left head
<b>Device Position</b>	Tilt
<b>Band</b>	2450MHz
<b>Channels</b>	Middle
<b>Signal</b>	TDMA (Crest factor: 8.0)

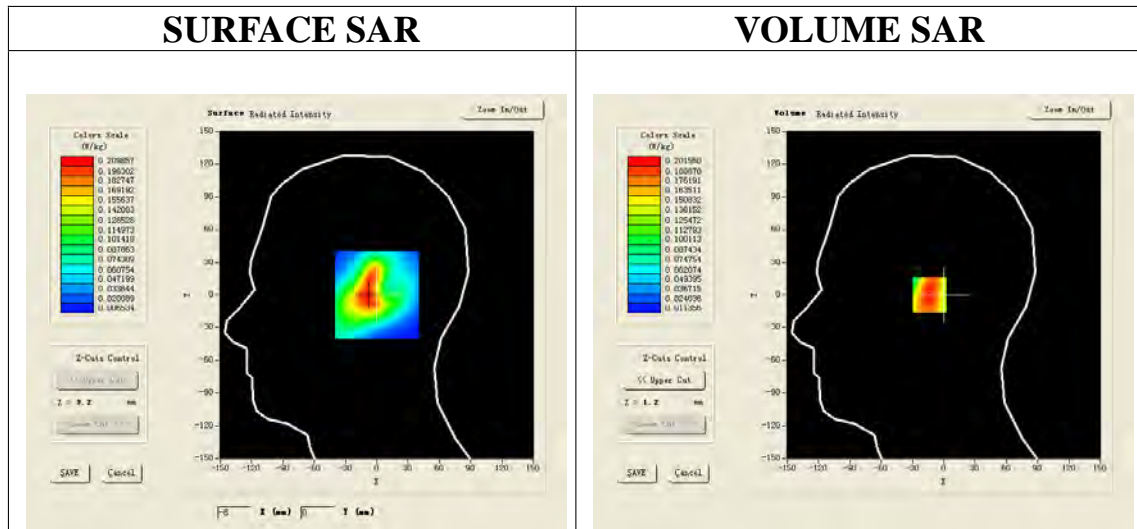

Maximum location: X=-10.00, Y=0.00

<b>SAR 10g (W/Kg)</b>	0.115462
<b>SAR 1g (W/Kg)</b>	0.191925

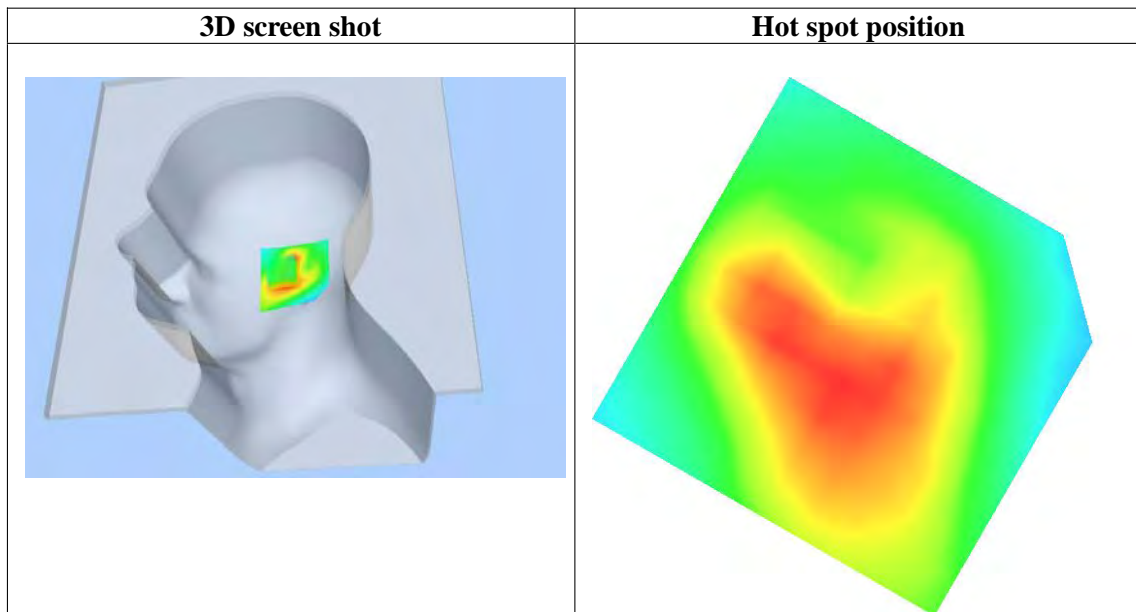
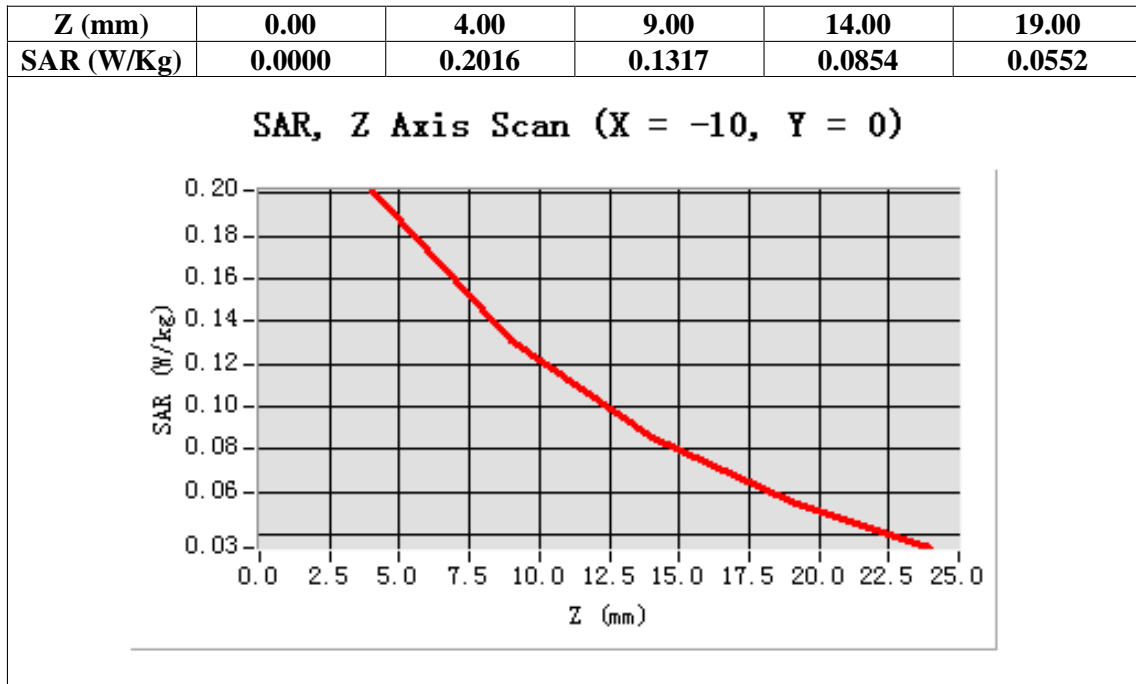



Test Laboratory: AGC Lab  
802.11b Mid- Touch-Right  
**DUT: Smart Phone; Type: Syreni 40DC**

**Date: Dec.12, 2013**

Communication System: Wi-Fi; Communication System Band: 802.11b; Duty Cycle: 1:1; Conv.F=4.19;  
Frequency: 2437 MHz; Medium parameters used:  $f = 2450$  MHz;  $\sigma = 1.84$  mho/m;  $\epsilon_r = 38.54$ ;  $\rho = 1000$  kg/m<sup>3</sup> ;  
Phantom section: Right Section  
Ambient temperature (°C): 21, Liquid temperature (°C): 21

**SATIMO Configuration:**

Probe: EP165; Calibrated: 01/31/2013

- Sensor-Surface: 4mm (Mechanical Surface Detection)
- Phantom: Flat Phantom; Type: Elliptical Phantom
- Measurement SW: OpenSAR V4\_02\_01

**Configuration/802.11b Mid- Touch-Right /Area Scan:** Measurement grid: dx=8mm, dy=8mm

**Configuration/802.11b Mid- Touch-Right /Zoom Scan:** Measurement grid: dx=8mm, dy=8mm, dz=5mm;

<b>Area Scan</b>	sam_direct_droit2_surf8mm.txt
<b>ZoomScan</b>	5x5x7,dx=8mm dy=8mm dz=5mm,Very fast
<b>Phantom</b>	Right head
<b>Device Position</b>	Cheek
<b>Band</b>	2450MHz
<b>Channels</b>	Middle
<b>Signal</b>	TDMA (Crest factor: 8.0)

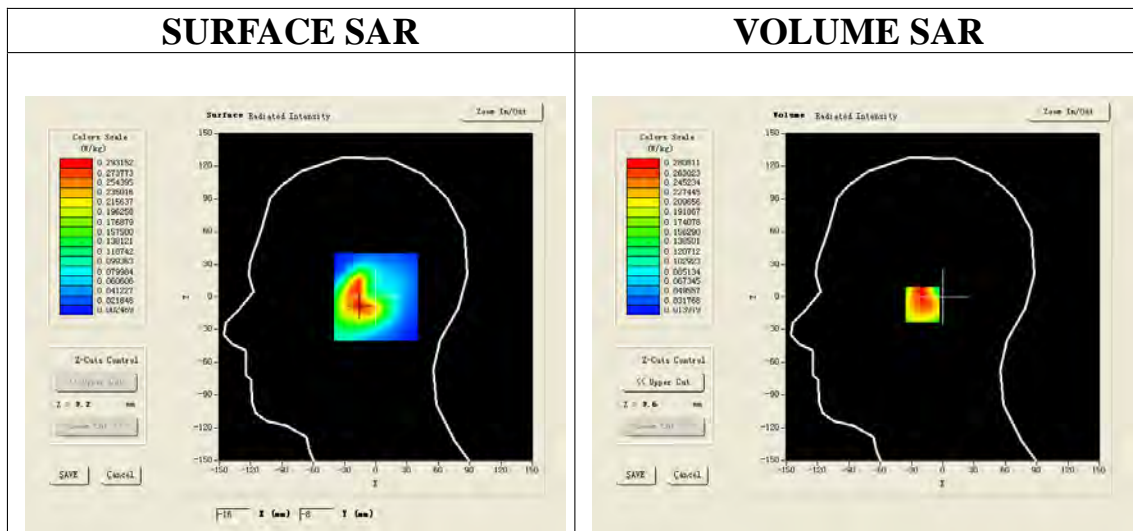

**Maximum location: X=-16.00, Y=-7.00**

<b>SAR 10g (W/Kg)</b>	0.164520
<b>SAR 1g (W/Kg)</b>	0.266895



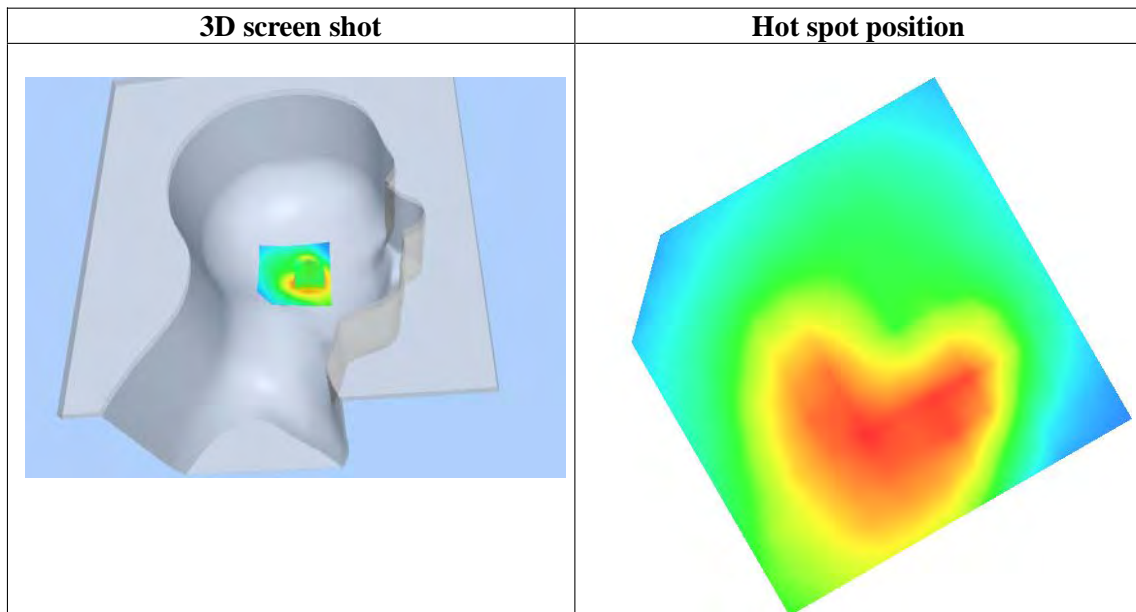
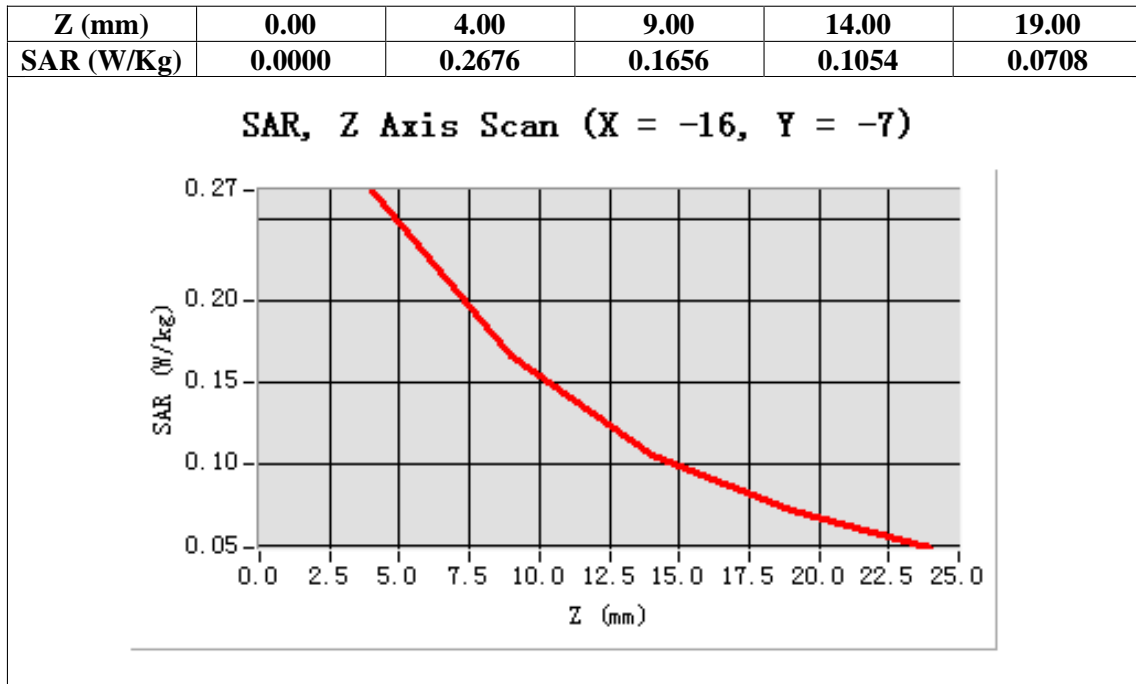

Test Laboratory: AGC Lab  
802.11b Mid-Tilt-Right  
**DUT: Smart Phone; Type: Syreni 40DC**

**Date: Dec.12, 2013**

Communication System: Wi-Fi; Communication System Band: 802.11b; Duty Cycle: 1:1; Conv.F=4.19;  
Frequency: 2437 MHz; Medium parameters used:  $f = 2450$  MHz;  $\sigma = 1.84$  mho/m;  $\epsilon_r = 38.54$ ;  $\rho = 1000$  kg/m<sup>3</sup> ;  
Phantom section: Right Section  
Ambient temperature (°C): 21, Liquid temperature (°C): 21

**SATIMO Configuration:**

Probe: EP165; Calibrated: 01/31/2013

- Sensor-Surface: 4mm (Mechanical Surface Detection)
- Phantom: Flat Phantom; Type: Elliptical Phantom
- Measurement SW: OpenSAR V4\_02\_01

**Configuration/802.11b Mid- Tilt-Right/Area Scan:** Measurement grid: dx=8mm, dy=8mm

**Configuration/802.11b Mid- Tilt-Right/Zoom Scan:** Measurement grid: dx=8mm, dy=8mm, dz=5mm;

<b>Area Scan</b>	sam_direct_droit2_surf8mm.txt
<b>Zoom Scan</b>	5x5x7,dx=8mm dy=8mm dz=5mm,Very fast
<b>Phantom</b>	Right head
<b>Device Position</b>	Tilt
<b>Band</b>	2450MHz
<b>Channels</b>	Middle
<b>Signal</b>	TDMA (Crest factor: 8.0)

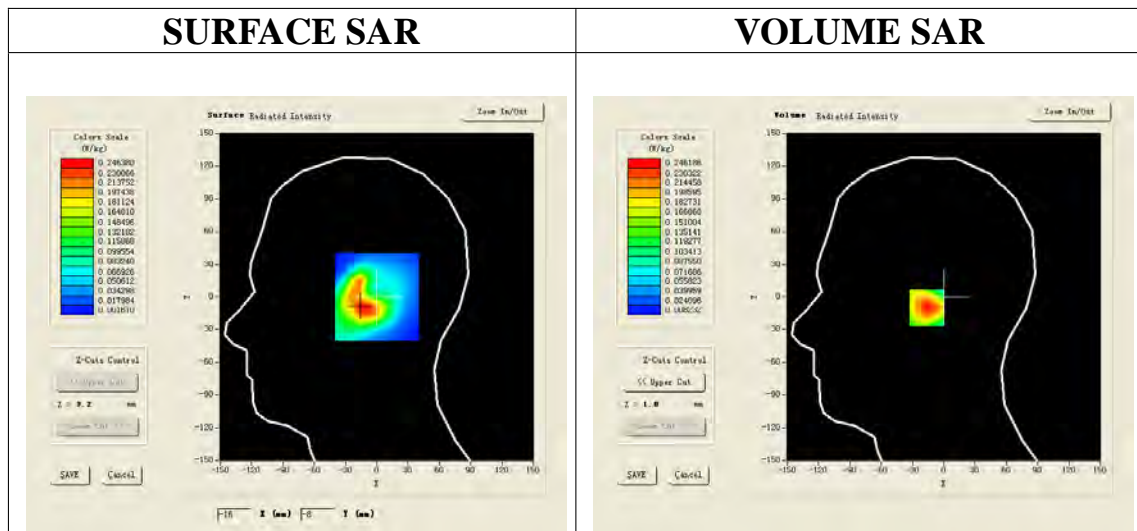

**Maximum location: X=-12.00, Y=-10.00**

<b>SAR 10g (W/Kg)</b>	0.127531
<b>SAR 1g (W/Kg)</b>	0.231658

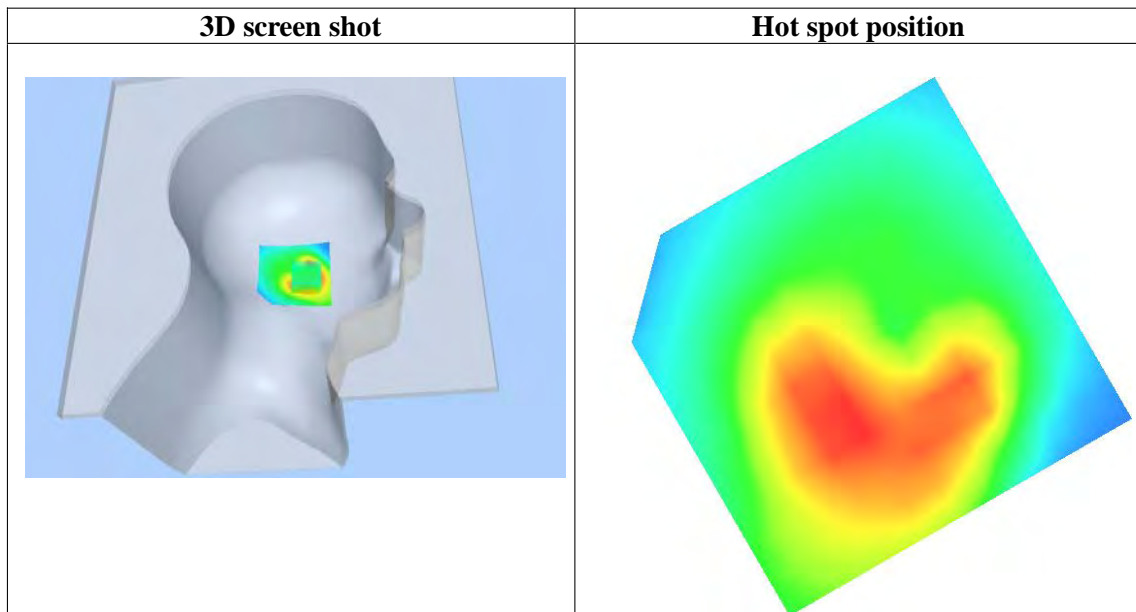
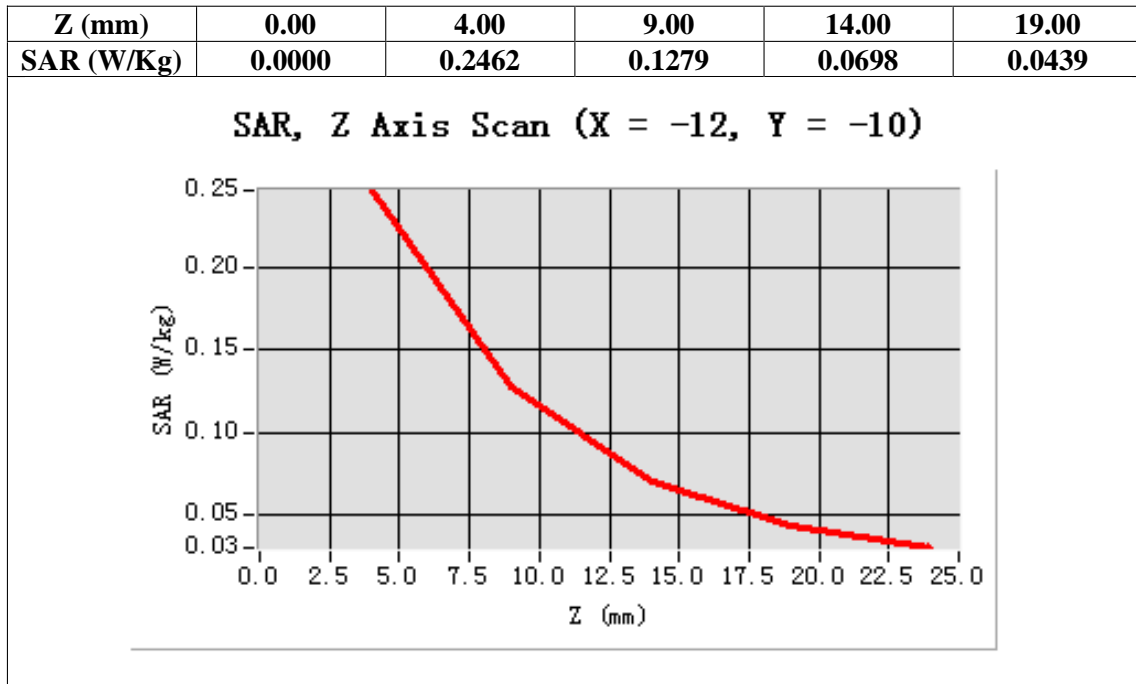

Test Laboratory: AGC Lab  
802.11b Mid-Body-Worn- Back (MS)  
**DUT: Smart Phone; Type: Syreni 40DC**

**Date: Dec.12, 2013**

Communication System: Wi-Fi; Communication System Band: 802.11b; Duty Cycle: 1:1; Conv.F=4.32;  
Frequency: 2437 MHz; Medium parameters used:  $f = 2450$  MHz;  $\sigma = 1.88$  mho/m;  $\epsilon_r = 53.45$ ;  $\rho = 1000$  kg/m<sup>3</sup> ;  
Phantom section: Flat Section  
Ambient temperature (°C):21, Liquid temperature (°C):21

**SATIMO Configuration:**

Probe: EP165; Calibrated: 01/31/2013

- Sensor-Surface: 4mm (Mechanical Surface Detection)
- Phantom: Flat Phantom; Type: Elliptical Phantom
- Measurement SW: OpenSAR V4\_02\_01

**Configuration/802.11b Mid- Body- Back /Area Scan (6x8x1):** Measurement grid: dx=8mm, dy=8mm  
**Configuration/802.11b Mid- Body- Back /Zoom Scan (5x5x7)/Cube 0:** Measurement grid: dx=8mm, dy=8mm, dz=5mm;

<b>Area Scan</b>	surf_sam_plan.txt
<b>ZoomScan</b>	5x5x7,dx=8mm dy=8mm dz=5mm,Very fast
<b>Phantom</b>	Validation plane
<b>Device Position</b>	Body Back
<b>Band</b>	2450MHz
<b>Channels</b>	Middle
<b>Signal</b>	TDMA (Crest factor: 8.0)

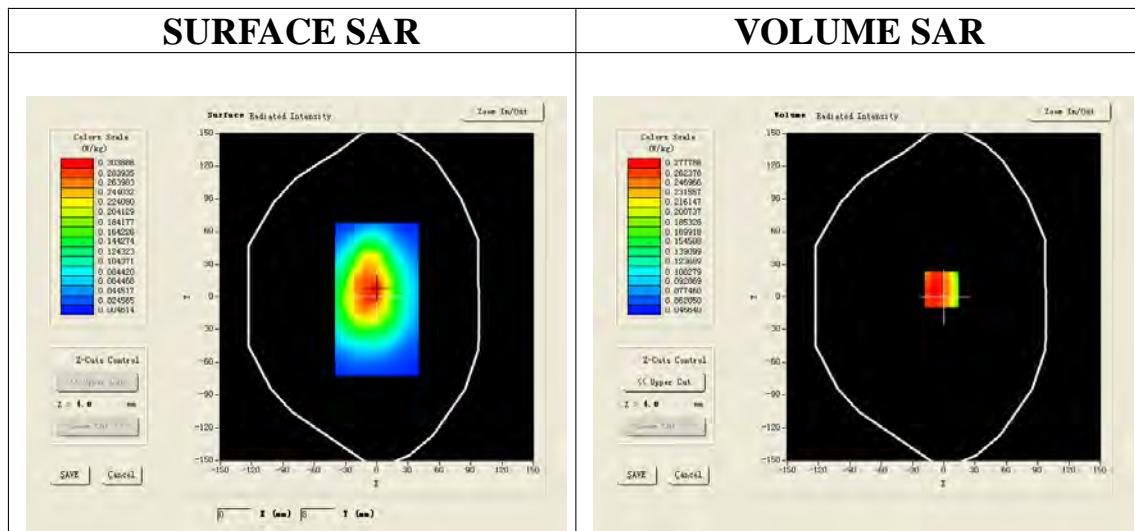

**Maximum location: X=-2.00, Y=7.00**

<b>SAR 10g (W/Kg)</b>	0.193356
<b>SAR 1g (W/Kg)</b>	0.267586

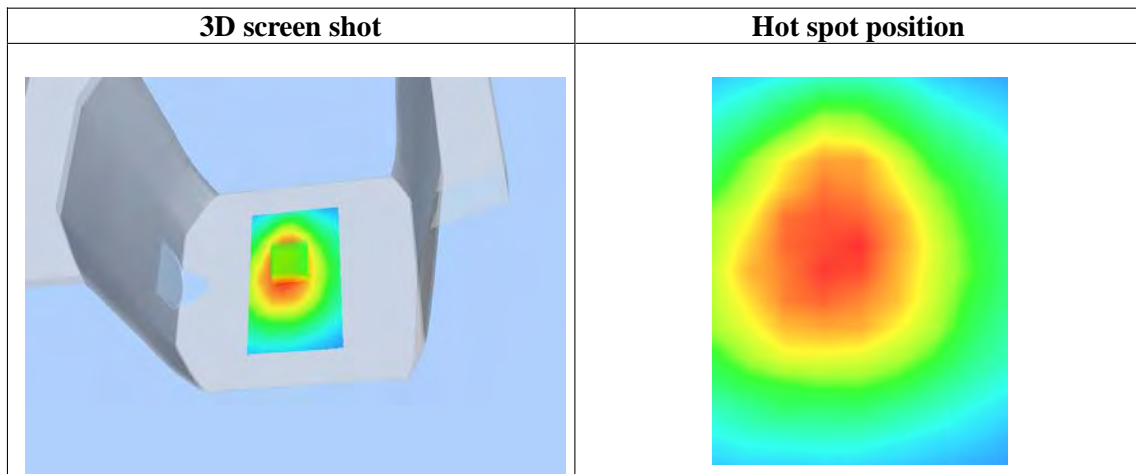
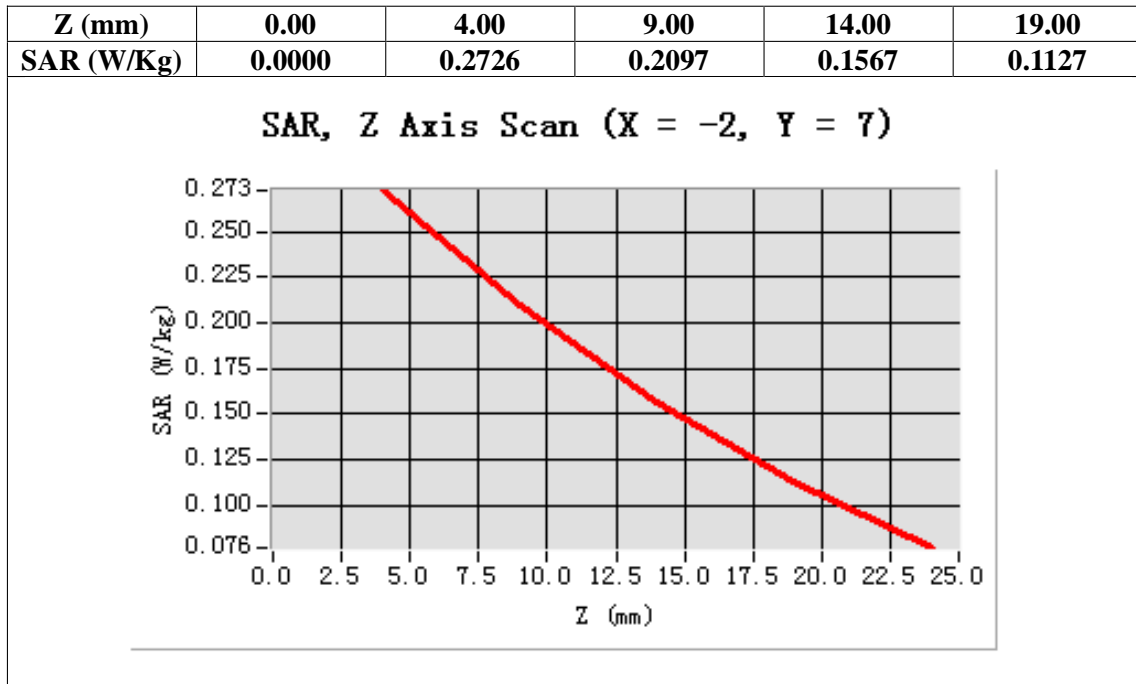

Test Laboratory: AGC Lab  
802.11b Mid-Body -Front (MS)  
**DUT: Smart Phone; Type: Syreni 40DC**

**Date: Dec.12, 2013**

Communication System: Wi-Fi; Communication System Band: 802.11b; Duty Cycle: 1:1; Conv.F=4.32;  
Frequency: 2437 MHz; Medium parameters used:  $f = 2450$  MHz;  $\sigma = 1.88$  mho/m;  $\epsilon_r = 53.45$ ;  $\rho = 1000$  kg/m<sup>3</sup> ;  
Phantom section: Flat Section  
Ambient temperature (°C):21, Liquid temperature (°C):21

**SATIMO Configuration:**

Probe: EP165; Calibrated: 01/31/2013

- Sensor-Surface: 4mm (Mechanical Surface Detection)
- Phantom: Flat Phantom; Type: Elliptical Phantom
- Measurement SW: OpenSAR V4\_02\_01

**Configuration/802.11b Mid-Body- Front /Area Scan:** Measurement grid: dx=8mm, dy=8mm

**Configuration/802.11b Mid-Body- Front /Zoom Scan:** Measurement grid: dx=8mm, dy=8mm, dz=5mm;

<b>Area Scan</b>	surf_sam_plan.txt
<b>ZoomScan</b>	5x5x7,dx=8mm dy=8mm dz=5mm,Very fast
<b>Phantom</b>	Validation plane
<b>Device Position</b>	Body Front
<b>Band</b>	2450MHz
<b>Channels</b>	Middle
<b>Signal</b>	TDMA (Crest factor: 8.0)

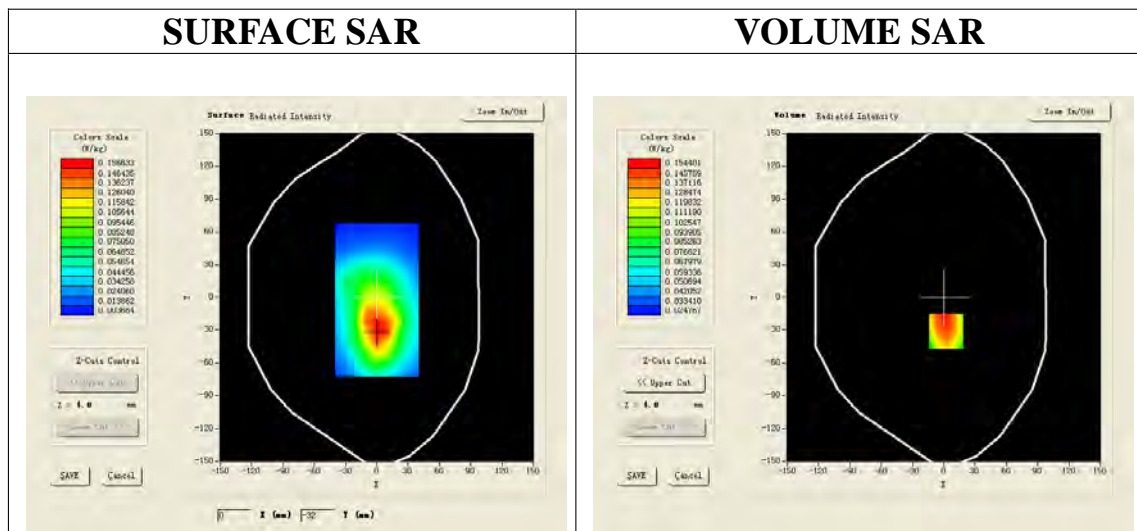

**Maximum location: X=2.00, Y=-31.00**

<b>SAR 10g (W/Kg)</b>	0.107356
<b>SAR 1g (W/Kg)</b>	0.155698

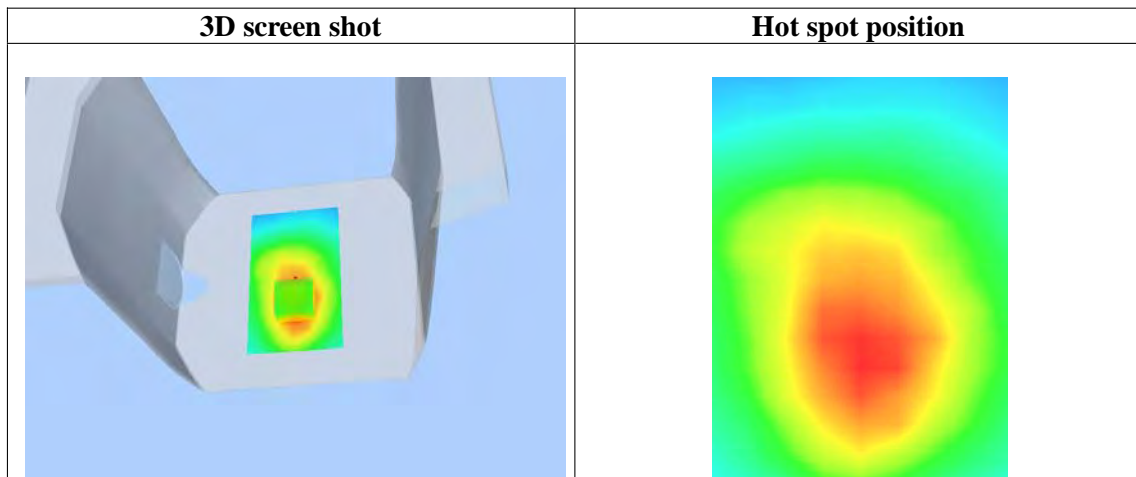
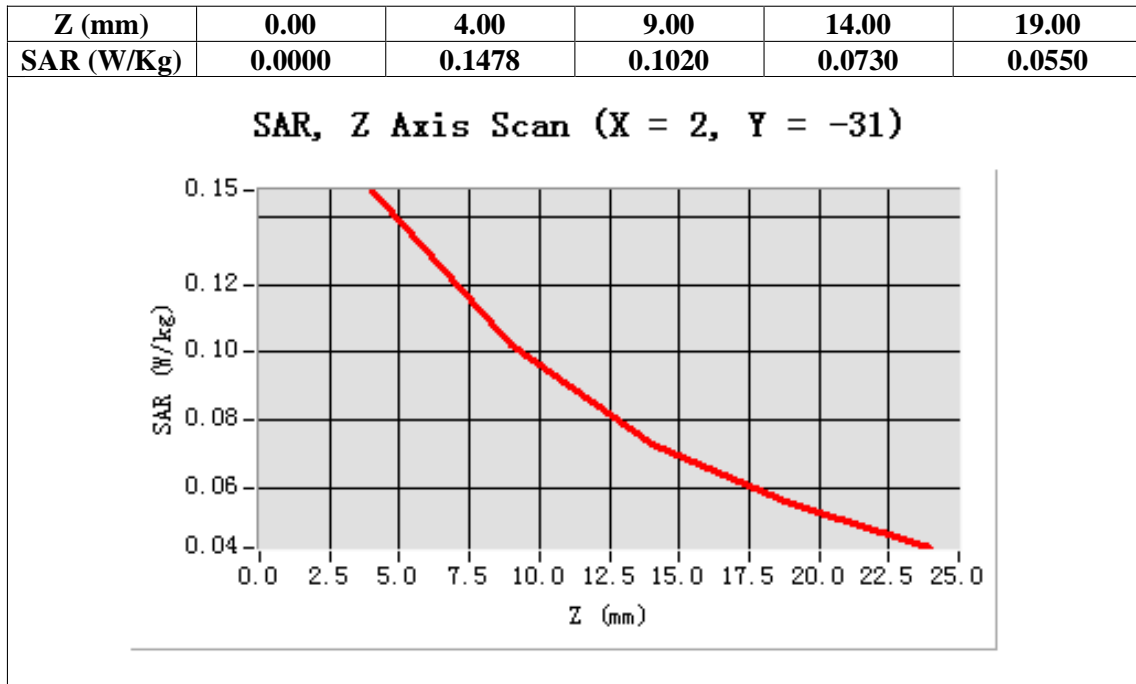



**HOTSPOT MODE**

Test Laboratory: AGC Lab

Hotspot Mid-Touch-Left

DUT: Smart Phone; Type: Syreni 40DC

Date: Dec.12, 2013

Communication System: Wi-Fi; Communication System Band: Hotspot; Duty Cycle: 1:1; Conv.F=4.19;  
Frequency: 2437 MHz; Medium parameters used:  $f = 2450$  MHz;  $\sigma = 1.84$  mho/m;  $\epsilon_r = 38.54$ ;  $\rho = 1000$  kg/m<sup>3</sup> ;  
Phantom section: Left Section  
Ambient temperature (°C): 21, Liquid temperature (°C): 21

SATIMO Configuration:

Probe: EP165; Calibrated: 01/31/2013

- Sensor-Surface: 4mm (Mechanical Surface Detection)
- Phantom: Flat Phantom; Type: Elliptical Phantom
- Measurement SW: OpenSAR V4\_02\_01

Configuration/Hotspot Mid- Touch-Left/Area Scan (6x8x1): Measurement grid: dx=8mm, dy=8mm  
Configuration/Hotspot Mid- Touch-Left/Zoom Scan (5x5x7)/Cube 0: Measurement grid: dx=8mm, dy=8mm, dz=5mm

Area Scan	sam_direct_droit2_surf8mm.txt
ZoomScan	5x5x7,dx=8mm dy=8mm dz=5mm,Very fast
Phantom	Left head
Device Position	Cheek
Band	2450MHz
Channels	Middle
Signal	TDMA (Crest factor: 8.0)

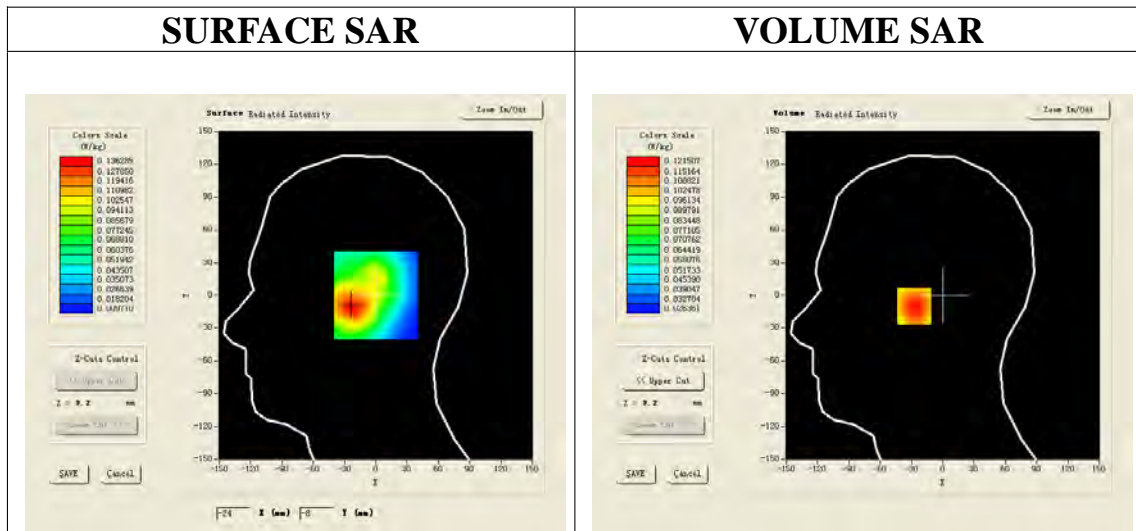

Maximum location: X=-24.00, Y=-10.00

SAR 10g (W/Kg)	0.083876
SAR 1g (W/Kg)	0.118937



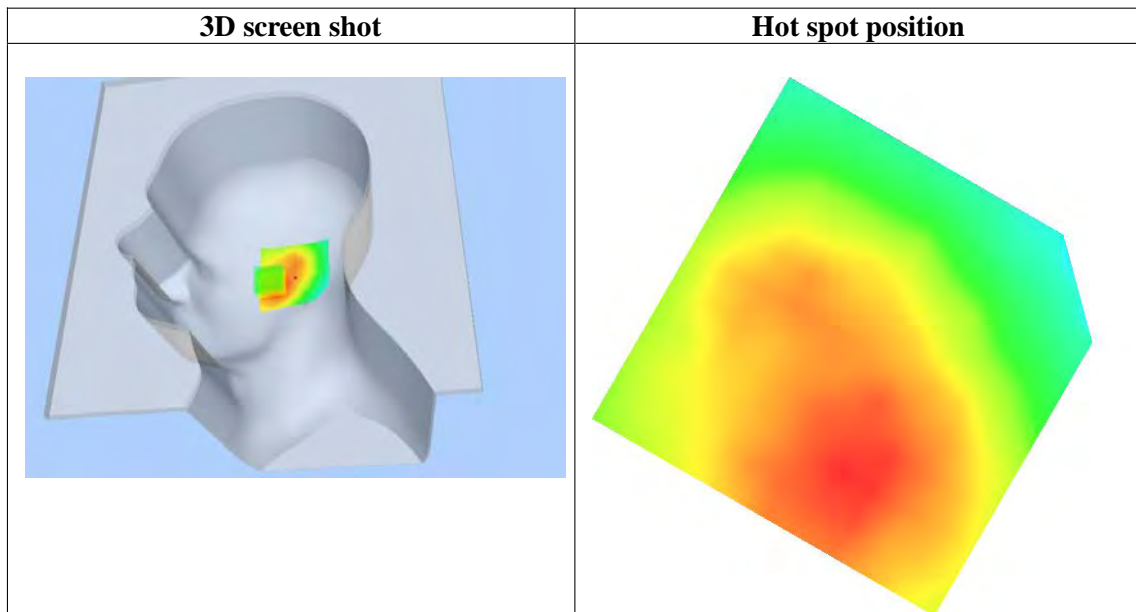
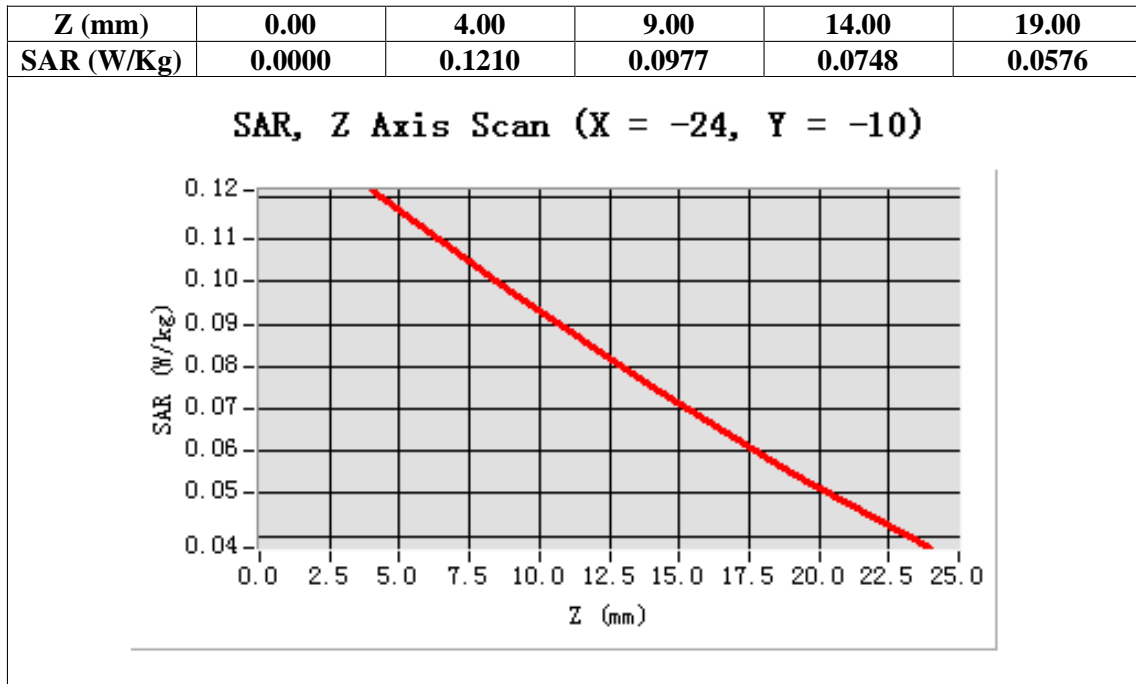

Test Laboratory: AGC Lab

Date: Dec.12, 2013

Hotspot Mid -Tilt-Left

DUT: Smart Phone; Type: Syreni 40DC

Communication System: Wi-Fi; Communication System Band: Hotspot; Duty Cycle: 1:1; Conv.F=4.19;  
Frequency: 2437 MHz; Medium parameters used:  $f = 2450$  MHz;  $\sigma = 1.84$  mho/m;  $\epsilon_r = 38.54$ ;  $\rho = 1000$  kg/m<sup>3</sup> ;  
Phantom section: Left Section  
Ambient temperature (°C): 21, Liquid temperature (°C): 21

SATIMO Configuration:

Probe: EP165; Calibrated: 01/31/2013

- Sensor-Surface: 4mm (Mechanical Surface Detection)
- Phantom: Flat Phantom; Type: Elliptical Phantom
- Measurement SW: OpenSAR V4\_02\_01

Configuration/Hotspot Mid- Tilt-Left/Area Scan (6x8x1): Measurement grid: dx=8mm, dy=8mm

Configuration/Hotspot Mid- Tilt-Left/Zoom Scan (5x5x7)/Cube 0: Measurement grid: dx=8mm, dy=8mm,dz=5mm;

<b>Area Scan</b>	sam_direct_droit2_surf8mm.txt
<b>ZoomScan</b>	5x5x7,dx=8mm dy=8mm dz=5mm,Very fast
<b>Phantom</b>	Left head
<b>Device Position</b>	Tilt
<b>Band</b>	2450MHz
<b>Channels</b>	Middle
<b>Signal</b>	TDMA (Crest factor: 8.0)

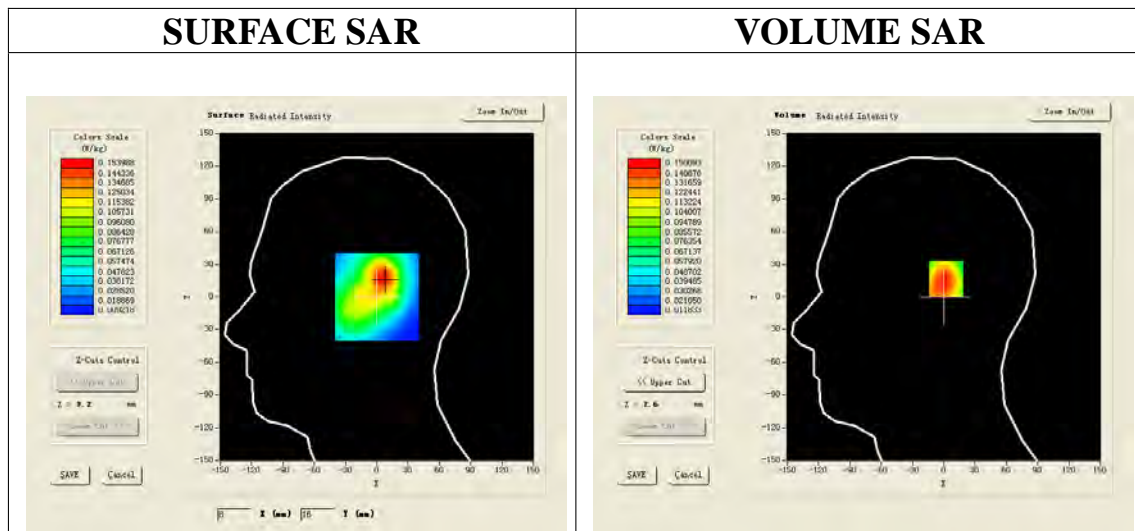

Maximum location: X=6.00, Y=17.00

<b>SAR 10g (W/Kg)</b>	0.093568
<b>SAR 1g (W/Kg)</b>	0.141536

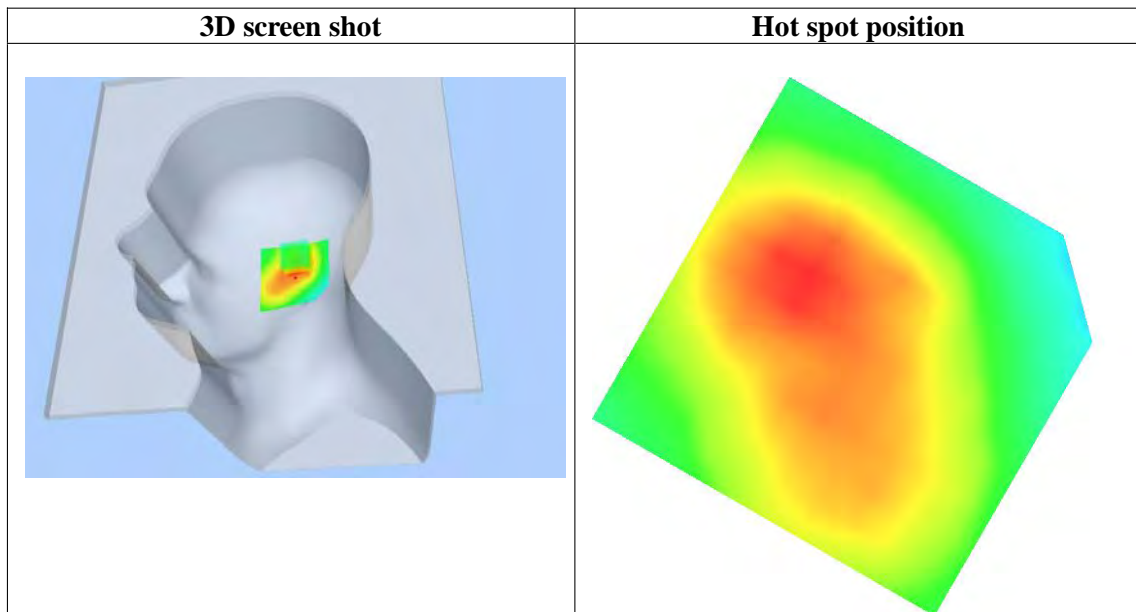
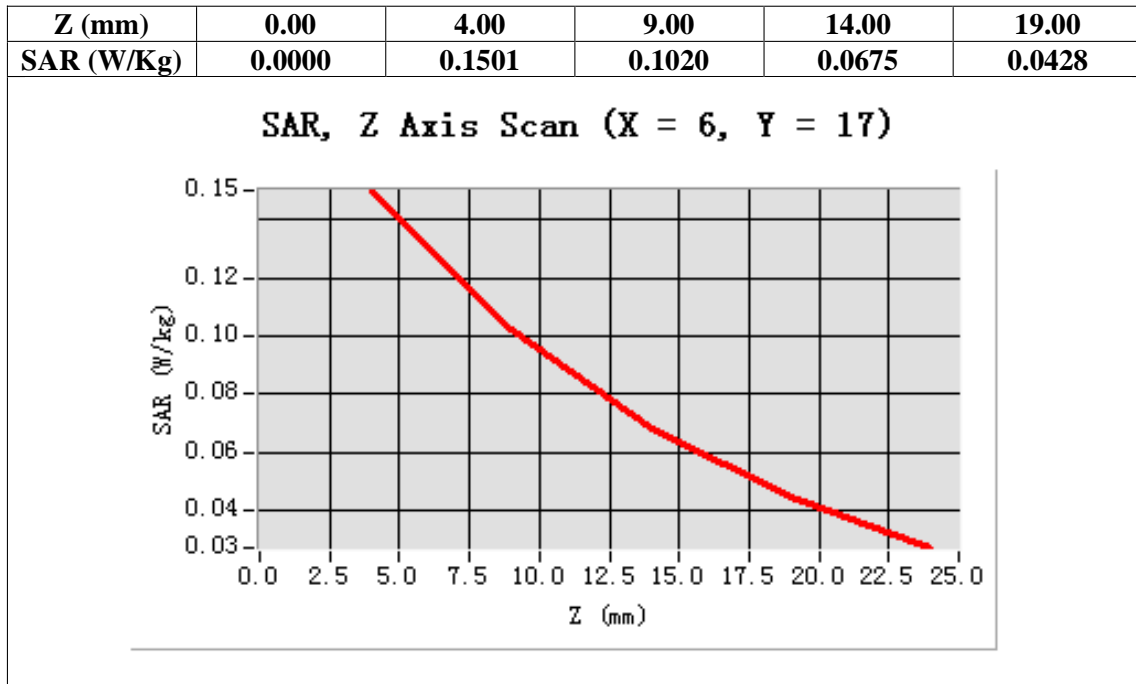

Test Laboratory: AGC Lab  
Hotspot Mid- Touch-Right  
**DUT: Smart Phone; Type: Syreni 40DC**

**Date: Dec.12, 2013**

Communication System: Wi-Fi; Communication System Band: Hotspot; Duty Cycle: 1:1; Conv.F=4.19;  
Frequency: 2437 MHz; Medium parameters used:  $f = 2450$  MHz;  $\sigma = 1.84$  mho/m;  $\epsilon_r = 38.54$ ;  $\rho = 1000$  kg/m<sup>3</sup> ;  
Phantom section: Right Section  
Ambient temperature (°C): 21, Liquid temperature (°C): 21

**SATIMO Configuration:**

Probe: EP165; Calibrated: 01/31/2013

- Sensor-Surface: 4mm (Mechanical Surface Detection)
- Phantom: Flat Phantom; Type: Elliptical Phantom
- Measurement SW: OpenSAR V4\_02\_01

**Configuration/Hotspot Mid- Touch-Right /Area Scan:** Measurement grid: dx=8mm, dy=8mm

**Configuration/Hotspot Mid- Touch-Right /Zoom Scan:** Measurement grid: dx=8mm, dy=8mm, dz=5mm;

<b>Area Scan</b>	sam_direct_droit2_surf8mm.txt
<b>ZoomScan</b>	5x5x7,dx=8mm dy=8mm dz=5mm,Very fast
<b>Phantom</b>	Right head
<b>Device Position</b>	Cheek
<b>Band</b>	2450MHz
<b>Channels</b>	Middle
<b>Signal</b>	TDMA (Crest factor: 8.0)

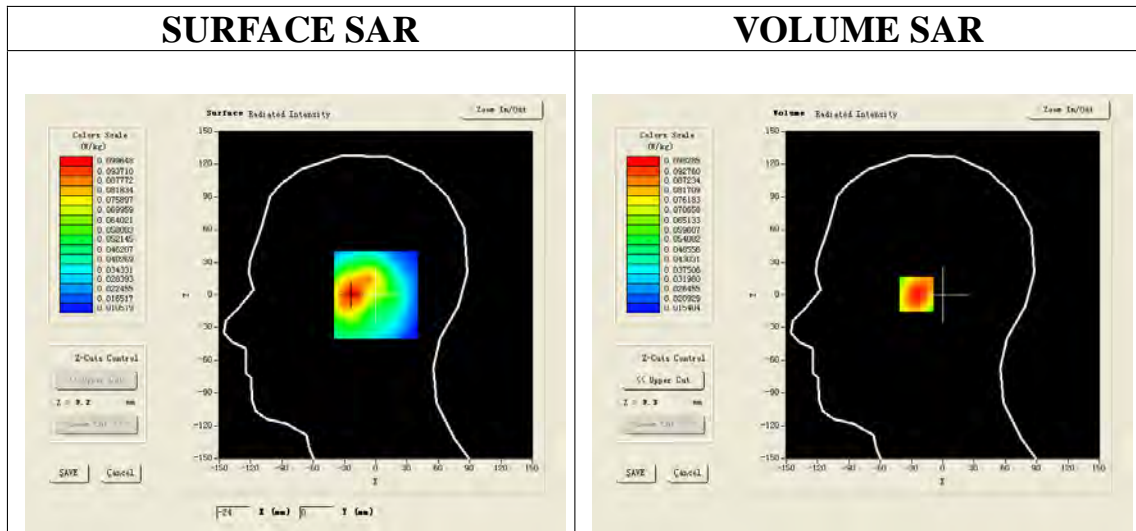

**Maximum location: X=-23.00, Y=1.00**

<b>SAR 10g (W/Kg)</b>	0.063868
<b>SAR 1g (W/Kg)</b>	0.096837

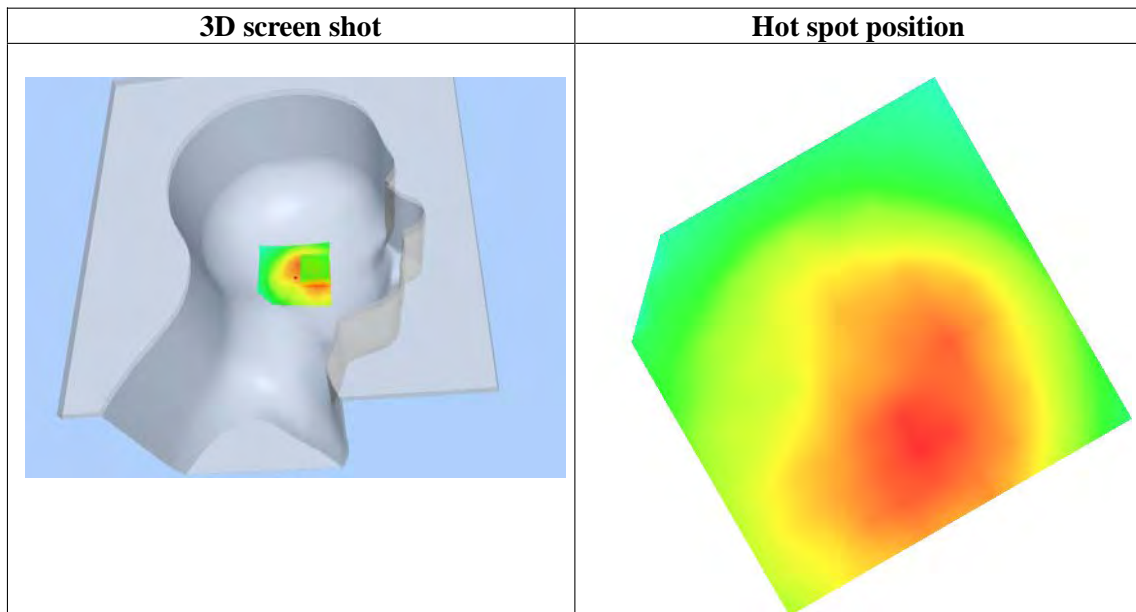
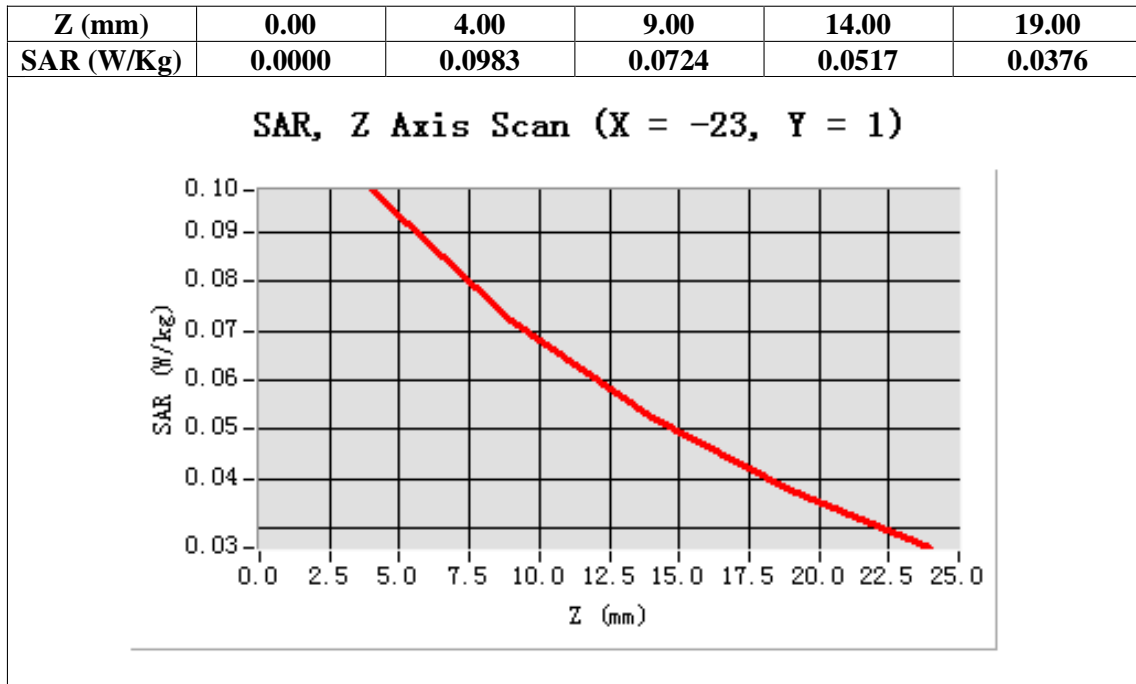

Test Laboratory: AGC Lab  
Hotspot Mid-Tilt-Right  
**DUT: Smart Phone; Type: Syreni 40DC**

**Date: Dec.12, 2013**

Communication System: Wi-Fi; Communication System Band: Hotspot; Duty Cycle: 1:1; Conv.F=4.19;  
Frequency: 2437 MHz; Medium parameters used:  $f = 2450$  MHz;  $\sigma = 1.84$  mho/m;  $\epsilon_r = 38.54$ ;  $\rho = 1000$  kg/m<sup>3</sup> ;  
Phantom section: Right Section  
Ambient temperature (°C): 21, Liquid temperature (°C): 21

**SATIMO Configuration:**

Probe: EP165; Calibrated: 01/31/2013

- Sensor-Surface: 4mm (Mechanical Surface Detection)
- Phantom: Flat Phantom; Type: Elliptical Phantom
- Measurement SW: OpenSAR V4\_02\_01

**Configuration/Hotspot Mid- Tilt-Right/Area Scan:** Measurement grid: dx=8mm, dy=8mm

**Configuration/Hotspot Mid- Tilt-Right/Zoom Scan:** Measurement grid: dx=8mm, dy=8mm, dz=5mm;

<b>Area Scan</b>	sam_direct_droit2_surf8mm.txt
<b>Zoom Scan</b>	5x5x7,dx=8mm dy=8mm dz=5mm,Very fast
<b>Phantom</b>	Right head
<b>Device Position</b>	Tilt
<b>Band</b>	2450MHz
<b>Channels</b>	Middle
<b>Signal</b>	TDMA (Crest factor: 8.0)

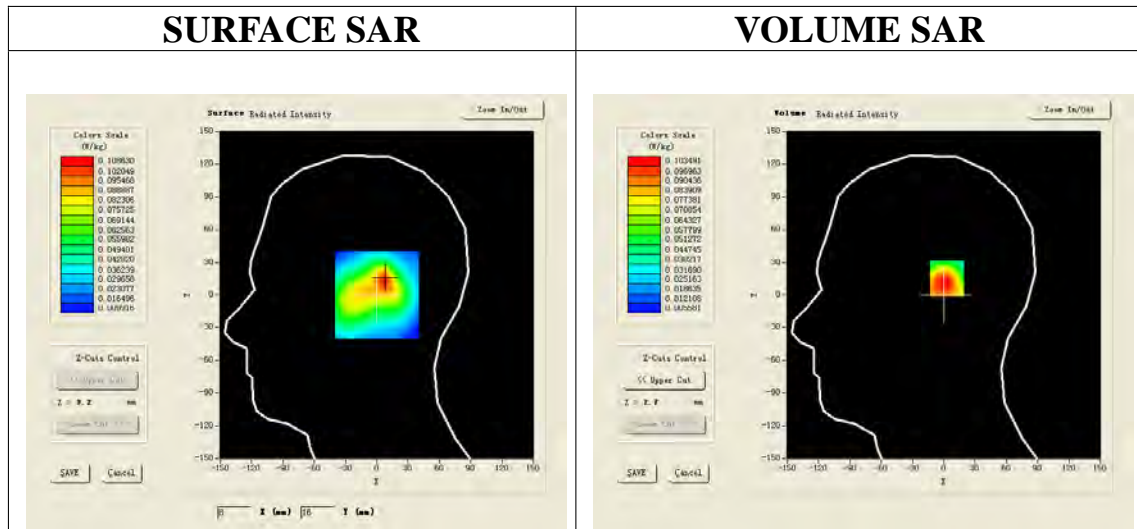

**Maximum location: X=7.00, Y=15.00**

<b>SAR 10g (W/Kg)</b>	0.064456
<b>SAR 1g (W/Kg)</b>	0.102569

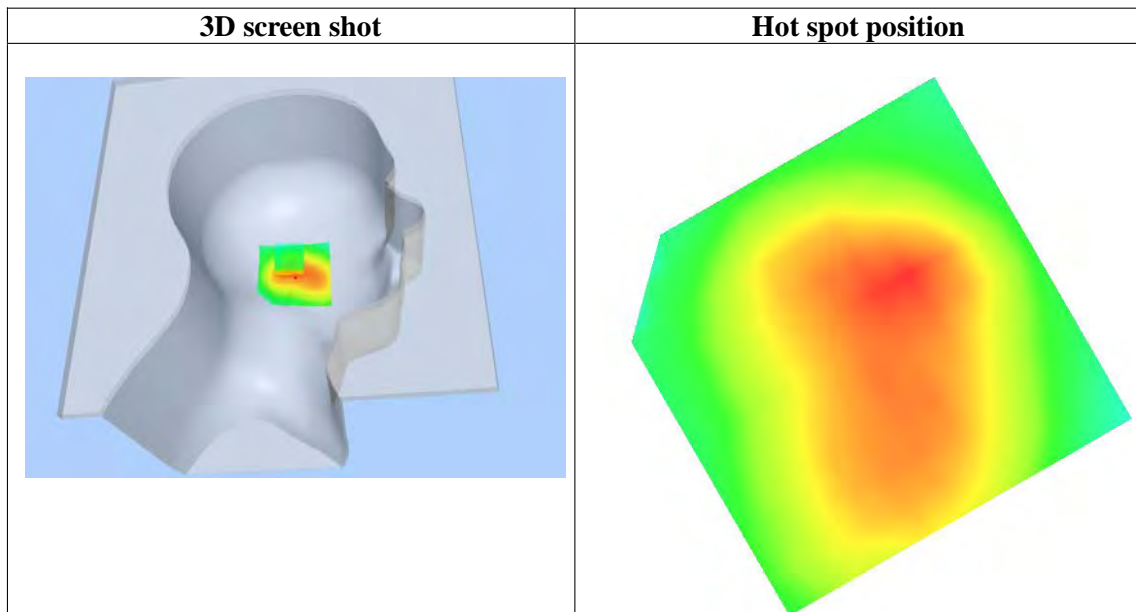
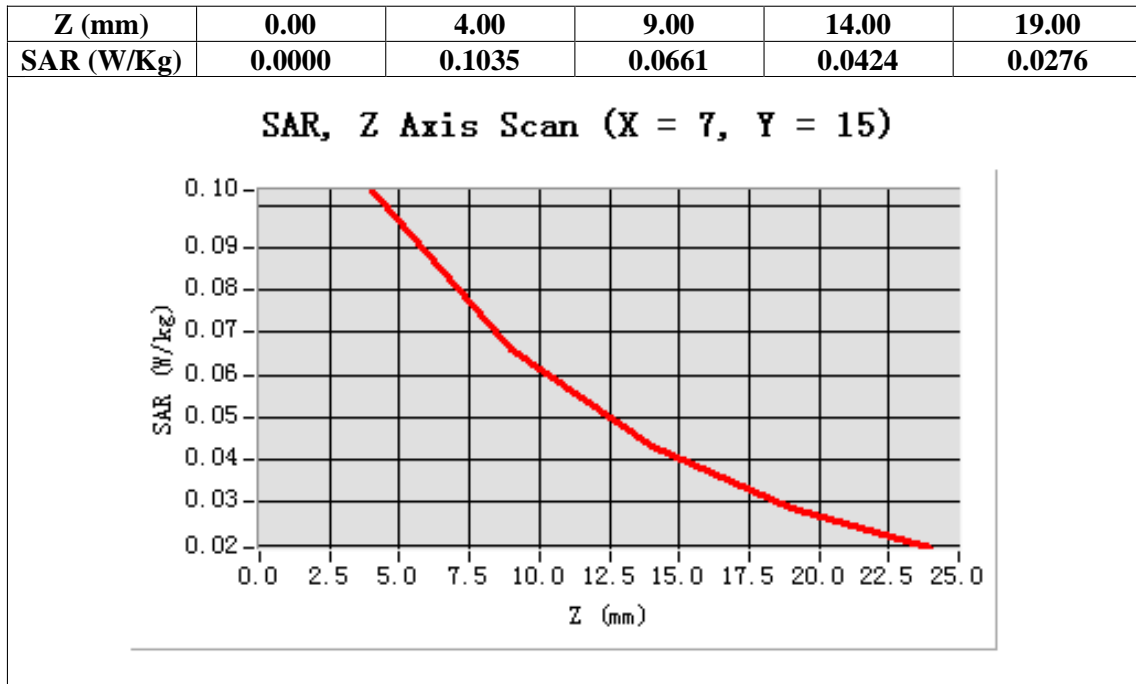



Test Laboratory: AGC Lab  
Hotspot Mid-Body-Worn- Back (MS)  
DUT: Smart Phone; Type: Syreni 40DC

Date: Dec.12, 2013

Communication System: Wi-Fi; Communication System Band: Hotspot; Duty Cycle: 1:1; Conv.F=4.32;  
Frequency: 2437 MHz; Medium parameters used:  $f = 2450$  MHz;  $\sigma = 1.88$  mho/m;  $\epsilon_r = 53.45$ ;  $\rho = 1000$  kg/m<sup>3</sup> ;  
Phantom section: Flat Section  
Ambient temperature (°C):21, Liquid temperature (°C):21

SATIMO Configuration:

Probe: EP165; Calibrated: 01/31/2013

- Sensor-Surface: 4mm (Mechanical Surface Detection)
- Phantom: Flat Phantom; Type: Elliptical Phantom
- Measurement SW: OpenSAR V4\_02\_01

Configuration/Hotspot Mid- Body- Back /Area Scan (6x8x1): Measurement grid: dx=8mm, dy=8mm  
Configuration/Hotspot Mid- Body- Back /Zoom Scan (5x5x7)/Cube 0: Measurement grid: dx=8mm, dy=8mm, dz=5mm;

Area Scan	surf_sam_plan.txt
ZoomScan	5x5x7,dx=8mm dy=8mm dz=5mm,Very fast
Phantom	Validation plane
Device Position	Body Back
Band	2450MHz
Channels	Middle
Signal	TDMA (Crest factor: 8.0)

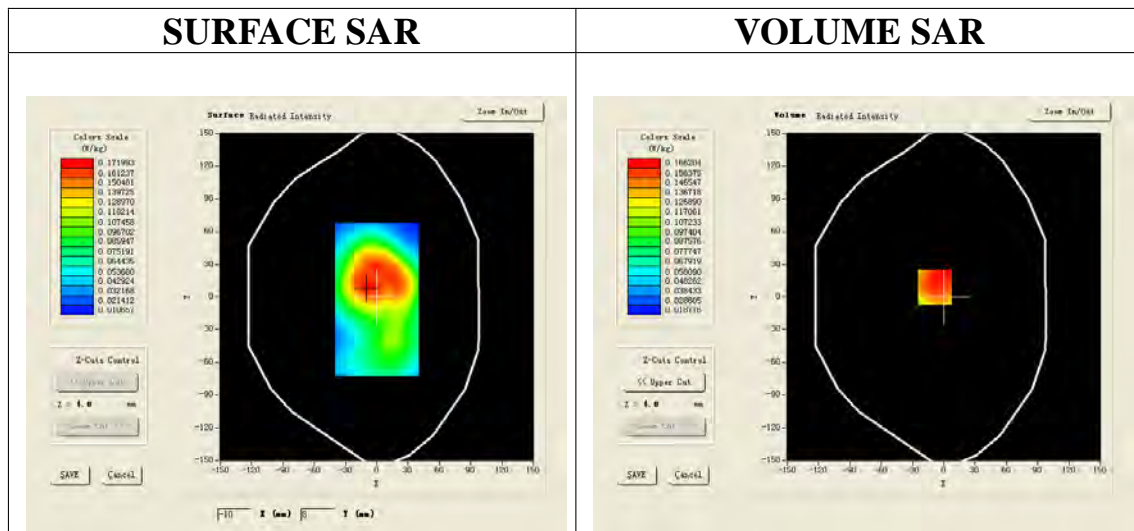

Maximum location: X=-9.00, Y=9.00

SAR 10g (W/Kg)	0.116837
SAR 1g (W/Kg)	0.174693



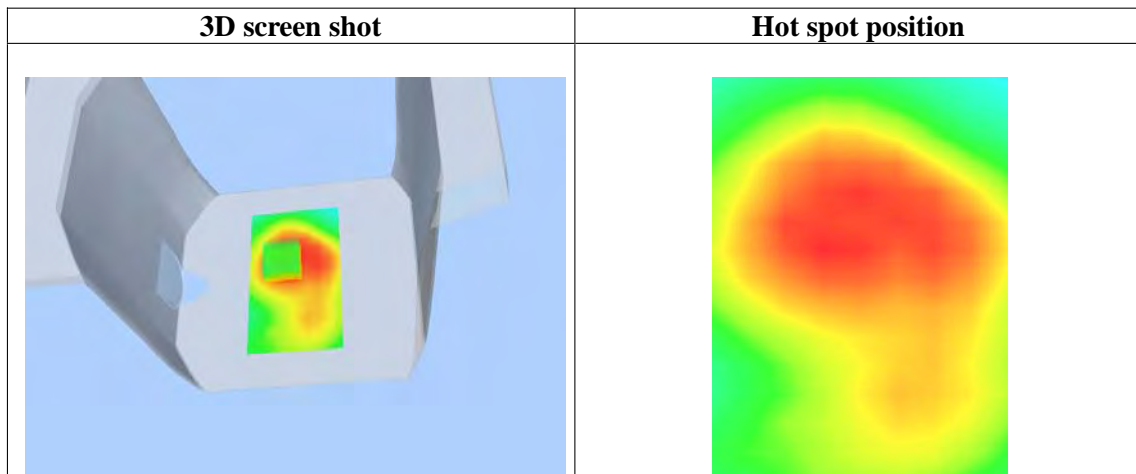
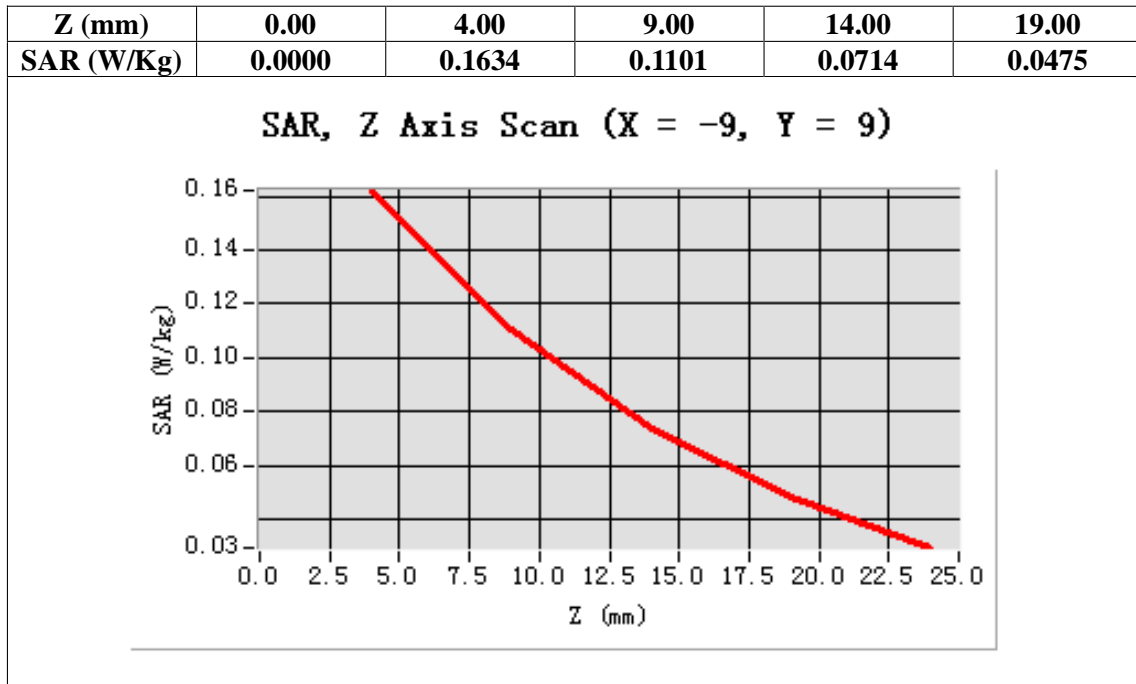

Test Laboratory: AGC Lab  
Hotspot Mid-Body -Front (MS)  
DUT: Smart Phone; Type: Syreni 40DC

Date: Dec.12, 2013

Communication System: Wi-Fi; Communication System Band: Hotspot; Duty Cycle: 1:1; Conv.F=4.32;  
Frequency: 2437 MHz; Medium parameters used:  $f = 2450$  MHz;  $\sigma = 1.88$  mho/m;  $\epsilon_r = 53.45$ ;  $\rho = 1000$  kg/m<sup>3</sup> ;  
Phantom section: Flat Section  
Ambient temperature (°C):21, Liquid temperature (°C):21

SATIMO Configuration:

- Probe: EP165; Calibrated: 01/31/2013
- Sensor-Surface: 4mm (Mechanical Surface Detection)
- Phantom: Flat Phantom; Type: Elliptical Phantom
- Measurement SW: OpenSAR V4\_02\_01

Configuration/Hotspot Mid-Body- Front /Area Scan: Measurement grid: dx=8mm, dy=8mm  
Configuration/Hotspot Mid-Body- Front /Zoom Scan: Measurement grid: dx=8mm, dy=8mm, dz=5mm;

Area Scan	surf_sam_plan.txt
ZoomScan	5x5x7,dx=8mm dy=8mm dz=5mm,Very fast
Phantom	Validation plane
Device Position	Body Front
Band	2450MHz
Channels	Middle
Signal	TDMA (Crest factor: 8.0)

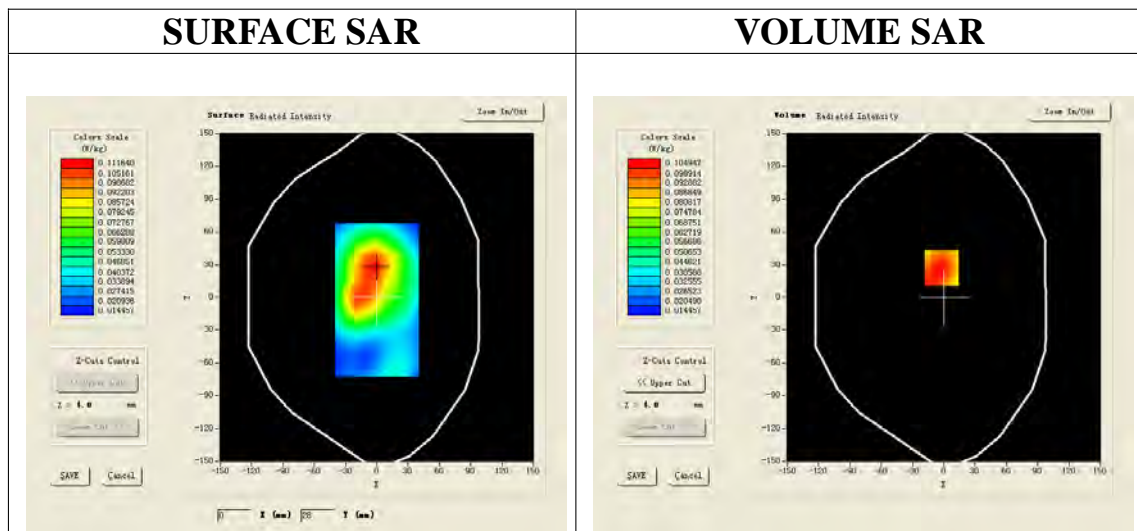

Maximum location: X=-2.00, Y=27.00

SAR 10g (W/Kg)	0.072256
SAR 1g (W/Kg)	0.108669

