



FEATURES AND BENEFITS

- Dual band antenna – 2.4 GHz and 5.5 GHz
- Quick and easy installation
- Adhesive holds to surface during humidity exposure and hot/cold cycles
- RoHS-compliant
- Can be installed in the following ways:
 - On different non-conductive surfaces and thicknesses
 - Near metals or the human body
 - On flat or curved surfaces

SPECIFICATIONS		
Frequency (MHz)	2400 - 2480	4900 - 5900
Peak Gain (dBi)	+2.5	+3.0
Average Gain (dBi)	> -2.5	> -3.4
VSWR (MHz)	<2.5:1	<3.0:1
Impedance (Ω)	50	
Antenna Type	Flexible Planar Inverted F (FlexPIFA)	
Polarization	Linear	

MECHANICAL SPECIFICATIONS		
Dimensions – mm (inches)	38.5 x 12.7 x 2.5 (1.52 x 0.5 x 0.098)	
Weight – g (oz.)	1.13 (0.040)	
Color	Clear yellow	
Adhesive	3M 100MP	
Connector Mating Height (max) – mm	MHF1 (U.FL)	2.5
	MHF4L	1.4

ENVIRONMENTAL SPECIFICATIONS	
Operating Temperature – °C (°F)	-40 to +85°C (-40 to +185°F)
Material Substance Compliance	RoHS

CONFIGURATION

PART NUMBER	CABLE LENGTH	CONNECTOR
001-0016	100 mm	U.FL
001-0021	100 mm	MHF4L
EFB2455A3S-16MHF1	160 mm	MHF4L

MECHANICAL DRAWING

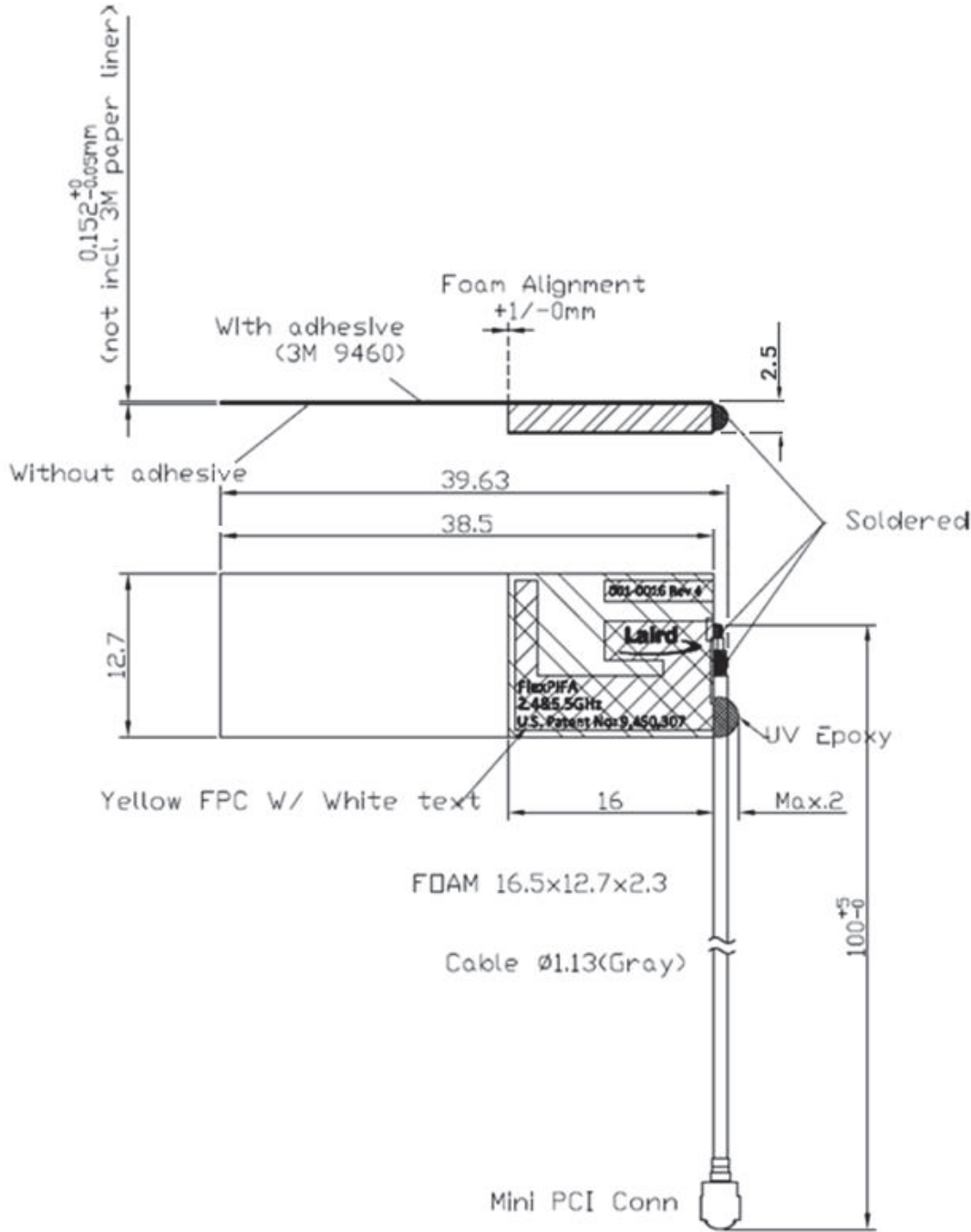

Figure 1: FlexPIFA mechanical drawing

TEST SETUP

Antenna measurements such as VSWR were measured with an Agilent E5071C vector network analyzer. Radiation patterns were measured with a CMT Planar 804/1 vector network analyzer in a Howland Company 3100 chamber equivalent. Phase center is nine inches above the Phi positioner.

Flat surface measurements were done with the antenna centered on a 1.5 mm-thick plate of polycarbonate. Curved surface measurements were taken by placing the antenna on the inside and outside of different diameter PVC tubing.

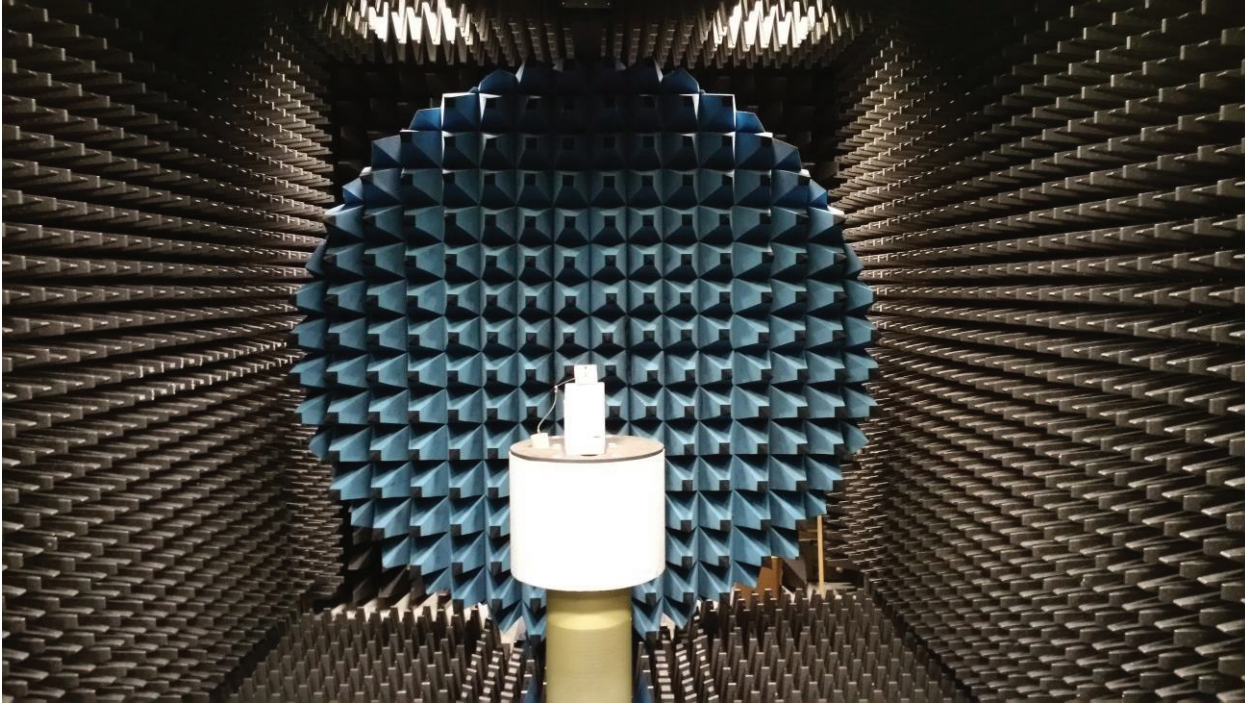

Figure 2: Antenna chamber

FLAT SURFACE ANTENNA MEASUREMENTS

Return Loss

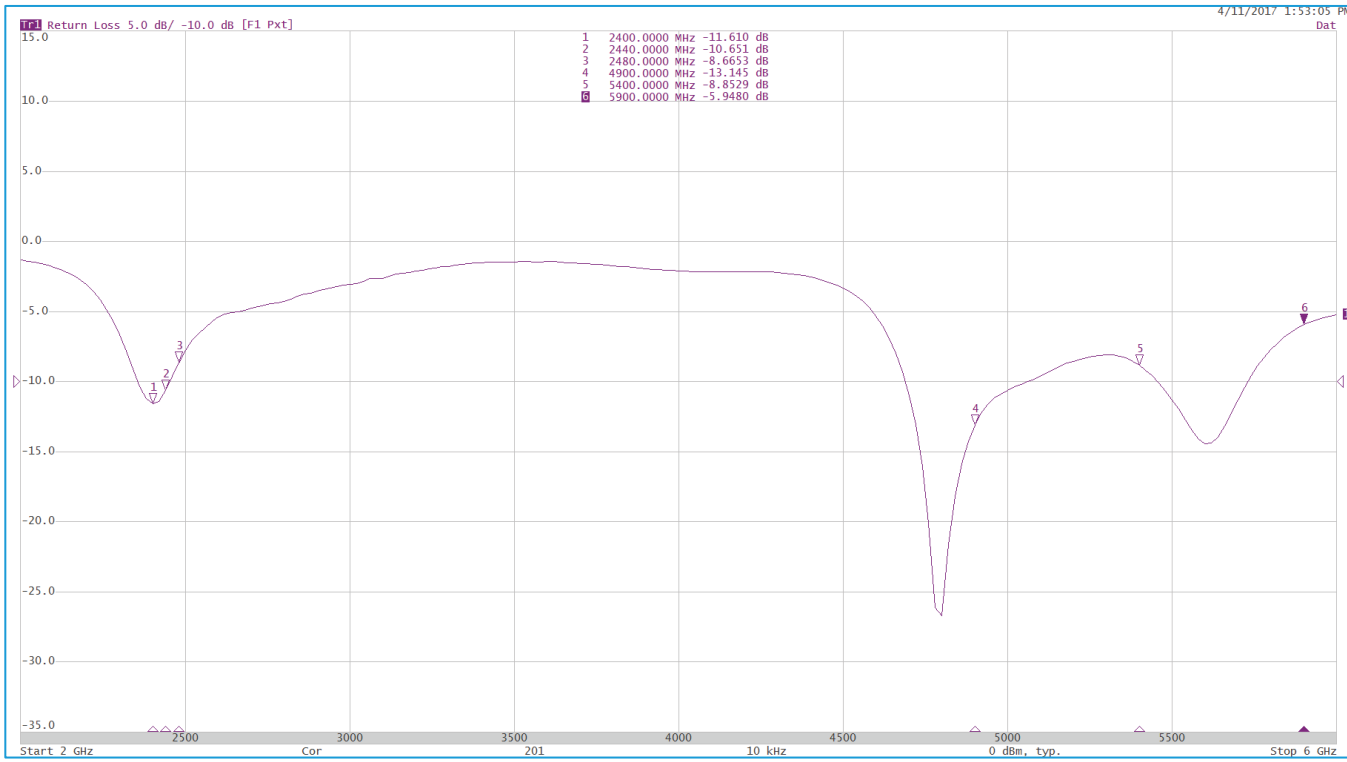

Figure 3: Antenna RL measured on a 1.5 mm-thick plate of polycarbonate

FLAT SURFACE ANTENNA RADIATION PERFORMANCE

FlexPIFA centered on a 1.5 mm-thick plate of polycarbonate

Antenna Measurement Set-Up

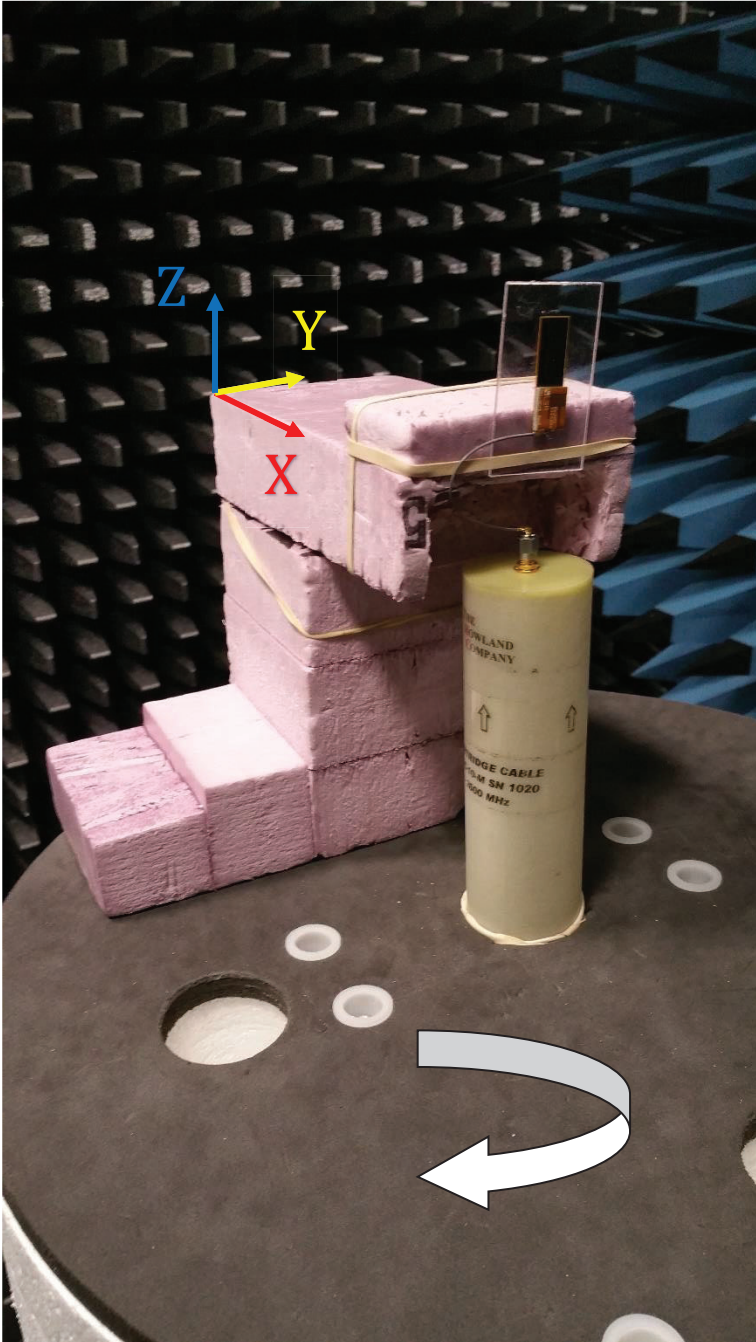

Figure 4: Flat surface setup

2.4 GHz Band

Azimuthal Conical Cuts at 2440 MHz

Azimuth Gain Pattern Cuts - Total Gain at 2440 MHz

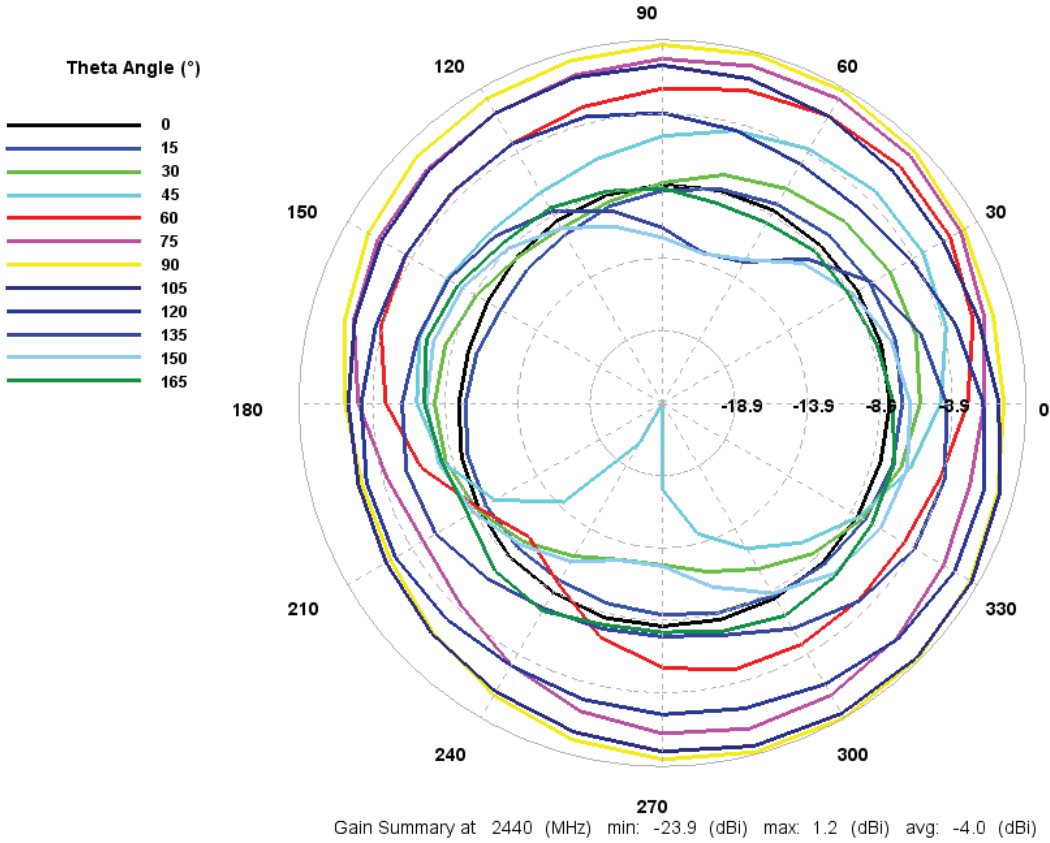

Figure 5: Total gain pattern

3D Plots at 2440 MHz

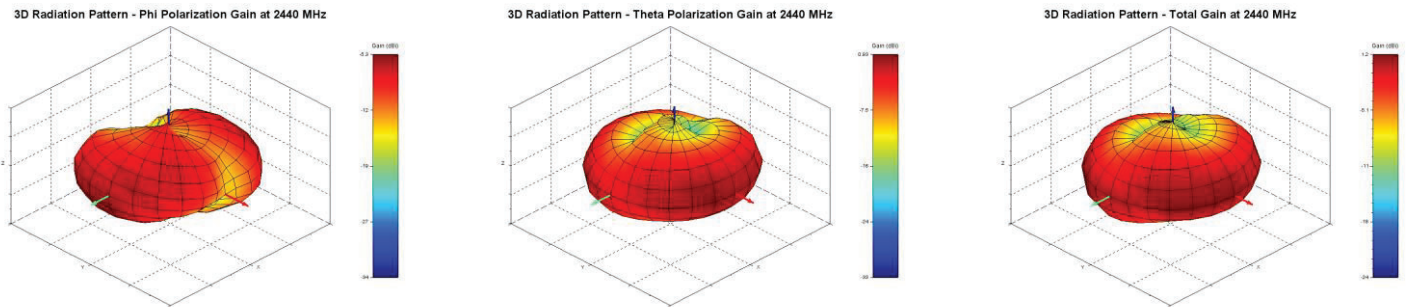

Figure 6: Phi, Theta, and total gain plots

5 GHz Band

Azimuthal Conical Cuts at 4900 MHz

Azimuth Gain Pattern Cuts - Total Gain at 4900 MHz

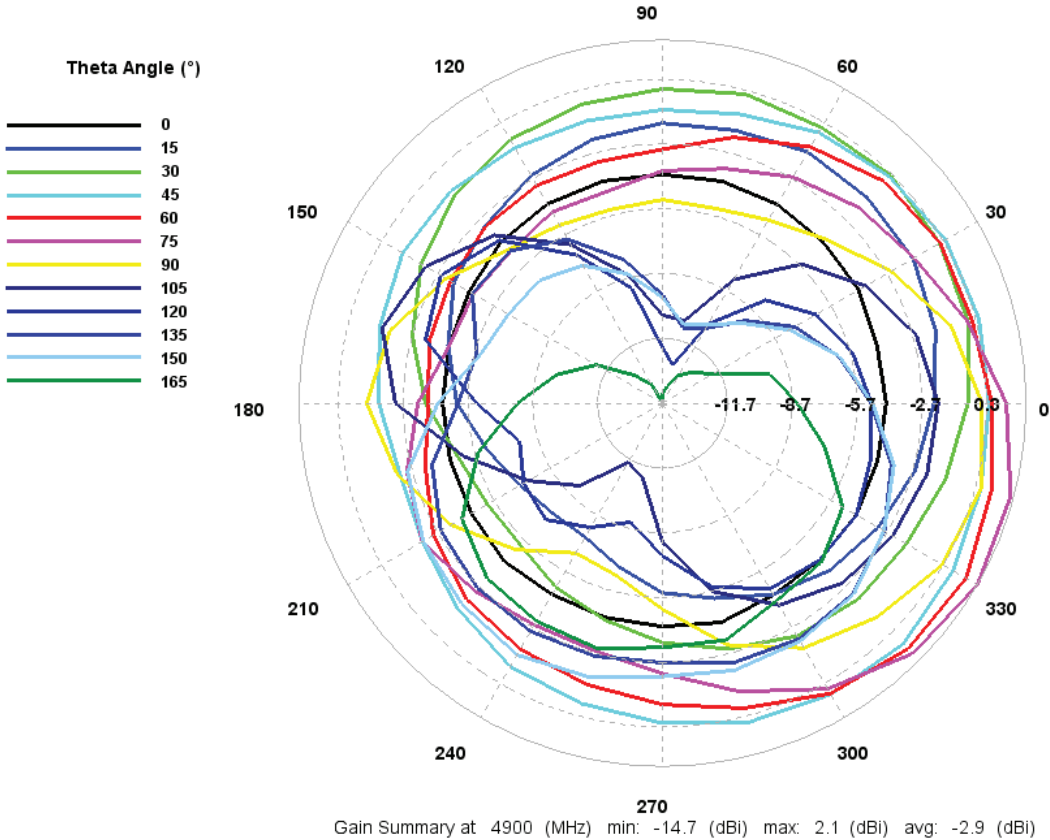

Figure 7: Total gain pattern

3D Plots at 4900 MHz

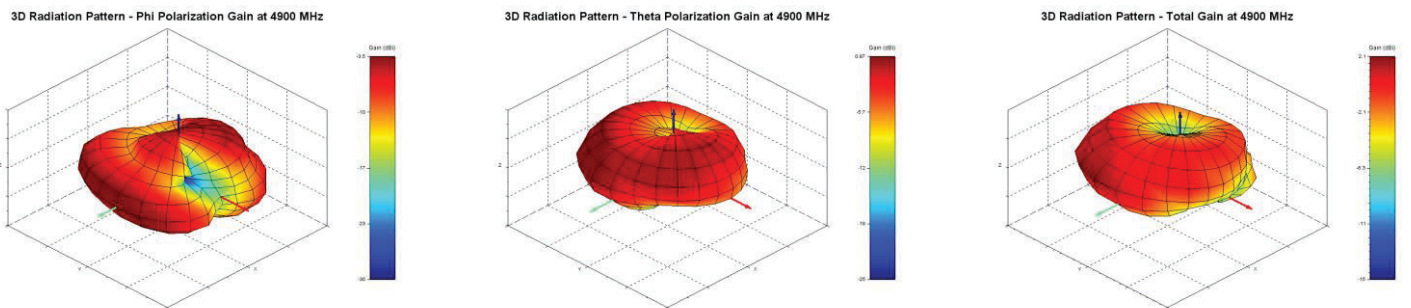

Figure 8: Phi, Theta, and total gain plots

Azimuthal Conical Cuts at 5400 MHz

Azimuth Gain Pattern Cuts - Total Gain at 5400 MHz

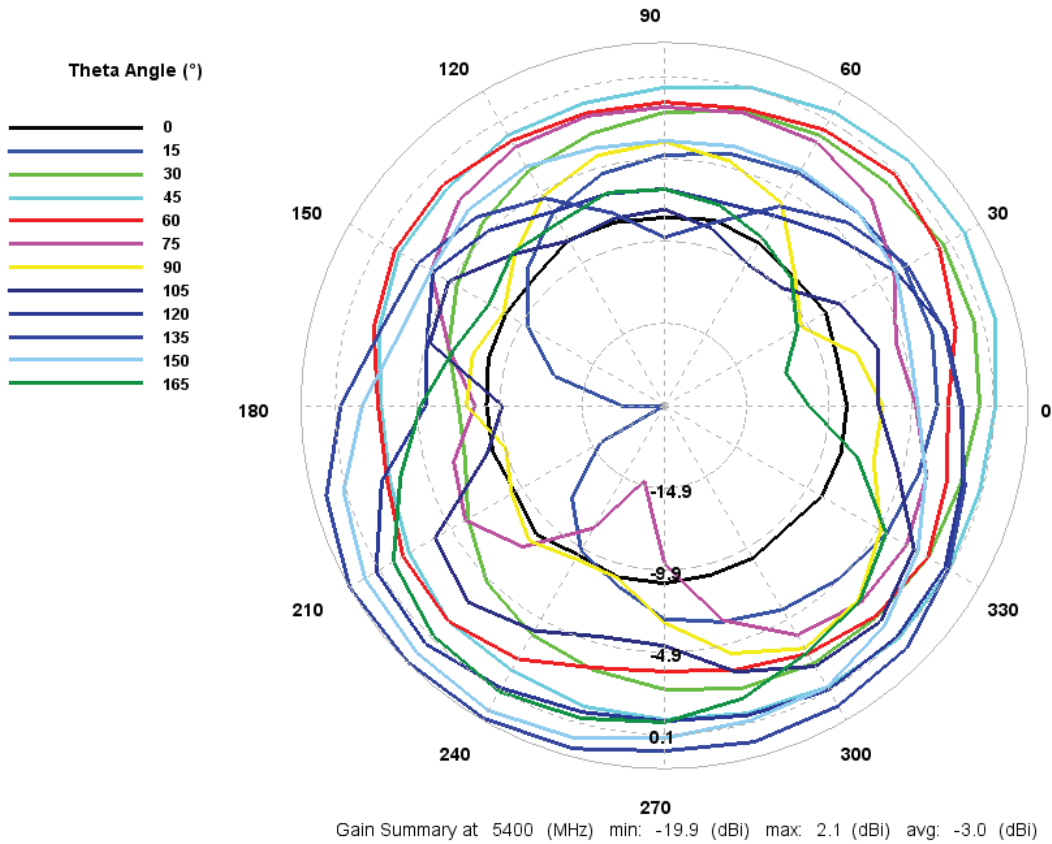

Figure 9: Total gain pattern

3D Plots at 5400 MHz

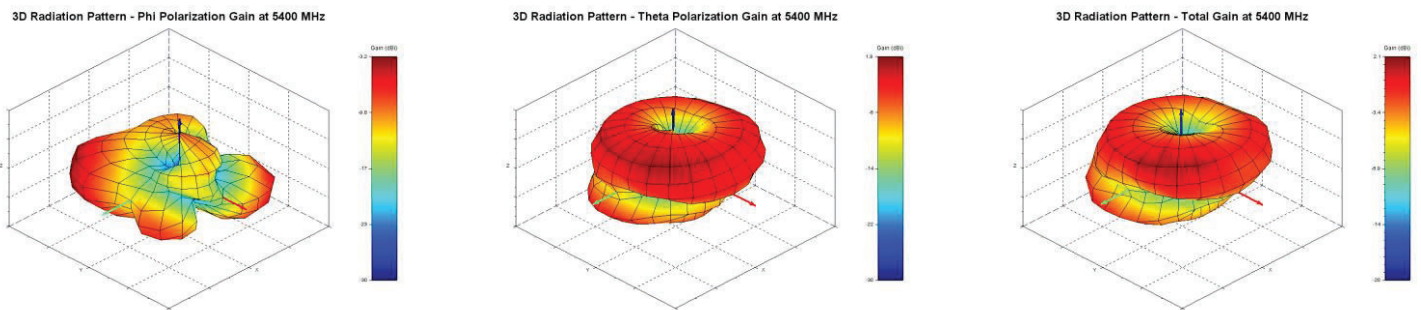

Figure 10: Phi, Theta, and total gain plots

Azimuthal Conical Cuts at 5900 MHz

Azimuth Gain Pattern Cuts - Total Gain at 5900 MHz

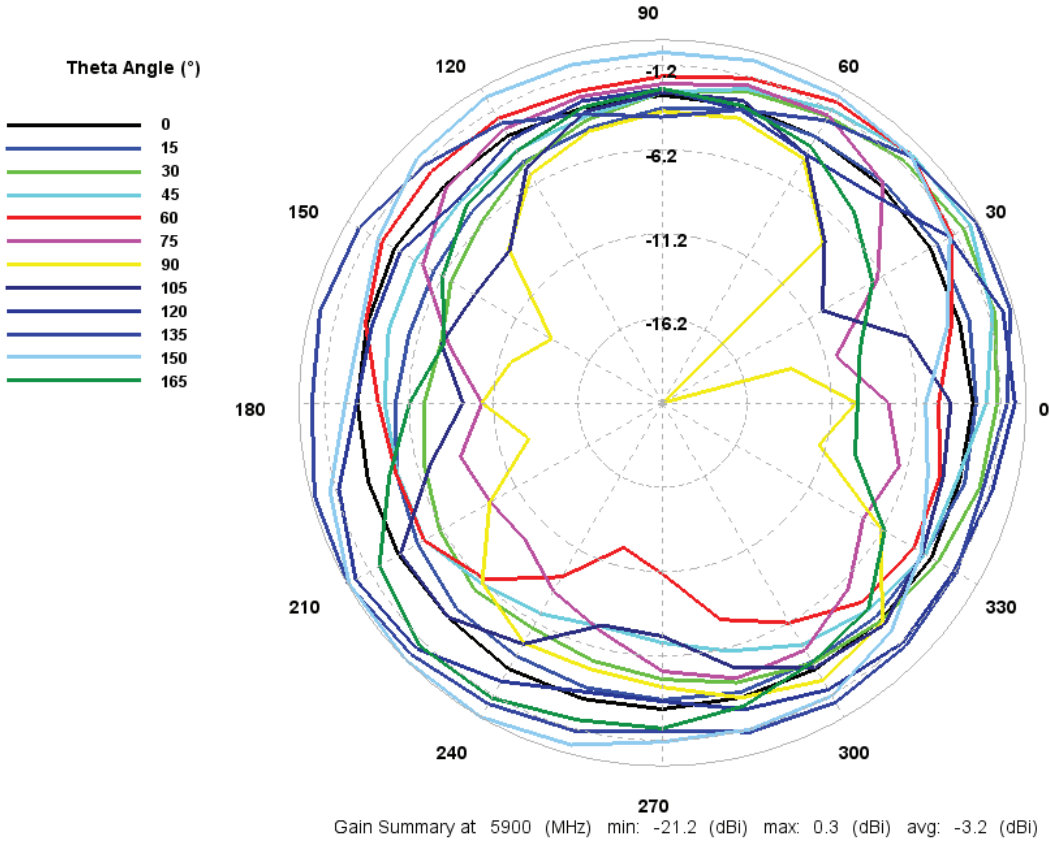

Figure 11: Total gain pattern

3D Plots at 5900 MHz

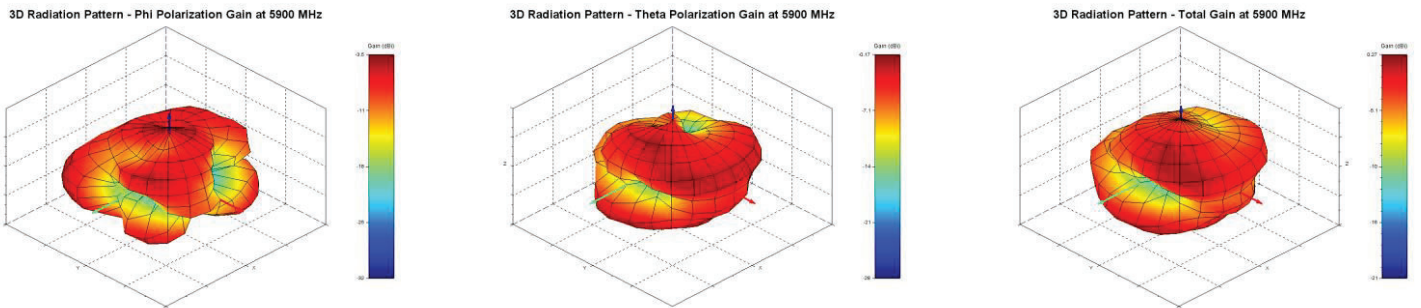

Figure 12: Phi, Theta, and total gain plots

CURVED SURFACE ANTENNA RADIATION PERFORMANCE

FlexPIFA outside 60 mm outer diameter PVC tube

Antenna Measurement Set-Up

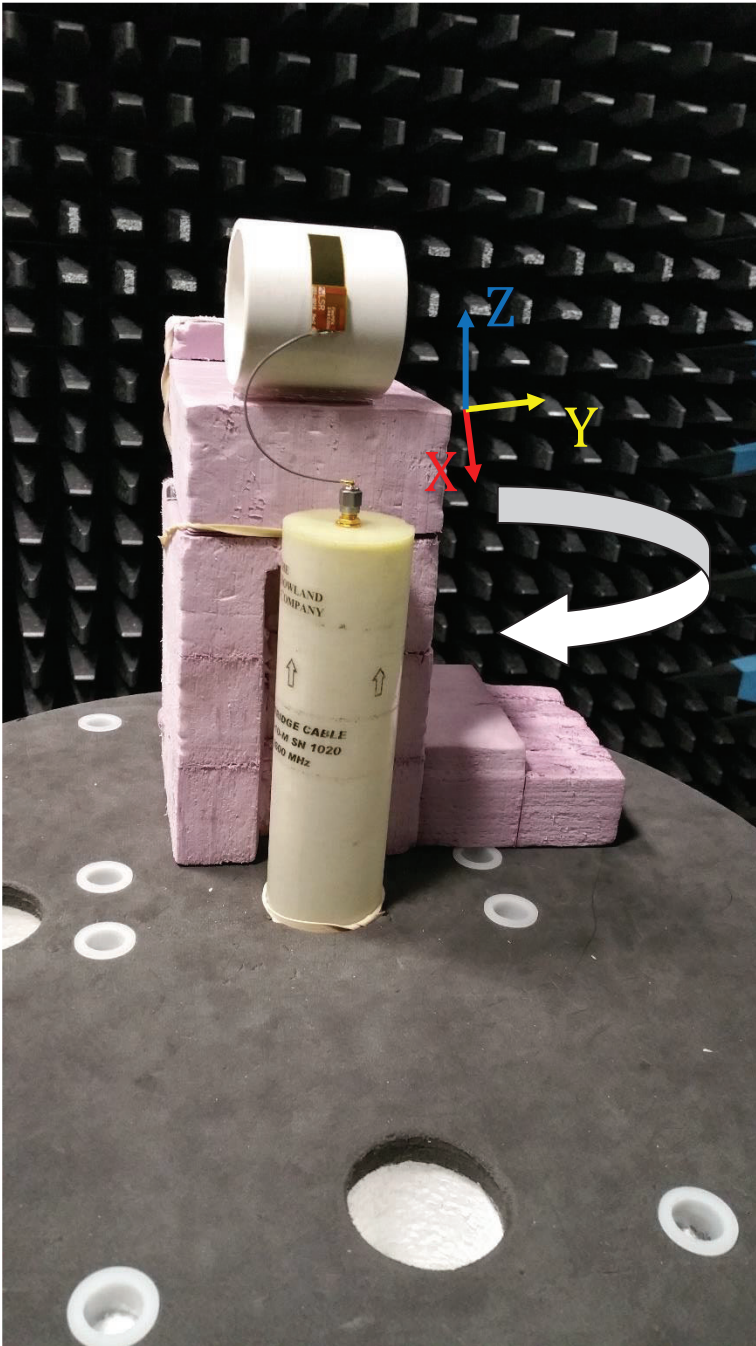

Figure 13: Outer diameter setup

2.4 GHz Band

Azimuthal Conical Cuts at 2440 MHz

Azimuth Gain Pattern Cuts - Total Gain at 2440 MHz

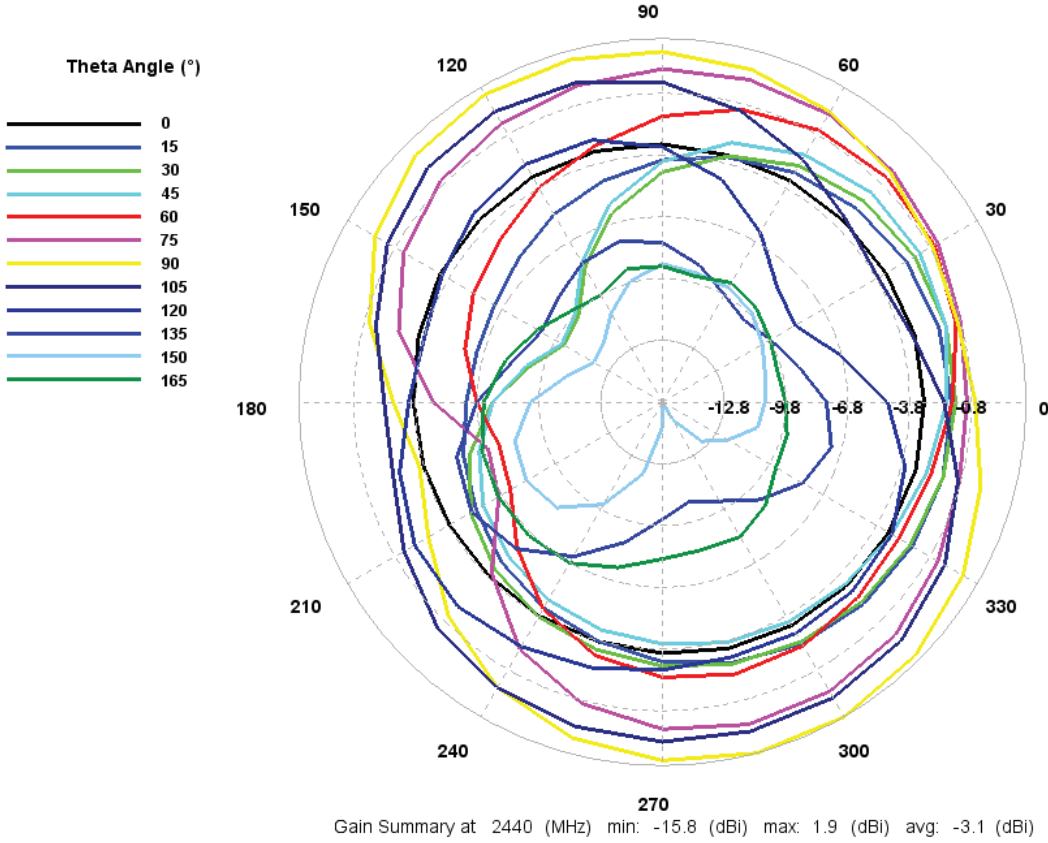

Figure 14: Total gain pattern

3D Plots at 2440 MHz

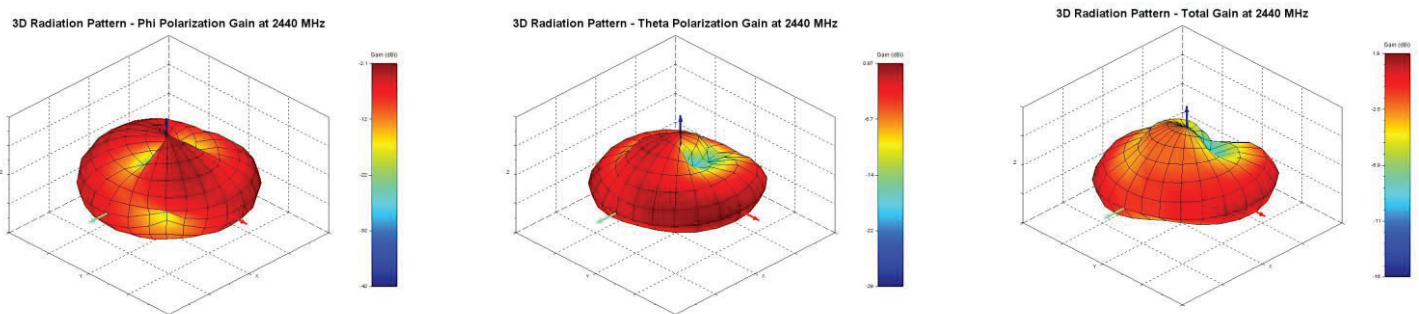

Figure 15: Phi, Theta, and total gain plots

5 GHz Band

Azimuthal Conical Cuts at 4900 MHz

Azimuth Gain Pattern Cuts - Total Gain at 4900 MHz

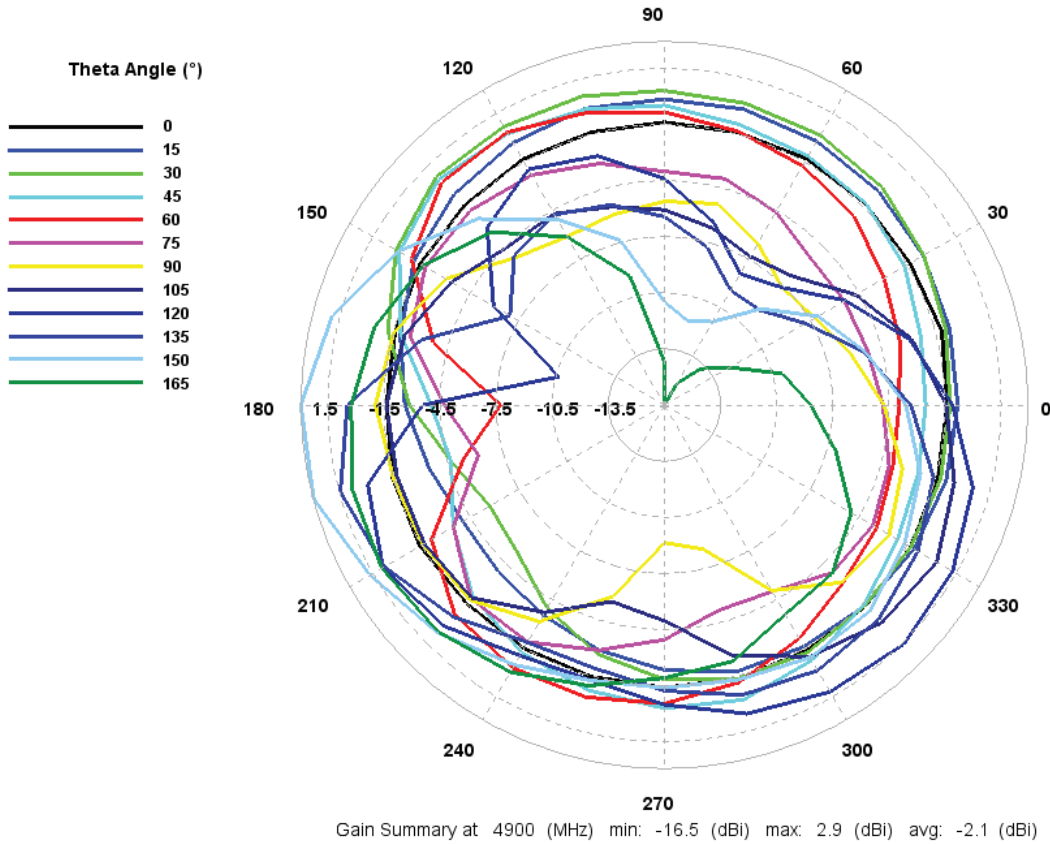

Figure 16: Total gain pattern

3D Plots at 4900 MHz

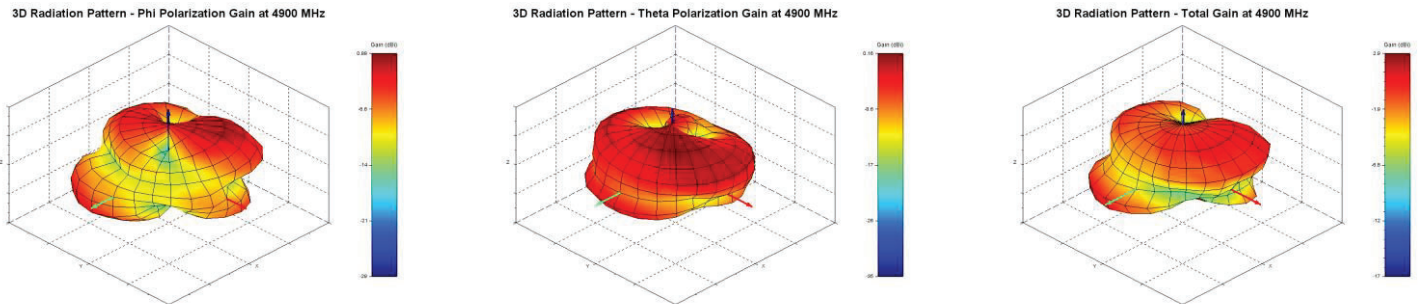

Figure 17: Phi, Theta, and total gain plots

Azimuthal Conical Cuts at 5400 MHz

Azimuth Gain Pattern Cuts - Total Gain at 5400 MHz

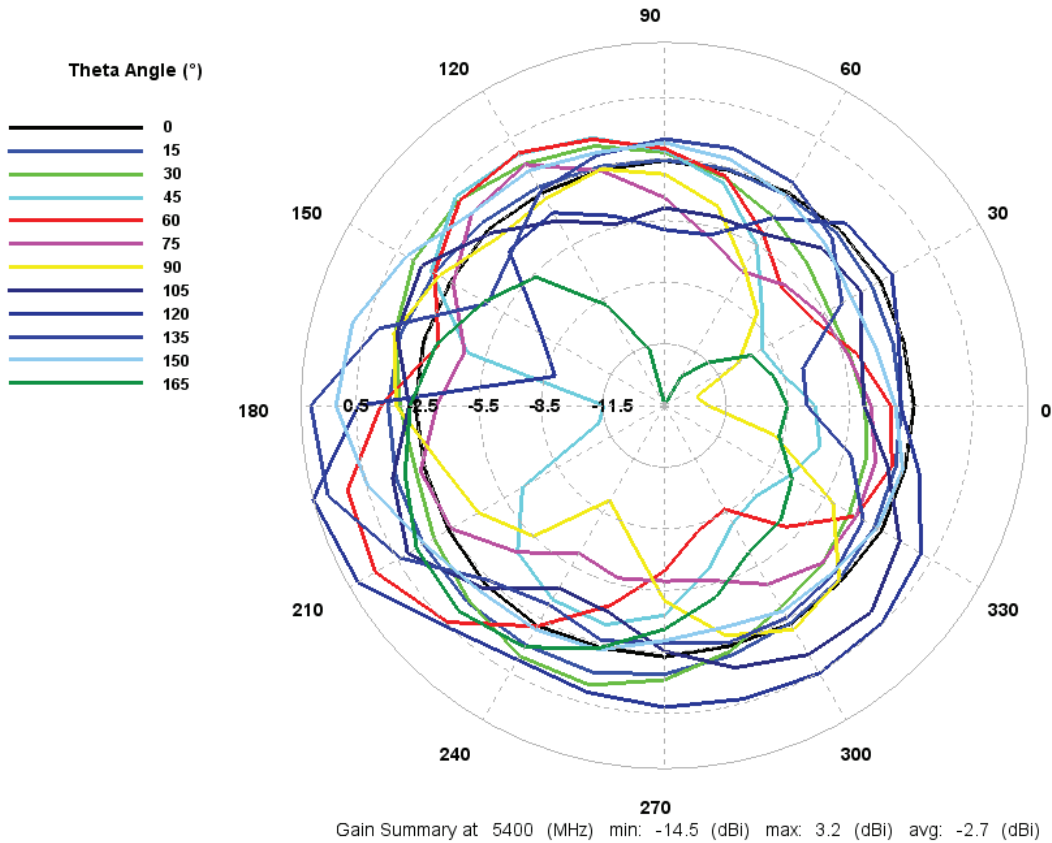

Figure 18: Total gain pattern

3D Plots at 5400 MHz

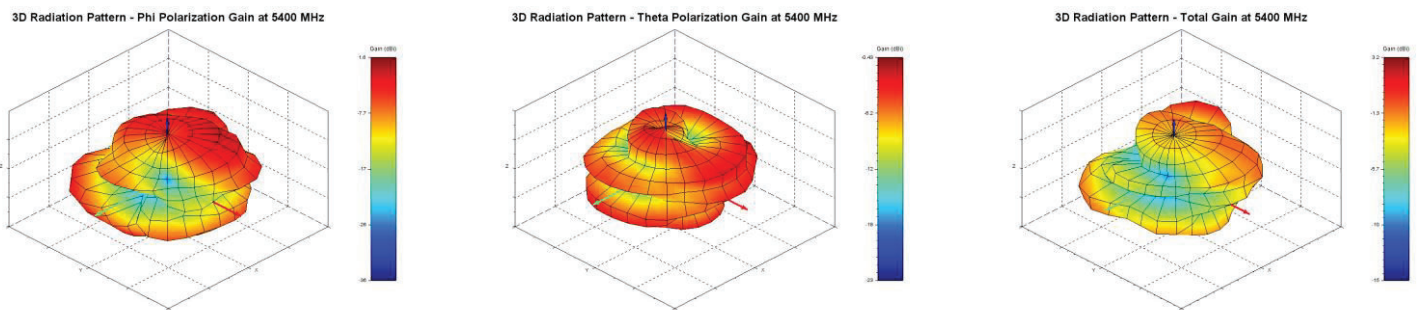

Figure 19: Phi, Theta, and total gain plots

Azimuthal Conical Cuts at 5900 MHz

Azimuth Gain Pattern Cuts - Total Gain at 5900 MHz

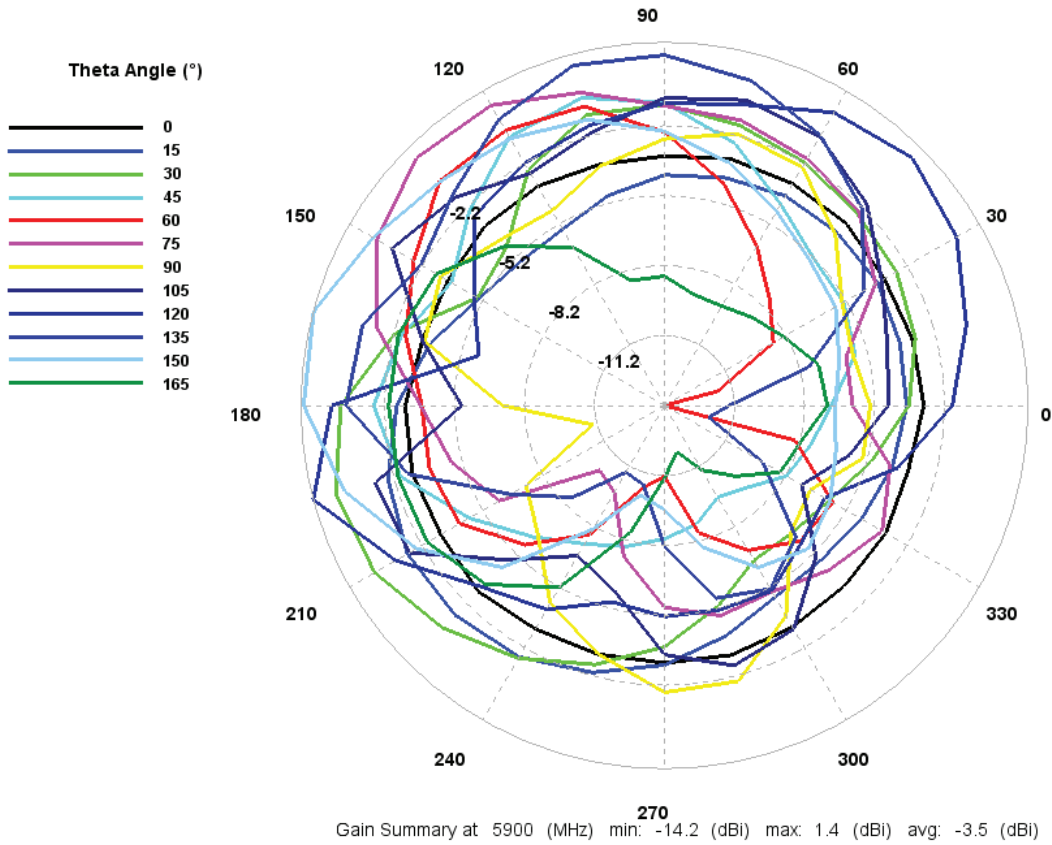

Figure 20: Total gain pattern

3D Plots at 5900 MHz

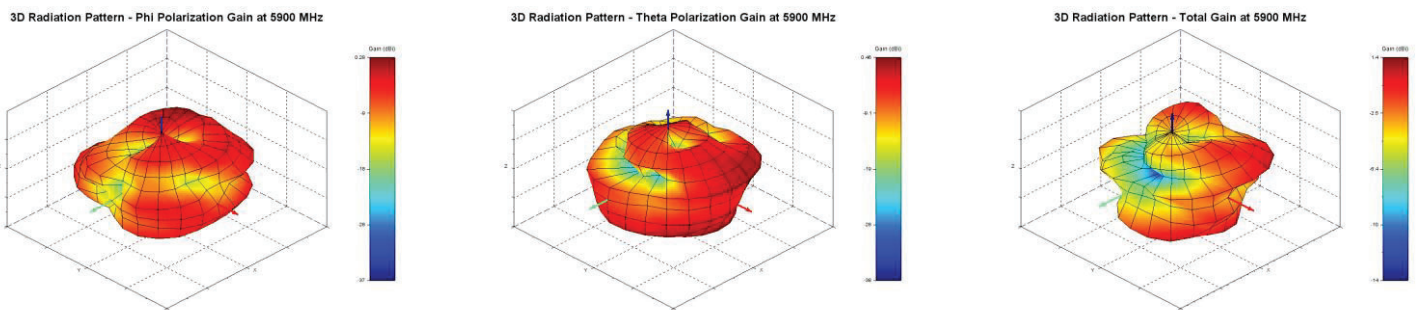

Figure 21: Phi, Theta, and total gain plots

FlexPIFA inside 52 mm inner diameter PVC tube
Antenna Measurement Setup

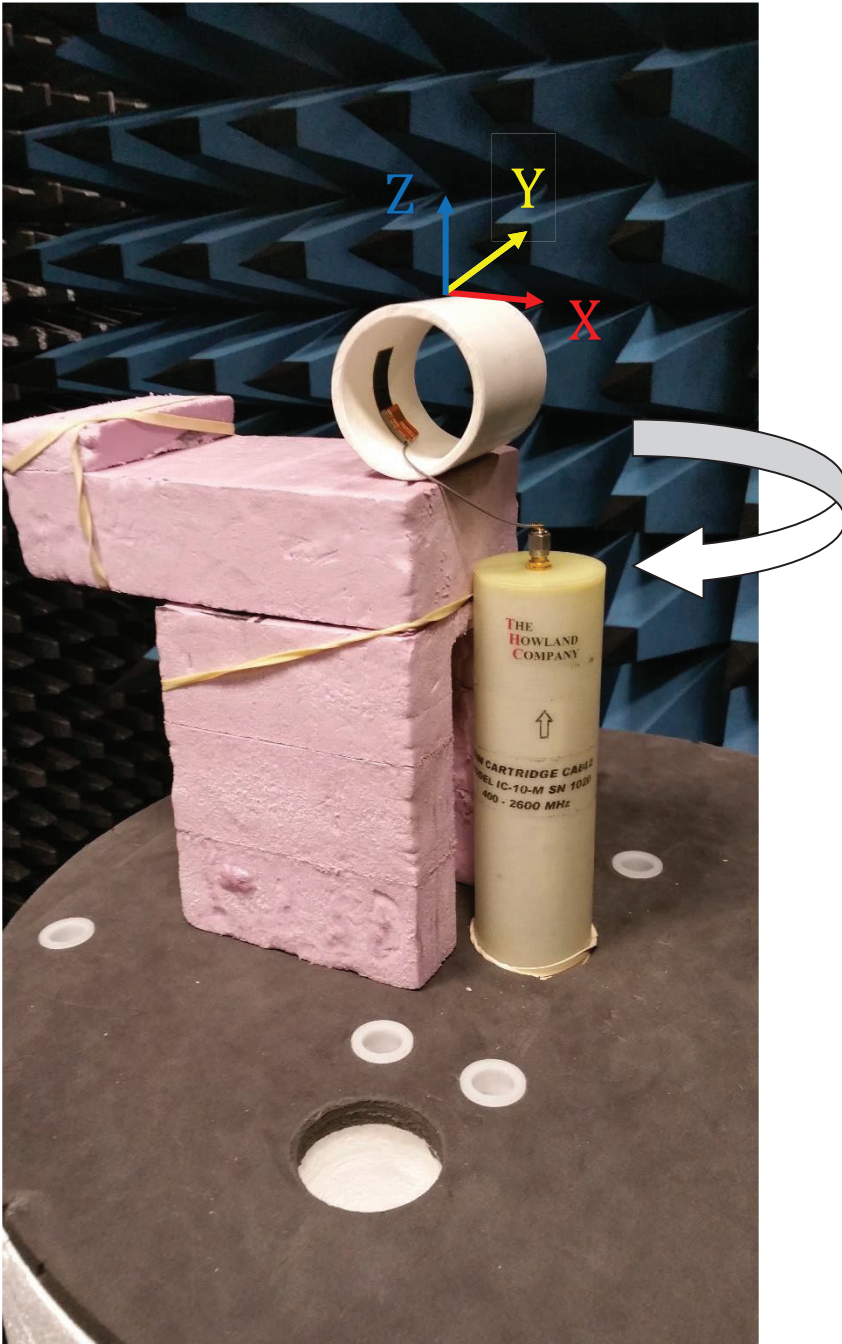

Figure 22: Inner diameter setup

2.4 GHz Band

Azimuthal Conical Cuts at 2440 MHz

Azimuth Gain Pattern Cuts - Total Gain at 2440 MHz

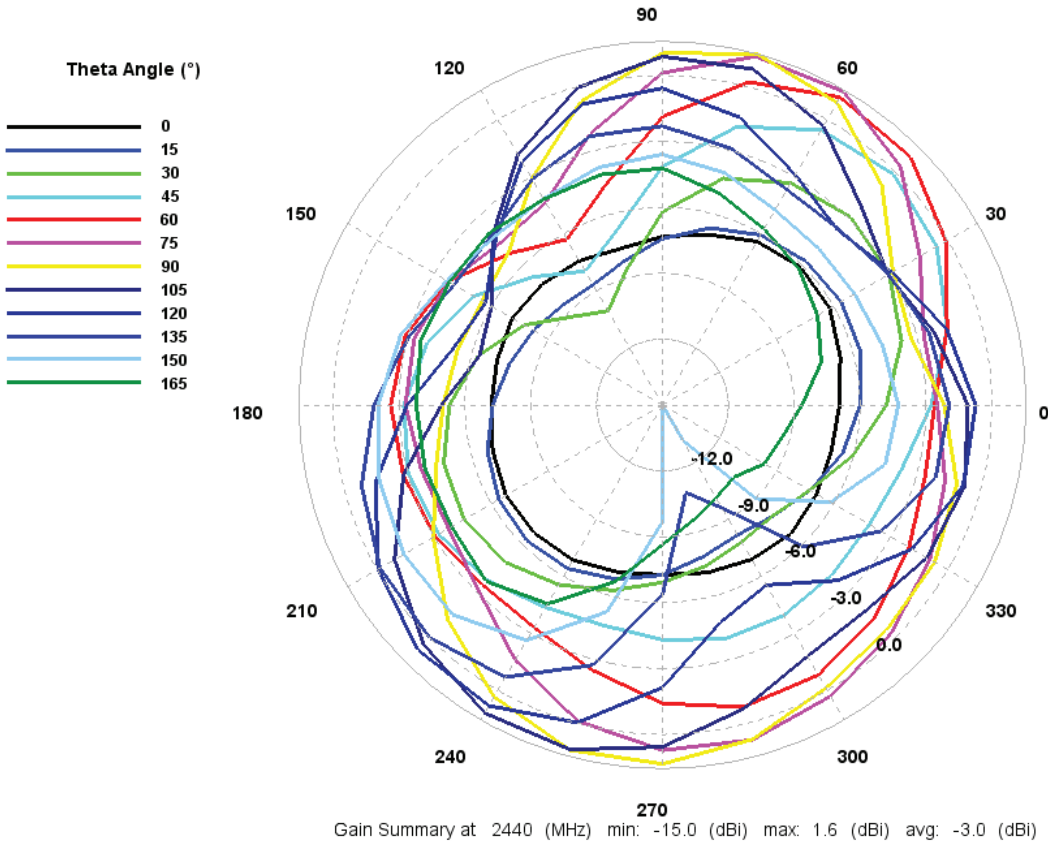

Figure 23: Total gain pattern

3D Plots at 2440 MHz

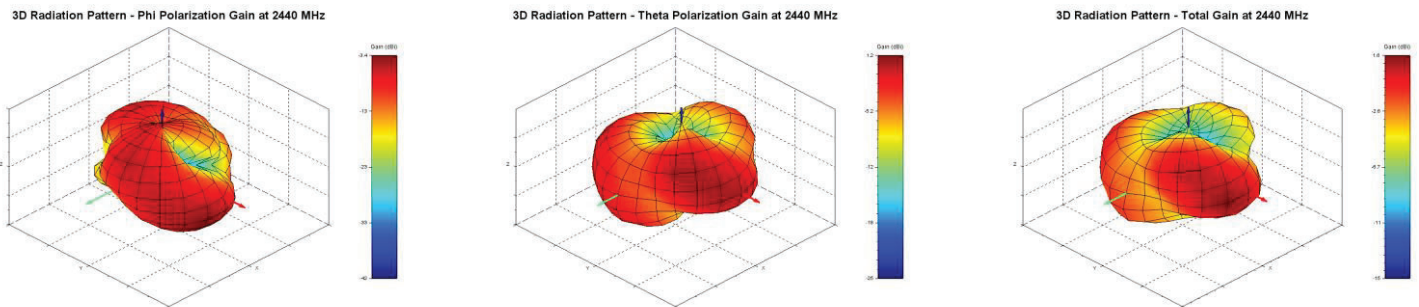

Figure 24: Phi, Theta, and total gain plots

5 GHz Band

Azimuthal Conical Cuts at 4900 MHz

Azimuth Gain Pattern Cuts - Total Gain at 4900 MHz

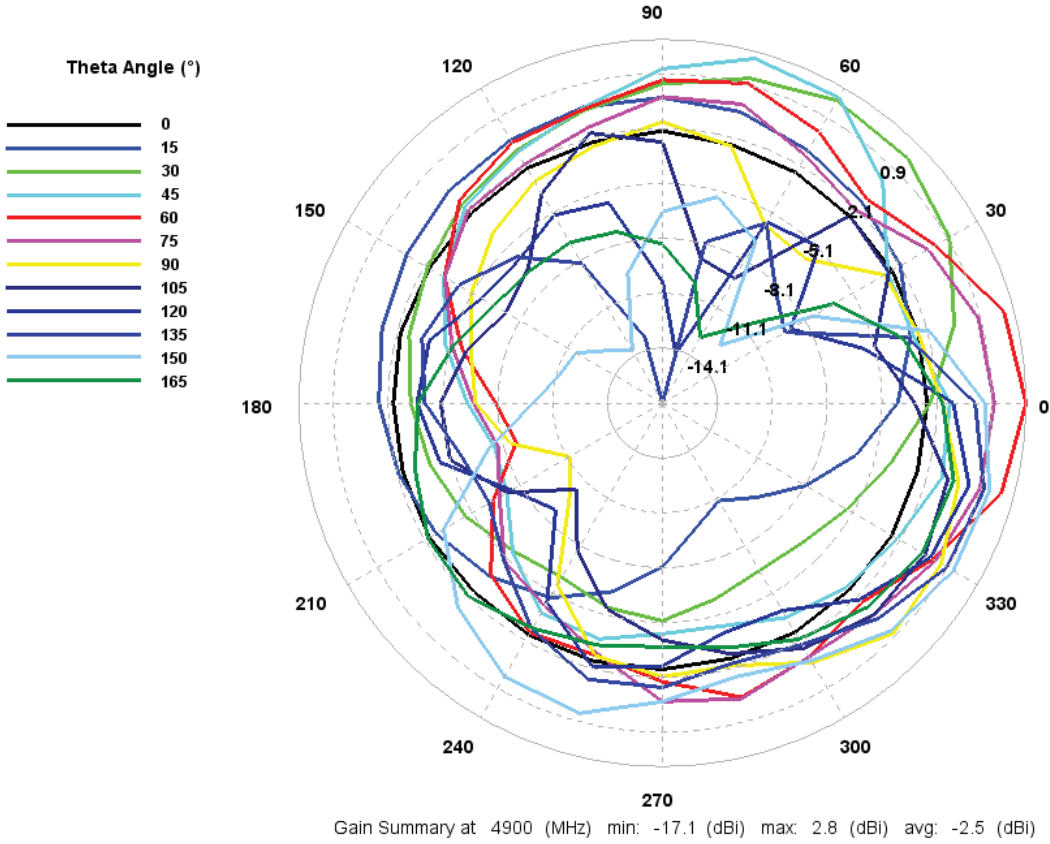

Figure 25: Total gain pattern

3D Plots at 4900 MHz

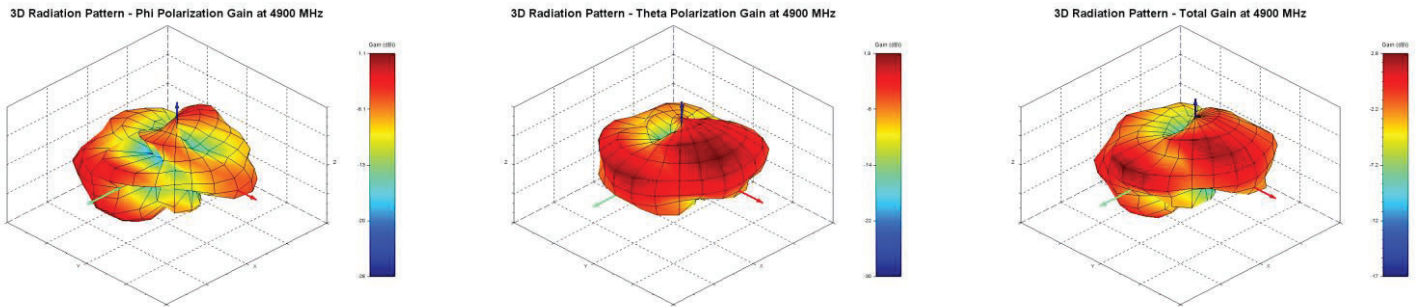

Figure 26: Phi, Theta, and total gain plots

Azimuthal Conical Cuts at 5400 MHz

Azimuth Gain Pattern Cuts - Total Gain at 5400 MHz

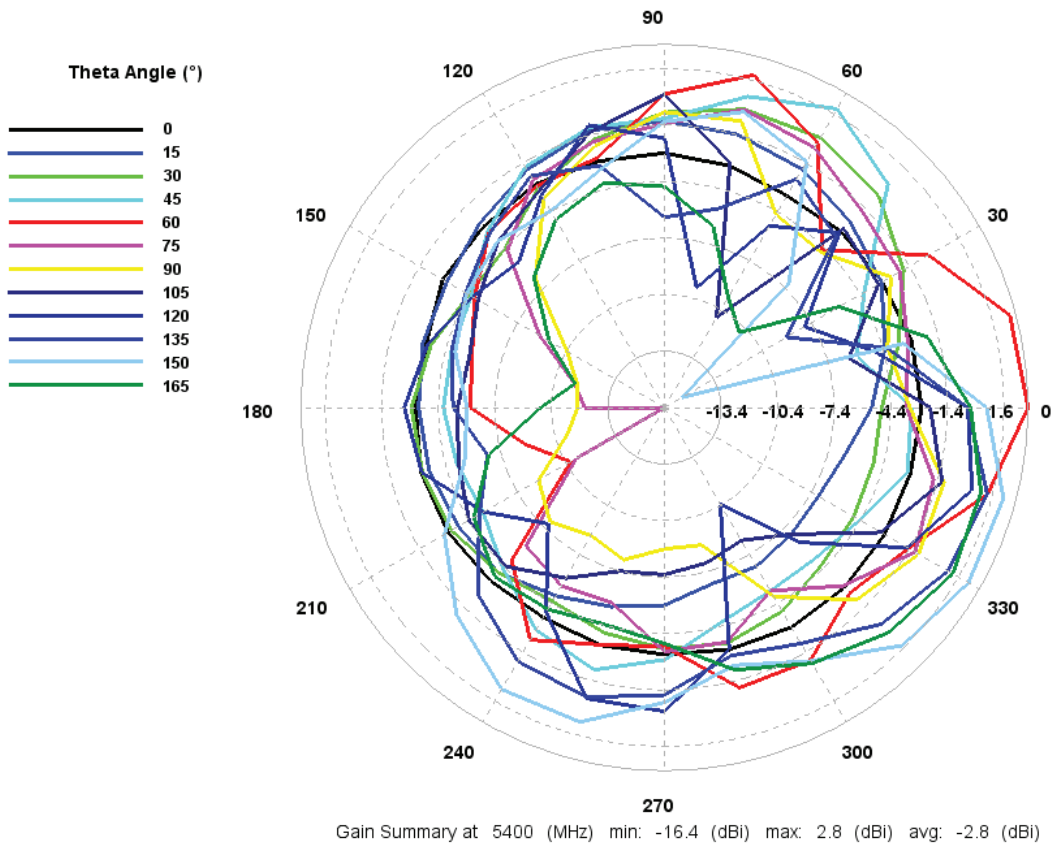

Figure 27: Total gain pattern

3D Plots at 5400 MHz

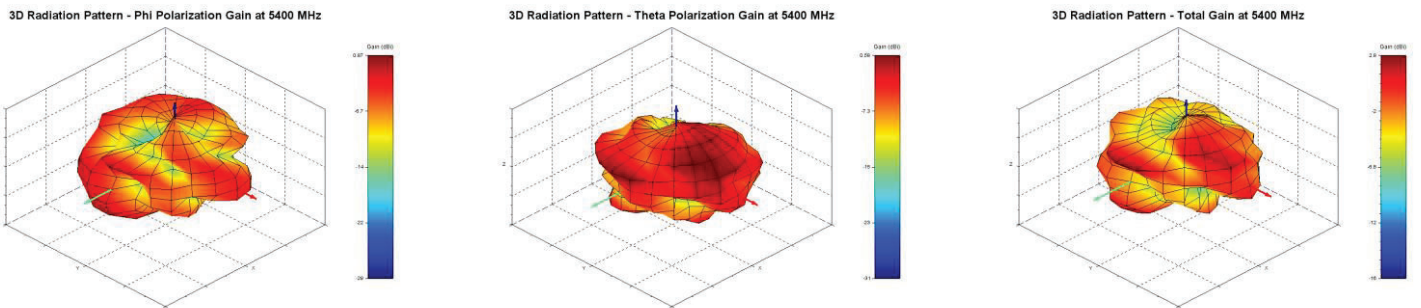

Figure 28: Phi, Theta, and total gain plots

Azimuthal Conical Cuts at 5900 MHz

Azimuth Gain Pattern Cuts - Total Gain at 5900 MHz

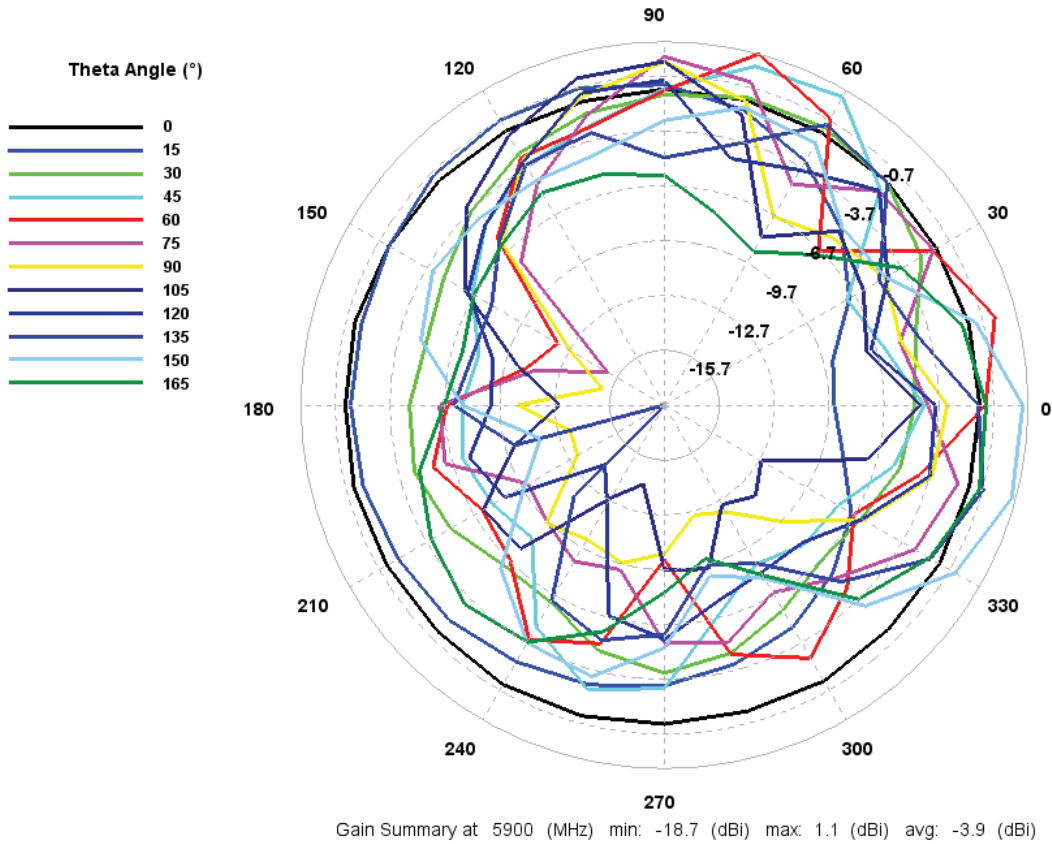

Figure 29: Total gain pattern

3D Plots at 5900 MHz

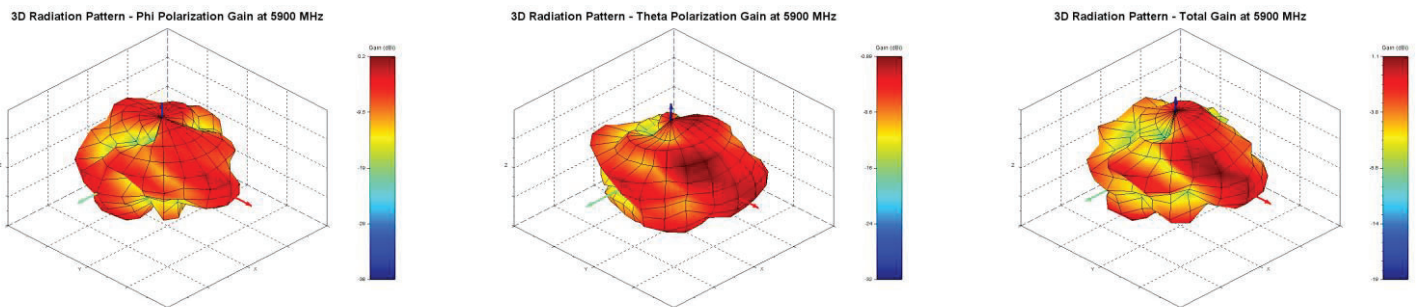

Figure 30: Phi, Theta, and total gain plots

OPTIMAL INSTALLATION GUIDE

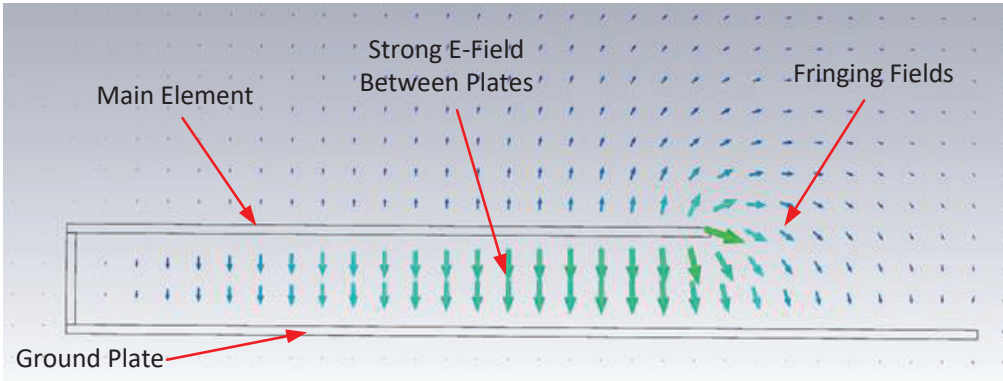

Figure 31: E-field radiation from FlexPIFA – taken from CST simulation

The main element should be kept clear of any non-metal objects (such as plastics) on top of it by at least three millimeters (see Figure 32). Similarly, the two long sides of the FlexPIFA should be kept clear of any non-metal object by at least two millimeters (See Figure 33). A one-millimeter clearance should be observed from the ground wall to any non-metal object. Mounting the FlexPIFA in a situation that does not allow for these clearance recommendations may change the gain characteristics stated in the datasheet, which could impact overall range of the wireless system.



Figure 32: Top clearance

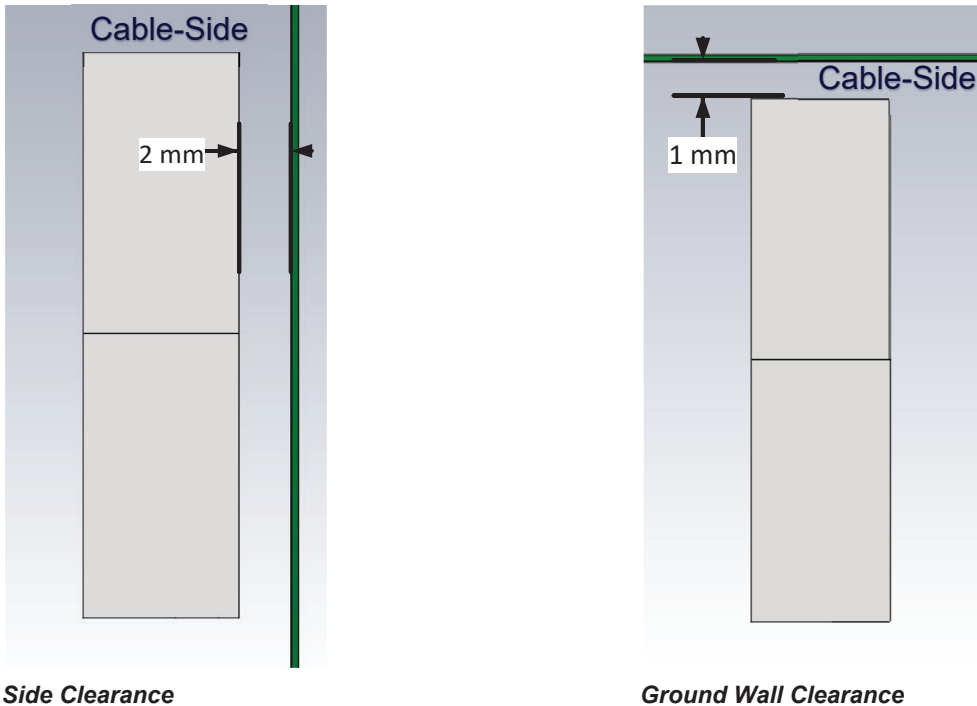
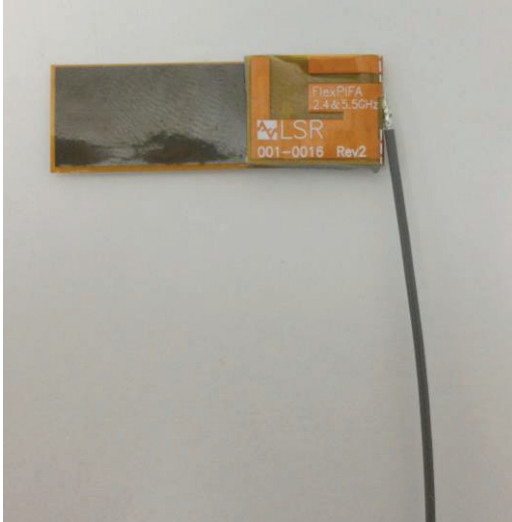

Figure 33: Side and ground wall clearance

The ideal material on which to mount the FlexPIFA is 1.5-millimeter thick polycarbonate for maximum performance. However, as previously mentioned, the FlexPIFA can tolerate other non-metallic surfaces and thicknesses and still radiate effectively. Depending on the type of material, the FlexPIFA may be detuned.

The coaxial cable feeding the FlexPIFA should be routed away from the antenna. Do not run the coaxial cable over the top of the FlexPIFA or near the tip of the main element. The cable should be routed perpendicular to the side of the FlexPIFA (this is the way the cable comes assembled) or away from the ground wall. These options are shown in [Figure 34](#).



Perpendicular to the side



Away from the ground wall

Figure 34: Recommended cable routing

As with any antenna, care should be taken not to place conductive materials or objects near the antenna (except as described in the next section). The radiated fields from the antenna induce currents on the surface of the metal; as a result, those currents then produce their own radiation. These re-radiating fields from the metal interfere with the fields radiating from the FlexPIFA (this is true for any antenna). Other objects, such as an LCD display, placed close to the antenna may not affect its tuning but it can distort the radiation pattern. Materials that absorb electromagnetic fields should be kept away from the antenna to maximize performance. Common things to keep in mind when placing the antenna:

- Wire routing
- Speakers – These generate magnetic fields
- Metal chassis and frames
- Battery location
- Proximity to human body
- Display screen – These absorb radiation
- Paint – Do not use metallic coating or flakes

Flex Limits of the FlexPIFA

One of the unique features of the FlexPIFA is its ability to flex. However, due to the adhesive, there are limits as to how much the antenna can be flexed and remain secured to the device. The FlexPIFA should not be flexed in a convex position with a radius less than 16 millimeters. Going smaller than this may result in the antenna peeling off the surface over time. Should a tighter radius of curvature be required, contact Laird Connectivity for assistance.

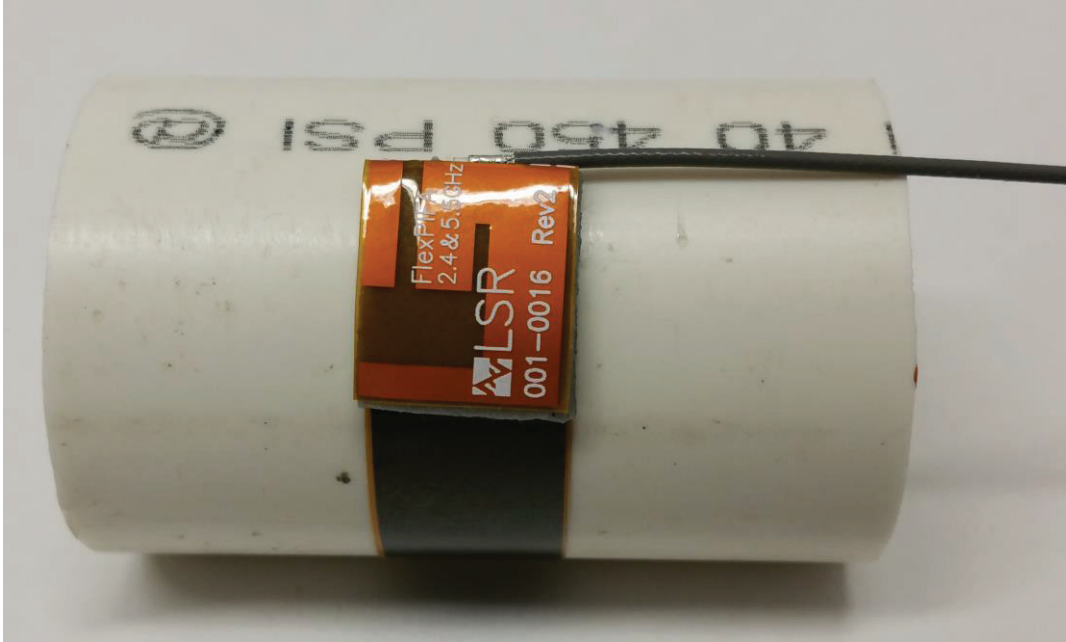

Figure 35: Convex-mounted

The FlexPIFA should not be flexed in a concave position with a radius less than 25 millimeters. In this scenario, the limiting factor is performance. The ground plane of the antenna is pressed closer to the main element. As previously discussed in the introduction of this datasheet, the fringing fields developing off the end of the element are responsible for most of the radiation. In a concave position with a radius of curvature less than 25 millimeters, the fringing fields are adversely affected and gain suffers. If a tighter radius of curvature is required, contact Laird Connectivity for assistance.

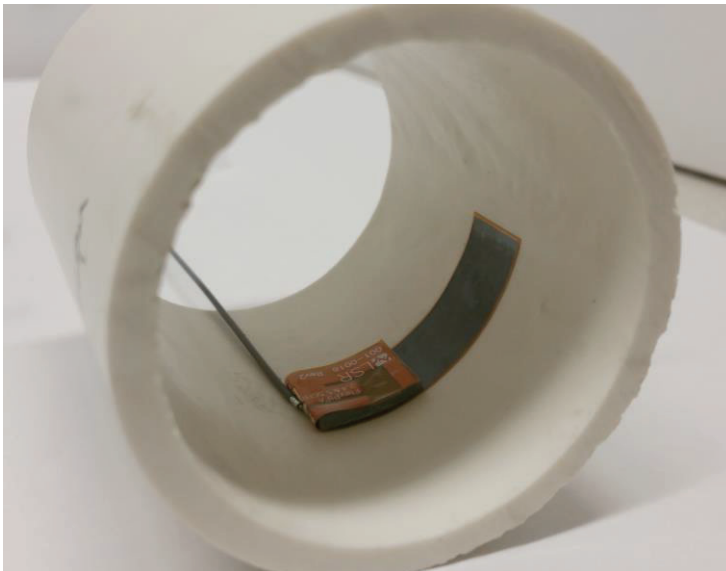

Figure 36: Concave-mounted

The FlexPIFA is not designed to be twisted or crumpled. The adhesive back should lay flush with the surface on which it is mounted.

Mounting on Metal and Body Loaded Applications

The FlexPIFA can tolerate being mounted on conductive surfaces. There will be some detuning of the antenna, which translates into some gain reduction. Even though the FlexPIFA is optimized to work on non-metallic surfaces, it still radiates efficiently due to the fringing fields (see [Figure 31](#)). The ground plane of the FlexPIFA carries the adhesive backing; placing the antenna onto a metal surface simply enlarges the size of the ground beneath the main element. Previously, the fringing fields only interacted with the small ground of the FlexPIFA, however they are now interacting with the much larger ground. The fringing fields still develop and radiate, but the antenna will no longer tune as well to the 2.4 GHz frequency band. Consequently, the VSWR increases and there is some loss in radiated power. If the FlexPIFA cannot meet your range requirements after being implemented on a metal surface, contact Laird Connectivity for a custom antenna build to help meet your application needs.

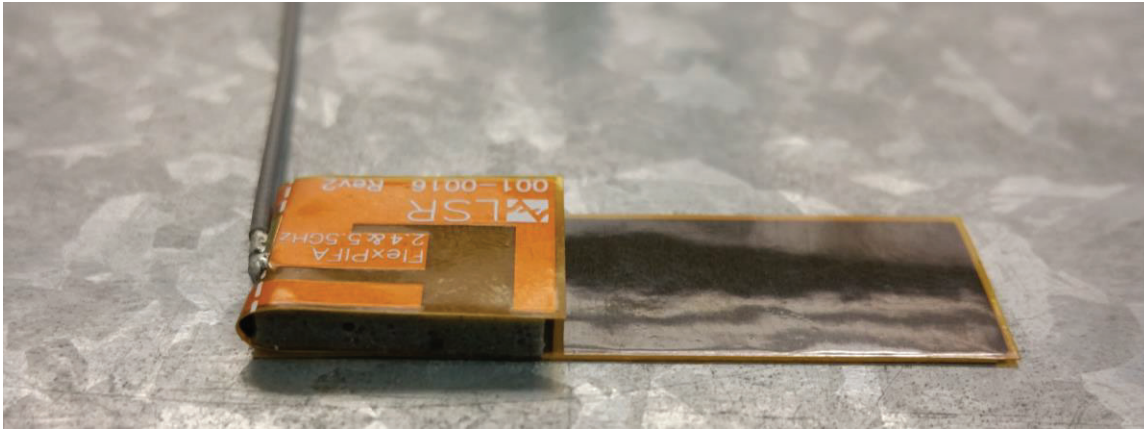

Figure 37: FlexPIFA mounted on metal

Do not mount the FlexPIFA where metal is within ten millimeters above the main element (see [Figure 39](#)). Not only does this severely limit the radiation pattern (mainly due to the re-radiation problem previously described) it detunes the antenna inside of this range.

Similarly, the two long sides of the FlexPIFA should be kept clear of any metal object by at least five millimeters. These keep out requirements pertaining to **conductive** materials only and are different from those listed in the previous sections which apply to **non-conductive** materials. In general, it is good practice to always keep metals as far away from the antenna as possible.

For the best performance, a spacer should be placed between the FlexPIFA and the conductive surface (see [Figure 38](#)). The spacer should be 1.5 millimeters thick polycarbonate. This will significantly improve performance and tuning of the FlexPIFA on a metal surface. Other non-conductive materials such as ABS plastic can be used; however, polycarbonate provides the best results.



Figure 38: FlexPIFA mounted on metal Surface with 1.5 mm thick polycarbonate spacer

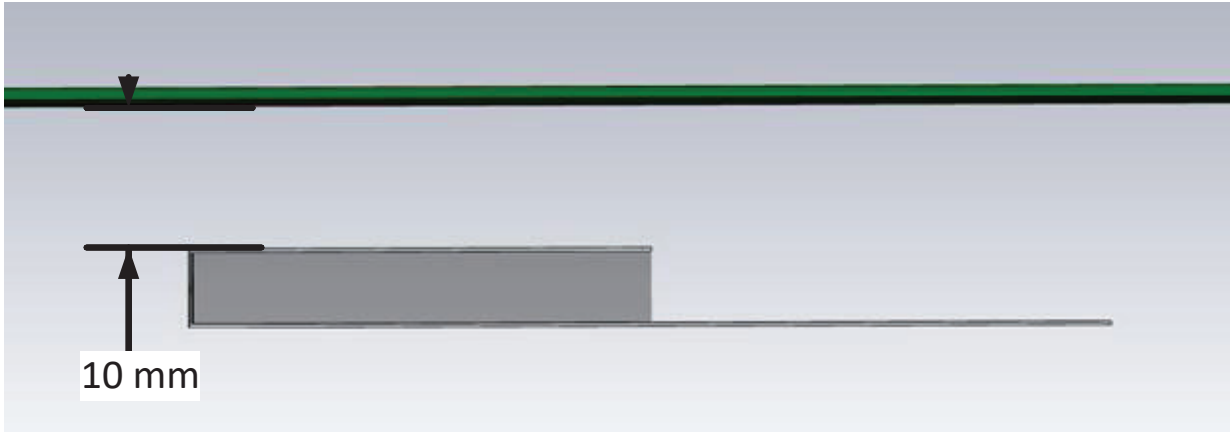

Figure 39: Metal near main element

For body-worn applications, the FlexPIFA can tolerate the presence of the human body. We do not recommend that you mount the antenna directly on body tissue to avoid detuning the FlexPIFA.

Additionally, the human body is an excellent absorber of 2.4 GHz RF signals. As a result, expect a reduction in range due to the presence of a body. In a body-worn application, the ground plate of the FlexPIFA should be closest to the body tissue. The main element should be pointed away from the body. Additionally, for handheld devices, the FlexPIFA should be mounted in a location where it is not covered by the hand. If the antenna is mounted in a location where the main element is covered or near a human body, ensure that there is at least a ten-millimeter separation distance between the main element and the body as shown in [Figure 39](#).

Additionally, when the FlexPIFA is mounted very close to body tissue, use a spacer to create separation distance between the body tissue and ground plate. This ensures maximum performance and prevents the antenna from detuning. As previously mentioned, the ideal spacer material is 1.5 mm thick polycarbonate.

Quite often this separation distance between the body tissue and the FlexPIFA is already provided by the enclosure. [Figure 40](#) is an example of a bracelet with the FlexPIFA integrated inside it. The enclosure provides enough spacing between the antenna and body tissue to prevent any major detuning. The enclosure is made of polycarbonate.



Figure 40: FlexPIFA integrated into bracelet

PRODUCT REVISION HISTORY

001-0016

Rev 1: Prototype Release



Rev 2: Initial Production Release



Rev 3: Updated FPC (Improve Tuning)

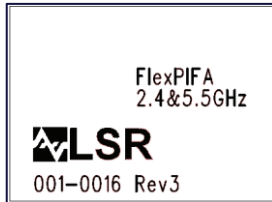

Rev 4: Updated Silkscreen (Laird Logo and U.S. Patent)

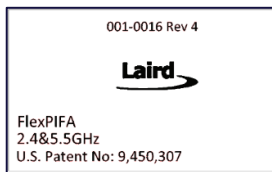

Rev 5: Changed Supplier – Color Change to Antenna

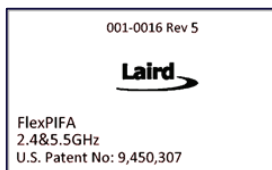

001-0021

Rev 1: Initial Production Release



Rev 2: Updated FPC (Improve Tuning)



Rev 3: Updated Silkscreen (Laird Logo and U.S. Patent)

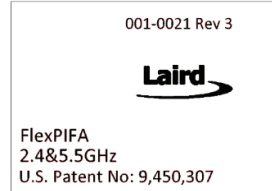

Rev 4: Changed Supplier – Color Change to Antenna

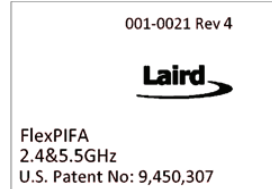

ADDITIONAL ASSISTANCE

Please contact your local Laird Connectivity sales representative or our support team for further assistance:

Support Center	https://connectivity.lairdtech.com/resources/support
Email	wireless.support@lairdtech.com
Phone	Americas: +1-800-492-2320 Europe: +44-1628-858-940 Hong Kong: +852 2923 0610
Web	https://connectivity.lairdtech.com/wireless-modules/bluetooth-modules

RoHS

Laird warrants to the original end user customer of its products that its products are free from defects in material and workmanship. Subject to conditions and limitations Laird will, at its option, either repair or replace any part of its products that prove defective because of improper workmanship or materials. This limited warranty is in force for the useful lifetime of the original end product into which the Laird product is installed. Useful lifetime of the original end product may vary but is not to exceed five (5) years from the original date of the end product purchase.

Any information furnished by Laird Inc. and its agents is believed to be accurate and reliable. All specifications are subject to change without notice. Responsibility for the use and application of Laird materials rests with the end user, since Laird and its agents cannot be aware of all potential uses. Laird makes no warranties as to the fitness, merchantability or suitability of any Laird materials or products for any specific or general uses. Laird shall not be liable for incidental or consequential damages of any kind. All Laird products are sold pursuant to the Laird Terms and Conditions of sale in effect from time to time, a copy of which will be furnished upon request.

© Copyright 2019 Laird Inc. All Rights Reserved. Laird, Laird Technologies, the Laird Logo, and other marks are trademarks or registered trademarks of Laird Inc. or an affiliate company thereof. Other product or service names may be the property of third parties. Nothing herein provides a license under any Laird or any third party intellectual property rights.

