

Application	2.4GHz
Part No.	AMAN201510ST01
Revision	0

DATASHEET

Application

Bluetooth
 Zigbee
 WLAN (IEEE 802.11 b/g)
 ISM 2.4GHz Wireless Devices

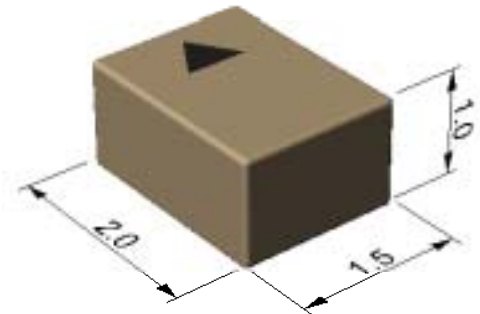

Features

PIFA Structure
 Small Size (2.0*1.5*1.0mm³)
 Easy Optimizing
 with external lumped matching components
 SMT Available under Pb-free Condition
 RoHS Compliant

AMOTECH

Revision History

Rev. No	Date	Title	Contents	Page
0	'09.08.27		New Published	

Table of Content

1. Specifications	3
1.1 Electrical Specifications	3
1.2 Mechanical Specifications	3
1.3 Appearance and Material	3
2. PCB Design for Test	4
2.1 Evaluation Board Dimension	4
2.2 PCB Design Guide	4
3. Measurement Result	5
3.1 Typical Measurement Result (VSWR/RL, Smithchart)	5
3.2 Typical Measurement Result (Gain, Radiation Pattern)	6
4. Reliability	7
5. Soldering Reflow Profile	7
6. Packaging	8
6.1 Carrier Tape Dimension	8
6.2 Packaging Label	8

1. Specifications

1.1 Electrical Specifications

No	Item	Spec.	Remark
1	Frequency Range [GHz]	2.4 ~2.485	
2	VSWR	Max 3.0:1	
3	Peak Gain [dBi]	typ. 2.9	
4	Total Avg. Gain [dBi]	typ. -0.9	
5	Efficiency [%]	typ. 82	
6	Polarization	Linear	
7	Impedance [Ω]	Nominal 50	

- ✓ The results are measured on the 50x50mm² evaluation board(EVB).
- ✓ See Page 6. for more detail gain parameter

1.2 Mechanical Specifications

No	Item	Spec.	Remark
1	Dimensions (LxWxH)	2.0x1.5x1.0 mm ³	
2	Unit Weight	typ. 11mg	
3	Operating Temperature	-35 ~ +85	

1.3 Appearance & Material

No	Item	Function	Material
	Marking	Feeding Index	Ink
	Ceramic Body	-	Ceramic

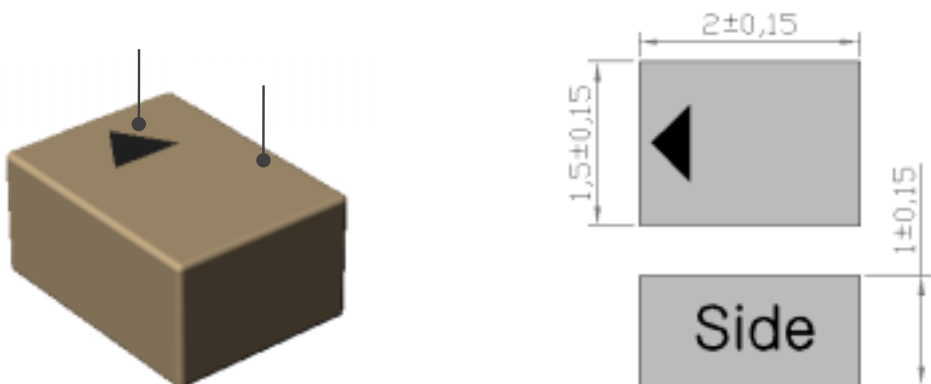

[unit : mm]

2. PCB Design for Test

2.1 Evaluation Board Dimension

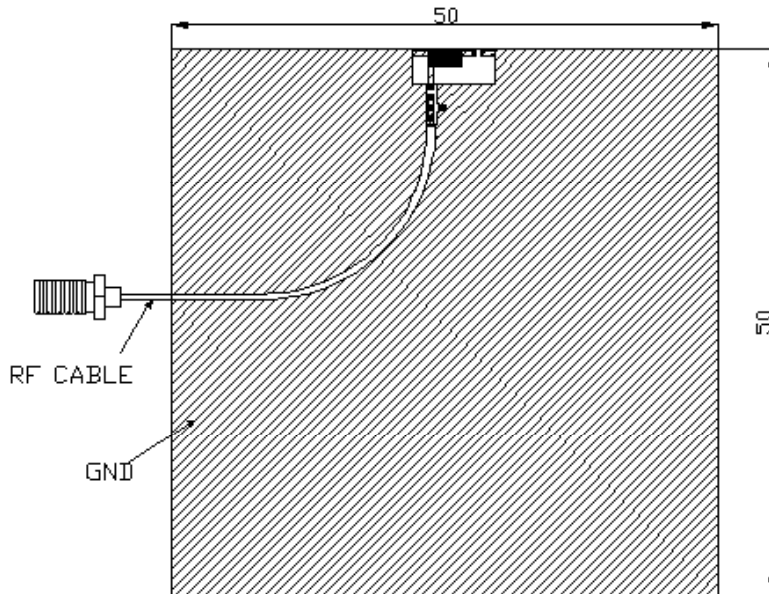

- ✓ Evaluation board size ~ 50x50
- ✓ Fill Cut Area (GND Clearance) ~ 7.5x3.8

2.2 PCB Design Guide

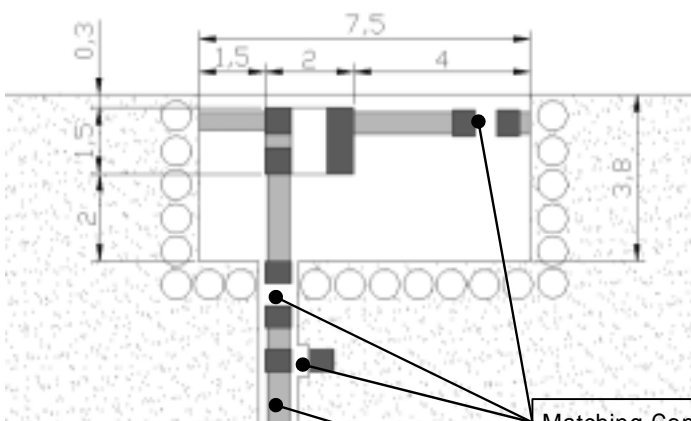

Matching Component

50 Ohm Feeding Line

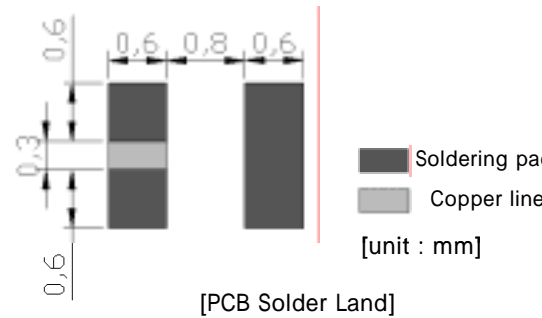

■ Soldering paste
■ Copper line

No	Pin Assignment
	Feeding
	GND
	GND

3. Measurement Result

3.1 Typical Measurement Result (VSWR/RL, Smithchart)

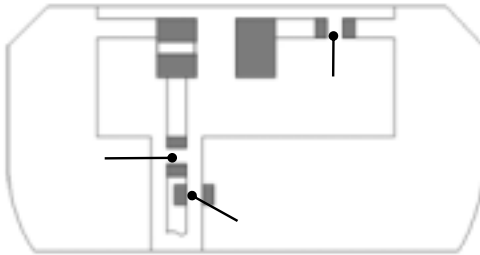

No	Matching Value
	1.2nH
	3.3pF
	2.7nH

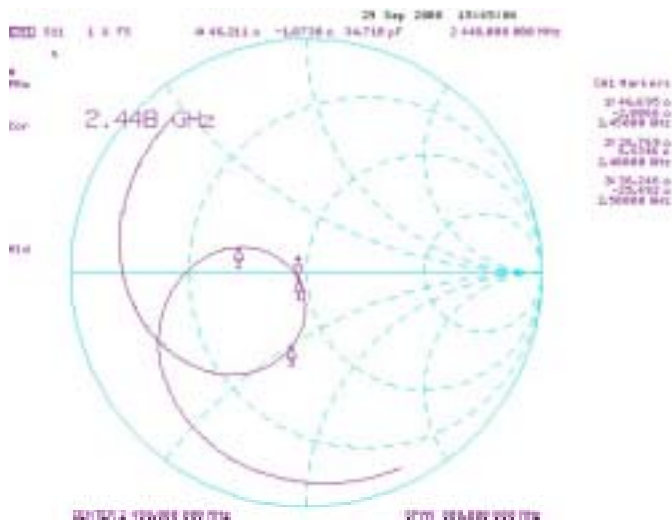
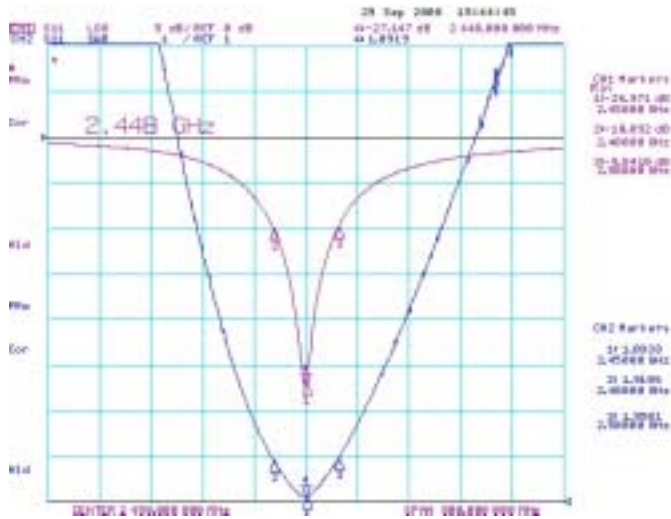

✓ The results are measured on the 50x50mm² evaluation board(EVB).

3.2 Typical Measurement Result (Gain, Radiation Pattern)

	Peak Gain (dBi)	Avg. Gain (dBi)	Total Avg. Gain (dBi)	Efficiency (%)
Azimuth	1.63	-1.23	-0.85	82
Elevation 1	2.32	-1.58		
Elevation 2	1.36	-2.75		

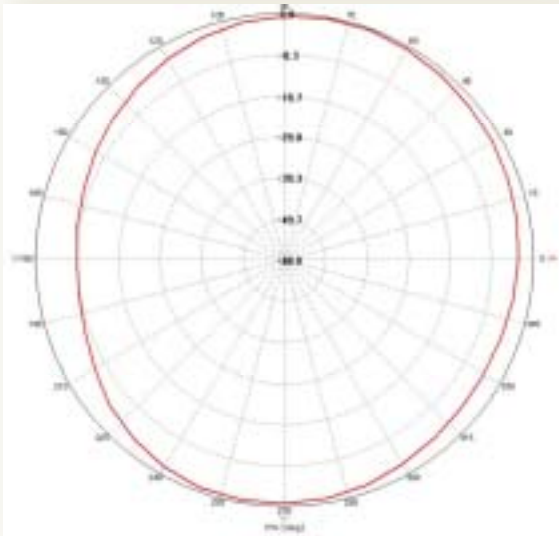
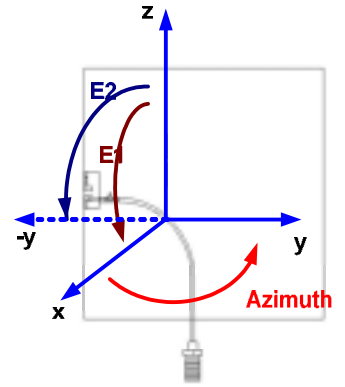

[Azimuth plane @2.45GHz]

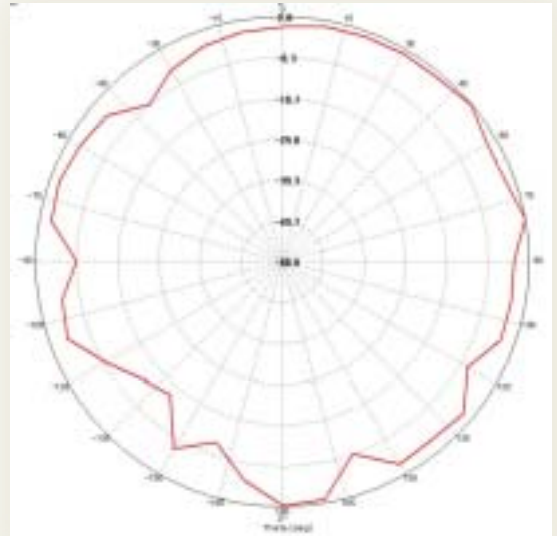

[Elevation1 plane @2.45GHz]

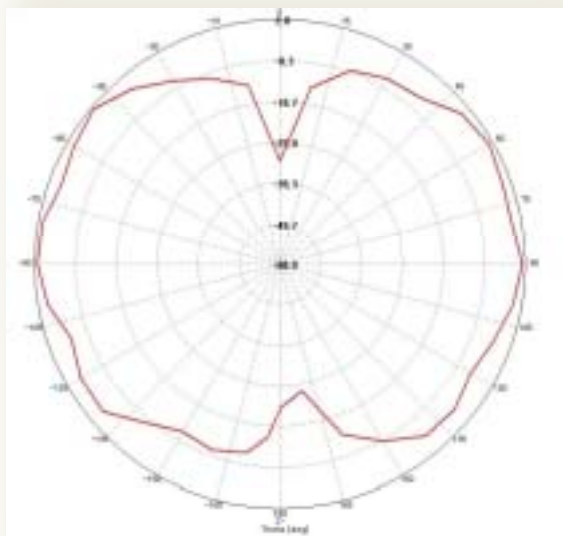

[Elevation2 plane @2.45GHz]

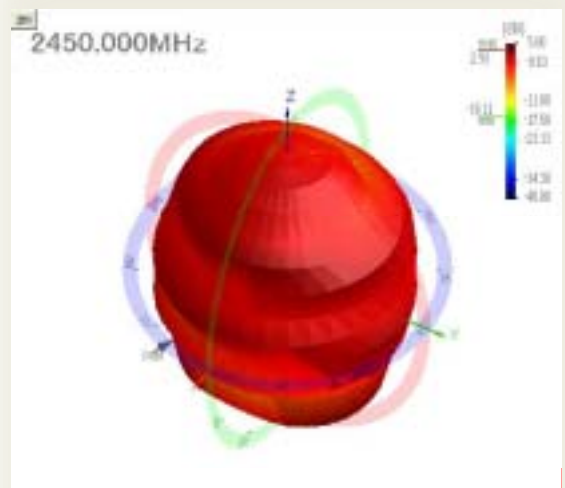

[3D Radiation Pattern]

4. Reliability

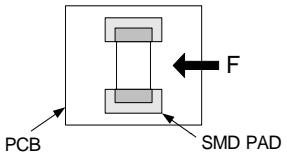
No	Item	Test Condition	Test Requirements
1	Adhesive Strength of Termination	1. Applied force on SMT chip till detached point from PCB. 	1. No mechanical damage by applied force 2. Strength (F) > 1 kgf
2	Thermal Shock (Cycle)	1. Step 1 : -40 ± 3 , 30 min Step 2 : $+125 \pm 3$, 30 min 2. Number of cycle : 30	1. No visual damage 2. Within electric spec (VSWR)
3	High Temperature Resistance	1. Temperature : $+125 \pm 5$ 2. Time : 1000 ± 24 hrs	1. No visual damage 2. Within electric spec (VSWR)
4	Low Temperature Resistance	1. Temperature : -40 ± 5 2. Time : 1000 ± 24 hrs	1. No visual damage 2. Within electric spec (VSWR)
5	Humidity	1. Humidity : 85 % RH Temperature : $+85 \pm 3$ 2. Time : 1000 ± 24 hrs	1. No visual damage 2. Within electric spec (VSWR)

5. Soldering Reflow Profile

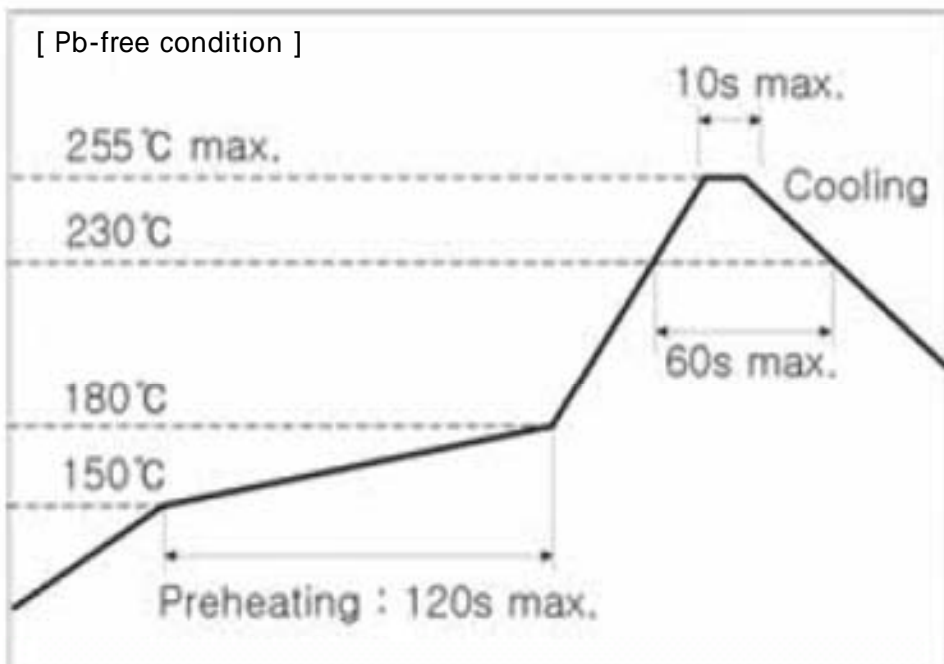

6. Packaging

6.1 Carrier Tape Dimension

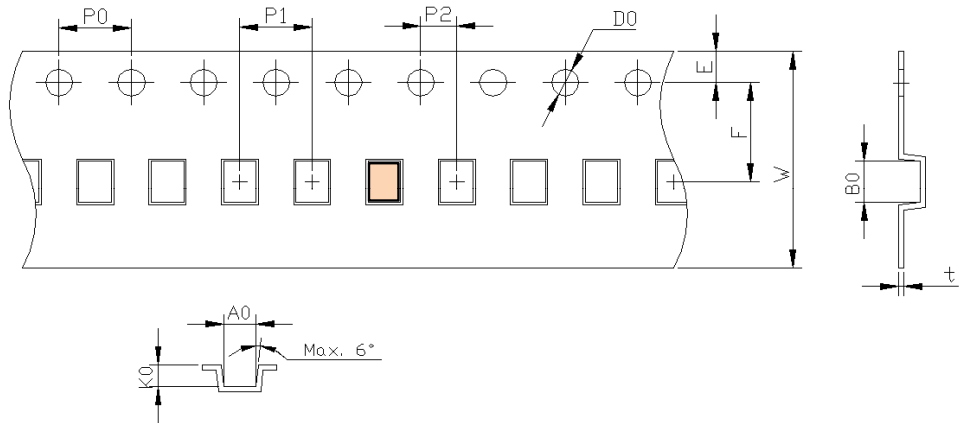

Item	Spec.	Item	Spec.	Item	Spec.
A0	1.80 ±0.10	P0	4.00 ±0.10	E	1.75 ±0.10
B0	2.30 ±0.10	P1	4.00 ±0.10	F	5.50 ±0.10
K0	1.20 ±0.10	P2	2.00 ±0.10	W	12.00 ±0.30
D0	1.55 ±0.05	-	-	t	0.30 ±0.10

6.2 Packaging Label

AMOTECH Co., Ltd.

5BL-1Lot, 617, Namchon-Dong, Namdong-Gu, Incheon, Korea

Dielectric Chip Antenna

P/N : AMAN201510ST01

Lot No :

Quantity : 2,500 pcs Date : 2009/08/27