



TEST REPORT

Report Number: 102374971MPK-019
Project Number: G102374971
March 29, 2016

Testing performed on the
Zwave Module
Model: QS-ZWAVE
FCC ID: 2AAJXQS-ZWAVE
IC: 11205A-QSZWAVE
to

FCC Part 15 Subpart C (15.249)
RSS-210 Issue 8
FCC Part 15, Subpart B
Industry Canada ICES-003

For

Qolsys, Inc.

Test Performed by:

Intertek
1365 Adams Court
Menlo Park, CA 94025 USA

Test Authorized by:

Qolsys, Inc.
1900 The Alameda Ste 420
San Jose, CA 95126 USA

Prepared by:

Aaron Chang

Date: March 29, 2016

Reviewed by:

Krishna K Vemuri

Date: March 29, 2016

This report is for the exclusive use of Intertek's Client and is provided pursuant to the agreement between Intertek and its Client. Intertek's responsibility and liability are limited to the terms and conditions of the agreement. Intertek assumes no liability to any party, other than to the Client in accordance with the agreement, for any loss, expense or damage occasioned by the use of this report. Only the Client is authorized to copy or distribute this report and then only in its entirety. Any use of the Intertek name or one of its marks for the sale or advertisement of the tested material, product or service must first be approved in writing by Intertek. The observations and test results in this report are relevant only to the sample tested. This report by itself does not imply that the material, product, or service is or has ever been under an Intertek certification program. This report must not be used to claim product endorsement by A2LA, NIST nor any other agency of the U.S. Government.

VERIFICATION OF COMPLIANCE
Report No. 102374971MPK-019

Verification is hereby issued to the named APPLICANT and is VALID ONLY for the equipment identified hereon for use under the rules and regulations listed below.

Equipment Under Test:	Zwave Module
Trade Name:	Qolsys, Inc.
Model Number:	QS-ZWAVE
Serial Number:	QC02RYYWWXXXXX
Applicant:	Qolsys, Inc.
Contact:	Mark Skeen
Address:	Qolsys, Inc. 1900 The Alameda Ste 420 San Jose, CA 95126
Country	USA
Tel. Number:	408-857-8415
Email:	mark.skeen@qolsys.com
Applicable Regulation:	FCC Part 15 Subpart C (15.249) RSS-210 Issue 8 FCC Part 15, Subpart B Industry Canada ICES-003
Date of Test:	February 11, 2016

We attest to the accuracy of this report:

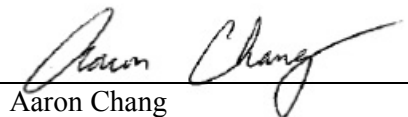

Aaron Chang
Project Engineer

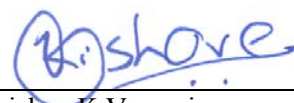

Krishna K Vemuri
Engineering Team Lead

TABLE OF CONTENTS

1.0	Summary of Tests	4
2.0	General Description.....	5
2.1	Product Description	5
2.2	Related Submittal(s) Grants.....	6
2.3	Test Methodology	6
2.4	Test Facility	6
2.5	Measurement Uncertainty.....	6
3.0	System Test Configuration.....	7
3.1	Support Equipment and description.....	7
3.2	Block Diagram of Test Setup.....	7
3.3	Justification.....	8
3.4	Software Exercise Program.....	8
3.5	Mode of operation during test.....	8
3.6	Modifications required for Compliance.....	8
3.7	Additions, deviations and exclusions from standards.....	8
4.0	Measurement Results.....	9
4.1	Transmitter Radiated Emissions	9
4.2	Occupied Bandwidth.....	16
4.3	Radiated Emissions from Digital Parts	19
4.4	Line Conducted Emissions	25
5.0	List of Test Equipment	31
6.0	Document History	32

1.0 Summary of Tests

TEST	REFERENCE FCC Part 15C	REFERENCE IC RSS-210/ RSS-Gen	RESULT
Field Strength of Fundamental	15.249a	A2.9(1) RSS-210	Complies
Field Strength of Harmonics	15.249a	A2.9(1) RSS-210	Complies
Radiated Emissions outside the band	15.249c	A2.9(2) RSS-210	Complies
Occupied Bandwidth	15.215(c)	4.4.1 RSS-Gen	Complies
Line Conducted Emissions	15.207	7.2.2 RSS-Gen	Complies
Antenna requirement	15.203	7.1.4 RSS-Gen	Complies
Radiated and Conducted Emissions from Digital Part and receiver	FCC 47CFR 15B	ICES 003	Complies

2.0 General Description

2.1 Product Description

The Equipment Under Test (EUT) is a module, model number QS-ZWAVE, that contains a Zwave radio.

Information about the Zwave radio is presented below:

Applicant name & address	Qolsys, Inc. 1900 The Alameda Ste 420 San Jose, CA 95126 USA
Manufacturer name & address	Qolsys, Inc. 1900 The Alameda Ste 420 San Jose, CA 95126 USA
Model No.	QS-ZWAVE
FCC Identifier	2AAJXQS-ZWAVE
IC	11205A-QSZWAVE
Frequency Range	908.4MHz
Rated RF Output	75.2 dB(μ V/m) at 3m
Number of Channel(s)	1
Type of Modulation	FSK
Data Rate	40Kbps for 908.4MHz Channel
Antenna(s) & Gain	PCB wire antenna, Gain: < 2 dBi

EUT receive date: January 4, 2016

EUT receive condition: The pre-production version of the EUT was received in good condition with no apparent damage. As declared by the Applicant, it is identical to the production units.

Test start date: February 11, 2016

Test completion date: February 11, 2016

The test results in this report pertain only to the item tested.

2.2 Related Submittal(s) Grants

None.

2.3 Test Methodology

Radiated emissions and AC mains conducted emissions measurements were performed according to the procedures in ANSI C63.10. Radiated tests were performed at an antenna to EUT distance of 3 meters, unless stated otherwise in the "Data Sheet" of this report. All other measurements were made in accordance with the procedures in part 2 of CFR 47.

2.4 Test Facility

The test site used to collect the radiated data is site 1 (10-m semi-anechoic chamber). This test facility and site measurement data have been fully placed on file with the FCC, IC and A2LA accredited.

2.5 Measurement Uncertainty

Compliance with the limits was based on the results of the measurements and doesn't take into account the measurement uncertainty.

Estimated Measurement Uncertainty

Measurement	Expanded Uncertainty (k=2)		
	0.15 MHz – 1 GHz	1 GHz – 2.5 GHz	> 2.5 GHz
Field Strength of fundamental	3.0 dB	2.5 dB	3.5 dB
Unwanted emissions - antenna conducted	1.1 dB	1.3 dB	1.9 dB
Bandwidth – antenna conducted	30 Hz	30 Hz	30 Hz
Spurious Radiated emissions	4.2 dB	3.4 dB	4.4 dB
AC mains conducted emissions	2.4 dB	-	-

3.0 System Test Configuration

3.1 Support Equipment and description

Description	Model No./ Part No.	Serial No.
HP Laptop	Elitebook 840	Not Labeled
IQPanel2	QS9201-1230-840	Not Labeled

3.2 Block Diagram of Test Setup

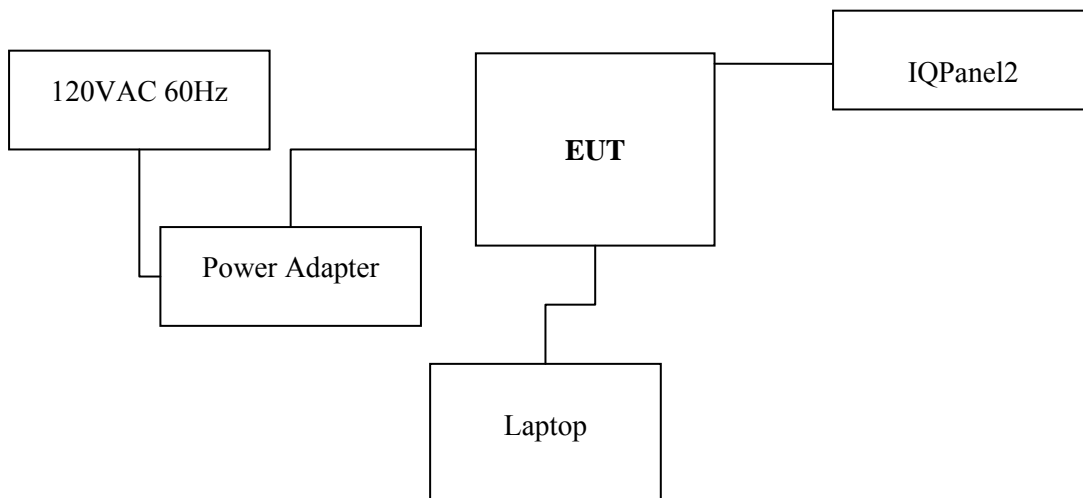

S = Shielded	F = With Ferrite
U = Unshielded	M = Meter

3.3 Justification

For radiated emission measurements the EUT is placed on a non-conductive table. The EUT is attached to peripherals and they are connected and operational (as typical as possible). The EUT is wired to transmit full power. During testing, all cables are manipulated to produce worst-case emissions.

3.4 Software Exercise Program

The EUT exercise program used during radiated and conducted testing was designed to exercise the various system components in a manner similar to a typical use.

3.5 Mode of operation during test

During the test the EUT was set to transmit the modulated signal with 100% duty cycle.

3.6 Modifications required for Compliance

No modifications were installed by Intertek during compliance testing in order to bring the product into compliance.

3.7 Additions, deviations and exclusions from standards

No additions, deviations or exclusion have been made from standard.

4.0 Measurement Results

4.1 Transmitter Radiated Emissions

FCC Rules: 15.249, 15.209; IC Rules: RSS-210 (A2.9), RSS-Gen

Requirements

The Field Strength of emissions at a distance of 3 meters shall not exceed the following levels:

94 dB(μ V/m) for fundamental frequency,

54 dB(μ V/m) for harmonics.

Emissions radiated outside of the specified frequency band, except for harmonics, shall be attenuated by at least 50 dB below the level of fundamental or to the general radiated emission limits in 15.209, whichever is the lesser attenuation.

Procedure

Radiated emission measurements were performed from 30 MHz to 10 GHz according to the procedure described in ANSI C64.10. Spectrum Analyzer Resolution Bandwidth is 100 kHz or greater for frequencies 30 MHz to 1000 MHz, 1 MHz for frequencies above 1000 MHz. Above 1000 MHz Peak measurements were performed.

Radiated emissions are taken at 10 meters for frequencies below 1 GHz and at 3 meters for frequencies above 1 GHz

The EUT is placed on a plastic turntable that is 80 cm in height. If the EUT attaches to peripherals, they are connected and operational (as typical as possible). During testing, all cables were manipulated to produce worst-case emissions. The signal is maximized through rotation. The antenna height and polarization are varied during the search for maximum signal level. The antenna height is varied from 1 to 4 meters.

Test was performed with the supply voltage varied between 85% and 115% of the nominal rated supply voltage as per FCC Rule 15.31(e).

Data is included of the worst case configuration (the configuration which resulted in the highest emission levels). A sample calculation, configuration photographs and data tables of the emissions are included.

Field Strength Calculation

The field strength is calculated by adding the Antenna Factor and Cable Factor, and subtracting the Amplifier Gain (if any) from the measured reading. The basic equation with a sample calculation is as follows:

$FS = RA + AF + CF - AG$; if measurement is performed at a distance other than specified in the rule, a Distance Correction Factor (DCF) shall be added.

Where FS = Field Strength in dB(μ V/m)

RA = Receiver Amplitude (including preamplifier) in dB(μ V); AF = Antenna Factor in dB(1/m)

CF = Cable Attenuation Factor in dB; AG = Amplifier Gain in dB

Assume a receiver reading of 52.0 dB(μ V) is obtained. The antennas factor of 7.4 dB(1/m) and cable factor of 1.6 dB is added. The amplifier gain of 29 dB is subtracted, giving field strength of 32 dB(μ V/m). This value in dB(μ V/m) was converted to its corresponding level in μ V/m.

RA = 52.0 dB(μ V)

AF = 7.4 dB(1/m)

CF = 1.6 dB

AG = 29.0 dB

FS = $52.0 + 7.4 + 1.6 - 29.0 = 32$ dB(μ V/m).

Level in μ V/m = Common Antilogarithm [$(32 \text{ dB}\mu\text{V/m})/20$] = 39.8 μ V/m.

Test Result

The data below shows the significant emission frequencies, the limit and the margin of compliance.

The EUT passed 0.2dB.



Radiated emissions at fundamental frequency

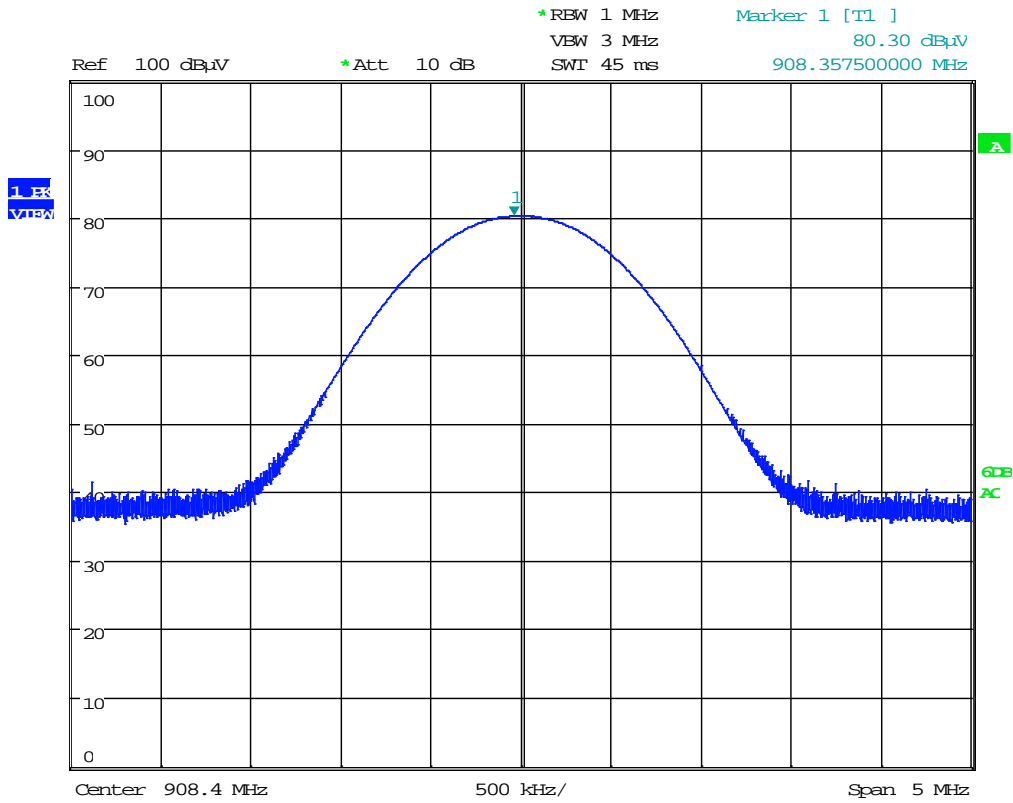

Date: 11.FEB.2016 16:38:43

The Field Strength of Fundamental at a distance of 3 meters is 75.2 dBuV (margin to Fundamental frequency Field Strength limit by 18.8 dB).

Note:

RA = 80.3 dB(µV)

AF = 22.20 dB(1/m)

CF = 4.0 dB

AG = 31.3 dB

FS = 80.3 + 22.2 + 4.0 - 31.3 = 75.2 dB(µV/m).

Note: The supply voltage was varied between 85% and 115% of the nominal rated Voltage. No Fundamental frequency Field Strength variation was observed.



Transmitter Radiated Emissions below 1GHz

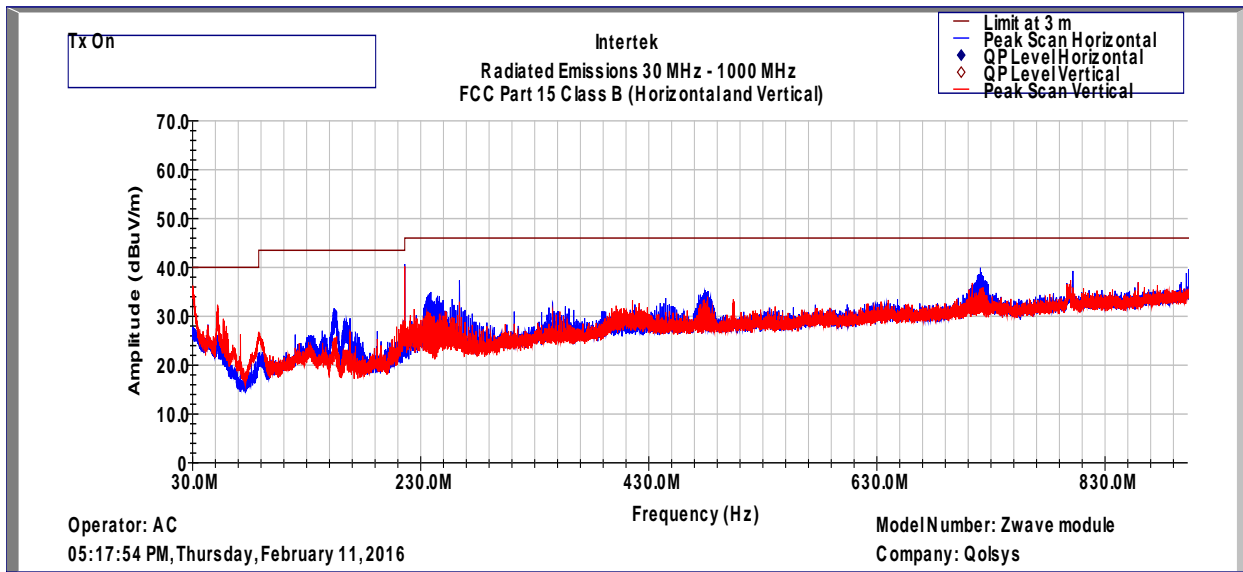

Plot 1: Spurious Emissions, 30MHz to 902MHz, Peak

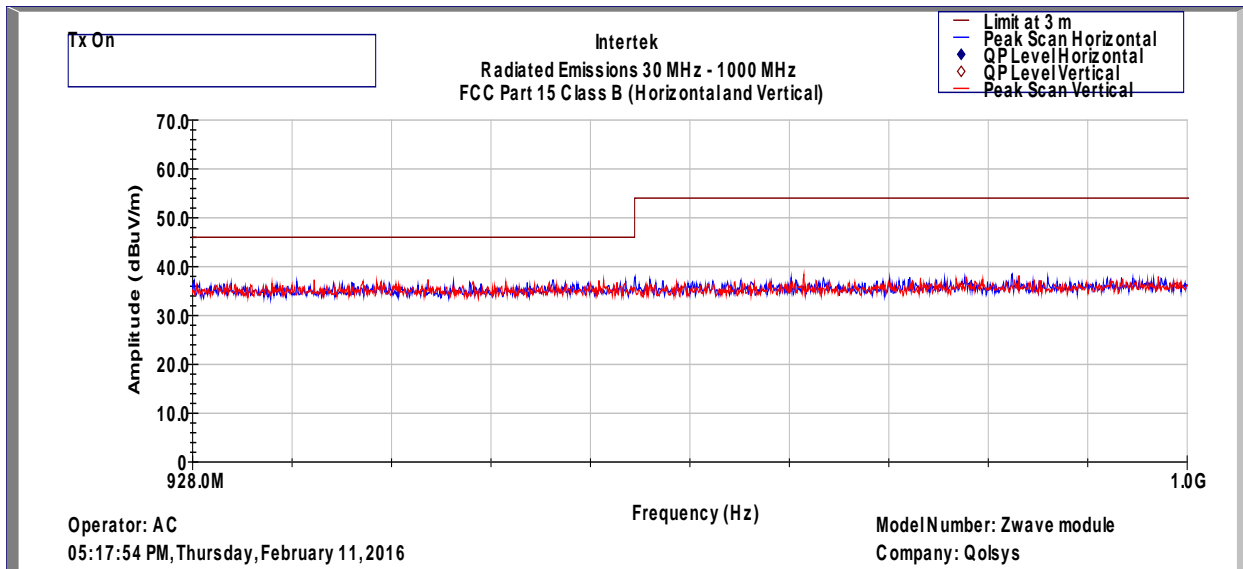

Plot 2: Spurious Emissions, 928MHz to 1000MHz, Peak

Transmitter Radiated Emissions above 1GHz

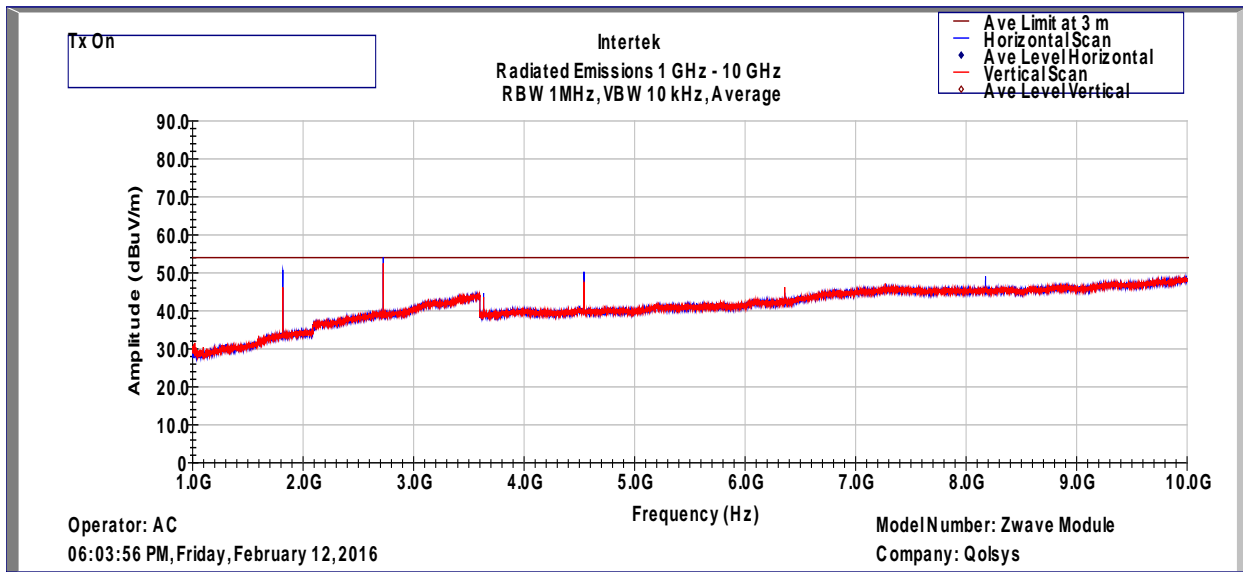

Plot 3: Spurious Emissions, 1GHz to 10GHz, Average

Frequency MHz	Ave Level (dBuV/m)	Limit@3m (dBuV/m)	Ave Margin (dB)	Raw (dBuV)	Cable (dB)	AF dB(1/m)
1816.750	50.7	54	-3.3	20.8	2.9	27.1
2725.250	53.8	54	-0.2	20.6	3.8	29.4
3633.750	44.6	54	-9.4	8	4.7	32
4542.000	50.3	54	-3.7	12.7	5.1	32.4

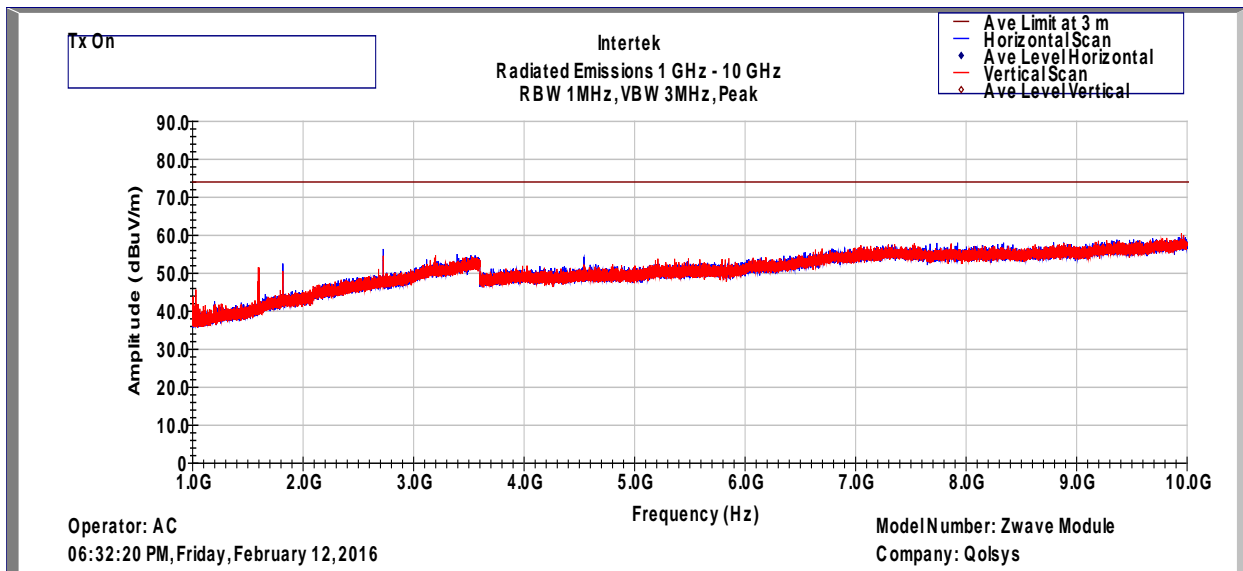

Plot 4: Spurious Emission, 1GHz to 10GHz, Peak

Test setup photographs

The following photographs show the testing configurations used.

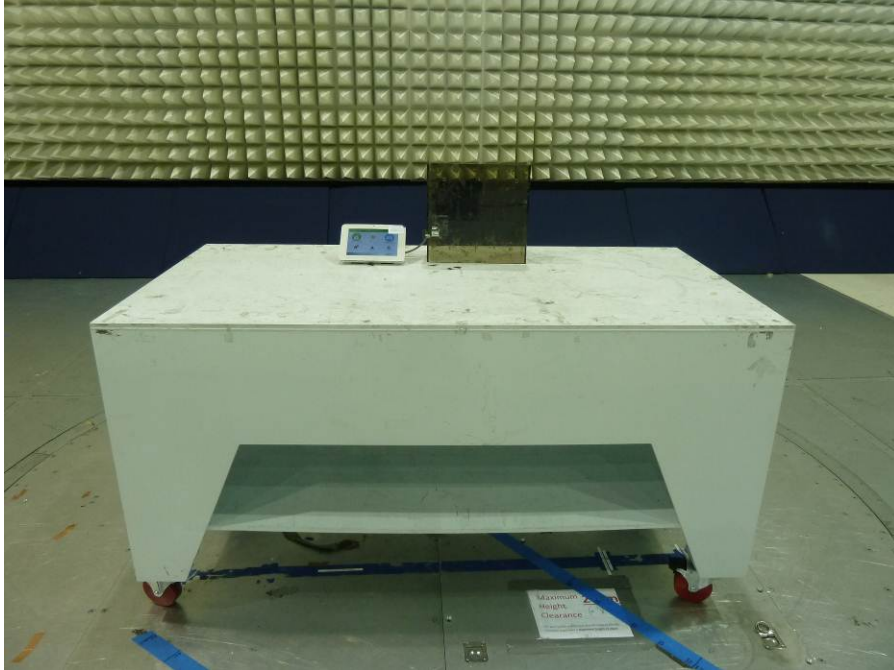

Test setup photographs (Continued)

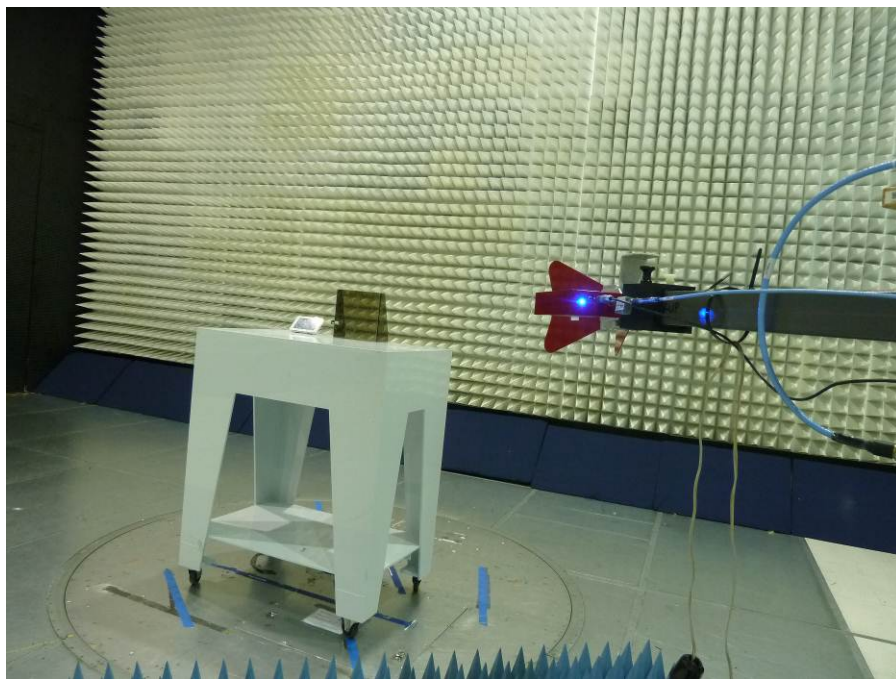
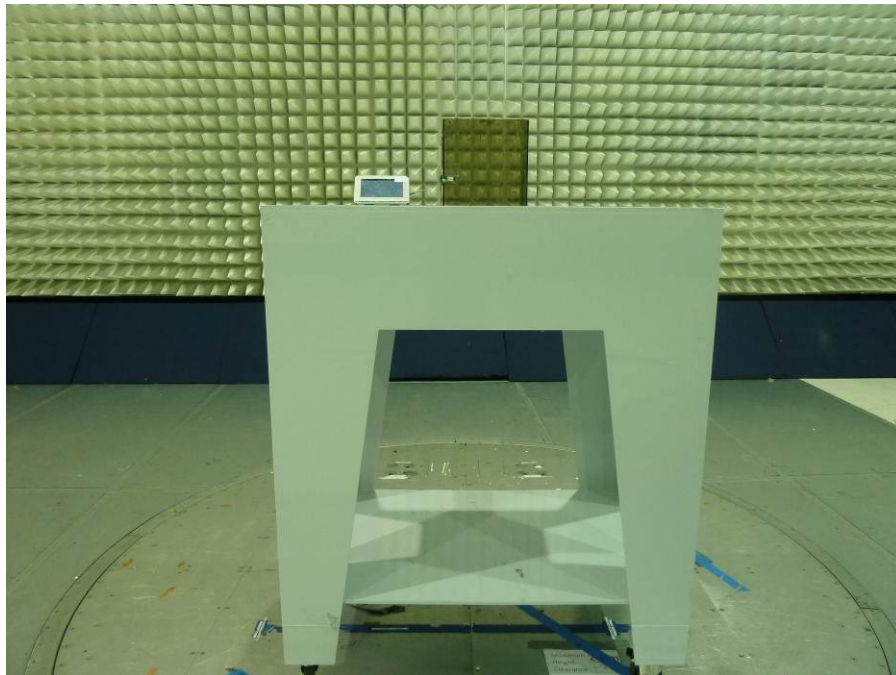

4.2 Occupied Bandwidth
FCC Rules: 15.215(c); IC Rules: RSS-Gen

Requirements

No limits for 20 dB Bandwidth and Occupied Bandwidths.

Procedure

The antenna port of the EUT was connected to the input of a spectrum analyzer (SA). For each RF output channel investigated, the spectrum analyzer center frequency was set to the channel carrier. A PEAK output reading was taken, a DISPLAY line was drawn 20 dB lower than PEAK level. The 20 dB bandwidth was determined from where the channel output spectrum intersected the marker delta.

The occupied bandwidth was measured using the built-in spectrum analyzer function for 99% power bandwidth measurement.

Test Results

Frequency MHz	20-dB bandwidth kHz	Occupied bandwidth kHz
908.4	86.460	84.350

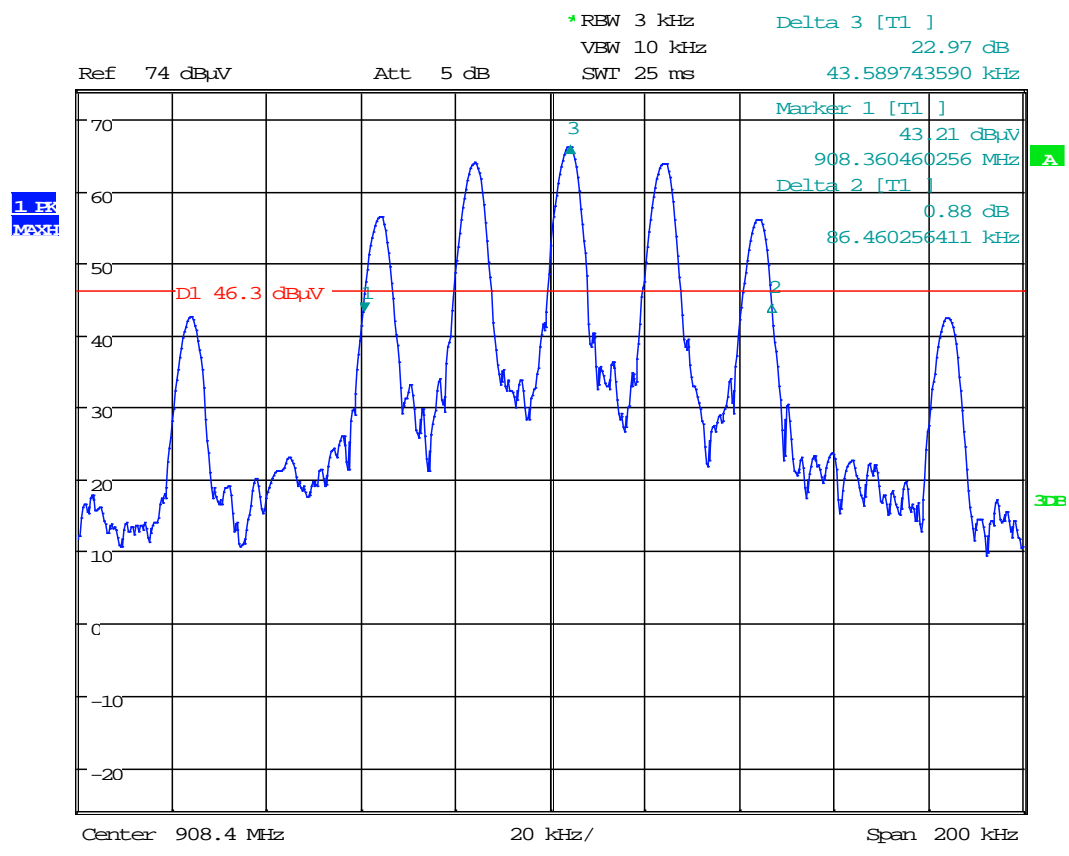

Date: 10.FEB.2016 07:58:47

Plot 1: 20dB Bandwidth

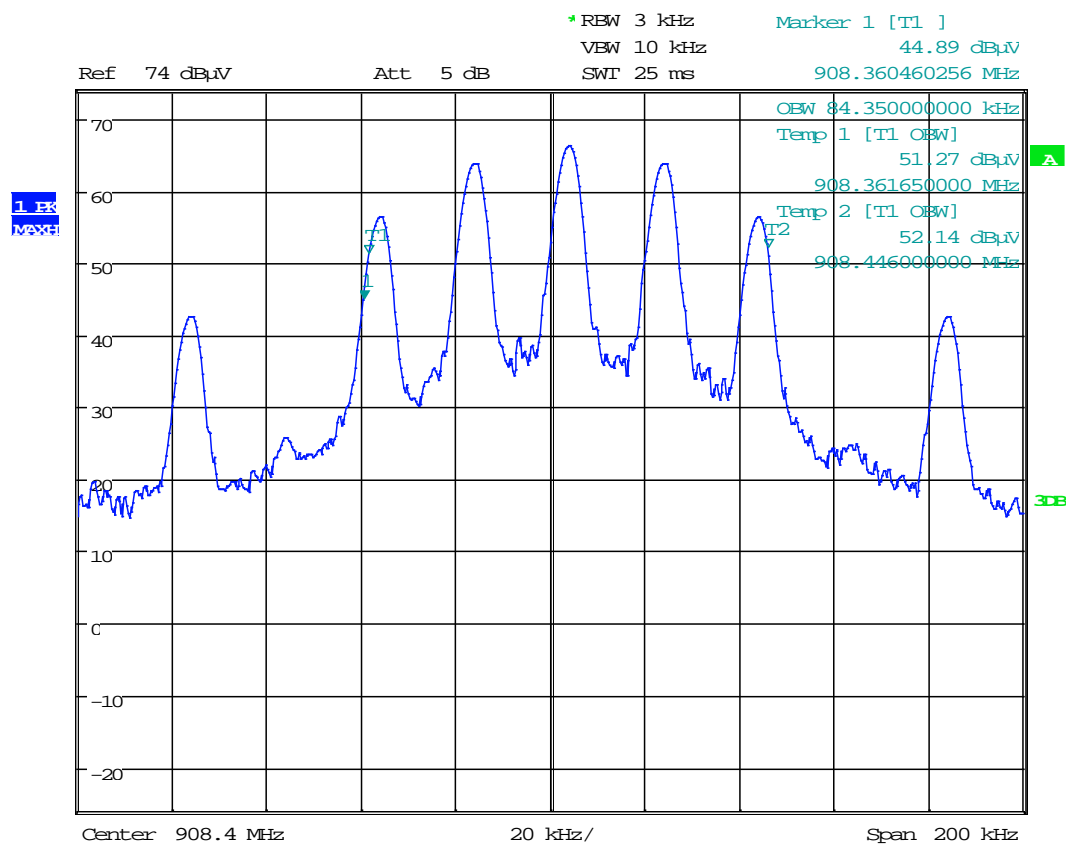

Date: 10.FEB.2016 07:59:46

Plot 2: 99% Bandwidth

4.3 Radiated Emissions from Digital Parts
FCC Ref: 15.109

Requirements

*Limits for Electromagnetic Radiated Emissions, FCC Section 15.109(b) and ICES 003 **

Frequency (MHz)	Class A at 10m dB(μV/m)	Class B at 3m dB(μV/m)
30-88	39	40.0
88-216	43.5	43.5
216-960	46.4	46.0
Above 960	49.5	54.0

* According to FCC Part 15.109(g) an alternative to the radiated emission limits shown above, digital devices may be shown to comply with the limit of CISPR Pub. 22

Procedure

Measurements are conducted with a quasi-peak detector instrument in the frequency range of 30 MHz to 1000 MHz and with the average detector instrument in the frequency range above 1000 MHz. The measuring receiver meets the requirements of Section One of CISPR 16 and the measuring antenna correlates to a balanced dipole.

Measurements of the radiated field are made with the antenna located at a distance of 10 meters from the EUT. If the field-strength measurements at 10m cannot be made because of high ambient noise level or for other reasons, measurements of Class B equipment may be made at a closer distance, for example 3m. An inverse proportionality factor of 20 dB per decade should be used to normalize the measured data to the specified distance for determining compliance.

The antenna is adjusted between 1m and 4m in height above the ground plane for maximum meter reading at each test frequency.

The antenna-to-EUT azimuth is varied during the measurement to find the maximum field-strength readings.

The antenna-to-EUT polarization (horizontal and vertical) is varied during the measurements to find the maximum field-strength readings.

The EUT, where intended for tabletop use, is placed on a table whose top is 0.8m above the ground plane. The table is constructed of non-conductive materials. Its dimensions are 1m by 1.5m, but may be extended for a larger EUT.

Floor standing EUTs are placed on a horizontal metal ground plane and isolated from the ground plane by 3 to 12 mm of insulating material.

Equipment setup for radiated disturbance tests followed the guidelines of ANSI C63.4.

Example Field Strength Calculation

The field strength is calculated by adding the Antenna Factor and Cable Factor to from the measured reading, followed by subtracting the Amplifier Gain (if any) and Distance Correction Factor (if any). The basic equation with a sample calculation is as follows:

$$FS = RA + AF + CF - PA - DCF$$

Where

FS = Field Strength in dB ($\mu\text{V}/\text{m}$)

RA = Receiver Amplitude (including preamplifier) in dB (μV)

CF = Cable Attenuation Factor in dB

AF = Antenna Factor in dB (1/m)

AG = Amplifier Gain in dB

DCF=Distance Correction Factor in dB

(Formula: $DCF = 20\log_{10}(\text{measurement distance}/\text{specification distance})$)

Assume a receiver reading of 52.0 dB (μV) is obtained. The antenna factor of 7.4 dB and cable factor of 1.6 dB is added. The amplifier gain of 29 dB and DCF of 10.5 dB (DCF in this example: $20\log_{10}(10/3)$) is subtracted, giving field strength of 21.5 dB ($\mu\text{V}/\text{m}$).

$$RA = 52.0 \text{ dB } (\mu\text{V})$$

$$AF = 7.4 \text{ dB } (1/\text{m})$$

$$CF = 1.6 \text{ dB}$$

$$AG = 29.0 \text{ dB}$$

$$DCF=10.5 \text{ dB}$$

$$FS = RF + AF + CF - AG - DCF$$

$$FS = 52.0 + 7.4 + 1.6 - 29.0 - 10.5$$

$$FS = 21.5 \text{ dB } (\mu\text{V}/\text{m})$$

Test Results

Radiated emission measurements were performed from 30 MHz to 1000 MHz. Spectrum Analyzer Resolution Bandwidth is 100 kHz or greater below 1000 MHz and 1 MHz - above 1000 MHz.

The EUT passed 6.6dB for Class B.



FCC and ICES 003, Radiated Disturbance

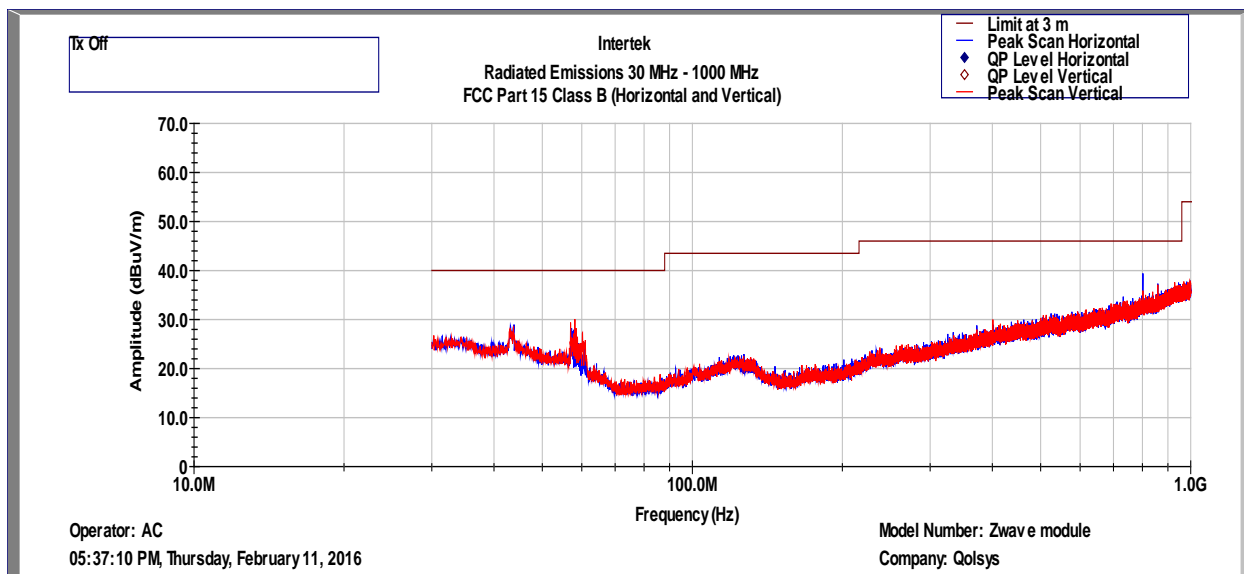

Intertek Testing Services
Radiated Emissions 30 MHz - 1000 MHz
FCC Part 15 Class B (QP-Vertical)

Operator: AC
February 11, 2016

Model Number: Zwave module
Company: Qolsys, Inc

Frequency	Quasi Pk FS	Limit@10m	Margin	RA	CF	AG	DCF	AF
MHz	dB(uV/m)	dB(uV/m)	dB	dB	dB	dB	dB	dB(1/m)
43.774	28.7	40	-11.3	33.8	0.7	32	10.5	15.6
56.966	29.4	40	-10.6	38	0.8	32	10.5	12
58.130	30.1	40	-9.9	39.1	0.8	32	10.5	11.6

FCC Part 15 Class B (QP-Horizontal)

Frequency	Quasi Pk FS	Limit@10m	Margin	RA	CF	AG	DCF	AF
MHz	dB(uV/m)	dB(uV/m)	dB	dB	dB	dB	dB	dB(1/m)
43.871	29	40	-11	34.1	0.7	32	10.5	15.6
57.257	28.2	40	-11.8	36.9	0.8	32	10.5	11.9
801.829	39.4	46	-6.6	35.9	3.8	31.9	10.5	21.1

Test Mode: Digital Parts Emissions
Temperature: 24.5 C
Humidity : 44 %



FCC and ICES 003, Radiated Disturbance

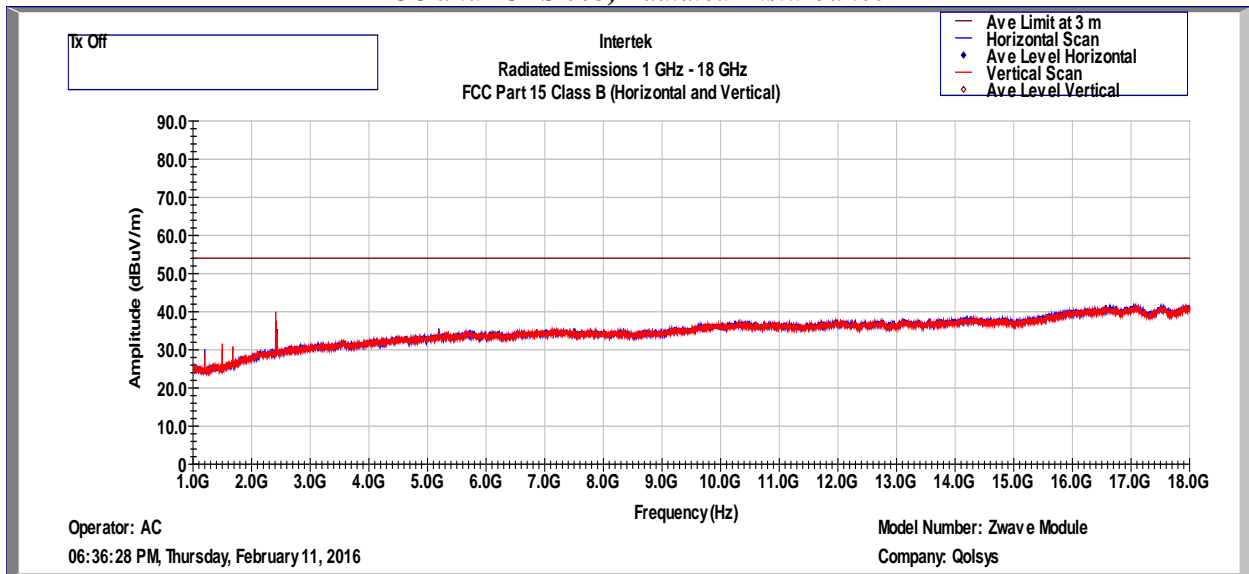

Test setup photographs

The following photographs show the testing configurations used.



Test setup photographs (Continued)

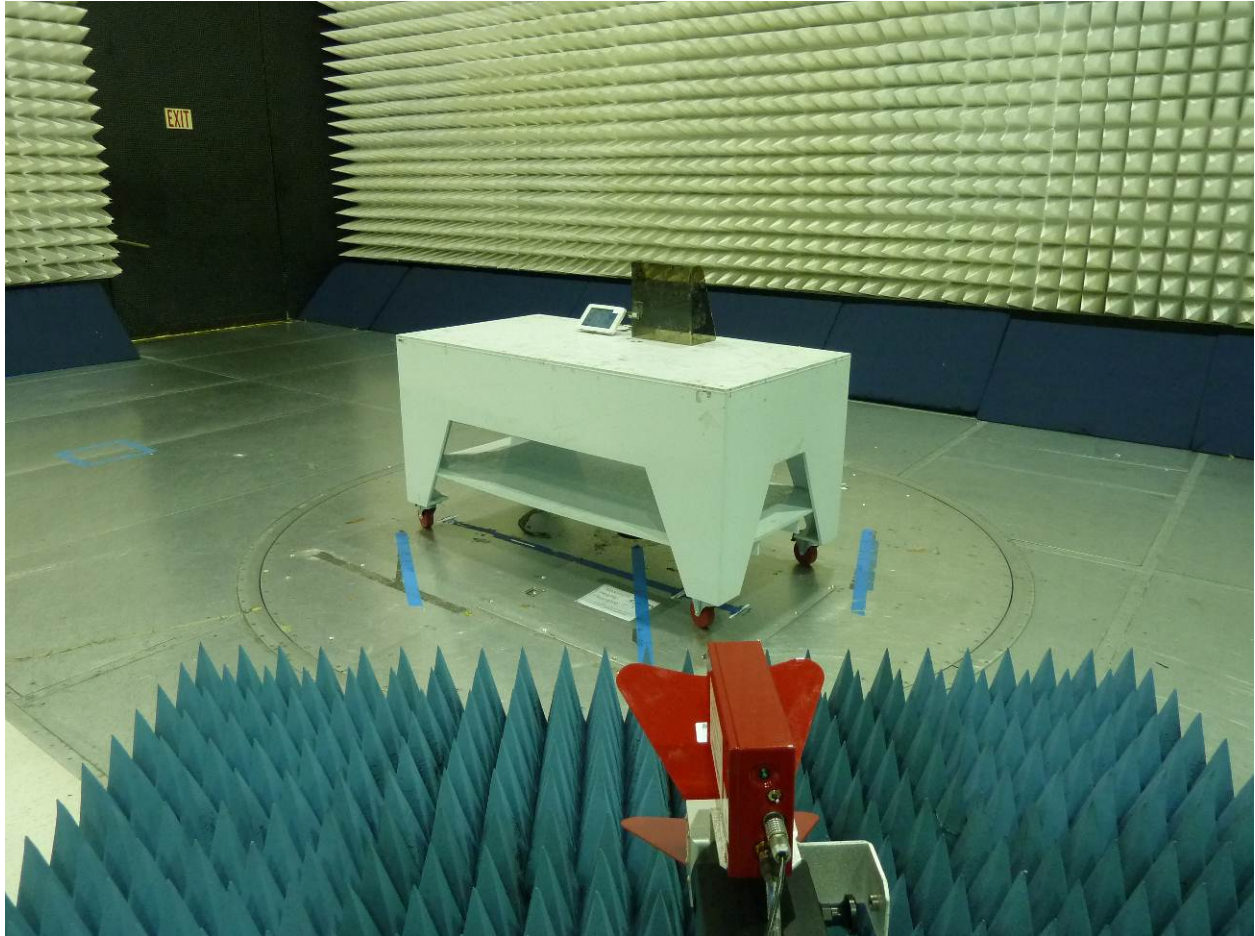

4.4 Line Conducted Emissions
 FCC Rules: 15.207; IC Rules: RSS-Gen
 FCC Rules: 15.107; IC Rules: ICES 003

Requirements

Frequency Band MHz	Class B Limit dB(μV)	
	Quasi-Peak	Average
0.15-0.50	66 to 56 *	56 to 46 *
0.50-5.00	56	46
5.00-30.00	60	50

*Note: *Decreases linearly with the logarithm of the frequency
 At the transition frequency the lower limit applies.*

Procedure

Measurements are carried out using quasi-peak and average detector receivers in accordance with CISPR 16. An AMN is required to provide defined impedance at high frequencies across the power feed at the point of measurement of terminal voltage and also to provide isolation of the circuit under test from the ambient noise on the power lines. An AMN as defined in CISPR 16 shall be used.

The EUT is located so that the distance between the boundary of the EUT and the closest surface of the AMN is 0.8m.

Where a flexible mains cord is provided by the manufacturer, this shall be 1m long or if in excess of 1m, the excess cable is folded back and forth as far as possible so as to form a bundle not exceeding 0.4m in length.

The EUT is arranged and connected with cables terminated in accordance with the product specification.

Conducted disturbance is measured between the phase lead and the reference ground, and between the neutral lead and the reference ground. Both measured values are reported.

The EUT, where intended for tabletop use, is placed on a table whose top is 0.8m above the ground plane. A vertical, metal reference plane is placed 0.4m from the EUT. The vertical metal reference-plane is at least 2m by 2m. The EUT shall be kept at least 0.8m from any other metal surface or other ground plane not being part of the EUT. The table is constructed of non-conductive materials. Its dimensions are 1m by 1.5m, but may be extended for larger EUT.

Floor standing EUT are placed on a horizontal metal ground plane and isolated from the ground plane by resting on an insulating material. The metal ground plane extends at least 0.5m beyond the boundaries of the EUT and has minimum dimensions of 2m by 2m.

Equipment setup for conducted disturbance tests followed the guidelines of ANSI C63.4.

Test Result

AC Line Conducted Emission Data, EUT in transmitting mode

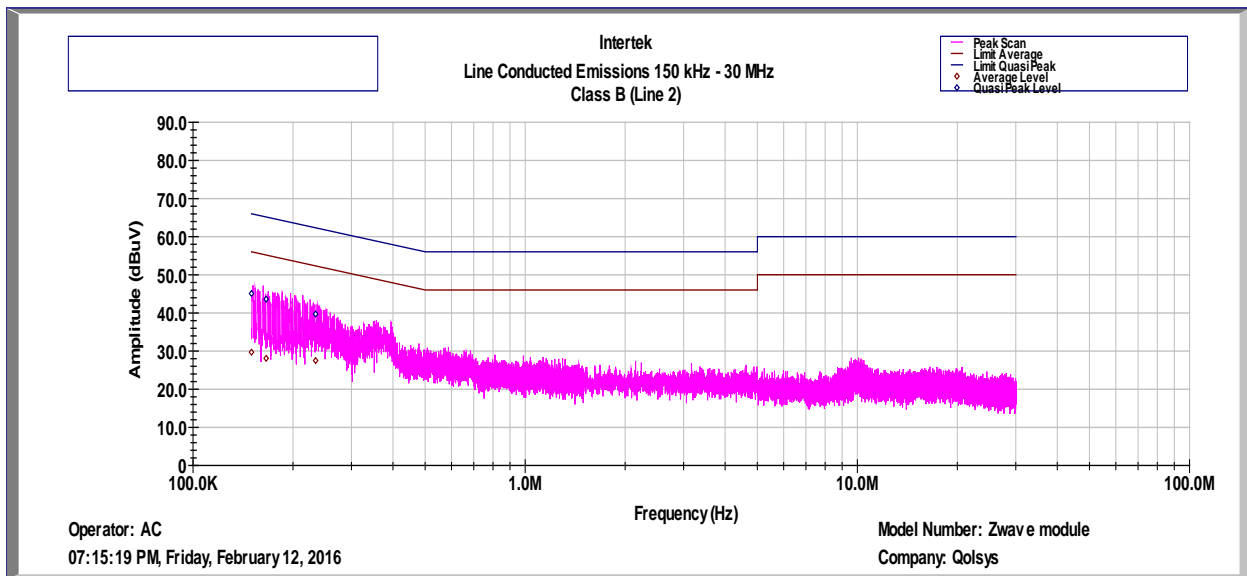
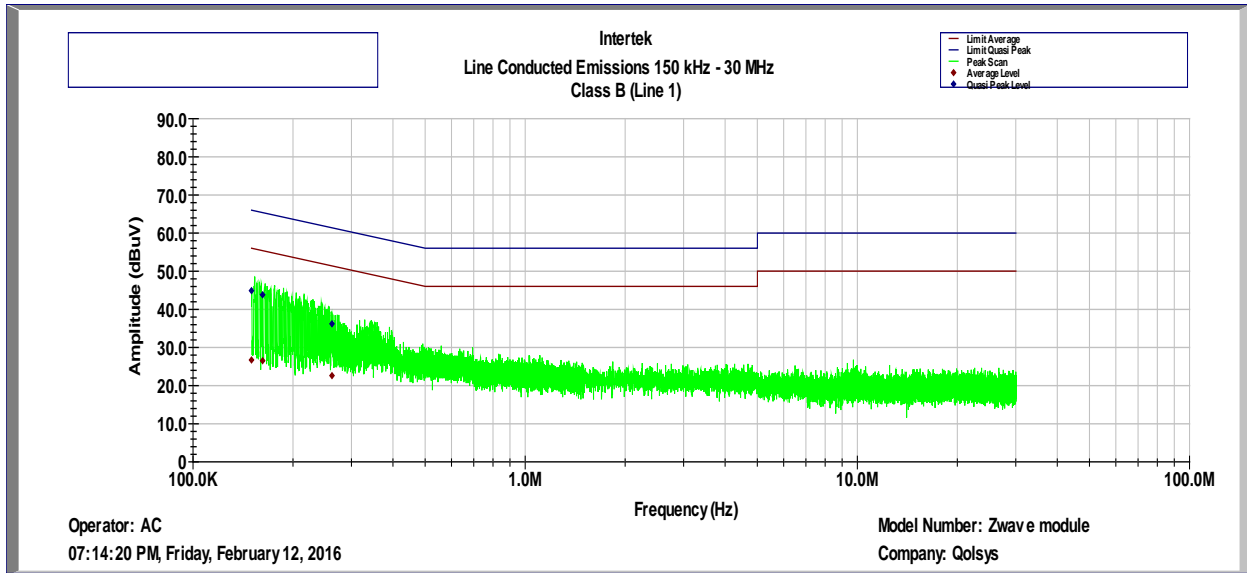

Frequency	Av Level	QP Level	Av Limit	QP Limit	Av Margin	QP Margin	Line
MHz	(dBuV)	(dBuV)	(dBuV)	(dBuV)	(dB)	(dB)	
0.15	26.7	44.9	56	66	-29.3	-21.1	Line
0.162	26.5	43.8	55.7	65.7	-29.2	-21.9	Line
0.262	22.6	36.2	52.8	62.8	-30.2	-26.6	Line
0.15	29.7	45.1	56	66	-26.3	-20.9	Neutral
0.166	28.1	43.6	55.5	65.5	-27.4	-21.9	Neutral
0.234	27.5	39.7	53.6	63.6	-26.1	-23.9	Neutral

Results ■ Complies by 20.9dB

AC Line Conducted Emission Data, EUT in Receive mode

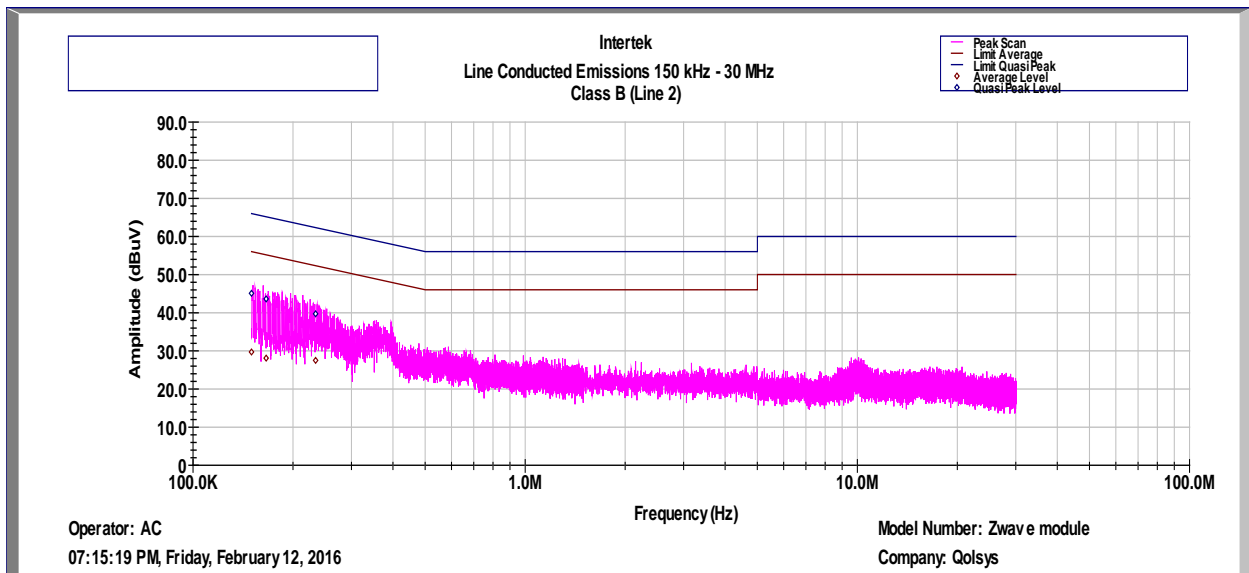
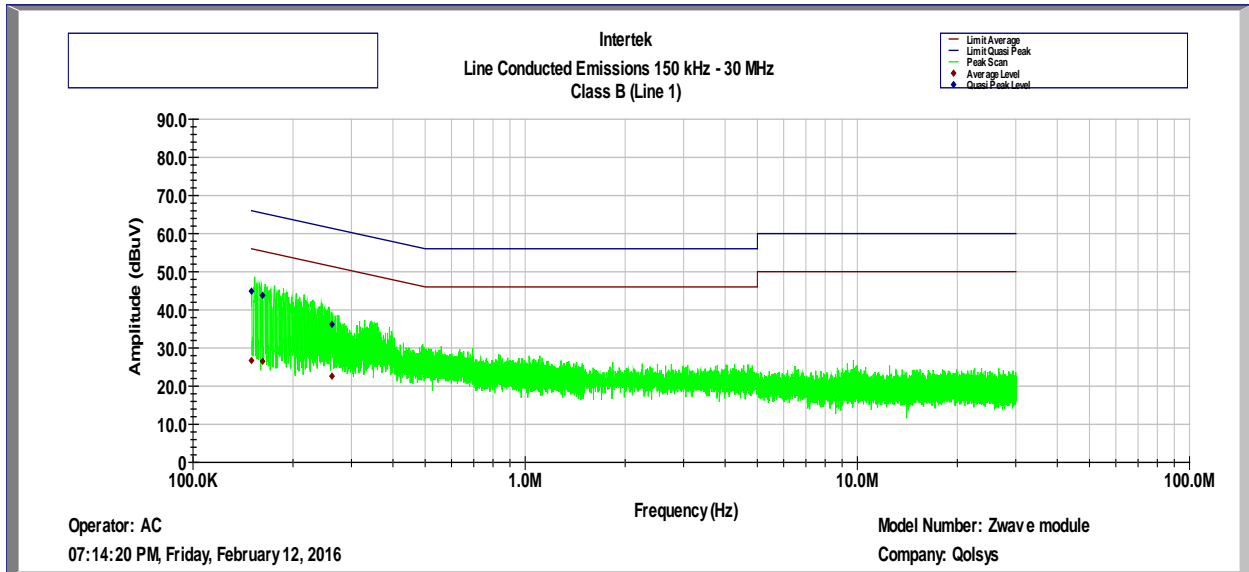

Frequency	Av Level	QP Level	Av Limit	QP Limit	Av Margin	QP Margin	Line
MHz	(dBuV)	(dBuV)	(dBuV)	(dBuV)	(dB)	(dB)	
0.15	26.7	44.9	56	66	-29.3	-21.1	Line
0.162	26.5	43.8	55.7	65.7	-29.2	-21.9	Line
0.262	22.6	36.2	52.8	62.8	-30.2	-26.6	Line
0.15	29.7	45.1	56	66	-26.3	-20.9	Neutral
0.166	28.1	43.6	55.5	65.5	-27.4	-21.9	Neutral
0.234	27.5	39.7	53.6	63.6	-26.1	-23.9	Neutral

Results	Complies by 20.9dB
----------------	---------------------------

Test setup photographs

The following photographs show the testing configurations used.

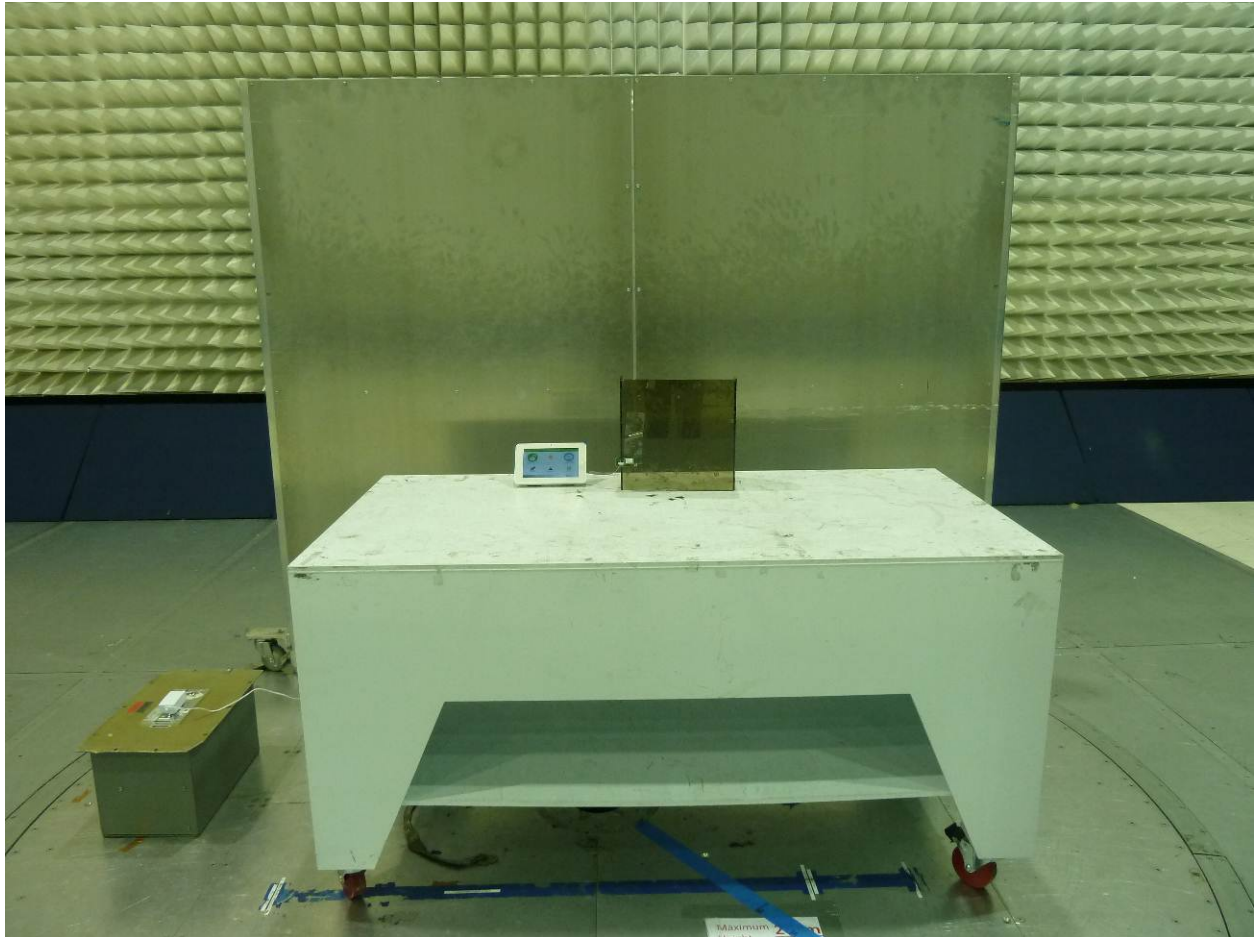

5.0 List of Test Equipment

Measurement equipment used for emission compliance testing utilized the equipment on the following list:

Equipment	Manufacturer	Model/Type	Asset #	Cal Int	Cal Due
EMI Receiver	Rohde & Schwarz	ESU	ITS 00961	12	06/02/16
Bi-Log Antenna	ARA	LPB-2513/A	ITS 0355	12	09/11/16
Horn Antenna	ETS Lindgren	3117	01325	12	11/23/16
Preamp	Miteq	AMF-4D-001180-24-10P	00526	12	10/06/16
Pre-Amplifier	Sonoma Instrument	310	ITS 00942	12	01/07/17
LISN	FCC	FCC-LISN-50-50-M-H	ITS 02011	12	06/02/16

No Calibration required

6.0 Document History

Revision/ Job Number	Writer Initials	Reviewer Initials	Date	Change
1.0 / G102374971	AC	KV	March 29, 2016	Original document