



**CFR 47 FCC PART 15 SUBPART C
ISED RSS-247 ISSUE 2**

CERTIFICATION TEST REPORT

For

Tablet

MODEL NUMBER: IQ Remote

FCC ID: 2AAJXQS-IQRT2

IC: 11205A-QSIQRT2

REPORT NUMBER: 4790411210.2-3

ISSUE DATE: June 10, 2022

Prepared for

Qolsys, Inc.

1919 S. Bascom Ave. Suite 600, Campbell, California, 95008 United States

Prepared by

UL Verification Services (Guangzhou) Co., Ltd, Song Shan Lake Branch

Building 10, Innovation Technology Park, No. 1, Li Bin Road, Song Shan Lake Hi-Tech Development Zone Dongguan, 523808, People's Republic of China

Tel: +86 769 22038881

Fax: +86 769 33244054

Website: www.ul.com



Revision History

<u>Rev.</u>	<u>Issue Date</u>	<u>Revisions</u>	<u>Revised By</u>
V0	6/10/2022	Initial Issue	



Summary of Test Results			
Clause	Test Items	FCC/ISED Rules	Test Results
1	6dB Bandwidth and 99% Occupied Bandwidth	FCC Part 15.247 (a) (2) RSS-247 Clause 5.2 (a) ISED RSS-Gen Clause 6.7	Pass
2	Conducted Output Power	FCC Part 15.247 (b) (3) RSS-247 Clause 5.4 (d)	Pass
3	Power Spectral Density	FCC Part 15.247 (e) RSS-247 Clause 5.2 (b)	Pass
4	Conducted Bandedge and Spurious Emission	FCC Part 15.247 (d) RSS-247 Clause 5.5	Pass
5	Radiated Bandedge and Spurious Emission	FCC Part 15.247 (d) FCC Part 15.209 FCC Part 15.205 RSS-247 Clause 5.5 RSS-GEN Clause 8.9	Pass
6	Conducted Emission Test for AC Power Port	FCC Part 15.207 RSS-GEN Clause 8.8	Pass
7	Antenna Requirement	FCC Part 15.203 RSS-GEN Clause 6.8	Pass
Note: 1. This test report is only published to and used by the applicant, and it is not for evidence purpose in China. 2. The measurement result for the sample received is <Pass> according to < CFR 47 FCC PART 15 SUBPART C >> ISED RSS-247 > when <Accuracy Method> decision rule is applied.			



TABLE OF CONTENTS

1. ATTESTATION OF TEST RESULTS	6
2. TEST METHODOLOGY	7
3. FACILITIES AND ACCREDITATION	7
4. CALIBRATION AND UNCERTAINTY	8
4.1. <i>MEASURING INSTRUMENT CALIBRATION</i>	8
4.2. <i>MEASUREMENT UNCERTAINTY</i>	8
5. EQUIPMENT UNDER TEST	9
5.1. <i>DESCRIPTION OF EUT</i>	9
5.2. <i>CHANNEL LIST</i>	9
5.3. <i>MAXIMUM OUTPUT POWER</i>	10
5.4. <i>TEST CHANNEL CONFIGURATION</i>	10
5.5. <i>THE WORSE CASE POWER SETTING PARAMETER</i>	10
5.6. <i>THE WORSE CASE CONFIGURATIONS</i>	11
5.7. <i>DESCRIPTION OF AVAILABLE ANTENNAS</i>	12
5.8. <i>DESCRIPTION OF TEST SETUP</i>	13
6. MEASURING INSTRUMENT AND SOFTWARE USED	14
7. ANTENNA PORT TEST RESULTS	16
7.1. <i>ON TIME AND DUTY CYCLE</i>	16
7.2. <i>6 dB DTS BANDWIDTH AND 99 % OCCUPIED BANDWIDTH</i>	17
7.3. <i>CONDUCTED OUTPUT POWER</i>	19
7.4. <i>POWER SPECTRAL DENSITY</i>	21
7.5. <i>CONDUCTED BANDEDGE AND SPURIOUS EMISSIONS</i>	23
8. RADIATED TEST RESULTS	25
8.1. <i>RESTRICTED BANDEDGE</i>	31
8.1.1. <i>802.11b MODE</i>	31
8.1.2. <i>802.11g MODE</i>	35
8.1.3. <i>802.11n HT20 MODE</i>	39
8.2. <i>SPURIOUS EMISSIONS (1 GHz ~ 3 GHz)</i>	43
8.2.1. <i>802.11b MODE</i>	43
8.3. <i>SPURIOUS EMISSIONS (3 GHz ~ 18 GHz)</i>	49
8.3.1. <i>802.11b MODE</i>	49
8.3.2. <i>802.11g MODE</i>	55
8.3.3. <i>802.11n HT20 MODE</i>	61
8.4. <i>SPURIOUS EMISSIONS (18 GHz ~ 26 GHz)</i>	67



8.4.1.	802.11b MODE.....	67
8.5.	<i>SPURIOUS EMISSIONS (30 MHz ~ 1 GHz)</i>	69
8.5.1.	802.11b MODE.....	69
8.6.	<i>SPURIOUS EMISSIONS BELOW 30 MHz</i>	71
8.6.1.	802.11b MODE.....	71
9.	AC POWER LINE CONDUCTED EMISSIONS	74
9.1.	<i>802.11b MODE</i>	75
10.	ANTENNA REQUIREMENTS	77
11.	Appendix	78
11.1.	<i>Appendix A: DTS Bandwidth</i>	78
11.1.1.	Test Result.....	78
11.1.2.	Test Graphs	79
11.2.	<i>Appendix B: Occupied Channel Bandwidth</i>	82
11.2.1.	Test Result.....	82
11.2.2.	Test Graphs	83
11.3.	<i>Appendix C: Maximum conducted Average output power</i>	86
11.3.1.	Test Result.....	86
11.4.	<i>Appendix D: Maximum Average power spectral density</i>	87
11.4.1.	Test Result.....	87
11.4.2.	Test Graphs	88
11.5.	<i>Appendix E: Band edge measurements</i>	91
11.5.1.	Test Result.....	91
11.5.2.	Test Graphs	92
11.6.	<i>Appendix F: Conducted Spurious Emission</i>	94
11.6.1.	Test Result.....	94
11.6.2.	Test Graphs	95
11.7.	<i>Appendix G: Duty Cycle</i>	104
11.7.1.	Test Result.....	104
11.7.2.	Test Graphs	105



1. ATTESTATION OF TEST RESULTS

Applicant Information

Company Name: Qolsys, Inc.
Address: 1919 S. Bascom Ave. Suite 600, Campbell, California, 95008
United States

Manufacturer Information

Company Name: Chengdu Vantron Technology Co., Ltd.
Address: No.5 GaoPeng Road, Hi-Tech Zone, Chengdu, SiChuan, P.R.
China

EUT Information

EUT Name: Tablet Computer
Model: IQ Remote
Brand: /
Sample Received Date: May 25, 2022
Sample Status: Normal
Sample ID: 4986388
Date of Tested: May 25, 2022~ June 10, 2022

APPLICABLE STANDARDS	
STANDARD	TEST RESULTS
CFR 47 FCC PART 15 SUBPART C	PASS
ISED RSS-247 Issue 2	PASS
ISED RSS-GEN Issue 5	PASS

Prepared By:

Kebo Zhang
Project Engineer

Checked By:

Shawn Wen
Laboratory Leader

Approved By:

Stephen Guo
Laboratory Manager



2. TEST METHODOLOGY

The tests documented in this report were performed in accordance with KDB 558074 D01 15.247 Meas Guidance v05r02, KDB 414788 D01 Radiated Test Site v01r01, CFR 47 FCC Part 2, CFR 47 FCC Part 15, ANSI C63.10-2013, ISED RSS-247 Issue 2 and ISED RSS-GEN Issue 5.

3. FACILITIES AND ACCREDITATION

Accreditation Certificate	<p>A2LA (Certificate No.: 4102.01) UL Verification Services (Guangzhou) Co., Ltd. Song Shan Lake Branch. has been assessed and proved to be in compliance with A2LA.</p> <p>FCC (FCC Designation No.: CN1187) UL Verification Services (Guangzhou) Co., Ltd. Song Shan Lake Branch. Has been recognized to perform compliance testing on equipment subject to the Commission's Declaration of Conformity (DoC) and Certification rules</p> <p>ISED (Company No.: 21320) UL Verification Services (Guangzhou) Co., Ltd. Song Shan Lake Branch. has been registered and fully described in a report filed with ISED. The Company Number is 21320 and the test lab Conformity Assessment Body Identifier (CABID) is CN0046.</p> <p>VCCI (Registration No.: G-20019, R-20004, C-20012 and T-20011) UL Verification Services (Guangzhou) Co., Ltd. Song Shan Lake Branch. has been assessed and proved to be in compliance with VCCI, the Membership No. is 3793. Facility Name: Chamber D, the VCCI registration No. is G-20019 and R-20004 Shielding Room B , the VCCI registration No. is C-20012 and T-20011</p>
---------------------------	--

Note 1: All tests measurement facilities use to collect the measurement data are located at Building 10, Innovation Technology Park, Song Shan Lake Hi tech Development Zone, Dongguan, 523808, China

Note 2: The test anechoic chamber in UL Verification Services (Guangzhou) Co., Ltd. Song Shan Lake Branch had been calibrated and compared to the open field sites and the test anechoic chamber is shown to be equivalent to or worst case from the open field site.

Note 3: For below 30 MHz, lab had performed measurements at test anechoic chamber and comparing to measurements obtained on an open field site. And these measurements below 30 MHz had been correlated to measurements performed on an OFS.



4. CALIBRATION AND UNCERTAINTY

4.1. MEASURING INSTRUMENT CALIBRATION

The measuring equipment utilized to perform the tests documented in this report has been calibrated in accordance with the manufacturer's recommendations and is traceable to recognize national standards.

4.2. MEASUREMENT UNCERTAINTY

Where relevant, the following measurement uncertainty levels have been estimated for tests performed on the apparatus:

Test Item	Uncertainty
Conduction emission	3.62 dB
Radiated Emission (Included Fundamental Emission) (9 kHz ~ 30 MHz)	2.2 dB
Radiated Emission (Included Fundamental Emission) (30 MHz ~ 1 GHz)	4.00 dB
Radiated Emission (Included Fundamental Emission) (1 GHz to 26 GHz)	5.78 dB (1 GHz ~ 18 GHz)
	5.23 dB (18 GHz ~ 26 GHz)
Duty Cycle	±0.028%
DTS and 99% Occupied Bandwidth	±0.0196%
Maximum Conducted Output Power	±0.686 dB
Maximum Power Spectral Density Level	±0.743 dB
Conducted Band-edge Compliance	±1.328 dB
Conducted Unwanted Emissions In Non-restricted Frequency Bands	±0.746 dB (9 kHz ~ 1 GHz)
	±1.328dB (1 GHz ~ 26 GHz)
Note: This uncertainty represents an expanded uncertainty expressed at approximately the 95% confidence level using a coverage factor of k=2.	



5. EQUIPMENT UNDER TEST

5.1. DESCRIPTION OF EUT

EUT Name:	Tablet Computer
Model Name:	IQ Remote
Radio Technology	IEEE802.11b/g/n HT20
Operation frequency	IEEE 802.11b: 2412MHz ~ 2462MHz IEEE 802.11g: 2412MHz ~ 2462MHz IEEE 802.11n HT20: 2412MHz ~ 2462MHz
Modulation	IEEE 802.11b: DSSS (CCK) IEEE 802.11g: OFDM (64QAM, 16QAM, QPSK, BPSK) IEEE 802.11n HT20: OFDM (64QAM, 16QAM, QPSK, BPSK)
Battery	DC 3.7V, 2400 mA
DC Power Supply	DC 7 V, 1 A via adapter

5.2. CHANNEL LIST

Channel List for 802.11b/g/n (20 MHz)							
Channel	Frequency (MHz)	Channel	Frequency (MHz)	Channel	Frequency (MHz)	Channel	Frequency (MHz)
1	2412	4	2427	7	2442	10	2457
2	2417	5	2432	8	2447	11	2462
3	2422	6	2437	9	2452	/	/

**5.3. MAXIMUM OUTPUT POWER**

IEEE Std. 802.11	Frequency (MHz)	Channel Number	Maximum Conducted AVG Output Power (dBm)
b	2412 ~ 2462	1-11[11]	14.74
g	2412 ~ 2462	1-11[11]	14.46
n HT20	2412 ~ 2462	1-11[11]	14.44

5.4. TEST CHANNEL CONFIGURATION

IEEE Std. 802.11	Test Channel Number	Frequency
b	CH 1(Low Channel), CH 6(MID Channel), CH 11(High Channel)	2412 MHz, 2437 MHz, 2462 MHz
g	CH 1(Low Channel), CH 6(MID Channel), CH 11(High Channel)	2412 MHz, 2437 MHz, 2462 MHz
n HT20	CH 1(Low Channel), CH 6(MID Channel), CH 11(High Channel)	2412 MHz, 2437 MHz, 2462 MHz

5.5. THE WORSE CASE POWER SETTING PARAMETER

The Worse Case Power Setting Parameter under 2400 ~ 2483.5MHz Band							
Test Software		Putty					
Modulation Mode	Transmit Antenna Number	Test Channel					
		NCB: 20MHz			NCB: 40MHz		
		CH 1	CH 6	CH 11	CH 3	CH 6	CH 9
802.11b	1	59	60	60	/		
802.11g	1	56	56	56			
802.11n HT20	1	58	58	58			



5.6. THE WORSE CASE CONFIGURATIONS

The EUT was tested in the following configuration(s):

Controlled in test mode using a software application on the EUT supplied by customer. The application was used to enable a continuous transmission and to select the mode, test channels, bandwidth, data rates as required.

Test channels referring to section 5.4.

Maximum power setting referring to section 5.5.

Worst-case data rates as provided by the client were:

802.11b mode: 1 Mbps

802.11g mode: 6 Mbps

802.11n HT20 mode: MCS0

The measured additional path loss was included in any path loss calculations for all RF cable used during tested.



5.7. DESCRIPTION OF AVAILABLE ANTENNAS

Antenna	Frequency (MHz)	Antenna Type	MAX Antenna Gain (dBi)
1	2412-2462	FPC Antenna	2.4

Test Mode	Transmit and Receive Mode	Description
IEEE 802.11b	<input checked="" type="checkbox"/> 1TX, 1RX	ANT 1 can be used as transmitting/receiving antenna.
IEEE 802.11g	<input checked="" type="checkbox"/> 1TX, 1RX	ANT 1 can be used as transmitting/receiving antenna.
IEEE 802.11n HT20	<input checked="" type="checkbox"/> 1TX, 1RX	ANT 1 can be used as transmitting/receiving antenna.

Note: The value of the antenna gain was declared by customer.

5.8. DESCRIPTION OF TEST SETUP

SUPPORT EQUIPMENT

Item	Equipment	Brand Name	Model Name	P/N
1	/	/	/	/

I/O CABLES

Cable No	Port	Connector Type	Cable Type	Cable Length(m)	Remarks
1	/	/	/	/	/

ACCESSORY

Item	Accessory	Brand Name	Model Name	Description
1	AC Adapter	/	SW-070100A	Input:100-240V~50/60Hz 0.68A Max Output: DC 7.0V,1.0A 7.0W

TEST SETUP

The EUT can work in an engineer mode with software.

SETUP DIAGRAM FOR TESTS

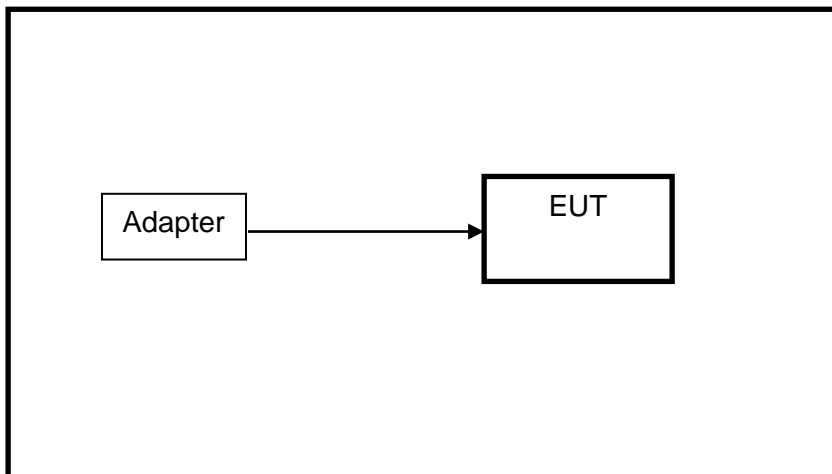

**6. MEASURING INSTRUMENT AND SOFTWARE USED**

Conducted Emissions					
Equipment	Manufacturer	Model No.	Serial No.	Last Cal.	Due Date
EMI Test Receiver	R&S	ESR3	101961	Oct.30, 2021	Oct.29, 2022
Two-Line V-Network	R&S	ENV216	101983	Oct.30, 2021	Oct.29, 2022
Software					
Description		Manufacturer	Name	Version	
Test Software for Conducted Emissions		Farad	EZ-EMC	Ver. UL-3A1	

Radiated Emissions					
Equipment	Manufacturer	Model No.	Serial No.	Last Cal.	Due Date
MXE EMI Receiver	KESIGHT	N9038A	MY56400036	Oct.30, 2021	Oct.29, 2022
Hybrid Log Periodic Antenna	TDK	HLP-3003C	130959	Aug.02, 2021	Aug.01, 2024
Preamplifier	HP	8447D	2944A09099	Oct.30, 2021	Oct.29, 2022
EMI Measurement Receiver	R&S	ESR26	101377	Oct.30, 2021	Oct.29, 2022
Horn Antenna	TDK	HRN-0118	130940	July 20, 2021	July 19, 2024
Preamplifier	TDK	PA-02-0118	TRS-305-00067	Oct.30, 2021	Oct.29, 2022
Horn Antenna	Schwarzbeck	BBHA9170	697	July 20, 2021	July 19, 2024
Preamplifier	TDK	PA-02-2	TRS-307-00003	Oct.31, 2021	Oct.30, 2022
Preamplifier	TDK	PA-02-3	TRS-308-00002	Oct.31, 2021	Oct.30, 2022
Loop antenna	Schwarzbeck	1519B	00008	July 20, 2021	July 19, 2024
Preamplifier	TDK	PA-02-001-3000	TRS-302-00050	Oct.31, 2021	Oct.30, 2022
Preamplifier	Mini-Circuits	ZX60-83LN-S+	SUP01201941	Oct.31, 2021	Oct.30, 2022
High Pass Filter	Wi	WHKX10-2700-3000-18000-40SS	23	Oct.31, 2021	Oct.30, 2022
Band Reject Filter	Wainwright	WRCJV8-2350-2400-2483.5-2533.5-40SS	4	Oct.31, 2021	Oct.30, 2022
Software					
Description		Manufacturer	Name	Version	



Test Software for Radiated Emissions	Farad	EZ-EMC	Ver. UL-3A1
--------------------------------------	-------	--------	-------------

Tonsend RF Test System					
Equipment	Manufacturer	Model No.	Serial No.	Last Cal.	Due. Date
PXA Signal Analyzer	Keysight	N9030A	MY55410512	Oct.30, 2021	Oct.29, 2022
MXG Vector Signal Generator	Keysight	N5182B	MY56200284	Oct.30, 2021	Oct.29, 2022
MXG Vector Signal Generator	Keysight	N5172B	MY56200301	Oct.30, 2021	Oct.29, 2022
Software					
Description	Manufacturer	Name		Version	
Tonsend SRD Test System	Tonsend	JS1120-3 RF Test System		2.6.77.0518	

Other Instruments					
Equipment	Manufacturer	Model No.	Serial No.	Last Cal.	Next Cal.
Dual Channel Power Meter	Keysight	N1912A	MY55416024	Oct.30, 2021	Oct.29, 2022
Power Sensor	Keysight	USB Wideband Power Sensor	MY5100022	Oct.30, 2021	Oct.29, 2022
Signal Analyzer	R&S	FSV40	101118	Oct.30, 2021	Oct.29, 2022

7. ANTENNA PORT TEST RESULTS

7.1. ON TIME AND DUTY CYCLE

LIMITS

None; for reporting purposes only

PROCEDURE

Refer to ANSI C63.10-2013 clause 11.6 Zero – Span Spectrum Analyzer method.

TEST SETUP

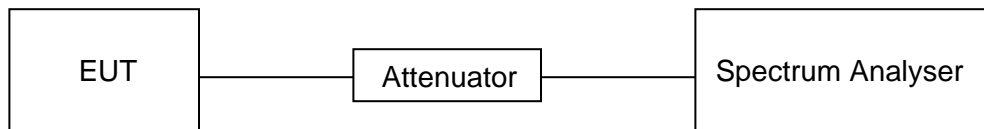

TEST ENVIRONMENT

Temperature	24.3 °C	Relative Humidity	59.5 %
Atmosphere Pressure	101 kPa	Test Voltage	AC 120V, 60 HZ

RESULTS

Please refer to appendix G.

7.2. 6 dB DTS BANDWIDTH AND 99 % OCCUPIED BANDWIDTH

LIMITS

CFR 47 FCC Part15 (15.247) Subpart C			
Section	Test Item	Limit	Frequency Range (MHz)
CFR 47 FCC 15.247(a)(2) ISED RSS-247 5.2 (a)	6 dB Bandwidth	≥ 500 kHz	2400-2483.5
ISED RSS-Gen Clause 6.7	99 % Occupied Bandwidth	For reporting purposes only.	2400-2483.5

TEST PROCEDURE

Connect the EUT to the spectrum analyser and use the following settings:

Center Frequency	The center frequency of the channel under test
Frequency Span	Between 1.5 times and 5.0 times the OBW
Detector	Peak
RBW	For 6 dB Bandwidth: 100 kHz For 99 % Occupied Bandwidth: 1 % to 5 % of the occupied bandwidth
VBW	For 6 dB Bandwidth: ≥3 × RBW For 99 % Occupied Bandwidth: ≥3 × RBW
Trace	Max hold
Sweep	Auto couple

- a) Use the 99 % power bandwidth function of the instrument, allow the trace to stabilize and report the measured bandwidth.
- b) Allow the trace to stabilize and measure the maximum width of the emission that is constrained by the frequencies associated with the two outermost amplitude points (upper and lower frequencies) that are attenuated by 6 dB relative to the maximum level measured in the fundamental emission.

TEST SETUP

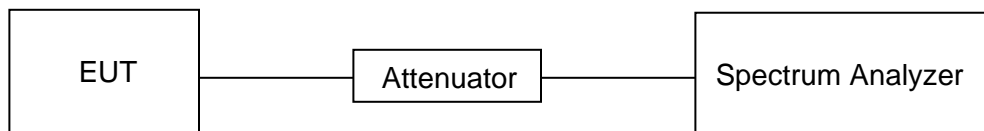



TEST ENVIRONMENT

Temperature	24.3 °C	Relative Humidity	59.5 %
Atmosphere Pressure	101 kPa	Test Voltage	AC 120V, 60 HZ

RESULTS

Please refer to appendix A & B.

7.3. CONDUCTED OUTPUT POWER

LIMITS

CFR 47 FCC Part15 (15.247) Subpart C ISED RSS-247 ISSUE 2			
Section	Test Item	Limit	Frequency Range (MHz)
CFR 47 FCC 15.247(b)(3) ISED RSS-247 5.4 (d)	AVG Output Power	1 watt or 30 dBm	2400-2483.5

TEST PROCEDURE

For Average Power:

Connect the EUT to a low loss RF cable from the antenna port to the power sensor (video bandwidth is greater than the occupied bandwidth).

Measure peak emission level, the indicated level is the average output power, after any corrections for external attenuators and cables.

TEST SETUP

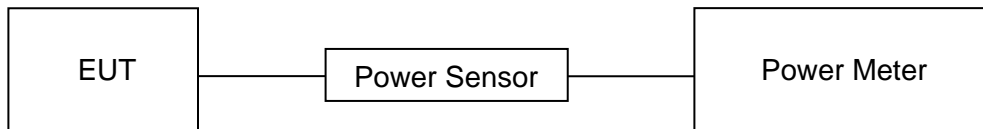



TEST ENVIRONMENT

Temperature	24.3 °C	Relative Humidity	59.5 %
Atmosphere Pressure	101 kPa	Test Voltage	AC 120V, 60 HZ

RESULTS

Please refer to appendix C.

7.4. POWER SPECTRAL DENSITY

LIMITS

CFR 47 FCC Part15 (15.247) Subpart C ISED RSS-247 ISSUE 2			
Section	Test Item	Limit	Frequency Range (MHz)
CFR 47 FCC §15.247 (e) ISED RSS-247 5.2 (b)	Power Spectral Density	8 dBm/3 kHz	2400-2483.5

TEST PROCEDURE

Refer to ANSI C63.10-2013 clause 11.10.5.

Connect the EUT to the spectrum analyser and use the following settings:

Center Frequency	The center frequency of the channel under test
Detector	power averaging (rms) or sample detector
RBW	$3 \text{ kHz} \leq \text{RBW} \leq 100 \text{ kHz}$
VBW	$\geq 3 \times \text{RBW}$
Span	1.5 x OBW bandwidth
Trace	Average
Sweep time	Auto couple

Allow trace to fully stabilize and use the peak marker function to determine the maximum amplitude level within the RBW.

If measured value exceeds limit, reduce RBW (no less than 3 kHz) and repeat.

TEST SETUP

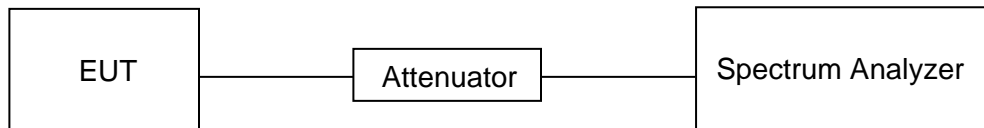

TEST ENVIRONMENT

Temperature	24.3 °C	Relative Humidity	59.5 %
Atmosphere Pressure	101 kPa	Test Voltage	AC 120V, 60 HZ



RESULTS

Please refer to appendix D.

7.5. CONDUCTED BANDEGE AND SPURIOUS EMISSIONS

LIMITS

CFR 47 FCC Part15 (15.247) Subpart C ISED RSS-247 ISSUE 2		
Section	Test Item	Limit
CFR 47 FCC §15.247 (d) ISED RSS-247 5.5	Conducted Bandedge and Spurious Emissions	at least 30 dB below that in the 100 kHz bandwidth within the band that contains the highest level of the desired power

TEST PROCEDURE

Refer to ANSI C63.10-2013 clause 11.11 and 11.13.

Connect the EUT to the spectrum analyser and use the following settings for reference level measurement:

Center Frequency	The center frequency of the channel under test
Detector	Peak
RBW	100 kHz
VBW	$\geq 3 \times \text{RBW}$
Span	1.5 x DTS bandwidth
Trace	Max hold
Sweep time	Auto couple.

Allow trace to fully stabilize and use the peak marker function to determine the maximum PSD level.

Change the settings for emission level measurement:

Span	Set the center frequency and span to encompass frequency range to be measured
Detector	Peak
RBW	100 kHz
VBW	$\geq 3 \times \text{RBW}$
measurement points	$\geq \text{span}/\text{RBW}$
Trace	Max hold
Sweep time	Auto couple.

Allow trace to fully stabilize and use the peak marker function to determine the maximum PSD level. Ensure that the amplitude of all unwanted emissions outside of the authorized frequency band (excluding restricted frequency bands) is attenuated by at least the minimum requirements specified in 11.11.



TEST SETUP

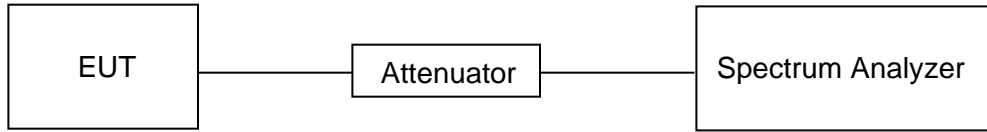

TEST ENVIRONMENT

Temperature	24.3 °C	Relative Humidity	59.5 %
Atmosphere Pressure	101 kPa	Test Voltage	AC 120V, 60 HZ

RESULTS

Please refer to appendix E & F.

8. RADIATED TEST RESULTS

Please refer to CFR 47 FCC §15.205 and §15.209.

Please refer to ISED RSS-GEN Clause 8.9 and Clause 8.10.

Radiation Disturbance Test Limit for FCC (Class B) (9 kHz ~ 1 GHz)

Emissions radiated outside of the specified frequency bands above 30 MHz			
Frequency Range (MHz)	Field Strength Limit (uV/m) at 3 m	Field Strength Limit (dBuV/m) at 3 m	
		Quasi-Peak	
30 - 88	100	40	
88 - 216	150	43.5	
216 - 960	200	46	
Above 960	500	54	
Above 1000	500	Peak	Average
		74	54

FCC Emissions radiated outside of the specified frequency bands below 30 MHz		
Frequency (MHz)	Field strength (microvolts/meter)	Measurement distance (meters)
0.009-0.490	2400/F(kHz)	300
0.490-1.705	24000/F(kHz)	30
1.705-30.0	30	30

ISED General field strength limits at frequencies below 30 MHz

Table 6 – General field strength limits at frequencies below 30 MHz		
Frequency	Magnetic field strength (H-Field) (µA/m)	Measurement distance (m)
9 - 490 kHz ^{Note 1}	6.37/F (F in kHz)	300
490 - 1705 kHz	63.7/F (F in kHz)	30
1.705 - 30 MHz	0.08	30

Note 1: The emission limits for the ranges 9-90 kHz and 110-490 kHz are based on measurements employing a linear average detector.



ISED Restricted bands please refer to ISED RSS-GEN Clause 8.10

Table 7 – Restricted frequency bands^{Note 1}

MHz	MHz	GHz
0.090 - 0.110	149.9 - 150.05	9.0 - 9.2
0.495 - 0.505	156.52475 - 156.52525	9.3 - 9.5
2.1735 - 2.1905	156.7 - 156.9	10.0 - 12.7
3.020 - 3.028	162.0125 - 167.17	13.25 - 13.4
4.125 - 4.128	167.72 - 173.2	14.47 - 14.5
4.17725 - 4.17775	240 - 285	15.35 - 16.2
4.20725 - 4.20775	322 - 335.4	17.7 - 21.4
5.677 - 5.683	399.9 - 410	22.01 - 23.12
6.215 - 6.218	608 - 614	23.6 - 24.0
6.26775 - 6.26825	960 - 1427	31.2 - 31.8
6.31175 - 6.31225	1435 - 1626.5	36.43 - 36.5
8.291 - 8.294	1045.5 - 1646.5	Above 38.6
8.362 - 8.366	1660 - 1710	
8.37625 - 8.38675	1718.8 - 1722.2	
8.41425 - 8.41475	2200 - 2300	
12.29 - 12.293	2310 - 2390	
12.51975 - 12.52025	2483.5 - 2500	
12.57675 - 12.57725	2655 - 2900	
13.36 - 13.41	3260 - 3267	
16.42 - 16.423	3332 - 3339	
16.69475 - 16.69525	3345.8 - 3358	
16.80425 - 16.80475	3500 - 4400	
25.5 - 25.67	4500 - 5150	
37.5 - 38.25	5350 - 5460	
73 - 74.6	7250 - 7750	
74.8 - 75.2	8025 - 8500	
108 - 138		

Note 1: Certain frequency bands listed in table 7 and in bands above 38.6 GHz are designated for licence-exempt applications. These frequency bands and the requirements that apply to related devices are set out in the 200 and 300 series of RSSs.

FCC Restricted bands of operation refer to FCC §15.205 (a):

MHz	MHz	MHz	GHz
0.090-0.110	16.42-16.423	399.9-410	4.5-5.15
¹ 0.495-0.505	16.69475-16.69525	608-614	5.35-5.46
2.1735-2.1905	16.80425-16.80475	960-1240	7.25-7.75
4.125-4.128	25.5-25.67	1300-1427	8.025-8.5
4.17725-4.17775	37.5-38.25	1435-1626.5	9.0-9.2
4.20725-4.20775	73-74.6	1645.5-1646.5	9.3-9.5
6.215-6.218	74.8-75.2	1660-1710	10.6-12.7
6.26775-6.26825	108-121.94	1718.8-1722.2	13.25-13.4
6.31175-6.31225	123-138	2200-2300	14.47-14.5
8.291-8.294	149.9-150.05	2310-2390	15.35-16.2
8.362-8.366	156.52475-156.52525	2483.5-2500	17.7-21.4
8.37625-8.38675	156.7-156.9	2690-2900	22.01-23.12
8.41425-8.41475	162.0125-167.17	3260-3267	23.6-24.0
12.29-12.293	167.72-173.2	3332-3339	31.2-31.8
12.51975-12.52025	240-285	3345.8-3358	36.43-36.5
12.57675-12.57725	322-335.4	3600-4400	(²)
13.36-13.41			

Note: ¹Until February 1, 1999, this restricted band shall be 0.490-0.510 MHz.

²Above 38.6c

TEST SETUP AND PROCEDURE

Below 30 MHz

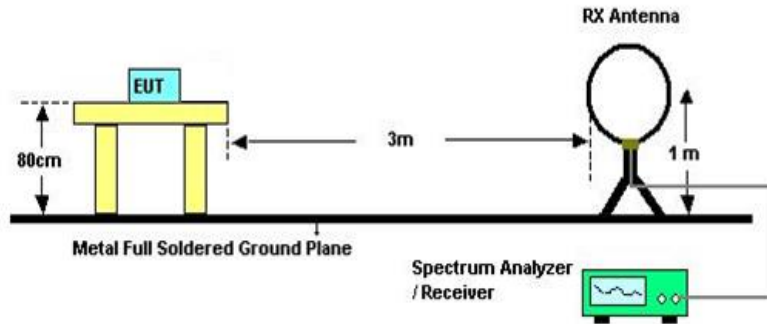

The setting of the spectrum analyser

RBW	200 Hz (From 9 kHz to 0.15 MHz)/ 9 kHz (From 0.15 MHz to 30 MHz)
VBW	200 Hz (From 9 kHz to 0.15 MHz)/ 9 kHz (From 0.15 MHz to 30 MHz)
Sweep	Auto
Trace	Max hold

1. The testing follows the guidelines in ANSI C63.10-2013 clause 6.4.
2. The EUT was arranged to its worst case and then turntable (from 0 degree to 360 degrees) to find the maximum reading. A pre-amp and a high pass filter are used for the test in order to get better signal level. Both Horizontal, Face-on and Face-off polarizations of the antenna are set to make the measurement.
3. The EUT was placed on a turntable with 80 cm above ground.
4. The EUT was set 3 meters from the interference receiving antenna, which was mounted on the top of a 1 m height antenna tower.
5. The radiated emission limits are based on measurements employing a CISPR quasi-peak detector except for the frequency bands 9-90 kHz, 110-490 kHz and above 1000 MHz. Radiated emission limits in these three bands are based on measurements employing an average detector.
6. For measurement below 1 GHz, the initial step in collecting conducted emission data is a spectrum analyzer peak detector mode pre-scanning the measurement frequency range. Significant peaks are then marked and then Quasi Peak and average detector mode re-measured. If the emission level of the EUT measured by the peak detector is 3 dB lower than the applicable limit, the peak emission level will be reported. Otherwise, the emission measurement will be repeated using the quasi-peak and average detector and reported.
7. Although these tests were performed other than open field site, adequate comparison measurements were confirmed against 30m open field site. Therefore sufficient tests were made to demonstrate that the alternative site produces results that correlate with the ones of tests made in an open field site based on KDB 414788.
8. The limits in CFR 47, Part 15, Subpart C, paragraph 15.209 (a), are identical to those in RSS-GEN Section 8.9, Table 6, since the measurements are performed in terms of magnetic field strength and converted to electric field strength levels (as reported in the table) using the free space impedance of 377Ω ; For example, the measurement frequency X kHz resulted in a level of Y dBuV/m, which is equivalent to $Y-51.5 = Z$ dBuA/m, which has the same margin, W dB, to the corresponding RSS-GEN Table 6 limit as it has to be 15.209(a) limit.

Below 1 GHz and above 30 MHz

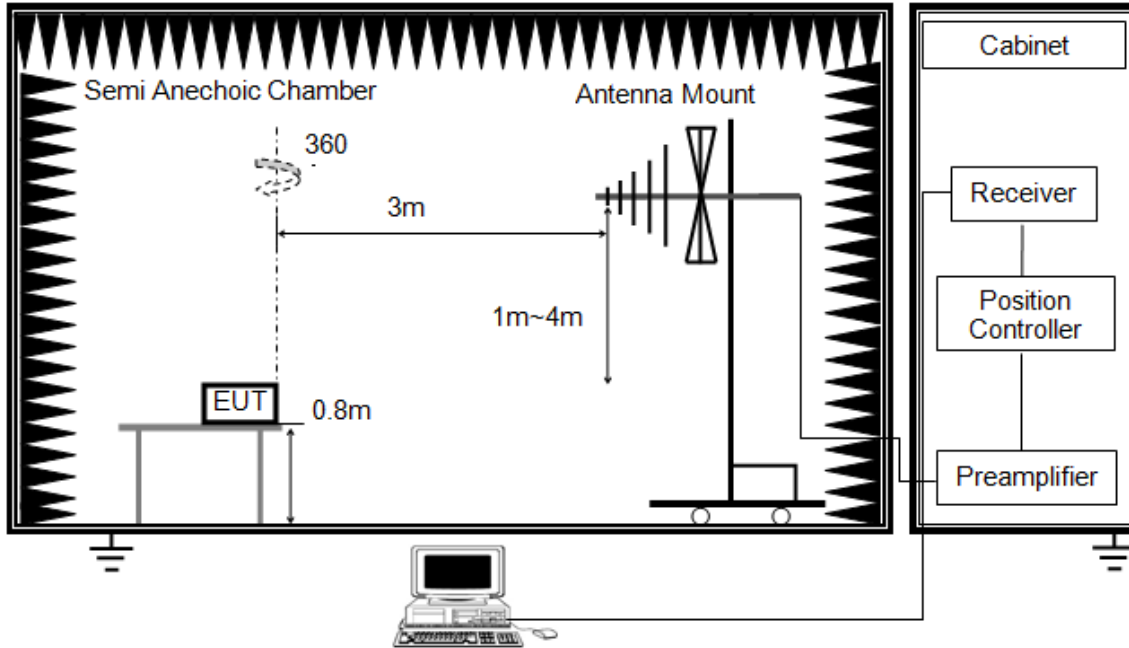

The setting of the spectrum analyser

RBW	120 kHz
VBW	300 kHz
Sweep	Auto
Detector	Peak/QP
Trace	Max hold

1. The testing follows the guidelines in ANSI C63.10-2013 clause 6.5.
2. The EUT was arranged to its worst case and then tune the antenna tower (from 1 m to 4 m) and turntable (from 0 degree to 360 degrees) to find the maximum reading. A pre-amp and a high pass filter are used for the test in order to get better signal level. Both horizontal and vertical polarizations of the antenna are set to make the measurement.
3. The EUT was placed on a turntable with 80 cm above ground.
4. The EUT was set 3 meters from the interference receiving antenna, which was mounted on the top of a variable height antenna tower.
5. For measurement below 1 GHz, the initial step in collecting conducted emission data is a spectrum analyzer peak detector mode pre-scanning the measurement frequency range. Significant peaks are then marked and then Quasi Peak detector mode re-measured. If the emission level of the EUT measured by the peak detector is 3 dB lower than the applicable limit, the peak emission level will be reported. Otherwise, the emission measurement will be repeated using the quasi-peak detector and reported.

Above 1 GHz

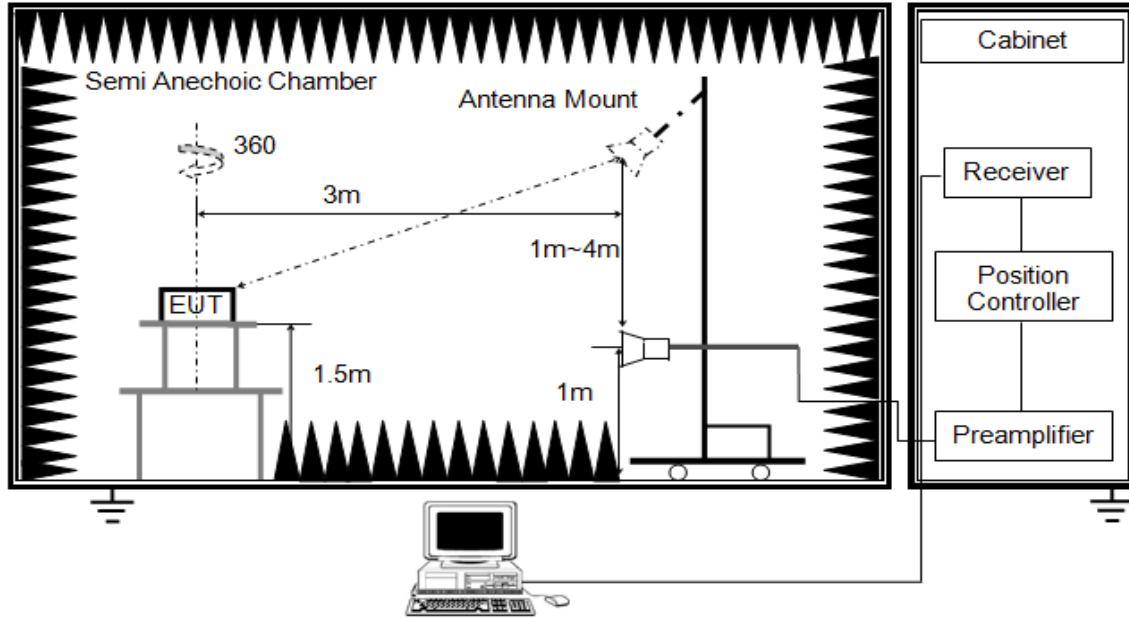

The setting of the spectrum analyser

RBW	1 MHz
VBW	PEAK: 3 MHz AVG: see note 6
Sweep	Auto
Detector	Peak
Trace	Max hold

1. The testing follows the guidelines in ANSI C63.10-2013 clause 6.6.
2. The EUT was arranged to its worst case and then tune the antenna tower (from 1 m to 4 m) and turntable (from 0 degree to 360 degrees) to find the maximum reading. A pre-amp and a high pass filter are used for the test in order to get better signal level. Both horizontal and vertical polarizations of the antenna are set to make the measurement.
3. The EUT was placed on a turntable with 1.5 m above ground.
4. The EUT was set 3 meters from the interference receiving antenna, which was mounted on the top of a variable height antenna tower.
5. For measurement above 1 GHz, the emission measurement will be measured by the peak detector. This peak level, once corrected, must comply with the limit specified in Section 15.209.
6. For measurements above 1 GHz the resolution bandwidth is set to 1 MHz, then the video bandwidth is set to 3 MHz for peak measurements and 1 MHz resolution bandwidth with 1/T video bandwidth with peak detector for average measurements. For the Duty Cycle please refer to clause 7.1.ON TIME AND DUTY CYCLE.

X axis, Y axis, Z axis positions:

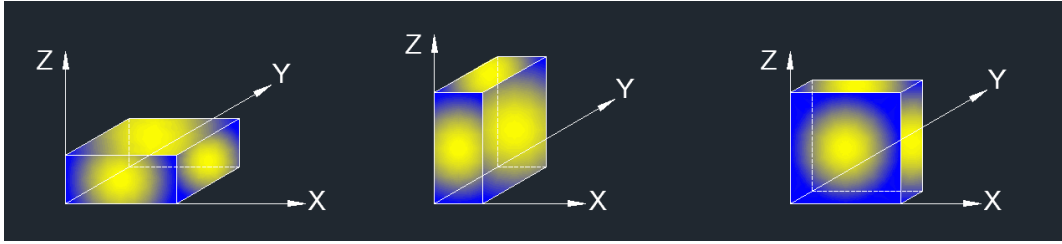

Note 1: For all radiated test, EUT in each of three orthogonal axis emissions had been tested, but only the worst case (X axis) data recorded in the report.

Note 2: The EUT was fully exercised with external accessories during the test. In the case of multiple accessory external ports, an external accessory shall be connected to one of each type of port.

TEST ENVIRONMENT

Temperature	24.3 °C	Relative Humidity	61 %
Atmosphere Pressure	101 kPa	Test Voltage	AC 120V, 60 HZ

RESULTS

8.1. RESTRICTED BANDEDGE

8.1.1. 802.11b MODE

RESTRICTED BANDEDGE (LOW CHANNEL, HORIZONTAL)

PEAK

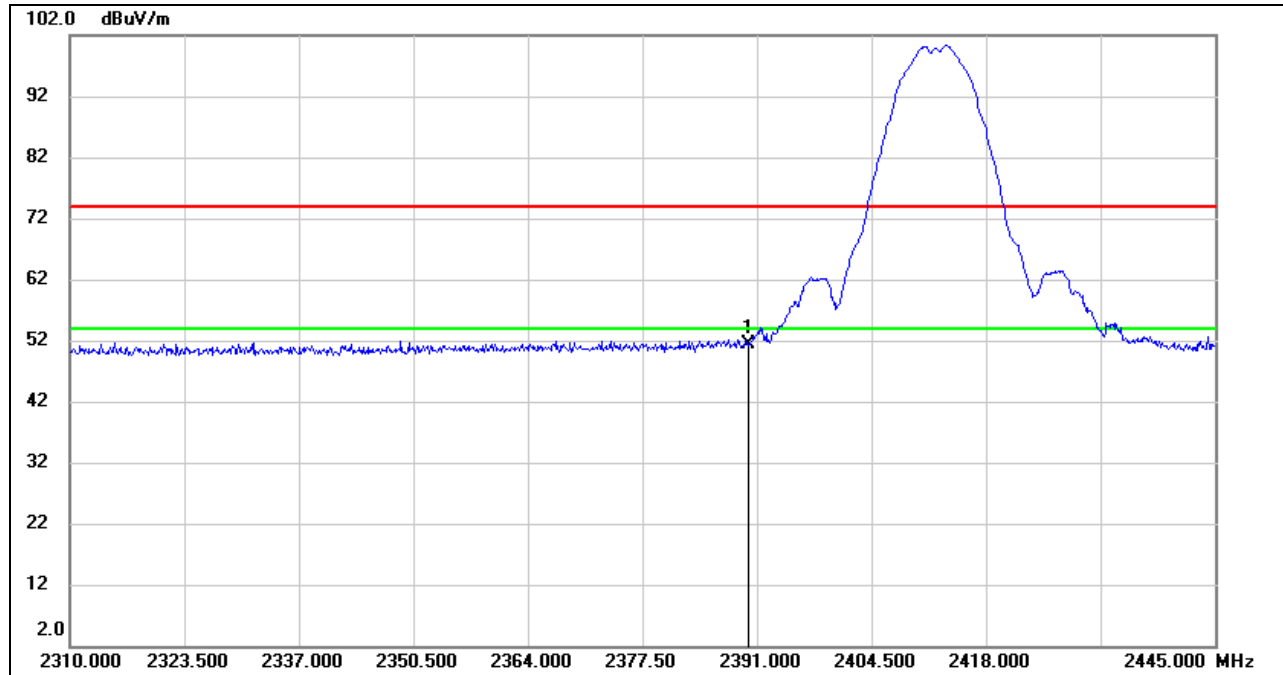

No.	Frequency (MHz)	Reading (dBuV)	Correct (dB/m)	Result (dBuV/m)	Limit (dBuV/m)	Margin (dB)	Remark
1	2390.000	19.26	32.16	51.42	74.00	-22.58	peak

- Note:
1. Measurement = Reading Level + Correct Factor.
 2. If Peak Result complies with AV limit, AV Result is deemed to comply with AV limit.
 3. Peak: Peak detector.
 4. Only the worst data was recorded, if it complies with the limit, the other emissions deemed to comply with the limit.



RESTRICTED BANDEDGE (LOW CHANNEL, VERTICAL)

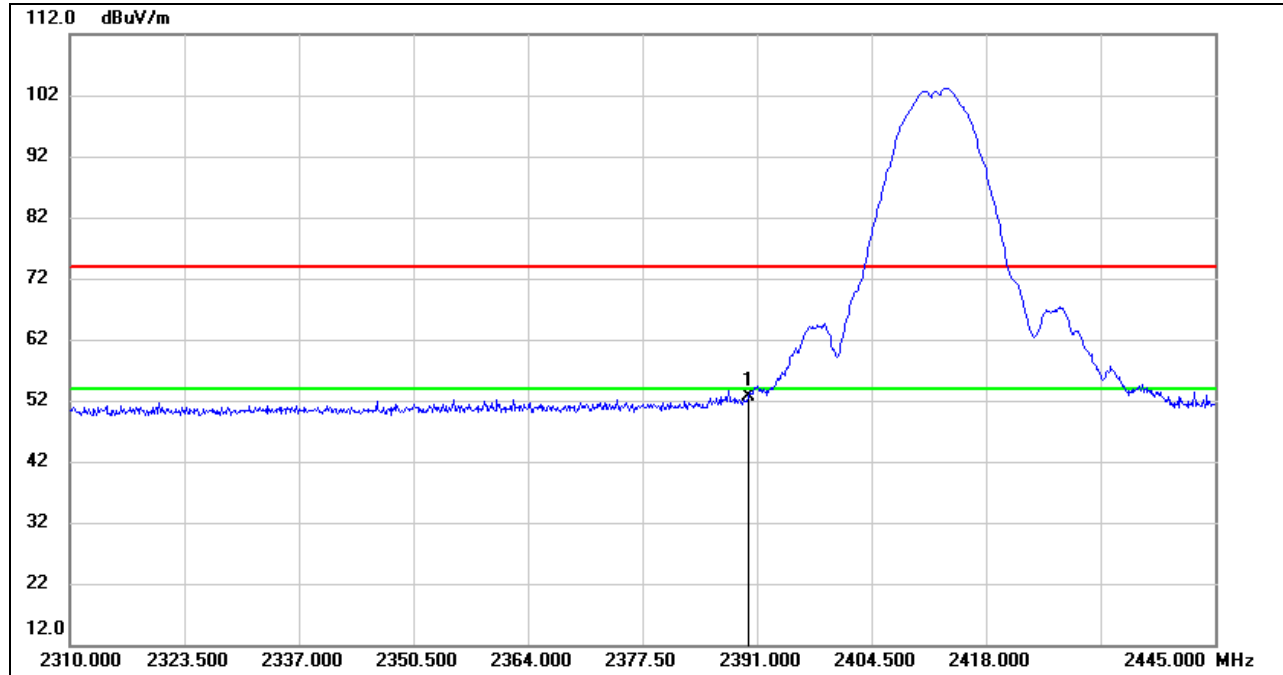

No.	Frequency (MHz)	Reading (dBuV)	Correct (dB/m)	Result (dBuV/m)	Limit (dBuV/m)	Margin (dB)	Remark
1	2390.000	20.43	32.16	52.59	74.00	-21.41	peak

- Note:
1. Measurement = Reading Level + Correct Factor.
 2. If Peak Result complies with AV limit, AV Result is deemed to comply with AV limit.
 3. AVG: $VBW=1/Ton$, where: Ton is the transmitting duration.
 4. For the transmitting duration, please refer to clause 7.1.
 5. Only the worst data was recorded, if it complies with the limit, the other emissions deemed to comply with the limit.



RESTRICTED BANDEDGE (HIGH CHANNEL, HORIZONTAL)

PEAK

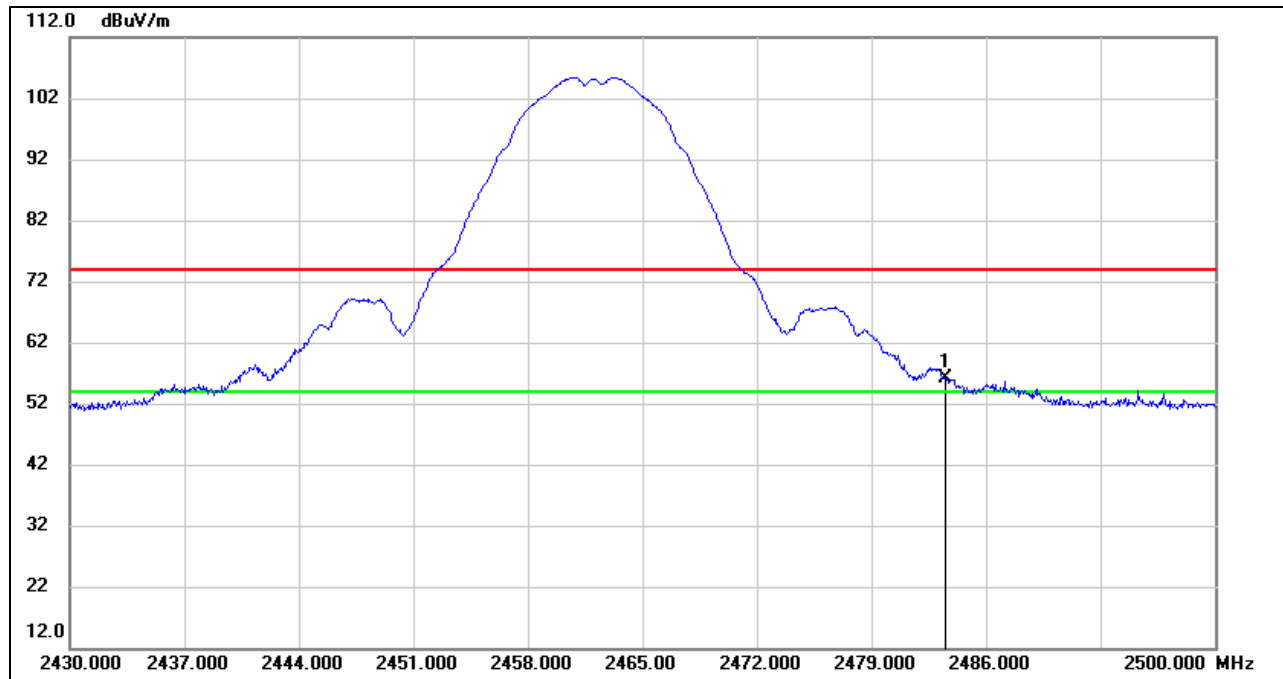

No.	Frequency (MHz)	Reading (dBuV)	Correct (dB/m)	Result (dBuV/m)	Limit (dBuV/m)	Margin (dB)	Remark
1	2483.500	23.58	32.44	56.02	74.00	-17.98	peak

- Note:
1. Measurement = Reading Level + Correct Factor.
 2. If Peak Result complies with AV limit, AV Result is deemed to comply with AV limit.
 3. Peak: Peak detector.
 4. Only the worst data was recorded, if it complies with the limit, the other emissions deemed to comply with the limit.

AVG

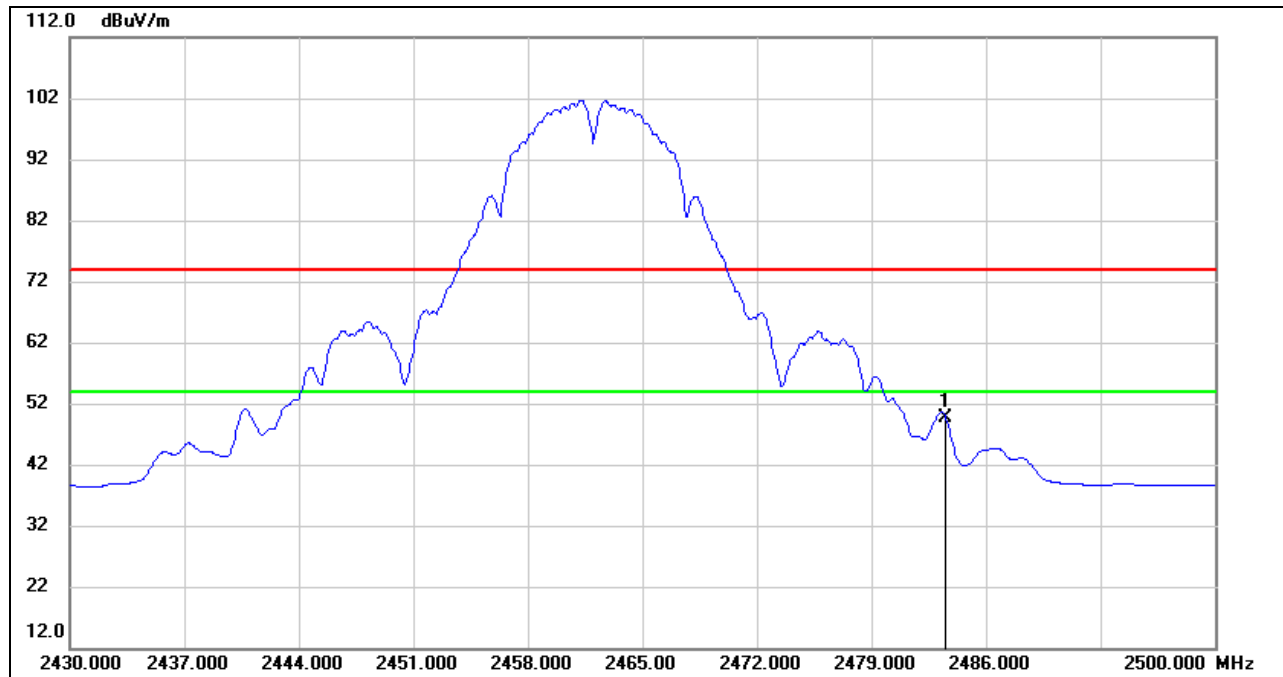

No.	Frequency (MHz)	Reading (dBuV)	Correct (dB/m)	Result (dBuV/m)	Limit (dBuV/m)	Margin (dB)	Remark
1	2483.500	17.27	32.44	49.71	54.00	-4.29	AVG

- Note:
1. Measurement = Reading Level + Correct Factor.
 2. If Peak Result complies with AV limit, AV Result is deemed to comply with AV limit.
 3. AVG: $VBW=1/Ton$, where: Ton is the transmitting duration.
 4. For the transmitting duration, please refer to clause 7.1.
 5. Only the worst data was recorded, if it complies with the limit, the other emissions deemed to comply with the limit.

Note: All the polarities (Vertical & Horizontal) had been tested, only the worst data was recorded in the report.

8.1.2. 802.11g MODE

RESTRICTED BANDEDGE (LOW CHANNEL, HORIZONTAL)

PEAK

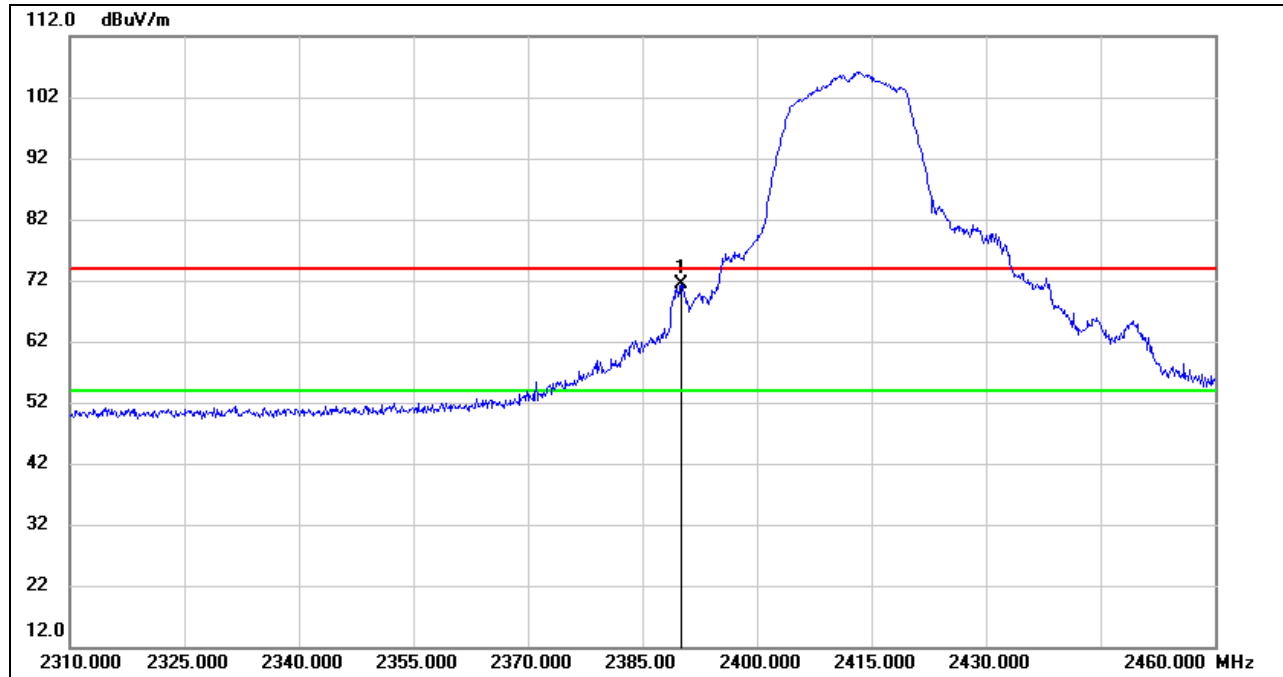

No.	Frequency (MHz)	Reading (dBuV)	Correct (dB/m)	Result (dBuV/m)	Limit (dBuV/m)	Margin (dB)	Remark
1	2390.000	39.25	32.16	71.41	74.00	-2.59	peak

- Note:
1. Measurement = Reading Level + Correct Factor.
 2. If Peak Result complies with AV limit, AV Result is deemed to comply with AV limit.
 3. Peak: Peak detector.
 4. Only the worst data was recorded, if it complies with the limit, the other emissions deemed to comply with the limit.



AVG

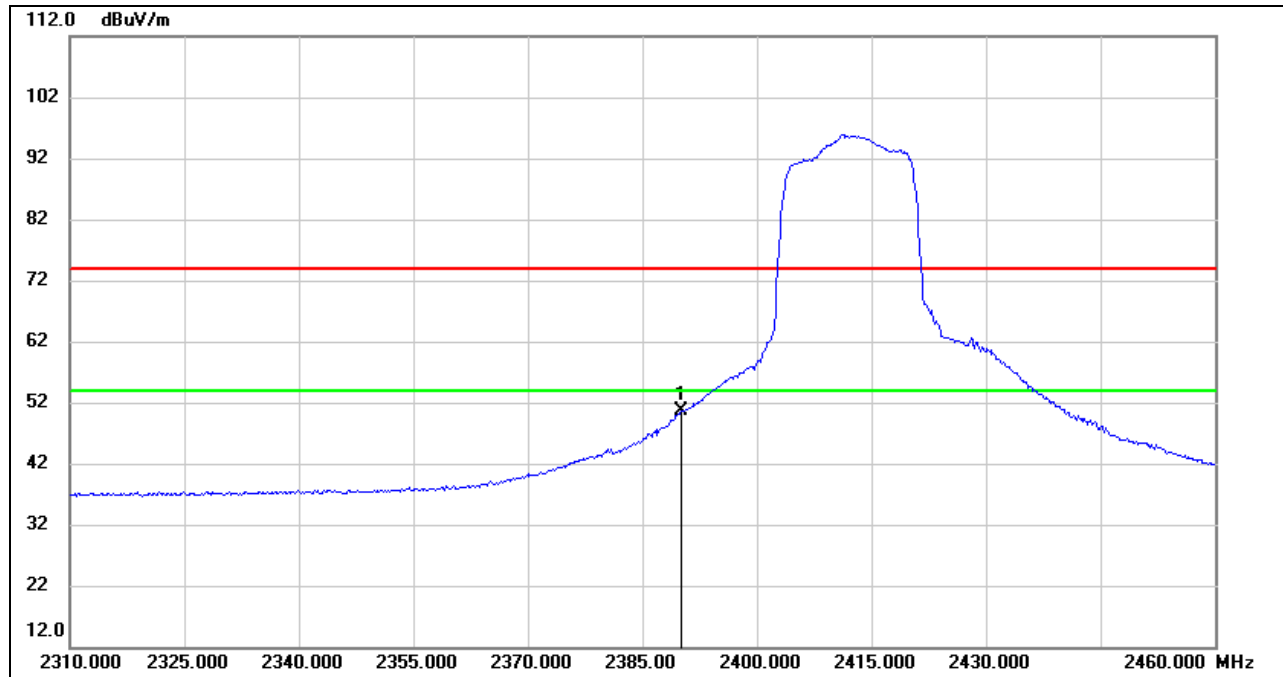

No.	Frequency (MHz)	Reading (dBuV)	Correct (dB/m)	Result (dBuV/m)	Limit (dBuV/m)	Margin (dB)	Remark
1	2390.000	18.40	32.16	50.56	54.00	-3.44	AVG

- Note:
1. Measurement = Reading Level + Correct Factor.
 2. If Peak Result complies with AV limit, AV Result is deemed to comply with AV limit.
 3. AVG: $VBW=1/Ton$, where: Ton is the transmitting duration.
 4. For the transmitting duration, please refer to clause 7.1.
 5. Only the worst data was recorded, if it complies with the limit, the other emissions deemed to comply with the limit.



RESTRICTED BANDEDGE (HIGH CHANNEL, HORIZONTAL)

PEAK

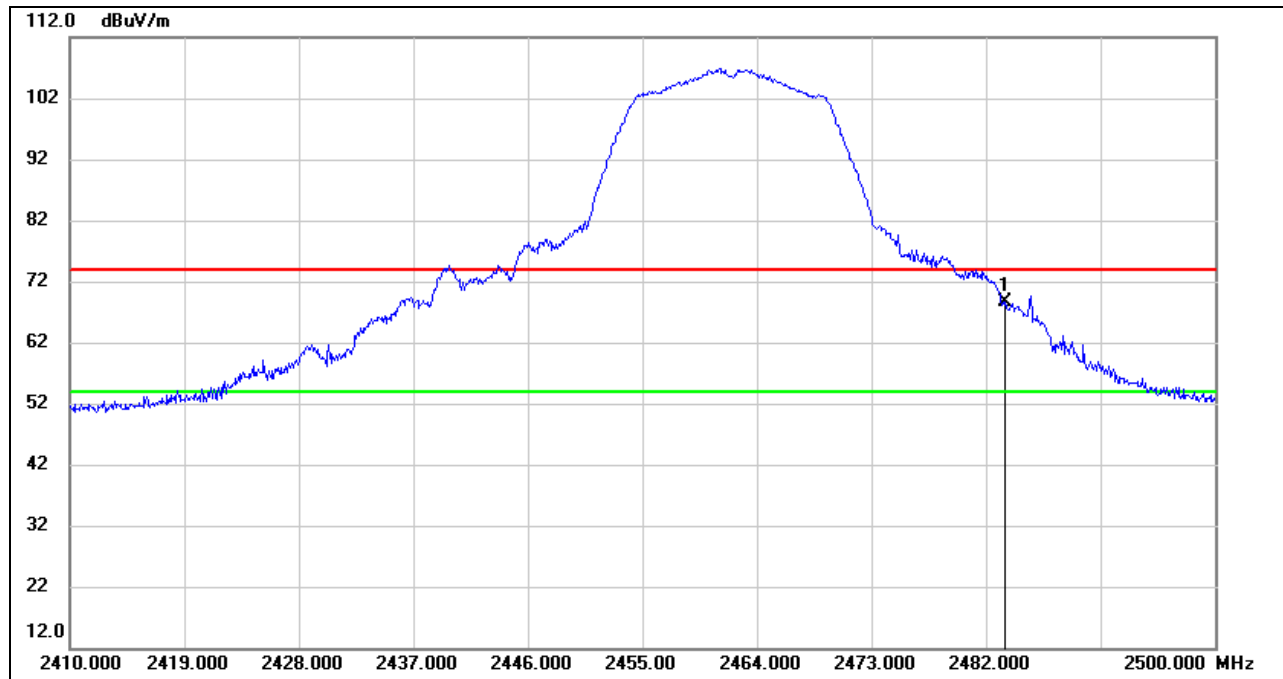

No.	Frequency (MHz)	Reading (dBuV)	Correct (dB/m)	Result (dBuV/m)	Limit (dBuV/m)	Margin (dB)	Remark
1	2483.500	36.12	32.44	68.56	74.00	-5.44	peak

- Note:
1. Measurement = Reading Level + Correct Factor.
 2. If Peak Result complies with AV limit, AV Result is deemed to comply with AV limit.
 3. Peak: Peak detector.
 4. Only the worst data was recorded, if it complies with the limit, the other emissions deemed to comply with the limit.

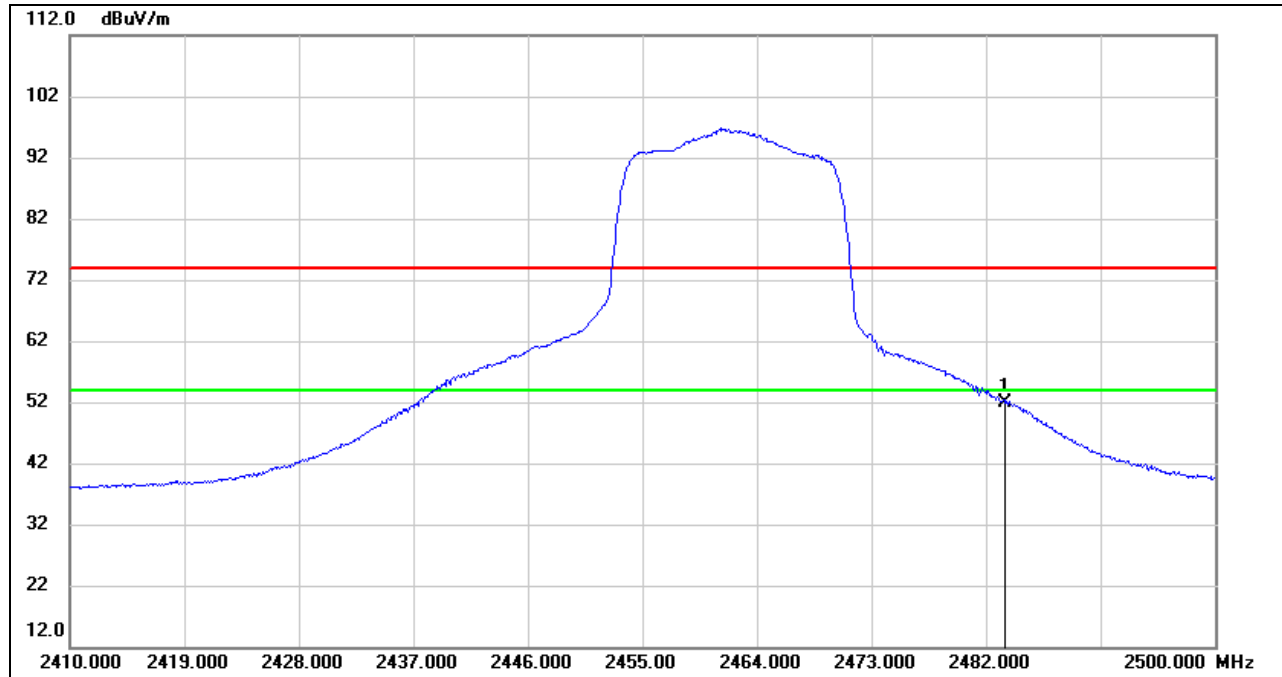
**AVG**

No.	Frequency (MHz)	Reading (dBuV)	Correct (dB/m)	Result (dBuV/m)	Limit (dBuV/m)	Margin (dB)	Remark
1	2483.500	19.52	32.44	51.96	54.00	-2.04	AVG

Note: 1. Measurement = Reading Level + Correct Factor.

2. If Peak Result complies with AV limit, AV Result is deemed to comply with AV limit.

3. AVG: $VBW=1/Ton$, where: Ton is the transmitting duration.

4. For the transmitting duration, please refer to clause 7.1.

5. Only the worst data was recorded, if it complies with the limit, the other emissions deemed to comply with the limit.

Note: All the polarities (Vertical & Horizontal) had been tested, only the worst data was recorded in the report.

8.1.3. 802.11n HT20 MODE

RESTRICTED BANDEDGE (LOW CHANNEL, HORIZONTAL)

PEAK

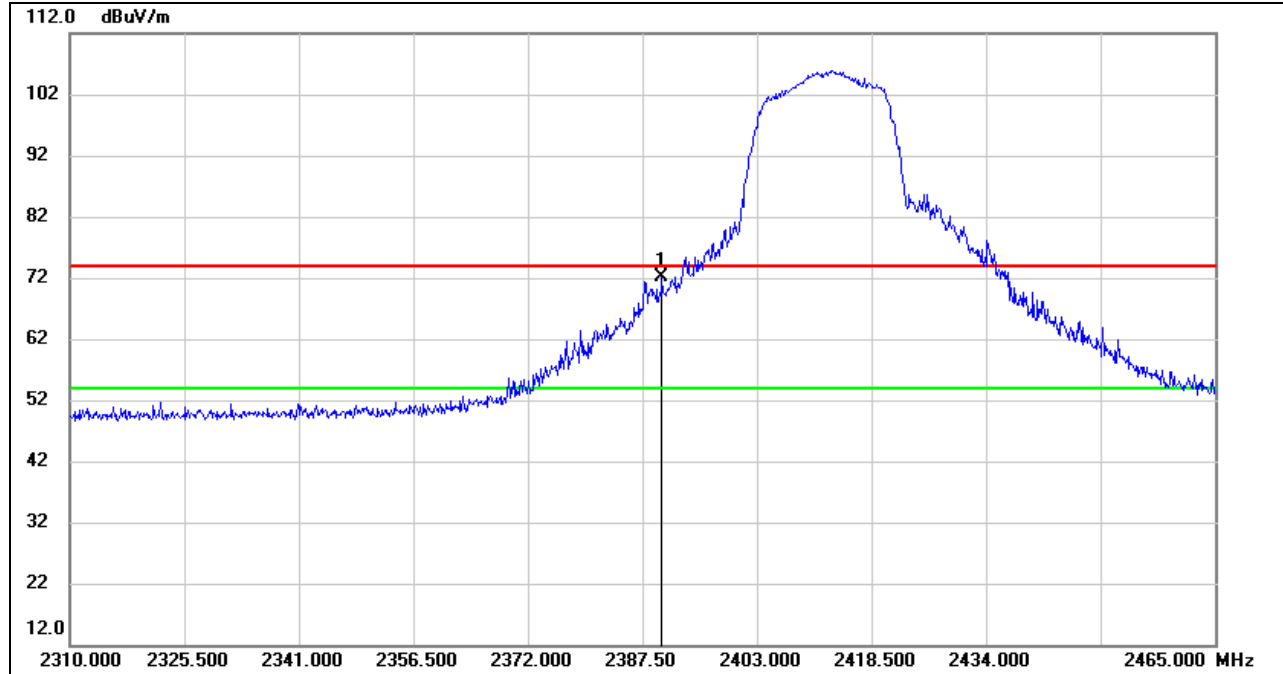

No.	Frequency (MHz)	Reading (dBuV)	Correct (dB/m)	Result (dBuV/m)	Limit (dBuV/m)	Margin (dB)	Remark
1	2390.000	40.03	32.16	72.19	74.00	-1.81	peak

- Note: 1. Measurement = Reading Level + Correct Factor.
 2. If Peak Result complies with AV limit, AV Result is deemed to comply with AV limit.
 3. Peak: Peak detector.
 4. Only the worst data was recorded, if it complies with the limit, the other emissions deemed to comply with the limit.

AVG

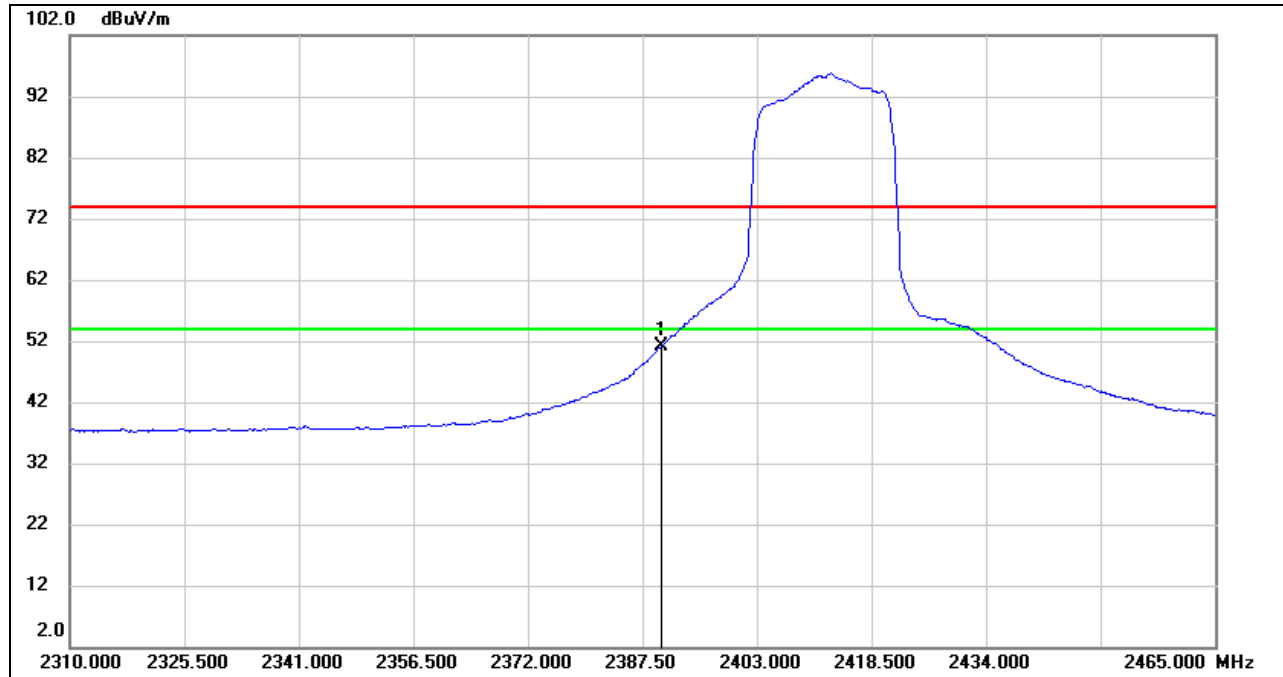

No.	Frequency (MHz)	Reading (dBuV)	Correct (dB/m)	Result (dBuV/m)	Limit (dBuV/m)	Margin (dB)	Remark
1	2390.000	18.90	32.16	51.06	54.00	-2.94	AVG

- Note:
1. Measurement = Reading Level + Correct Factor.
 2. If Peak Result complies with AV limit, AV Result is deemed to comply with AV limit.
 3. AVG: $VBW=1/Ton$, where: Ton is the transmitting duration.
 4. For the transmitting duration, please refer to clause 7.1.
 5. Only the worst data was recorded, if it complies with the limit, the other emissions deemed to comply with the limit.

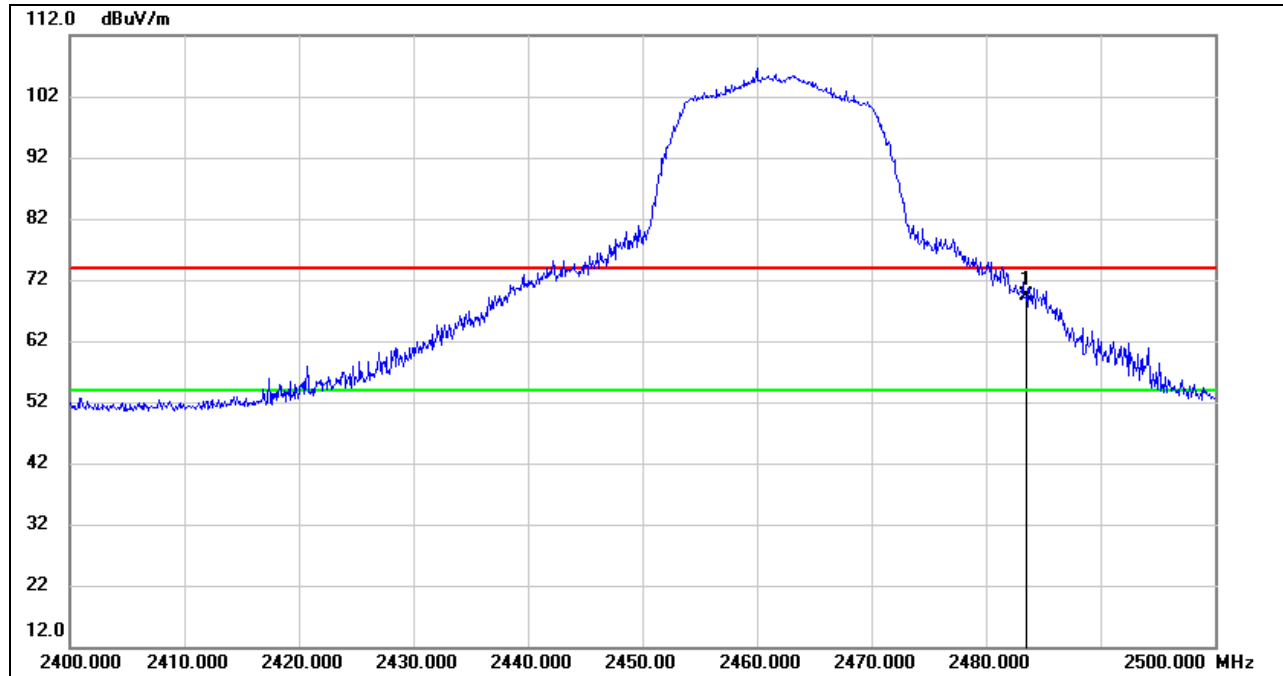
**RESTRICTED BANDEDGE (HIGH CHANNEL, HORIZONTAL)****PEAK**

No.	Frequency (MHz)	Reading (dBuV)	Correct (dB/m)	Result (dBuV/m)	Limit (dBuV/m)	Margin (dB)	Remark
1	2483.500	36.97	32.44	69.41	74.00	-4.59	peak

- Note: 1. Measurement = Reading Level + Correct Factor.
 2. If Peak Result complies with AV limit, AV Result is deemed to comply with AV limit.
 3. Peak: Peak detector.
 4. Only the worst data was recorded, if it complies with the limit, the other emissions deemed to comply with the limit.

AVG

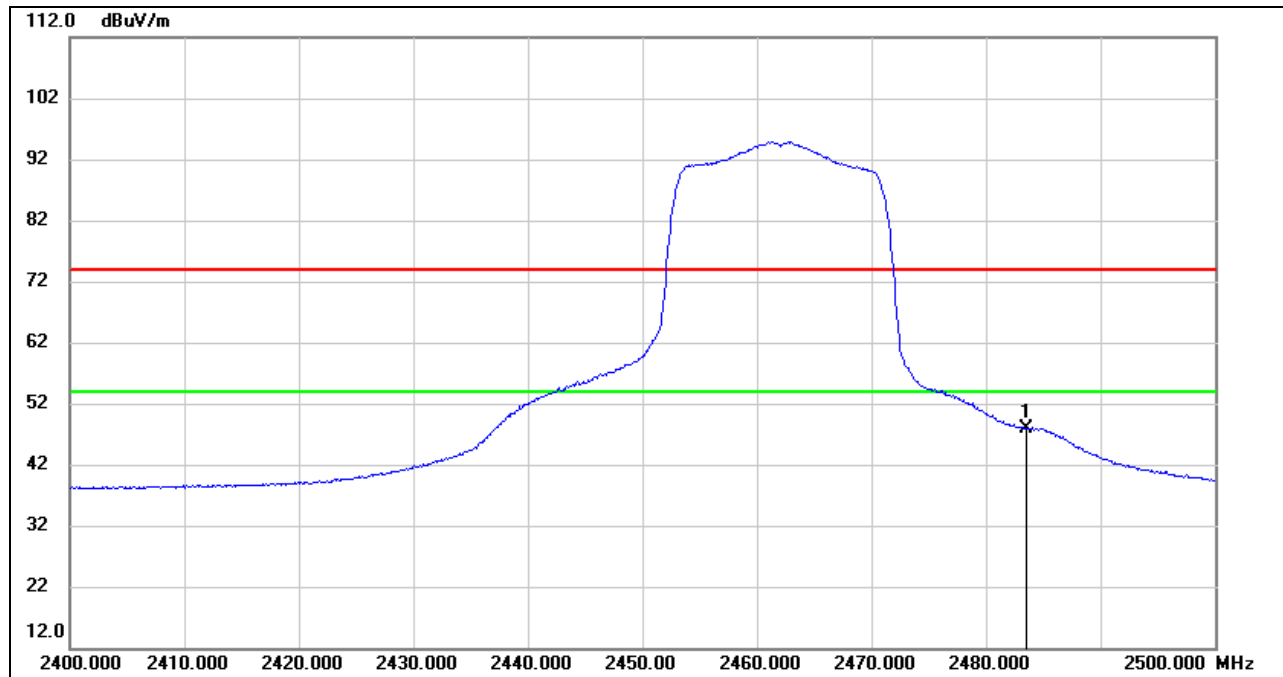

No.	Frequency (MHz)	Reading (dBuV)	Correct (dB/m)	Result (dBuV/m)	Limit (dBuV/m)	Margin (dB)	Remark
1	2483.500	15.41	32.44	47.85	54.00	-6.15	AVG

- Note:
1. Measurement = Reading Level + Correct Factor.
 2. If Peak Result complies with AV limit, AV Result is deemed to comply with AV limit.
 3. AVG: $VBW=1/Ton$, where: Ton is the transmitting duration.
 4. For the transmitting duration, please refer to clause 7.1.
 5. Only the worst data was recorded, if it complies with the limit, the other emissions deemed to comply with the limit.

Note: All the polarities (Vertical & Horizontal) had been tested, only the worst data was recorded in the report.

8.2. SPURIOUS EMISSIONS (1 GHz ~ 3 GHz)

8.2.1. 802.11b MODE

HARMONICS AND SPURIOUS EMISSIONS (LOW CHANNEL, HORIZONTAL)

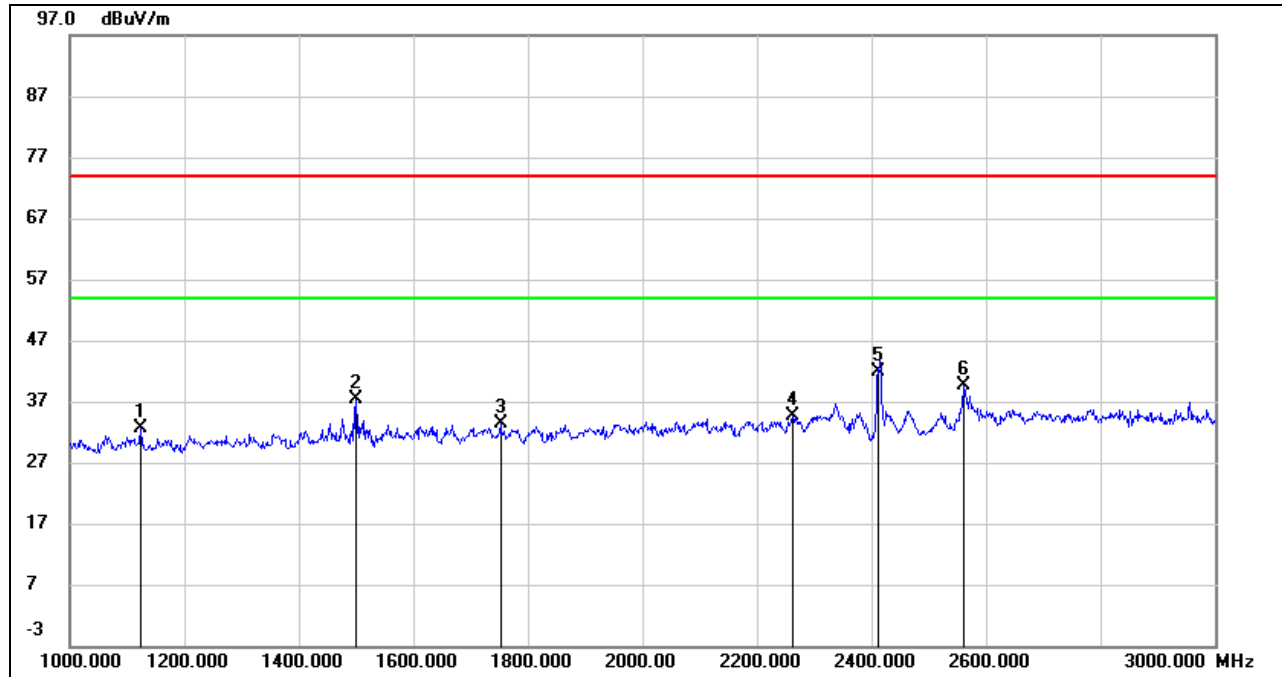

No.	Frequency (MHz)	Reading (dBuV)	Correct (dB/m)	Result (dBuV/m)	Limit (dBuV/m)	Margin (dB)	Remark
1	1124.000	47.06	-14.43	32.63	74.00	-41.37	peak
2	1500.000	49.85	-12.53	37.32	74.00	-36.68	peak
3	1752.000	45.18	-11.76	33.42	74.00	-40.58	peak
4	2262.000	44.32	-9.60	34.72	74.00	-39.28	peak
5	2412.000	50.78	-8.78	42.00	/	/	Fundamental
6	2562.000	47.66	-8.15	39.51	74.00	-34.49	peak

Note: 1. Measurement = Reading Level + Correct Factor.

2. If Peak Result complies with AV limit, AV Result is deemed to comply with AV limit.

3. Peak: Peak detector.

4. Filter losses were only considered in the spurious frequency bands and the authorized band was not corrected for Band reject filter losses.

5. Proper operation of the transmitter prior to adding the filter to the measurement chain.

HARMONICS AND SPURIOUS EMISSIONS (LOW CHANNEL, VERTICAL)

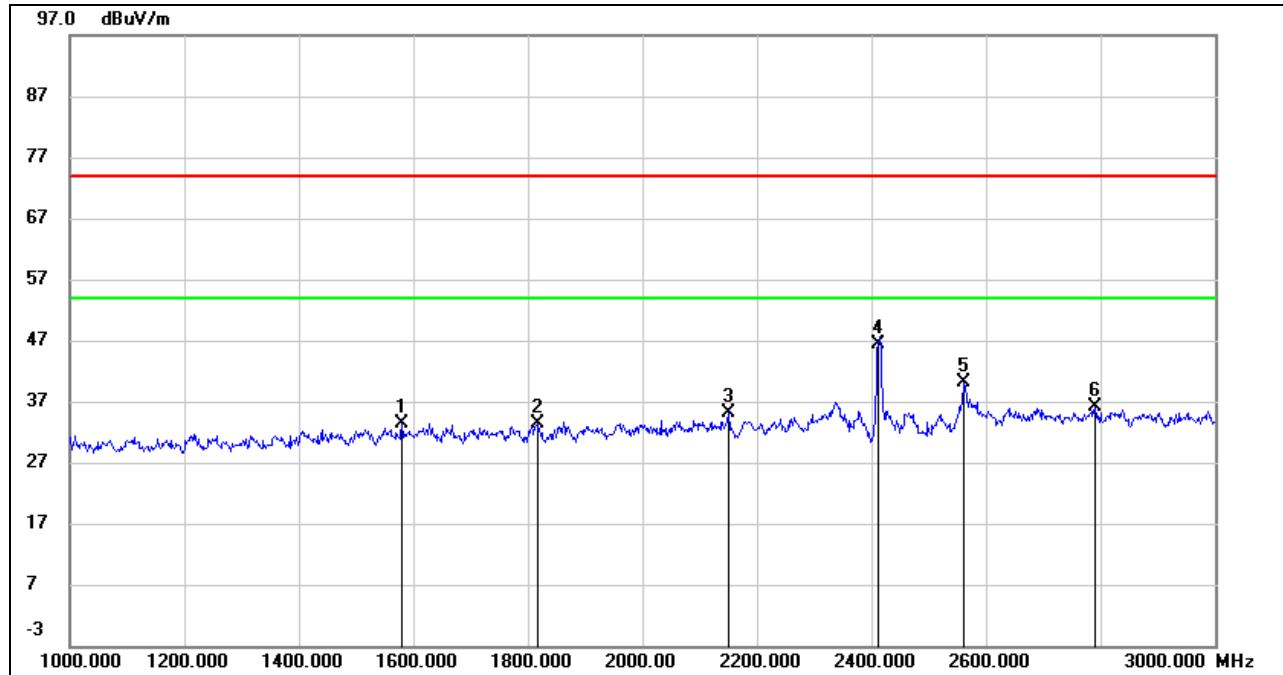

No.	Frequency (MHz)	Reading (dBuV)	Correct (dB/m)	Result (dBuV/m)	Limit (dBuV/m)	Margin (dB)	Remark
1	1580.000	45.58	-12.29	33.29	74.00	-40.71	peak
2	1816.000	44.85	-11.56	33.29	74.00	-40.71	peak
3	2150.000	45.23	-10.19	35.04	74.00	-38.96	peak
4	2412.000	55.13	-8.78	46.35	/	/	Fundamental
5	2562.000	48.29	-8.15	40.14	74.00	-33.86	peak
6	2790.000	43.70	-7.55	36.15	74.00	-37.85	peak

Note: 1. Measurement = Reading Level + Correct Factor.

2. If Peak Result complies with AV limit, AV Result is deemed to comply with AV limit.

3. Peak: Peak detector.

4. Filter losses were only considered in the spurious frequency bands and the authorized band was not corrected for Band reject filter losses.

5. Proper operation of the transmitter prior to adding the filter to the measurement chain.

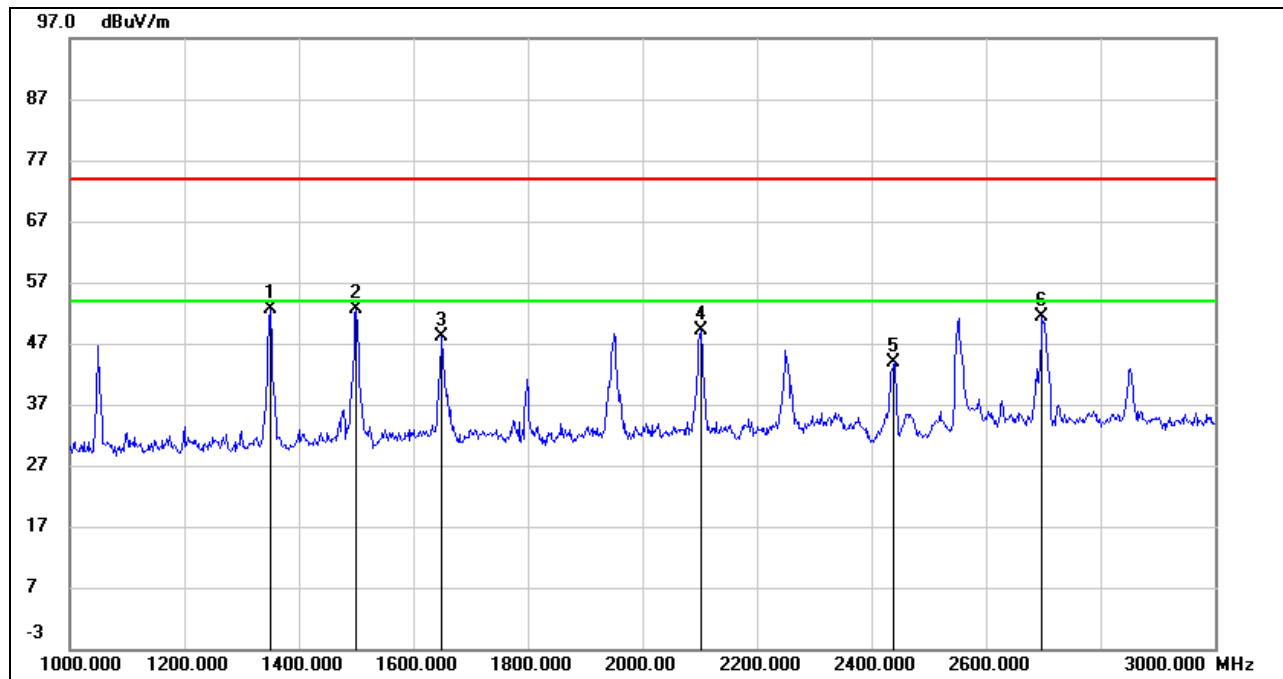
HARMONICS AND SPURIOUS EMISSIONS (MID CHANNEL, HORIZONTAL)

No.	Frequency (MHz)	Reading (dBuV)	Correct (dB/m)	Result (dBuV/m)	Limit (dBuV/m)	Margin (dB)	Remark
1	1350.000	66.01	-13.29	52.72	74.00	-21.28	peak
2	1500.000	65.25	-12.53	52.72	74.00	-21.28	peak
3	1650.000	60.27	-12.07	48.20	74.00	-25.80	peak
4	2102.000	59.64	-10.45	49.19	74.00	-24.81	peak
5	2437.000	52.44	-8.64	43.80	/	/	Fundamental
6	2698.000	59.20	-7.78	51.42	74.00	-22.58	peak

Note: 1. Measurement = Reading Level + Correct Factor.

2. If Peak Result complies with AV limit, AV Result is deemed to comply with AV limit.

3. Peak: Peak detector.

4. Filter losses were only considered in the spurious frequency bands and the authorized band was not corrected for Band reject filter losses.

5. Proper operation of the transmitter prior to adding the filter to the measurement chain.

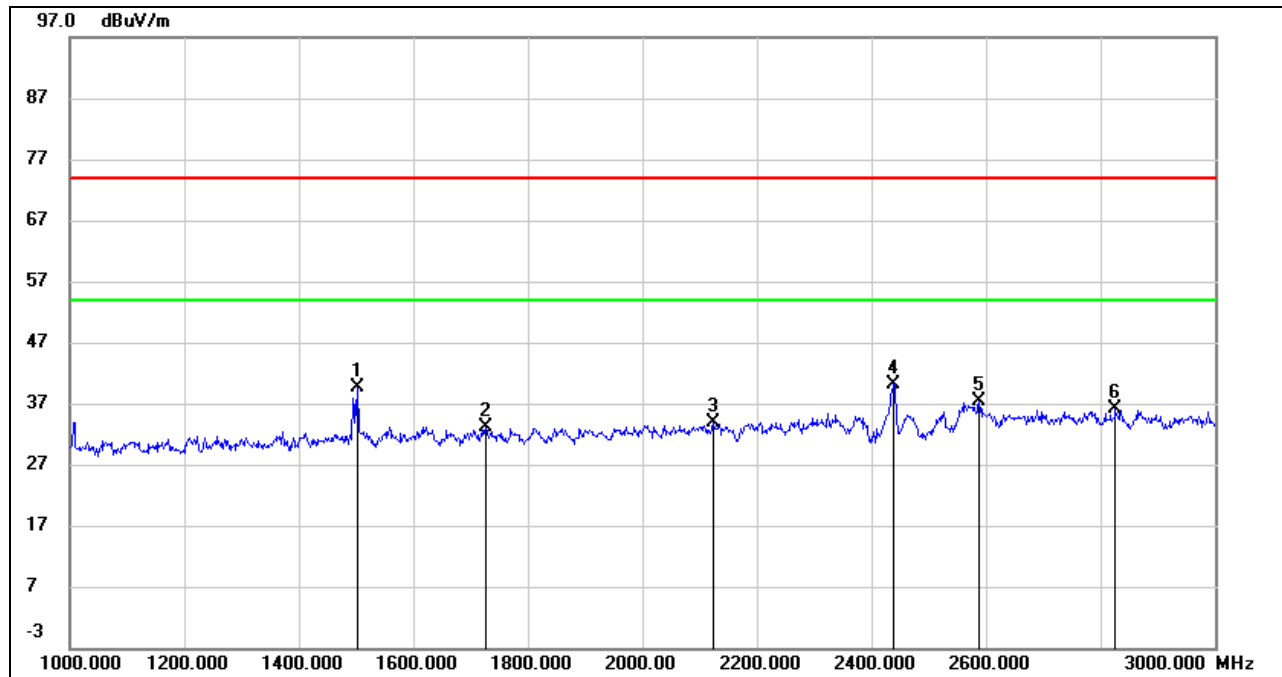
**HARMONICS AND SPURIOUS EMISSIONS (MID CHANNEL, VERTICAL)**

No.	Frequency (MHz)	Reading (dBuV)	Correct (dB/m)	Result (dBuV/m)	Limit (dBuV/m)	Margin (dB)	Remark
1	1502.000	52.11	-12.53	39.58	74.00	-34.42	peak
2	1726.000	45.00	-11.84	33.16	74.00	-40.84	peak
3	2124.000	44.11	-10.33	33.78	74.00	-40.22	peak
4	2437.000	48.88	-8.64	40.24	/	/	Fundamental
5	2588.000	45.41	-8.08	37.33	74.00	-36.67	peak
6	2826.000	43.63	-7.44	36.19	74.00	-37.81	peak

Note: 1. Measurement = Reading Level + Correct Factor.

2. If Peak Result complies with AV limit, AV Result is deemed to comply with AV limit.

3. Peak: Peak detector.

4. Filter losses were only considered in the spurious frequency bands and the authorized band was not corrected for Band reject filter losses.

5. Proper operation of the transmitter prior to adding the filter to the measurement chain.

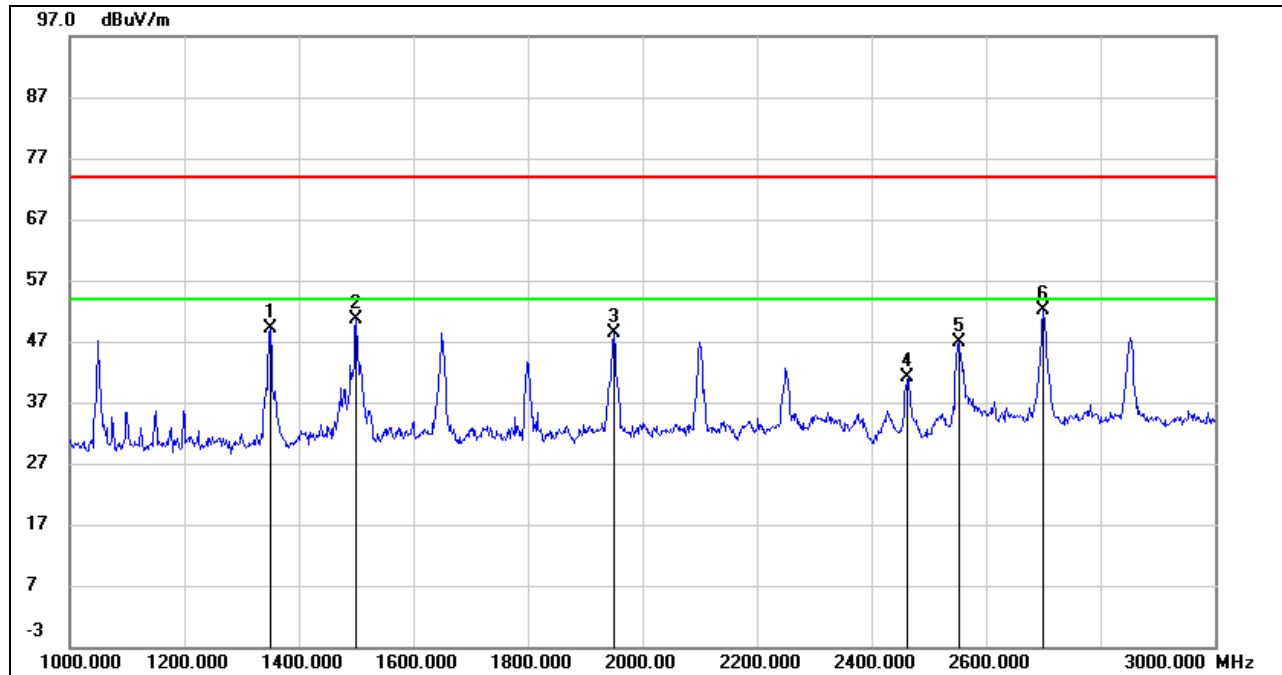
**HARMONICS AND SPURIOUS EMISSIONS (HIGH CHANNEL, HORIZONTAL)**

No.	Frequency (MHz)	Reading (dBuV)	Correct (dB/m)	Result (dBuV/m)	Limit (dBuV/m)	Margin (dB)	Remark
1	1350.000	62.39	-13.29	49.10	74.00	-24.90	peak
2	1500.000	63.10	-12.53	50.57	74.00	-23.43	peak
3	1950.000	59.61	-11.15	48.46	74.00	-25.54	peak
4	2462.000	49.68	-8.52	41.16	/	/	Fundamental
5	2552.000	55.15	-8.17	46.98	74.00	-27.02	peak
6	2700.000	59.91	-7.78	52.13	74.00	-21.87	peak

- Note: 1. Measurement = Reading Level + Correct Factor.
2. If Peak Result complies with AV limit, AV Result is deemed to comply with AV limit.
3. Peak: Peak detector.
4. Filter losses were only considered in the spurious frequency bands and the authorized band was not corrected for Band reject filter losses.
5. Proper operation of the transmitter prior to adding the filter to the measurement chain.

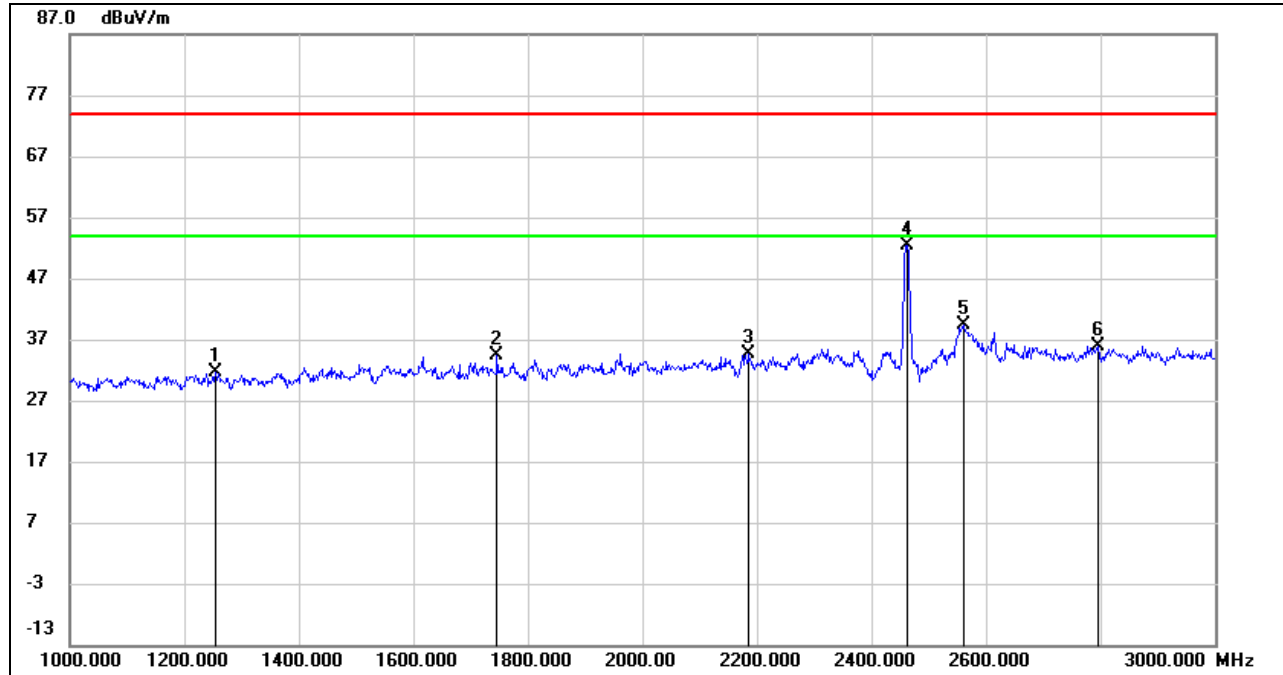
HARMONICS AND SPURIOUS EMISSIONS (HIGH CHANNEL, VERTICAL)

No.	Frequency (MHz)	Reading (dBuV)	Correct (dB/m)	Result (dBuV/m)	Limit (dBuV/m)	Margin (dB)	Remark
1	1254.000	45.33	-13.78	31.55	74.00	-42.45	peak
2	1746.000	46.09	-11.78	34.31	74.00	-39.69	peak
3	2186.000	44.63	-10.00	34.63	74.00	-39.37	peak
4	2462.000	60.91	-8.52	52.39	/	/	Fundamental
5	2560.000	47.45	-8.15	39.30	74.00	-34.70	peak
6	2796.000	43.50	-7.53	35.97	74.00	-38.03	peak

Note: 1. Measurement = Reading Level + Correct Factor.

2. If Peak Result complies with AV limit, AV Result is deemed to comply with AV limit.

3. Peak: Peak detector.

4. Filter losses were only considered in the spurious frequency bands and the authorized band was not corrected for Band reject filter losses.

5. Proper operation of the transmitter prior to adding the filter to the measurement chain.

Note: All the modes and channels had been tested, but only the worst data was recorded in the report.

8.3. SPURIOUS EMISSIONS (3 GHz ~ 18 GHz)

8.3.1. 802.11b MODE

HARMONICS AND SPURIOUS EMISSIONS (LOW CHANNEL, HORIZONTAL)

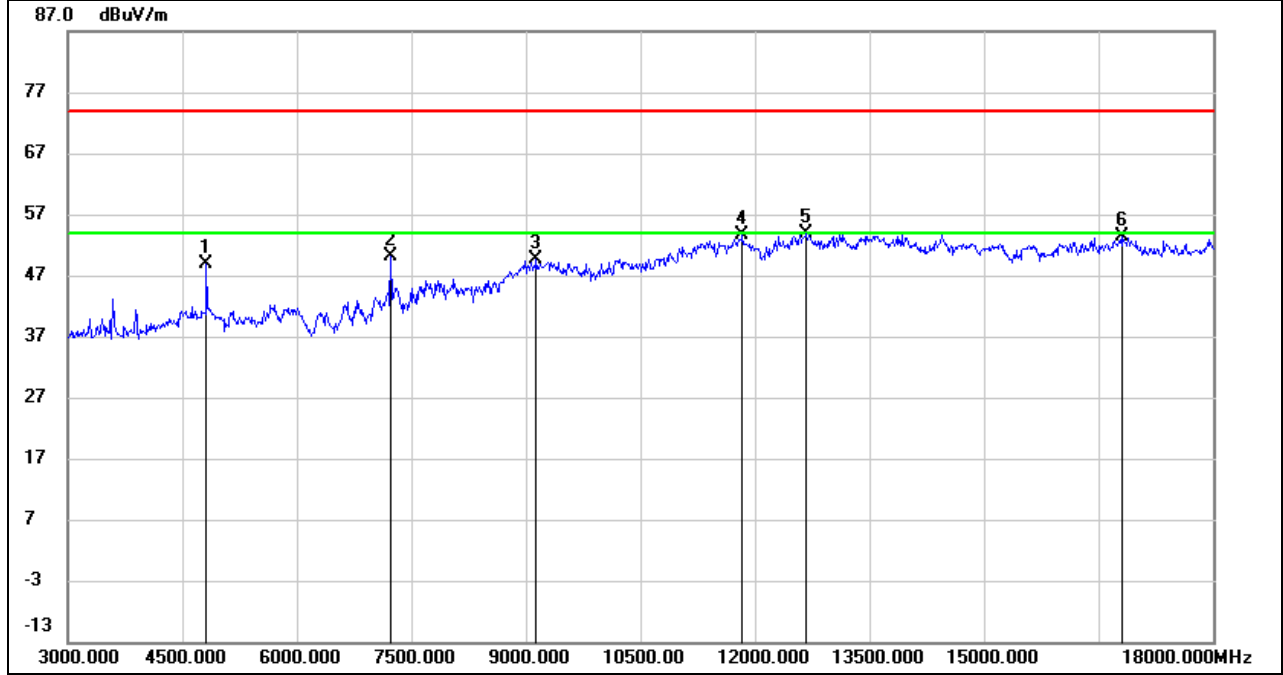

No.	Frequency (MHz)	Reading (dBuV)	Correct (dB/m)	Result (dBuV/m)	Limit (dBuV/m)	Margin (dB)	Remark
1	4815.000	47.82	0.97	48.79	74.00	-25.21	peak
2	7230.000	42.32	7.85	50.17	74.00	-23.83	peak
3	9135.000	37.44	12.11	49.55	74.00	-24.45	peak
4	11835.000	34.27	19.33	53.60	74.00	-20.40	peak
5	12675.000	33.54	20.23	53.77	74.00	-20.23	peak
6	16815.000	30.39	23.05	53.44	74.00	-20.56	peak

- Note: 1. Peak Result = Reading Level + Correct Factor.
 2. If Peak Result complies with AV limit, AV Result is deemed to comply with AV limit.
 3. Peak: Peak detector.
 4. Filter losses were only considered in the spurious frequency bands and the authorized band was not corrected for High Pass Filter losses.
 5. Proper operation of the transmitter prior to adding the filter to the measurement chain.

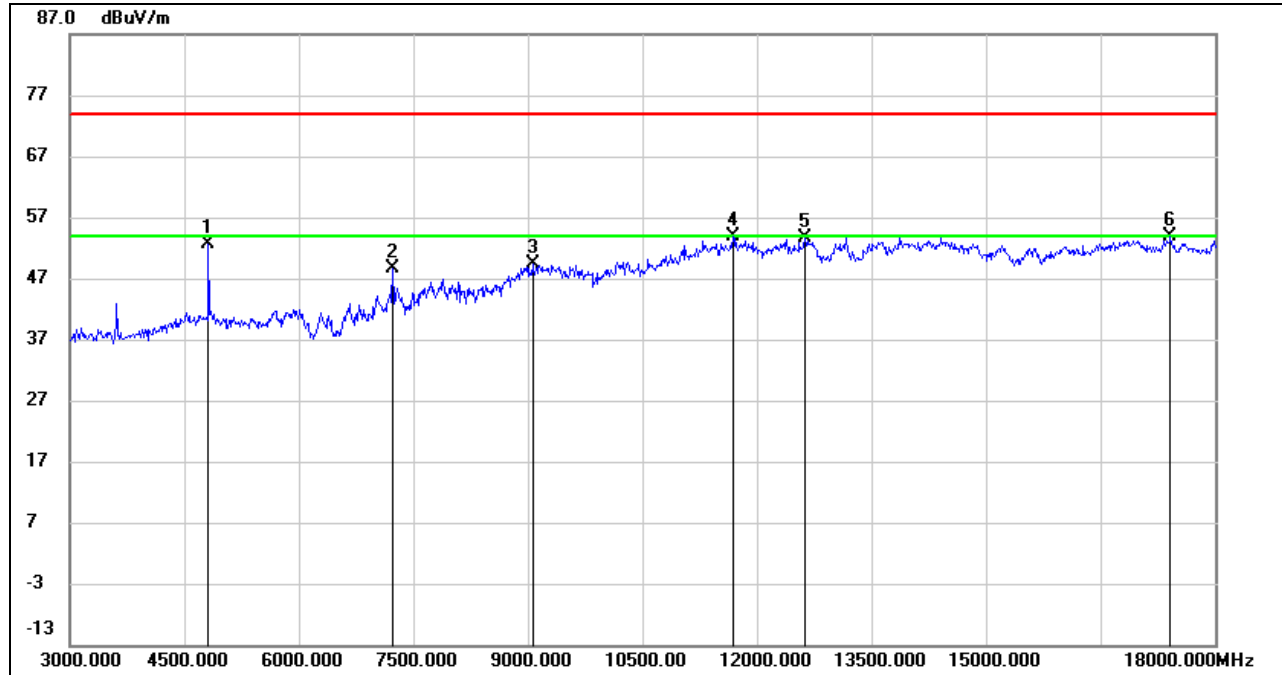
**HARMONICS AND SPURIOUS EMISSIONS (LOW CHANNEL, VERTICAL)**

No.	Frequency (MHz)	Reading (dBuV)	Correct (dB/m)	Result (dBuV/m)	Limit (dBuV/m)	Margin (dB)	Remark
1	4815.000	51.70	0.97	52.67	74.00	-21.33	peak
2	7230.000	40.82	7.85	48.67	74.00	-25.33	peak
3	9060.000	37.38	12.05	49.43	74.00	-24.57	peak
4	11685.000	34.97	18.79	53.76	74.00	-20.24	peak
5	12630.000	33.59	20.15	53.74	74.00	-20.26	peak
6	17415.000	28.31	25.52	53.83	74.00	-20.17	peak

- Note:
1. Peak Result = Reading Level + Correct Factor.
 2. If Peak Result complies with AV limit, AV Result is deemed to comply with AV limit.
 3. Peak: Peak detector.
 4. Filter losses were only considered in the spurious frequency bands and the authorized band was not corrected for High Pass Filter losses.
 5. Proper operation of the transmitter prior to adding the filter to the measurement chain.

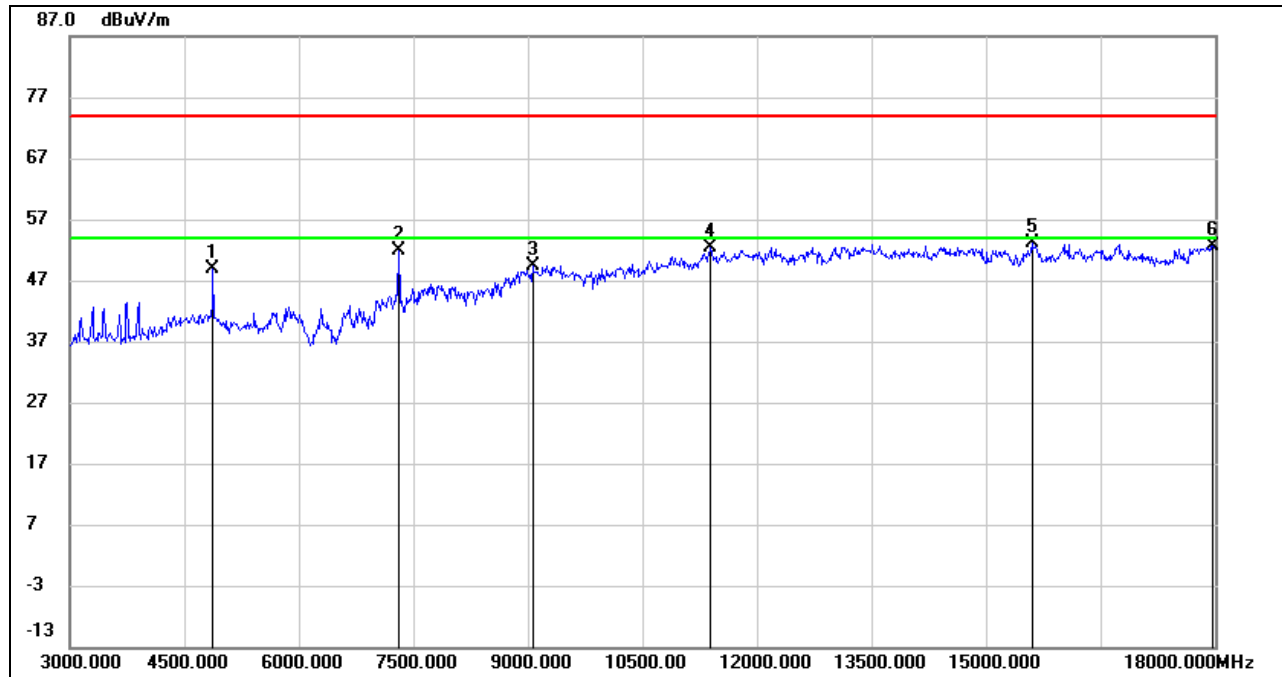
**HARMONICS AND SPURIOUS EMISSIONS (MID CHANNEL, HORIZONTAL)**

No.	Frequency (MHz)	Reading (dBuV)	Correct (dB/m)	Result (dBuV/m)	Limit (dBuV/m)	Margin (dB)	Remark
1	4875.000	47.71	1.20	48.91	74.00	-25.09	peak
2	7305.000	44.12	7.85	51.97	74.00	-22.03	peak
3	9060.000	37.39	12.05	49.44	74.00	-24.56	peak
4	11385.000	34.76	17.59	52.35	74.00	-21.65	peak
5	15600.000	33.38	19.81	53.19	74.00	-20.81	peak
6	17970.000	23.94	28.61	52.55	74.00	-21.45	peak

Note: 1. Peak Result = Reading Level + Correct Factor.

2. If Peak Result complies with AV limit, AV Result is deemed to comply with AV limit.

3. Peak: Peak detector.

4. Filter losses were only considered in the spurious frequency bands and the authorized band was not corrected for High Pass Filter losses.

5. Proper operation of the transmitter prior to adding the filter to the measurement chain.

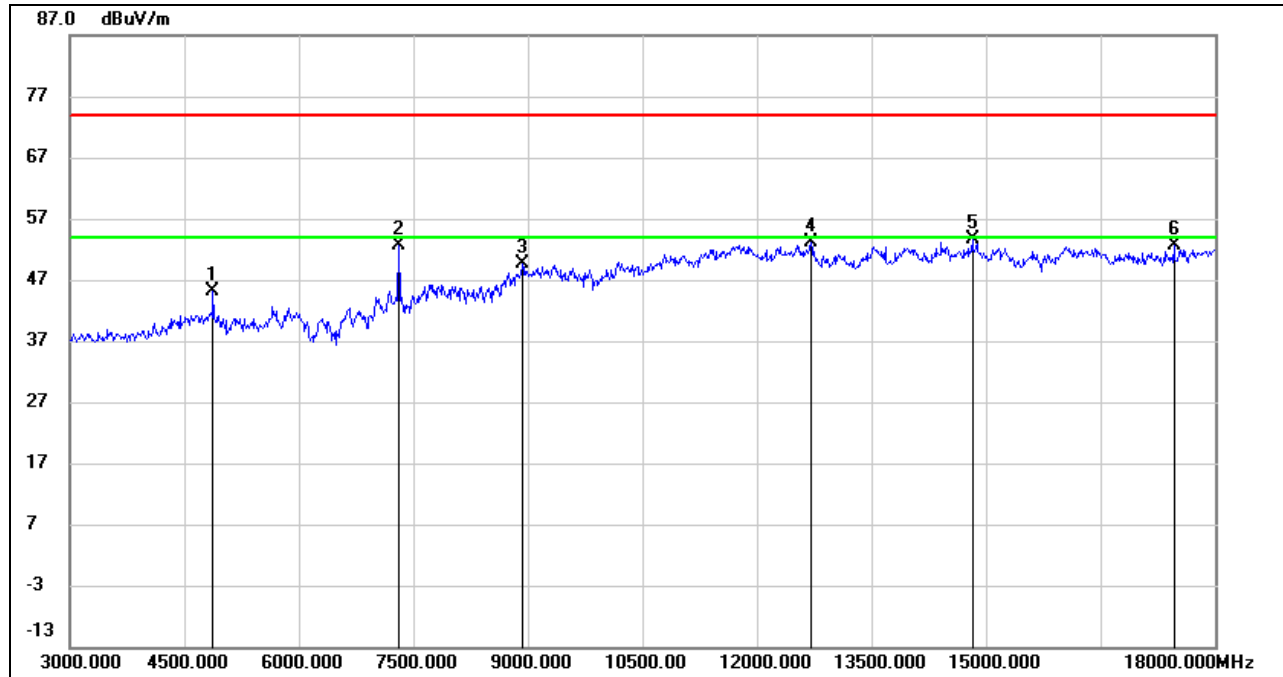
HARMONICS AND SPURIOUS EMISSIONS (MID CHANNEL, VERTICAL)

No.	Frequency (MHz)	Reading (dBuV)	Correct (dB/m)	Result (dBuV/m)	Limit (dBuV/m)	Margin (dB)	Remark
1	4875.000	44.02	1.20	45.22	74.00	-28.78	peak
2	7305.000	44.78	7.85	52.63	74.00	-21.37	peak
3	8925.000	38.04	11.50	49.54	74.00	-24.46	peak
4	12705.000	32.88	20.28	53.16	74.00	-20.84	peak
5	14820.000	32.24	21.33	53.57	74.00	-20.43	peak
6	17460.000	26.90	25.70	52.60	74.00	-21.40	peak

Note: 1. Peak Result = Reading Level + Correct Factor.

2. If Peak Result complies with AV limit, AV Result is deemed to comply with AV limit.

3. Peak: Peak detector.

4. Filter losses were only considered in the spurious frequency bands and the authorized band was not corrected for High Pass Filter losses.

5. Proper operation of the transmitter prior to adding the filter to the measurement chain.

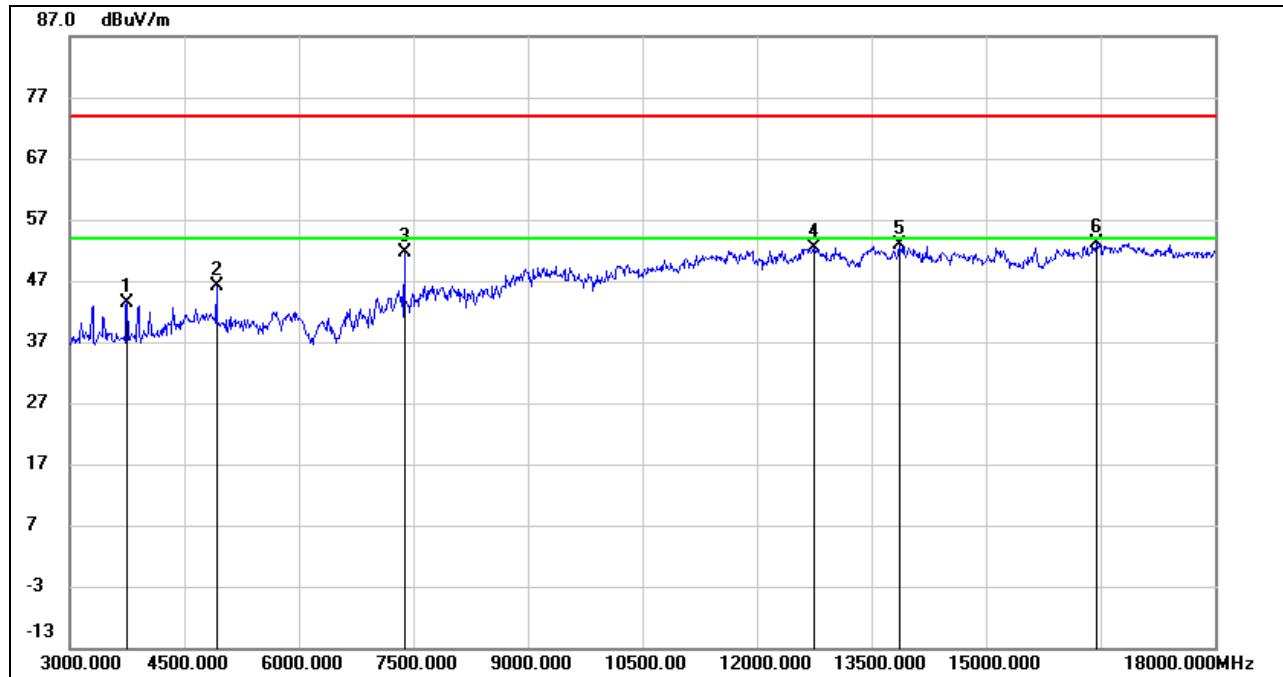
HARMONICS AND SPURIOUS EMISSIONS (HIGH CHANNEL, HORIZONTAL)

No.	Frequency (MHz)	Reading (dBuV)	Correct (dB/m)	Result (dBuV/m)	Limit (dBuV/m)	Margin (dB)	Remark
1	3750.000	46.85	-3.35	43.50	74.00	-30.50	peak
2	4920.000	44.86	1.36	46.22	74.00	-27.78	peak
3	7380.000	43.67	7.84	51.51	74.00	-22.49	peak
4	12750.000	32.12	20.35	52.47	74.00	-21.53	peak
5	13860.000	29.14	23.82	52.96	74.00	-21.04	peak
6	16440.000	31.58	21.52	53.10	74.00	-20.90	peak

Note: 1. Peak Result = Reading Level + Correct Factor.

2. If Peak Result complies with AV limit, AV Result is deemed to comply with AV limit.

3. Peak: Peak detector.

4. Filter losses were only considered in the spurious frequency bands and the authorized band was not corrected for High Pass Filter losses.

5. Proper operation of the transmitter prior to adding the filter to the measurement chain.

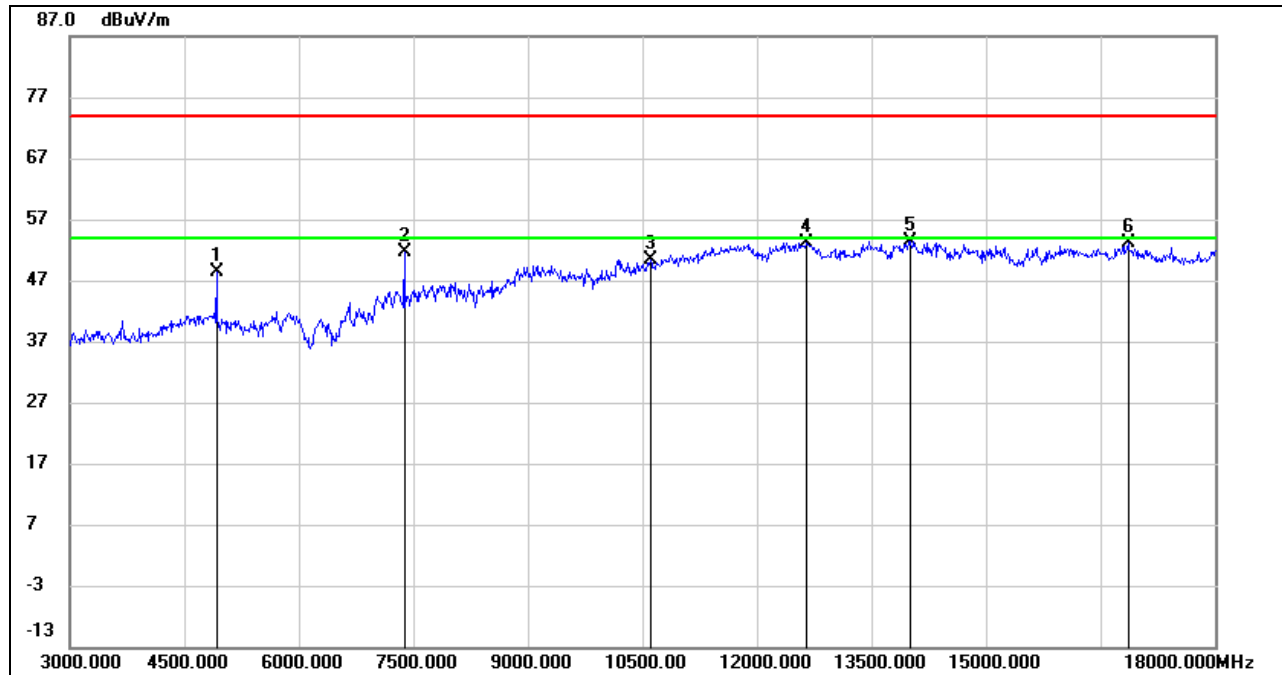
**HARMONICS AND SPURIOUS EMISSIONS (HIGH CHANNEL, VERTICAL)**

No.	Frequency (MHz)	Reading (dBuV)	Correct (dB/m)	Result (dBuV/m)	Limit (dBuV/m)	Margin (dB)	Remark
1	4920.000	47.04	1.36	48.40	74.00	-25.60	peak
2	7380.000	43.89	7.84	51.73	74.00	-22.27	peak
3	10605.000	35.64	14.83	50.47	74.00	-23.53	peak
4	12645.000	32.95	20.17	53.12	74.00	-20.88	peak
5	14010.000	29.24	24.16	53.40	74.00	-20.60	peak
6	16860.000	29.95	23.25	53.20	74.00	-20.80	peak

Note: 1. Peak Result = Reading Level + Correct Factor.

2. If Peak Result complies with AV limit, AV Result is deemed to comply with AV limit.

3. Peak: Peak detector.

4. Filter losses were only considered in the spurious frequency bands and the authorized band was not corrected for High Pass Filter losses.

5. Proper operation of the transmitter prior to adding the filter to the measurement chain.

8.3.2. 802.11g MODE

HARMONICS AND SPURIOUS EMISSIONS (LOW CHANNEL, HORIZONTAL)

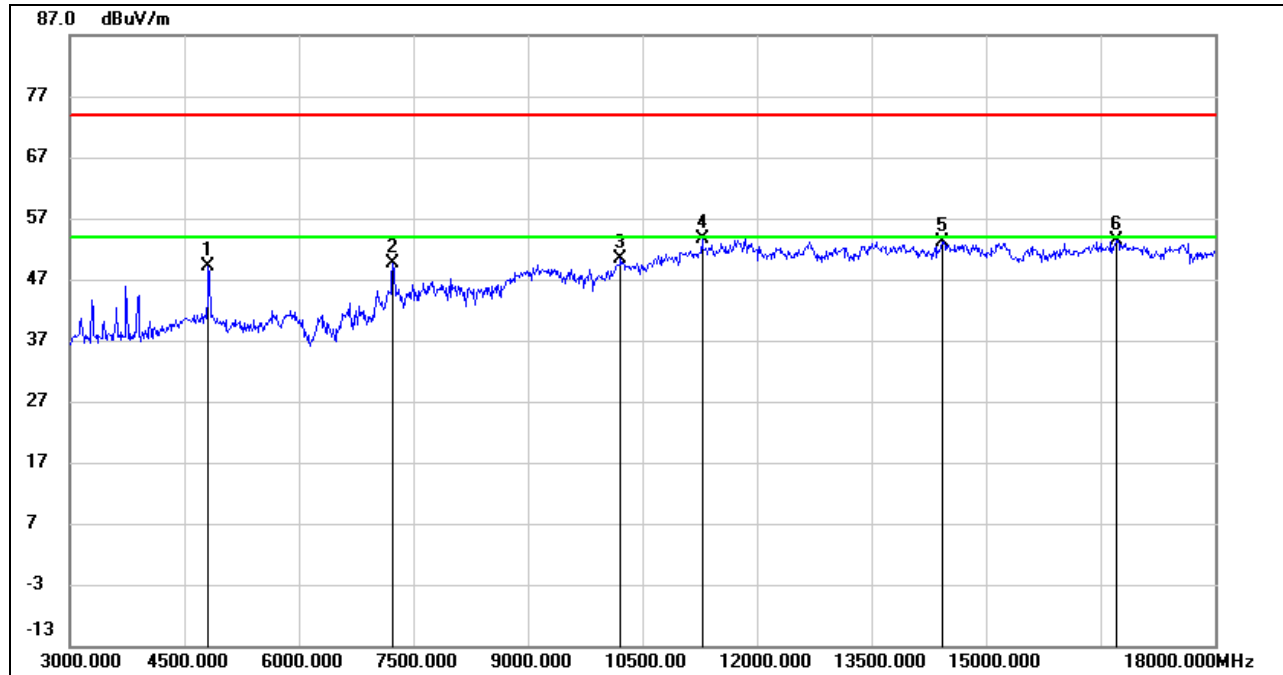

No.	Frequency (MHz)	Reading (dBuV)	Correct (dB/m)	Result (dBuV/m)	Limit (dBuV/m)	Margin (dB)	Remark
1	4815.000	48.18	0.97	49.15	74.00	-24.85	peak
2	7230.000	41.75	7.85	49.60	74.00	-24.40	peak
3	10215.000	36.57	13.91	50.48	74.00	-23.52	peak
4	11280.000	36.55	17.11	53.66	74.00	-20.34	peak
5	14430.000	30.53	22.70	53.23	74.00	-20.77	peak
6	16710.000	30.81	22.61	53.42	74.00	-20.58	peak

Note: 1. Peak Result = Reading Level + Correct Factor.

2. If Peak Result complies with AV limit, AV Result is deemed to comply with AV limit.

3. Peak: Peak detector.

4. Filter losses were only considered in the spurious frequency bands and the authorized band was not corrected for High Pass Filter losses.

5. Proper operation of the transmitter prior to adding the filter to the measurement chain.

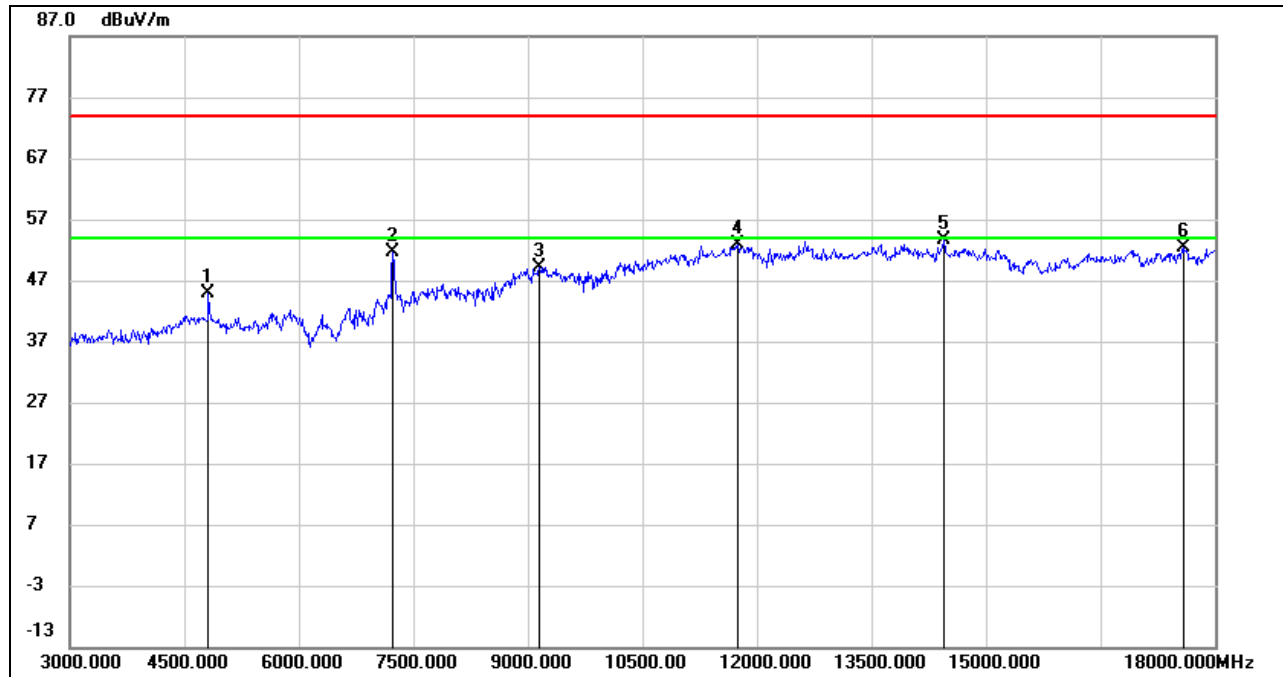
**HARMONICS AND SPURIOUS EMISSIONS (LOW CHANNEL, VERTICAL)**

No.	Frequency (MHz)	Reading (dBuV)	Correct (dB/m)	Result (dBuV/m)	Limit (dBuV/m)	Margin (dB)	Remark
1	4815.000	44.00	0.97	44.97	74.00	-29.03	peak
2	7230.000	43.77	7.85	51.62	74.00	-22.38	peak
3	9150.000	37.02	12.11	49.13	74.00	-24.87	peak
4	11745.000	33.88	19.01	52.89	74.00	-21.11	peak
5	14445.000	30.90	22.65	53.55	74.00	-20.45	peak
6	17595.000	26.03	26.42	52.45	74.00	-21.55	peak

Note: 1. Peak Result = Reading Level + Correct Factor.

2. If Peak Result complies with AV limit, AV Result is deemed to comply with AV limit.

3. Peak: Peak detector.

4. Filter losses were only considered in the spurious frequency bands and the authorized band was not corrected for High Pass Filter losses.

5. Proper operation of the transmitter prior to adding the filter to the measurement chain.

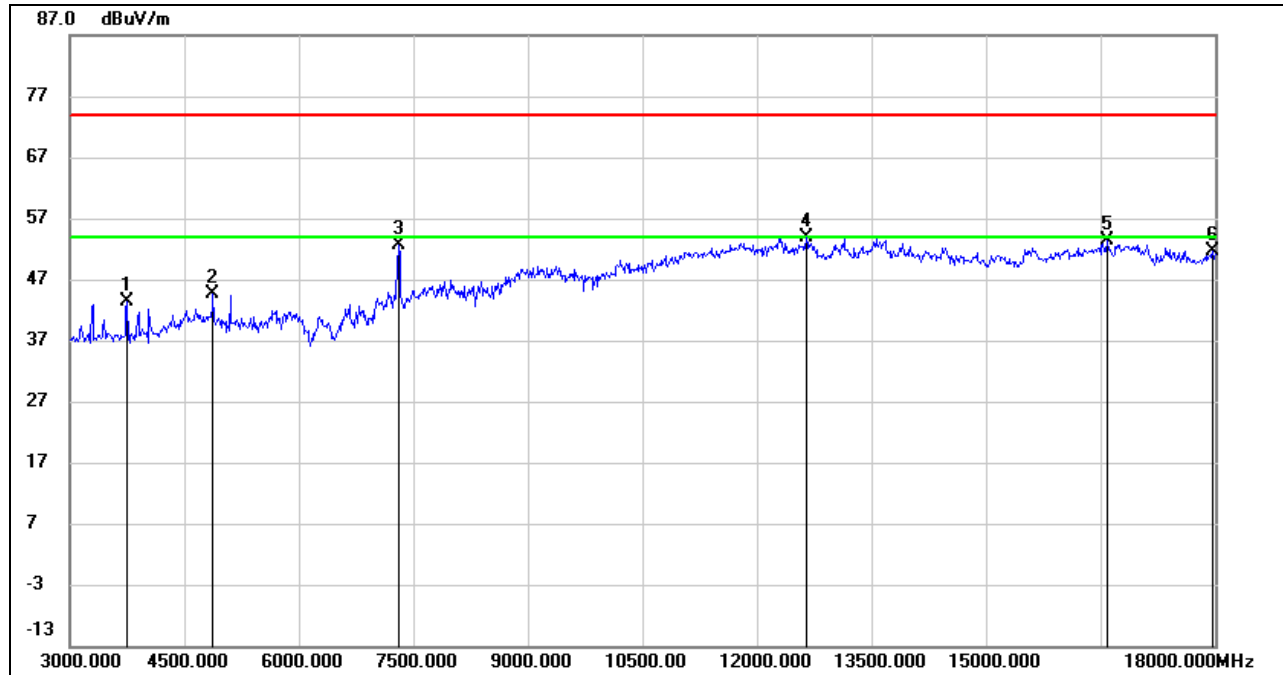
HARMONICS AND SPURIOUS EMISSIONS (MID CHANNEL, HORIZONTAL)

No.	Frequency (MHz)	Reading (dBuV)	Correct (dB/m)	Result (dBuV/m)	Limit (dBuV/m)	Margin (dB)	Remark
1	3750.000	46.69	-3.35	43.34	74.00	-30.66	peak
2	4875.000	43.45	1.20	44.65	74.00	-29.35	peak
3	7305.000	44.68	7.85	52.53	74.00	-21.47	peak
4	12645.000	33.64	20.17	53.81	74.00	-20.19	peak
5	16590.000	31.24	22.09	53.33	74.00	-20.67	peak
6	17970.000	23.09	28.61	51.70	74.00	-22.30	peak

Note: 1. Peak Result = Reading Level + Correct Factor.

2. If Peak Result complies with AV limit, AV Result is deemed to comply with AV limit.

3. Peak: Peak detector.

4. Filter losses were only considered in the spurious frequency bands and the authorized band was not corrected for High Pass Filter losses.

5. Proper operation of the transmitter prior to adding the filter to the measurement chain.

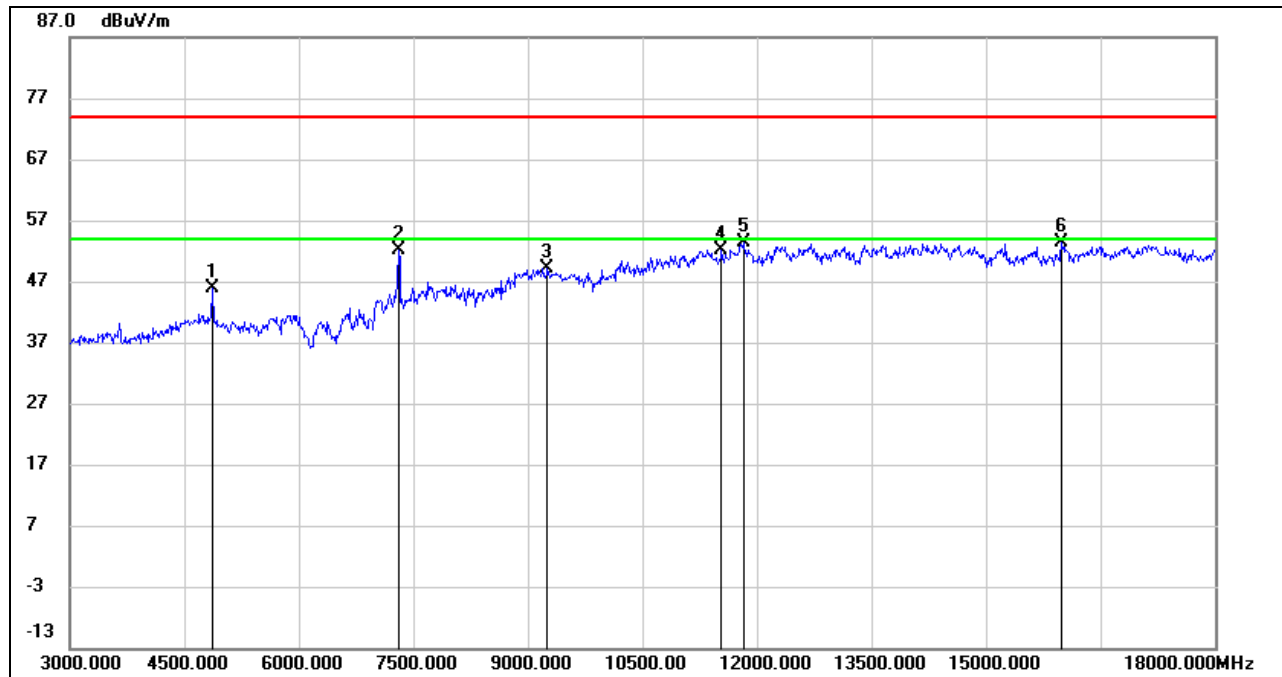
**HARMONICS AND SPURIOUS EMISSIONS (MID CHANNEL, VERTICAL)**

No.	Frequency (MHz)	Reading (dBuV)	Correct (dB/m)	Result (dBuV/m)	Limit (dBuV/m)	Margin (dB)	Remark
1	4860.000	44.64	1.13	45.77	74.00	-28.23	peak
2	7305.000	44.32	7.85	52.17	74.00	-21.83	peak
3	9255.000	36.99	12.19	49.18	74.00	-24.82	peak
4	11535.000	33.94	18.26	52.20	74.00	-21.80	peak
5	11820.000	34.04	19.27	53.31	74.00	-20.69	peak
6	15990.000	33.24	20.03	53.27	74.00	-20.73	peak

Note: 1. Peak Result = Reading Level + Correct Factor.

2. If Peak Result complies with AV limit, AV Result is deemed to comply with AV limit.

3. Peak: Peak detector.

4. Filter losses were only considered in the spurious frequency bands and the authorized band was not corrected for High Pass Filter losses.

5. Proper operation of the transmitter prior to adding the filter to the measurement chain.

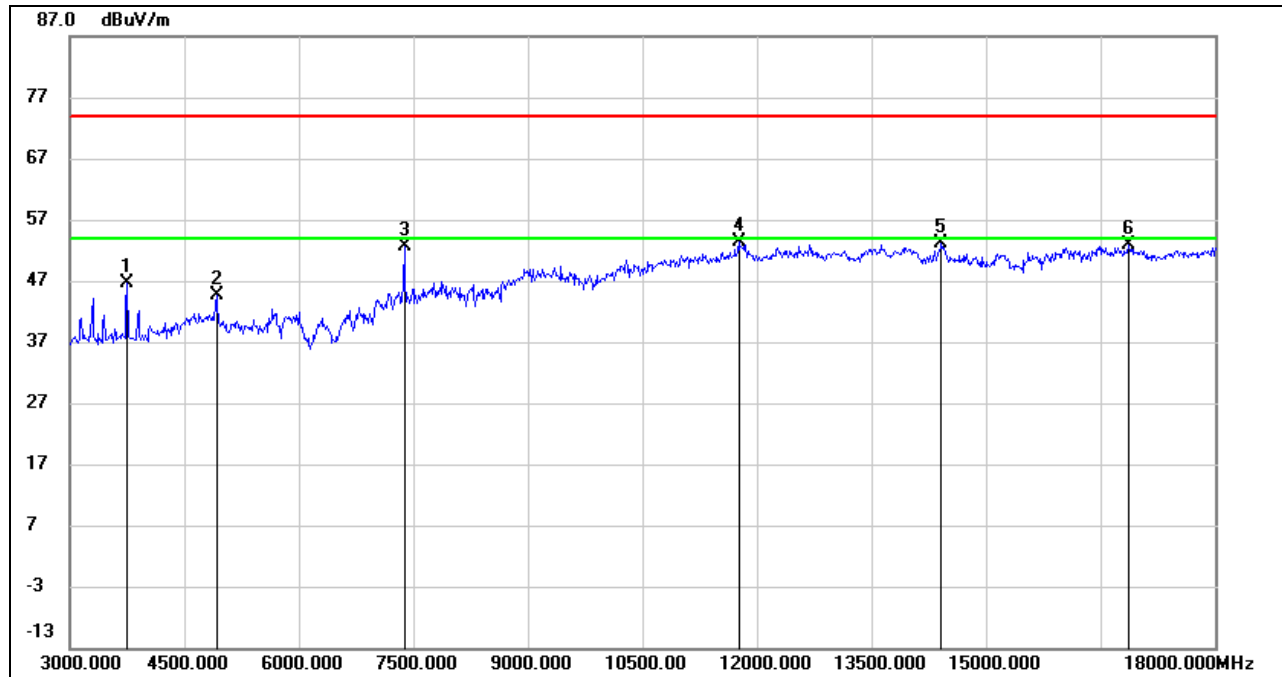
**HARMONICS AND SPURIOUS EMISSIONS (HIGH CHANNEL, HORIZONTAL)**

No.	Frequency (MHz)	Reading (dBuV)	Correct (dB/m)	Result (dBuV/m)	Limit (dBuV/m)	Margin (dB)	Remark
1	3750.000	50.06	-3.35	46.71	74.00	-27.29	peak
2	4920.000	43.34	1.36	44.70	74.00	-29.30	peak
3	7380.000	44.87	7.84	52.71	74.00	-21.29	peak
4	11760.000	34.27	19.06	53.33	74.00	-20.67	peak
5	14415.000	30.34	22.75	53.09	74.00	-20.91	peak
6	16875.000	29.59	23.31	52.90	74.00	-21.10	peak

Note: 1. Peak Result = Reading Level + Correct Factor.

2. If Peak Result complies with AV limit, AV Result is deemed to comply with AV limit.

3. Peak: Peak detector.

4. Filter losses were only considered in the spurious frequency bands and the authorized band was not corrected for High Pass Filter losses.

5. Proper operation of the transmitter prior to adding the filter to the measurement chain.

HARMONICS AND SPURIOUS EMISSIONS (HIGH CHANNEL, VERTICAL)

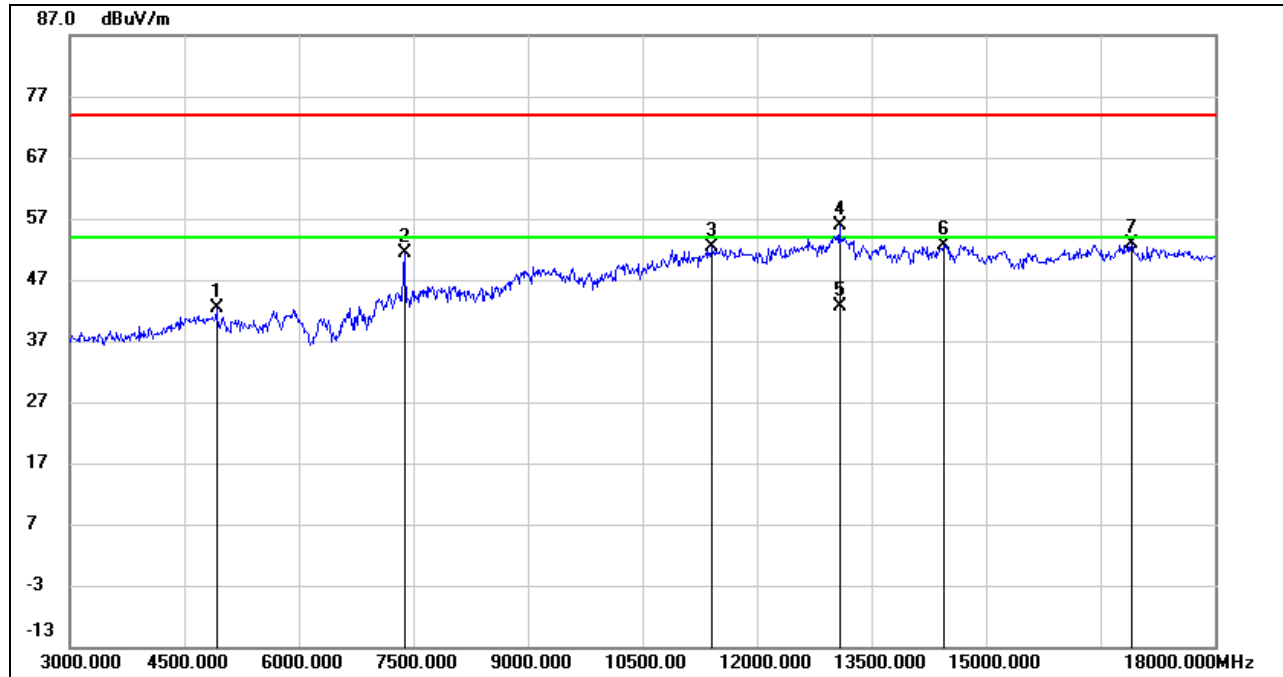

No.	Frequency (MHz)	Reading (dBuV)	Correct (dB/m)	Result (dBuV/m)	Limit (dBuV/m)	Margin (dB)	Remark
1	4920.000	41.01	1.36	42.37	74.00	-31.63	peak
2	7380.000	43.45	7.84	51.29	74.00	-22.71	peak
3	11415.000	34.53	17.74	52.27	74.00	-21.73	peak
4	13080.000	34.91	21.09	56.00	74.00	-18.00	peak
5	13080.000	21.53	21.09	42.62	54.00	-11.38	AVG
6	14445.000	29.93	22.65	52.58	74.00	-21.42	peak
7	16905.000	29.38	23.43	52.81	74.00	-21.19	peak

- Note: 1. Peak Result = Reading Level + Correct Factor.
 2. If Peak Result complies with AV limit, AV Result is deemed to comply with AV limit.
 3. Peak: Peak detector.
 4. Filter losses were only considered in the spurious frequency bands and the authorized band was not corrected for High Pass Filter losses.
 5. Proper operation of the transmitter prior to adding the filter to the measurement chain.



8.3.3. 802.11n HT20 MODE

HARMONICS AND SPURIOUS EMISSIONS (LOW CHANNEL, HORIZONTAL)

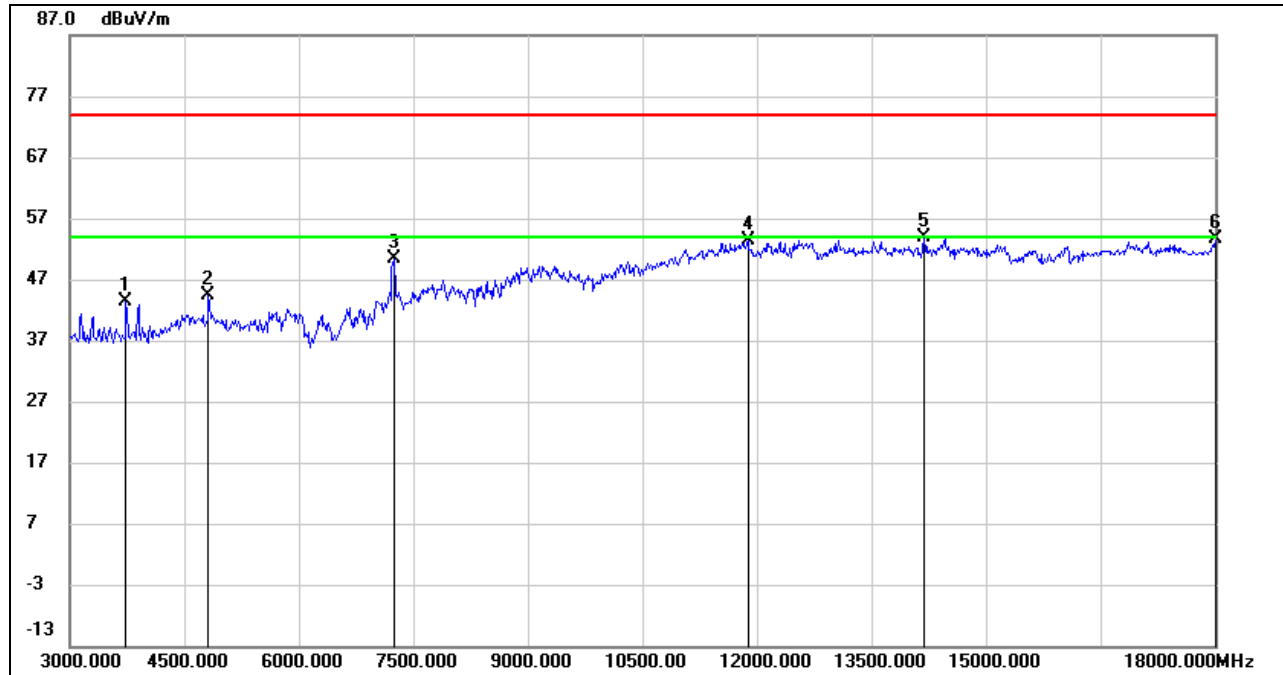

No.	Frequency (MHz)	Reading (dBuV)	Correct (dB/m)	Result (dBuV/m)	Limit (dBuV/m)	Margin (dB)	Remark
1	3735.000	46.79	-3.38	43.41	74.00	-30.59	peak
2	4815.000	43.40	0.97	44.37	74.00	-29.63	peak
3	7245.000	42.47	7.85	50.32	74.00	-23.68	peak
4	11880.000	33.98	19.48	53.46	74.00	-20.54	peak
5	14190.000	30.38	23.52	53.90	74.00	-20.10	peak
6	18000.000	24.75	28.79	53.54	74.00	-20.46	peak

- Note: 1. Peak Result = Reading Level + Correct Factor.
 2. If Peak Result complies with AV limit, AV Result is deemed to comply with AV limit.
 3. Peak: Peak detector.
 4. Filter losses were only considered in the spurious frequency bands and the authorized band was not corrected for High Pass Filter losses.
 5. Proper operation of the transmitter prior to adding the filter to the measurement chain.

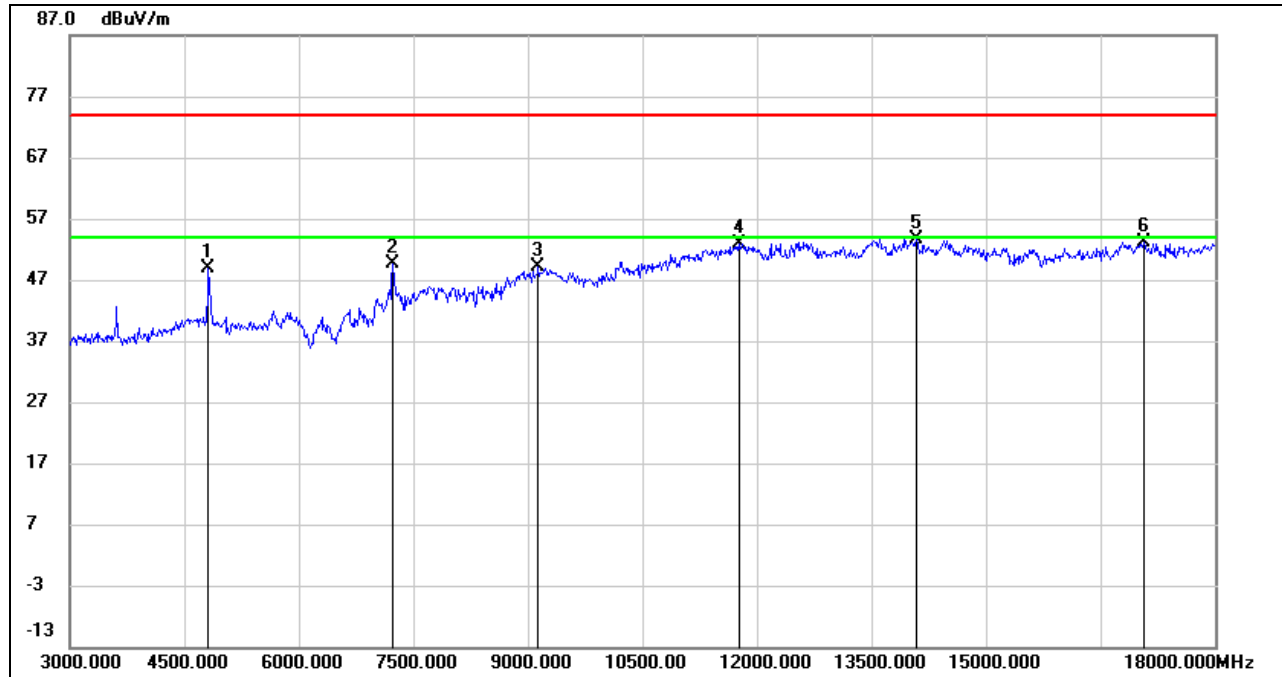
**HARMONICS AND SPURIOUS EMISSIONS (LOW CHANNEL, VERTICAL)**

No.	Frequency (MHz)	Reading (dBuV)	Correct (dB/m)	Result (dBuV/m)	Limit (dBuV/m)	Margin (dB)	Remark
1	4815.000	47.96	0.97	48.93	74.00	-25.07	peak
2	7230.000	41.85	7.85	49.70	74.00	-24.30	peak
3	9135.000	37.09	12.11	49.20	74.00	-24.80	peak
4	11760.000	33.76	19.06	52.82	74.00	-21.18	peak
5	14085.000	29.78	23.89	53.67	74.00	-20.33	peak
6	17070.000	29.06	24.12	53.18	74.00	-20.82	peak

Note: 1. Peak Result = Reading Level + Correct Factor.

2. If Peak Result complies with AV limit, AV Result is deemed to comply with AV limit.

3. Peak: Peak detector.

4. Filter losses were only considered in the spurious frequency bands and the authorized band was not corrected for High Pass Filter losses.

5. Proper operation of the transmitter prior to adding the filter to the measurement chain.

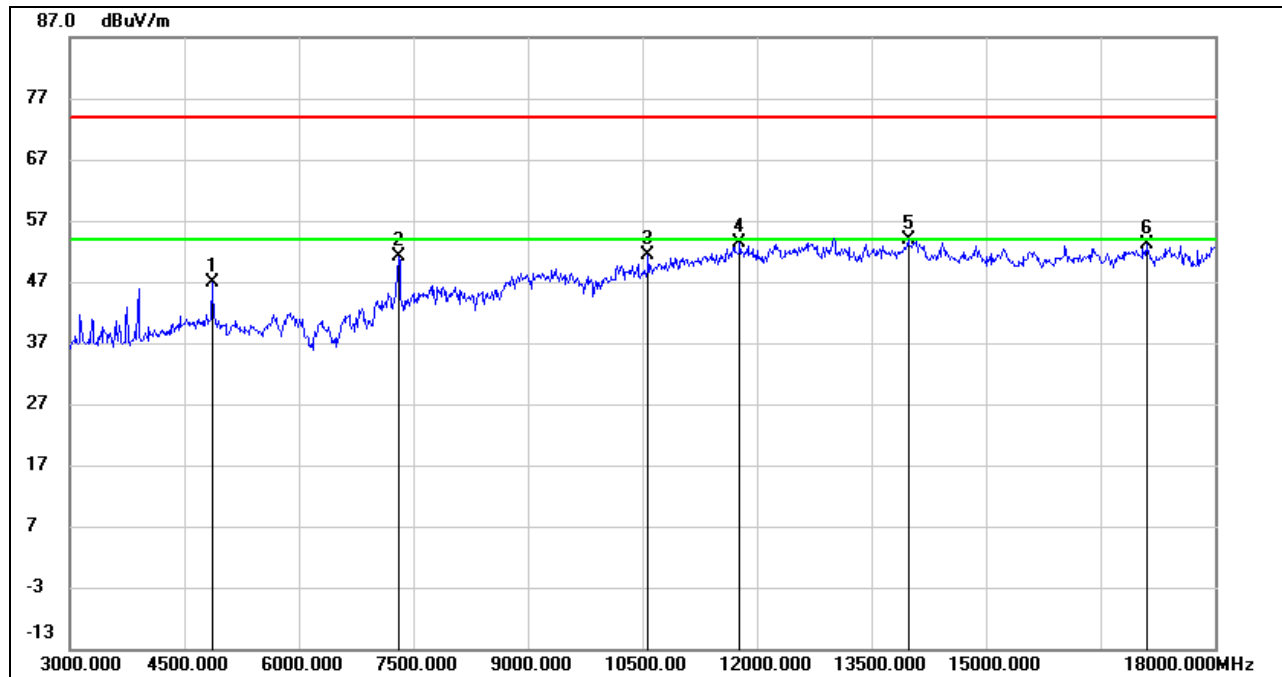
**HARMONICS AND SPURIOUS EMISSIONS (MID CHANNEL, HORIZONTAL)**

No.	Frequency (MHz)	Reading (dBuV)	Correct (dB/m)	Result (dBuV/m)	Limit (dBuV/m)	Margin (dB)	Remark
1	4860.000	45.65	1.13	46.78	74.00	-27.22	peak
2	7305.000	43.24	7.85	51.09	74.00	-22.91	peak
3	10575.000	36.53	14.75	51.28	74.00	-22.72	peak
4	11775.000	34.30	19.11	53.41	74.00	-20.59	peak
5	13980.000	29.65	24.14	53.79	74.00	-20.21	peak
6	17100.000	28.85	24.24	53.09	74.00	-20.91	peak

- Note: 1. Peak Result = Reading Level + Correct Factor.
 2. If Peak Result complies with AV limit, AV Result is deemed to comply with AV limit.
 3. Peak: Peak detector.
 4. Filter losses were only considered in the spurious frequency bands and the authorized band was not corrected for High Pass Filter losses.
 5. Proper operation of the transmitter prior to adding the filter to the measurement chain.

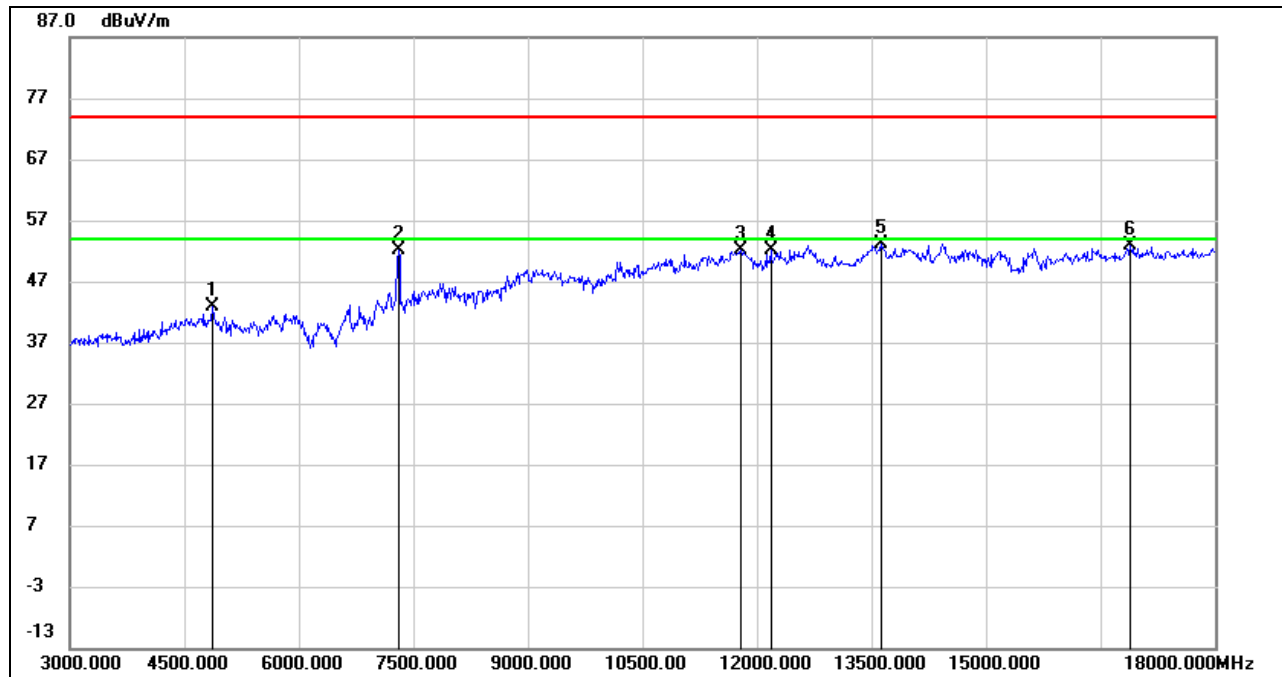
**HARMONICS AND SPURIOUS EMISSIONS (MID CHANNEL, VERTICAL)**

No.	Frequency (MHz)	Reading (dBuV)	Correct (dB/m)	Result (dBuV/m)	Limit (dBuV/m)	Margin (dB)	Remark
1	4875.000	41.65	1.20	42.85	74.00	-31.15	peak
2	7305.000	44.22	7.85	52.07	74.00	-21.93	peak
3	11790.000	32.85	19.16	52.01	74.00	-21.99	peak
4	12180.000	32.13	19.92	52.05	74.00	-21.95	peak
5	13620.000	30.00	23.17	53.17	74.00	-20.83	peak
6	16890.000	29.41	23.36	52.77	74.00	-21.23	peak

Note: 1. Peak Result = Reading Level + Correct Factor.

2. If Peak Result complies with AV limit, AV Result is deemed to comply with AV limit.

3. Peak: Peak detector.

4. Filter losses were only considered in the spurious frequency bands and the authorized band was not corrected for High Pass Filter losses.

5. Proper operation of the transmitter prior to adding the filter to the measurement chain.

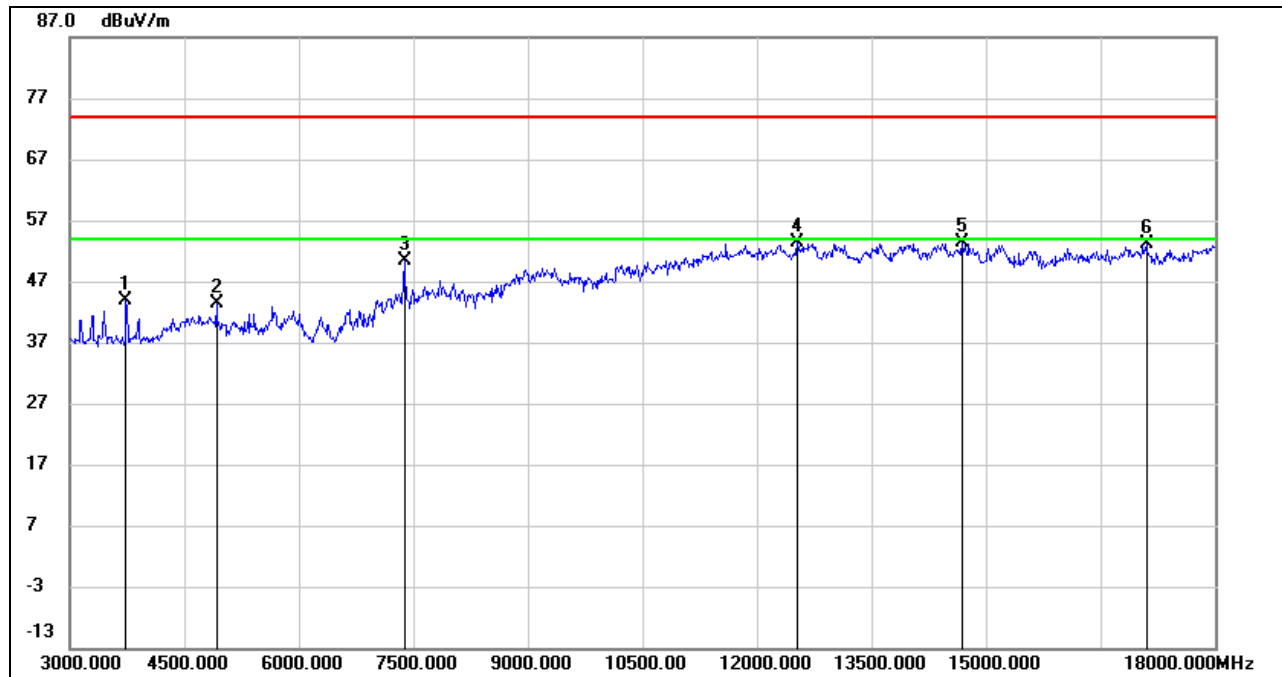
**HARMONICS AND SPURIOUS EMISSIONS (HIGH CHANNEL, HORIZONTAL)**

No.	Frequency (MHz)	Reading (dBuV)	Correct (dB/m)	Result (dBuV/m)	Limit (dBuV/m)	Margin (dB)	Remark
1	3735.000	47.29	-3.38	43.91	74.00	-30.09	peak
2	4920.000	42.10	1.36	43.46	74.00	-30.54	peak
3	7380.000	42.61	7.84	50.45	74.00	-23.55	peak
4	12525.000	33.48	19.98	53.46	74.00	-20.54	peak
5	14685.000	31.53	21.80	53.33	74.00	-20.67	peak
6	17100.000	28.97	24.24	53.21	74.00	-20.79	peak

Note: 1. Peak Result = Reading Level + Correct Factor.

2. If Peak Result complies with AV limit, AV Result is deemed to comply with AV limit.

3. Peak: Peak detector.

4. Filter losses were only considered in the spurious frequency bands and the authorized band was not corrected for High Pass Filter losses.

5. Proper operation of the transmitter prior to adding the filter to the measurement chain.

HARMONICS AND SPURIOUS EMISSIONS (HIGH CHANNEL, VERTICAL)

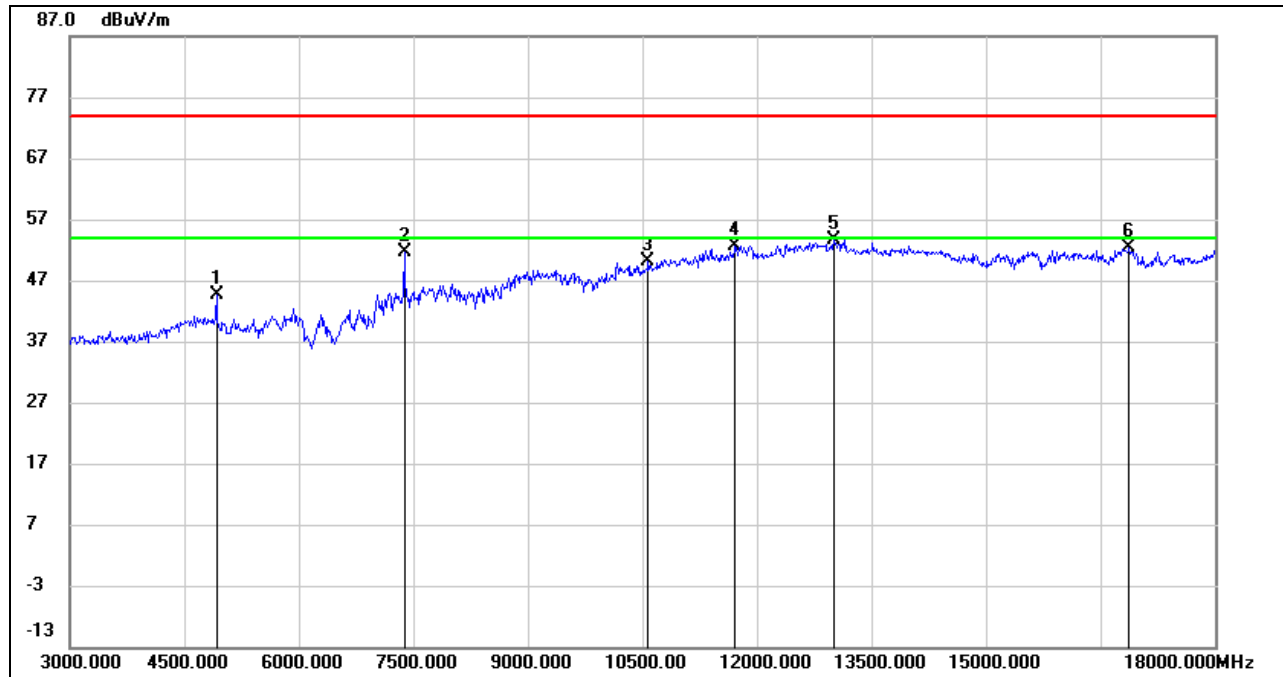

No.	Frequency (MHz)	Reading (dBuV)	Correct (dB/m)	Result (dBuV/m)	Limit (dBuV/m)	Margin (dB)	Remark
1	4920.000	43.17	1.36	44.53	74.00	-29.47	peak
2	7380.000	43.88	7.84	51.72	74.00	-22.28	peak
3	10575.000	35.29	14.75	50.04	74.00	-23.96	peak
4	11715.000	33.80	18.90	52.70	74.00	-21.30	peak
5	13005.000	32.89	20.77	53.66	74.00	-20.34	peak
6	16875.000	29.10	23.31	52.41	74.00	-21.59	peak

- Note:
1. Peak Result = Reading Level + Correct Factor.
 2. If Peak Result complies with AV limit, AV Result is deemed to comply with AV limit.
 3. Peak: Peak detector.
 4. Filter losses were only considered in the spurious frequency bands and the authorized band was not corrected for High Pass Filter losses.
 5. Proper operation of the transmitter prior to adding the filter to the measurement chain.

8.4. SPURIOUS EMISSIONS (18 GHz ~ 26 GHz)

8.4.1. 802.11b MODE

SPURIOUS EMISSIONS (MID CHANNEL, WORST-CASE CONFIGURATION, HORIZONTAL)

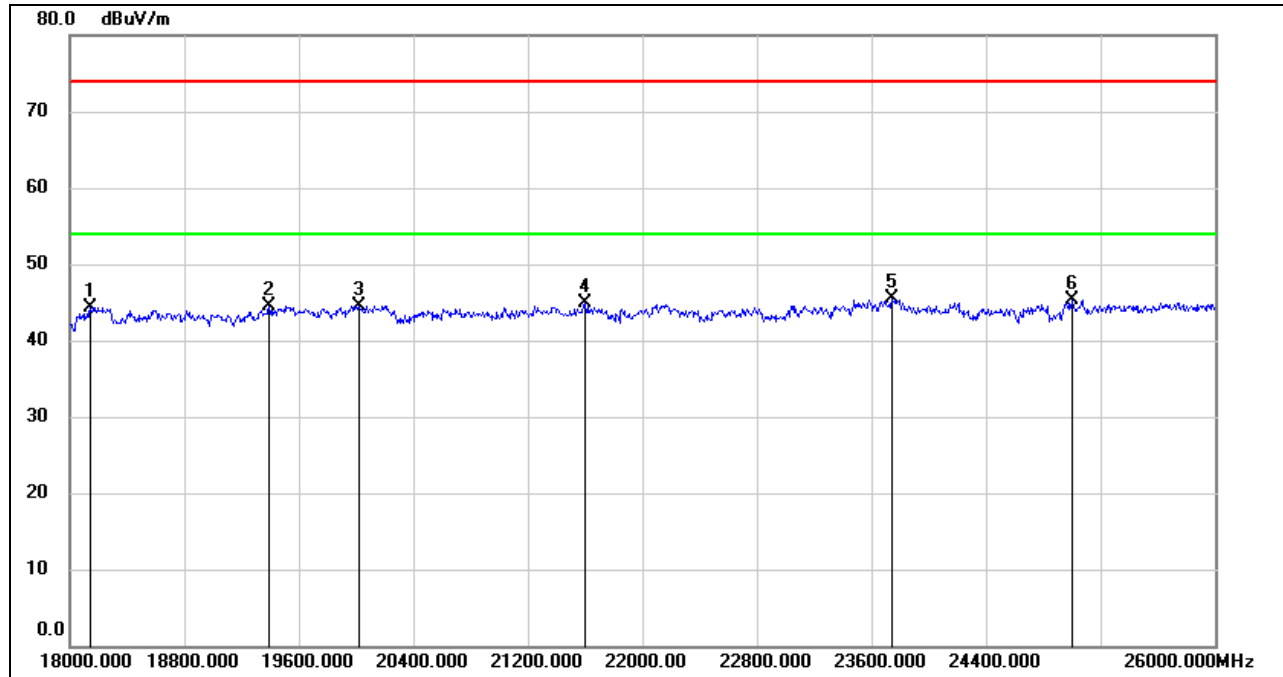

No.	Frequency (MHz)	Reading (dBuV)	Correct (dB/m)	Result (dBuV/m)	Limit (dBuV/m)	Margin (dB)	Remark
1	18144.000	49.77	-5.48	44.29	74.00	-29.71	peak
2	19392.000	50.12	-5.57	44.55	74.00	-29.45	peak
3	20016.000	50.06	-5.47	44.59	74.00	-29.41	peak
4	21600.000	49.52	-4.54	44.98	74.00	-29.02	peak
5	23744.000	48.65	-3.20	45.45	74.00	-28.55	peak
6	25000.000	47.36	-2.10	45.26	74.00	-28.74	peak

Note: 1. Measurement = Reading Level + Correct Factor.
 2. If Peak Result complies with AV limit, AV Result is deemed to comply with AV limit.
 3. Peak: Peak detector.



SPURIOUS EMISSIONS (MID CHANNEL, WORST-CASE CONFIGURATION, VERTICAL)

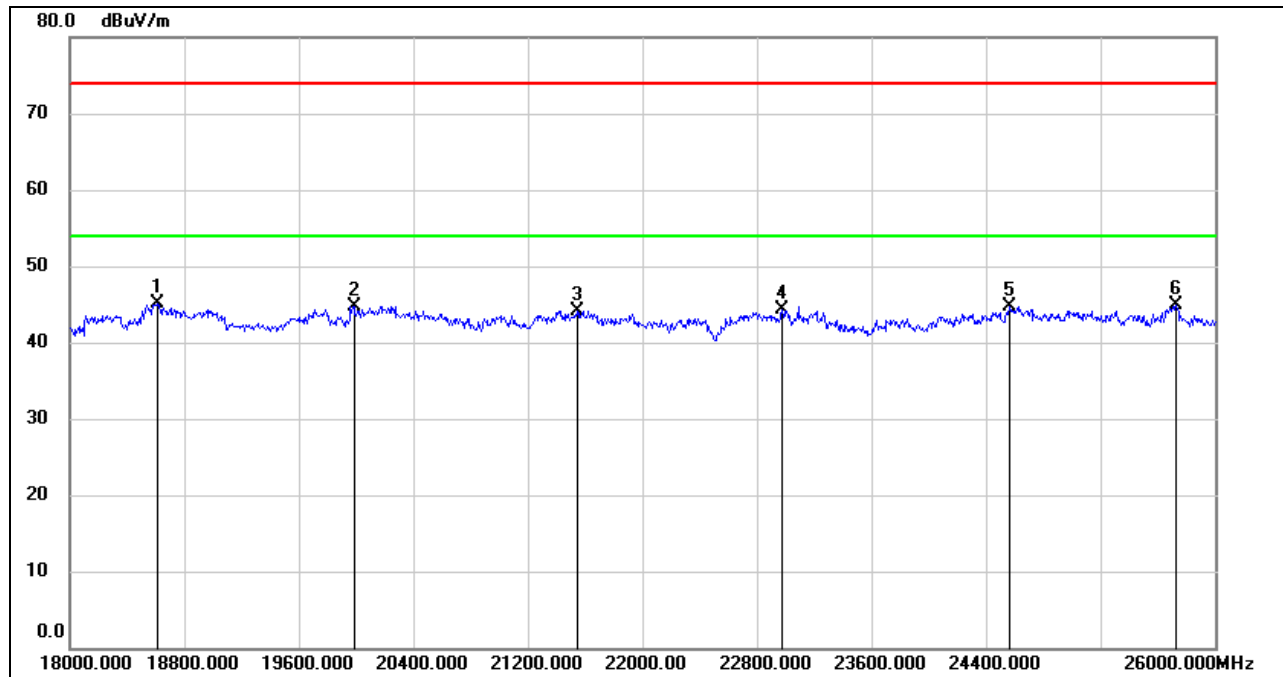

No.	Frequency (MHz)	Reading (dBuV)	Correct (dB/m)	Result (dBuV/m)	Limit (dBuV/m)	Margin (dB)	Remark
1	18616.000	50.39	-5.34	45.05	74.00	-28.95	peak
2	19984.000	50.21	-5.44	44.77	74.00	-29.23	peak
3	21544.000	48.76	-4.63	44.13	74.00	-29.87	peak
4	22976.000	47.76	-3.46	44.30	74.00	-29.70	peak
5	24568.000	47.10	-2.33	44.77	74.00	-29.23	peak
6	25728.000	45.61	-0.72	44.89	74.00	-29.11	peak

Note: 1. Measurement = Reading Level + Correct Factor.
 2. If Peak Result complies with AV limit, AV Result is deemed to comply with AV limit.
 3. Peak: Peak detector.

Note: All the modes had been tested, but only the worst data was recorded in the report.



8.5. SPURIOUS EMISSIONS (30 MHz ~ 1 GHz)

8.5.1. 802.11b MODE

SPURIOUS EMISSIONS (MID CHANNEL, WORST-CASE CONFIGURATION, HORIZONTAL)

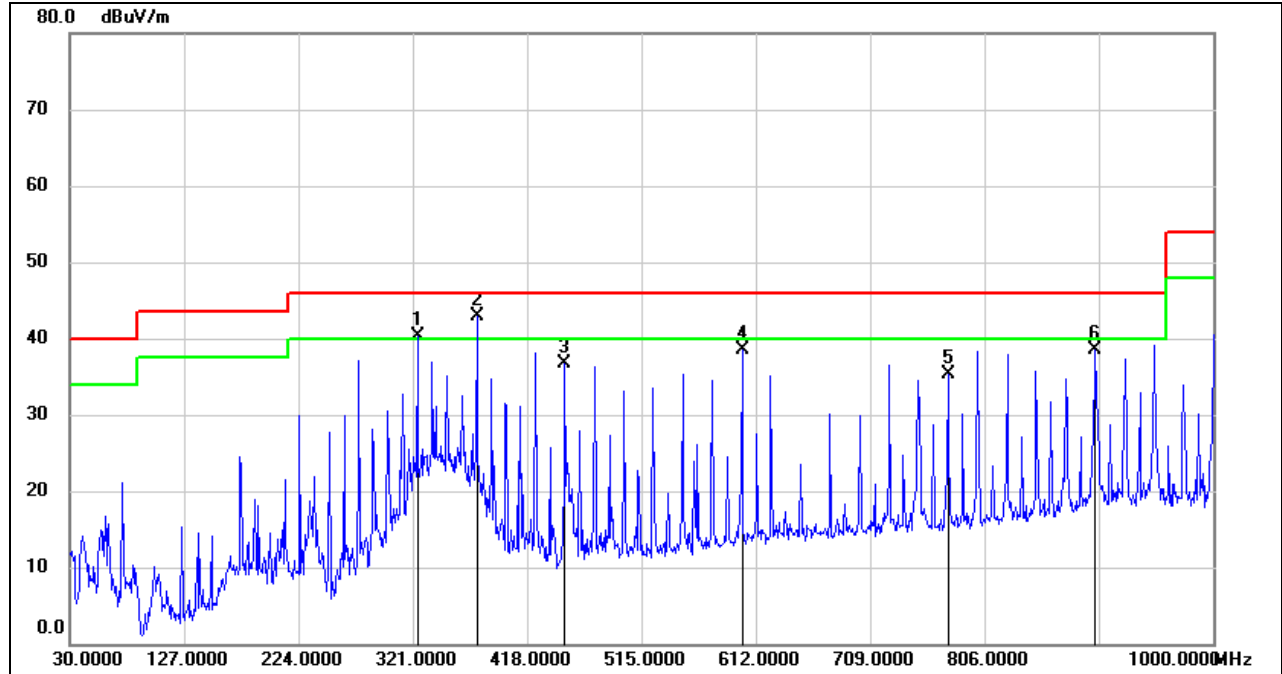

No.	Frequency (MHz)	Reading (dBuV)	Correct (dB/m)	Result (dBuV/m)	Limit (dBuV/m)	Margin (dB)	Remark
1	324.8800	54.98	-14.73	40.25	46.00	-5.75	QP
2	375.3200	56.68	-13.79	42.89	46.00	-3.11	QP
3	450.0100	49.27	-12.49	36.78	46.00	-9.22	QP
4	600.3600	48.07	-9.54	38.53	46.00	-7.47	QP
5	774.9600	42.99	-7.60	35.39	46.00	-10.61	QP
6	900.0900	43.66	-5.21	38.45	46.00	-7.55	QP

- Note: 1. Result Level = Read Level + Correct Factor.
 2. If Peak Result complies with QP limit, QP Result is deemed to comply with QP limit.
 3. Test setup: RBW: 120 kHz, VBW: 300 kHz, Sweep time: auto.

SPURIOUS EMISSIONS (MID CHANNEL, WORST-CASE CONFIGURATION, VERTICAL)

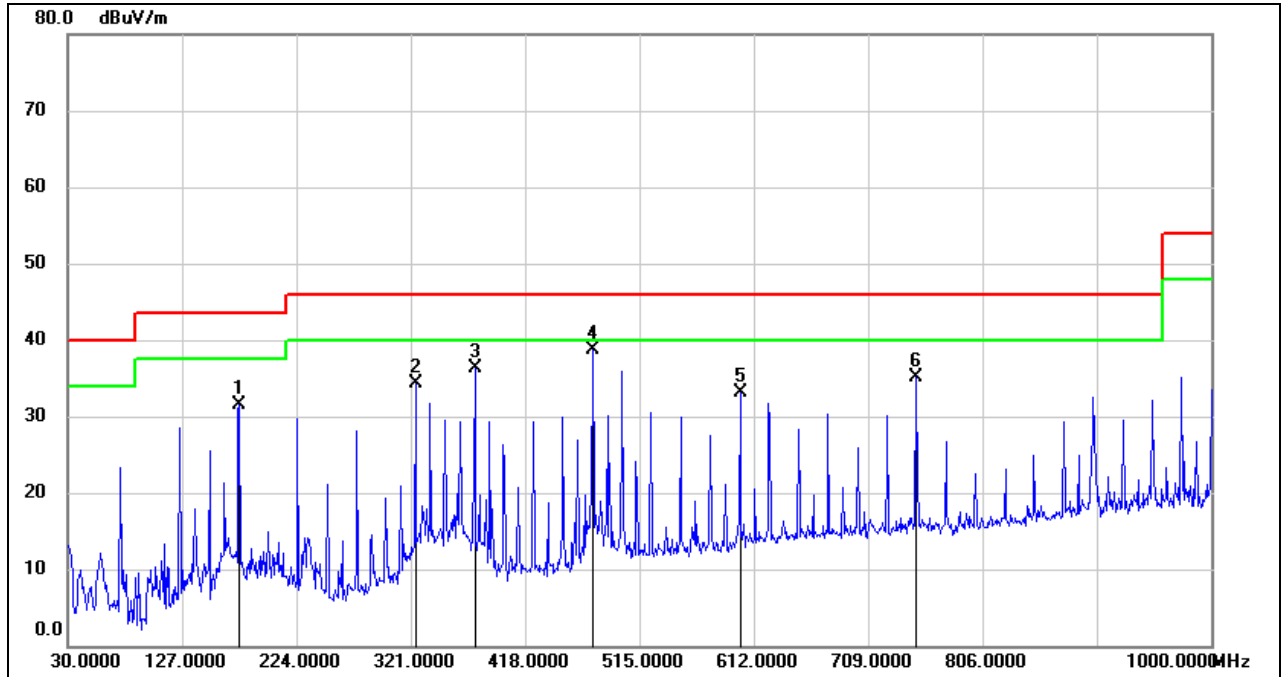

No.	Frequency (MHz)	Reading (dBuV)	Correct (dB/m)	Result (dBuV/m)	Limit (dBuV/m)	Margin (dB)	Remark
1	175.5000	48.50	-17.07	31.43	43.50	-12.07	QP
2	324.8800	49.01	-14.73	34.28	46.00	-11.72	QP
3	375.3200	50.04	-13.79	36.25	46.00	-9.75	QP
4	475.2300	50.57	-11.90	38.67	46.00	-7.33	QP
5	600.3600	42.61	-9.54	33.07	46.00	-12.93	QP
6	749.7400	43.01	-7.94	35.07	46.00	-10.93	QP

- Note: 1. Result Level = Read Level + Correct Factor.
 2. If Peak Result complies with QP limit, QP Result is deemed to comply with QP limit.
 3. Test setup: RBW: 120 kHz, VBW: 300 kHz, Sweep time: auto

Note: All the modes had been tested, but only the worst data was recorded in the report.

8.6. SPURIOUS EMISSIONS BELOW 30 MHz

8.6.1. 802.11b MODE

SPURIOUS EMISSIONS (MID CHANNEL, LOOP ANTENNA FACE ON TO THE EUT, WORST-CASE CONFIGURATION)

9 kHz ~ 150 kHz

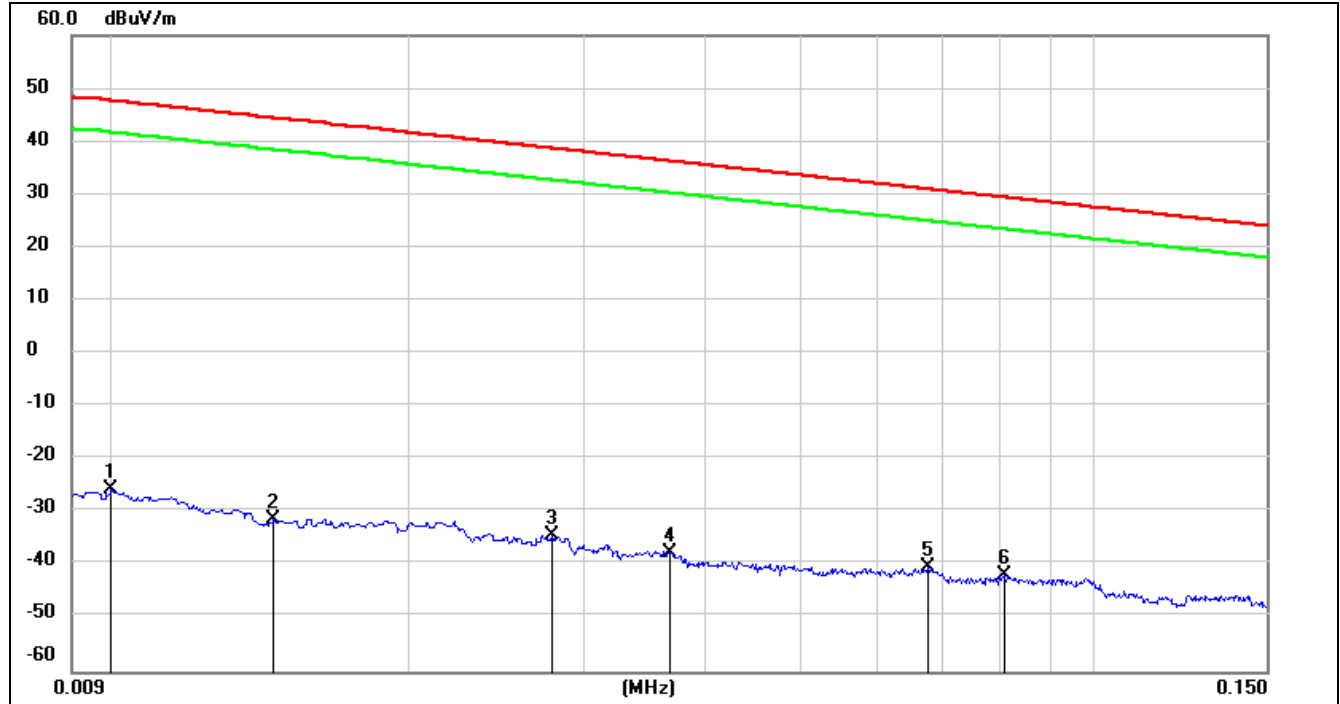

No.	Frequency (MHz)	Reading (dBuV)	Correct (dB/m)	FCC Result (dBuV/m)	FCC Limit (dBuV/m)	ISED Result (dBuA/m)	ISED Limit (dBuA/m)	Margin (dB)	Remark
1	0.0100	75.72	-101.40	-25.68	47.6	-77.18	-3.90	-73.28	peak
2	0.0145	70.05	-101.38	-31.33	44.37	-82.83	-7.13	-75.70	peak
3	0.0279	67.17	-101.38	-34.21	38.69	-85.71	-12.81	-72.90	peak
4	0.0367	63.75	-101.42	-37.67	36.31	-89.17	-15.19	-73.98	peak
5	0.0675	61.14	-101.56	-40.42	31.02	-91.92	-20.48	-71.44	peak
6	0.0806	59.68	-101.63	-41.95	29.47	-93.45	-22.03	-71.42	peak

Note: 1. Measurement = Reading Level + Correct Factor (dBuA/m= dBuV/m- 20Log10[120π] = dBuV/m- 51.5).

2. If Peak Result complies with AV and QP limit, AV and QP Result are deemed to comply with AV limit.

3. All 3 polarizations (Horizontal, Face-on and Face-off) of the loop antenna had been tested, but only the worst data recorded in the report.

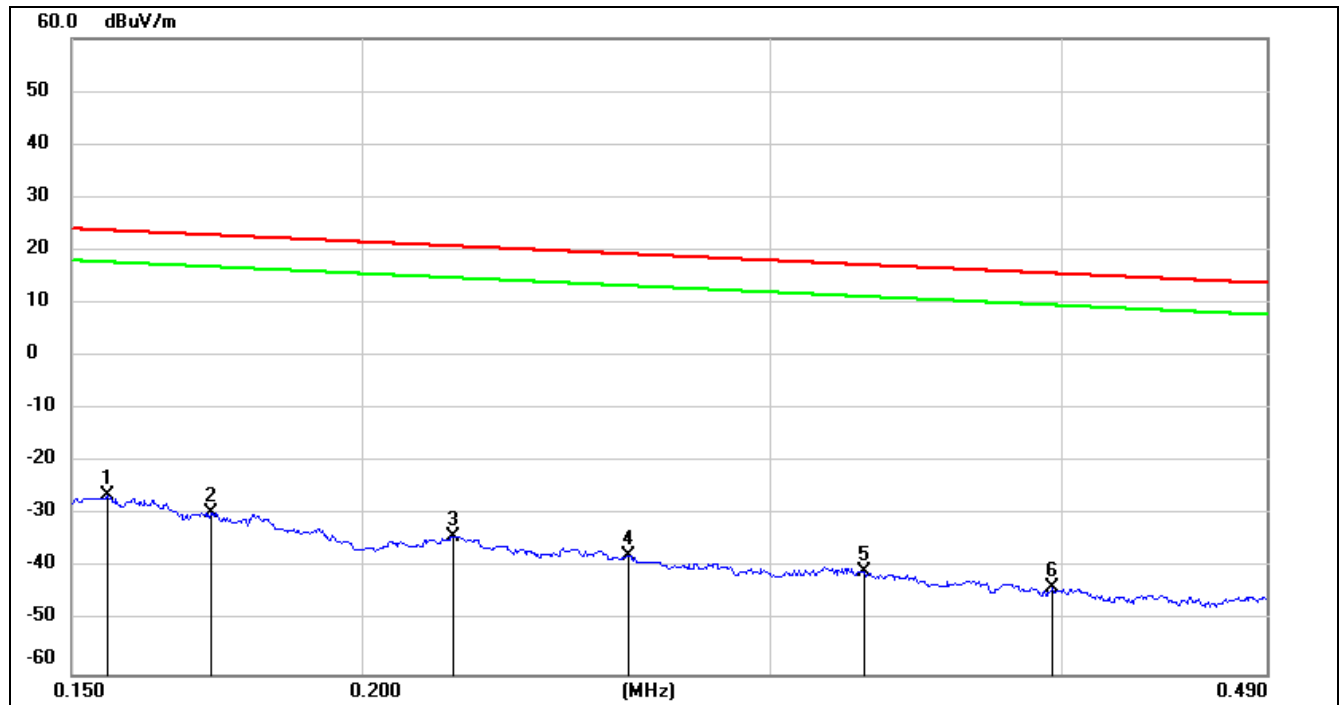
**150 kHz ~ 490 kHz**

No.	Frequency (MHz)	Reading (dBuV)	Correct (dB/m)	FCC Result (dBuV/m)	FCC Limit (dBuV/m)	ISED Result (dBuA/m)	ISED Limit (dBuA/m)	Margin (dB)	Remark
1	0.1554	75.27	-101.65	-26.38	23.77	-77.88	-27.73	-50.15	peak
2	0.1720	72.19	-101.67	-29.48	22.9	-80.98	-28.60	-52.38	peak
3	0.2190	67.77	-101.75	-33.98	20.79	-85.48	-30.71	-54.77	peak
4	0.2605	64.10	-101.81	-37.71	19.28	-89.21	-32.22	-56.99	peak
5	0.3286	61.21	-101.88	-40.67	17.27	-92.17	-34.23	-57.94	peak
6	0.3966	58.18	-101.96	-43.78	15.63	-95.28	-35.87	-59.41	peak

Note: 1. Measurement = Reading Level + Correct Factor (dBuA/m= dBuV/m- 20Log10[120π] = dBuV/m- 51.5).

2. If Peak Result complies with AV and QP limit, AV and QP Result are deemed to comply with AV limit.

3. All 3 polarizations (Horizontal, Face-on and Face-off) of the loop antenna had been tested, but only the worst data recorded in the report.

490 kHz ~ 30 MHz

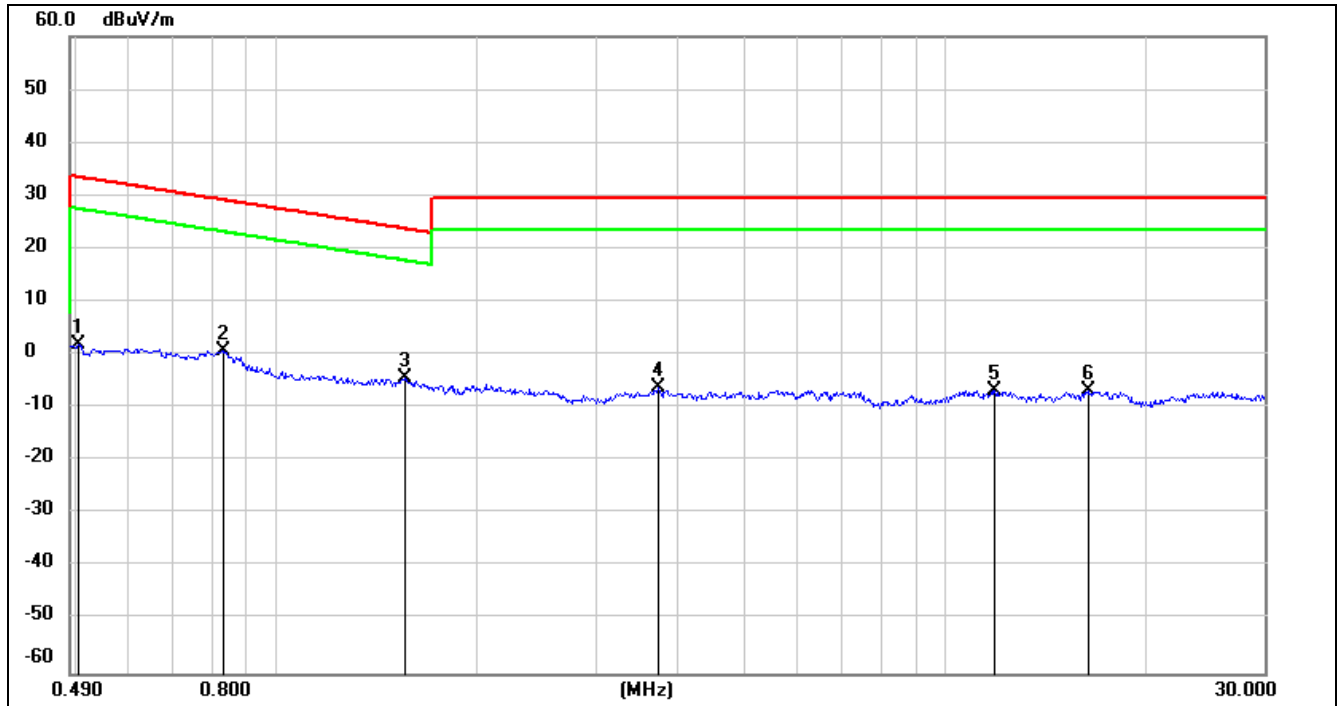

No.	Frequency (MHz)	Reading (dBuV)	Correct (dB/m)	FCC Result (dBuV/m)	FCC Limit (dBuV/m)	ISED Result (dBuA/m)	ISED Limit (dBuA/m)	Margin (dB)	Remark
1	0.5039	63.93	-62.07	1.86	33.56	-49.64	-17.94	-31.70	peak
2	0.8296	62.94	-62.17	0.77	29.23	-50.73	-22.27	-28.46	peak
3	1.5564	57.68	-62.02	-4.34	23.76	-55.84	-27.74	-28.10	peak
4	3.7100	55.20	-61.41	-6.21	29.54	-57.71	-21.96	-35.75	peak
5	11.8513	54.06	-60.88	-6.82	29.54	-58.32	-21.96	-36.36	peak
6	16.3959	54.17	-60.96	-6.79	29.54	-58.29	-21.96	-36.33	peak

Note: 1. Measurement = Reading Level + Correct Factor (dBuA/m= dBuV/m- 20Log10[120π] = dBuV/m- 51.5).

2. If Peak Result complies with AV and QP limit, AV and QP Result are deemed to comply with AV limit.

3. All 3 polarizations (Horizontal, Face-on and Face-off) of the loop antenna had been tested, but only the worst data recorded in the report.

Note: All the modes had been tested, but only the worst data was recorded in the report.

9. AC POWER LINE CONDUCTED EMISSIONS

LIMITS

Please refer to CFR 47 FCC §15.207 (a).

FREQUENCY (MHz)	Quasi-peak	Average
0.15 -0.5	66 - 56 *	56 - 46 *
0.50 -5.0	56.00	46.00
5.0 -30.0	60.00	50.00

TEST SETUP AND PROCEDURE

Refer to ANSI C63.10-2013 clause 6.2.

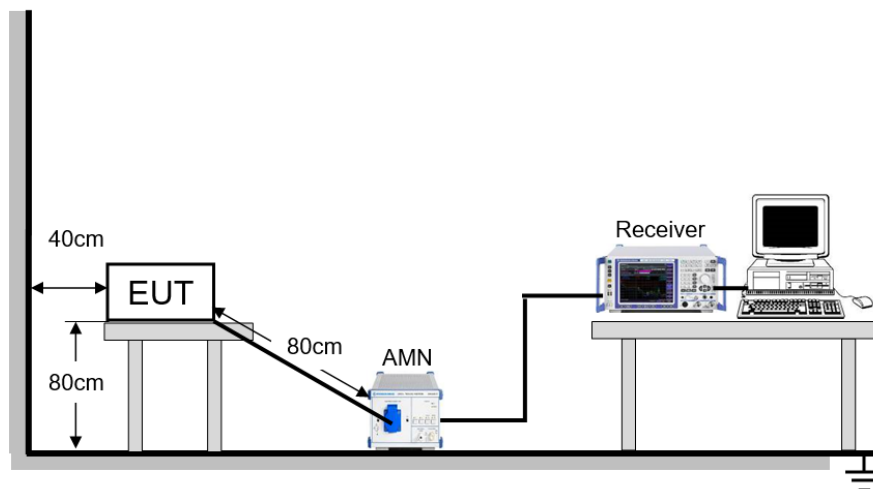

The EUT is put on a table of non-conducting material that is 80 cm high. The vertical conducting wall of shielding is located 40 cm to the rear of the EUT. The power line of the EUT is connected to the AC mains through a Artificial Mains Network (A.M.N.). A EMI Measurement Receiver (R&S Test Receiver ESR3) is used to test the emissions from both sides of AC line. According to the requirements in Section 6.2 of ANSI C63.10-2013. Conducted emissions from the EUT measured in the frequency range between 0.15 MHz and 30 MHz using CISPR Quasi-Peak and average detector mode. The bandwidth of EMI test receiver is set at 9 kHz.

The arrangement of the equipment is installed to meet the standards and operating in a manner, which tends to maximize its emission characteristics in a normal application.

TEST ENVIRONMENT

Temperature	24.7 °C	Relative Humidity	63.7 %
Atmosphere Pressure	101 kPa	Test Voltage	AC 120 V/60 Hz

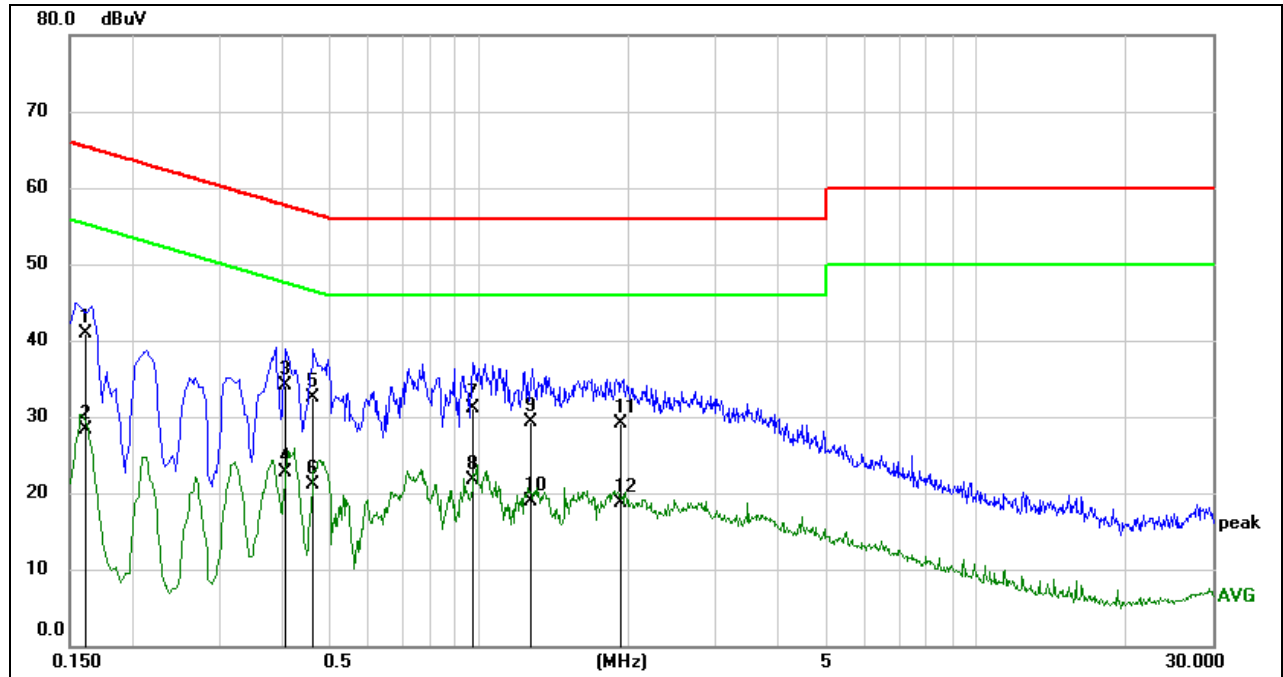
RESULTS
9.1. 802.11b MODE
LINE L RESULTS (MID CHANNEL, WORST-CASE CONFIGURATION)

No.	Frequency (MHz)	Reading (dBuV)	Correct (dB)	Result (dBuV)	Limit (dBuV)	Margin (dB)	Remark
1	0.1620	31.41	9.51	40.92	65.36	-24.44	QP
2	0.1620	18.71	9.51	28.22	55.36	-27.14	AVG
3	0.4092	24.65	9.53	34.18	57.66	-23.48	QP
4	0.4092	13.19	9.53	22.72	47.66	-24.94	AVG
5	0.4638	22.90	9.51	32.41	56.62	-24.21	QP
6	0.4638	11.68	9.51	21.19	46.62	-25.43	AVG
7	0.9800	21.69	9.51	31.20	56.00	-24.80	QP
8	0.9800	12.21	9.51	21.72	46.00	-24.28	AVG
9	1.2737	19.86	9.54	29.40	56.00	-26.60	QP
10	1.2737	9.42	9.54	18.96	46.00	-27.04	AVG
11	1.9270	19.39	9.62	29.01	56.00	-26.99	QP
12	1.9270	9.04	9.62	18.66	46.00	-27.34	AVG

Note: 1. Result = Reading +Correct Factor.

2. If QP Result complies with AV limit, AV Result is deemed to comply with AV limit.

3. Test setup: RBW: 200 Hz (9 kHz ~ 150 kHz), 9 kHz (150 kHz ~ 30 MHz).

4. Step size: 80 Hz (0.009 MHz ~ 0.15 MHz), 4 kHz (0.15 MHz ~ 30 MHz), Scan time: auto.

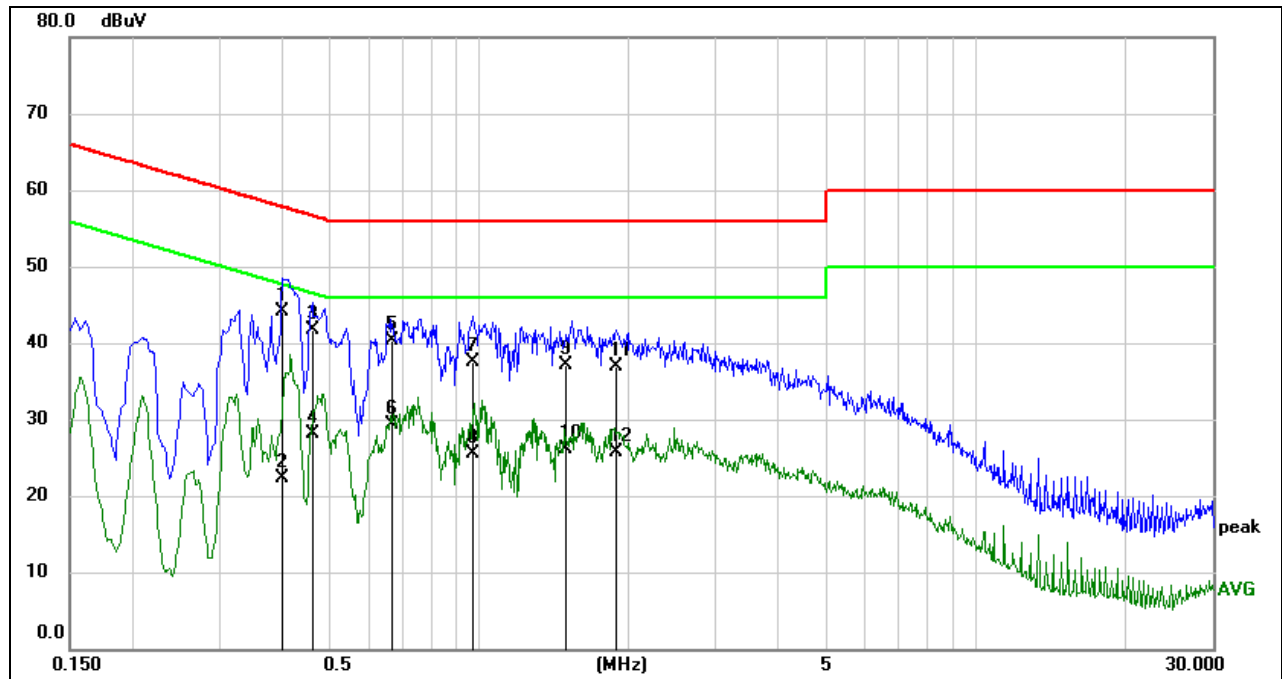
LINE N RESULTS (MID CHANNEL, WORST-CASE CONFIGURATION)

No.	Frequency (MHz)	Reading (dBuV)	Correct (dB)	Result (dBuV)	Limit (dBuV)	Margin (dB)	Remark
1	0.4059	34.65	9.53	44.18	57.73	-13.55	QP
2	0.4059	12.68	9.53	22.21	47.73	-25.52	AVG
3	0.4653	32.13	9.51	41.64	56.60	-14.96	QP
4	0.4653	18.69	9.51	28.20	46.60	-18.40	AVG
5	0.6703	30.81	9.50	40.31	56.00	-15.69	QP
6	0.6703	19.85	9.50	29.35	46.00	-16.65	AVG
7	0.9779	28.03	9.51	37.54	56.00	-18.46	QP
8	0.9779	15.92	9.51	25.43	46.00	-20.57	AVG
9	1.5017	27.45	9.57	37.02	56.00	-18.98	QP
10	1.5017	16.55	9.57	26.12	46.00	-19.88	AVG
11	1.9006	27.26	9.61	36.87	56.00	-19.13	QP
12	1.9006	16.03	9.61	25.64	46.00	-20.36	AVG

Note: 1. Result = Reading +Correct Factor.

2. If QP Result complies with AV limit, AV Result is deemed to comply with AV limit.

3. Test setup: RBW: 200 Hz (9 kHz ~ 150 kHz), 9 kHz (150 kHz ~ 30 MHz).

4. Step size: 80 Hz (0.009 MHz ~ 0.15 MHz), 4 kHz (0.15 MHz ~ 30 MHz), Scan time: auto.

Note: All the modes had been tested, but only the worst data was recorded in the report.



10. ANTENNA REQUIREMENTS

APPLICABLE REQUIREMENTS

Please refer to FCC §15.203

An intentional radiator shall be designed to ensure that no antenna other than that furnished by the responsible party shall be used with the device. The use of a permanently attached antenna or of an antenna that uses a unique coupling to the intentional radiator shall be considered sufficient to comply with the provisions of this section. The manufacturer may design the unit so that a broken antenna can be replaced by the user, but the use of a standard antenna jack or electrical connector is prohibited.

Please refer to FCC §15.247(b)(4)

The conducted output power limit specified in paragraph (b) of this section is based on the use of antennas with directional gains that do not exceed 6 dBi. Except as shown in paragraph (c) of this section, if transmitting antennas of directional gain greater than 6 dBi are used, the conducted output power from the intentional radiator shall be reduced below the stated values in paragraphs (b)(1), (b)(2), and (b)(3) of this section, as appropriate, by the amount in dB that the directional gain of the antenna exceeds 6 dBi.

RESULTS

Complies



11. Appendix

11.1. Appendix A: DTS Bandwidth

11.1.1. Test Result

Test Mode	Antenna	Channel	DTS BW [MHz]	FL[MHz]	FH[MHz]	Limit[MHz]	Verdict
11B	Ant1	2412	7.08	2408.44	2415.52	0.5	PASS
		2437	7.08	2433.44	2440.52	0.5	PASS
		2462	7.08	2458.44	2465.52	0.5	PASS
11G	Ant1	2412	16.28	2403.84	2420.12	0.5	PASS
		2437	16.28	2428.84	2445.12	0.5	PASS
		2462	15.80	2454.08	2469.88	0.5	PASS
11N20SISO	Ant1	2412	16.88	2403.60	2420.48	0.5	PASS
		2437	17.08	2428.44	2445.52	0.5	PASS
		2462	15.72	2453.84	2469.56	0.5	PASS

11.1.2. Test Graphs

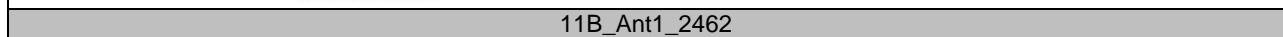
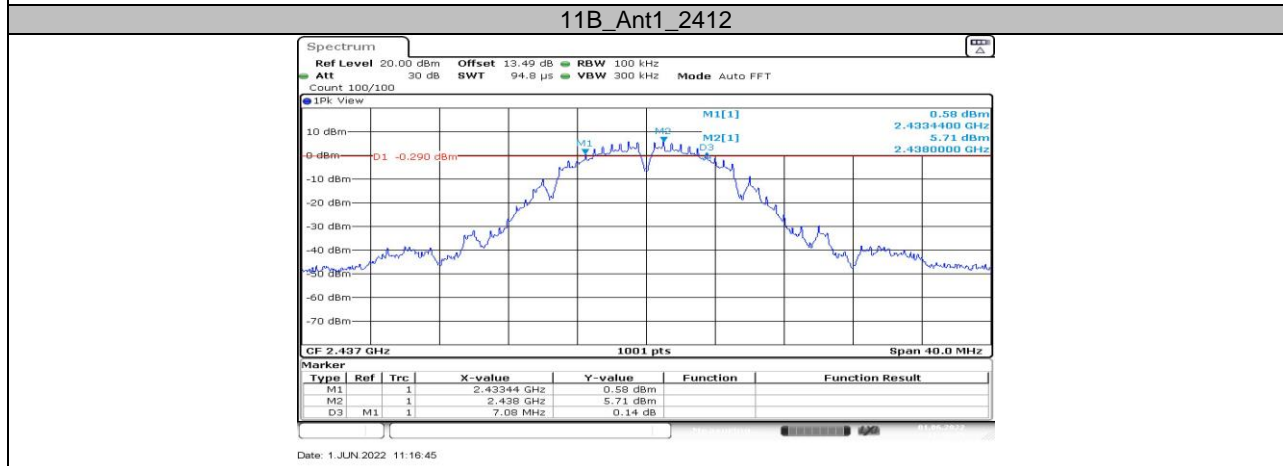
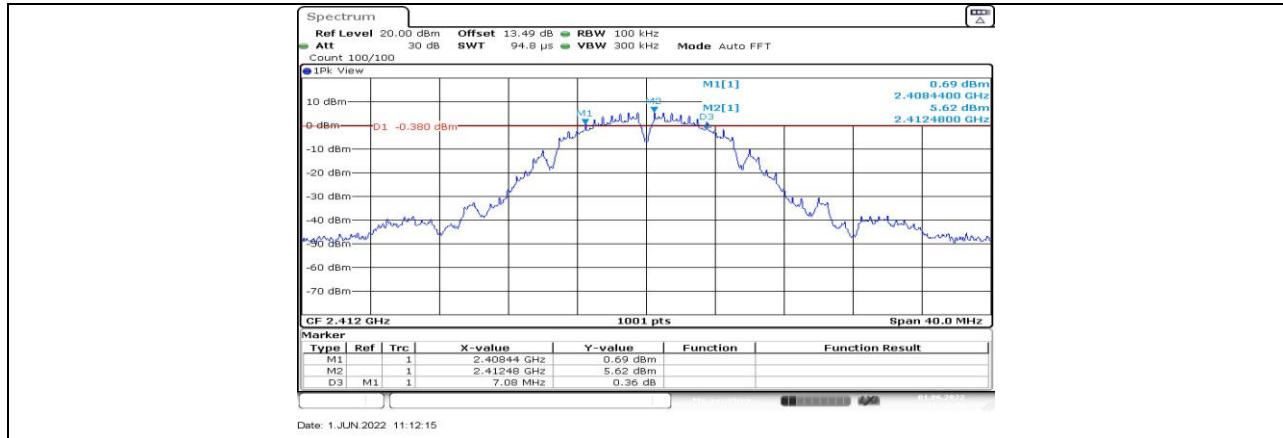

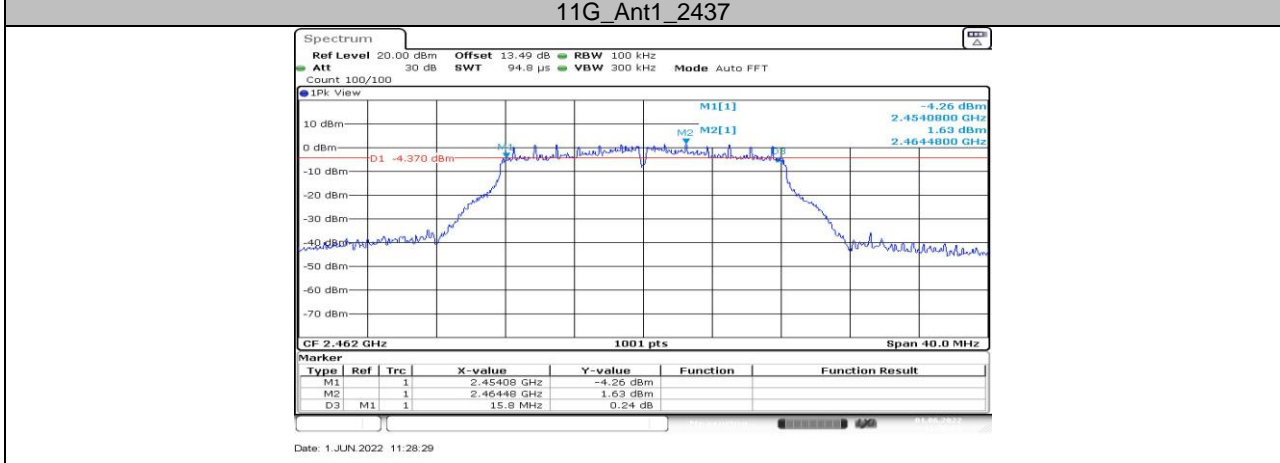
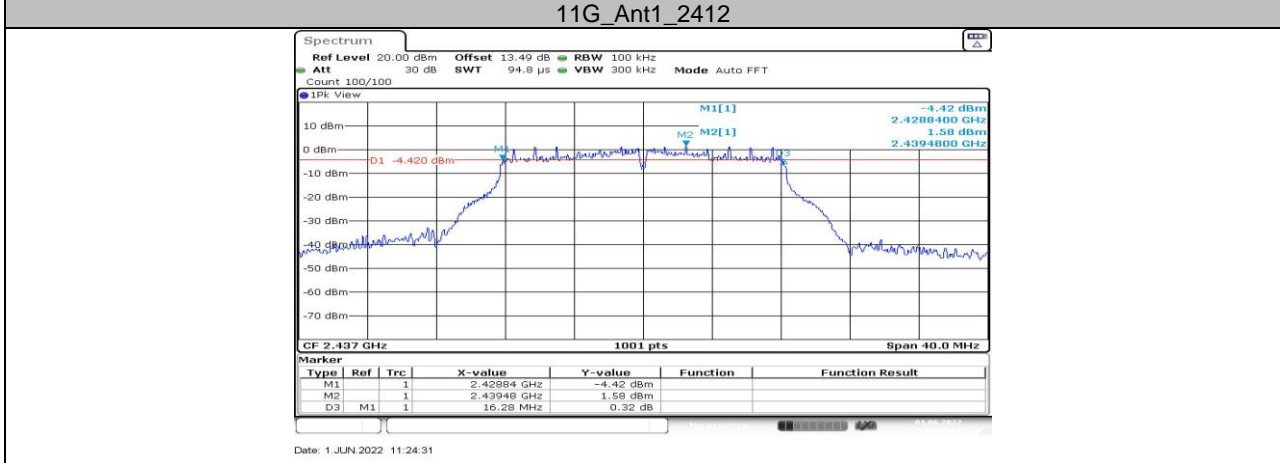
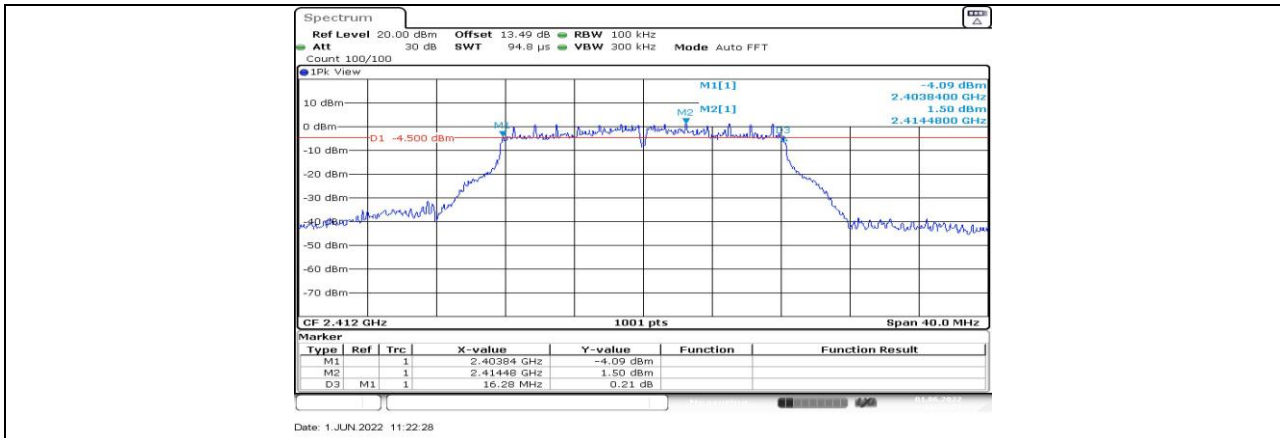

11G_Ant1_2462

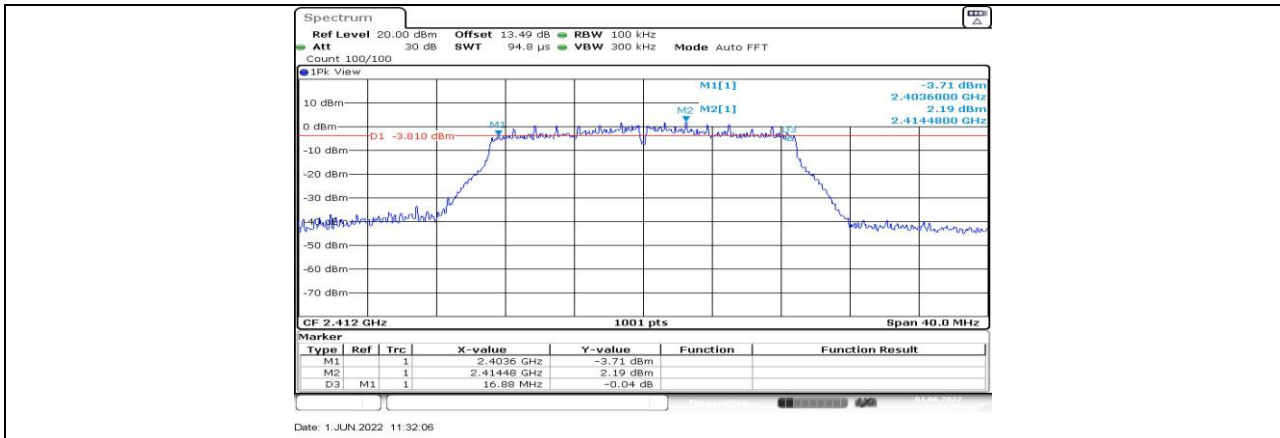

11N20SISO_Ant1_2412

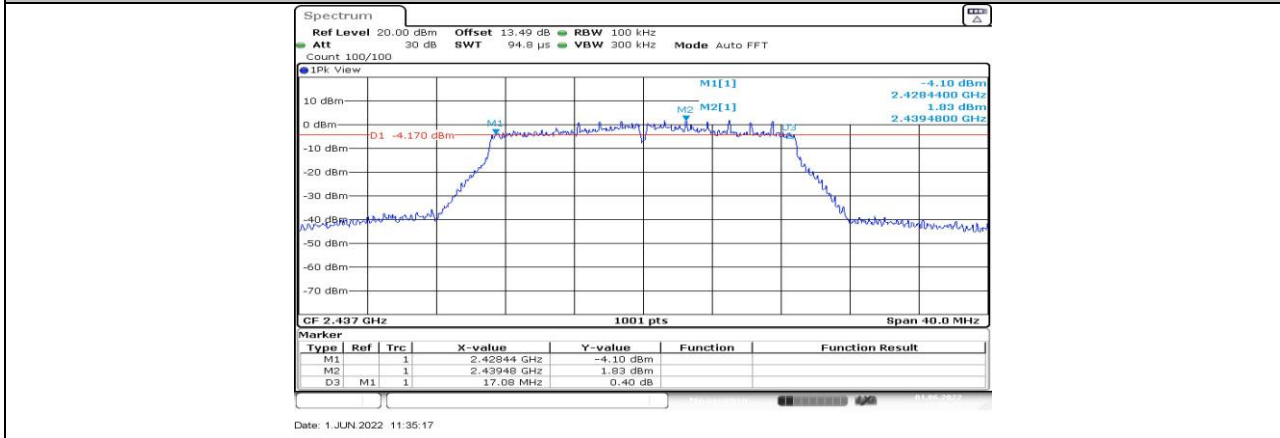

11N20SISO_Ant1_2437

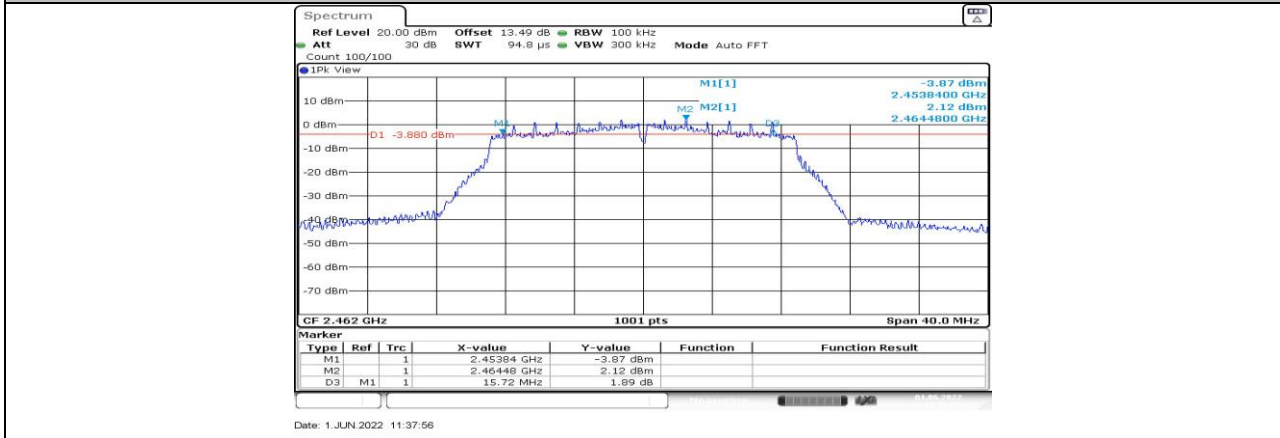

11N20SISO_Ant1_2462



11.2. Appendix B: Occupied Channel Bandwidth

11.2.1. Test Result

Test Mode	Antenna	Channel	OCB [MHz]	FL[MHz]	FH[MHz]	Verdict
11B	Ant1	2412	11.588	2406.206	2417.794	PASS
		2437	11.309	2431.406	2442.714	PASS
		2462	11.668	2456.166	2467.834	PASS
11G	Ant1	2412	17.742	2403.089	2420.831	PASS
		2437	17.702	2428.129	2445.831	PASS
		2462	17.502	2453.209	2470.711	PASS
11N20SISO	Ant1	2412	18.661	2402.729	2421.391	PASS
		2437	18.581	2427.729	2446.311	PASS
		2462	18.541	2452.729	2471.271	PASS

11.2.2. Test Graphs

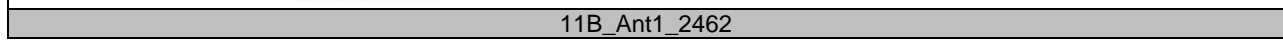
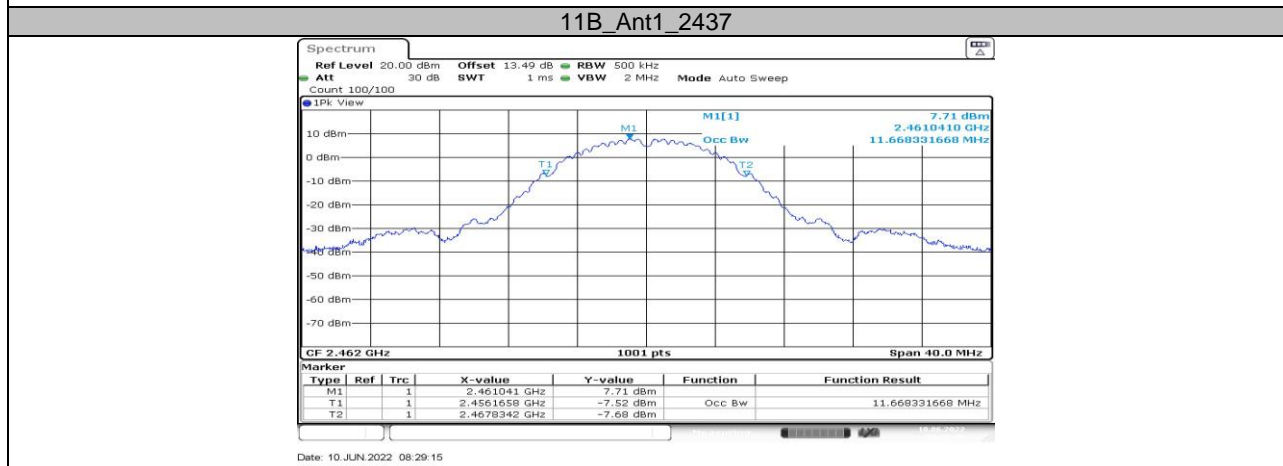
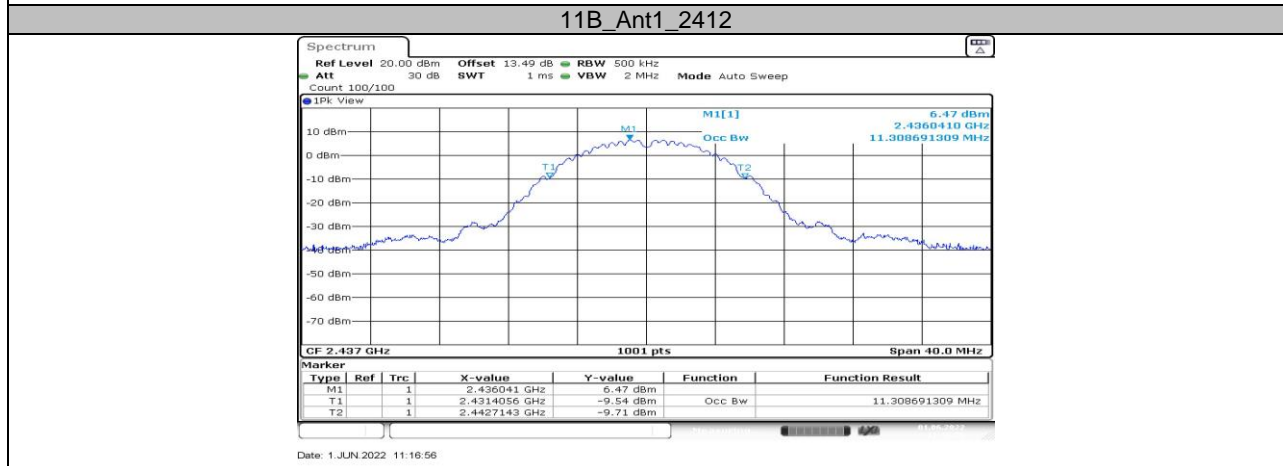
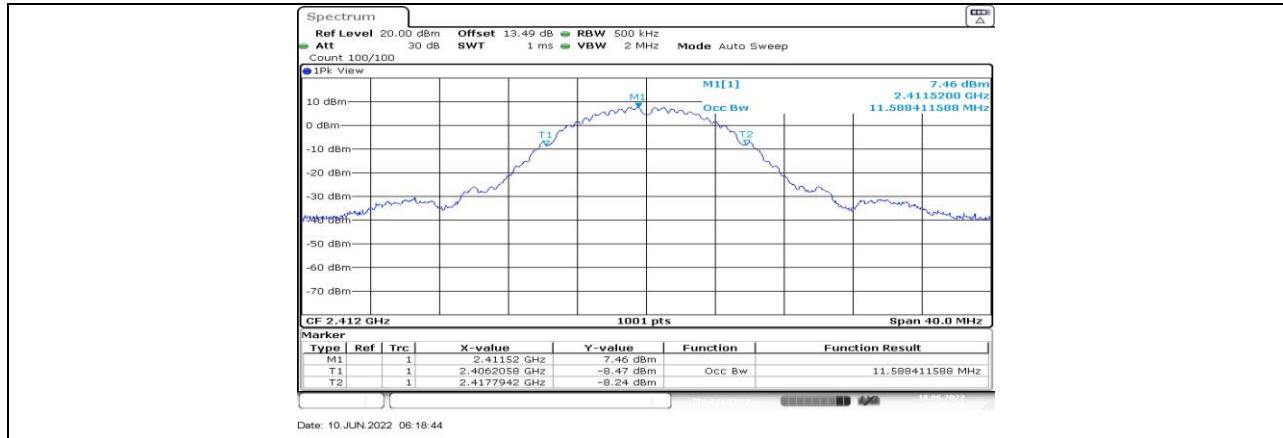

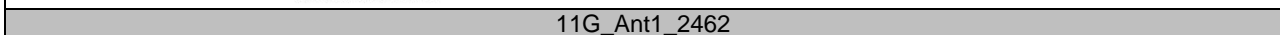
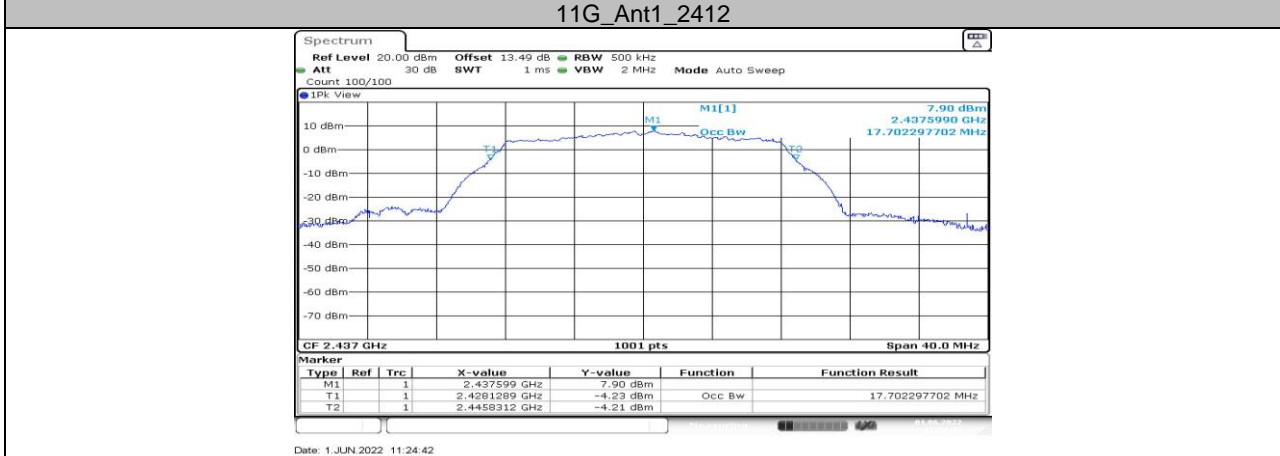
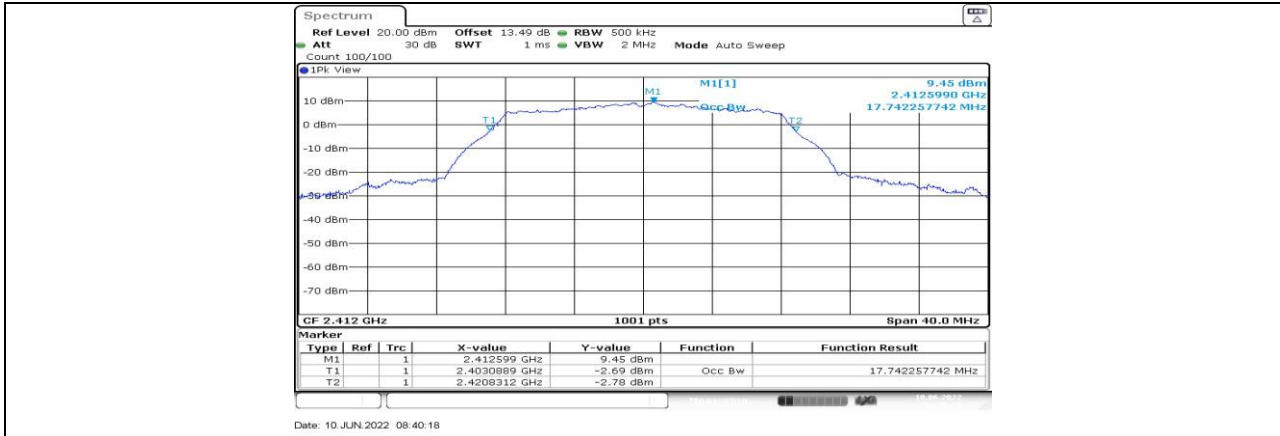

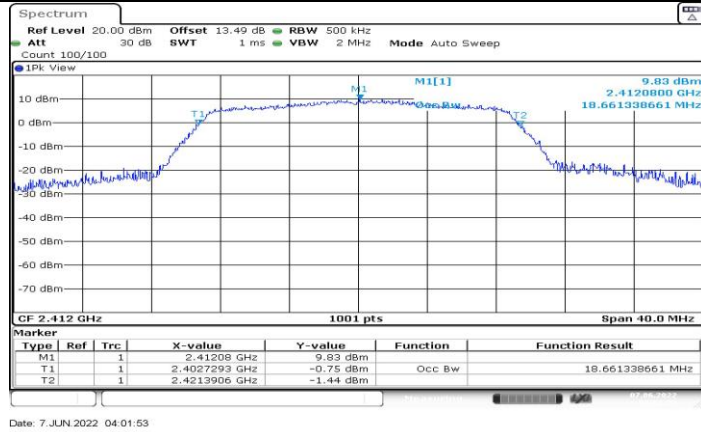

11N20SISO_Ant1_2412

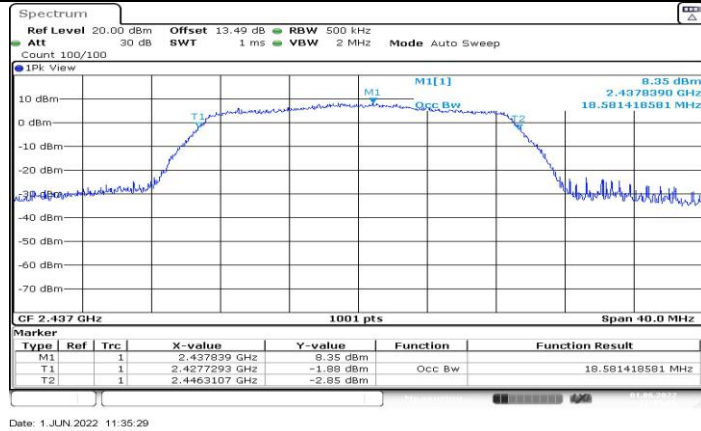

11N20SISO_Ant1_2437

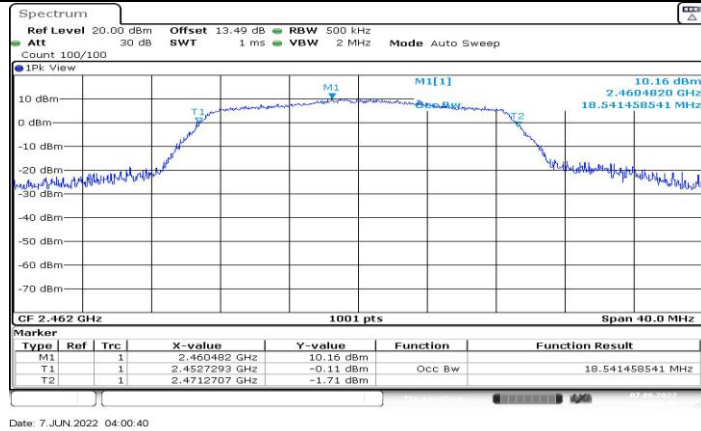

11N20SISO_Ant1_2462



11.3. Appendix C: Maximum conducted Average output power

11.3.1. Test Result

Test Mode	Antenna	Channel	Result[dBm]	Limit[dBm]	Verdict
11B	Ant1	2412	14.71	≤30.00	PASS
		2437	14.74	≤30.00	PASS
		2462	14.71	≤30.00	PASS
11G	Ant1	2412	14.45	≤30.00	PASS
		2437	14.45	≤30.00	PASS
		2462	14.46	≤30.00	PASS
11N20SISO	Ant1	2412	14.28	≤30.00	PASS
		2437	14.39	≤30.00	PASS
		2462	14.44	≤30.00	PASS

- Note: 1. Conducted Power=Meas. Level+ Correction Factor
2. The Duty Cycle Factor (refer to section 7.1) had already compensated to the test data.



11.4. Appendix D: Maximum Average power spectral density

11.4.1. Test Result

Test Mode	Antenna	Channel	Result[dBm/3kHz]	Limit[dBm/3kHz]	Verdict
11B	Ant1	2412	-16.13	≤8.00	PASS
		2437	-15.66	≤8.00	PASS
		2462	-15.9	≤8.00	PASS
11G	Ant1	2412	-14.06	≤8.00	PASS
		2437	-13.9	≤8.00	PASS
		2462	-13.47	≤8.00	PASS
11N20SISO	Ant1	2412	-17.43	≤8.00	PASS
		2437	-17.45	≤8.00	PASS
		2462	-16.97	≤8.00	PASS

- Note: 1. Conducted Power=Meas. Level+ Correction Factor
2. The Duty Cycle Factor (refer to section 7.1) had already compensated to the test data.

11.4.2. Test Graphs

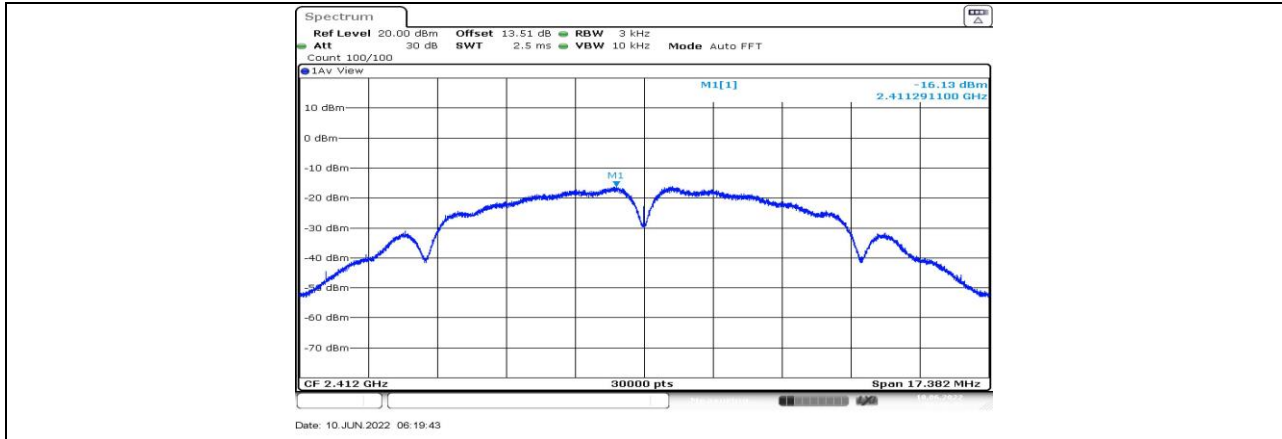

11B_Ant1_2412

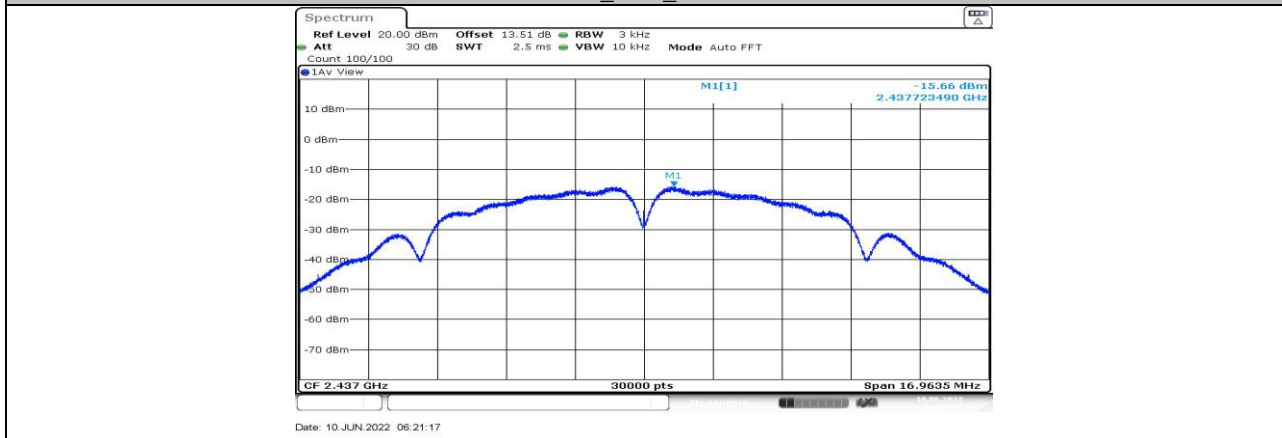

11B_Ant1_2437

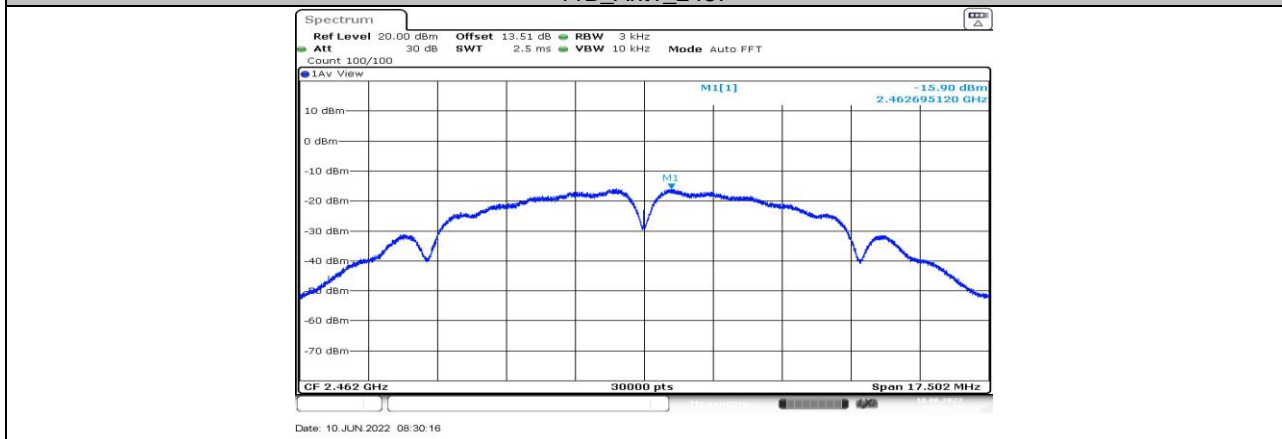

11B_Ant1_2462

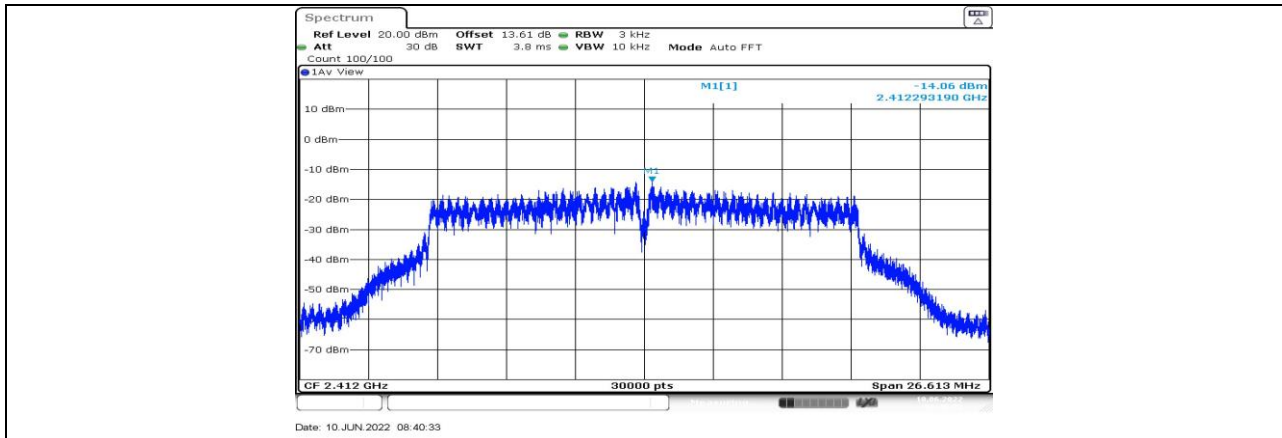

11G_Ant1_2412

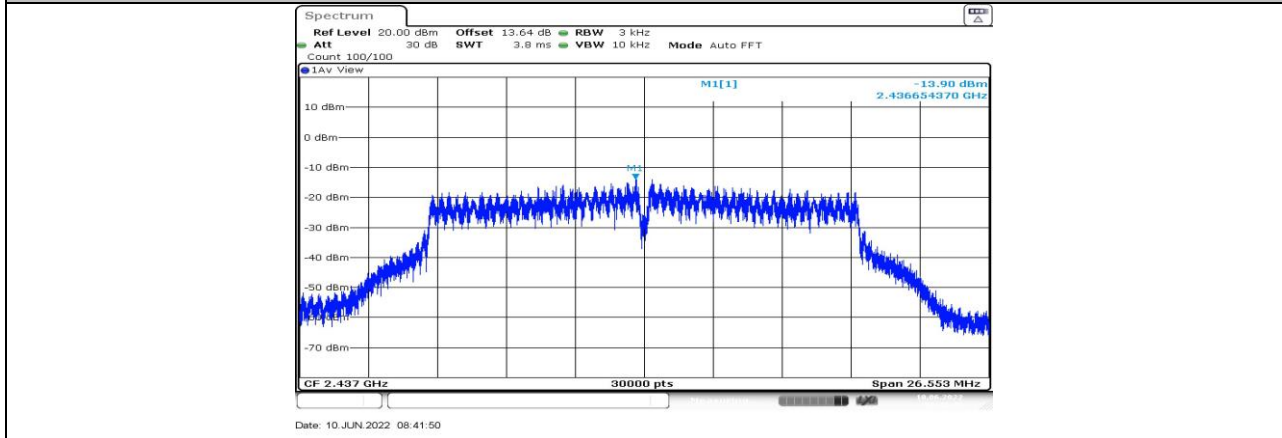

11G_Ant1_2437

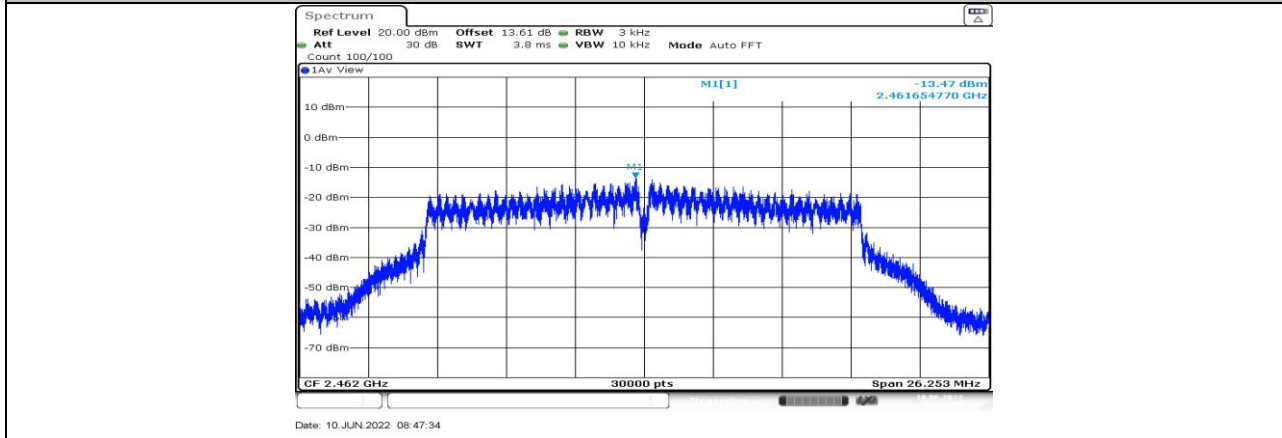

11G_Ant1_2462

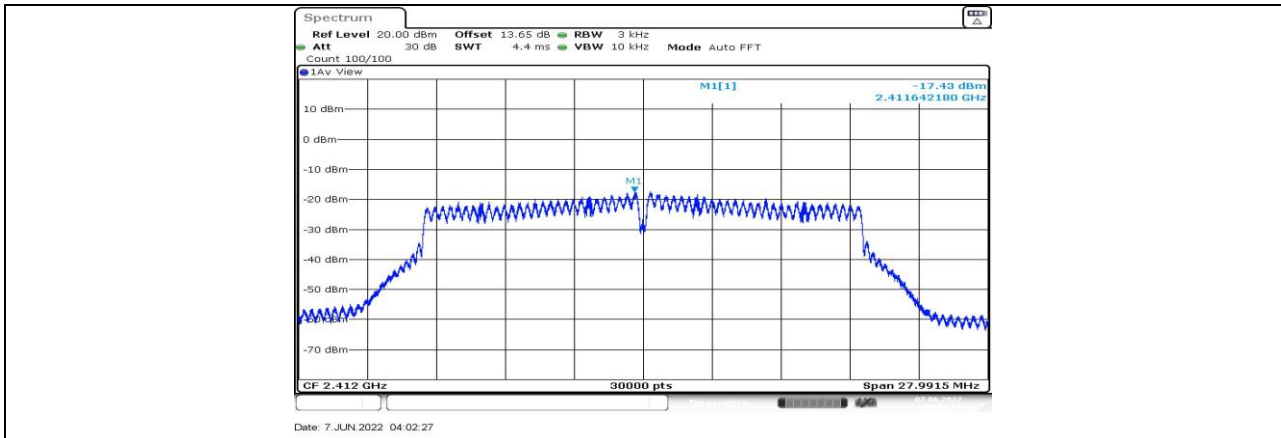

11N20SISO_Ant1_2412

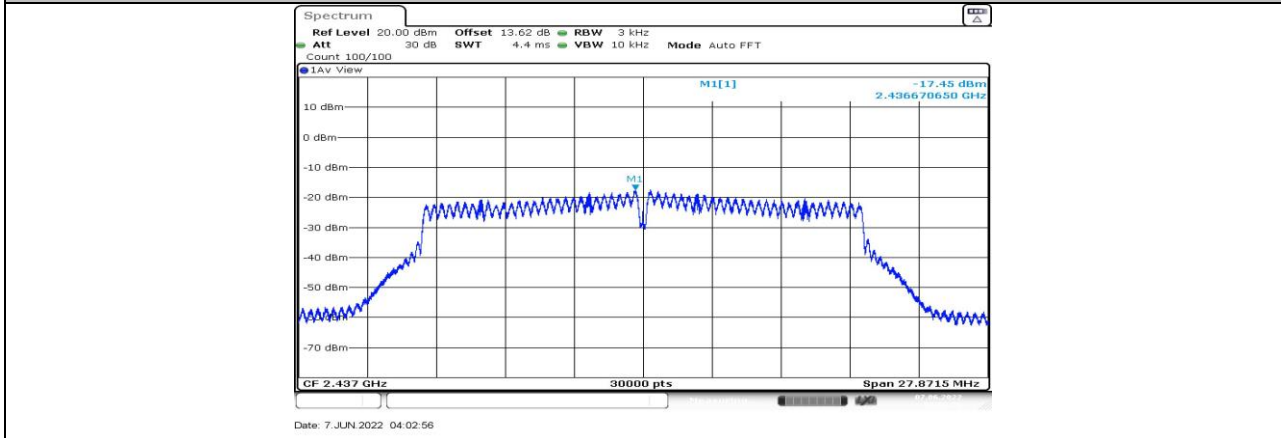

11N20SISO_Ant1_2437

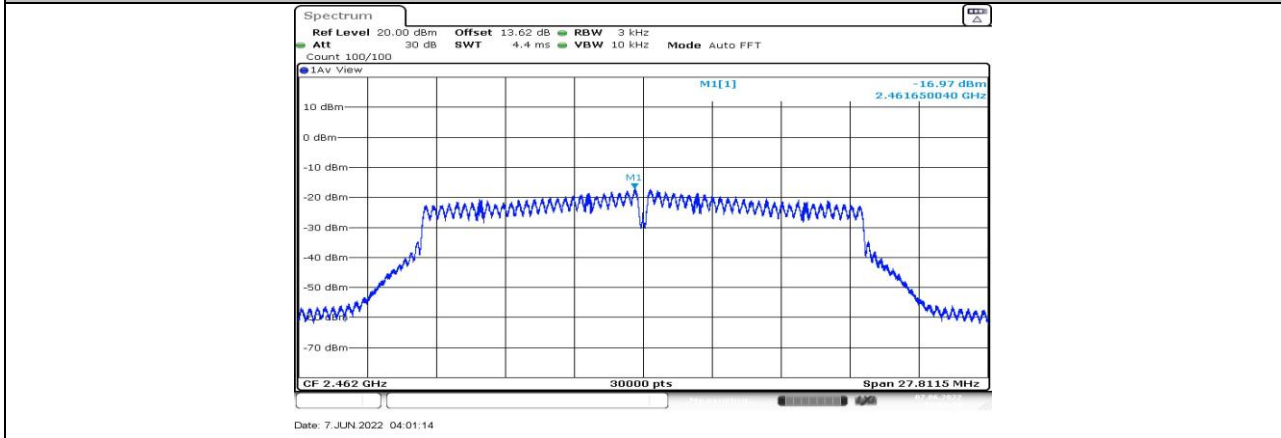

11N20SISO_Ant1_2462



11.5. Appendix E: Band edge measurements
11.5.1. Test Result

Test Mode	Antenna	ChName	Channel	RefLevel[dBm]	Result[dBm]	Limit[dBm]	Verdict
11B	Ant1	Low	2412	6.09	-35.72	≤-23.91	PASS
		High	2462	6.99	-45.52	≤-23.01	PASS
11G	Ant1	Low	2412	3.04	-31.66	≤-26.96	PASS
		High	2462	2.91	-38.28	≤-27.09	PASS
11N20SISO	Ant1	Low	2412	5.87	-24.68	≤-24.13	PASS
		High	2462	6.29	-32.73	≤-23.71	PASS



11.5.2. Test Graphs

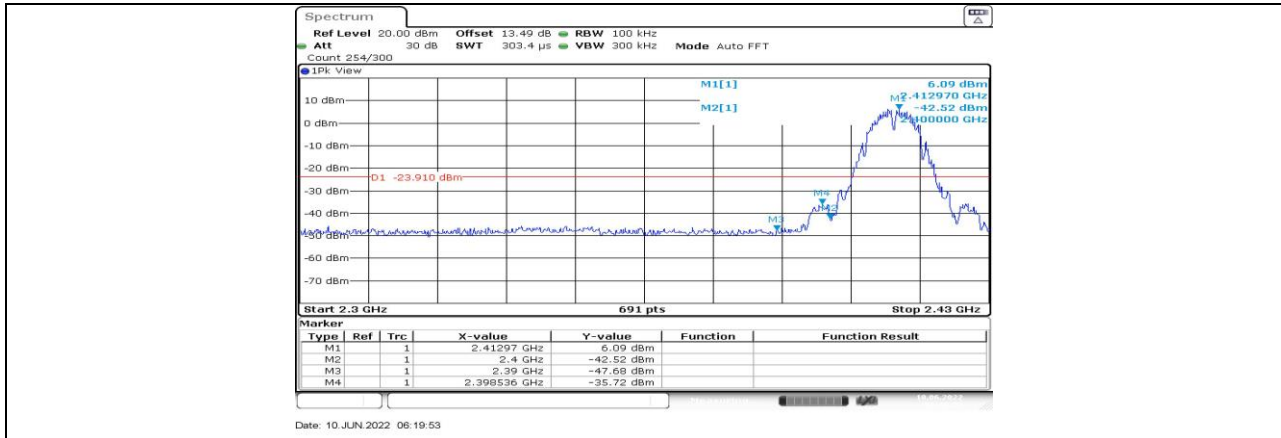

11B_Ant1_Low_2412



11B_Ant1_High_2462

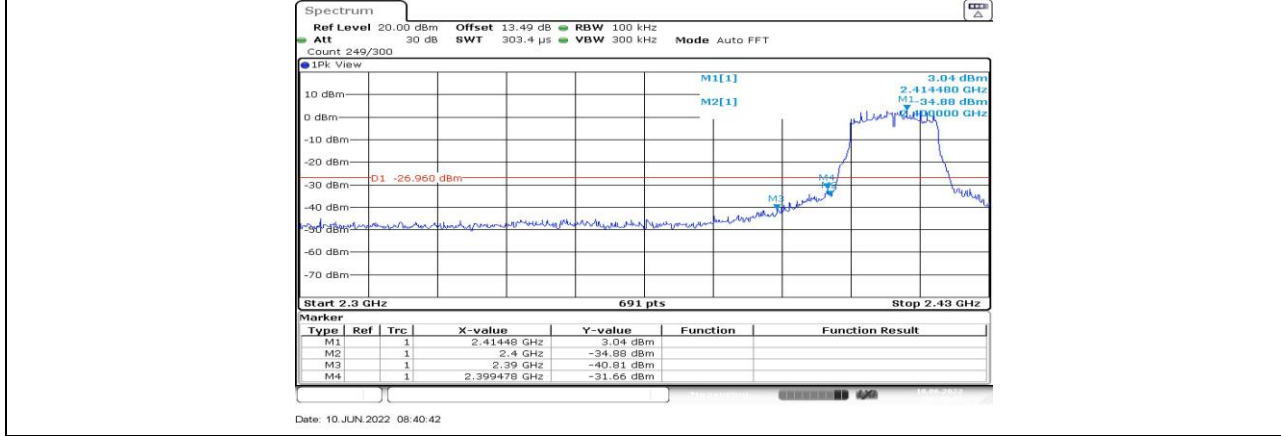

11G_Ant1_Low_2412

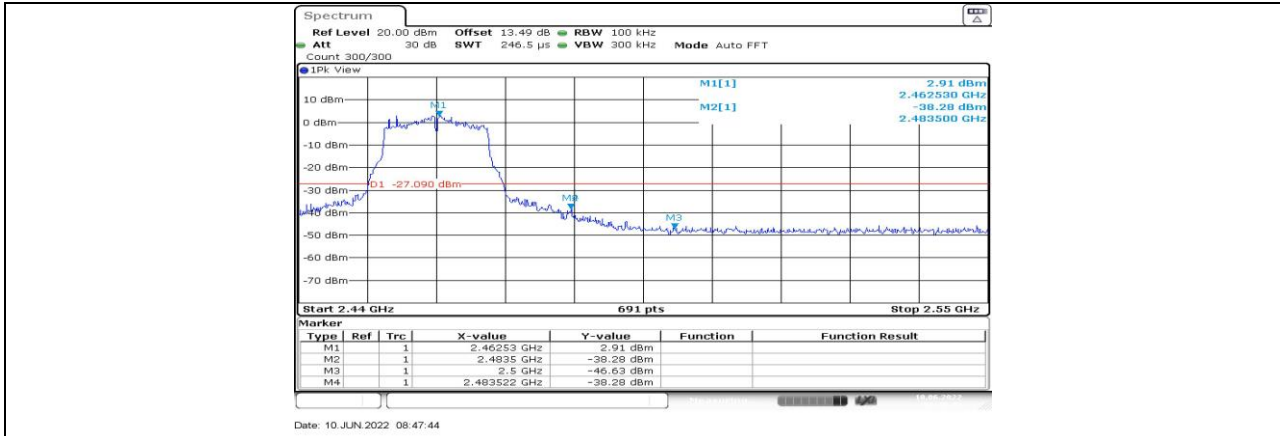

11G_Ant1_High_2462

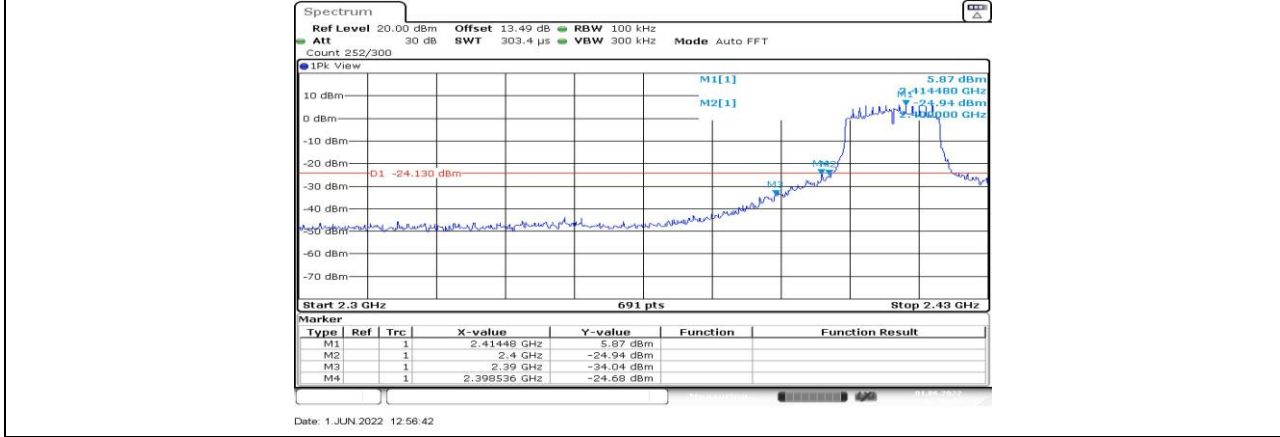

11N20SISO_Ant1_Low_2412

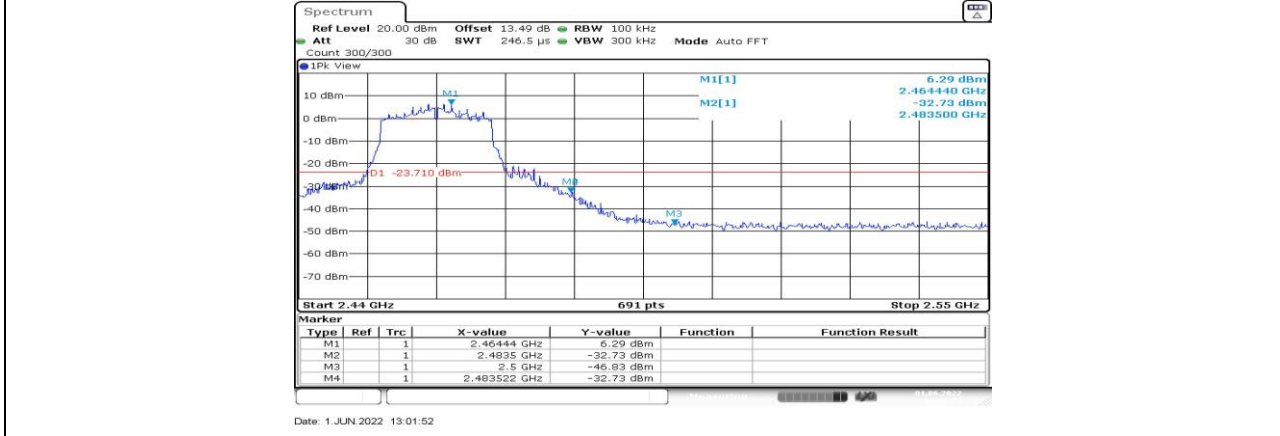

11N20SISO_Ant1_High_2462

**11.6. Appendix F: Conducted Spurious Emission****11.6.1. Test Result**

Test Mode	Antenna	Channel	FreqRange [Mhz]	Result [dBm]	Limit [dBm]	Verdict
11B	Ant1	2412	Reference	6.88	---	PASS
			30~1000	-54.6	≤-23.12	PASS
			1000~26500	-49.33	≤-23.12	PASS
		2437	Reference	7.51	---	PASS
			30~1000	-54.31	≤-22.49	PASS
			1000~26500	-48.66	≤-22.49	PASS
		2462	Reference	7.28	---	PASS
			30~1000	-54.42	≤-22.72	PASS
			1000~26500	-49.99	≤-22.72	PASS
11G	Ant1	2412	Reference	2.79	---	PASS
			30~1000	-54.1	≤-27.21	PASS
			1000~26500	-49.43	≤-27.21	PASS
		2437	Reference	3.26	---	PASS
			30~1000	-53.94	≤-26.74	PASS
			1000~26500	-48.16	≤-26.74	PASS
		2462	Reference	3.79	---	PASS
			30~1000	-53.84	≤-26.21	PASS
			1000~26500	-49.64	≤-26.21	PASS
11N20SISO	Ant1	2412	Reference	6.51	---	PASS
			30~1000	-54.7	≤-23.49	PASS
			1000~26500	-48.94	≤-23.49	PASS
		2437	Reference	5.81	---	PASS
			30~1000	-54.7	≤-24.19	PASS
			1000~26500	-48.97	≤-24.19	PASS
		2462	Reference	6.29	---	PASS
			30~1000	-54.27	≤-23.71	PASS
			1000~26500	-49.15	≤-23.71	PASS

11.6.2. Test Graphs

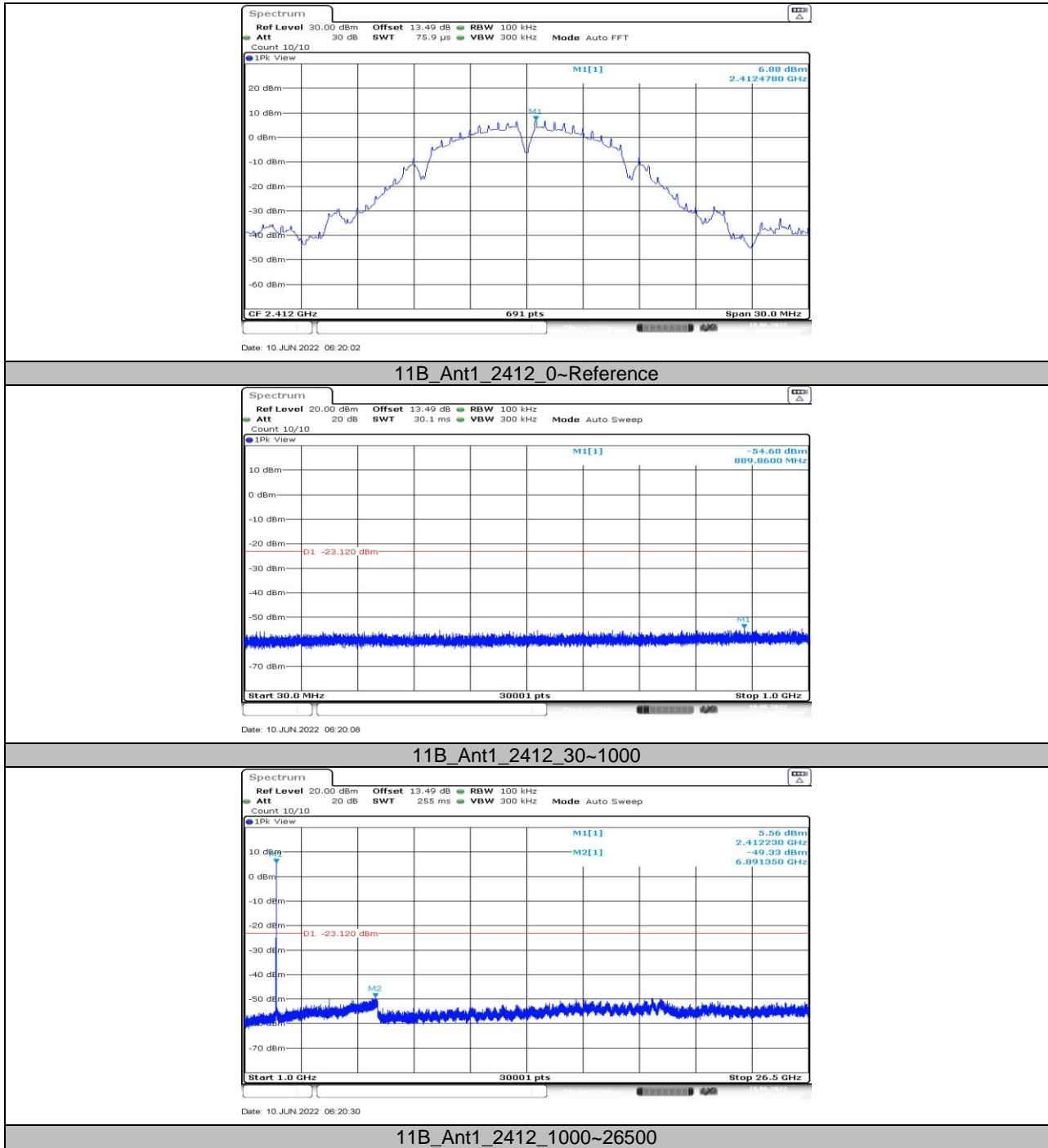

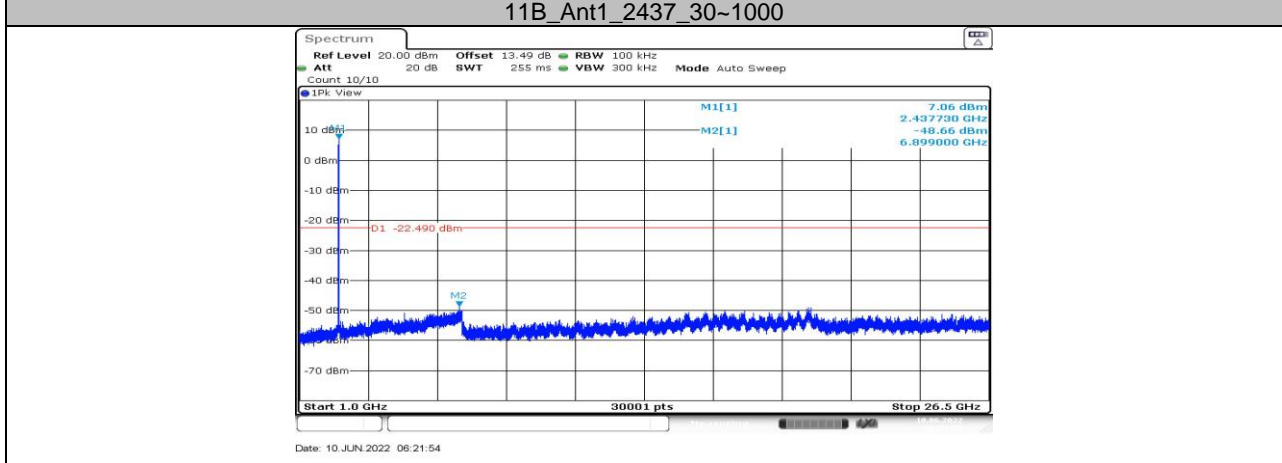
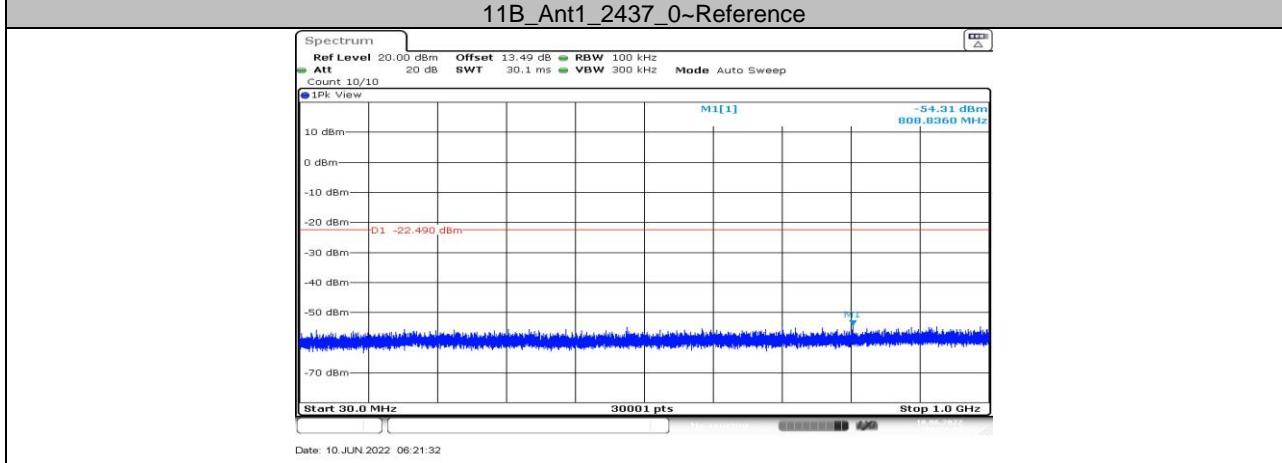
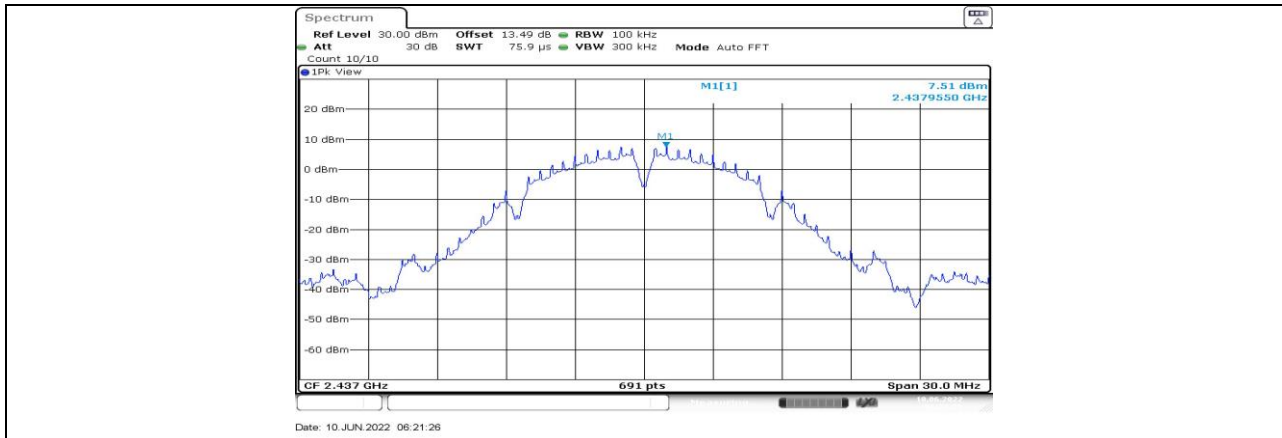

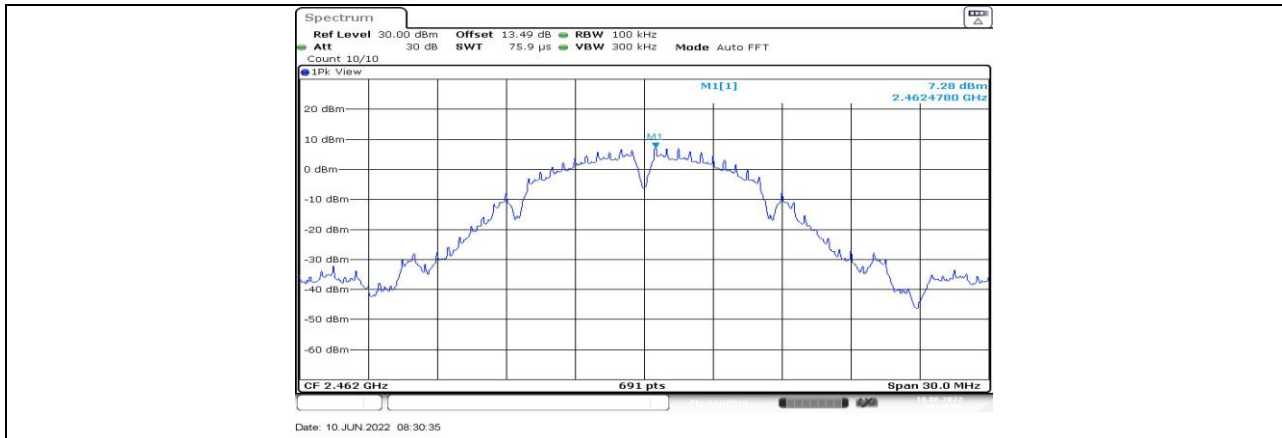

11B_Ant1_2462_0~Reference

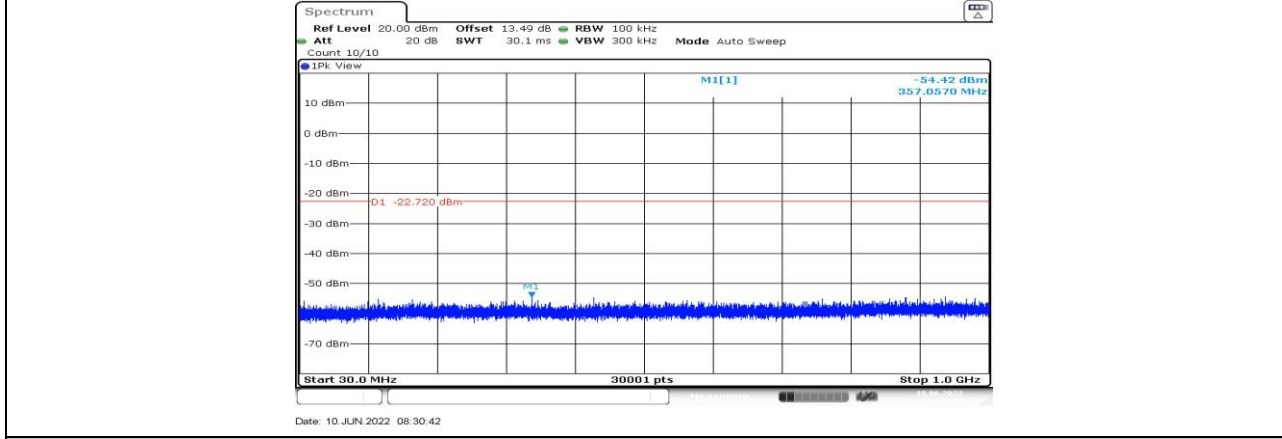

11B_Ant1_2462_30~1000

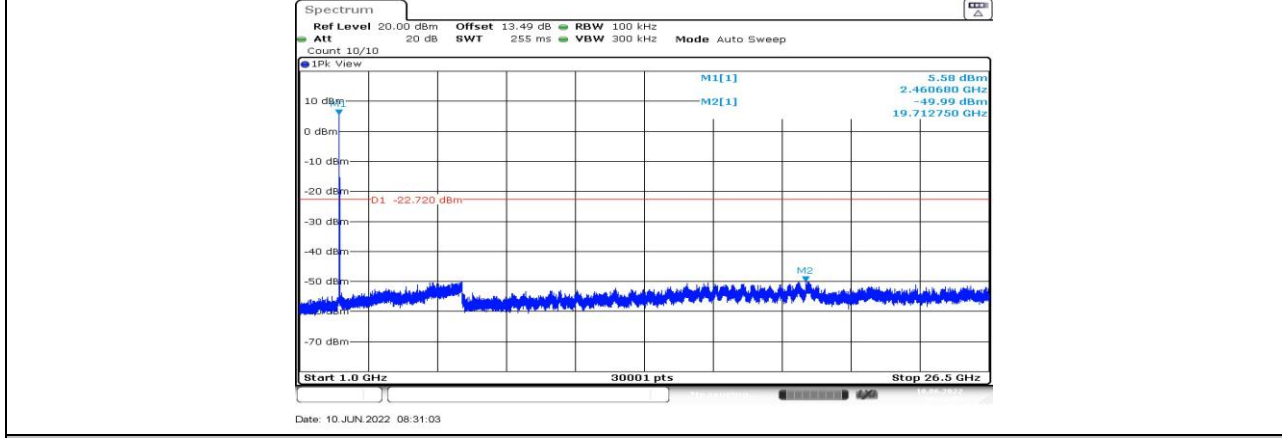

11B_Ant1_2462_1000~26500

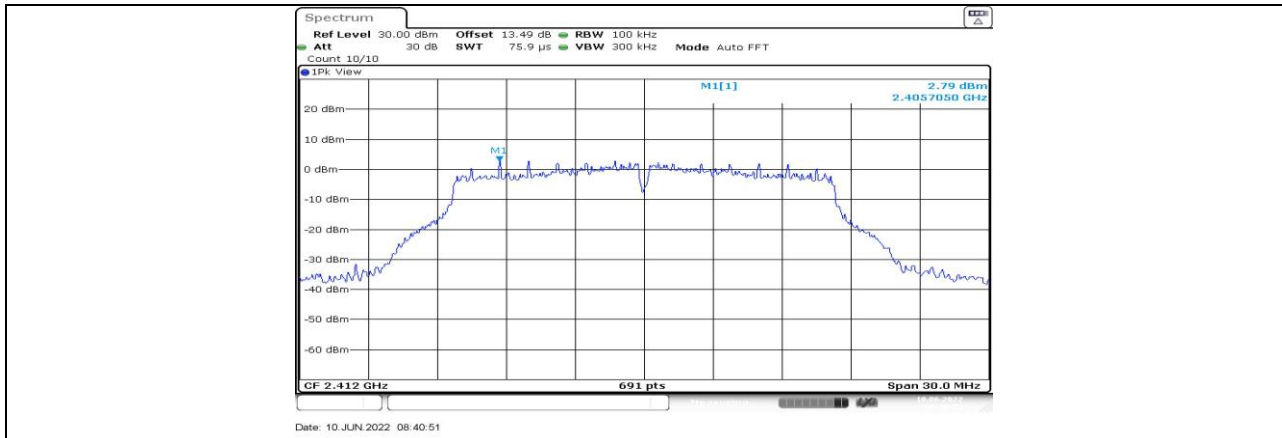

11G_Ant1_2412_0~Reference

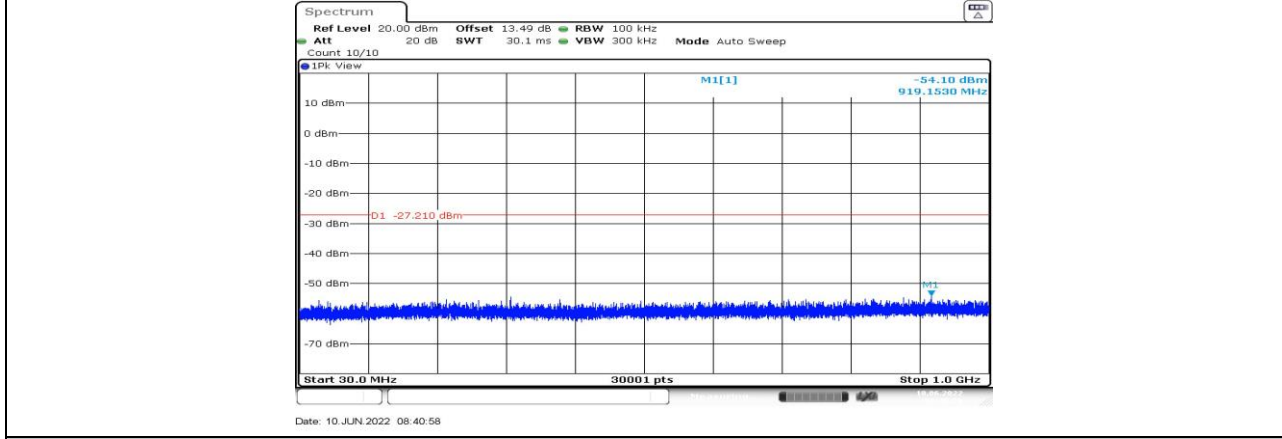

11G_Ant1_2412_30~1000

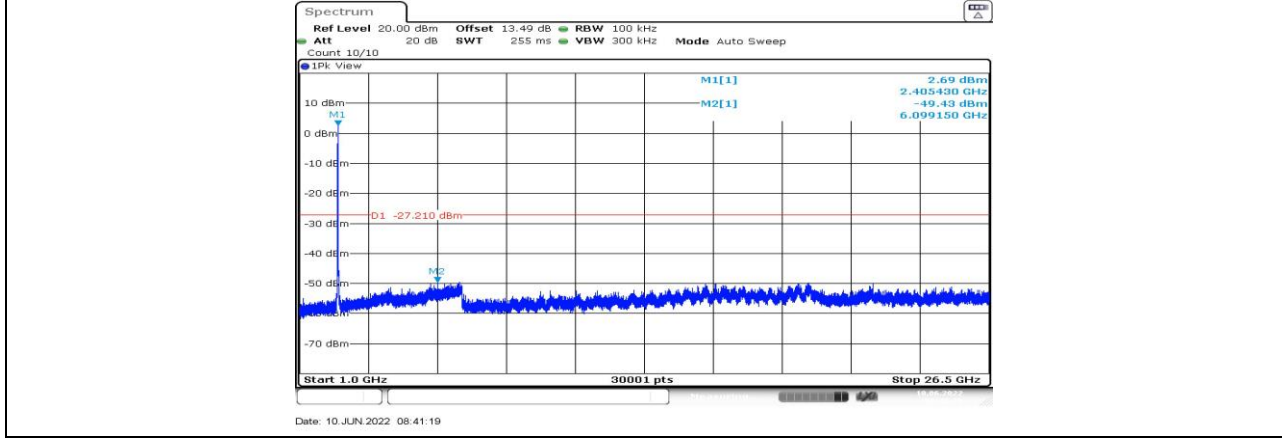

11G_Ant1_2412_1000~26500

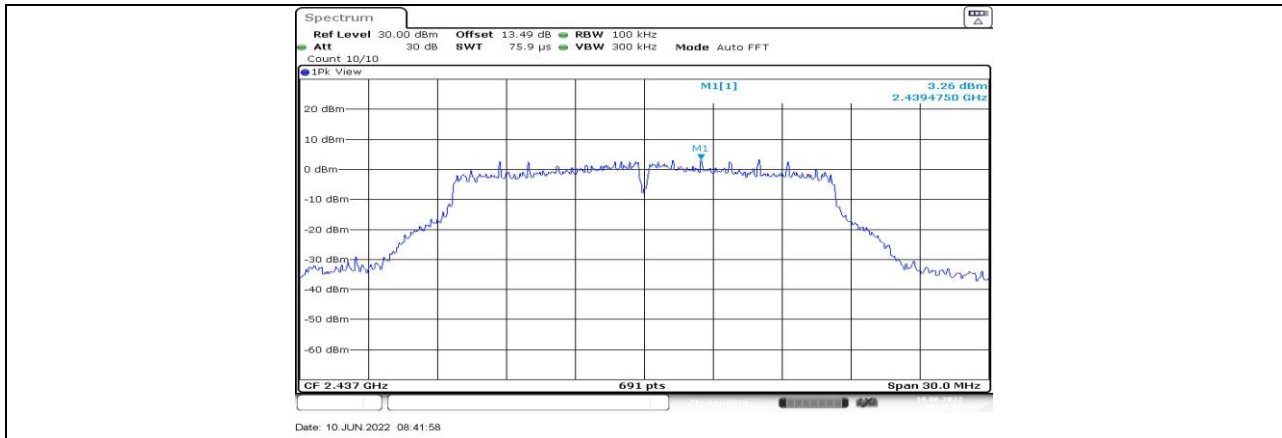

11G_Ant1_2437_0~Reference

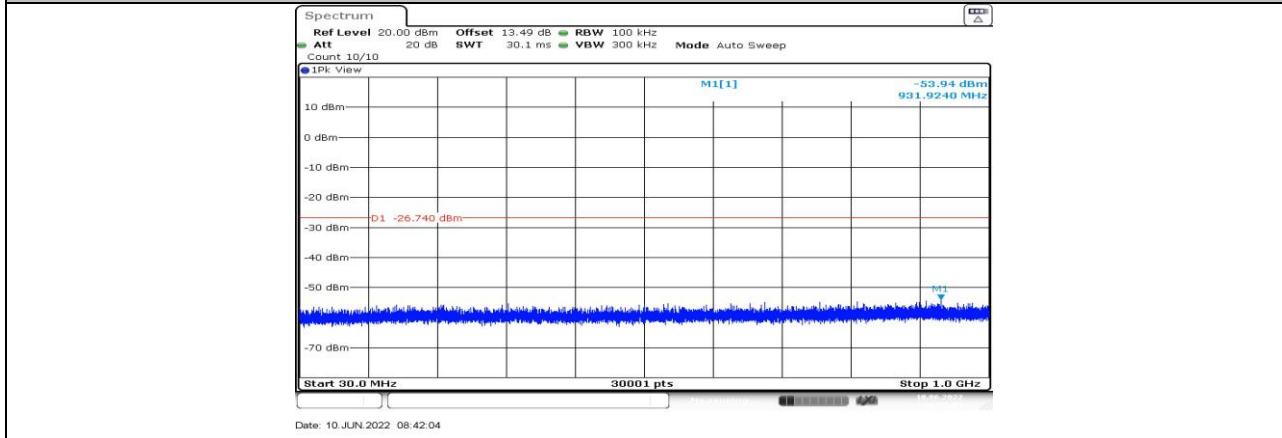

11G_Ant1_2437_30~1000

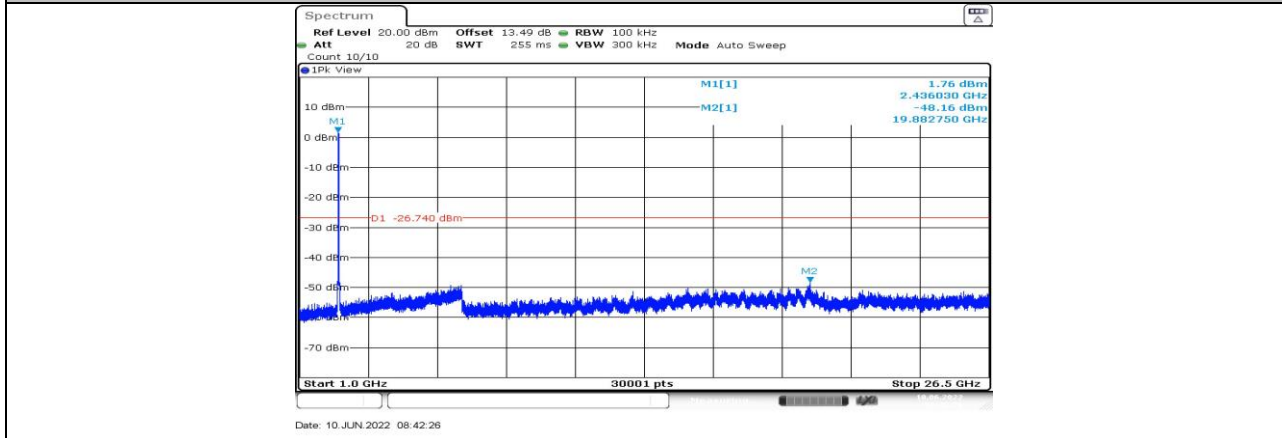

11G_Ant1_2437_1000~26500

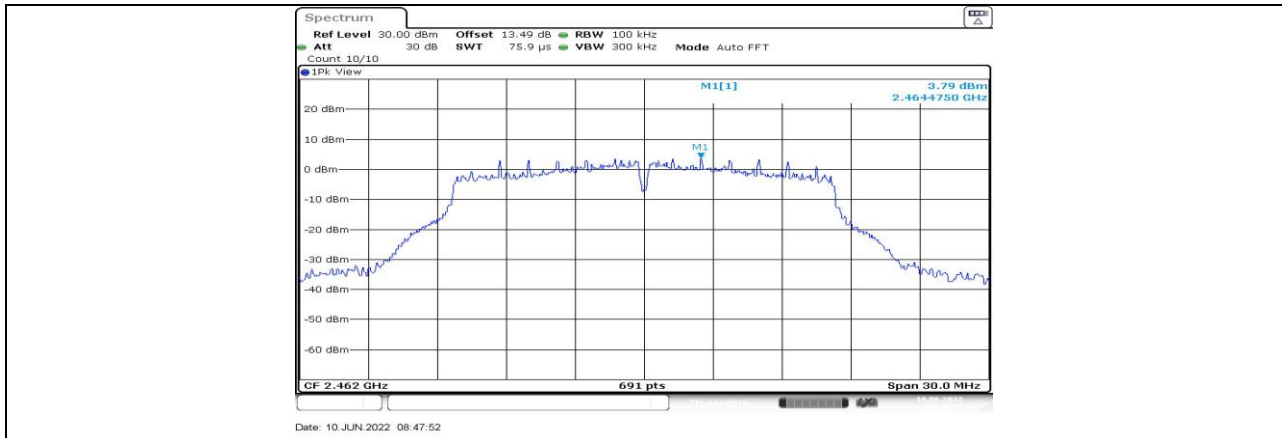

11G_Ant1_2462_0~Reference

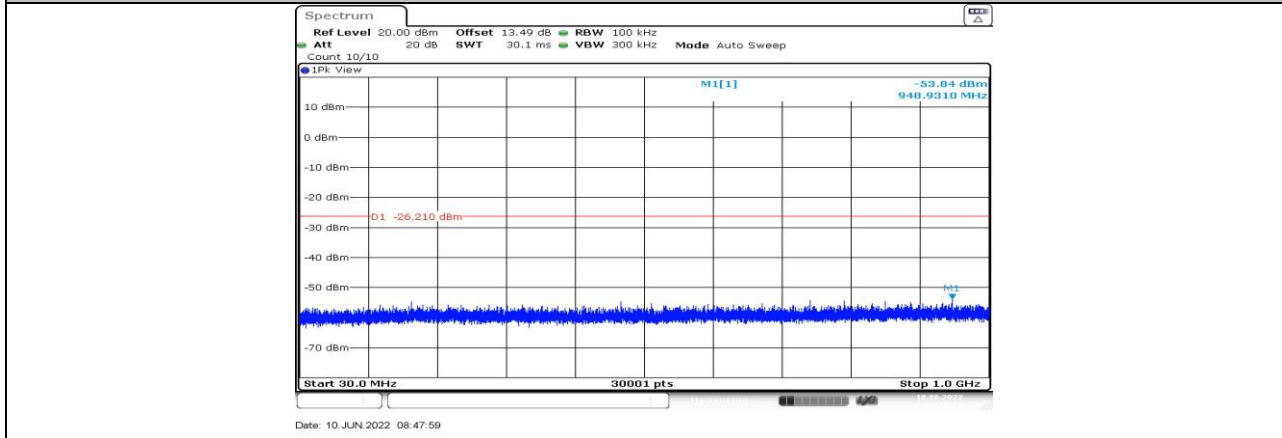

11G_Ant1_2462_30~1000

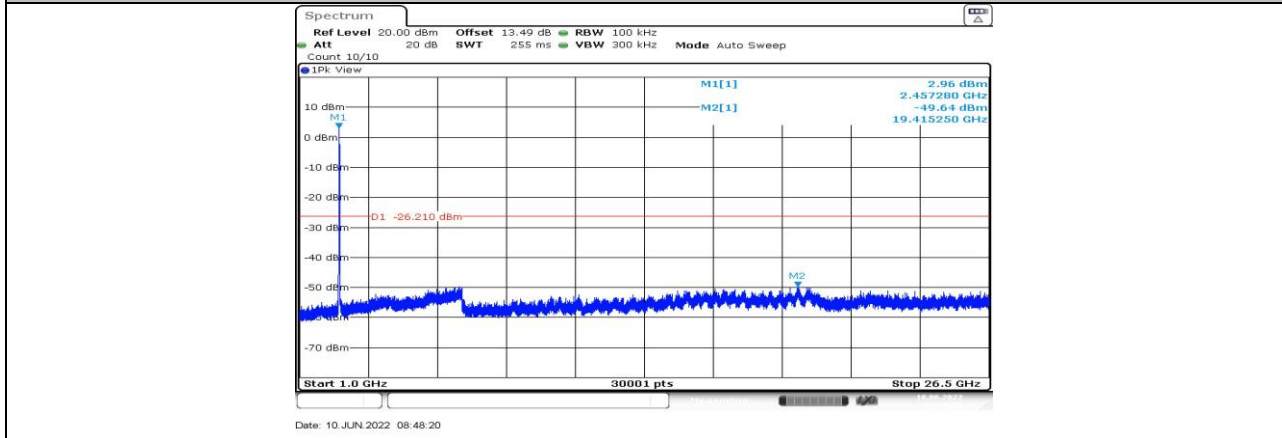

11G_Ant1_2462_1000~26500

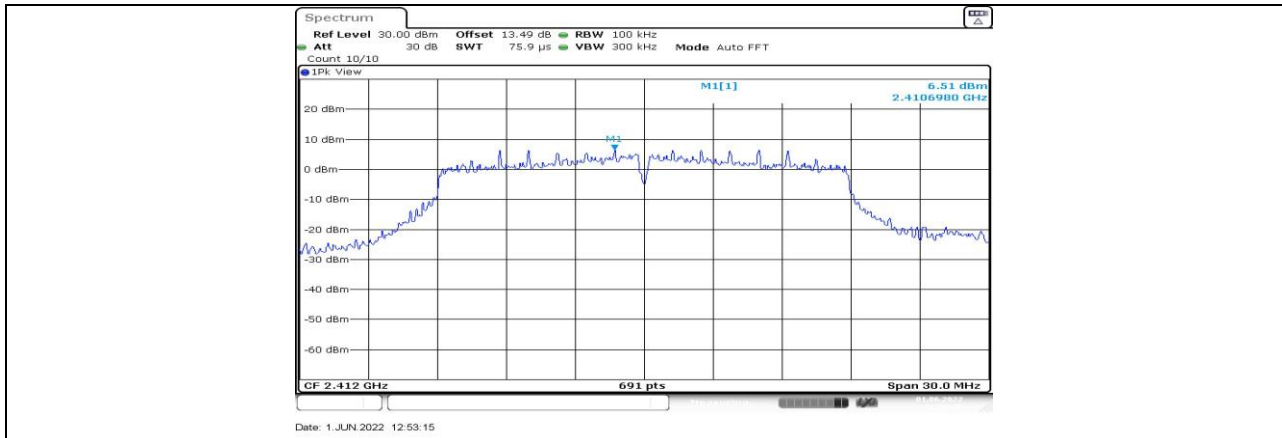

11N20SISO_Ant1_2412_0~Reference

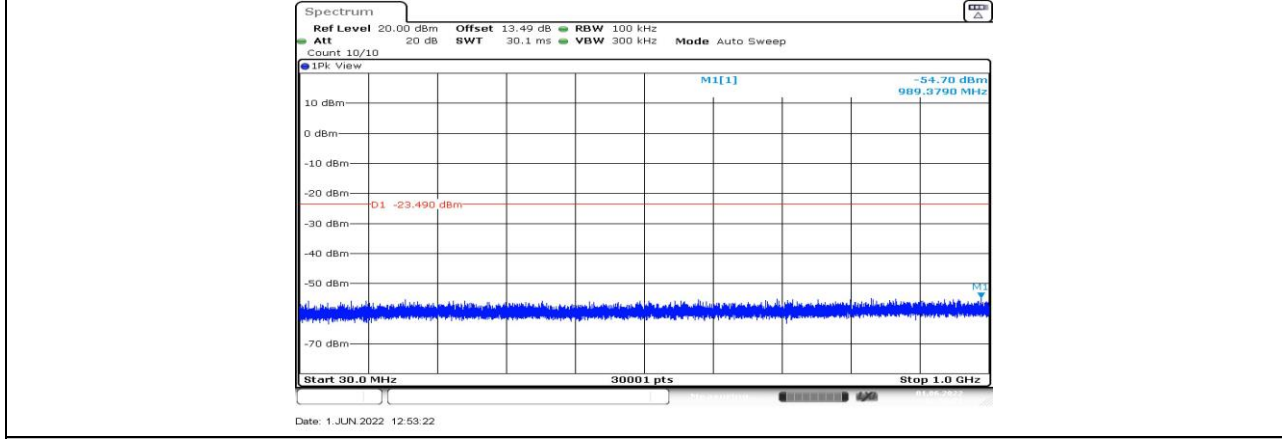

11N20SISO_Ant1_2412_30~100

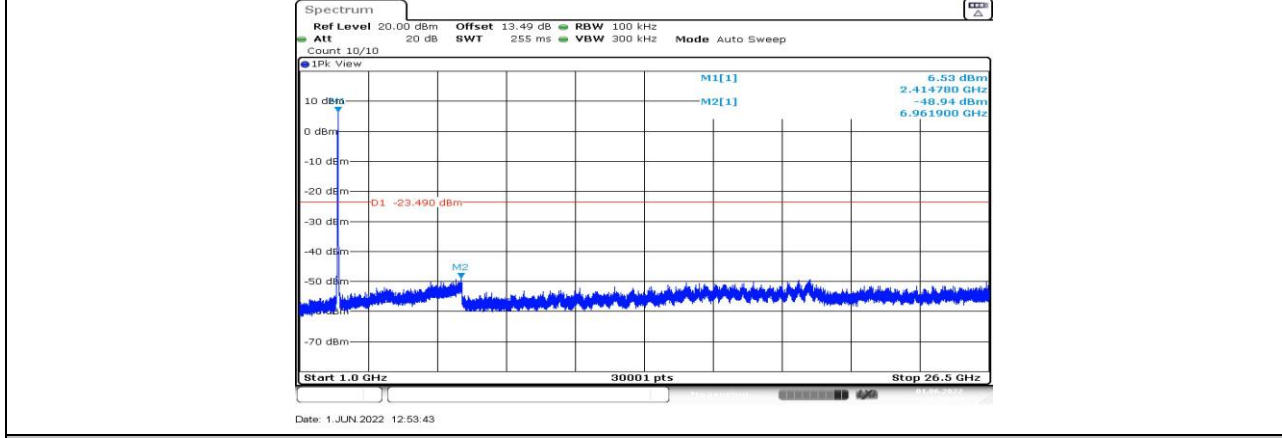

11N20SISO_Ant1_2412_1000~26500

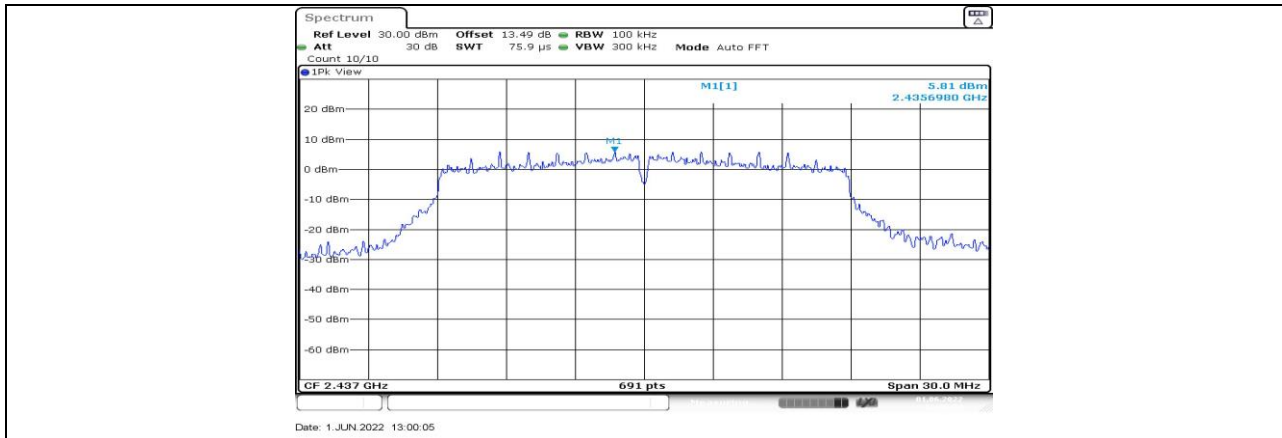

11N20SISO_Ant1_2437_0~Reference

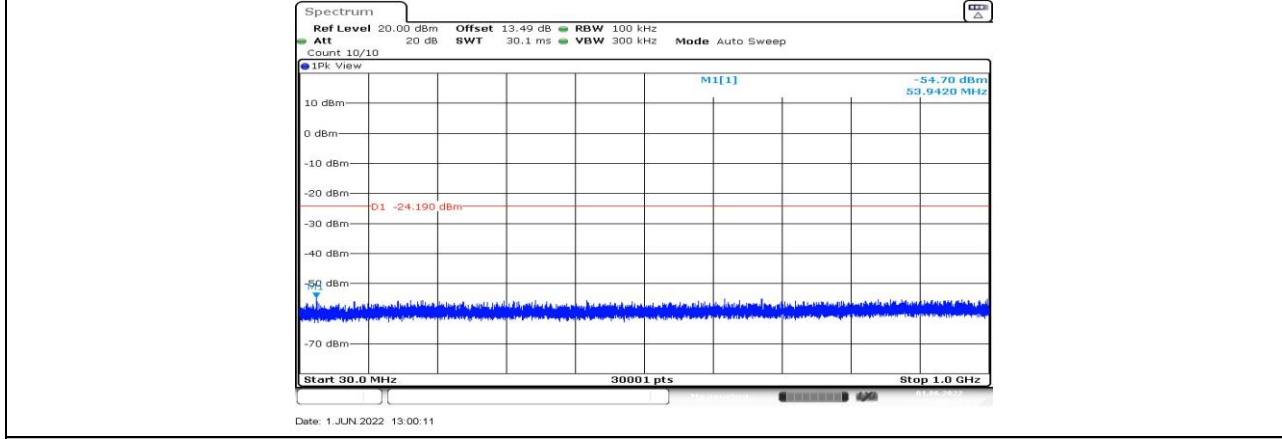

11N20SISO_Ant1_2437_30~100

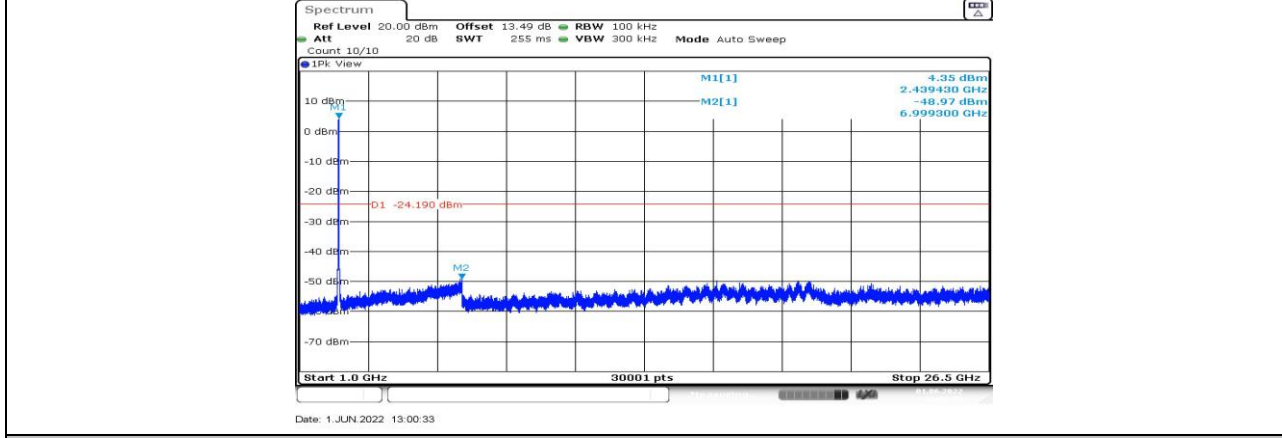

11N20SISO_Ant1_2437_1000~26500

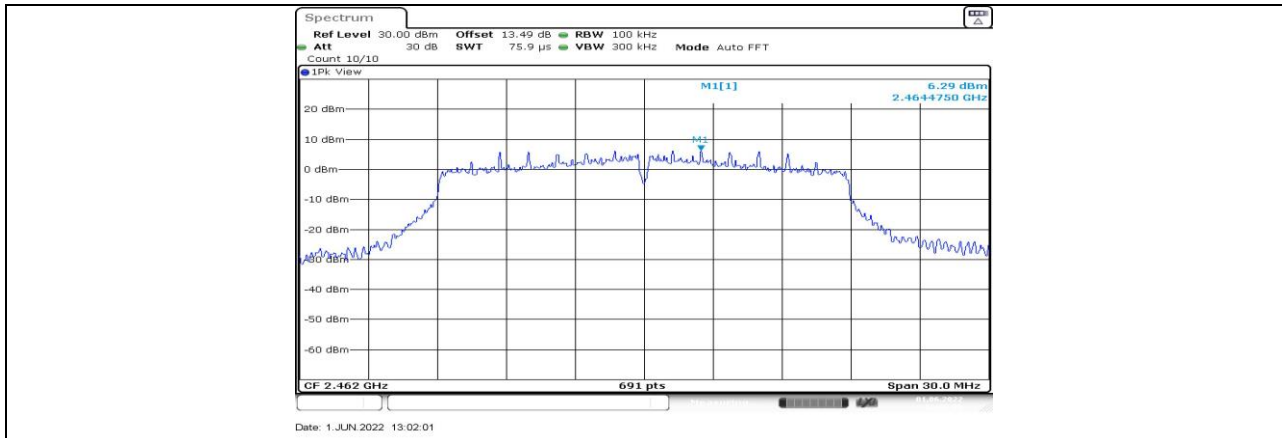

11N20SISO_Ant1_2462_0~Reference

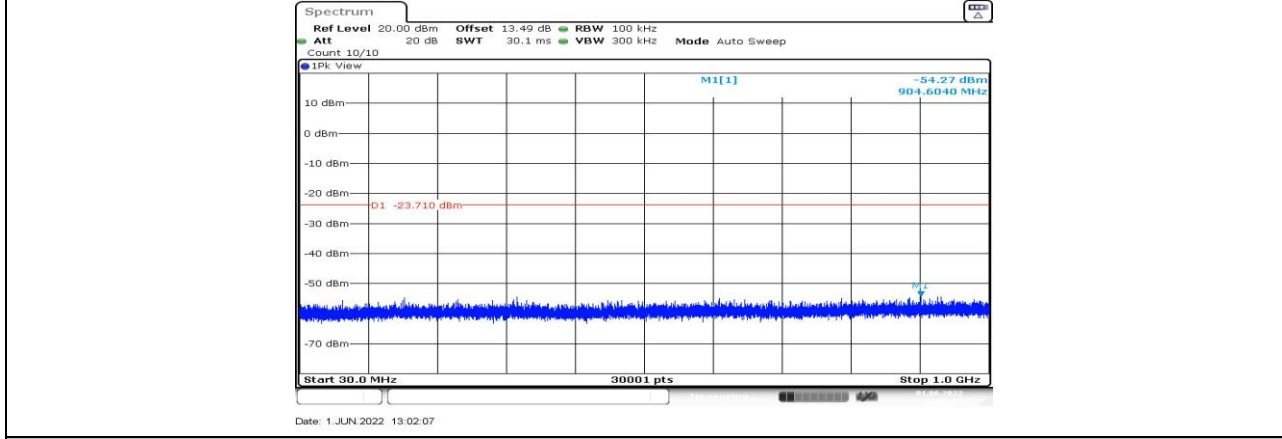

11N20SISO_Ant1_2462_30~100

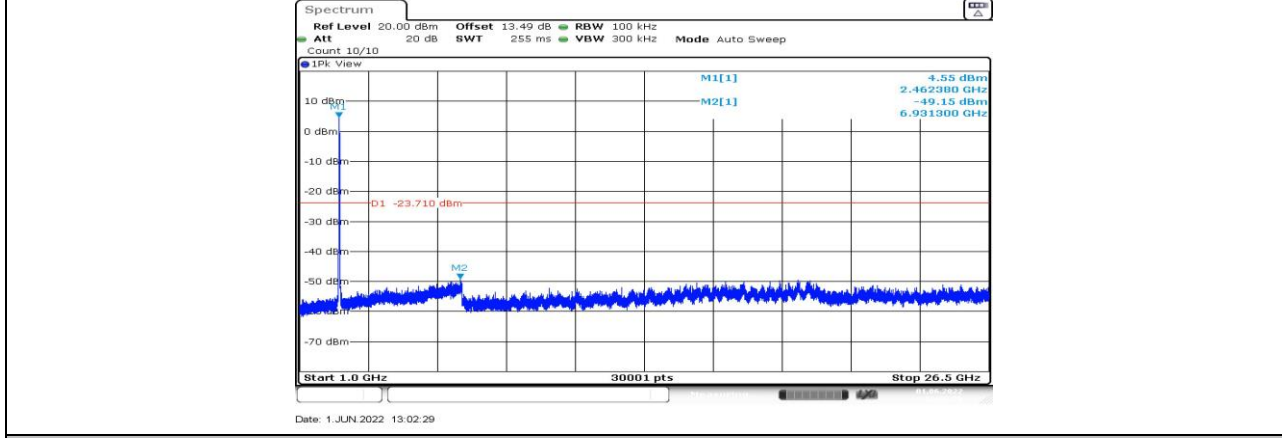

11N20SISO_Ant1_2462_1000~26500



11.7. Appendix G: Duty Cycle

11.7.1. Test Result

Test Mode	On Time (msec)	Period (msec)	Duty Cycle x (Linear)	Duty Cycle (%)	Duty Cycle Correction Factor (dB)	1/T Minimum VBW (kHz)	Final setting For VBW (kHz)
11B	8.39	8.43	0.9953	99.53	0.02	0.12	0.01
11G	1.38	1.43	0.9650	96.50	0.15	0.72	1
11N20SISO	1.30	1.34	0.9701	97.01	0.13	0.77	1

Note:

Duty Cycle Correction Factor= $10\log(1/x)$.

Where: x is Duty Cycle (Linear)

Where: T is On Time

If that calculated VBW is not available on the analyzer then the next higher value should be used.



11.7.2. Test Graphs

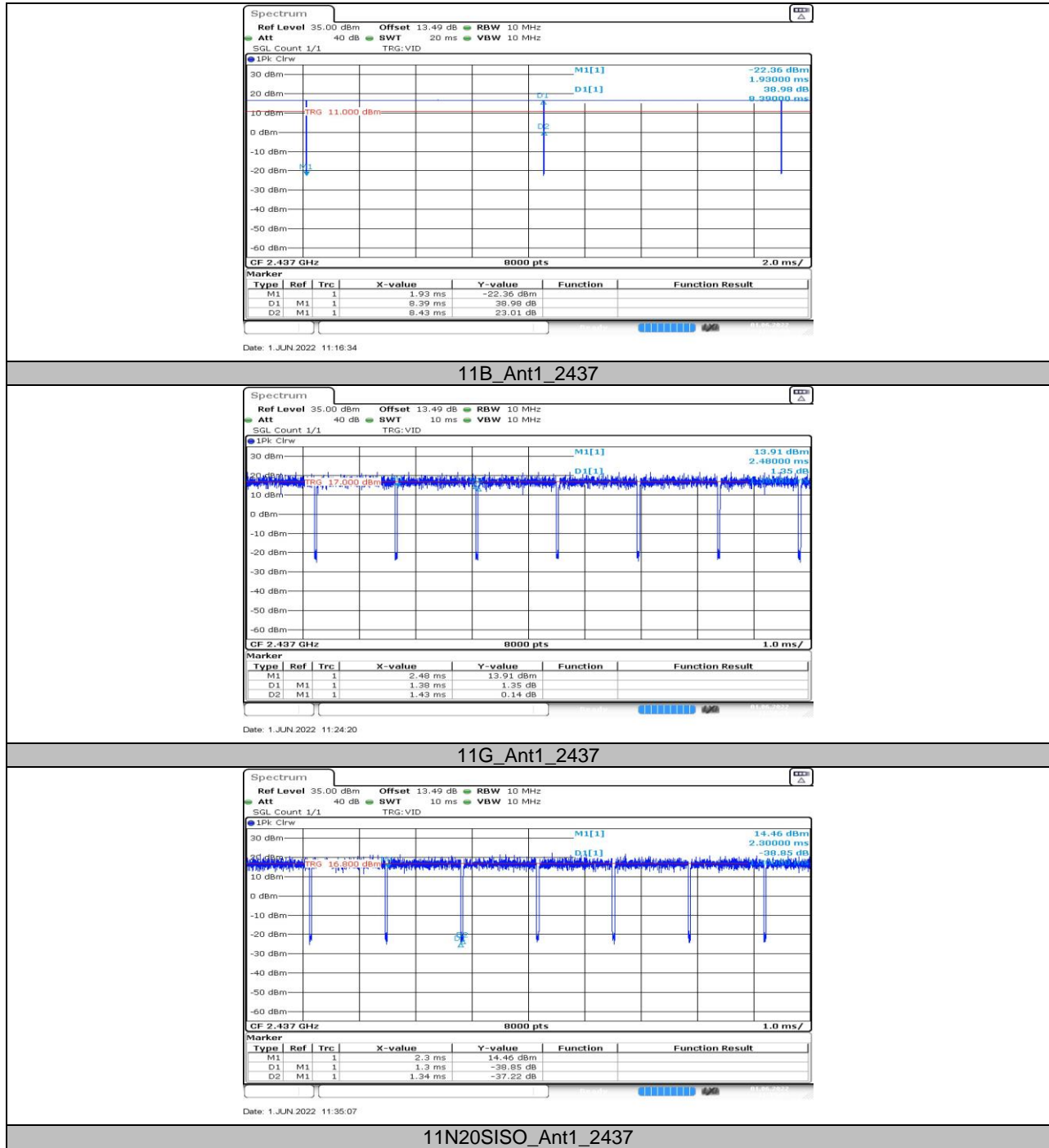

END OF REPORT