



**CFR 47 FCC PART 15 SUBPART C
ISED RSS-247 ISSUE 2**

CERTIFICATION TEST REPORT

For

Tablet

MODEL NUMBER: IQ Remote

FCC ID: 2AAJXQS-IQRT2

IC: 11205A-QSIQRT2

REPORT NUMBER: 4790411210.2-1

ISSUE DATE: June 10, 2022

Prepared for

Qolsys, Inc.

1919 S. Bascom Ave. Suite 600, Campbell, California, 95008 United States

Prepared by

UL Verification Services (Guangzhou) Co., Ltd, Song Shan Lake Branch

Building 10, Innovation Technology Park, No. 1, Li Bin Road, Song Shan Lake Hi-Tech Development Zone Dongguan, 523808, People's Republic of China

Tel: +86 769 22038881

Fax: +86 769 33244054

Website: www.ul.com



Revision History

| <u>Rev.</u> | <u>Issue Date</u> | <u>Revisions</u> | <u>Revised By</u> |
|-------------|-------------------|------------------|-------------------|
| V0 | 6/10/2022 | Initial Issue | |



| Summary of Test Results | | | |
|--|---|---|--------------|
| Clause | Test Items | FCC/ISED Rules | Test Results |
| 1 | 6dB Bandwidth and 99% Occupied Bandwidth | FCC Part 15.247 (a) (2) RSS-247 Clause 5.2 (a) ISED RSS-Gen Clause 6.7 | Pass |
| 2 | Peak Conducted Output Power | FCC Part 15.247 (b) (3) RSS-247 Clause 5.4 (d) | Pass |
| 3 | Power Spectral Density | FCC Part 15.247 (e) RSS-247 Clause 5.2 (b) | Pass |
| 4 | Conducted Bandedge and Spurious Emission | FCC Part 15.247 (d) RSS-247 Clause 5.5 | Pass |
| 5 | Radiated Bandedge and Spurious Emission | FCC Part 15.247 (d) FCC Part 15.209 FCC Part 15.205 RSS-247 Clause 5.5 RSS-GEN Clause 8.9 | Pass |
| 6 | Conducted Emission Test for AC Power Port | FCC Part 15.207 RSS-GEN Clause 8.8 | Pass |
| 7 | Antenna Requirement | FCC Part 15.203 RSS-GEN Clause 6.8 | Pass |
| <p>Note:</p> <p>1. This test report is only published to and used by the applicant, and it is not for evidence purpose in China.</p> <p>2. The measurement result for the sample received is <Pass> according to < CFR 47 FCC PART 15 SUBPART C >< ISED RSS-247 > when <Accuracy Method> decision rule is applied.</p> | | | |

TABLE OF CONTENTS

| | |
|--|-----------|
| 1. ATTESTATION OF TEST RESULTS | 6 |
| 2. TEST METHODOLOGY | 7 |
| 3. FACILITIES AND ACCREDITATION | 7 |
| 4. CALIBRATION AND UNCERTAINTY | 8 |
| 4.1. <i>MEASURING INSTRUMENT CALIBRATION</i> | 8 |
| 4.2. <i>MEASUREMENT UNCERTAINTY</i> | 8 |
| 5. EQUIPMENT UNDER TEST | 9 |
| 5.1. <i>DESCRIPTION OF EUT</i> | 9 |
| 5.2. <i>CHANNEL LIST</i> | 9 |
| 5.3. <i>MAXIMUM PEAK OUTPUT POWER</i> | 9 |
| 5.4. <i>TEST CHANNEL CONFIGURATION</i> | 10 |
| 5.5. <i>THE WORSE CASE POWER SETTING PARAMETER</i> | 10 |
| 5.6. <i>DESCRIPTION OF AVAILABLE ANTENNAS</i> | 10 |
| 5.7. <i>DESCRIPTION OF TEST SETUP</i> | 11 |
| 6. MEASURING INSTRUMENT AND SOFTWARE USED | 12 |
| 7. ANTENNA PORT TEST RESULTS | 14 |
| 7.1. <i>ON TIME AND DUTY CYCLE</i> | 14 |
| 7.2. <i>6 dB DTS BANDWIDTH AND 99 % OCCUPIED BANDWIDTH</i> | 15 |
| 7.3. <i>CONDUCTED OUTPUT POWER</i> | 17 |
| 7.4. <i>POWER SPECTRAL DENSITY</i> | 18 |
| 7.5. <i>CONDUCTED BANDEDGE AND SPURIOUS EMISSIONS</i> | 20 |
| 8. RADIATED TEST RESULTS | 22 |
| 8.1. <i>RESTRICTED BANDEDGE</i> | 28 |
| 8.1.1. <i>BLE_1M MODE</i> | 28 |
| 8.1.2. <i>BLE_2M MODE</i> | 31 |
| 8.2. <i>SPURIOUS EMISSIONS (1 GHz ~ 3 GHz)</i> | 33 |
| 8.2.1. <i>BLE_1M MODE</i> | 33 |
| 8.3. <i>SPURIOUS EMISSIONS (3 GHz ~ 18 GHz)</i> | 39 |
| 8.3.1. <i>BLE_1M MODE</i> | 39 |
| 8.3.2. <i>BLE_2M MODE</i> | 45 |
| 8.4. <i>SPURIOUS EMISSIONS (18 GHz ~ 26 GHz)</i> | 51 |
| 8.4.1. <i>BLE_1M MODE</i> | 51 |
| 8.5. <i>SPURIOUS EMISSIONS (30 MHz ~ 1 GHz)</i> | 53 |
| 8.5.1. <i>BLE_1M MODE</i> | 53 |



| | | |
|------------|---|-----------|
| 8.6. | <i>SPURIOUS EMISSIONS BELOW 30 MHz</i> | 55 |
| 8.6.1. | <i>BLE_1M MODE</i> | 55 |
| 9. | AC POWER LINE CONDUCTED EMISSIONS | 58 |
| 9.1. | <i>BLE_1M MODE</i> | 59 |
| 10. | ANTENNA REQUIREMENTS | 61 |
| 11. | Appendix | 62 |
| 11.1. | <i>Appendix A: DTS Bandwidth</i> | 62 |
| 11.1.1. | Test Result | 62 |
| 11.1.2. | Test Graphs | 63 |
| 11.2. | <i>Appendix B: Occupied Channel Bandwidth</i> | 65 |
| 11.2.1. | Test Result | 65 |
| 11.2.2. | Test Graphs | 66 |
| 11.3. | <i>Appendix C: Maximum conducted output power</i> | 68 |
| 11.3.1. | Test Result | 68 |
| 11.4. | <i>Appendix D: Maximum power spectral density</i> | 69 |
| 11.4.1. | Test Result | 69 |
| 11.4.2. | Test Graphs | 70 |
| 11.5. | <i>Appendix E: Band edge measurements</i> | 72 |
| 11.5.1. | Test Result | 72 |
| 11.5.2. | Test Graphs | 73 |
| 11.6. | <i>Appendix F: Conducted Spurious Emission</i> | 75 |
| 11.6.1. | Test Result | 75 |
| 11.6.2. | Test Graphs | 76 |
| 11.7. | <i>Appendix G: Duty Cycle</i> | 82 |
| 11.7.1. | Test Result | 82 |
| 11.7.2. | Test Graphs | 83 |



1. ATTESTATION OF TEST RESULTS

Applicant Information

Company Name: Qolsys, Inc.
Address: 1919 S. Bascom Ave. Suite 600, Campbell, California, 95008
United States

Manufacturer Information

Company Name: Chengdu Vantron Technology Co., Ltd.
Address: No.5 GaoPeng Road, Hi-Tech Zone, Chengdu, SiChuan, P.R.
China

EUT Information

EUT Name: Tablet Computer
Model: IQ Remote
Brand: /
Sample Received Date: May 25, 2022
Sample Status: Normal
Sample ID: 4986388
Date of Tested: May 25, 2022~ June 10, 2022

| APPLICABLE STANDARDS | |
|------------------------------|--------------|
| STANDARD | TEST RESULTS |
| CFR 47 FCC PART 15 SUBPART C | PASS |
| ISED RSS-247 Issue 2 | PASS |
| ISED RSS-GEN Issue 5 | PASS |

Prepared By:

Kebo Zhang
Project Engineer

Checked By:

Shawn Wen
Laboratory Leader

Approved By:

Stephen Guo
Laboratory Manager



2. TEST METHODOLOGY

The tests documented in this report were performed in accordance with KDB 558074 D01 15.247 Meas Guidance v05r02, 414788 D01 Radiated Test Site v01r01, CFR 47 FCC Part 2, CFR 47 FCC Part 15, ANSI C63.10-2013, ISED RSS-247 Issue 2 and ISED RSS-GEN Issue 5.

3. FACILITIES AND ACCREDITATION

| | |
|---------------------------|--|
| Accreditation Certificate | <p>A2LA (Certificate No.: 4102.01) UL Verification Services (Guangzhou) Co., Ltd. Song Shan Lake Branch. has been assessed and proved to be in compliance with A2LA.</p> <p>FCC (FCC Designation No.: CN1187) UL Verification Services (Guangzhou) Co., Ltd. Song Shan Lake Branch. Has been recognized to perform compliance testing on equipment subject to the Commission's Declaration of Conformity (DoC) and Certification rules</p> <p>ISED (Company No.: 21320) UL Verification Services (Guangzhou) Co., Ltd. Song Shan Lake Branch. has been registered and fully described in a report filed with ISED. The Company Number is 21320 and the test lab Conformity Assessment Body Identifier (CABID) is CN0046.</p> <p>VCCI (Registration No.: G-20019, R-20004, C-20012 and T-20011) UL Verification Services (Guangzhou) Co., Ltd. Song Shan Lake Branch. has been assessed and proved to be in compliance with VCCI, the Membership No. is 3793. Facility Name: Chamber D, the VCCI registration No. is G-20019 and R-20004 Shielding Room B, the VCCI registration No. is C-20012 and T-20011</p> |
|---------------------------|--|

Note 1: All tests measurement facilities use to collect the measurement data are located at Building 10, Innovation Technology Park, Song Shan Lake Hi tech Development Zone, Dongguan, 523808, China

Note 2: The test anechoic chamber in UL Verification Services (Guangzhou) Co., Ltd. Song Shan Lake Branch had been calibrated and compared to the open field sites and the test anechoic chamber is shown to be equivalent to or worst case from the open field site.

Note 3: For below 30 MHz, lab had performed measurements at test anechoic chamber and comparing to measurements obtained on an open field site. And these measurements below 30 MHz had been correlated to measurements performed on an OFS.



4. CALIBRATION AND UNCERTAINTY

4.1. MEASURING INSTRUMENT CALIBRATION

The measuring equipment utilized to perform the tests documented in this report has been calibrated in accordance with the manufacturer's recommendations and is traceable to recognize national standards.

4.2. MEASUREMENT UNCERTAINTY

Where relevant, the following measurement uncertainty levels have been estimated for tests performed on the apparatus:

| Test Item | Uncertainty |
|--|---------------------------|
| Conduction emission | 3.62 dB |
| Radiated Emission (Included Fundamental Emission) (9 kHz ~ 30 MHz) | 2.2 dB |
| Radiated Emission (Included Fundamental Emission) (30 MHz ~ 1 GHz) | 4.00 dB |
| Radiated Emission (Included Fundamental Emission) (1 GHz to 26 GHz) | 5.78 dB (1 GHz ~ 18 GHz) |
| | 5.23 dB (18 GHz ~ 26 GHz) |
| Note: This uncertainty represents an expanded uncertainty expressed at approximately the 95 % confidence level using a coverage factor of k=2. | |

5. EQUIPMENT UNDER TEST

5.1. DESCRIPTION OF EUT

| | | |
|--------------------------|-------------------------|--------|
| EUT Name | Tablet Computer | |
| Model | IQ Remote | |
| Technology | Bluetooth - Low Energy | |
| Transmit Frequency Range | 2402 MHz ~ 2480 MHz | |
| Modulation | GFSK | |
| Data Rate | BLE_1M | 1 Mbps |
| | BLE_2M | 2Mbps |
| Battery | DC 3.7V, 2400 mA | |
| DC Power Supply | DC 7 V, 1 A via adapter | |

5.2. CHANNEL LIST

| Channel | Frequency (MHz) | Channel | Frequency (MHz) | Channel | Frequency (MHz) | Channel | Frequency (MHz) |
|---------|-----------------|---------|-----------------|---------|-----------------|---------|-----------------|
| 0 | 2402 | 11 | 2424 | 22 | 2446 | 33 | 2468 |
| 1 | 2404 | 12 | 2426 | 23 | 2448 | 34 | 2470 |
| 2 | 2406 | 13 | 2428 | 24 | 2450 | 35 | 2472 |
| 3 | 2408 | 14 | 2430 | 25 | 2452 | 36 | 2474 |
| 4 | 2410 | 15 | 2432 | 26 | 2454 | 37 | 2476 |
| 5 | 2412 | 16 | 2434 | 27 | 2456 | 38 | 2478 |
| 6 | 2414 | 17 | 2436 | 28 | 2458 | 39 | 2480 |
| 7 | 2416 | 18 | 2438 | 29 | 2460 | / | / |
| 8 | 2418 | 19 | 2440 | 30 | 2462 | / | / |
| 9 | 2420 | 20 | 2442 | 31 | 2464 | / | / |
| 10 | 2422 | 21 | 2444 | 32 | 2468 | / | / |

5.3. MAXIMUM PEAK OUTPUT POWER

| Test Mode | Frequency (MHz) | Channel Number | Maximum Peak Output Power (dBm) |
|-----------|-----------------|----------------|---------------------------------|
| BLE_1M | 2402 ~ 2480 | 0-39[40] | 6.58 |
| BLE_2M | 2402 ~ 2480 | 0-39[40] | 6.30 |

5.4. TEST CHANNEL CONFIGURATION

| Test Mode | Test Channel | Frequency |
|-----------|--|------------------------------|
| BLE_1M | CH 0(Low Channel), CH 19(MID Channel), CH 39(High Channel) | 2402 MHz, 2440 MHz, 2480 MHz |
| BLE_2M | CH 0(Low Channel), CH 19(MID Channel), CH 39(High Channel) | 2402 MHz, 2440 MHz, 2480 MHz |

5.5. THE WORSE CASE POWER SETTING PARAMETER

| The Worst Case Power Setting Parameter under 2400 ~ 2483.5MHz Band | | | | |
|--|-----------------------------|-----------------------------|---------|---------|
| Test Software Version | | Putty | | |
| Test Mode | Test Software setting value | Test Software setting value | | |
| | | CH 0 | CH 19 | CH 39 |
| BLE_1M | 1 | Default | Default | Default |
| BLE_2M | 1 | Default | Default | Default |

5.6. DESCRIPTION OF AVAILABLE ANTENNAS

| Antenna | Frequency (MHz) | Antenna Type | MAX Antenna Gain (dBi) |
|---------|-----------------|--------------|------------------------|
| 1 | 2402-2480 | FPC Antenna | 2.4 |

| Test Mode | Transmit and Receive Mode | Description |
|-----------|--|--|
| BLE_1M | <input checked="" type="checkbox"/> 1TX, 1RX | Antenna 1 can be used as transmitting/receiving antenna. |
| BLE_1M | <input checked="" type="checkbox"/> 1TX, 1RX | Antenna 1 can be used as transmitting/receiving antenna. |

5.7. DESCRIPTION OF TEST SETUP

SUPPORT EQUIPMENT

| Item | Equipment | Brand Name | Model Name | P/N |
|------|-----------|------------|------------|-----|
| 1 | / | / | / | / |

I/O CABLES

| Cable No | Port | Connector Type | Cable Type | Cable Length(m) | Remarks |
|----------|------|----------------|------------|-----------------|---------|
| 1 | / | / | / | / | / |

ACCESSORY

| Item | Accessory | Brand Name | Model Name | Description |
|------|------------|------------|------------|--|
| 1 | AC Adapter | / | SW-070100A | Input:100-240V~50/60Hz 0.68A Max Output: DC 7.0V,1.0A 7.0W |

TEST SETUP

The EUT can work in an engineer mode with software.

SETUP DIAGRAM FOR TESTS

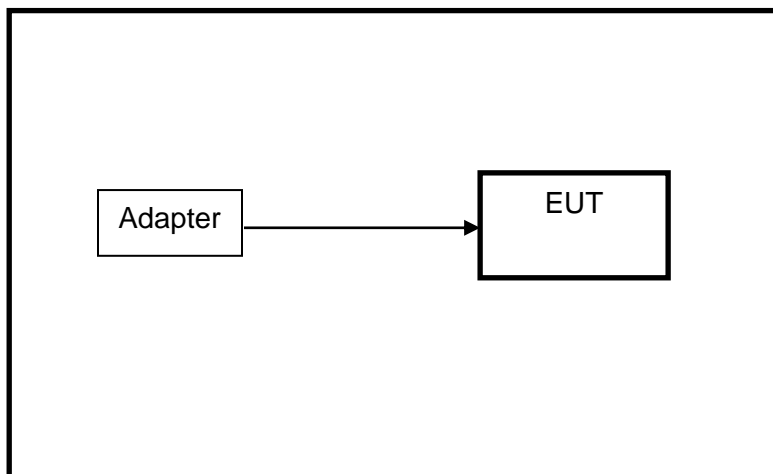

**6. MEASURING INSTRUMENT AND SOFTWARE USED**

| Conducted Emissions | | | | | |
|---------------------------------------|--------------|-----------|--------------|--------------|--------------|
| Equipment | Manufacturer | Model No. | Serial No. | Last Cal. | Due Date |
| EMI Test Receiver | R&S | ESR3 | 101961 | Oct.30, 2021 | Oct.29, 2022 |
| Two-Line V-Network | R&S | ENV216 | 101983 | Oct.30, 2021 | Oct.29, 2022 |
| Artificial Mains Networks | Schwarzbeck | NSLK 8126 | 8126465 | Oct.30, 2021 | Oct.29, 2022 |
| Software | | | | | |
| Description | | | Manufacturer | Name | Version |
| Test Software for Conducted Emissions | | | Farad | EZ-EMC | Ver. UL-3A1 |

| Radiated Emissions | | | | | |
|-----------------------------|--------------|-------------------------------------|---------------|---------------|---------------|
| Equipment | Manufacturer | Model No. | Serial No. | Last Cal. | Due Date |
| MXE EMI Receiver | KESIGHT | N9038A | MY56400036 | Oct.30, 2021 | Oct.29, 2022 |
| Hybrid Log Periodic Antenna | TDK | HLP-3003C | 130959 | Aug.02, 2021 | Aug.01, 2024 |
| Preamplifier | HP | 8447D | 2944A09099 | Oct.30, 2021 | Oct.29, 2022 |
| EMI Measurement Receiver | R&S | ESR26 | 101377 | Oct.30, 2021 | Oct.29, 2022 |
| Horn Antenna | TDK | HRN-0118 | 130940 | July 20, 2021 | July 19, 2024 |
| Preamplifier | TDK | PA-02-0118 | TRS-305-00067 | Oct.30, 2021 | Oct.29, 2022 |
| Horn Antenna | Schwarzbeck | BBHA9170 | 697 | July 20, 2021 | July 19, 2024 |
| Preamplifier | TDK | PA-02-2 | TRS-307-00003 | Oct.31, 2021 | Oct.30, 2022 |
| Preamplifier | TDK | PA-02-3 | TRS-308-00002 | Oct.31, 2021 | Oct.30, 2022 |
| Loop antenna | Schwarzbeck | 1519B | 00008 | Dec.14, 2021 | Dec.13, 2024 |
| Preamplifier | TDK | PA-02-001-3000 | TRS-302-00050 | Oct.31, 2021 | Oct.30, 2022 |
| High Pass Filter | Wi | WHKX10-2700-3000-18000-40SS | 23 | Oct.31, 2021 | Oct.30, 2022 |
| Band Reject Filter | Wainwright | WRCJV8-2350-2400-2483.5-2533.5-40SS | 4 | Oct.31, 2021 | Oct.30, 2022 |
| Software | | | | | |
| Description | | | Manufacturer | Name | Version |



| | | | |
|--------------------------------------|-------|--------|-------------|
| Test Software for Radiated Emissions | Farad | EZ-EMC | Ver. UL-3A1 |
|--------------------------------------|-------|--------|-------------|

| Other Instruments | | | | | |
|--------------------------|--------------|---------------------------|------------|--------------|--------------|
| Equipment | Manufacturer | Model No. | Serial No. | Last Cal. | Next Cal. |
| Signal Analyzer | R&S | FSV40 | 101118 | Oct.30, 2021 | Oct.29, 2022 |
| Dual Channel Power Meter | Keysight | N1912A | MY55416024 | Oct.30, 2021 | Oct.29, 2022 |
| Power Sensor | Keysight | USB Wideband Power Sensor | MY5100022 | Oct.30, 2021 | Oct.29, 2022 |

7. ANTENNA PORT TEST RESULTS

7.1. ON TIME AND DUTY CYCLE

LIMITS

None; for reporting purposes only.

PROCEDURE

Refer to ANSI C63.10-2013 clause 11.6 Zero – Span Spectrum Analyzer method.

TEST SETUP

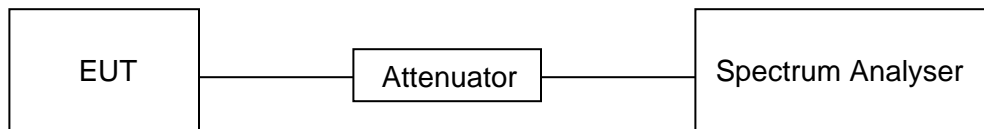

TEST ENVIRONMENT

| | | | |
|---------------------|---------|-------------------|----------------|
| Temperature | 24.3 °C | Relative Humidity | 59.5 % |
| Atmosphere Pressure | 101 kPa | Test Voltage | AC 120V, 60 Hz |

RESULTS

Please refer to appendix G.

7.2. 6 dB DTS BANDWIDTH AND 99 % OCCUPIED BANDWIDTH

LIMITS

| CFR 47FCC Part15 (15.247) Subpart C ISED RSS-247 ISSUE 2 | | | |
|---|-------------------------|------------------------------------|-----------------------|
| Section | Test Item | Limit | Frequency Range (MHz) |
| CFR 47 FCC 15.247(a)(2) ISED RSS-247 5.2 (a) | 6 dB Bandwidth | ≥ 500 kHz | 2400-2483.5 |
| ISED RSS-Gen Clause 6.7 | 99 % Occupied Bandwidth | None; for reporting purposes only. | 2400-2483.5 |

TEST PROCEDURE

Refer to ANSI C63.10-2013 clause 11.8 for DTS bandwidth and clause 6.9 for Occupied Bandwidth.

Connect the EUT to the spectrum analyser and use the following settings:

| | |
|------------------|---|
| Center Frequency | The center frequency of the channel under test |
| Frequency Span | For 6 dB Bandwidth: Enough to capture all products of the modulation carrier emission For 99 % Occupied Bandwidth: Between 1.5 times and 5.0 times the OBW |
| Detector | Peak |
| RBW | For 6 dB Bandwidth: 100 kHz For 99 % Occupied Bandwidth: 1 % to 5 % of the occupied bandwidth |
| VBW | For 6 dB Bandwidth: $\geq 3 \times$ RBW For 99 % Occupied Bandwidth: $\geq 3 \times$ RBW |
| Trace | Max hold |
| Sweep | Auto couple |

a) Use the 99 % power bandwidth function of the instrument, allow the trace to stabilize and report the measured bandwidth.

b) Allow the trace to stabilize and measure the maximum width of the emission that is constrained by the frequencies associated with the two outermost amplitude points (upper and lower frequencies) that are attenuated by 6 dB relative to the maximum level measured in the fundamental emission.

TEST SETUP

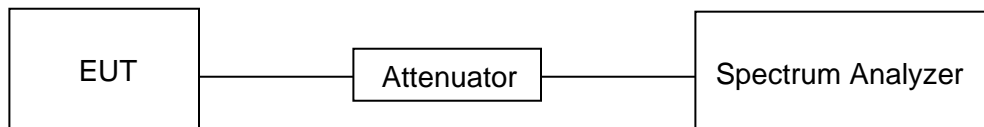



TEST ENVIRONMENT

| | | | |
|---------------------|---------|-------------------|----------------|
| Temperature | 24.3 °C | Relative Humidity | 59.5 % |
| Atmosphere Pressure | 101 kPa | Test Voltage | AC 120V, 60 Hz |

RESULTS

Please refer to appendix A & B.

7.3. CONDUCTED OUTPUT POWER

I/O CABLES

| Cable No | Port | Connector Type | Cable Type | Cable Length(m) | Remarks |
|----------|------|----------------|------------|-----------------|---------|
| 1 | / | / | / | / | / |

LIMITS

| CFR 47 FCC Part15 (15.247) Subpart C ISED RSS-247 ISSUE 2 | | | |
|--|-----------------------------|------------------|-----------------------|
| Section | Test Item | Limit | Frequency Range (MHz) |
| CFR 47 FCC 15.247(b)(3) ISED RSS-247 5.4 (d) | Peak Conducted Output Power | 1 watt or 30 dBm | 2400-2483.5 |

TEST PROCEDURE

Connect the EUT to a low loss RF cable from the antenna port to the power sensor (video bandwidth is greater than the occupied bandwidth).
Measure peak emission level, the indicated level is the peak output power, after any corrections for external attenuators and cables.

TEST SETUP

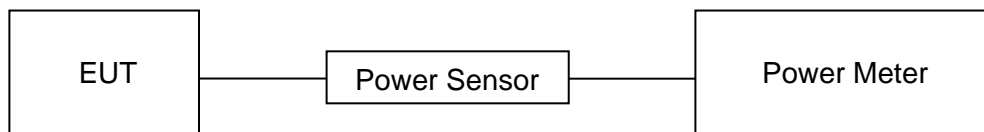

TEST ENVIRONMENT

| | | | |
|---------------------|---------|-------------------|----------------|
| Temperature | 24.3 °C | Relative Humidity | 59.5 % |
| Atmosphere Pressure | 101 kPa | Test Voltage | AC 120V, 60 Hz |

RESULTS

Please refer to appendix C.

7.4. POWER SPECTRAL DENSITY

LIMITS

| CFR 47 FCC Part15 (15.247) Subpart C ISED RSS-247 ISSUE 2 | | | |
|--|------------------------|-------------------------|-----------------------|
| Section | Test Item | Limit | Frequency Range (MHz) |
| CFR 47 FCC §15.247 (e) ISED RSS-247 5.2 (b) | Power Spectral Density | 8 dBm in any 3 kHz band | 2400-2483.5 |

TEST PROCEDURE

Refer to ANSI C63.10-2013 clause 11.10.

Connect the EUT to the spectrum analyser and use the following settings:

| | |
|------------------|--|
| Center Frequency | The center frequency of the channel under test |
| Detector | Peak |
| RBW | $3 \text{ kHz} \leq \text{RBW} \leq 100 \text{ kHz}$ |
| VBW | $\geq 3 \times \text{RBW}$ |
| Span | 1.5 x DTS bandwidth |
| Trace | Max hold |
| Sweep time | Auto couple |

Allow trace to fully stabilize and use the peak marker function to determine the maximum amplitude level within the RBW.

If measured value exceeds limit, reduce RBW (no less than 3 kHz) and repeat.

TEST SETUP

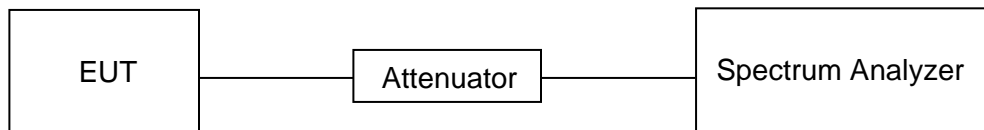

TEST ENVIRONMENT

| | | | |
|---------------------|---------|-------------------|----------------|
| Temperature | 24.3 °C | Relative Humidity | 59.5 % |
| Atmosphere Pressure | 101 kPa | Test Voltage | AC 120V, 60 Hz |



RESULTS

Please refer to appendix D.

7.5. CONDUCTED BANDEGE AND SPURIOUS EMISSIONS

LIMITS

| CFR 47 FCC Part15 (15.247) Subpart C ISED RSS-247 ISSUE 2 | | |
|--|---|---|
| Section | Test Item | Limit |
| CFR 47 FCC §15.247 (d) ISED RSS-247 5.5 | Conducted Bandedge and Spurious Emissions | at least 20 dB below that in the 100 kHz bandwidth within the band that contains the highest level of the desired power |

TEST PROCEDURE

Refer to ANSI C63.10-2013 clause 11.11 and 11.13.

Connect the EUT to the spectrum analyser and use the following settings for reference level measurement:

| | |
|------------------|--|
| Center Frequency | The center frequency of the channel under test |
| Detector | Peak |
| RBW | 100 kHz |
| VBW | $\geq 3 \times \text{RBW}$ |
| Span | 1.5 x DTS bandwidth |
| Trace | Max hold |
| Sweep time | Auto couple. |

Allow trace to fully stabilize and use the peak marker function to determine the maximum PSD level.

Change the settings for emission level measurement:

| | |
|--------------------|---|
| Span | Set the center frequency and span to encompass frequency range to be measured |
| Detector | Peak |
| RBW | 100 kHz |
| VBW | $\geq 3 \times \text{RBW}$ |
| measurement points | $\geq \text{span}/\text{RBW}$ |
| Trace | Max hold |
| Sweep time | Auto couple. |

Allow trace to fully stabilize and use the peak marker function to determine the maximum PSD level. Ensure that the amplitude of all unwanted emissions outside of the authorized frequency band (excluding restricted frequency bands) is attenuated by at least the minimum requirements specified in 11.11.



TEST SETUP

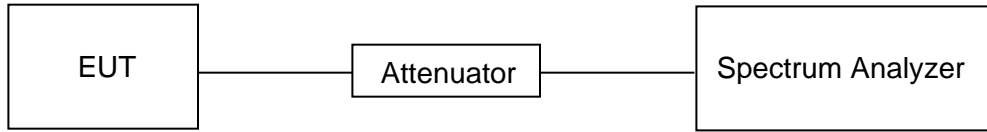

TEST ENVIRONMENT

| | | | |
|---------------------|---------|-------------------|----------------|
| Temperature | 24.3 °C | Relative Humidity | 59.5 % |
| Atmosphere Pressure | 101 kPa | Test Voltage | AC 120V, 60 Hz |

RESULTS

Please refer to appendix E & F.

8. RADIATED TEST RESULTS

LIMITS

Please refer to CFR 47 FCC §15.205 and §15.209.

Please refer to ISED RSS-GEN Clause 8.9 and Clause 8.10.

Radiation Disturbance Test Limit for FCC (Class B) (9 kHz-1 GHz)

| Emissions radiated outside of the specified frequency bands above 30 MHz | | | |
|--|------------------------------------|--------------------------------------|---------|
| Frequency Range (MHz) | Field Strength Limit (uV/m) at 3 m | Field Strength Limit (dBuV/m) at 3 m | |
| | | Quasi-Peak | |
| 30 - 88 | 100 | 40 | |
| 88 - 216 | 150 | 43.5 | |
| 216 - 960 | 200 | 46 | |
| Above 960 | 500 | 54 | |
| Above 1000 | 500 | Peak | Average |
| | | 74 | 54 |

| FCC Emissions radiated outside of the specified frequency bands below 30 MHz | | |
|--|-----------------------------------|-------------------------------|
| Frequency (MHz) | Field strength (microvolts/meter) | Measurement distance (meters) |
| 0.009-0.490 | 2400/F(kHz) | 300 |
| 0.490-1.705 | 24000/F(kHz) | 30 |
| 1.705-30.0 | 30 | 30 |

ISED General field strength limits at frequencies below 30 MHz

| Table 6 – General field strength limits at frequencies below 30 MHz | | |
|---|--|--------------------------|
| Frequency | Magnetic field strength (H-Field) (µA/m) | Measurement distance (m) |
| 9 - 490 kHz ^{Note 1} | 6.37/F (F in kHz) | 300 |
| 490 - 1705 kHz | 63.7/F (F in kHz) | 30 |
| 1.705 - 30 MHz | 0.08 | 30 |

Note 1: The emission limits for the ranges 9-90 kHz and 110-490 kHz are based on measurements employing a linear average detector.



ISED Restricted bands please refer to ISED RSS-GEN Clause 8.10

| Table 7 – Restricted frequency bands ^{Note 1} | | |
|--|-----------------------|---------------|
| MHz | MHz | GHz |
| 0.090 - 0.110 | 149.9 - 150.05 | 9.0 - 9.2 |
| 0.495 - 0.505 | 156.52475 - 156.52525 | 9.3 - 9.5 |
| 2.1735 - 2.1905 | 156.7 - 156.9 | 10.6 - 12.7 |
| 3.020 - 3.020 | 162.0125 - 167.17 | 13.25 - 13.4 |
| 4.125 - 4.128 | 167.72 - 173.2 | 14.47 - 14.5 |
| 4.17725 - 4.17775 | 240 - 285 | 15.35 - 16.2 |
| 4.20725 - 4.20775 | 322 - 335.4 | 17.7 - 21.4 |
| 5.677 - 5.683 | 399.9 - 410 | 22.01 - 23.12 |
| 6.215 - 6.218 | 608 - 614 | 23.6 - 24.0 |
| 6.26775 - 6.26825 | 960 - 1427 | 31.2 - 31.8 |
| 6.31175 - 6.31225 | 1435 - 1626.5 | 36.43 - 36.5 |
| 8.291 - 8.294 | 1645.5 - 1646.5 | Above 38.6 |
| 8.362 - 8.366 | 1660 - 1710 | |
| 8.37625 - 8.38675 | 1718.8 - 1722.2 | |
| 8.41425 - 8.41475 | 2200 - 2300 | |
| 12.29 - 12.293 | 2310 - 2390 | |
| 12.51975 - 12.52025 | 2483.5 - 2500 | |
| 12.57675 - 12.57725 | 2695 - 2900 | |
| 13.36 - 13.41 | 3260 - 3267 | |
| 16.42 - 16.423 | 3332 - 3339 | |
| 16.80475 - 16.80525 | 3345.8 - 3358 | |
| 16.80425 - 16.80475 | 3500 - 4400 | |
| 25.5 - 25.67 | 4500 - 5150 | |
| 37.5 - 38.25 | 5350 - 5400 | |
| 73 - 74.6 | 7250 - 7750 | |
| 74.8 - 75.2 | 8025 - 8500 | |
| 108 - 138 | | |

Note 1: Certain frequency bands listed in table 7 and in bands above 38.6 GHz are designated for licence-exempt applications. These frequency bands and the requirements that apply to related devices are set out in the 200 and 300 series of RSSs.

FCC Restricted bands of operation refer to FCC §15.205 (a):

| MHz | MHz | MHz | GHz |
|--------------------------|---------------------|---------------|------------------|
| 0.090-0.110 | 16.42-16.423 | 399.9-410 | 4.5-5.15 |
| ¹ 0.495-0.505 | 16.69475-16.69525 | 608-614 | 5.35-5.46 |
| 2.1735-2.1905 | 16.80425-16.80475 | 960-1240 | 7.25-7.75 |
| 4.125-4.128 | 25.5-25.67 | 1300-1427 | 8.025-8.5 |
| 4.17725-4.17775 | 37.5-38.25 | 1435-1626.5 | 9.0-9.2 |
| 4.20725-4.20775 | 73-74.6 | 1645.5-1646.5 | 9.3-9.5 |
| 6.215-6.218 | 74.8-75.2 | 1660-1710 | 10.6-12.7 |
| 6.26775-6.26825 | 108-121.94 | 1718.8-1722.2 | 13.25-13.4 |
| 6.31175-6.31225 | 123-138 | 2200-2300 | 14.47-14.5 |
| 8.291-8.294 | 149.9-150.05 | 2310-2390 | 15.35-16.2 |
| 8.362-8.366 | 156.52475-156.52525 | 2483.5-2500 | 17.7-21.4 |
| 8.37625-8.38675 | 156.7-156.9 | 2690-2900 | 22.01-23.12 |
| 8.41425-8.41475 | 162.0125-167.17 | 3260-3267 | 23.6-24.0 |
| 12.29-12.293 | 167.72-173.2 | 3332-3339 | 31.2-31.8 |
| 12.51975-12.52025 | 240-285 | 3345.8-3358 | 36.43-36.5 |
| 12.57675-12.57725 | 322-335.4 | 3600-4400 | (²) |
| 13.36-13.41 | | | |

Note: ¹Until February 1, 1999, this restricted band shall be 0.490-0.510 MHz.

²Above 38.6c

TEST SETUP AND PROCEDURE

Below 30 MHz

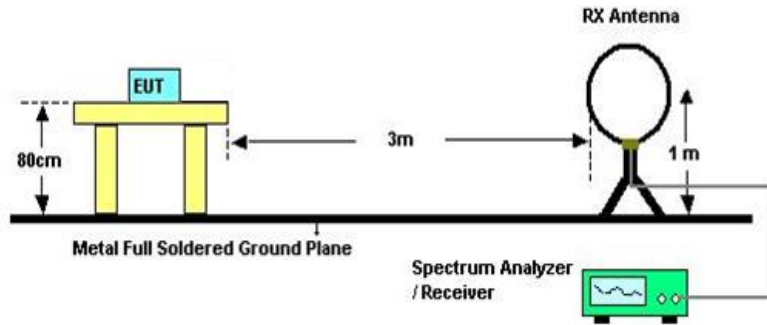

The setting of the spectrum analyser

| | |
|-------|--|
| RBW | 200 Hz (From 9 kHz to 0.15 MHz)/ 9 kHz (From 0.15 MHz to 30 MHz) |
| VBW | 200 Hz (From 9 kHz to 0.15 MHz)/ 9 kHz (From 0.15 MHz to 30 MHz) |
| Sweep | Auto |
| Trace | Max hold |

1. The testing follows the guidelines in ANSI C63.10-2013 clause 6.4.
2. The EUT was arranged to its worst case and then turntable (from 0 degree to 360 degrees) to find the maximum reading. A pre-amp and a high pass filter are used for the test in order to get better signal level. Both Horizontal, Face-on and Face-off polarizations of the antenna are set to make the measurement.
3. The EUT was placed on a turntable with 80 cm above ground.
4. The EUT was set 3 meters from the interference receiving antenna, which was mounted on the top of a 1 m height antenna tower.
5. The radiated emission limits are based on measurements employing a CISPR quasi-peak detector except for the frequency bands 9-90 kHz, 110-490 kHz and above 1000 MHz. Radiated emission limits in these three bands are based on measurements employing an average detector.
6. For measurement below 1 GHz, the initial step in collecting conducted emission data is a spectrum analyzer peak detector mode pre-scanning the measurement frequency range. Significant peaks are then marked and then Quasi Peak and average detector mode re-measured. If the emission level of the EUT measured by the peak detector is 3 dB lower than the applicable limit, the peak emission level will be reported. Otherwise, the emission measurement will be repeated using the quasi-peak and average detector and reported.
7. Although these tests were performed other than open field site, adequate comparison measurements were confirmed against 30m open field site. Therefore sufficient tests were made to demonstrate that the alternative site produces results that correlate with the ones of tests made in an open field site based on KDB 414788.
8. The limits in CFR 47, Part 15, Subpart C, paragraph 15.209 (a), are identical to those in RSS-GEN Section 8.9, Table 6, since the measurements are performed in terms of magnetic field strength and converted to electric field strength levels (as reported in the table) using the free space impedance of 377Ω ; For example, the measurement frequency X kHz resulted in a level of Y dBuV/m, which is equivalent to $Y-51.5 = Z$ dBuA/m, which has the same margin, W dB, to the corresponding RSS-GEN Table 6 limit as it has to be 15.209(a) limit.

Below 1 GHz and above 30 MHz

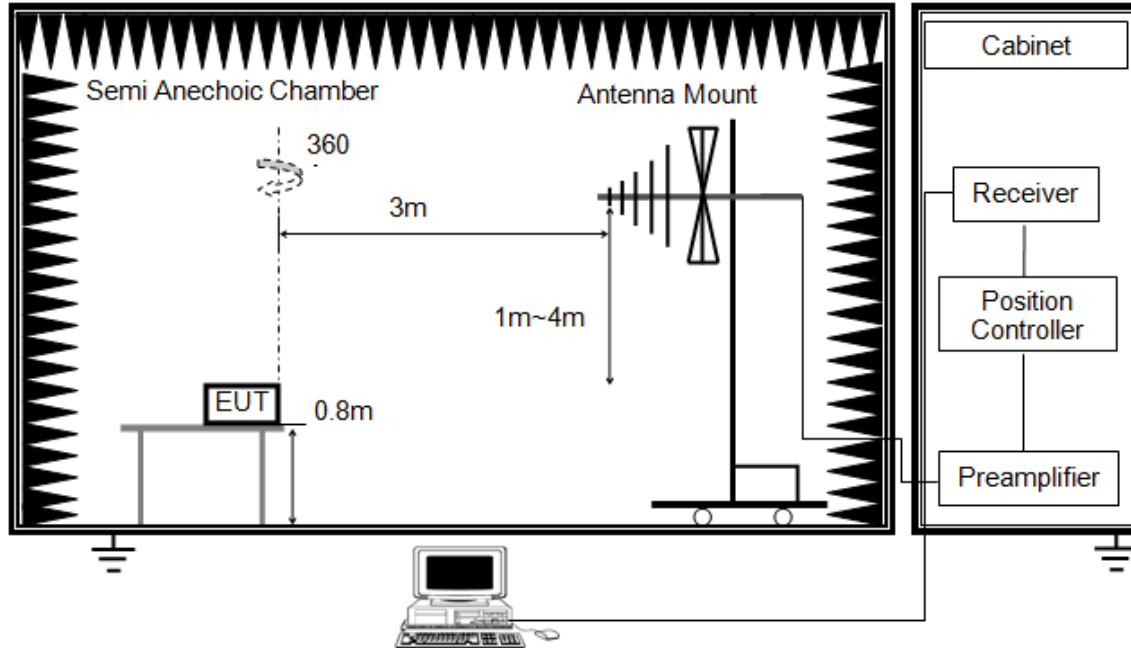

The setting of the spectrum analyser

| | |
|----------|----------|
| RBW | 120 kHz |
| VBW | 300 kHz |
| Sweep | Auto |
| Detector | Peak/QP |
| Trace | Max hold |

1. The testing follows the guidelines in ANSI C63.10-2013 clause 6.5.
2. The EUT was arranged to its worst case and then tune the antenna tower (from 1 m to 4 m) and turntable (from 0 degree to 360 degrees) to find the maximum reading. A pre-amp and a high pass filter are used for the test in order to get better signal level. Both horizontal and vertical polarizations of the antenna are set to make the measurement.
3. The EUT was placed on a turntable with 80 cm above ground.
4. The EUT was set 3 meters from the interference receiving antenna, which was mounted on the top of a variable height antenna tower.
5. For measurement below 1 GHz, the initial step in collecting conducted emission data is a spectrum analyzer peak detector mode pre-scanning the measurement frequency range. Significant peaks are then marked and then Quasi Peak detector mode re-measured. If the emission level of the EUT measured by the peak detector is 3 dB lower than the applicable limit, the peak emission level will be reported. Otherwise, the emission measurement will be repeated using the quasi-peak detector and reported.

Above 1 GHz

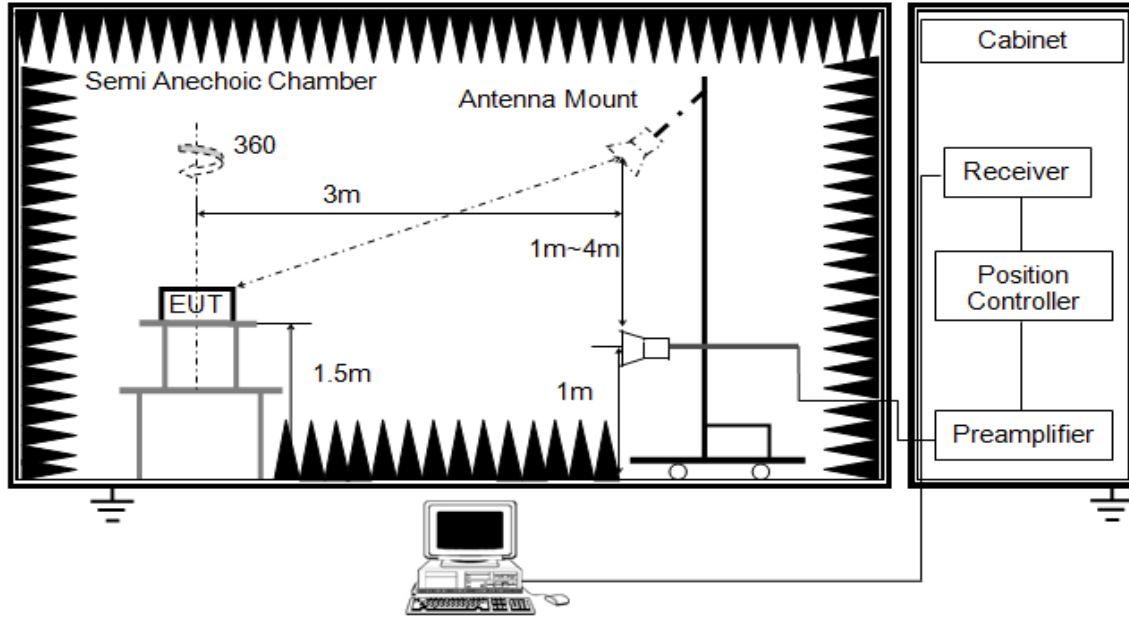

The setting of the spectrum analyser

| | |
|----------|--------------------------------|
| RBW | 1 MHz |
| VBW | PEAK: 3 MHz AVG: see note 6 |
| Sweep | Auto |
| Detector | Peak |
| Trace | Max hold |

1. The testing follows the guidelines in ANSI C63.10-2013 clause 6.6.
2. The EUT was arranged to its worst case and then tune the antenna tower (from 1 m to 4 m) and turntable (from 0 degree to 360 degrees) to find the maximum reading. A pre-amp and a high pass filter are used for the test in order to get better signal level. Both horizontal and vertical polarizations of the antenna are set to make the measurement.
3. The EUT was placed on a turntable with 1.5 m above ground.
4. The EUT was set 3 meters from the interference receiving antenna, which was mounted on the top of a variable height antenna tower.
5. For measurement above 1 GHz, the emission measurement will be measured by the peak detector. This peak level, once corrected, must comply with the limit specified in Section 15.209.
6. For measurements above 1 GHz the resolution bandwidth is set to 1 MHz, then the video bandwidth is set to 3 MHz for peak measurements and 1 MHz resolution bandwidth with 1/T video bandwidth with peak detector for average measurements. For the Duty Cycle please refer to clause 7.1.ON TIME AND DUTY CYCLE.

X axis, Y axis, Z axis positions:

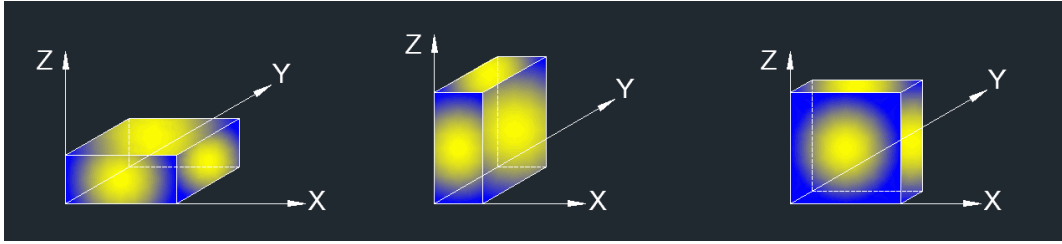

Note 1: For all radiated test, EUT in each of three orthogonal axis emissions had been tested, but only the worst case (X axis) data recorded in the report.

Note 2: The EUT was fully exercised with external accessories during the test. In the case of multiple accessory external ports, an external accessory shall be connected to one of each type of port.

TEST ENVIRONMENT

| | | | |
|---------------------|---------|-------------------|----------------|
| Temperature | 24.3 °C | Relative Humidity | 61 % |
| Atmosphere Pressure | 101 kPa | Test Voltage | AC 120V, 60 Hz |

RESULTS

8.1. RESTRICTED BANDEDGE

8.1.1. BLE_1M MODE

RESTRICTED BANDEDGE (LOW CHANNEL, HORIZONTAL)

PEAK

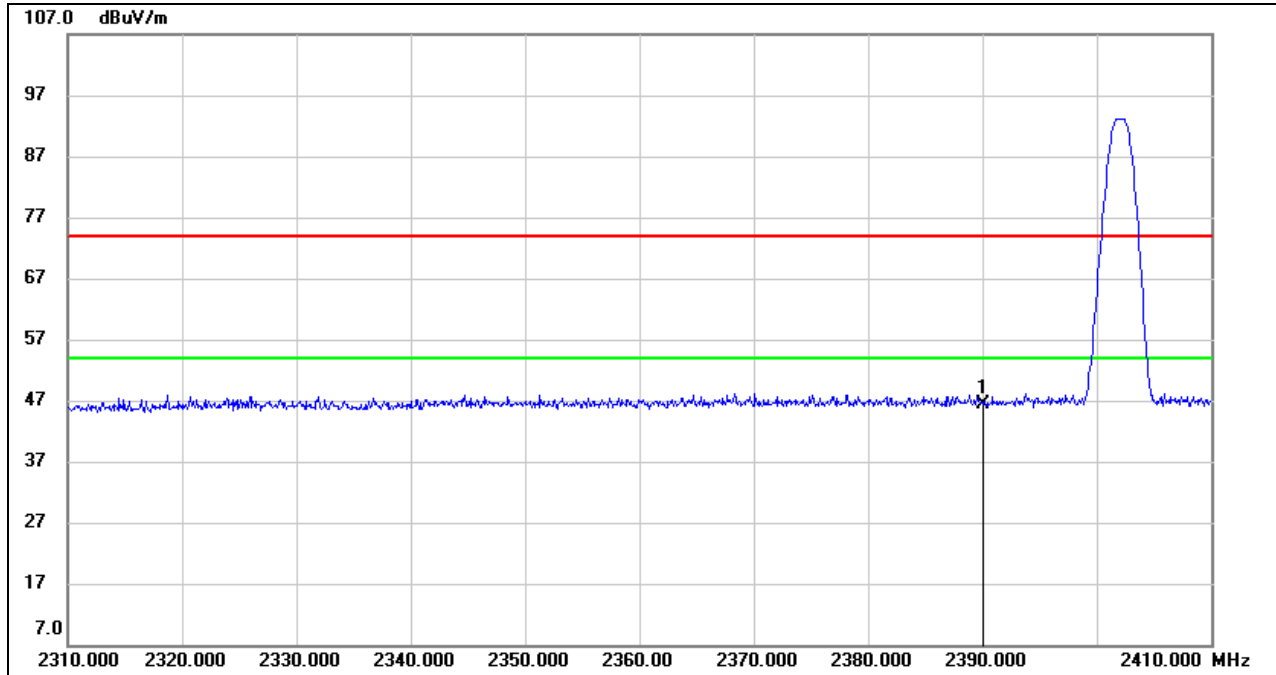

| No. | Frequency (MHz) | Reading (dBuV) | Correct (dB/m) | Result (dBuV/m) | Limit (dBuV/m) | Margin (dB) | Remark |
|-----|--------------------|-------------------|-------------------|--------------------|-------------------|----------------|--------|
| 1 | 2390.000 | 13.63 | 32.66 | 46.29 | 74.00 | -27.71 | peak |

- Note: 1. Measurement = Reading Level + Correct Factor.
 2. If Peak Result complies with AV limit, AV Result is deemed to comply with AV limit.
 3. Peak: Peak detector.
 4. Only the worst data was recorded, if it complies with the limit, the other emissions deemed to comply with the limit.

RESTRICTED BANDEDGE (LOW CHANNEL, VERTICAL)

PEAK

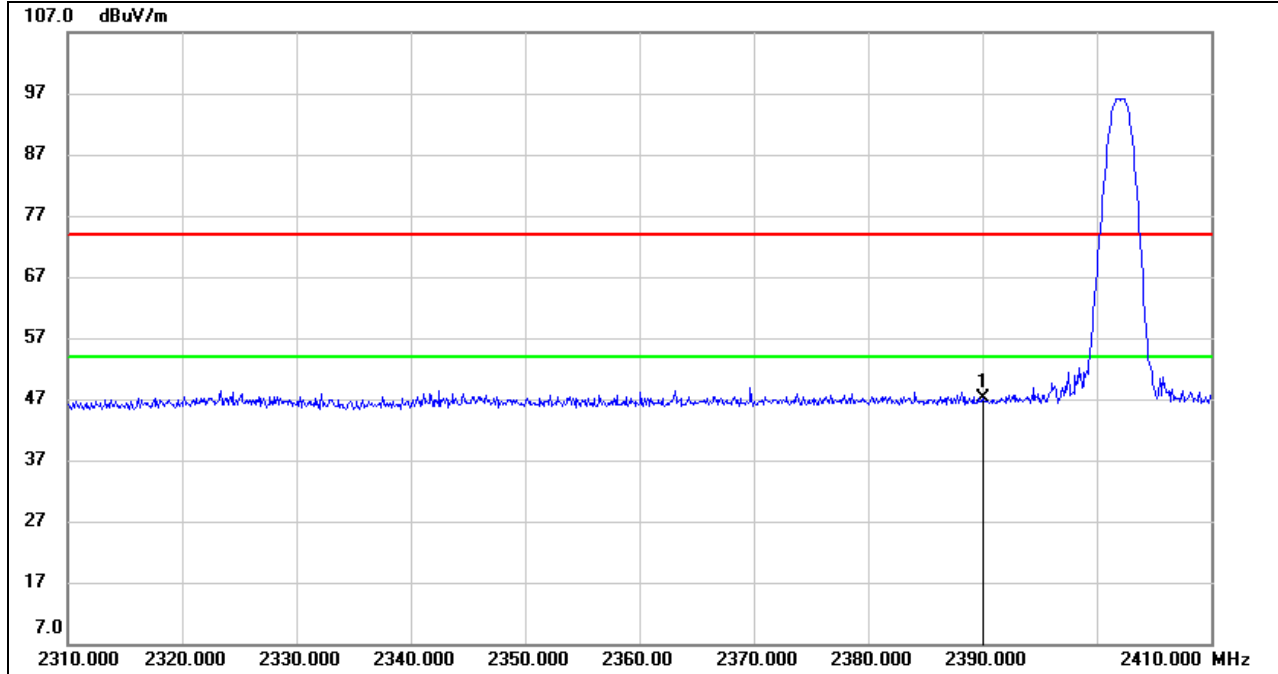

| No. | Frequency (MHz) | Reading (dBuV) | Correct (dB/m) | Result (dBuV/m) | Limit (dBuV/m) | Margin (dB) | Remark |
|-----|-----------------|----------------|----------------|-----------------|----------------|-------------|--------|
| 1 | 2390.000 | 14.48 | 32.66 | 47.14 | 74.00 | -26.86 | peak |

- Note: 1. Measurement = Reading Level + Correct Factor.
 2. If Peak Result complies with AV limit, AV Result is deemed to comply with AV limit.
 3. Peak: Peak detector.
 4. Only the worst data was recorded, if it complies with the limit, the other emissions deemed to comply with the limit.



RESTRICTED BANDEDGE (HIGH CHANNEL, VERTICAL)

PEAK

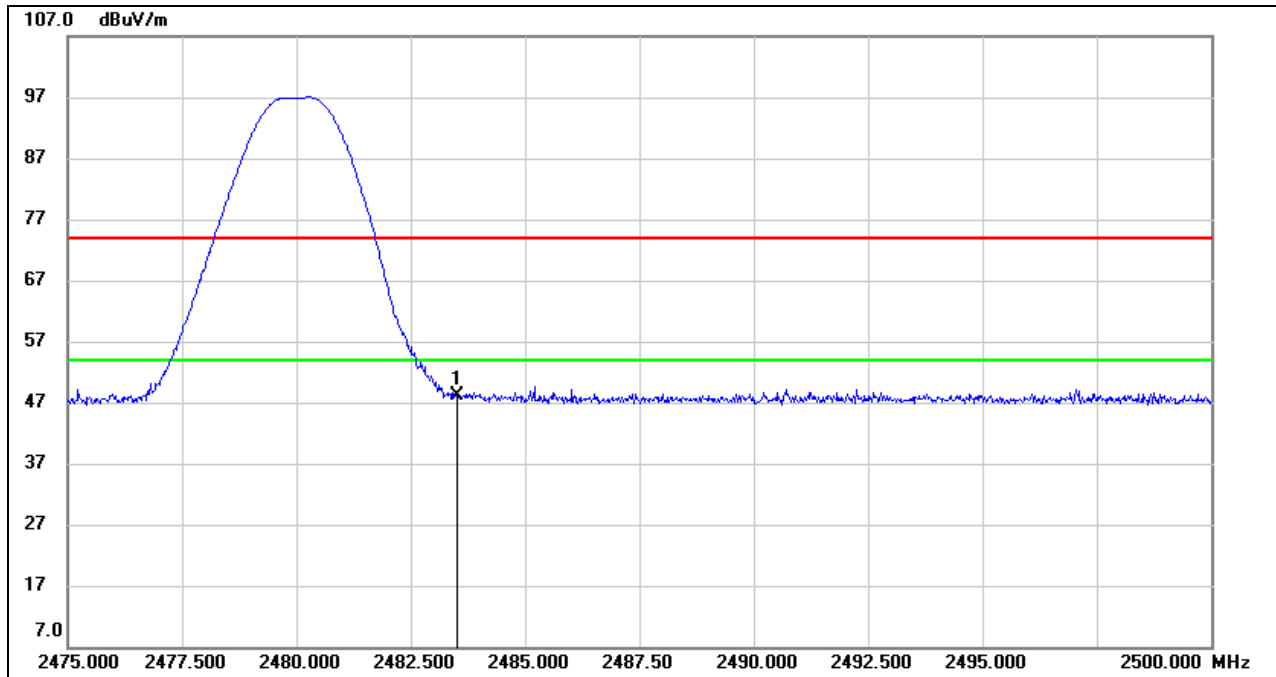

| No. | Frequency (MHz) | Reading (dBuV) | Correct (dB/m) | Result (dBuV/m) | Limit (dBuV/m) | Margin (dB) | Remark |
|-----|-----------------|----------------|----------------|-----------------|----------------|-------------|--------|
| 1 | 2483.500 | 15.04 | 33.10 | 48.14 | 74.00 | -25.86 | peak |

- Note:
1. Measurement = Reading Level + Correct Factor.
 2. If Peak Result complies with AV limit, AV Result is deemed to comply with AV limit.
 3. Peak: Peak detector.
 4. Only the worst data was recorded, if it complies with the limit, the other emissions deemed to comply with the limit.

Note: All the polarities (Vertical & Horizontal) had been tested, only the worst data was recorded in the report.

8.1.2. BLE_2M MODE

RESTRICTED BANDEDGE (LOW CHANNEL, VERTICAL)

PEAK

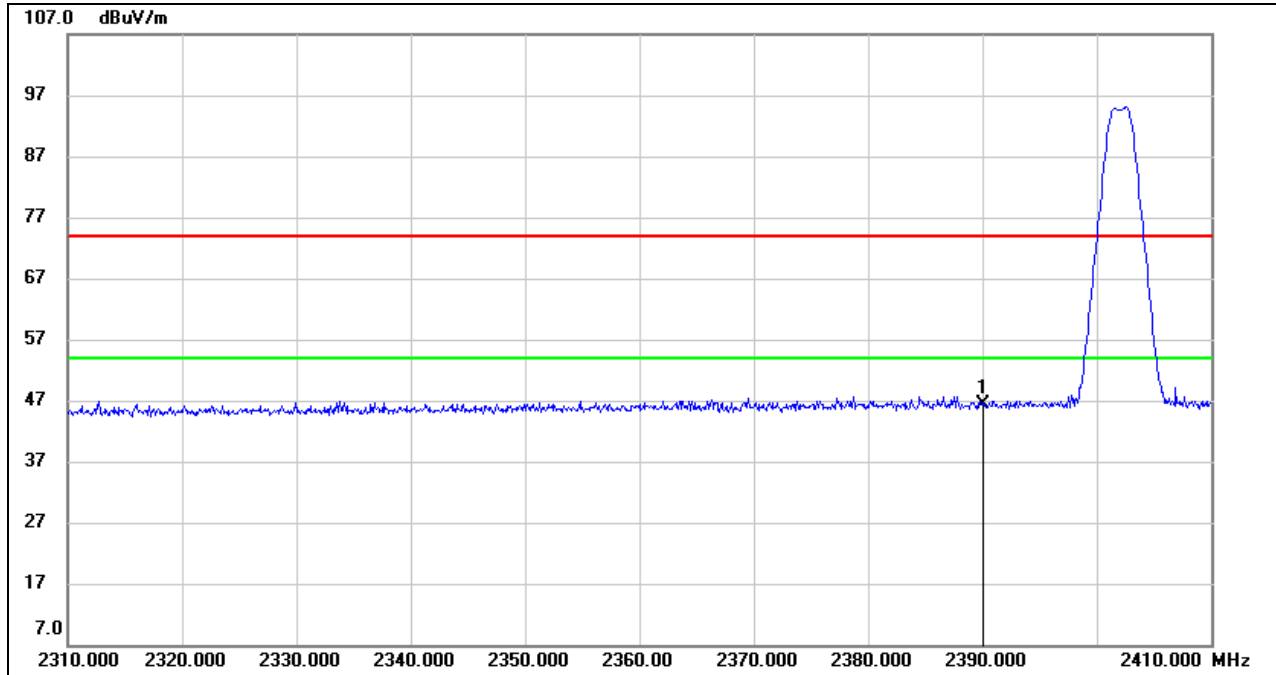

| No. | Frequency (MHz) | Reading (dBuV) | Correct (dB/m) | Result (dBuV/m) | Limit (dBuV/m) | Margin (dB) | Remark |
|-----|--------------------|-------------------|-------------------|--------------------|-------------------|----------------|--------|
| 1 | 2390.000 | 13.65 | 32.66 | 46.31 | 74.00 | -27.69 | peak |

- Note:
1. Measurement = Reading Level + Correct Factor.
 2. If Peak Result complies with AV limit, AV Result is deemed to comply with AV limit.
 3. Peak: Peak detector.
 4. Only the worst data was recorded, if it complies with the limit, the other emissions deemed to comply with the limit.



RESTRICTED BANDEDGE (HIGH CHANNEL, VERTICAL)

PEAK

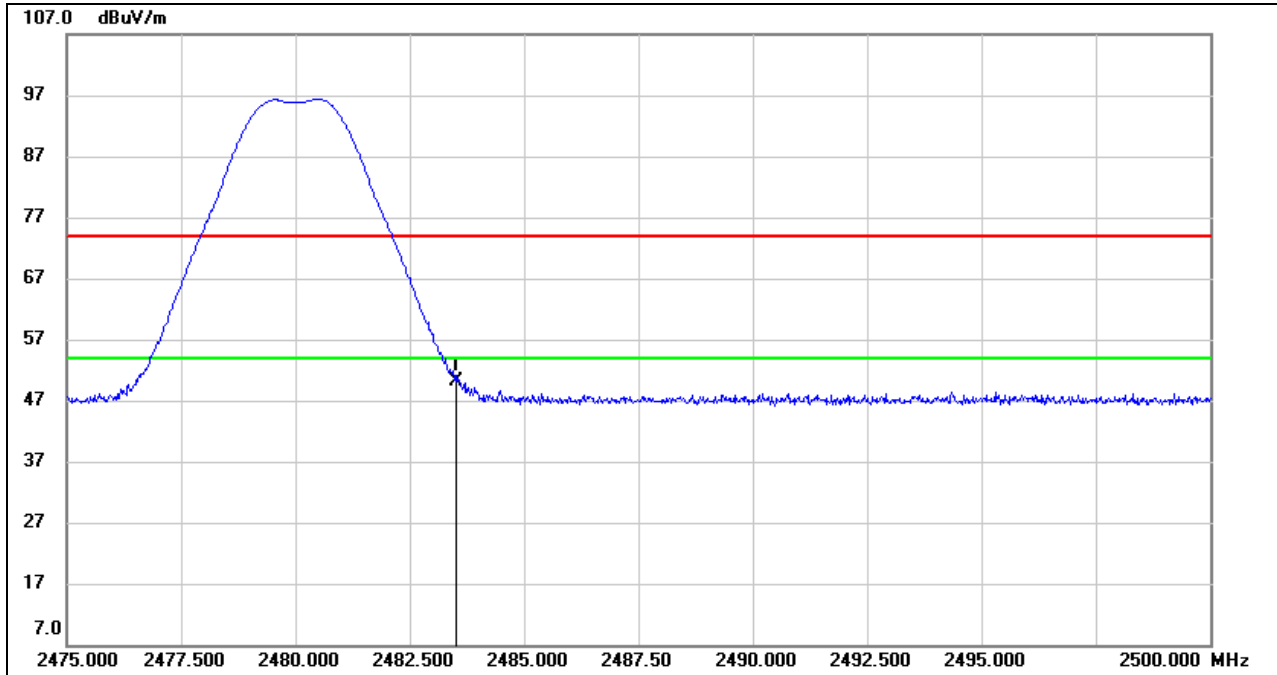

| No. | Frequency (MHz) | Reading (dBuV) | Correct (dB/m) | Result (dBuV/m) | Limit (dBuV/m) | Margin (dB) | Remark |
|-----|-----------------|----------------|----------------|-----------------|----------------|-------------|--------|
| 1 | 2483.500 | 16.96 | 33.10 | 50.06 | 74.00 | -23.94 | peak |

- Note: 1. Measurement = Reading Level + Correct Factor.
 2. If Peak Result complies with AV limit, AV Result is deemed to comply with AV limit.
 3. Peak: Peak detector.
 4. Only the worst data was recorded, if it complies with the limit, the other emissions deemed to comply with the limit.

Note: All the polarities (Vertical & Horizontal) had been tested, only the worst data was recorded in the report.

8.2. SPURIOUS EMISSIONS (1 GHz ~ 3 GHz)

8.2.1. BLE_1M MODE

HARMONICS AND SPURIOUS EMISSIONS (LOW CHANNEL, HORIZONTAL)

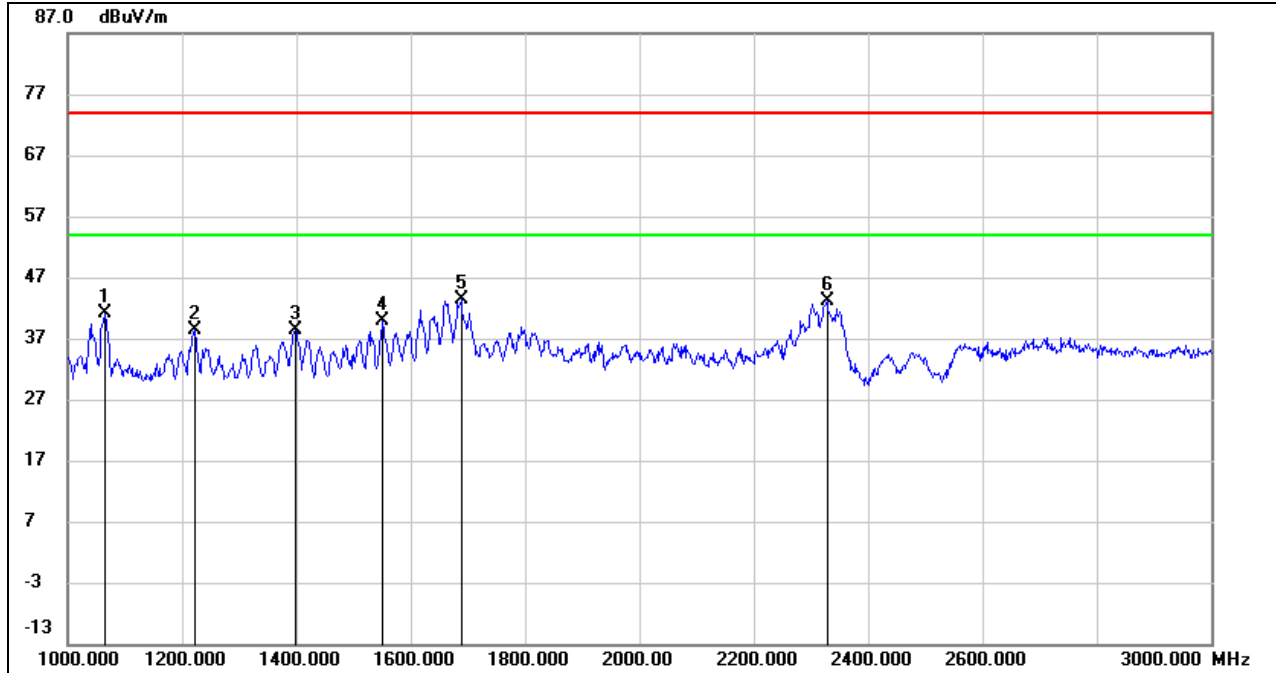

| No. | Frequency (MHz) | Reading (dBuV) | Correct (dB/m) | Result (dBuV/m) | Limit (dBuV/m) | Margin (dB) | Remark |
|-----|-----------------|----------------|----------------|-----------------|----------------|-------------|--------|
| 1 | 1066.000 | 55.75 | -14.62 | 41.13 | 74.00 | -32.87 | peak |
| 2 | 1222.000 | 52.05 | -13.64 | 38.41 | 74.00 | -35.59 | peak |
| 3 | 1398.000 | 51.43 | -13.07 | 38.36 | 74.00 | -35.64 | peak |
| 4 | 1550.000 | 51.91 | -12.13 | 39.78 | 74.00 | -34.22 | peak |
| 5 | 1688.000 | 54.71 | -11.29 | 43.42 | 74.00 | -30.58 | peak |
| 6 | 2328.000 | 52.42 | -9.23 | 43.19 | 74.00 | -30.81 | peak |

- Note: 1. Peak Result = Reading Level + Correct Factor.
 2. If Peak Result complies with AV limit, AV Result is deemed to comply with AV limit.
 3. Peak: Peak detector.
 4. Filter losses were only considered in then spurious frequency bands and the authorized band was not corrected for Band reject filter losses.
 5. Proper operation of the transmitter prior to adding the filter to the measurement chain.

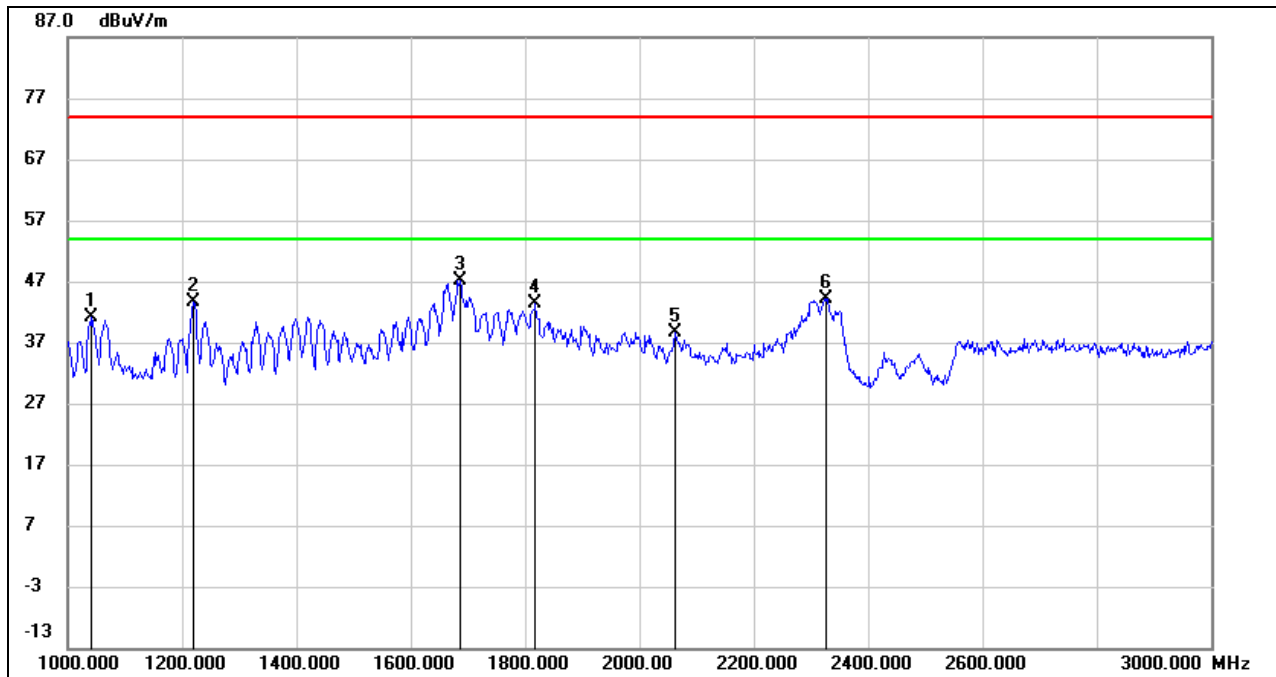
HARMONICS AND SPURIOUS EMISSIONS (LOW CHANNEL, VERTICAL)

| No. | Frequency (MHz) | Reading (dBuV) | Correct (dB/m) | Result (dBuV/m) | Limit (dBuV/m) | Margin (dB) | Remark |
|-----|-----------------|----------------|----------------|-----------------|----------------|-------------|--------|
| 1 | 1040.000 | 56.01 | -14.79 | 41.22 | 74.00 | -32.78 | peak |
| 2 | 1220.000 | 57.39 | -13.64 | 43.75 | 74.00 | -30.25 | peak |
| 3 | 1686.000 | 58.48 | -11.30 | 47.18 | 74.00 | -26.82 | peak |
| 4 | 1818.000 | 53.89 | -10.62 | 43.27 | 74.00 | -30.73 | peak |
| 5 | 2062.000 | 49.28 | -10.58 | 38.70 | 74.00 | -35.30 | peak |
| 6 | 2326.000 | 53.45 | -9.23 | 44.22 | 74.00 | -29.78 | peak |

- Note:
1. Peak Result = Reading Level + Correct Factor.
 2. If Peak Result complies with AV limit, AV Result is deemed to comply with AV limit.
 3. Peak: Peak detector.
 4. Filter losses were only considered in then spurious frequency bands and the authorized band was not corrected for Band reject filter losses.
 5. Proper operation of the transmitter prior to adding the filter to the measurement chain.

HARMONICS AND SPURIOUS EMISSIONS (MID CHANNEL, HORIZONTAL)

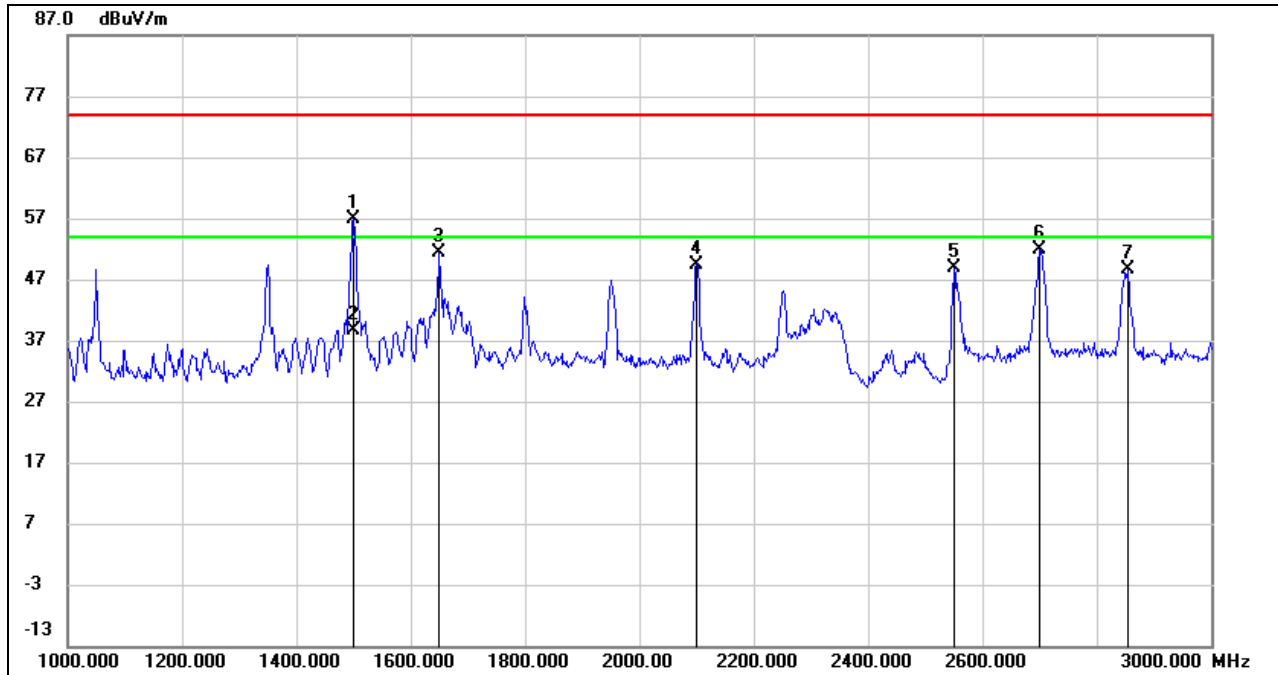

| No. | Frequency (MHz) | Reading (dBuV) | Correct (dB/m) | Result (dBuV/m) | Limit (dBuV/m) | Margin (dB) | Remark |
|-----|-----------------|----------------|----------------|-----------------|----------------|-------------|--------|
| 1 | 1500.000 | 69.18 | -12.41 | 56.77 | 74.00 | -17.23 | peak |
| 2 | 1500.000 | 51.03 | -12.41 | 38.62 | 54.00 | -15.38 | AVG |
| 3 | 1650.000 | 62.90 | -11.53 | 51.37 | 74.00 | -22.63 | peak |
| 4 | 2100.000 | 59.84 | -10.34 | 49.50 | 74.00 | -24.50 | peak |
| 5 | 2550.000 | 57.58 | -8.64 | 48.94 | 74.00 | -25.06 | peak |
| 6 | 2700.000 | 60.09 | -8.12 | 51.97 | 74.00 | -22.03 | peak |
| 7 | 2854.000 | 56.06 | -7.52 | 48.54 | 74.00 | -25.46 | peak |

- Note:
1. Peak Result = Reading Level + Correct Factor.
 2. If Peak Result complies with AV limit, AV Result is deemed to comply with AV limit.
 3. Peak: Peak detector.
 4. Filter losses were only considered in then spurious frequency bands and the authorized band was not corrected for Band reject filter losses.
 5. Proper operation of the transmitter prior to adding the filter to the measurement chain.

HARMONICS AND SPURIOUS EMISSIONS (MID CHANNEL, VERTICAL)

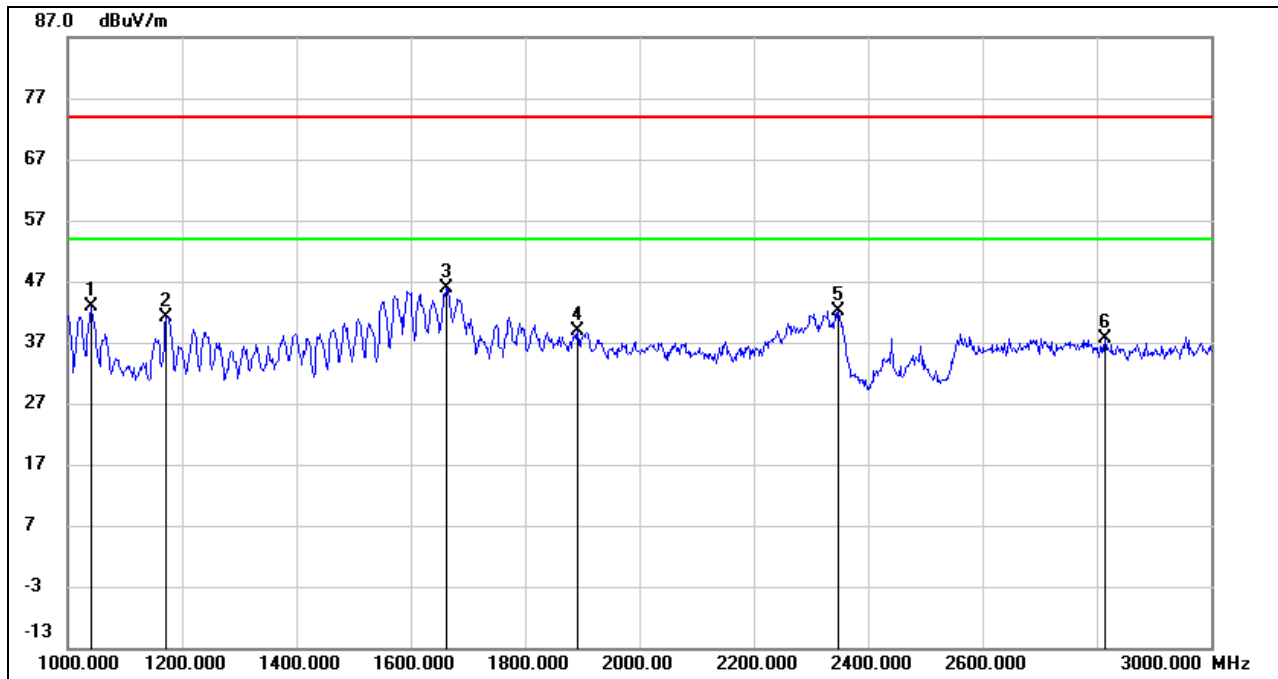

| No. | Frequency (MHz) | Reading (dBuV) | Correct (dB/m) | Result (dBuV/m) | Limit (dBuV/m) | Margin (dB) | Remark |
|-----|-----------------|----------------|----------------|-----------------|----------------|-------------|--------|
| 1 | 1040.000 | 57.59 | -14.79 | 42.80 | 74.00 | -31.20 | peak |
| 2 | 1172.000 | 55.13 | -13.90 | 41.23 | 74.00 | -32.77 | peak |
| 3 | 1662.000 | 57.38 | -11.46 | 45.92 | 74.00 | -28.08 | peak |
| 4 | 1892.000 | 49.61 | -10.76 | 38.85 | 74.00 | -35.15 | peak |
| 5 | 2348.000 | 51.33 | -9.16 | 42.17 | 74.00 | -31.83 | peak |
| 6 | 2814.000 | 45.19 | -7.63 | 37.56 | 74.00 | -36.44 | peak |

- Note:
1. Peak Result = Reading Level + Correct Factor.
 2. If Peak Result complies with AV limit, AV Result is deemed to comply with AV limit.
 3. Peak: Peak detector.
 4. Filter losses were only considered in then spurious frequency bands and the authorized band was not corrected for Band reject filter losses.
 5. Proper operation of the transmitter prior to adding the filter to the measurement chain.

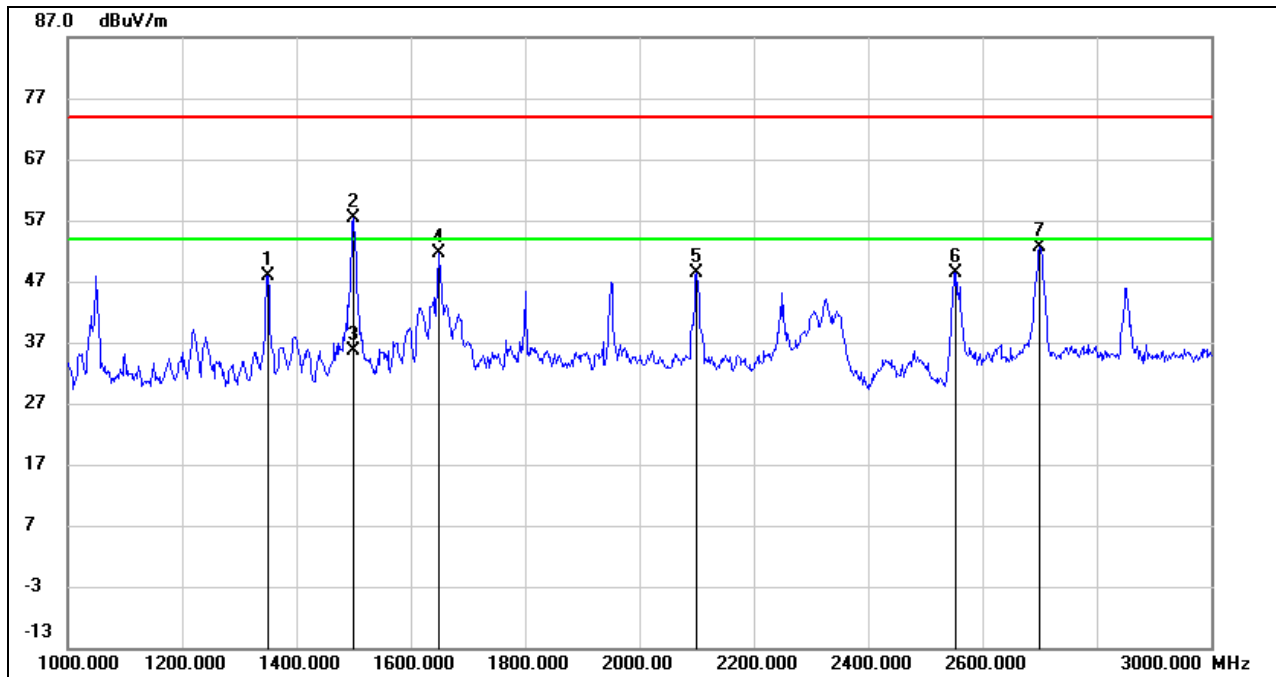
HARMONICS AND SPURIOUS EMISSIONS (HIGH CHANNEL, HORIZONTAL)

| No. | Frequency (MHz) | Reading (dBuV) | Correct (dB/m) | Result (dBuV/m) | Limit (dBuV/m) | Margin (dB) | Remark |
|-----|-----------------|----------------|----------------|-----------------|----------------|-------------|--------|
| 1 | 1350.000 | 61.20 | -13.22 | 47.98 | 74.00 | -26.02 | peak |
| 2 | 1500.000 | 69.87 | -12.41 | 57.46 | 74.00 | -16.54 | peak |
| 3 | 1500.000 | 48.03 | -12.41 | 35.62 | 54.00 | -18.38 | AVG |
| 4 | 1648.000 | 63.19 | -11.54 | 51.65 | 74.00 | -22.35 | peak |
| 5 | 2100.000 | 58.65 | -10.34 | 48.31 | 74.00 | -25.69 | peak |
| 6 | 2554.000 | 57.02 | -8.63 | 48.39 | 74.00 | -25.61 | peak |
| 7 | 2700.000 | 60.71 | -8.12 | 52.59 | 74.00 | -21.41 | peak |

- Note:
1. Peak Result = Reading Level + Correct Factor.
 2. If Peak Result complies with AV limit, AV Result is deemed to comply with AV limit.
 3. Peak: Peak detector.
 4. Filter losses were only considered in then spurious frequency bands and the authorized band was not corrected for Band reject filter losses.
 5. Proper operation of the transmitter prior to adding the filter to the measurement chain.

HARMONICS AND SPURIOUS EMISSIONS (HIGH CHANNEL, VERTICAL)

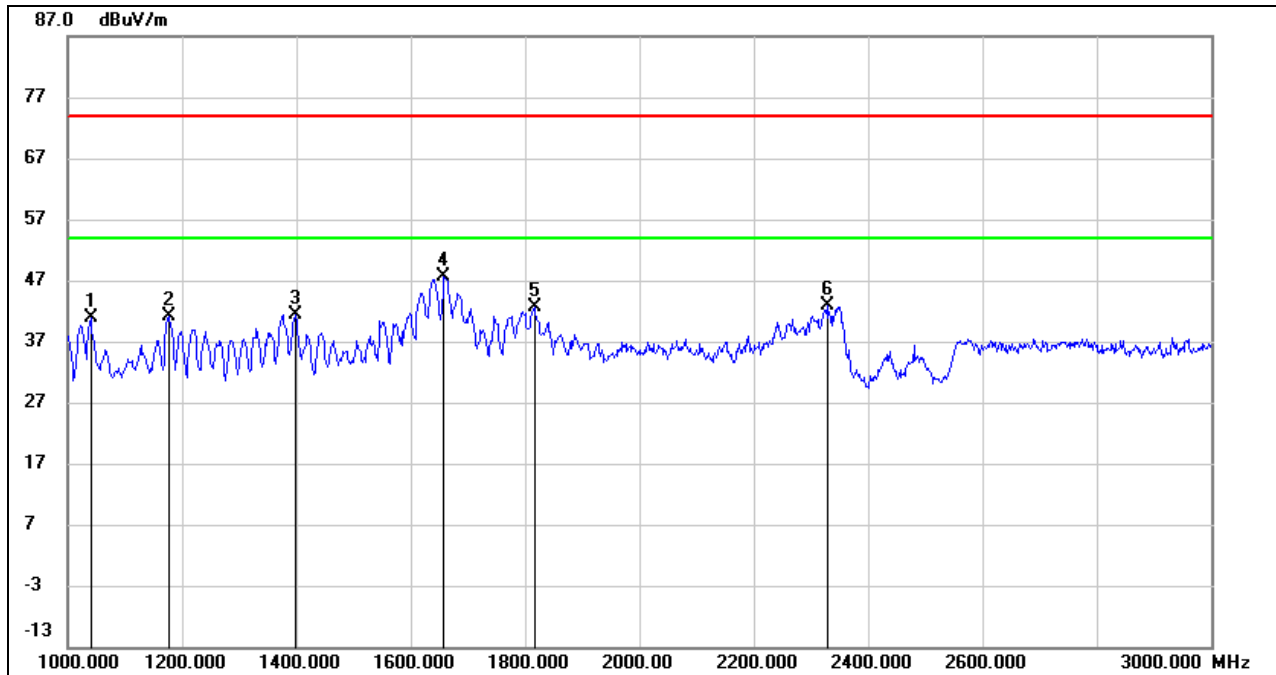

| No. | Frequency (MHz) | Reading (dBuV) | Correct (dB/m) | Result (dBuV/m) | Limit (dBuV/m) | Margin (dB) | Remark |
|-----|-----------------|----------------|----------------|-----------------|----------------|-------------|--------|
| 1 | 1040.000 | 55.64 | -14.79 | 40.85 | 74.00 | -33.15 | peak |
| 2 | 1176.000 | 55.11 | -13.87 | 41.24 | 74.00 | -32.76 | peak |
| 3 | 1398.000 | 54.50 | -13.07 | 41.43 | 74.00 | -32.57 | peak |
| 4 | 1658.000 | 59.13 | -11.48 | 47.65 | 74.00 | -26.35 | peak |
| 5 | 1816.000 | 53.17 | -10.61 | 42.56 | 74.00 | -31.44 | peak |
| 6 | 2328.000 | 52.06 | -9.23 | 42.83 | 74.00 | -31.17 | peak |

- Note: 1. Peak Result = Reading Level + Correct Factor.
 2. If Peak Result complies with AV limit, AV Result is deemed to comply with AV limit.
 3. Peak: Peak detector.
 4. Filter losses were only considered in then spurious frequency bands and the authorized band was not corrected for Band reject filter losses.
 5. Proper operation of the transmitter prior to adding the filter to the measurement chain.

Note: All the modes have been tested, only the worst data was recorded in the report.

8.3. SPURIOUS EMISSIONS (3 GHz ~ 18 GHz)

8.3.1. BLE_1M MODE

HARMONICS AND SPURIOUS EMISSIONS (LOW CHANNEL, HORIZONTAL)

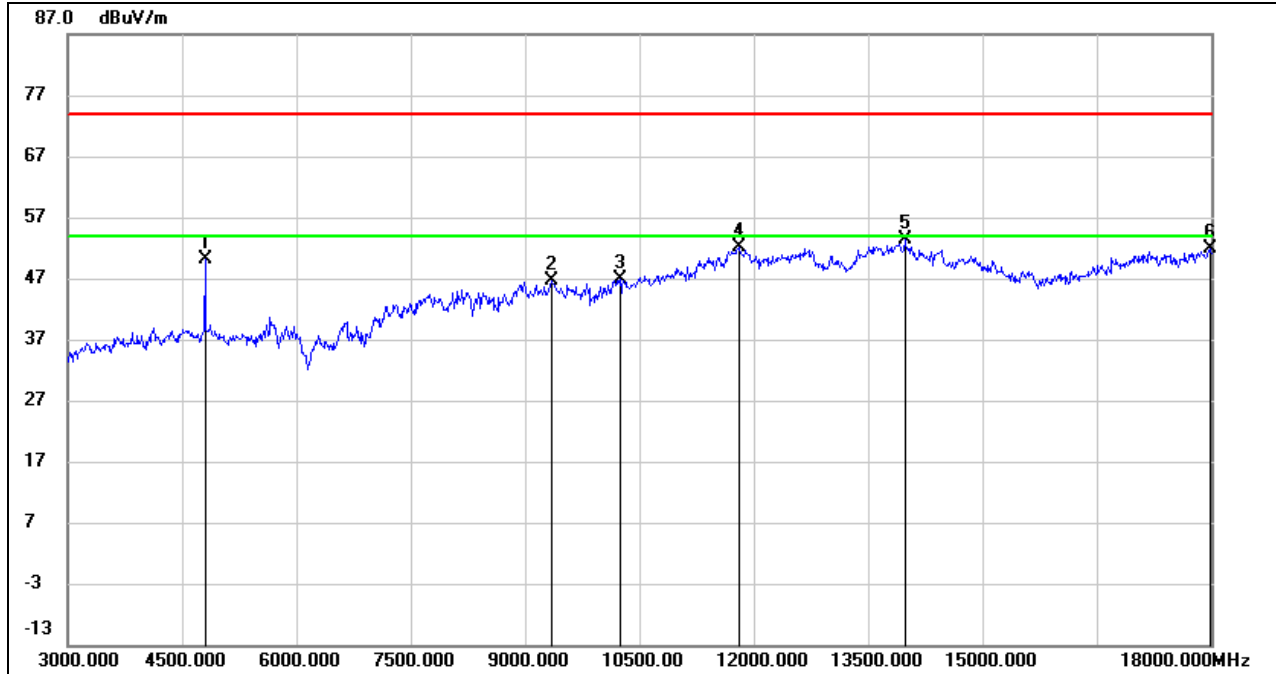

| No. | Frequency (MHz) | Reading (dBuV) | Correct (dB/m) | Result (dBuV/m) | Limit (dBuV/m) | Margin (dB) | Remark |
|-----|-----------------|----------------|----------------|-----------------|----------------|-------------|--------|
| 1 | 4800.000 | 51.28 | -1.14 | 50.14 | 74.00 | -23.86 | peak |
| 2 | 9345.000 | 37.34 | 9.34 | 46.68 | 74.00 | -27.32 | peak |
| 3 | 10245.000 | 35.83 | 11.03 | 46.86 | 74.00 | -27.14 | peak |
| 4 | 11805.000 | 34.82 | 17.21 | 52.03 | 74.00 | -21.97 | peak |
| 5 | 13980.000 | 32.87 | 20.63 | 53.50 | 74.00 | -20.50 | peak |
| 6 | 17985.000 | 28.17 | 23.64 | 51.81 | 74.00 | -22.19 | peak |

- Note: 1. Peak Result = Reading Level + Correct Factor.
 2. If Peak Result complies with AV limit, AV Result is deemed to comply with AV limit.
 3. Peak: Peak detector.
 4. Filter losses were only considered in the spurious frequency bands and the authorized band was not corrected for High Pass Filter losses.
 5. Proper operation of the transmitter prior to adding the filter to the measurement chain.

HARMONICS AND SPURIOUS EMISSIONS (LOW CHANNEL, VERTICAL)

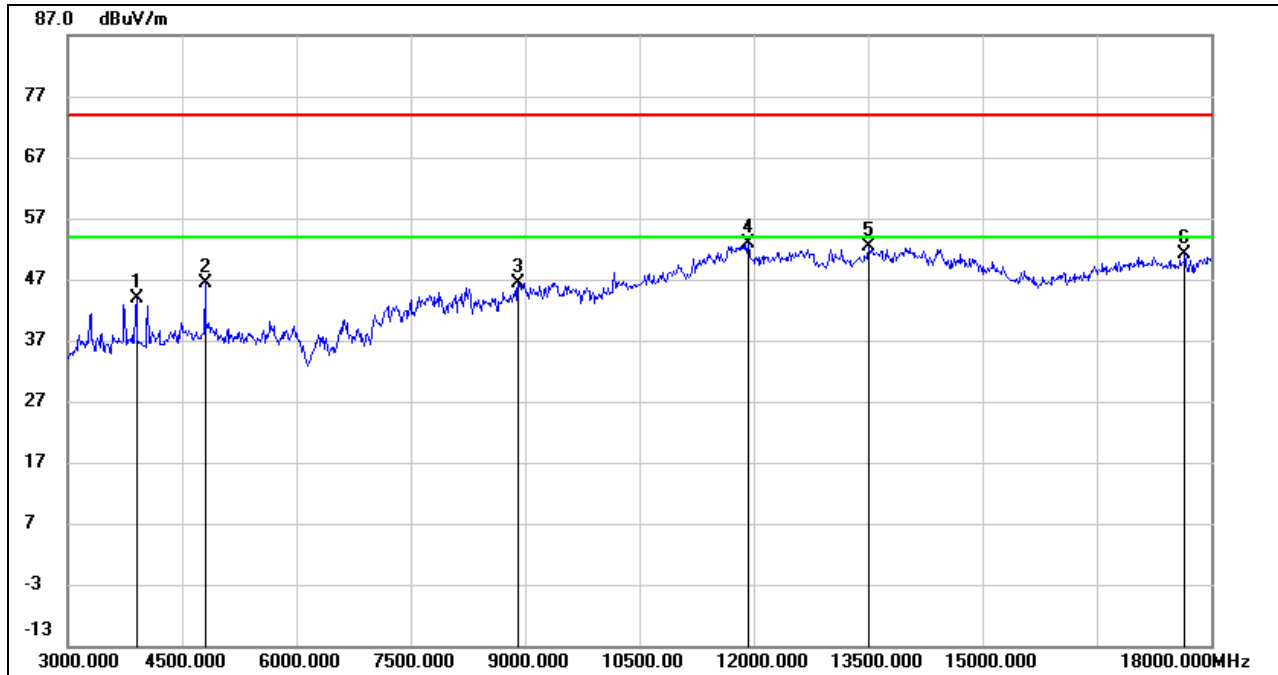

| No. | Frequency (MHz) | Reading (dBuV) | Correct (dB/m) | Result (dBuV/m) | Limit (dBuV/m) | Margin (dB) | Remark |
|-----|-----------------|----------------|----------------|-----------------|----------------|-------------|--------|
| 1 | 3900.000 | 48.48 | -4.50 | 43.98 | 74.00 | -30.02 | peak |
| 2 | 4800.000 | 47.54 | -1.14 | 46.40 | 74.00 | -27.60 | peak |
| 3 | 8910.000 | 38.01 | 8.44 | 46.45 | 74.00 | -27.55 | peak |
| 4 | 11925.000 | 35.79 | 17.14 | 52.93 | 74.00 | -21.07 | peak |
| 5 | 13500.000 | 32.69 | 19.58 | 52.27 | 74.00 | -21.73 | peak |
| 6 | 17655.000 | 29.55 | 21.68 | 51.23 | 74.00 | -22.77 | peak |

- Note: 1. Peak Result = Reading Level + Correct Factor.
 2. If Peak Result complies with AV limit, AV Result is deemed to comply with AV limit.
 3. Peak: Peak detector.
 4. Filter losses were only considered in the spurious frequency bands and the authorized band was not corrected for High Pass Filter losses.
 5. Proper operation of the transmitter prior to adding the filter to the measurement chain.

HARMONICS AND SPURIOUS EMISSIONS (MID CHANNEL, HORIZONTAL)

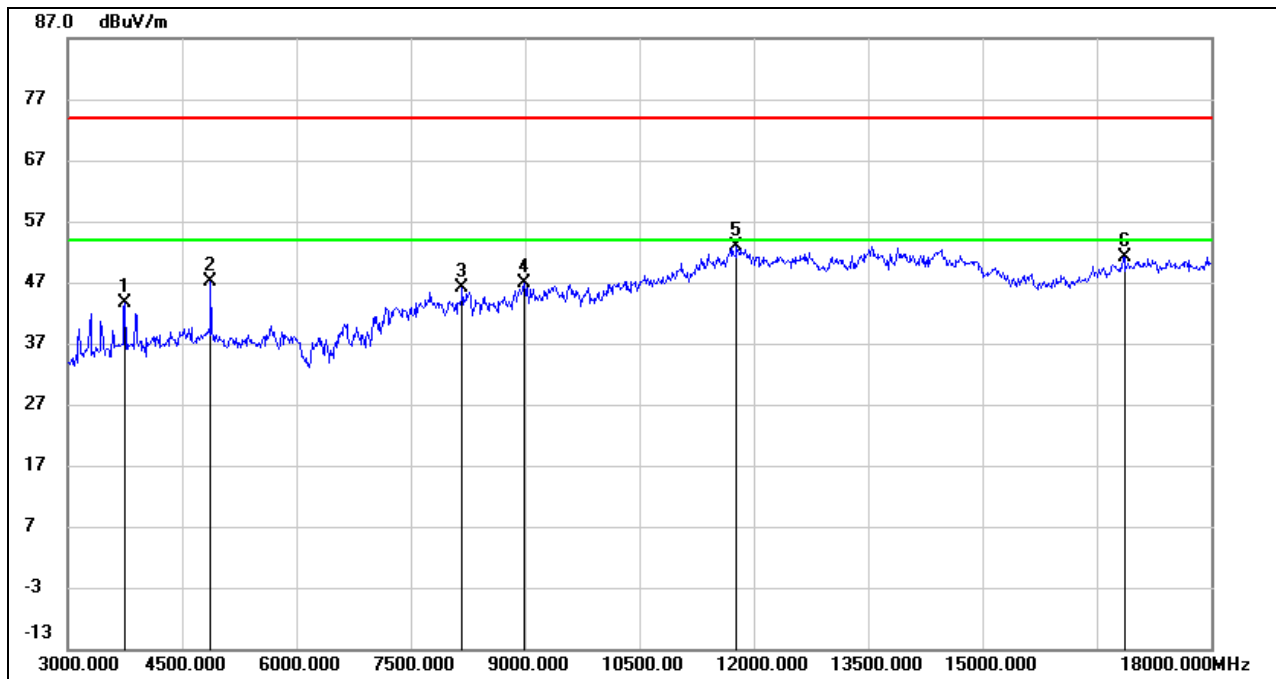

| No. | Frequency (MHz) | Reading (dBuV) | Correct (dB/m) | Result (dBuV/m) | Limit (dBuV/m) | Margin (dB) | Remark |
|-----|-----------------|----------------|----------------|-----------------|----------------|-------------|--------|
| 1 | 3750.000 | 48.14 | -4.57 | 43.57 | 74.00 | -30.43 | peak |
| 2 | 4875.000 | 48.16 | -1.13 | 47.03 | 74.00 | -26.97 | peak |
| 3 | 8175.000 | 39.07 | 6.99 | 46.06 | 74.00 | -27.94 | peak |
| 4 | 8985.000 | 37.51 | 9.34 | 46.85 | 74.00 | -27.15 | peak |
| 5 | 11775.000 | 35.82 | 17.06 | 52.88 | 74.00 | -21.12 | peak |
| 6 | 16860.000 | 32.68 | 18.48 | 51.16 | 74.00 | -22.84 | peak |

- Note: 1. Peak Result = Reading Level + Correct Factor.
 2. If Peak Result complies with AV limit, AV Result is deemed to comply with AV limit.
 3. Peak: Peak detector.
 4. Filter losses were only considered in the spurious frequency bands and the authorized band was not corrected for High Pass Filter losses.
 5. Proper operation of the transmitter prior to adding the filter to the measurement chain.

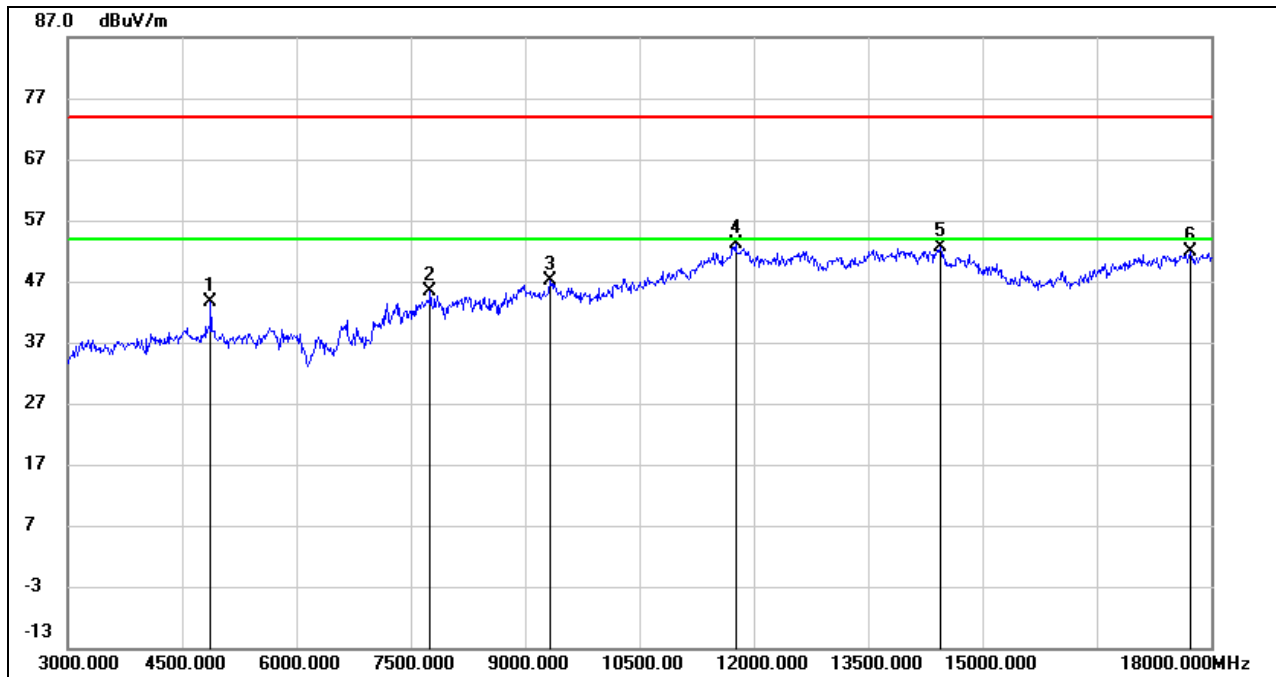
**HARMONICS AND SPURIOUS EMISSIONS (MID CHANNEL, VERTICAL)**

| No. | Frequency (MHz) | Reading (dBuV) | Correct (dB/m) | Result (dBuV/m) | Limit (dBuV/m) | Margin (dB) | Remark |
|-----|-----------------|----------------|----------------|-----------------|----------------|-------------|--------|
| 1 | 4875.000 | 44.71 | -1.13 | 43.58 | 74.00 | -30.42 | peak |
| 2 | 7755.000 | 39.54 | 5.93 | 45.47 | 74.00 | -28.53 | peak |
| 3 | 9330.000 | 37.83 | 9.24 | 47.07 | 74.00 | -26.93 | peak |
| 4 | 11760.000 | 36.13 | 16.97 | 53.10 | 74.00 | -20.90 | peak |
| 5 | 14445.000 | 33.90 | 18.69 | 52.59 | 74.00 | -21.41 | peak |
| 6 | 17730.000 | 29.49 | 22.46 | 51.95 | 74.00 | -22.05 | peak |

Note: 1. Peak Result = Reading Level + Correct Factor.

2. If Peak Result complies with AV limit, AV Result is deemed to comply with AV limit.

3. Peak: Peak detector.

4. Filter losses were only considered in the spurious frequency bands and the authorized band was not corrected for High Pass Filter losses.

5. Proper operation of the transmitter prior to adding the filter to the measurement chain.



HARMONICS AND SPURIOUS EMISSIONS (HIGH CHANNEL, HORIZONTAL)

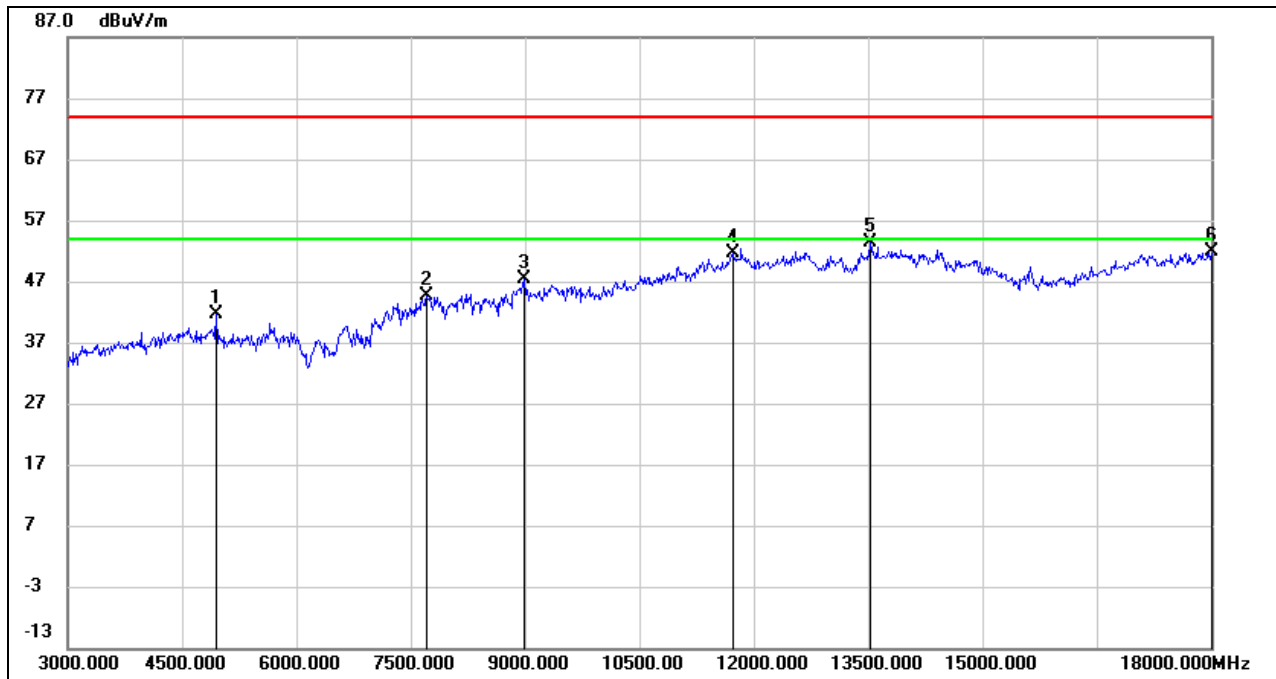

| No. | Frequency (MHz) | Reading (dBuV) | Correct (dB/m) | Result (dBuV/m) | Limit (dBuV/m) | Margin (dB) | Remark |
|-----|-----------------|----------------|----------------|-----------------|----------------|-------------|--------|
| 1 | 4950.000 | 42.84 | -1.12 | 41.72 | 74.00 | -32.28 | peak |
| 2 | 7710.000 | 38.79 | 5.80 | 44.59 | 74.00 | -29.41 | peak |
| 3 | 8985.000 | 37.97 | 9.34 | 47.31 | 74.00 | -26.69 | peak |
| 4 | 11730.000 | 34.81 | 16.77 | 51.58 | 74.00 | -22.42 | peak |
| 5 | 13530.000 | 33.83 | 19.62 | 53.45 | 74.00 | -20.55 | peak |
| 6 | 18000.000 | 28.31 | 23.68 | 51.99 | 74.00 | -22.01 | peak |

- Note: 1. Peak Result = Reading Level + Correct Factor.
 2. If Peak Result complies with AV limit, AV Result is deemed to comply with AV limit.
 3. Peak: Peak detector.
 4. Filter losses were only considered in the spurious frequency bands and the authorized band was not corrected for High Pass Filter losses.
 5. Proper operation of the transmitter prior to adding the filter to the measurement chain.

HARMONICS AND SPURIOUS EMISSIONS (HIGH CHANNEL, VERTICAL)

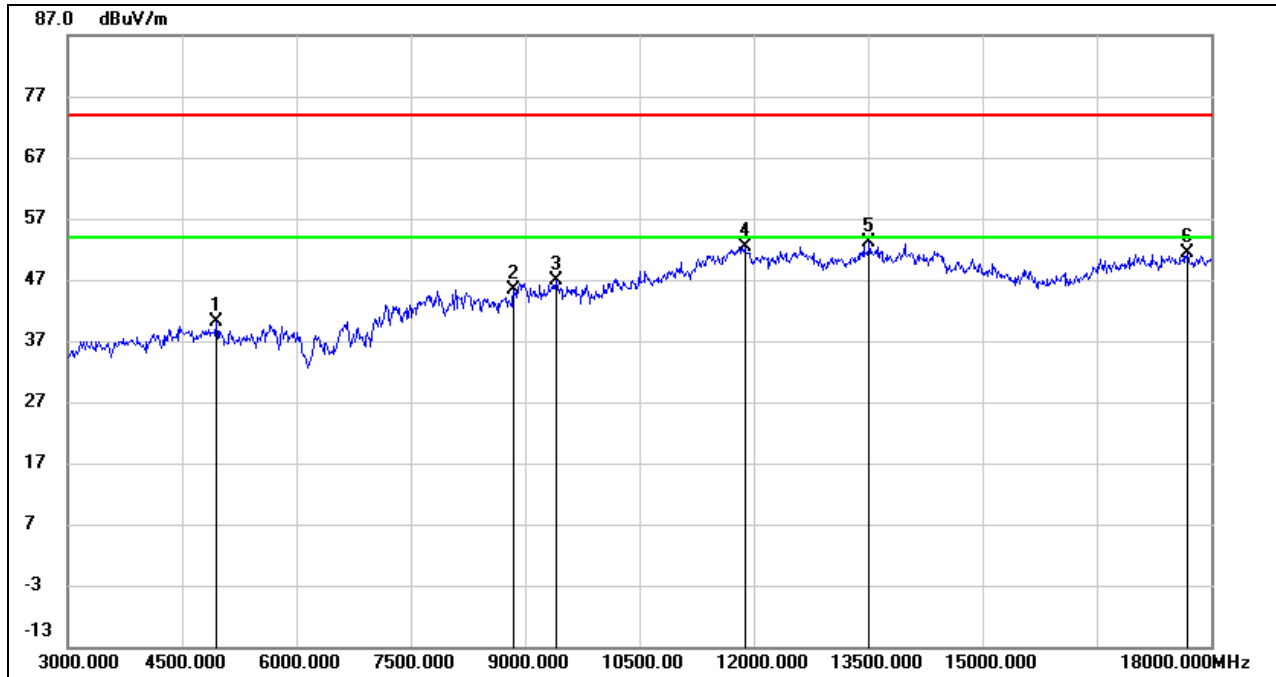

| No. | Frequency (MHz) | Reading (dBuV) | Correct (dB/m) | Result (dBuV/m) | Limit (dBuV/m) | Margin (dB) | Remark |
|-----|-----------------|----------------|----------------|-----------------|----------------|-------------|--------|
| 1 | 4950.000 | 41.34 | -1.12 | 40.22 | 74.00 | -33.78 | peak |
| 2 | 8850.000 | 37.72 | 7.73 | 45.45 | 74.00 | -28.55 | peak |
| 3 | 9405.000 | 37.13 | 9.70 | 46.83 | 74.00 | -27.17 | peak |
| 4 | 11880.000 | 35.11 | 17.17 | 52.28 | 74.00 | -21.72 | peak |
| 5 | 13515.000 | 33.55 | 19.60 | 53.15 | 74.00 | -20.85 | peak |
| 6 | 17685.000 | 29.42 | 21.99 | 51.41 | 74.00 | -22.59 | peak |

- Note: 1. Peak Result = Reading Level + Correct Factor.
 2. If Peak Result complies with AV limit, AV Result is deemed to comply with AV limit.
 3. Peak: Peak detector.
 4. Filter losses were only considered in the spurious frequency bands and the authorized band was not corrected for High Pass Filter losses.
 5. Proper operation of the transmitter prior to adding the filter to the measurement chain.

8.3.2. BLE_2M MODE

HARMONICS AND SPURIOUS EMISSIONS (LOW CHANNEL, HORIZONTAL)

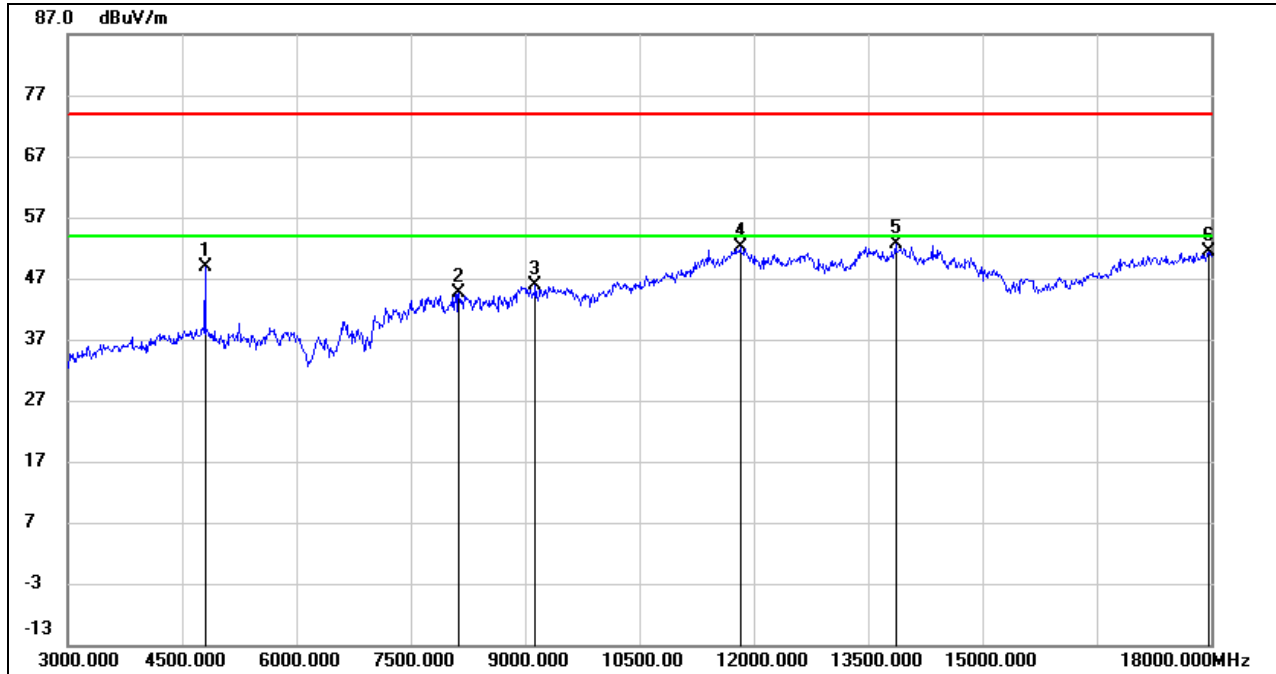

| No. | Frequency (MHz) | Reading (dBuV) | Correct (dB/m) | Result (dBuV/m) | Limit (dBuV/m) | Margin (dB) | Remark |
|-----|-----------------|----------------|----------------|-----------------|----------------|-------------|--------|
| 1 | 4800.000 | 50.11 | -1.14 | 48.97 | 74.00 | -25.03 | peak |
| 2 | 8130.000 | 38.09 | 6.57 | 44.66 | 74.00 | -29.34 | peak |
| 3 | 9135.000 | 36.99 | 8.79 | 45.78 | 74.00 | -28.22 | peak |
| 4 | 11820.000 | 34.99 | 17.21 | 52.20 | 74.00 | -21.80 | peak |
| 5 | 13860.000 | 32.15 | 20.55 | 52.70 | 74.00 | -21.30 | peak |
| 6 | 17970.000 | 27.78 | 23.60 | 51.38 | 74.00 | -22.62 | peak |

- Note: 1. Peak Result = Reading Level + Correct Factor.
 2. If Peak Result complies with AV limit, AV Result is deemed to comply with AV limit.
 3. Peak: Peak detector.
 4. Filter losses were only considered in the spurious frequency bands and the authorized band was not corrected for High Pass Filter losses.
 5. Proper operation of the transmitter prior to adding the filter to the measurement chain.

HARMONICS AND SPURIOUS EMISSIONS (LOW CHANNEL, VERTICAL)

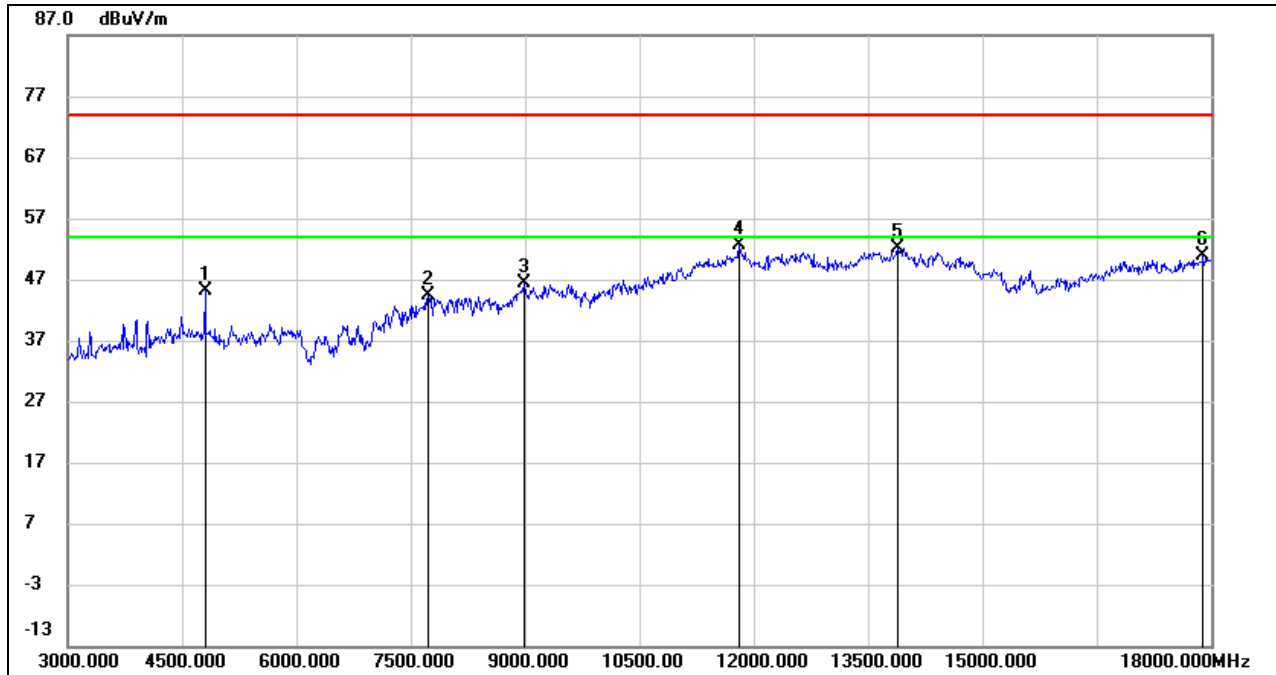

| No. | Frequency (MHz) | Reading (dBuV) | Correct (dB/m) | Result (dBuV/m) | Limit (dBuV/m) | Margin (dB) | Remark |
|-----|-----------------|----------------|----------------|-----------------|----------------|-------------|--------|
| 1 | 4800.000 | 46.33 | -1.14 | 45.19 | 74.00 | -28.81 | peak |
| 2 | 7725.000 | 38.66 | 5.84 | 44.50 | 74.00 | -29.50 | peak |
| 3 | 8985.000 | 37.10 | 9.34 | 46.44 | 74.00 | -27.56 | peak |
| 4 | 11805.000 | 35.36 | 17.21 | 52.57 | 74.00 | -21.43 | peak |
| 5 | 13890.000 | 31.54 | 20.56 | 52.10 | 74.00 | -21.90 | peak |
| 6 | 17895.000 | 27.46 | 23.42 | 50.88 | 74.00 | -23.12 | peak |

- Note: 1. Peak Result = Reading Level + Correct Factor.
 2. If Peak Result complies with AV limit, AV Result is deemed to comply with AV limit.
 3. Peak: Peak detector.
 4. Filter losses were only considered in the spurious frequency bands and the authorized band was not corrected for High Pass Filter losses.
 5. Proper operation of the transmitter prior to adding the filter to the measurement chain.

HARMONICS AND SPURIOUS EMISSIONS (MID CHANNEL, HORIZONTAL)

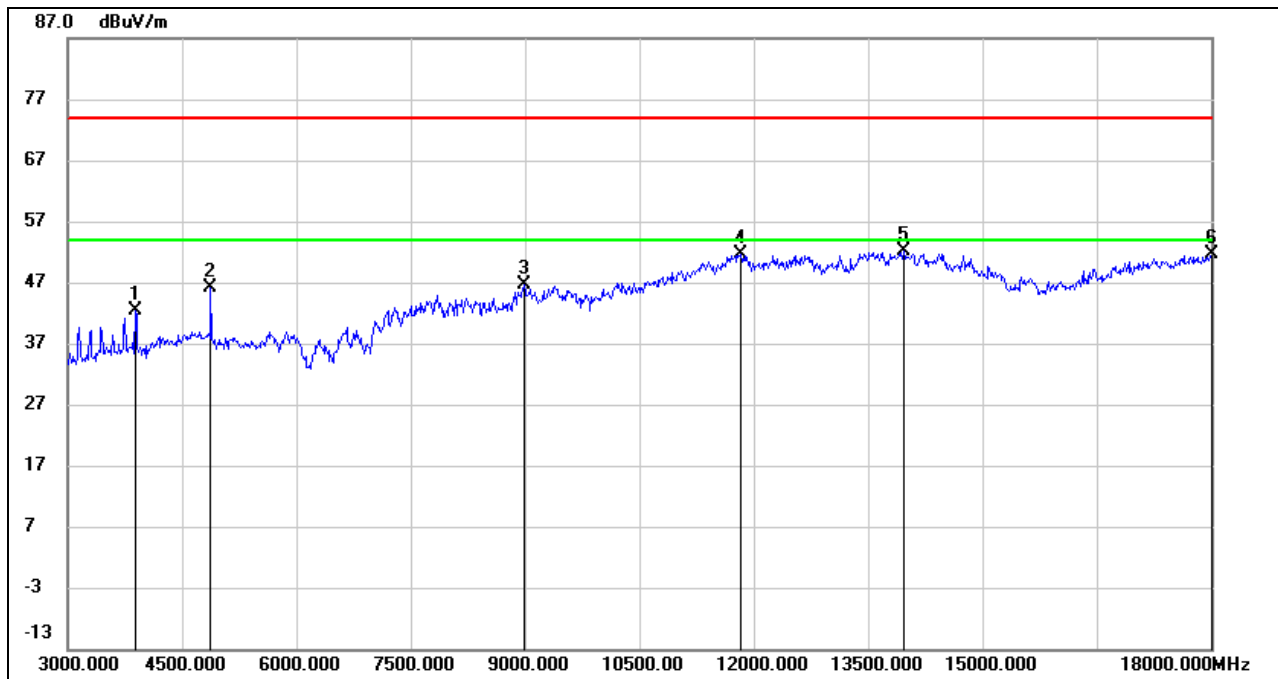

| No. | Frequency (MHz) | Reading (dBuV) | Correct (dB/m) | Result (dBuV/m) | Limit (dBuV/m) | Margin (dB) | Remark |
|-----|-----------------|----------------|----------------|-----------------|----------------|-------------|--------|
| 1 | 3885.000 | 46.94 | -4.47 | 42.47 | 74.00 | -31.53 | peak |
| 2 | 4875.000 | 47.31 | -1.13 | 46.18 | 74.00 | -27.82 | peak |
| 3 | 8985.000 | 37.17 | 9.34 | 46.51 | 74.00 | -27.49 | peak |
| 4 | 11835.000 | 34.38 | 17.20 | 51.58 | 74.00 | -22.42 | peak |
| 5 | 13965.000 | 31.49 | 20.61 | 52.10 | 74.00 | -21.90 | peak |
| 6 | 18000.000 | 27.90 | 23.68 | 51.58 | 74.00 | -22.42 | peak |

- Note: 1. Peak Result = Reading Level + Correct Factor.
 2. If Peak Result complies with AV limit, AV Result is deemed to comply with AV limit.
 3. Peak: Peak detector.
 4. Filter losses were only considered in the spurious frequency bands and the authorized band was not corrected for High Pass Filter losses.
 5. Proper operation of the transmitter prior to adding the filter to the measurement chain.

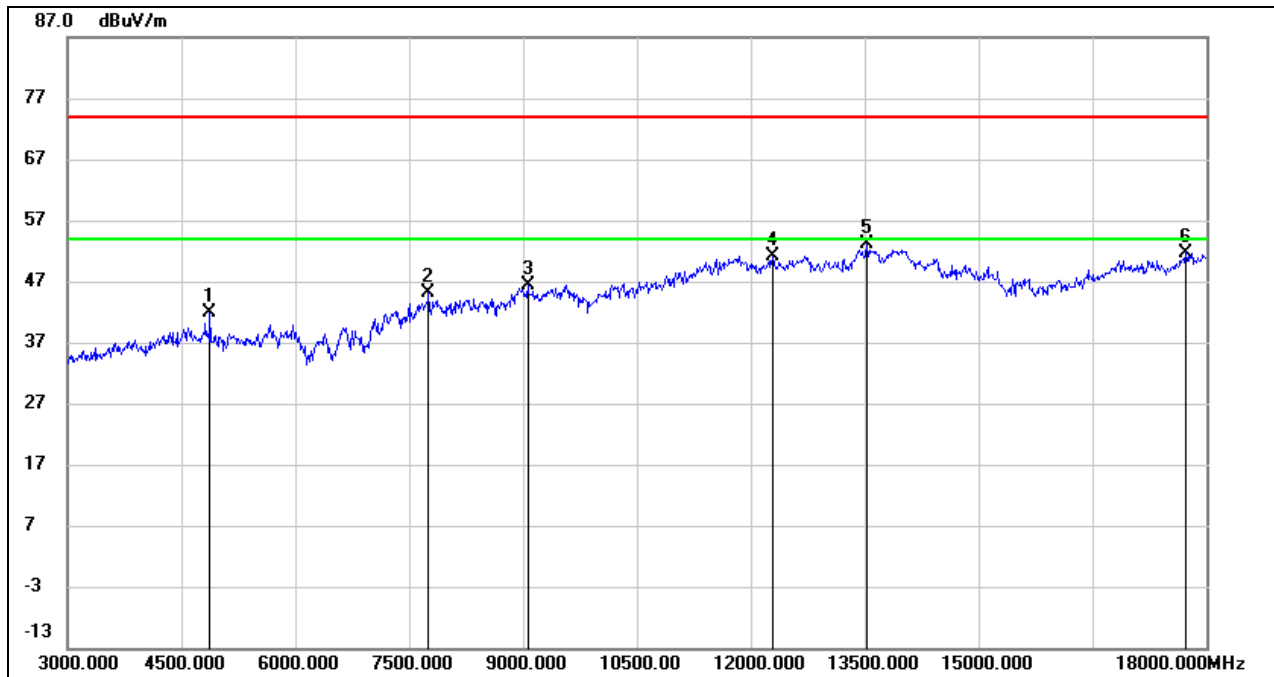
HARMONICS AND SPURIOUS EMISSIONS (MID CHANNEL, VERTICAL)

| No. | Frequency (MHz) | Reading (dBuV) | Correct (dB/m) | Result (dBuV/m) | Limit (dBuV/m) | Margin (dB) | Remark |
|-----|-----------------|----------------|----------------|-----------------|----------------|-------------|--------|
| 1 | 4875.000 | 42.99 | -1.13 | 41.86 | 74.00 | -32.14 | peak |
| 2 | 7755.000 | 39.09 | 5.93 | 45.02 | 74.00 | -28.98 | peak |
| 3 | 9060.000 | 37.24 | 9.20 | 46.44 | 74.00 | -27.56 | peak |
| 4 | 12285.000 | 34.17 | 16.88 | 51.05 | 74.00 | -22.95 | peak |
| 5 | 13530.000 | 33.42 | 19.62 | 53.04 | 74.00 | -20.96 | peak |
| 6 | 17730.000 | 29.29 | 22.46 | 51.75 | 74.00 | -22.25 | peak |

- Note:
1. Peak Result = Reading Level + Correct Factor.
 2. If Peak Result complies with AV limit, AV Result is deemed to comply with AV limit.
 3. Peak: Peak detector.
 4. Filter losses were only considered in the spurious frequency bands and the authorized band was not corrected for High Pass Filter losses.
 5. Proper operation of the transmitter prior to adding the filter to the measurement chain.

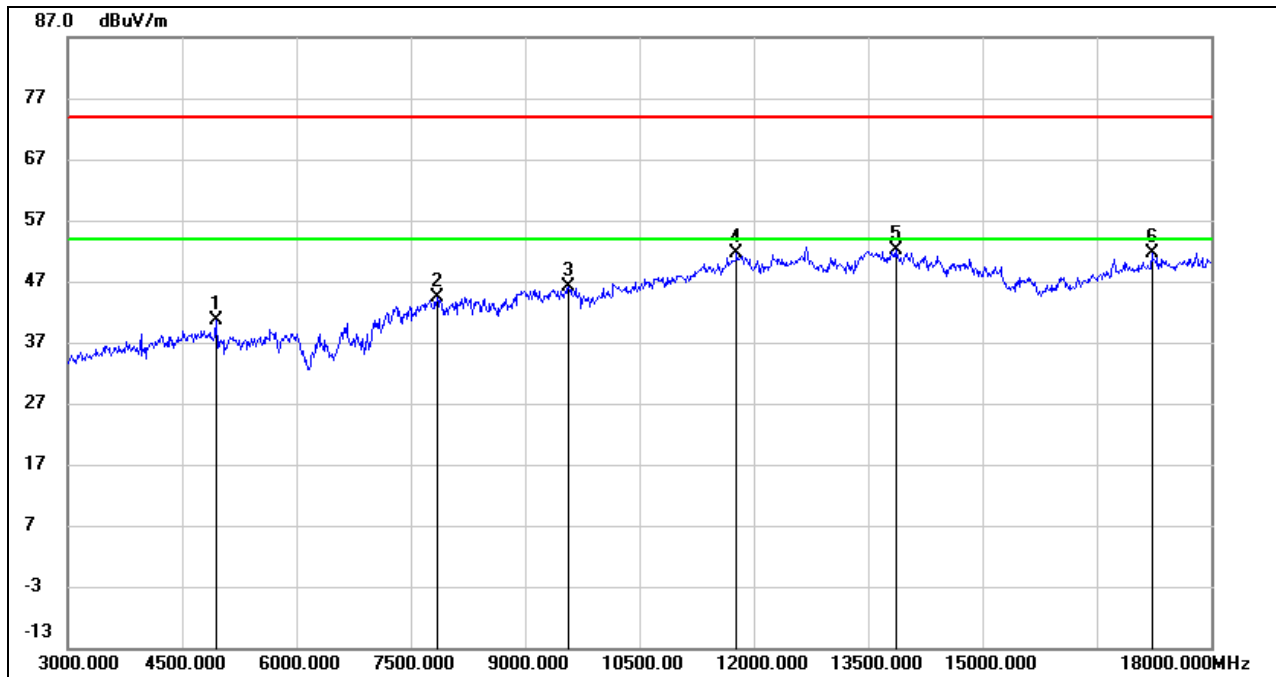
**HARMONICS AND SPURIOUS EMISSIONS (HIGH CHANNEL, HORIZONTAL)**

| No. | Frequency (MHz) | Reading (dBuV) | Correct (dB/m) | Result (dBuV/m) | Limit (dBuV/m) | Margin (dB) | Remark |
|-----|-----------------|----------------|----------------|-----------------|----------------|-------------|--------|
| 1 | 4950.000 | 41.66 | -1.12 | 40.54 | 74.00 | -33.46 | peak |
| 2 | 7845.000 | 38.48 | 5.92 | 44.40 | 74.00 | -29.60 | peak |
| 3 | 9570.000 | 35.98 | 10.07 | 46.05 | 74.00 | -27.95 | peak |
| 4 | 11775.000 | 34.58 | 17.06 | 51.64 | 74.00 | -22.36 | peak |
| 5 | 13860.000 | 31.59 | 20.55 | 52.14 | 74.00 | -21.86 | peak |
| 6 | 17220.000 | 31.38 | 20.16 | 51.54 | 74.00 | -22.46 | peak |

Note: 1. Peak Result = Reading Level + Correct Factor.

2. If Peak Result complies with AV limit, AV Result is deemed to comply with AV limit.

3. Peak: Peak detector.

4. Filter losses were only considered in the spurious frequency bands and the authorized band was not corrected for High Pass Filter losses.

5. Proper operation of the transmitter prior to adding the filter to the measurement chain.

HARMONICS AND SPURIOUS EMISSIONS (HIGH CHANNEL, VERTICAL)

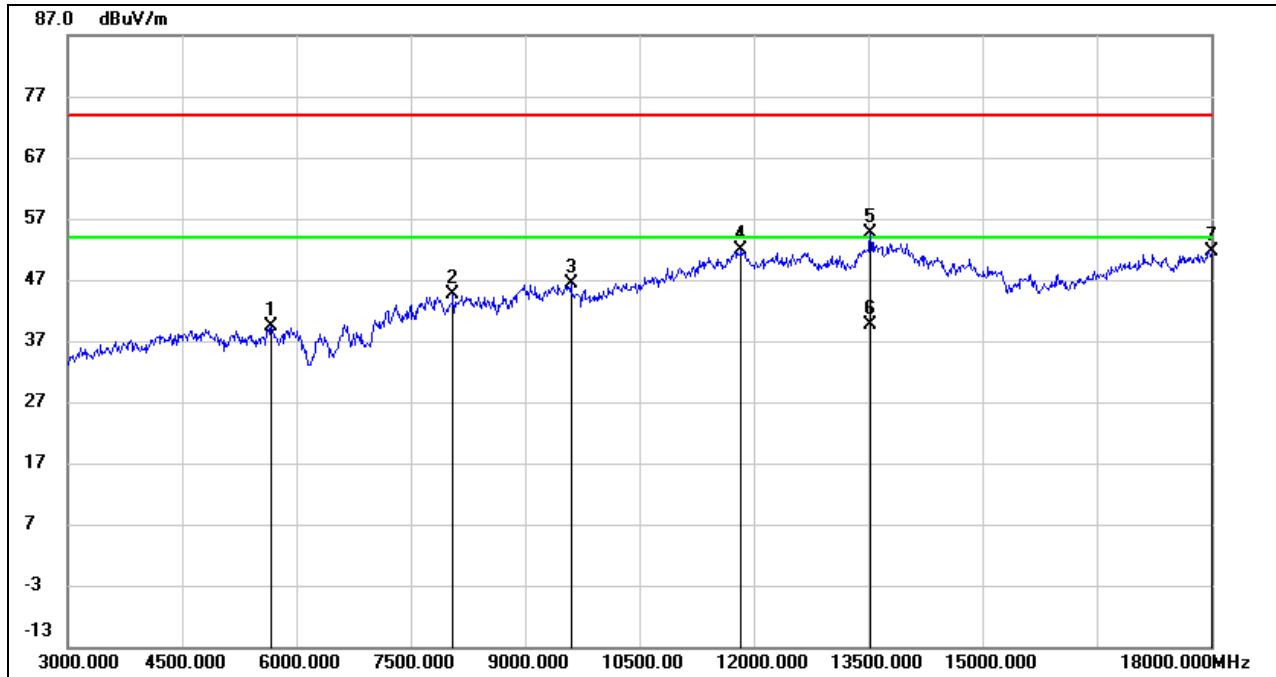

| No. | Frequency (MHz) | Reading (dBuV) | Correct (dB/m) | Result (dBuV/m) | Limit (dBuV/m) | Margin (dB) | Remark |
|-----|-----------------|----------------|----------------|-----------------|----------------|-------------|--------|
| 1 | 5670.000 | 38.65 | 0.68 | 39.33 | 74.00 | -34.67 | peak |
| 2 | 8055.000 | 38.65 | 5.87 | 44.52 | 74.00 | -29.48 | peak |
| 3 | 9600.000 | 36.14 | 10.13 | 46.27 | 74.00 | -27.73 | peak |
| 4 | 11835.000 | 34.64 | 17.20 | 51.84 | 74.00 | -22.16 | peak |
| 5 | 13530.000 | 34.97 | 19.62 | 54.59 | 74.00 | -19.41 | peak |
| 6 | 13530.000 | 19.90 | 19.62 | 39.52 | 54.00 | -14.48 | AVG |
| 7 | 18000.000 | 28.06 | 23.68 | 51.74 | 74.00 | -22.26 | peak |

- Note: 1. Peak Result = Reading Level + Correct Factor.
 2. If Peak Result complies with AV limit, AV Result is deemed to comply with AV limit.
 3. Peak: Peak detector.
 4. Filter losses were only considered in the spurious frequency bands and the authorized band was not corrected for High Pass Filter losses.
 5. Proper operation of the transmitter prior to adding the filter to the measurement chain.

8.4. SPURIOUS EMISSIONS (18 GHz ~ 26 GHz)

8.4.1. BLE_1M MODE

SPURIOUS EMISSIONS (MID CHANNEL, WORST-CASE CONFIGURATION, HORIZONTAL)

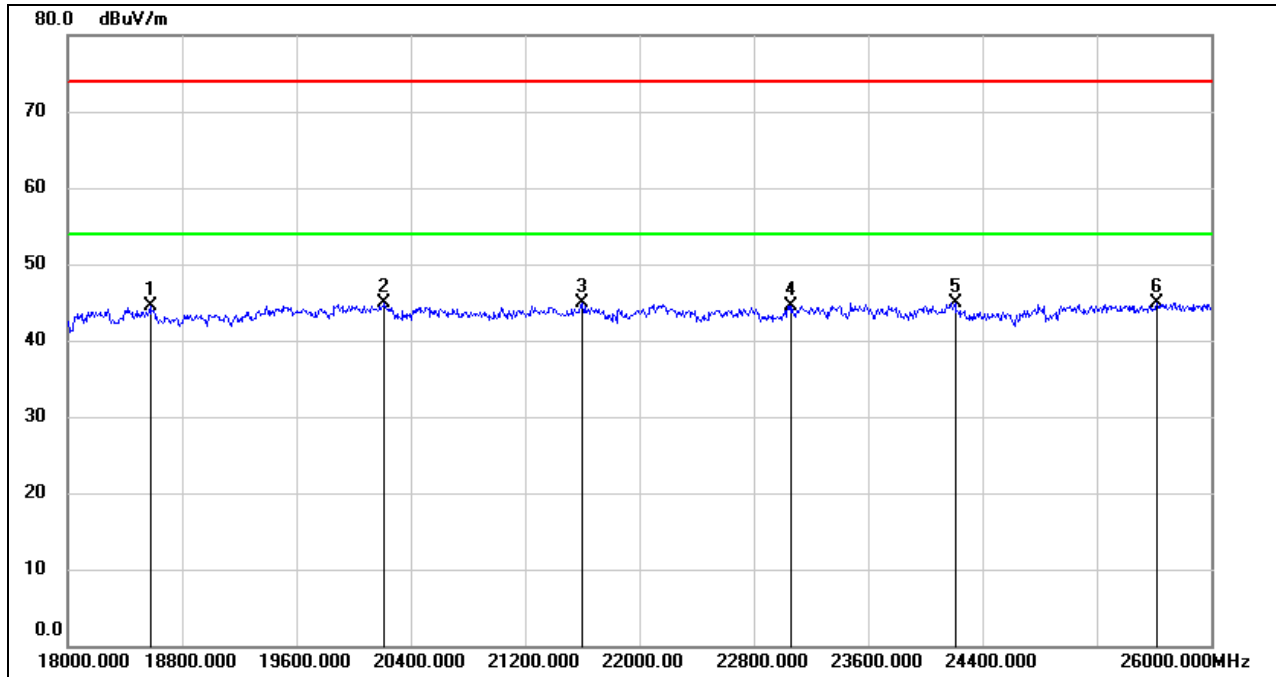

| No. | Frequency (MHz) | Reading (dBuV) | Correct (dB/m) | Result (dBuV/m) | Limit (dBuV/m) | Margin (dB) | Remark |
|-----|-----------------|----------------|----------------|-----------------|----------------|-------------|--------|
| 1 | 18576.000 | 49.72 | -5.30 | 44.42 | 74.00 | -29.58 | peak |
| 2 | 20216.000 | 50.52 | -5.60 | 44.92 | 74.00 | -29.08 | peak |
| 3 | 21600.000 | 49.52 | -4.54 | 44.98 | 74.00 | -29.02 | peak |
| 4 | 23064.000 | 47.99 | -3.42 | 44.57 | 74.00 | -29.43 | peak |
| 5 | 24208.000 | 47.71 | -2.81 | 44.90 | 74.00 | -29.10 | peak |
| 6 | 25616.000 | 46.18 | -1.24 | 44.94 | 74.00 | -29.06 | peak |

- Note: 1. Peak Result = Reading Level + Correct Factor.
 2. If Peak Result complies with AV limit, AV Result is deemed to comply with AV limit.
 3. Peak: Peak detector.



SPURIOUS EMISSIONS (MID CHANNEL, WORST-CASE CONFIGURATION, VERTICAL)

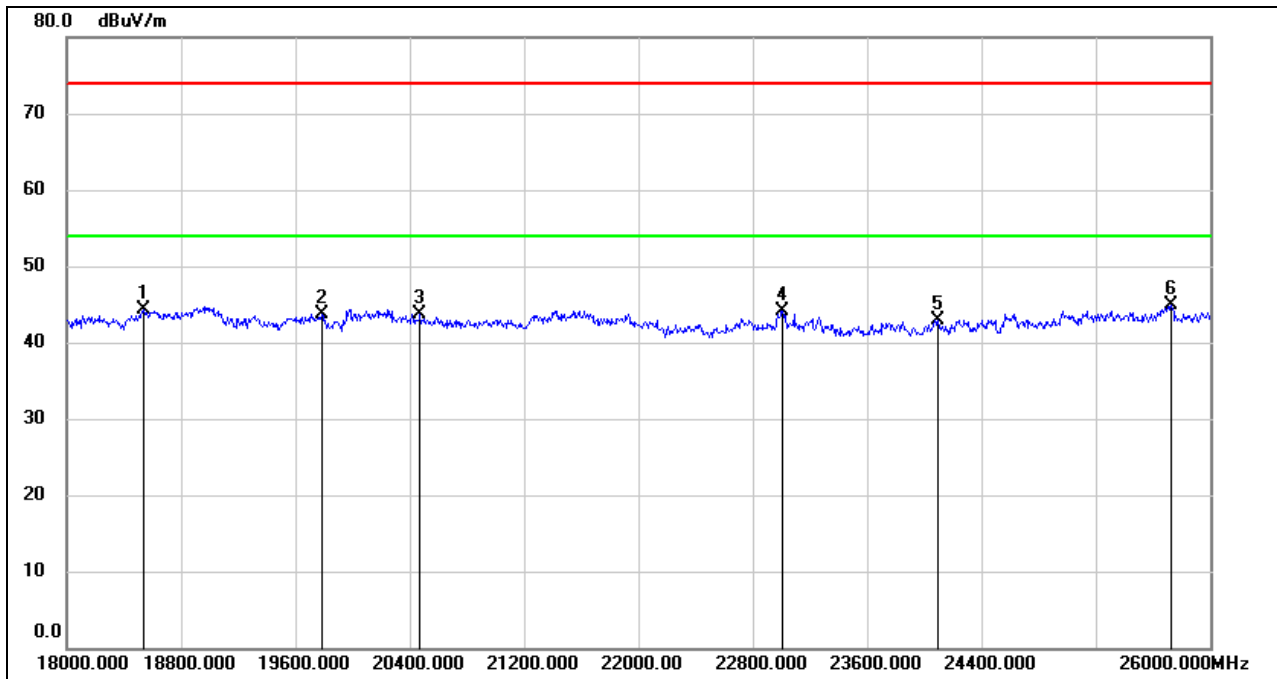

| No. | Frequency (MHz) | Reading (dBuV) | Correct (dB/m) | Result (dBuV/m) | Limit (dBuV/m) | Margin (dB) | Remark |
|-----|-----------------|----------------|----------------|-----------------|----------------|-------------|--------|
| 1 | 18536.000 | 49.60 | -5.27 | 44.33 | 74.00 | -29.67 | peak |
| 2 | 19784.000 | 49.07 | -5.28 | 43.79 | 74.00 | -30.21 | peak |
| 3 | 20472.000 | 49.07 | -5.39 | 43.68 | 74.00 | -30.32 | peak |
| 4 | 23008.000 | 47.60 | -3.44 | 44.16 | 74.00 | -29.84 | peak |
| 5 | 24096.000 | 45.61 | -2.78 | 42.83 | 74.00 | -31.17 | peak |
| 6 | 25728.000 | 45.61 | -0.72 | 44.89 | 74.00 | -29.11 | peak |

- Note: 1. Peak Result = Reading Level + Correct Factor.
 2. If Peak Result complies with AV limit, AV Result is deemed to comply with AV limit.
 3. Peak: Peak detector.

Note: All the modes have been tested, only the worst data was recorded in the report.

8.5. SPURIOUS EMISSIONS (30 MHz ~ 1 GHz)

8.5.1. BLE_1M MODE

SPURIOUS EMISSIONS (MID CHANNEL, WORST-CASE CONFIGURATION, HORIZONTAL)

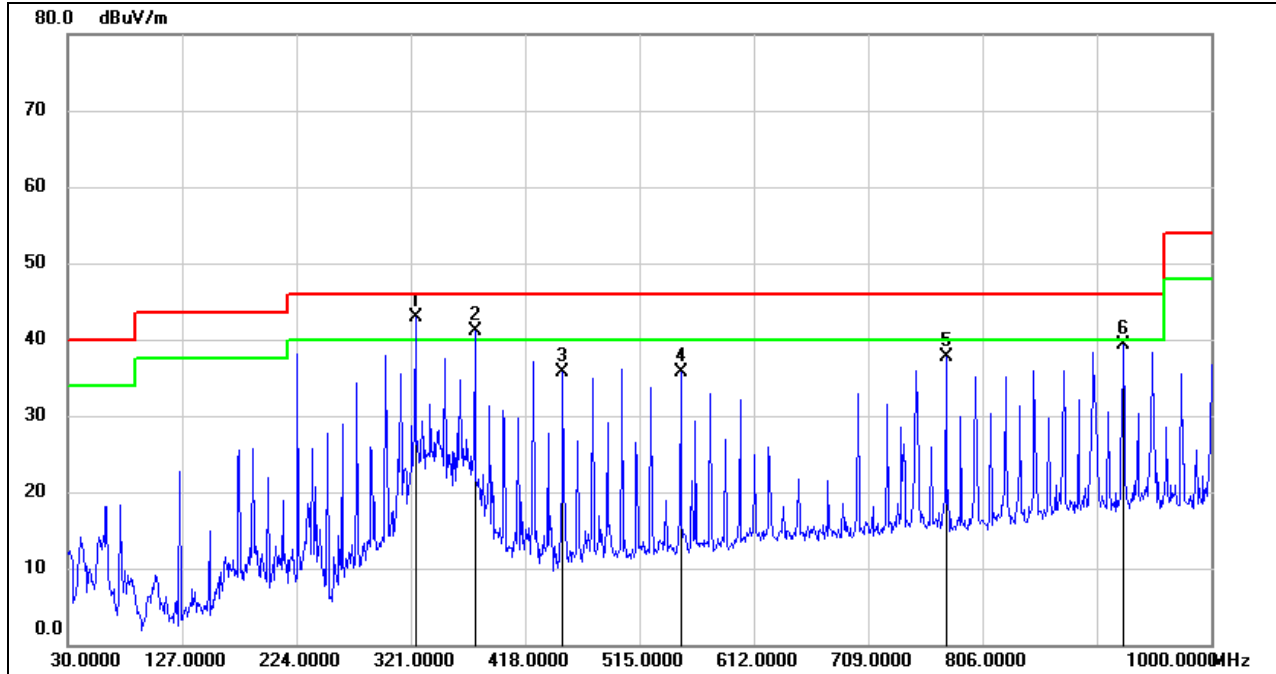

| No. | Frequency (MHz) | Reading (dBuV) | Correct (dB/m) | Result (dBuV/m) | Limit (dBuV/m) | Margin (dB) | Remark |
|-----|-----------------|----------------|----------------|-----------------|----------------|-------------|--------|
| 1 | 324.8800 | 57.65 | -14.73 | 42.92 | 46.00 | -3.08 | QP |
| 2 | 375.3200 | 54.90 | -13.79 | 41.11 | 46.00 | -4.89 | QP |
| 3 | 450.0100 | 48.14 | -12.49 | 35.65 | 46.00 | -10.35 | QP |
| 4 | 549.9200 | 46.12 | -10.49 | 35.63 | 46.00 | -10.37 | QP |
| 5 | 774.9600 | 45.33 | -7.60 | 37.73 | 46.00 | -8.27 | QP |
| 6 | 925.3100 | 44.04 | -4.76 | 39.28 | 46.00 | -6.72 | QP |

- Note: 1. Result Level = Read Level + Correct Factor.
 2. If Peak Result complies with QP limit, QP Result is deemed to comply with QP limit.
 3. Test setup: RBW: 120 kHz, VBW: 300 kHz, Sweep time: auto.

SPURIOUS EMISSIONS (MID CHANNEL, WORST-CASE CONFIGURATION, VERTICAL)

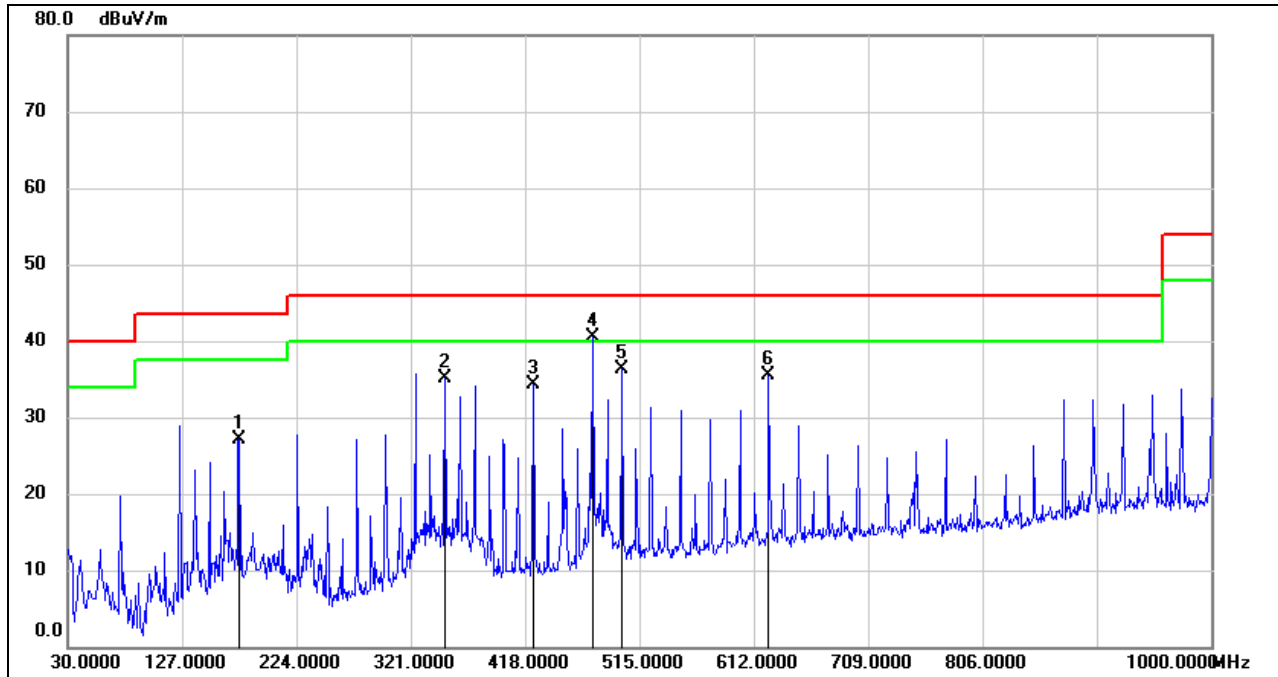

| No. | Frequency (MHz) | Reading (dBuV) | Correct (dB/m) | Result (dBuV/m) | Limit (dBuV/m) | Margin (dB) | Remark |
|-----|-----------------|----------------|----------------|-----------------|----------------|-------------|--------|
| 1 | 175.5000 | 44.14 | -17.07 | 27.07 | 43.50 | -16.43 | QP |
| 2 | 350.1000 | 49.40 | -14.32 | 35.08 | 46.00 | -10.92 | QP |
| 3 | 424.7900 | 47.08 | -12.86 | 34.22 | 46.00 | -11.78 | QP |
| 4 | 475.2300 | 52.35 | -11.90 | 40.45 | 46.00 | -5.55 | QP |
| 5 | 500.4500 | 47.79 | -11.46 | 36.33 | 46.00 | -9.67 | QP |
| 6 | 624.6100 | 44.74 | -9.31 | 35.43 | 46.00 | -10.57 | QP |

- Note: 1. Result Level = Read Level + Correct Factor.
 2. If Peak Result complies with QP limit, QP Result is deemed to comply with QP limit.
 3. Test setup: RBW: 120 kHz, VBW: 300 kHz, Sweep time: auto

Note: All the modes have been tested, only the worst data was recorded in the report.

8.6. SPURIOUS EMISSIONS BELOW 30 MHz

8.6.1. BLE_1M MODE

SPURIOUS EMISSIONS (MID CHANNEL, LOOP ANTENNA FACE ON TO THE EUT, WORST-CASE CONFIGURATION)

9 kHz ~ 150 kHz

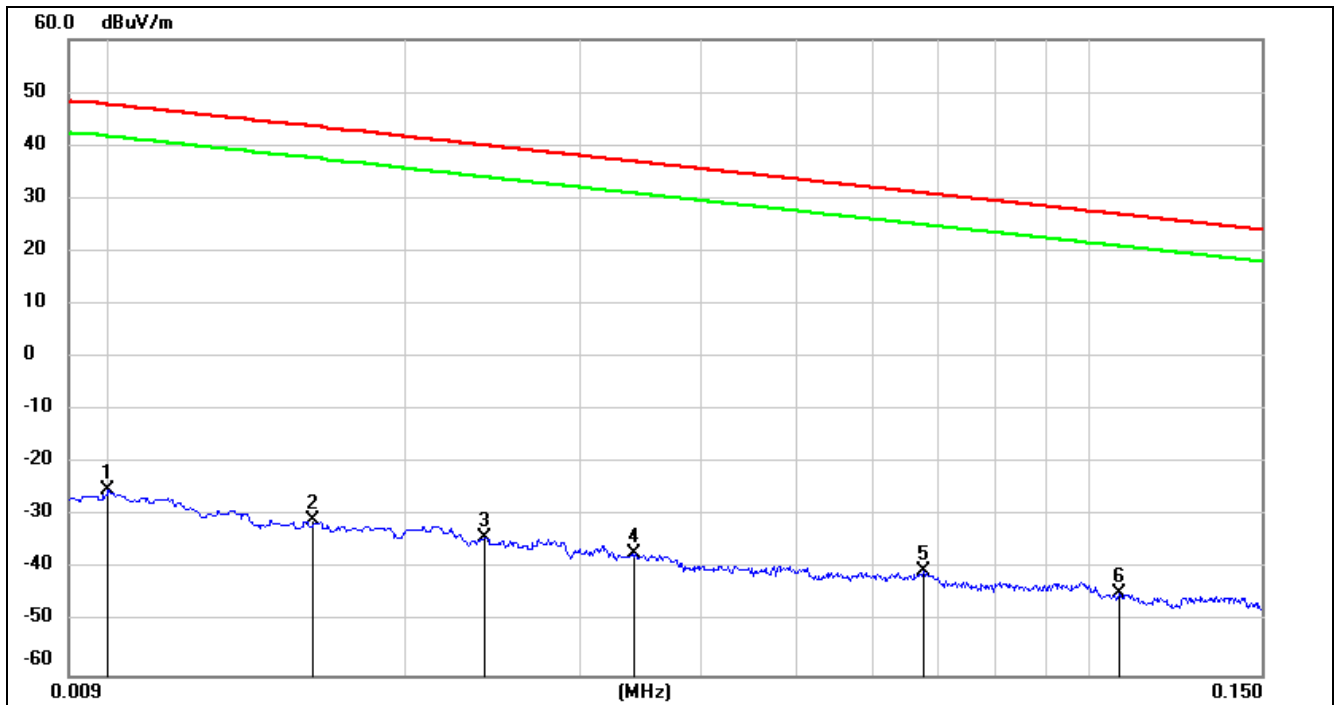

| No. | Frequency (MHz) | Reading (dBuV) | Correct (dB/m) | FCC Result (dBuV/m) | FCC Limit (dBuV/m) | ISED Result (dBuA/m) | ISED Limit (dBuA/m) | Margin (dB) | Remark |
|-----|--------------------|-------------------|-------------------|---------------------------|--------------------------|----------------------------|---------------------------|----------------|--------|
| 1 | 0.0100 | 76.22 | -101.40 | -25.18 | 47.6 | -76.68 | -3.90 | -72.78 | peak |
| 2 | 0.0160 | 70.47 | -101.37 | -30.9 | 43.52 | -82.40 | -7.98 | -74.42 | peak |
| 3 | 0.0240 | 67.32 | -101.36 | -34.04 | 40 | -85.54 | -11.50 | -74.04 | peak |
| 4 | 0.0342 | 64.36 | -101.41 | -37.05 | 36.92 | -88.55 | -14.58 | -73.97 | peak |
| 5 | 0.0675 | 61.14 | -101.56 | -40.42 | 31.02 | -91.92 | -20.48 | -71.44 | peak |
| 6 | 0.1073 | 57.30 | -101.77 | -44.47 | 26.99 | -95.97 | -24.51 | -71.46 | peak |

Note: 1. Measurement = Reading Level + Correct Factor (dBuA/m= dBuV/m- 20Log10[120π] = dBuV/m- 51.5).

2. If Peak Result complies with AV and QP limit, AV and QP Result are deemed to comply with AV limit.

3. All 3 polarizations (Horizontal, Face-on and Face-off) of the loop antenna had been tested, but only the worst data recorded in the report.



150 kHz ~ 490 kHz

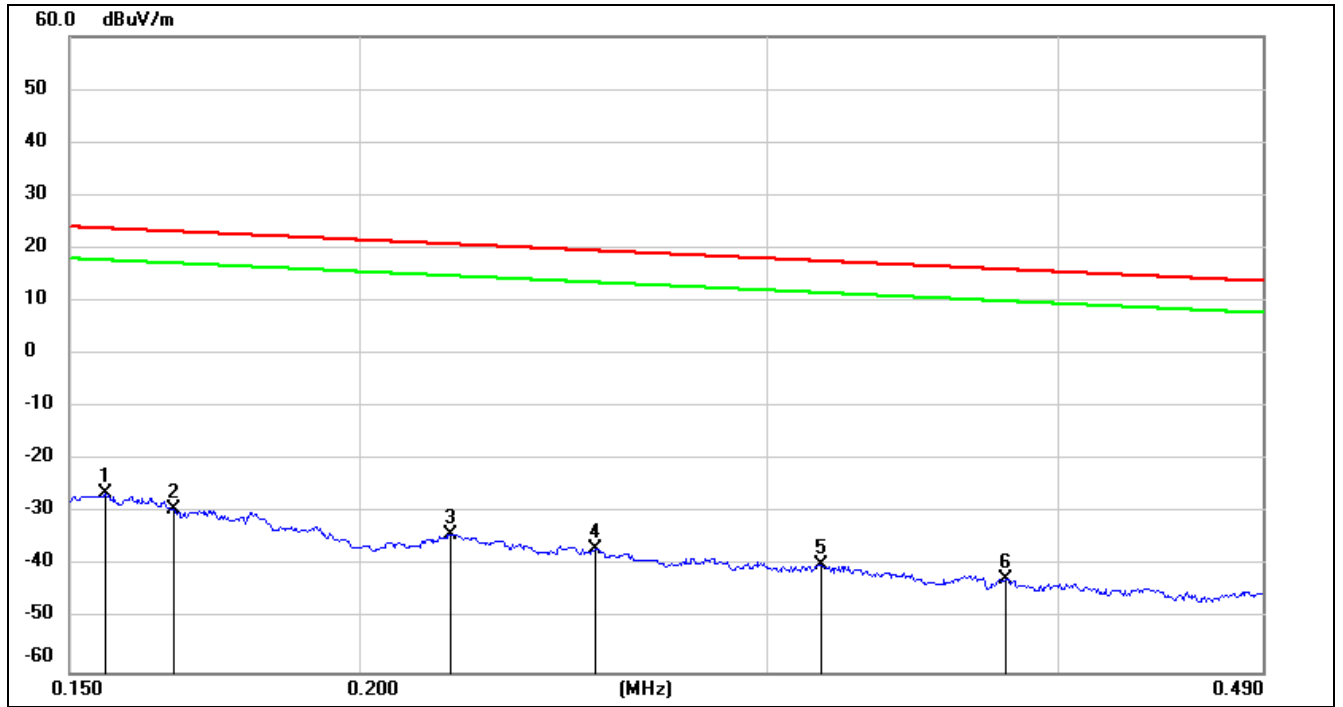

| No. | Frequency (MHz) | Reading (dBuV) | Correct (dB/m) | FCC Result (dBuV/m) | FCC Limit (dBuV/m) | ISED Result (dBuA/m) | ISED Limit (dBuA/m) | Margin (dB) | Remark |
|-----|--------------------|-------------------|-------------------|---------------------------|--------------------------|----------------------------|---------------------------|----------------|--------|
| 1 | 0.1554 | 75.27 | -101.65 | -26.38 | 23.77 | -77.88 | -27.73 | -50.15 | peak |
| 2 | 0.1663 | 72.28 | -101.66 | -29.38 | 23.19 | -80.88 | -28.31 | -52.57 | peak |
| 3 | 0.2190 | 67.77 | -101.75 | -33.98 | 20.79 | -85.48 | -30.71 | -54.77 | peak |
| 4 | 0.2530 | 65.14 | -101.80 | -36.66 | 19.54 | -88.16 | -31.96 | -56.20 | peak |
| 5 | 0.3163 | 62.20 | -101.87 | -39.67 | 17.6 | -91.17 | -33.90 | -57.27 | peak |
| 6 | 0.3800 | 59.52 | -101.94 | -42.42 | 16.01 | -93.92 | -35.49 | -58.43 | peak |

Note: 1. Measurement = Reading Level + Correct Factor (dBuA/m= dBuV/m- 20Log10[120π] = dBuV/m- 51.5).

2. If Peak Result complies with AV and QP limit, AV and QP Result are deemed to comply with AV limit.

3. All 3 polarizations (Horizontal, Face-on and Face-off) of the loop antenna had been tested, but only the worst data recorded in the report.



490 kHz ~ 30 MHz

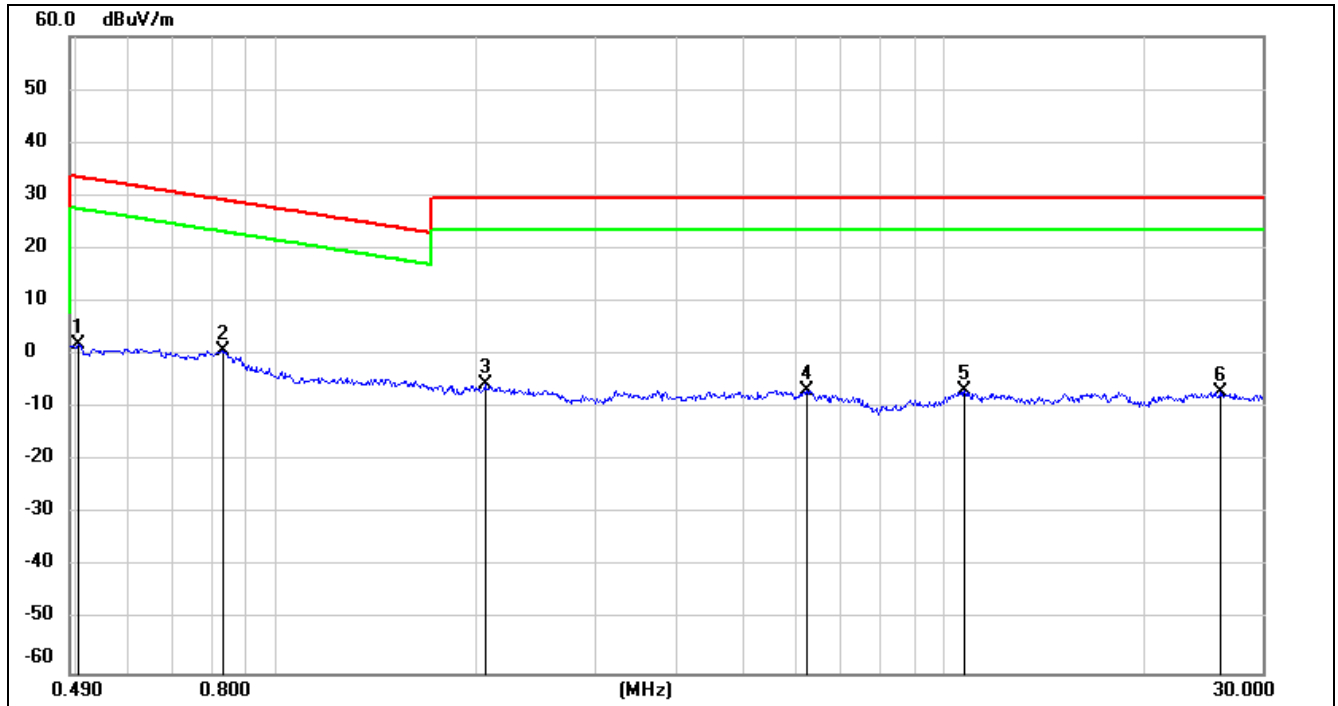

| No. | Frequency (MHz) | Reading (dBuV) | Correct (dB/m) | FCC Result (dBuV/m) | FCC Limit (dBuV/m) | ISED Result (dBuA/m) | ISED Limit (dBuA/m) | Margin (dB) | Remark |
|-----|-----------------|----------------|----------------|---------------------|--------------------|----------------------|---------------------|-------------|--------|
| 1 | 0.5039 | 63.93 | -62.07 | 1.86 | 33.56 | -49.64 | -17.94 | -31.70 | peak |
| 2 | 0.8296 | 62.94 | -62.17 | 0.77 | 29.23 | -50.73 | -22.27 | -28.46 | peak |
| 3 | 2.0539 | 56.20 | -61.81 | -5.61 | 29.54 | -57.11 | -21.96 | -35.15 | peak |
| 4 | 6.2445 | 54.63 | -61.32 | -6.69 | 29.54 | -58.19 | -21.96 | -36.23 | peak |
| 5 | 10.7299 | 53.98 | -60.83 | -6.85 | 29.54 | -58.35 | -21.96 | -36.39 | peak |
| 6 | 25.8978 | 53.26 | -60.36 | -7.1 | 29.54 | -58.60 | -21.96 | -36.64 | peak |

Note: 1. Measurement = Reading Level + Correct Factor (dBuA/m= dBuV/m- 20Log10[120π] = dBuV/m- 51.5).

2. If Peak Result complies with AV and QP limit, AV and QP Result are deemed to comply with AV limit.

3. All 3 polarizations (Horizontal, Face-on and Face-off) of the loop antenna had been tested, but only the worst data recorded in the report.

Note: All the modes have been tested, only the worst data was recorded in the report.

9. AC POWER LINE CONDUCTED EMISSIONS

LIMITS

Please refer to CFR 47 FCC §15.207 (a) and ISED RSS-Gen Clause 8.8

| FREQUENCY (MHz) | Quasi-peak | Average |
|-----------------|------------|-----------|
| 0.15 -0.5 | 66 - 56 * | 56 - 46 * |
| 0.50 -5.0 | 56.00 | 46.00 |
| 5.0 -30.0 | 60.00 | 50.00 |

TEST SETUP AND PROCEDURE

Refer to ANSI C63.10-2013 clause 6.2.

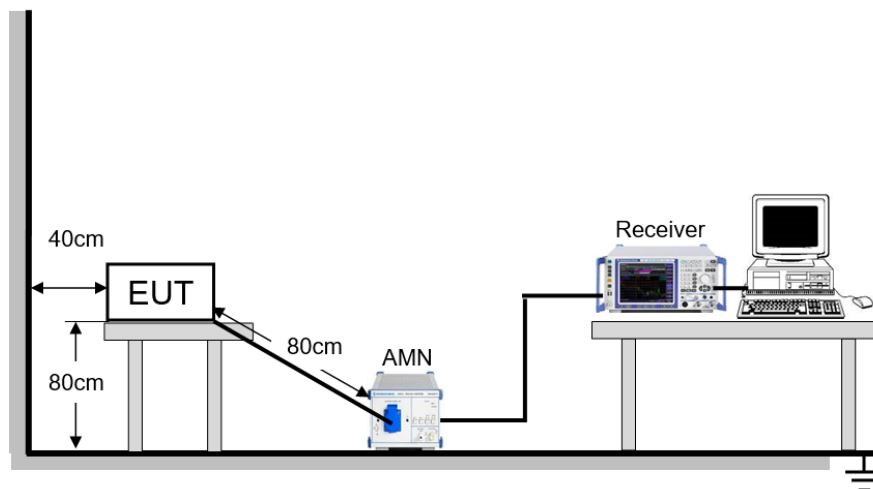

The EUT is put on a table of non-conducting material that is 80 cm high. The vertical conducting wall of shielding is located 40 cm to the rear of the EUT. The power line of the EUT is connected to the AC mains through a Artificial Mains Network (A.M.N.). A EMI Measurement Receiver (R&S Test Receiver ESR3) is used to test the emissions from both sides of AC line. According to the requirements in Section 6.2 of ANSI C63.10-2013. Conducted emissions from the EUT measured in the frequency range between 0.15 MHz and 30 MHz using CISPR Quasi-Peak and average detector mode. The bandwidth of EMI test receiver is set at 9 kHz.

The arrangement of the equipment is installed to meet the standards and operating in a manner, which tends to maximize its emission characteristics in a normal application.

TEST ENVIRONMENT

| | | | |
|---------------------|---------|-------------------|----------------|
| Temperature | 24.7 °C | Relative Humidity | 63.7 % |
| Atmosphere Pressure | 101 kPa | Test Voltage | AC 120 V/60 Hz |

RESULTS

9.1. BLE_1M MODE

LINE L RESULTS (MID CHANNEL, WORST-CASE CONFIGURATION)

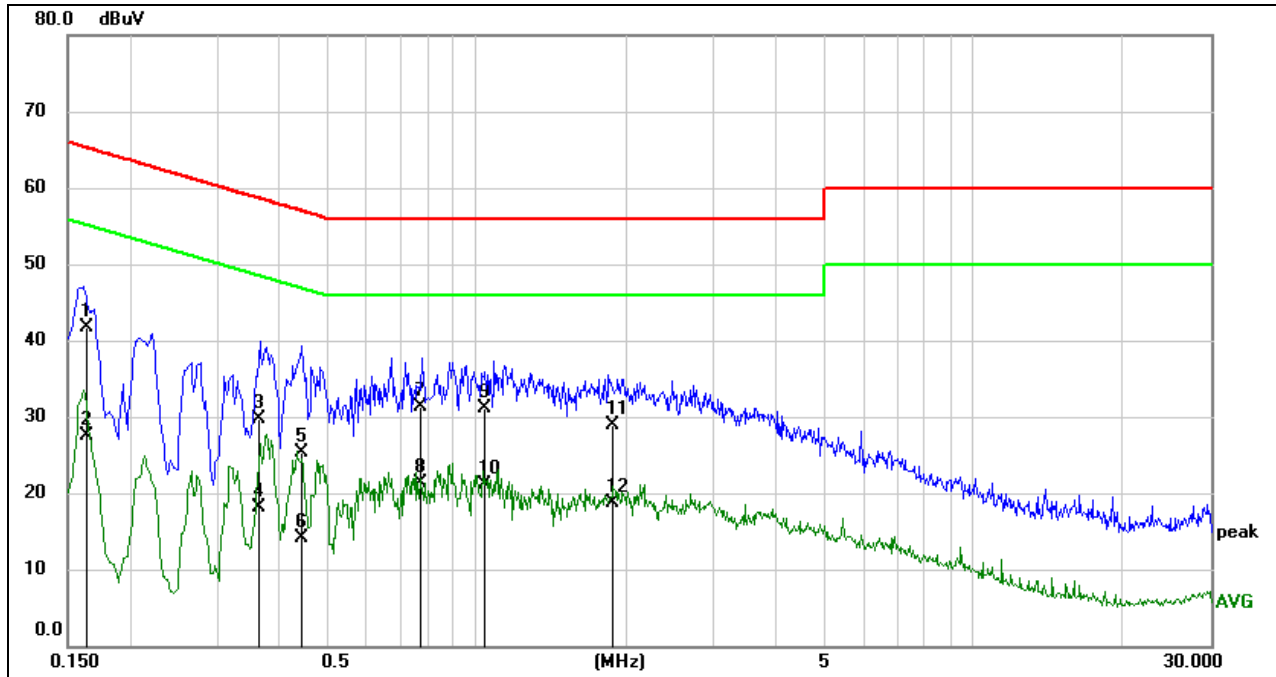

| No. | Frequency (MHz) | Reading (dBuV) | Correct (dB) | Result (dBuV) | Limit (dBuV) | Margin (dB) | Remark |
|-----|-----------------|----------------|--------------|---------------|--------------|-------------|--------|
| 1 | 0.1647 | 32.19 | 9.52 | 41.71 | 65.22 | -23.51 | QP |
| 2 | 0.1647 | 18.08 | 9.52 | 27.60 | 55.22 | -27.62 | AVG |
| 3 | 0.3634 | 20.20 | 9.54 | 29.74 | 58.65 | -28.91 | QP |
| 4 | 0.3634 | 8.59 | 9.54 | 18.13 | 48.65 | -30.52 | AVG |
| 5 | 0.4454 | 15.81 | 9.52 | 25.33 | 56.96 | -31.63 | QP |
| 6 | 0.4454 | 4.51 | 9.52 | 14.03 | 46.96 | -32.93 | AVG |
| 7 | 0.7740 | 21.78 | 9.50 | 31.28 | 56.00 | -24.72 | QP |
| 8 | 0.7740 | 11.90 | 9.50 | 21.40 | 46.00 | -24.60 | AVG |
| 9 | 1.0358 | 21.64 | 9.51 | 31.15 | 56.00 | -24.85 | QP |
| 10 | 1.0358 | 11.59 | 9.51 | 21.10 | 46.00 | -24.90 | AVG |
| 11 | 1.8852 | 19.29 | 9.61 | 28.90 | 56.00 | -27.10 | QP |
| 12 | 1.8852 | 9.18 | 9.61 | 18.79 | 46.00 | -27.21 | AVG |

Note: 1. Result = Reading + Correct Factor.

2. If QP Result complies with AV limit, AV Result is deemed to comply with AV limit.

3. Test setup: RBW: 200 Hz (9 kHz ~ 150 kHz), 9 kHz (150 kHz ~ 30 MHz).

4. Step size: 80 Hz (0.009 MHz ~ 0.15 MHz), 4 kHz (0.15 MHz ~ 30 MHz), Scan time: auto.

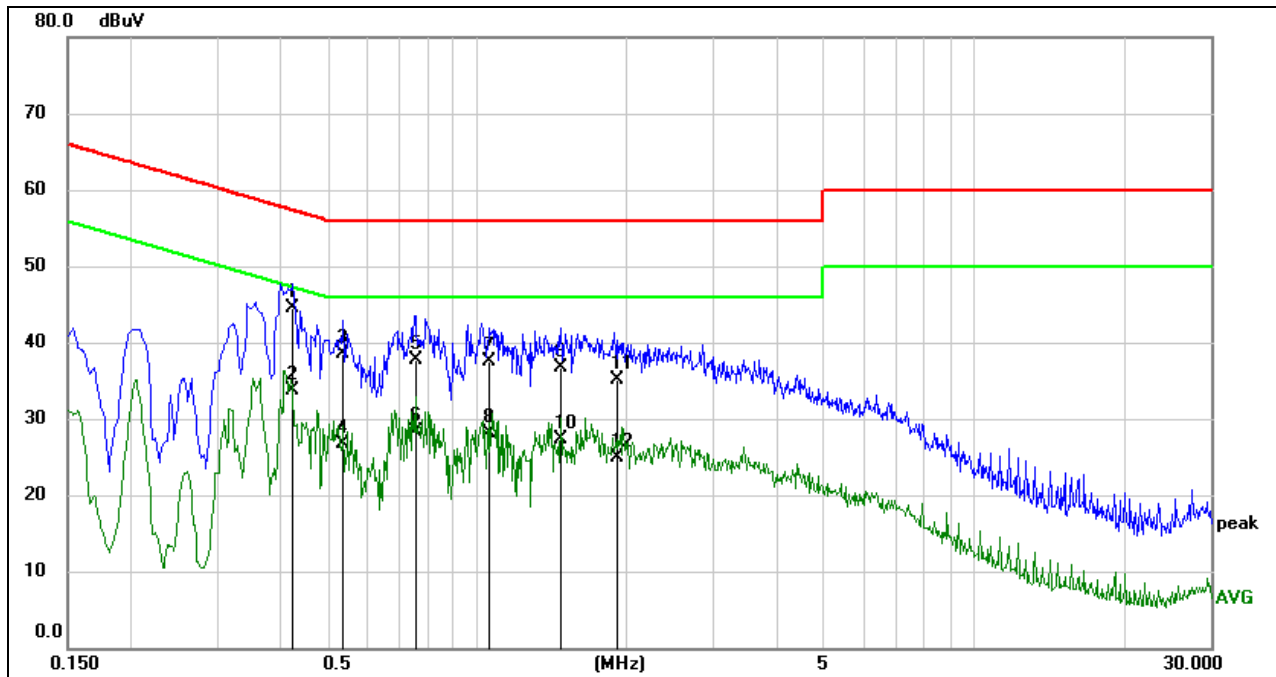
**LINE N RESULTS (MID CHANNEL, WORST-CASE CONFIGURATION)**

| No. | Frequency (MHz) | Reading (dBuV) | Correct (dB) | Result (dBuV) | Limit (dBuV) | Margin (dB) | Remark |
|-----|-----------------|----------------|--------------|---------------|--------------|-------------|--------|
| 1 | 0.4237 | 34.96 | 9.53 | 44.49 | 57.38 | -12.89 | QP |
| 2 | 0.4237 | 24.26 | 9.53 | 33.79 | 47.38 | -13.59 | AVG |
| 3 | 0.5400 | 28.98 | 9.50 | 38.48 | 56.00 | -17.52 | QP |
| 4 | 0.5400 | 17.27 | 9.50 | 26.77 | 46.00 | -19.23 | AVG |
| 5 | 0.7543 | 28.14 | 9.50 | 37.64 | 56.00 | -18.36 | QP |
| 6 | 0.7543 | 18.84 | 9.50 | 28.34 | 46.00 | -17.66 | AVG |
| 7 | 1.0621 | 28.05 | 9.52 | 37.57 | 56.00 | -18.43 | QP |
| 8 | 1.0621 | 18.54 | 9.52 | 28.06 | 46.00 | -17.94 | AVG |
| 9 | 1.4716 | 27.12 | 9.57 | 36.69 | 56.00 | -19.31 | QP |
| 10 | 1.4716 | 17.77 | 9.57 | 27.34 | 46.00 | -18.66 | AVG |
| 11 | 1.9170 | 25.51 | 9.62 | 35.13 | 56.00 | -20.87 | QP |
| 12 | 1.9170 | 15.30 | 9.62 | 24.92 | 46.00 | -21.08 | AVG |

Note: 1. Result = Reading + Correct Factor.

2. If QP Result complies with AV limit, AV Result is deemed to comply with AV limit.

3. Test setup: RBW: 200 Hz (9 kHz ~ 150 kHz), 9 kHz (150 kHz ~ 30 MHz).

4. Step size: 80 Hz (0.009 MHz ~ 0.15 MHz), 4 kHz (0.15 MHz ~ 30 MHz), Scan time: auto.

Note: All the modes have been tested, only the worst data was recorded in the report.



10. ANTENNA REQUIREMENTS

APPLICABLE REQUIREMENTS

Please refer to FCC §15.203

An intentional radiator shall be designed to ensure that no antenna other than that furnished by the responsible party shall be used with the device. The use of a permanently attached antenna or of an antenna that uses a unique coupling to the intentional radiator shall be considered sufficient to comply with the provisions of this section. The manufacturer may design the unit so that a broken antenna can be replaced by the user, but the use of a standard antenna jack or electrical connector is prohibited.

Please refer to FCC §15.247(b)(4)

The conducted output power limit specified in paragraph (b) of this section is based on the use of antennas with directional gains that do not exceed 6 dBi. Except as shown in paragraph (c) of this section, if transmitting antennas of directional gain greater than 6 dBi are used, the conducted output power from the intentional radiator shall be reduced below the stated values in paragraphs (b)(1), (b)(2), and (b)(3) of this section, as appropriate, by the amount in dB that the directional gain of the antenna exceeds 6 dBi.

RESULTS

Complies



11. Appendix

11.1. Appendix A: DTS Bandwidth

11.1.1. Test Result

| Test Mode | Antenna | Channel | DTS BW [MHz] | FL[MHz] | FH[MHz] | Limit[MHz] | Verdict |
|-----------|---------|---------|--------------|---------|---------|------------|---------|
| BLE_1M | Ant1 | 2402 | 0.72 | 2401.65 | 2402.37 | 0.5 | PASS |
| | | 2440 | 0.72 | 2439.65 | 2440.37 | 0.5 | PASS |
| | | 2480 | 0.72 | 2479.66 | 2480.38 | 0.5 | PASS |
| BLE_2M | Ant1 | 2402 | 1.10 | 2401.44 | 2402.54 | 0.5 | PASS |
| | | 2440 | 1.10 | 2439.45 | 2440.55 | 0.5 | PASS |
| | | 2480 | 1.10 | 2479.45 | 2480.55 | 0.5 | PASS |

11.1.2. Test Graphs

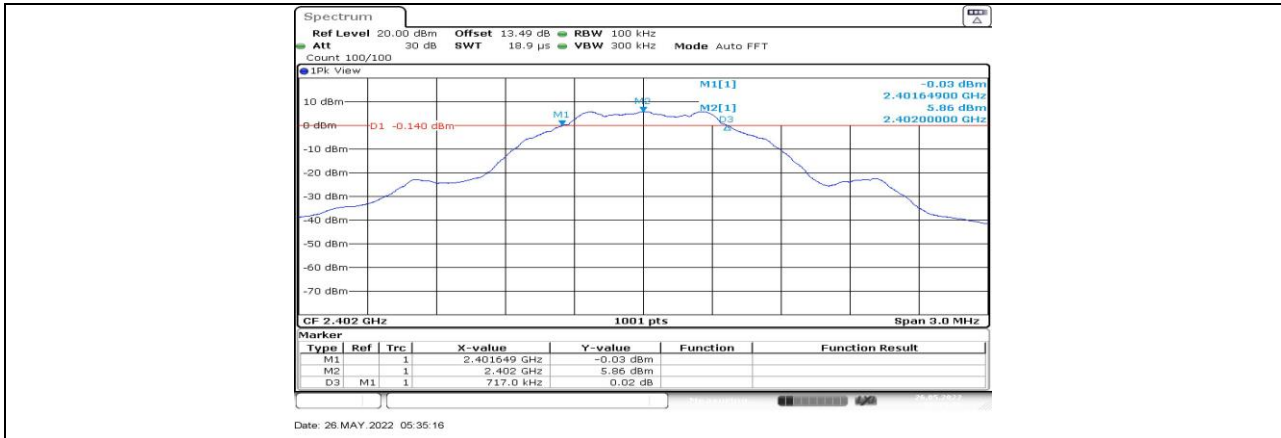

BLE_1M_Ant1_2402

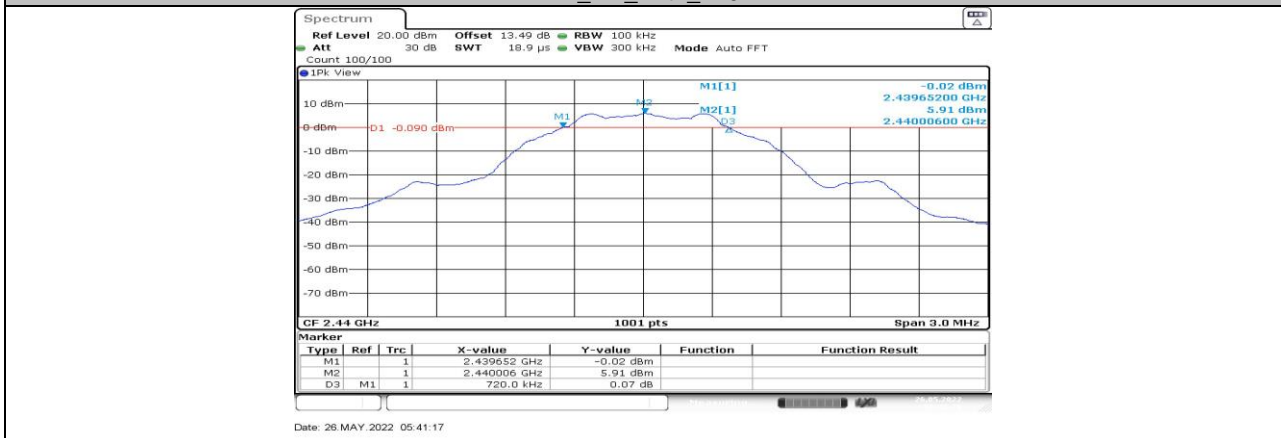

BLE_1M_Ant1_2440

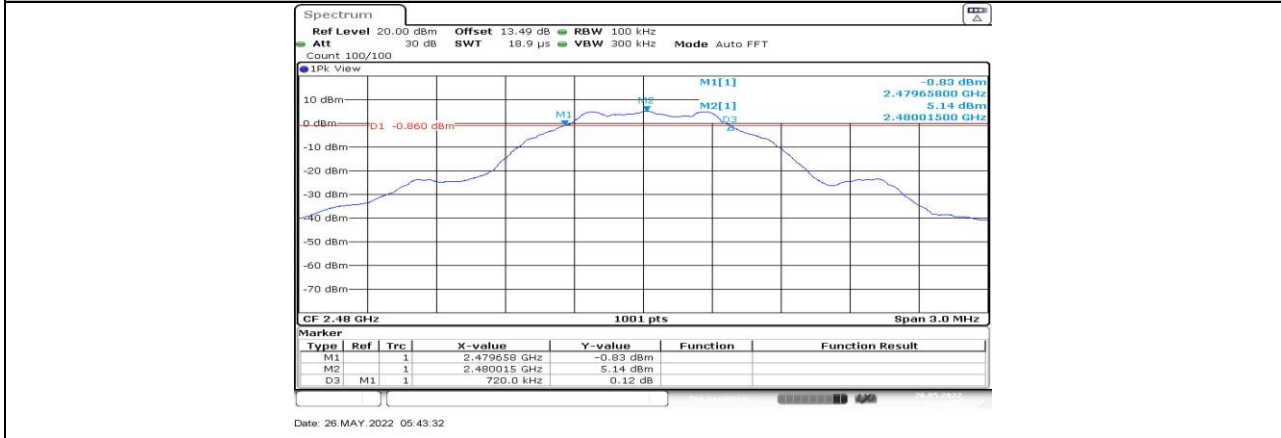

BLE_1M_Ant1_2480

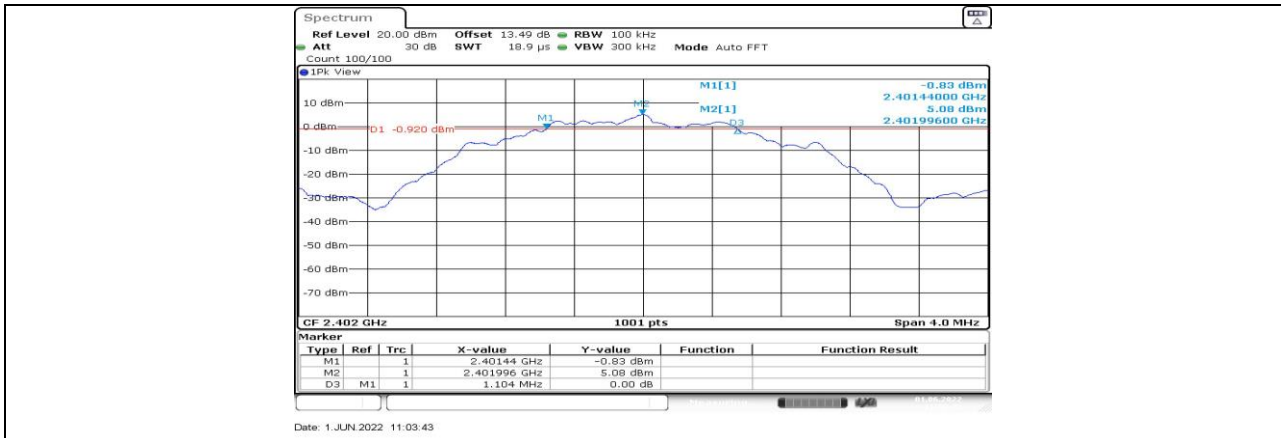

BLE_2M_Ant1_2402

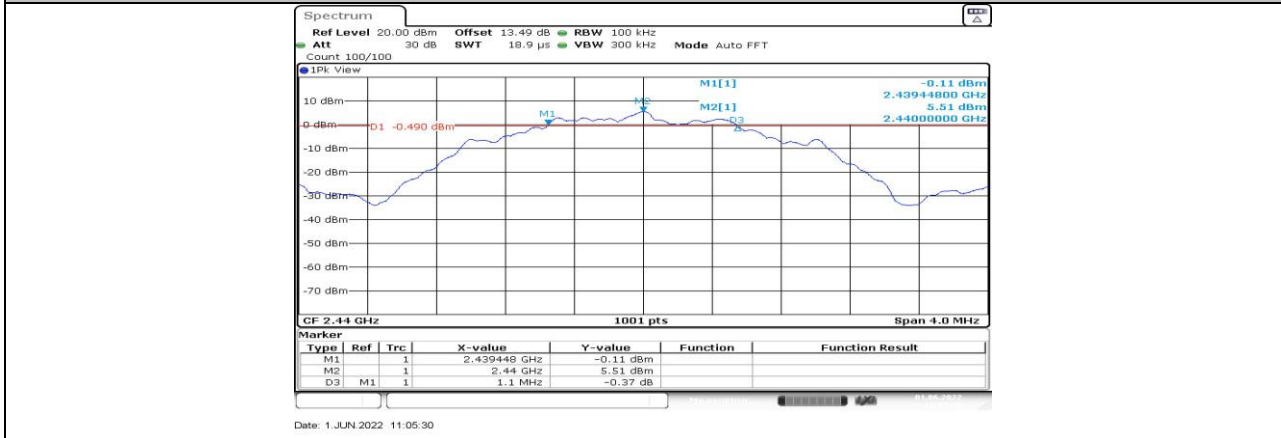

BLE_2M_Ant1_2440

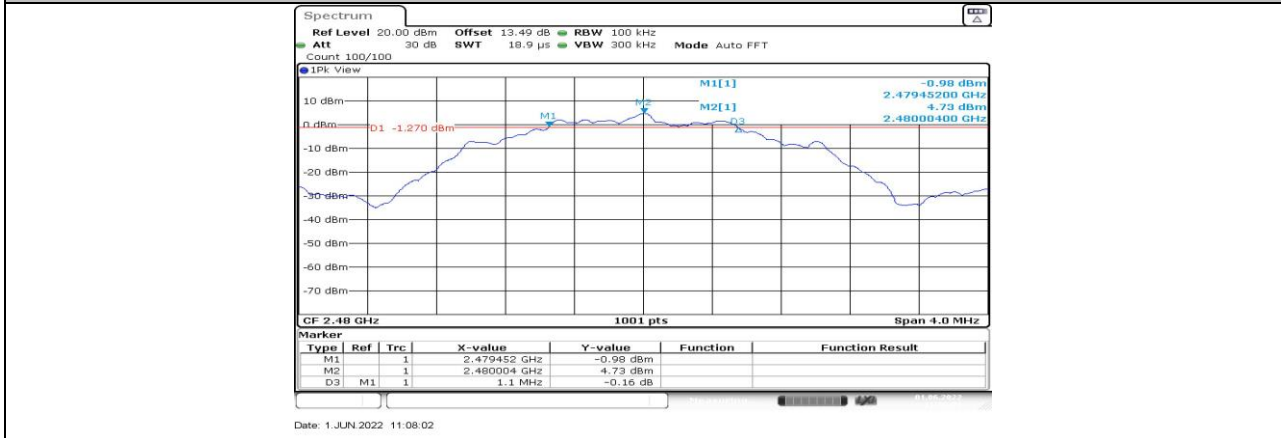

BLE_2M_Ant1_2480



11.2. Appendix B: Occupied Channel Bandwidth

11.2.1. Test Result

| Test Mode | Antenna | Channel | OCB [MHz] | FL[MHz] | FH[MHz] | Verdict |
|-----------|---------|---------|-----------|----------|----------|---------|
| BLE_1M | Ant1 | 2402 | 1.063 | 2401.489 | 2402.551 | PASS |
| | | 2440 | 1.063 | 2439.493 | 2440.555 | PASS |
| | | 2480 | 1.063 | 2479.497 | 2480.559 | PASS |
| BLE_2M | Ant1 | 2402 | 2.07 | 2400.969 | 2403.039 | PASS |
| | | 2440 | 2.07 | 2438.973 | 2441.043 | PASS |
| | | 2480 | 2.07 | 2478.977 | 2481.047 | PASS |

11.2.2. Test Graphs

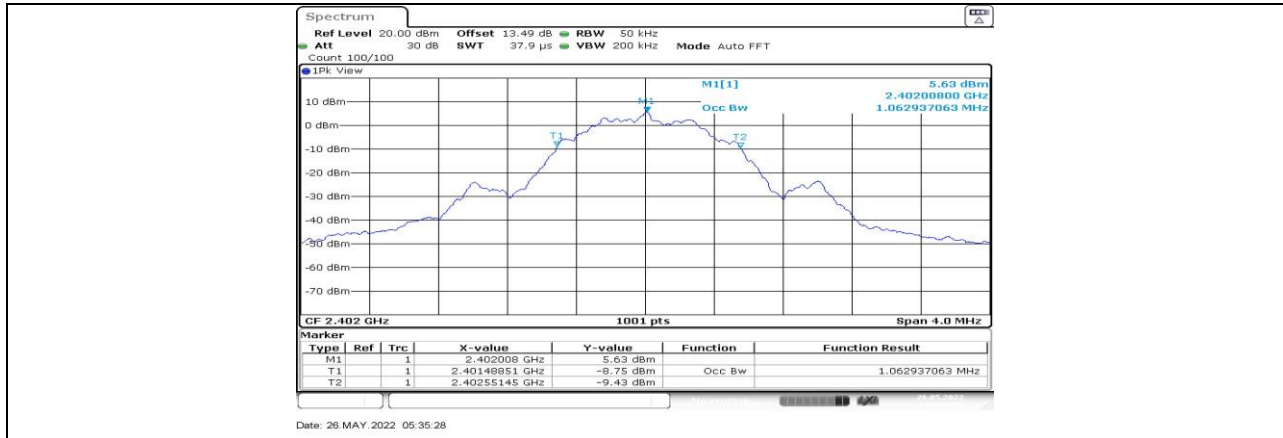

BLE_1M_Ant1_2402

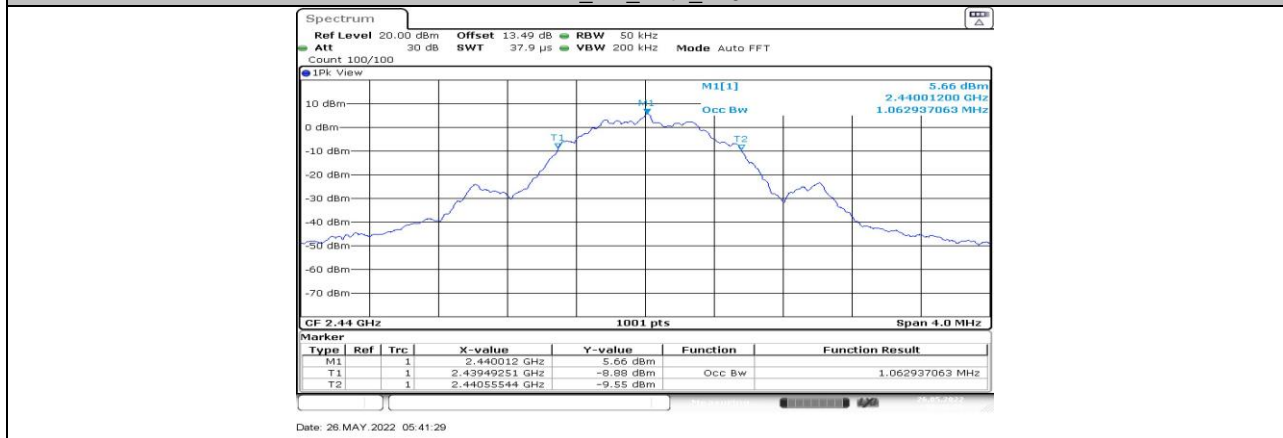

BLE_1M_Ant1_2440

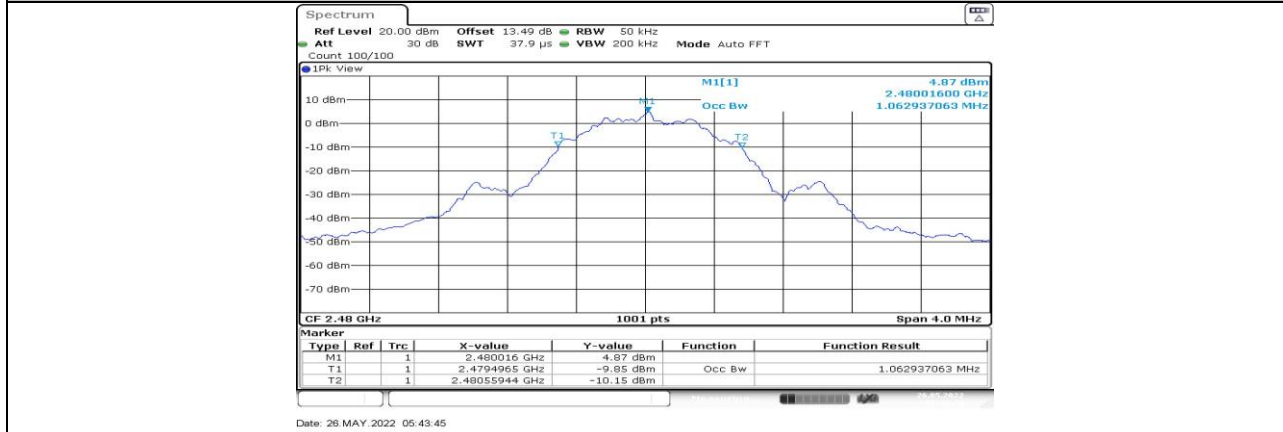

BLE_1M_Ant1_2480

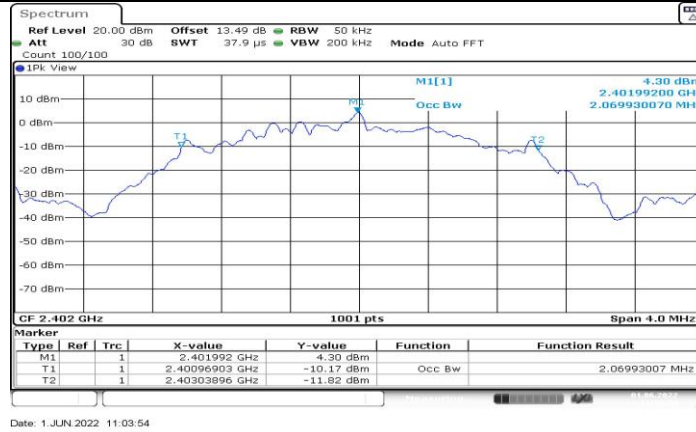

BLE_2M_Ant1_2402

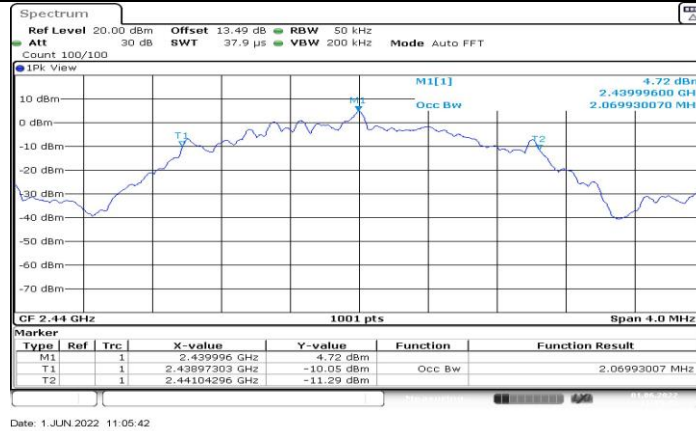

BLE_2M_Ant1_2440

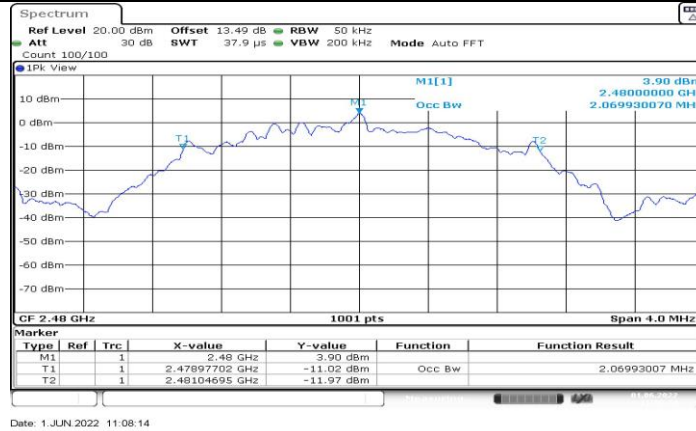

BLE_2M_Ant1_2480



11.3. Appendix C: Maximum conducted output power

11.3.1. Test Result

| Test Mode | Antenna | Channel | Peak Result[dBm] | Limit[dBm] | Verdict |
|-----------|---------|---------|------------------|------------|---------|
| BLE_1M | Ant1 | 2402 | 6.55 | ≤30 | PASS |
| | | 2440 | 6.58 | ≤30 | PASS |
| | | 2480 | 5.80 | ≤30 | PASS |
| BLE_2M | Ant1 | 2402 | 5.91 | ≤30 | PASS |
| | | 2440 | 6.30 | ≤30 | PASS |
| | | 2480 | 5.52 | ≤30 | PASS |

| Test Mode | Antenna | Channel | Average Result[dBm] | Limit[dBm] | Verdict |
|-----------|---------|---------|---------------------|------------|---------|
| BLE_1M | Ant1 | 2402 | 5.69 | ≤30 | PASS |
| | | 2440 | 5.66 | ≤30 | PASS |
| | | 2480 | 5.02 | ≤30 | PASS |
| BLE_2M | Ant1 | 2402 | 5.23 | ≤30 | PASS |
| | | 2440 | 5.81 | ≤30 | PASS |
| | | 2480 | 4.87 | ≤30 | PASS |



11.4. Appendix D: Maximum power spectral density

11.4.1. Test Result

| Test Mode | Antenna | Channel | Result[dBm/3kHz] | Limit[dBm/3kHz] | Verdict |
|-----------|---------|---------|------------------|-----------------|---------|
| BLE_1M | Ant1 | 2402 | -7.7 | ≤8.00 | PASS |
| | | 2440 | -7.76 | ≤8.00 | PASS |
| | | 2480 | -8.53 | ≤8.00 | PASS |
| BLE_2M | Ant1 | 2402 | -11.41 | ≤8.00 | PASS |
| | | 2440 | -11.15 | ≤8.00 | PASS |
| | | 2480 | -11.78 | ≤8.00 | PASS |

11.4.2. Test Graphs

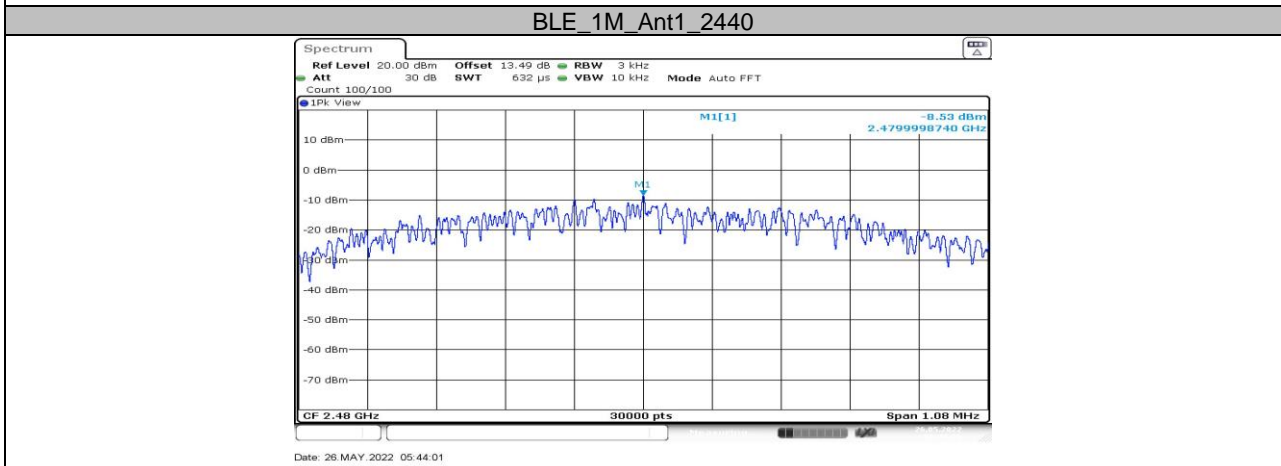
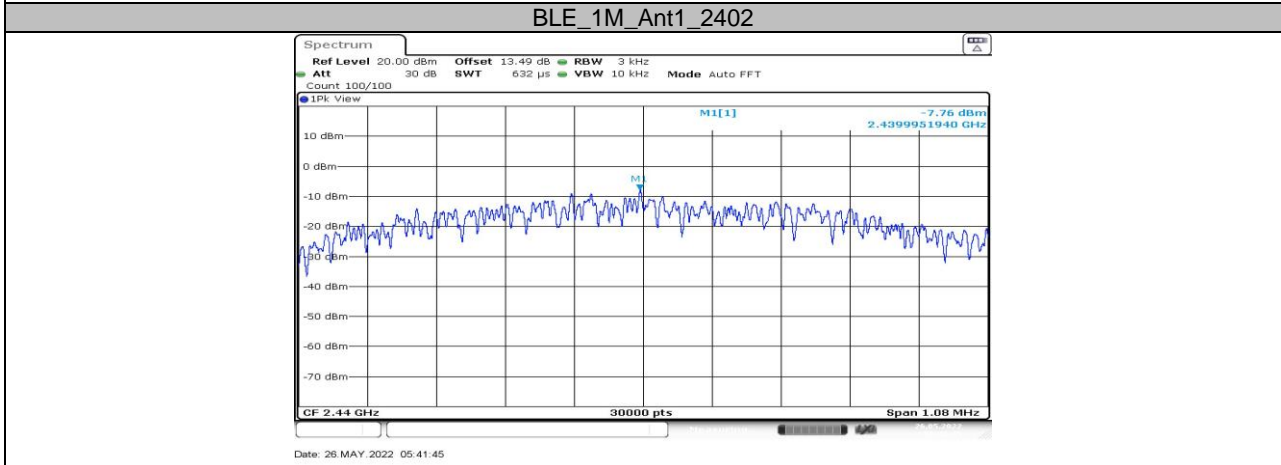
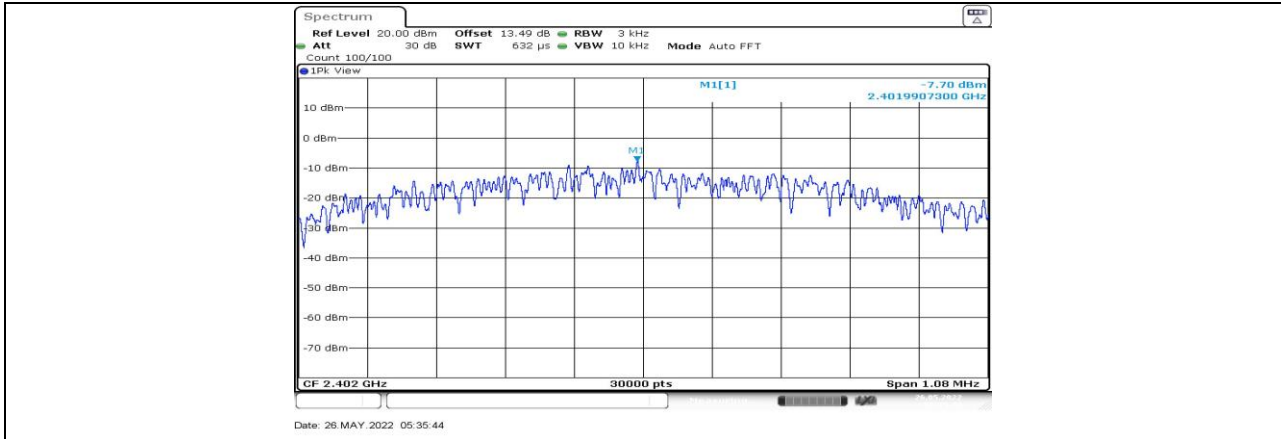

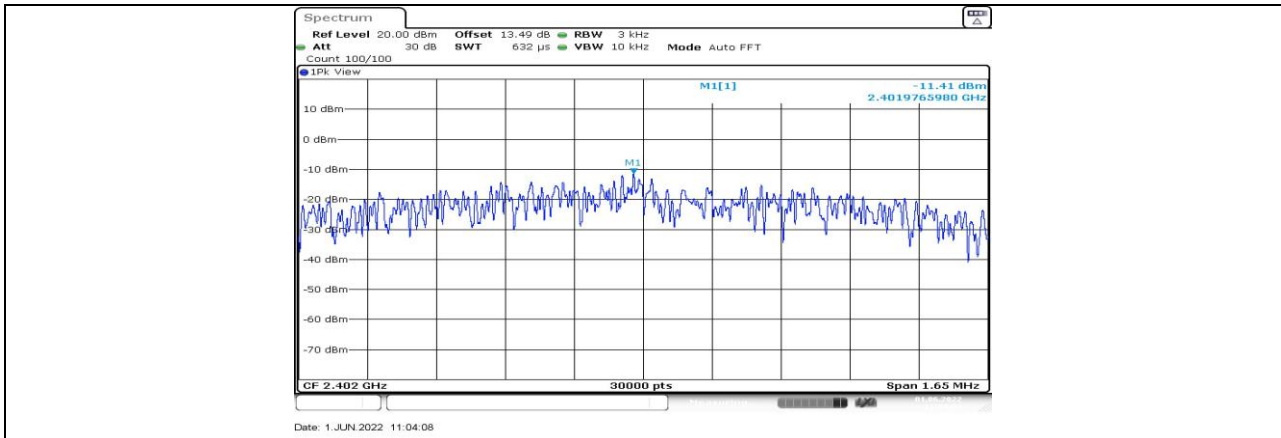

BLE_2M_Ant1_2402

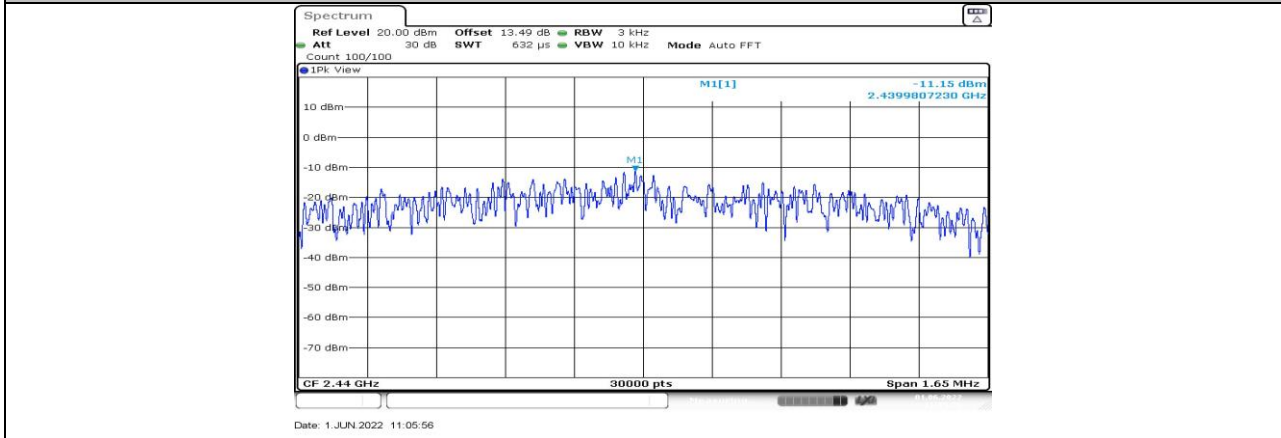

BLE_2M_Ant1_2440

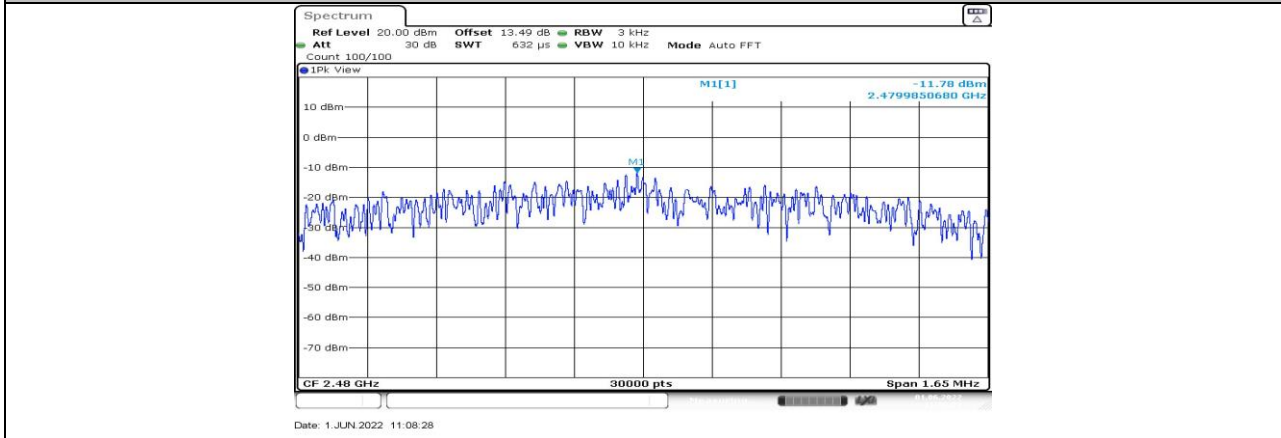

BLE_2M_Ant1_2480



11.5. Appendix E: Band edge measurements

11.5.1. Test Result

| Test Mode | Antenna | ChName | Channel | RefLevel[dBm] | Result[dBm] | Limit[dBm] | Verdict |
|-----------|---------|--------|---------|---------------|-------------|---------------|---------|
| BLE_1M | Ant1 | Low | 2402 | 5.88 | -46.05 | ≤ -14.12 | PASS |
| | | High | 2480 | 5.06 | -43.11 | ≤ -14.94 | PASS |
| BLE_2M | Ant1 | Low | 2402 | 5.10 | -26.18 | ≤ -14.9 | PASS |
| | | High | 2480 | 4.76 | -43.79 | ≤ -15.24 | PASS |

11.5.2. Test Graphs

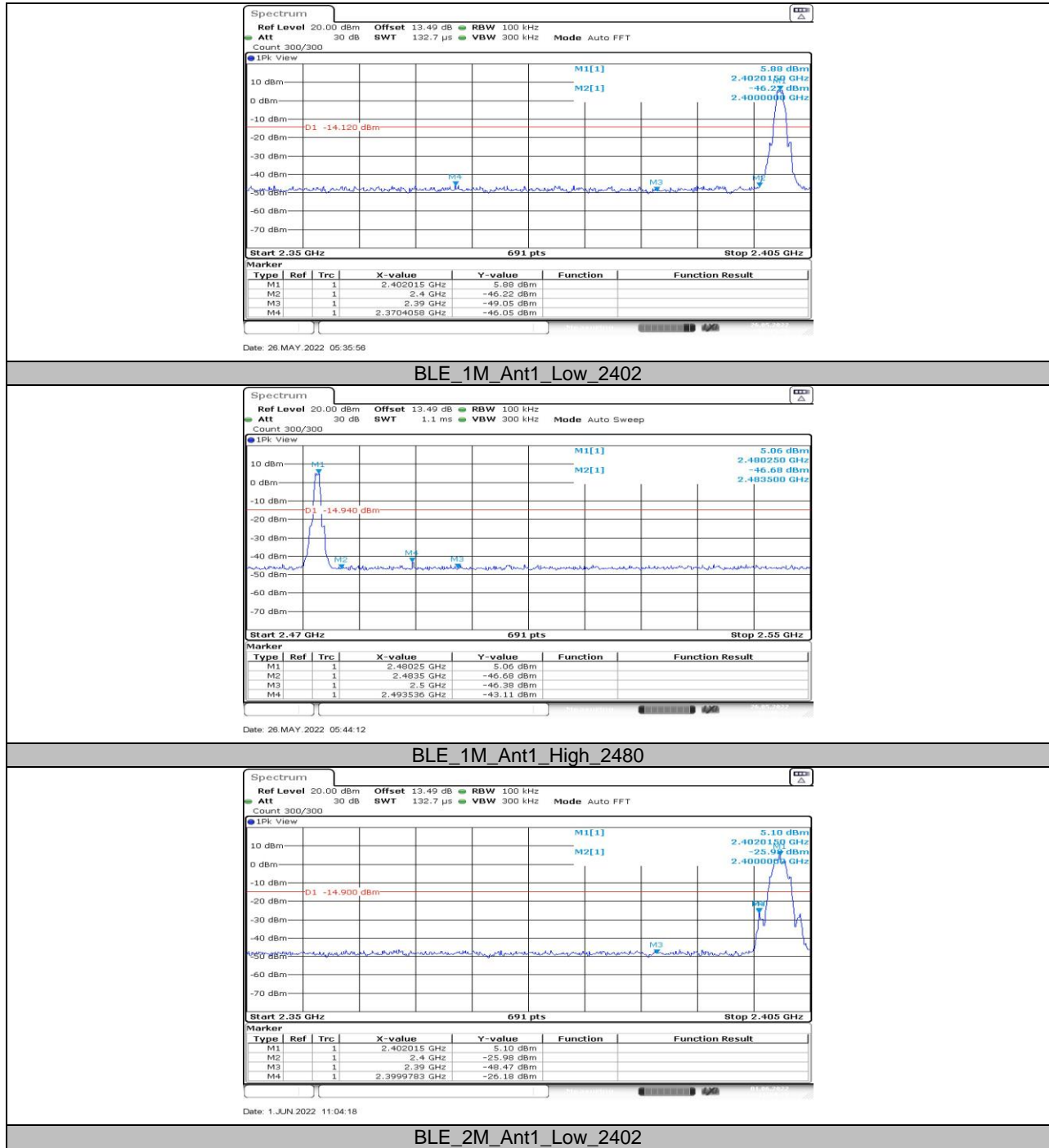

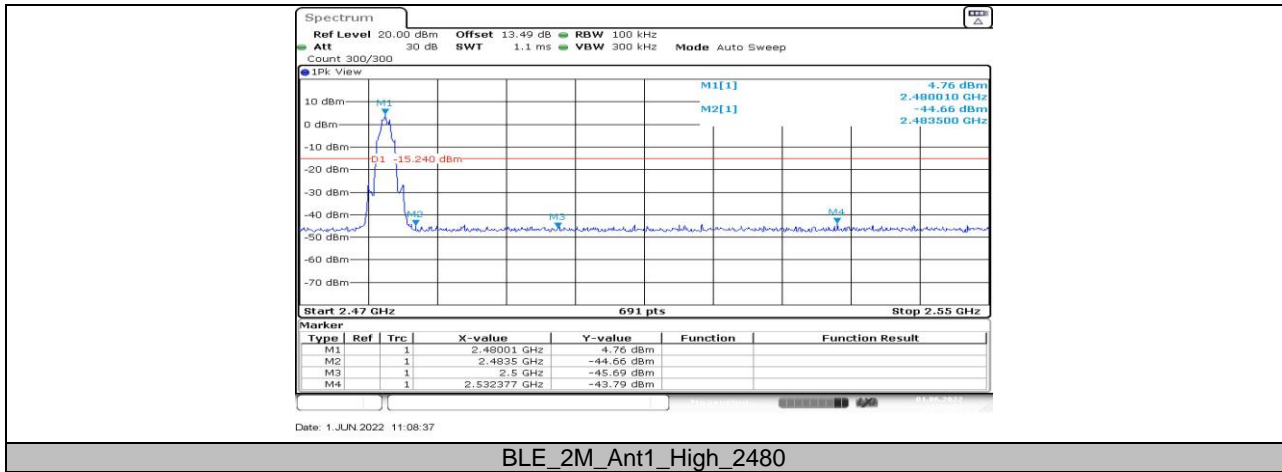

11.6. Appendix F: Conducted Spurious Emission
11.6.1. Test Result

| Test Mode | Antenna | Channel | FreqRange [MHz] | Result[dBm] | Limit[dBm] | Verdict |
|-----------|---------|---------|-----------------|-------------|------------|---------|
| BLE_1M | Ant1 | 2402 | Reference | 5.84 | --- | PASS |
| | | | 30~1000 | -54.61 | ≤-14.16 | PASS |
| | | | 1000~26500 | -45.64 | ≤-14.16 | PASS |
| | | 2440 | Reference | 5.88 | --- | PASS |
| | | | 30~1000 | -54.08 | ≤-14.12 | PASS |
| | | | 1000~26500 | -49.5 | ≤-14.12 | PASS |
| | | 2480 | Reference | 5.09 | --- | PASS |
| | | | 30~1000 | -54.59 | ≤-14.91 | PASS |
| | | | 1000~26500 | -48.82 | ≤-14.91 | PASS |
| BLE_2M | Ant1 | 2402 | Reference | 5.07 | --- | PASS |
| | | | 30~1000 | -54.28 | ≤-14.93 | PASS |
| | | | 1000~26500 | -49.41 | ≤-14.93 | PASS |
| | | 2440 | Reference | 5.50 | --- | PASS |
| | | | 30~1000 | -54.87 | ≤-14.5 | PASS |
| | | | 1000~26500 | -49.1 | ≤-14.5 | PASS |
| | | 2480 | Reference | 4.70 | --- | PASS |
| | | | 30~1000 | -54.35 | ≤-15.3 | PASS |
| | | | 1000~26500 | -49.22 | ≤-15.3 | PASS |

11.6.2. Test Graphs

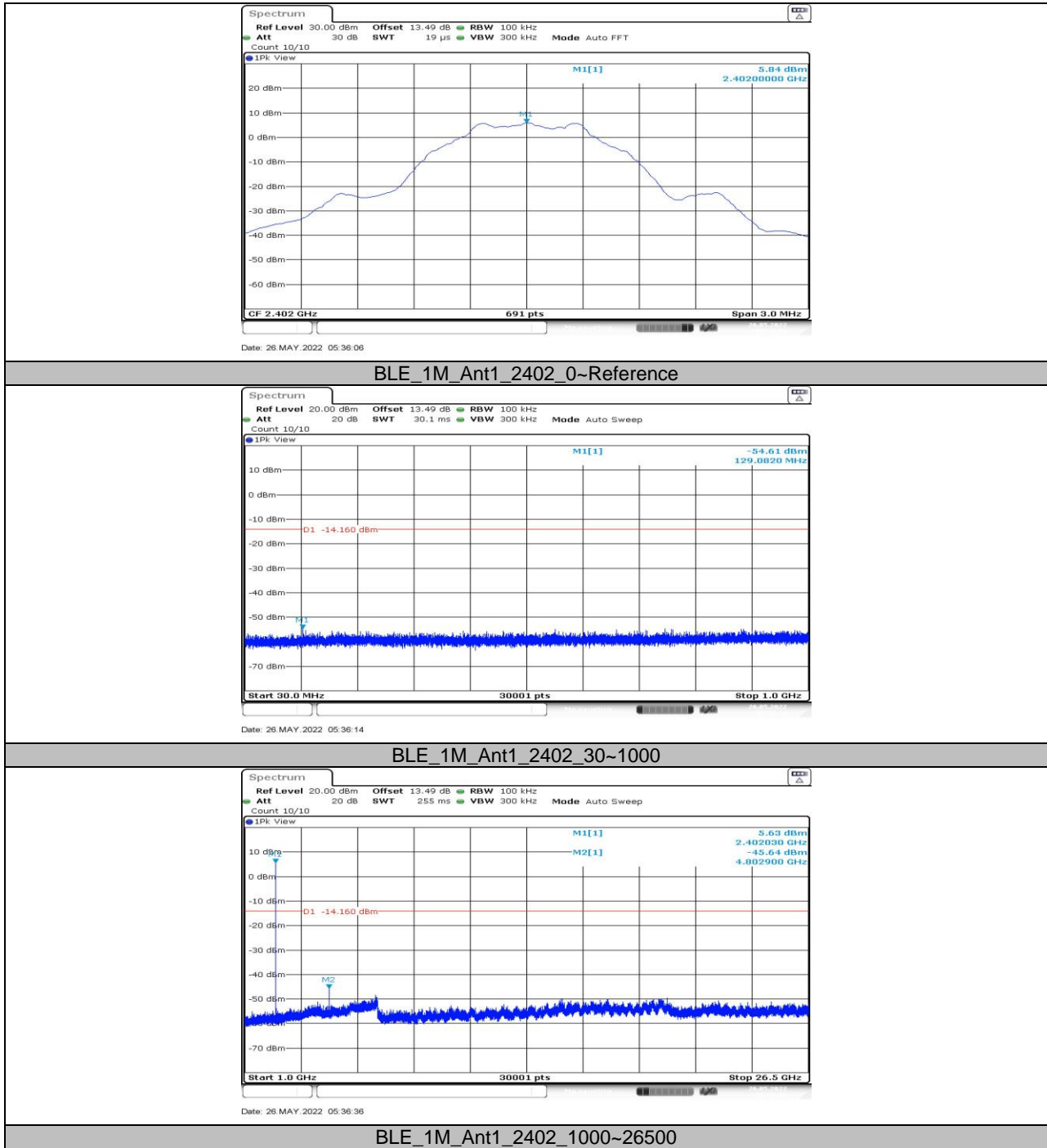



BLE_1M_Ant1_2440_0~Reference

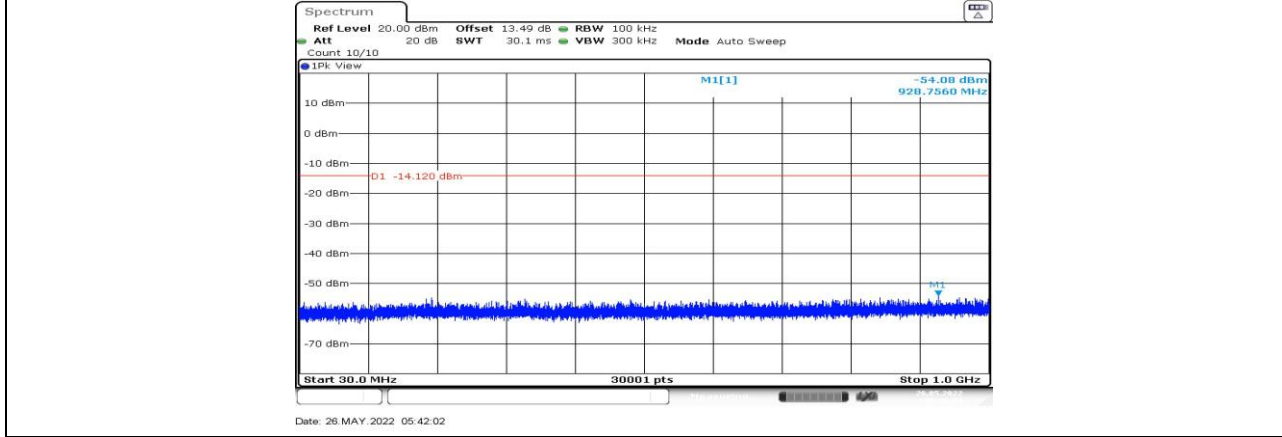

BLE_1M_Ant1_2440_30~1000

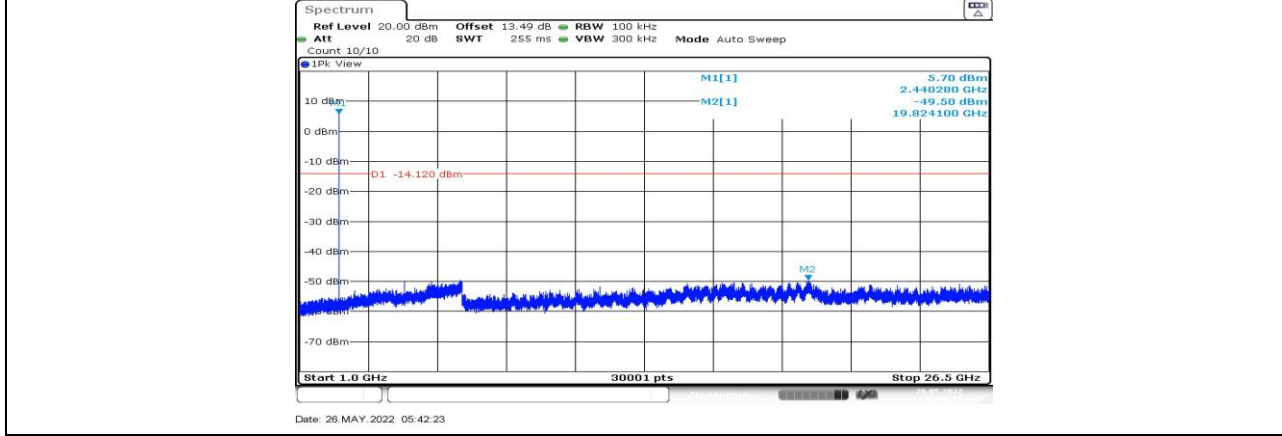

BLE_1M_Ant1_2440_1000~26500



BLE_1M_Ant1_2480_0~Reference

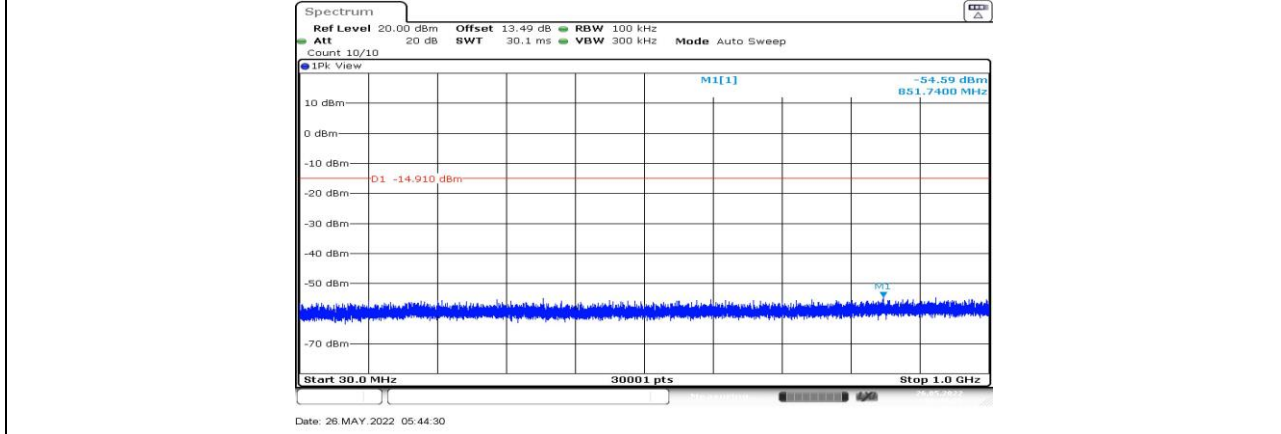

BLE_1M_Ant1_2480_30~1000

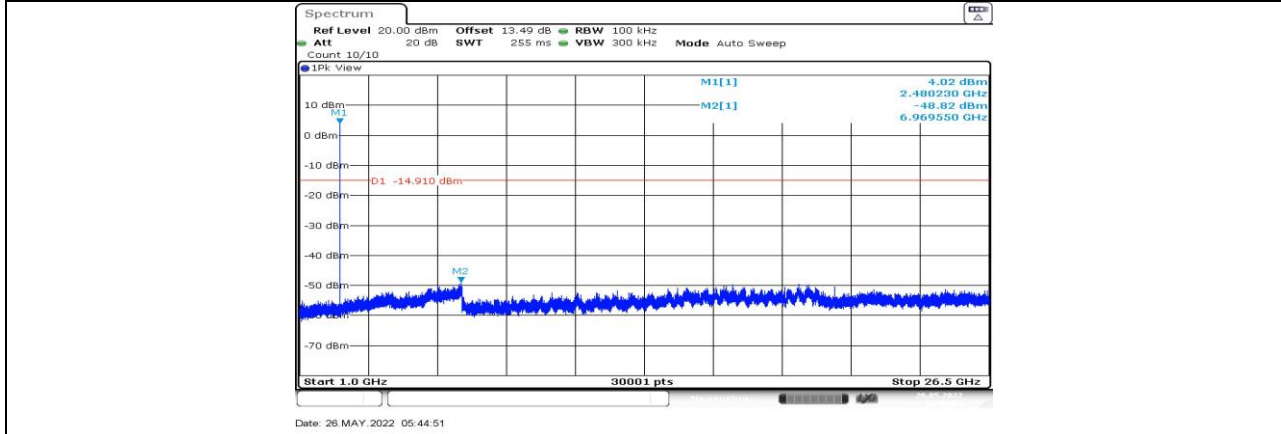

BLE_1M_Ant1_2480_1000~26500

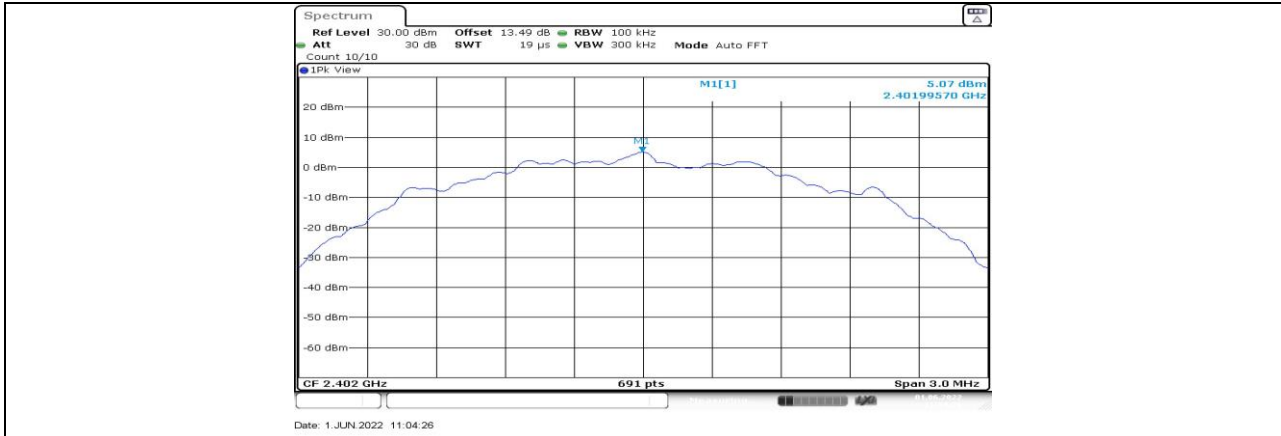

BLE_2M_Ant1_2402_0~Reference

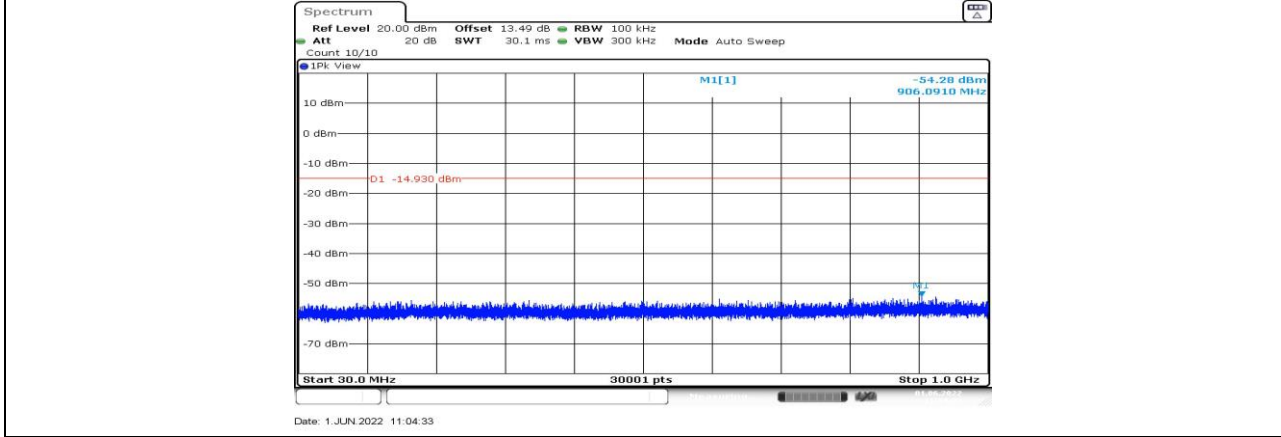

BLE_2M_Ant1_2402_30~1000

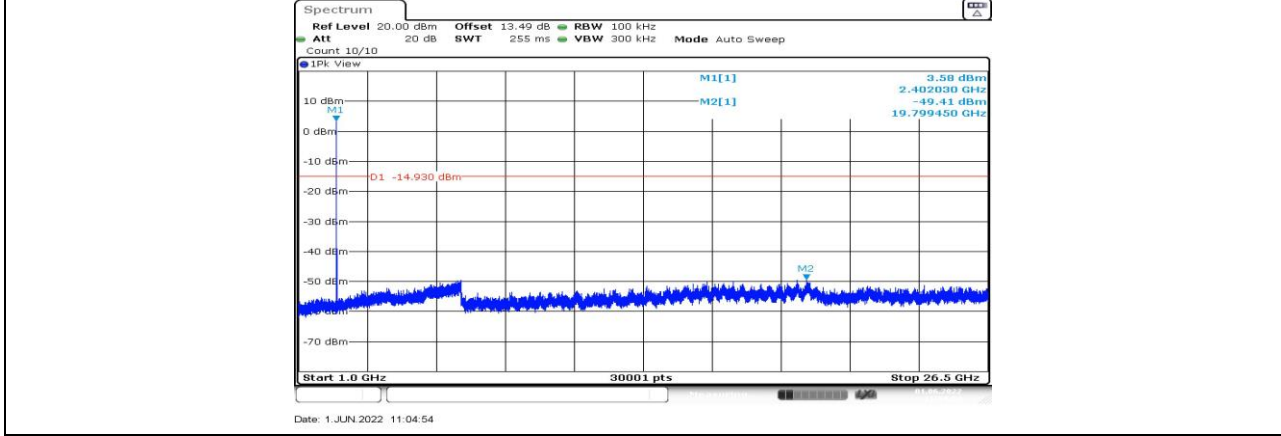

BLE_2M_Ant1_2402_1000~26500

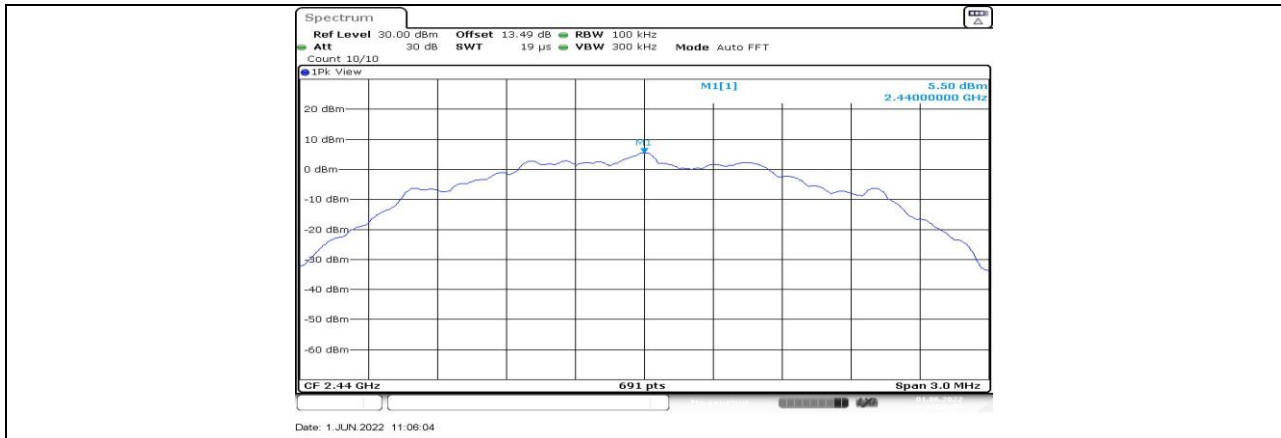

BLE_2M_Ant1_2440_0~Reference

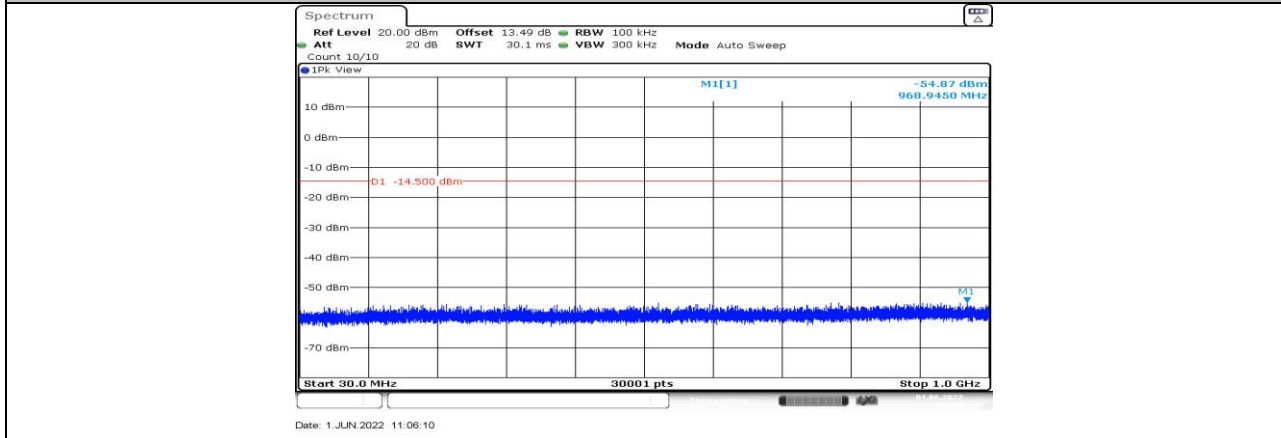

BLE_2M_Ant1_2440_30~1000

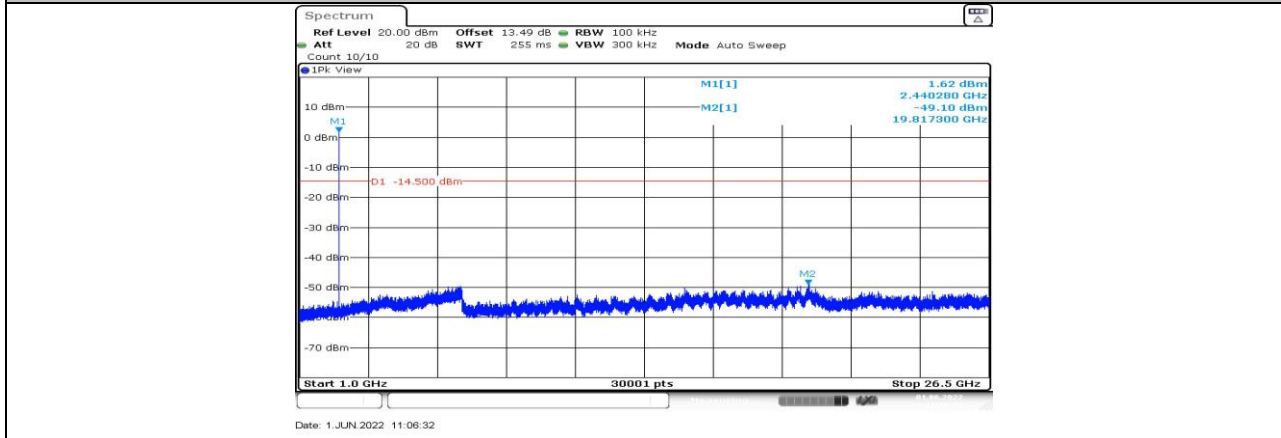

BLE_2M_Ant1_2440_1000~26500

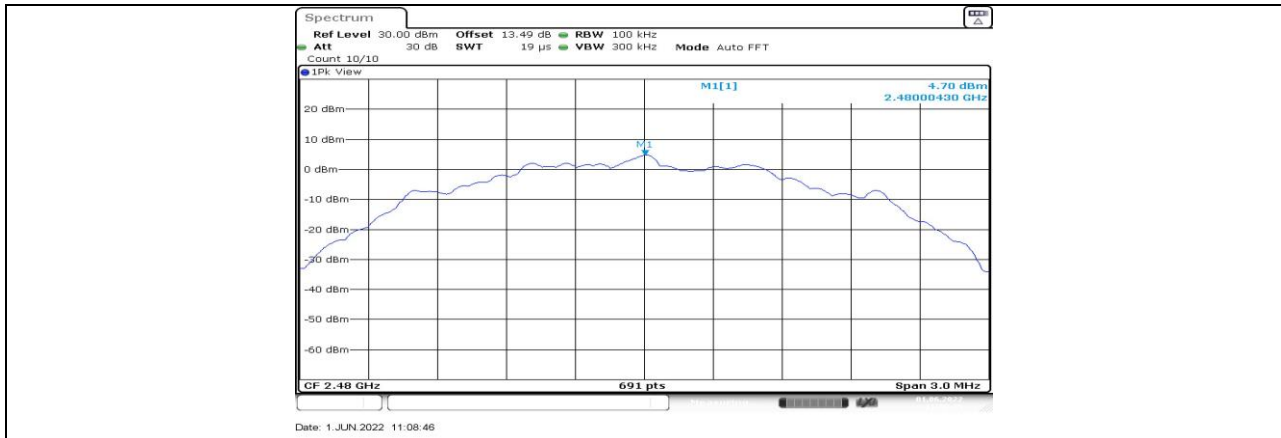

BLE_2M_Ant1_2480_0~Reference

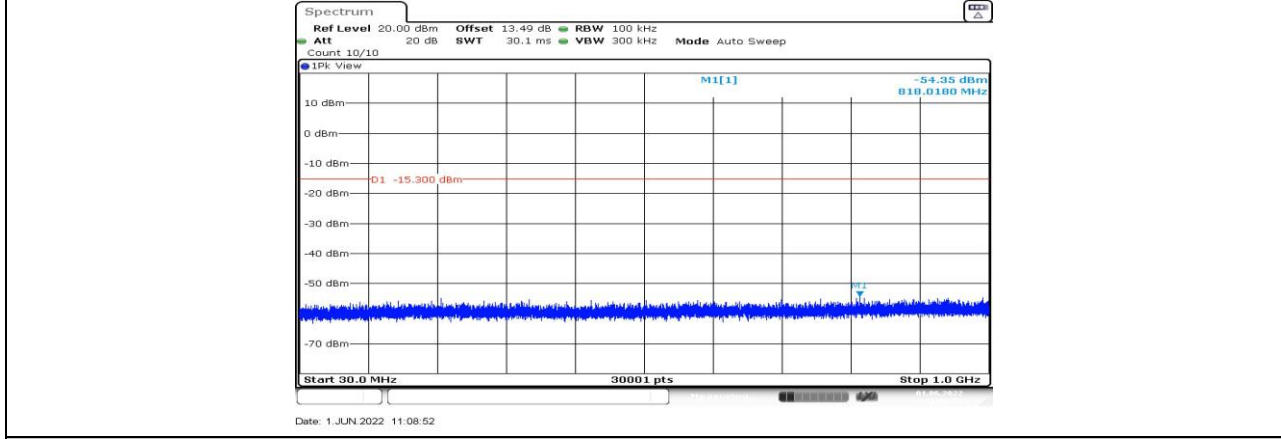

BLE_2M_Ant1_2480_30~1000

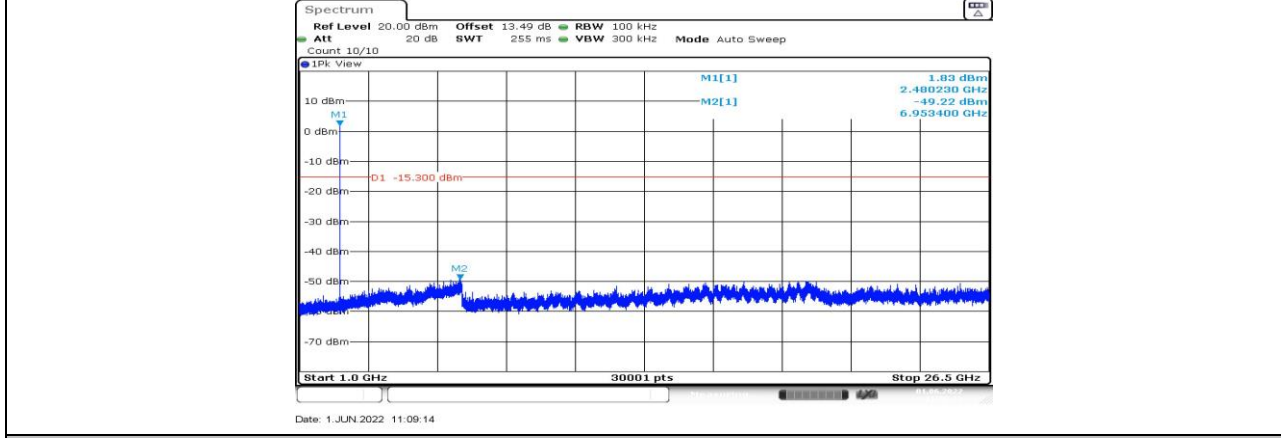

BLE_2M_Ant1_2480_1000~26500



11.7. Appendix G: Duty Cycle

11.7.1. Test Result

| Test Mode | On Time (msec) | Period (msec) | Duty Cycle x (Linear) | Duty Cycle (%) | Duty Cycle Correction Factor (dB) | 1/T Minimum VBW (kHz) | Final setting For VBW (kHz) |
|-----------|----------------|---------------|-----------------------|----------------|-----------------------------------|-----------------------|-----------------------------|
| BLE_1M | 0.39 | 0.62 | 0.6290 | 62.90 | 2.01 | 2.56 | 3 |
| BLE_2M | 0.20 | 0.62 | 0.3226 | 32.26 | 4.91 | 5.00 | 5 |

Note:

Duty Cycle Correction Factor=10log (1/x).

Where: x is Duty Cycle (Linear)

Where: T is On Time

If that calculated VBW is not available on the analyzer then the next higher value should be used.

11.7.2. Test Graphs

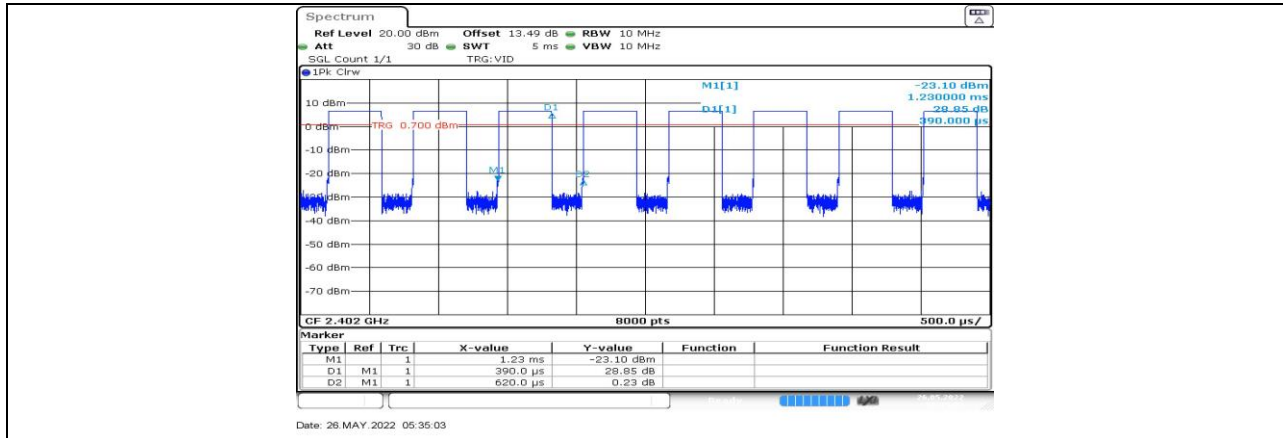

BLE_1M_Ant1_2402

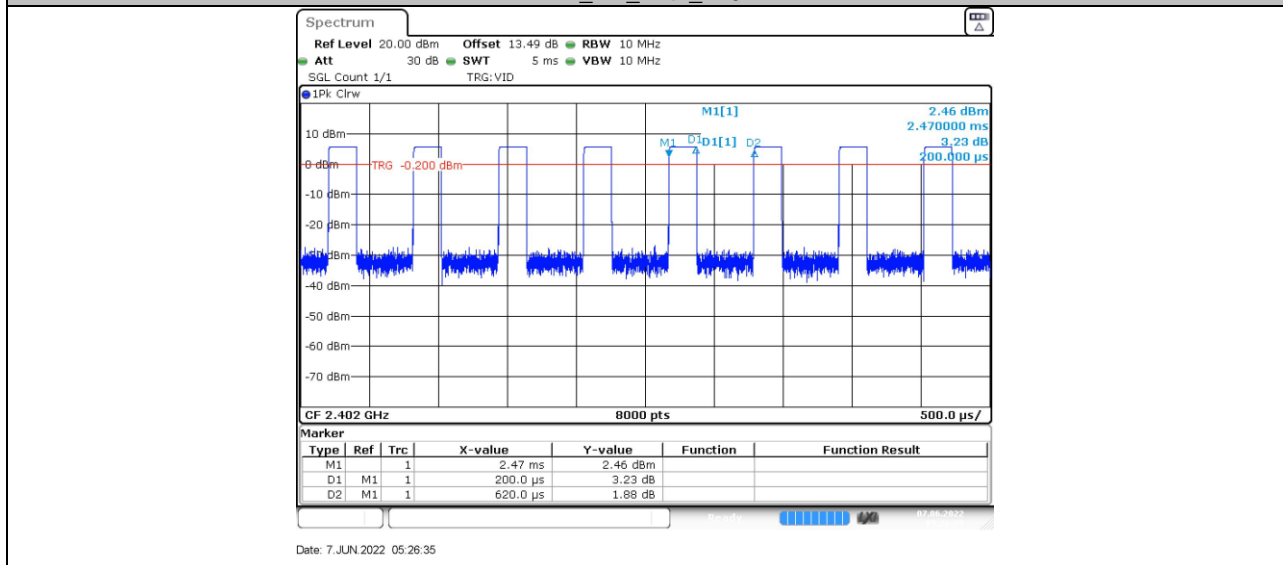

BLE_2M_Ant1_2402

END OF REPORT