



731 Enterprise Drive  
Lexington, KY 40510

Telephone: 859-226-1000  
Facsimile: 859-226-1040  
www.intertek-etlsemko.com

# TEST REPORT

**Report Number:** 102374971LEX-001  
**Project Number:** G102374971

**Report Issue Date:** 3/11/2016

**Product Name:** IQ Panel

**FCC Standards:** Title 47 CFR Part 22, 24, and 27

**Industry Canada Standards:** RSS-132 Issue 3, RSS-133 Issue 6,  
RSS-130 Issue 1, and RSS-139 Issue 3

Tested by:  
Intertek Testing Services NA, Inc.  
731 Enterprise Drive  
Lexington, KY 40510

Client:  
Qolsys  
1900 the Alameda Ste 420  
San Jose CA USA95123-1437

Report prepared by

Brian Daffin,  
Engineer

Report reviewed by

Bryan Taylor,  
Team Leader



*This report is for the exclusive use of Intertek's Client and is provided pursuant to the agreement between Intertek and its Client. Intertek's responsibility and liability are limited to the terms and conditions of the agreement. Intertek assumes no liability to any party, other than to the Client in accordance with the agreement, for any loss, expense or damage occasioned by the use of this report. Only the Client is authorized to permit copying or distribution of this report and then only in its entirety. Any use of the Intertek name or one of its marks for the sale or advertisement of the tested material, product or service must first be approved in writing by Intertek. The observations and test results in this report are relevant only to the sample tested. This report by itself does not imply that the material, product, or service is or has ever been under an Intertek certification program.*

**TABLE OF CONTENTS**

**1 Introduction and Conclusion..... 3**

**2 Test Summary ..... 3**

**3 Description of Equipment Under Test ..... 4**

**4 Conducted Output Power..... 6**

**5 Occupied Bandwidth ..... 22**

**6 Conducted Spurious Emissions at Antenna Terminals..... 40**

**7 Radiated Output Power ..... 82**

**8 Radiated Spurious Emissions (Transmitter)..... 84**

**9 Frequency Stability..... 93**

**10 Measurement Uncertainty ..... 97**

**11 Revision History..... 98**

## 1 Introduction and Conclusion

The tests indicated in Section 2 were performed on the product constructed as described in Section 3. The remaining test sections are the verbatim text from the actual data sheets used during the investigation. These test sections include the test name, the specified test method, a list of the actual test equipment used, documentation photos, results and raw data. No additions, deviations, or exclusions have been made from the standard(s) unless specifically noted.

Based on the results of our investigation, we have concluded the product tested complied with the requirements of the standard(s) indicated. The results obtained in this test report pertain only to the item(s) tested.

The INTERTEK-Lexington laboratory is located at 731 Enterprise Drive, Lexington Kentucky, 40510. The radiated emission test site is a 10-meter semi-anechoic chamber. The chamber meets the characteristics of CISPR 16-1 and ANSI C63.4. For measurements, a remotely controlled flush-mount metal-top turntable is used to rotate the EUT a full 360 degrees. A remote controlled non-conductive antenna mast is used to scan the antenna height from one to four meters. The test site is listed with the FCC under Registration Number 485103.

## 2 Test Summary

Page	Test full name	FCC Reference	Industry Canada	Result
6	Conducted Output Power	§ 22.913(a) § 24.232(c) § 27.50(b)(c)(d)	RSS-130 (4.4) RSS-132 (5.4) RSS-133 (6.4) RSS-139 (6.5)	Pass
22	Occupied Bandwidth	§2.1049	RSS-GEN (4.6.1)	Pass
40	Conducted Spurious Emissions	§22.917(a)(b) § 24.238(a)(b) §27.53(c)(g)(h)	RSS-130 (4.6) RSS-132 (5.5) RSS-133 (6.5) RSS-139 (6.6)	Pass
42	Radiated Output Power	§ 22.913(a) § 24.232(c) § 27.50(b)(c)(d)	RSS-130 (4.4) RSS-132 (5.4) RSS-133 (6.4) RSS-139 (6.5)	Pass
84	Radiated Spurious Emissions (Transmitter)	§22.917(a)(b) §24.238(a)(b) §27.53(c)(g)(h)	RSS-130 (4.6) RSS-132 (5.5) RSS-133 (6.5) RSS-139 (6.6)	Pass
91	Frequency Stability	§22.355 §24.235 §27.54	RSS-130 (4.3) RSS-132 (5.3) RSS-133 (6.3) RSS-139 (6.4)	Pass

### 3 Description of Equipment Under Test

Equipment Under Test	
<b>Manufacturer</b>	Qolsys
<b>Model Number</b>	IQ Panel
<b>Serial Number</b>	MEID:00110700001527
<b>Receive Date</b>	12/15/2015
<b>Test Start Date</b>	12/15/2015
<b>Test End Date</b>	3/2/2016
<b>Device Received Condition</b>	Good
<b>Test Sample Type</b>	Production
<b>Frequency Band</b>	1850MHz – 1910MHz (Band 2) 1710MHz – 1755MHz (Band 4) 824MHz – 849MHz (Band 5) 698MHz – 716MHz (Band 12) 777MHz – 787MHz (Band 13) 704MHz – 716MHz (Band 17)
<b>Modulation Type</b>	LTE
<b>Transmission Control</b>	Base Station Simulator
<b>Maximum Output Power (Conducted)</b>	23.78dBm (Band 2) 26.31dBm (Band 4) 27.55dBm (Band 5) 26.96dBm (Band 12) 25.63dBm (Band 13) 26.73dBm (Band 17)
<b>Antenna Type</b>	Internal
<b>Operating Voltage</b>	Battery Powered by 5VDC

Description of Equipment Under Test
Access and control your entire home from the security panel. Turn lights on or off, activate your security system, lock and unlock doors, or adjust your thermostat. When not in use, your panel turns into a customizable photo frame. When deactivated it takes photographs of the person who used it, and because it's built on android it stays updated with latest software. It's the smartest, easiest to use security panel you'll ever own.

**Operating modes of the EUT:**

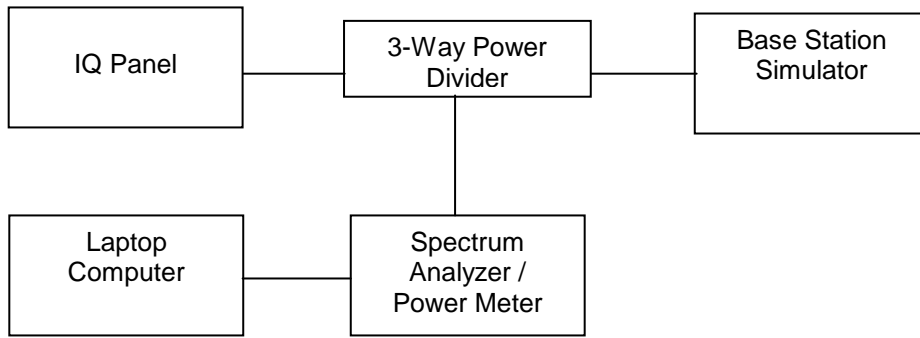
No.	Descriptions of EUT Exercising
1	Connected to base station simulator on various LTE bands and channels
2	Receive / idle mode

**3.1 System setup including cable interconnection details, support equipment and simplified block diagram**

**3.2 EUT Block Diagram:**



Block Diagram for Radiated Tests



Block Diagram for Conducted Tests at the Antenna Port

**3.3 Cables:**

Cables					
Description	Length	Shielding	Ferrites	Connection	
				From	To
DC Power Supply	5ft	Yes	None	AC Mains	Device

## 4 Conducted Output Power

### 4.1 Test Limits

#### § 2.1046

For transmitters other than single sideband, independent sideband and controlled carrier radiotelephone, power output shall be measured at the RF output terminals when the transmitter is adjusted in accordance with the tune-up procedure to give the values of current and voltage on the circuit elements specified in §2.1033(c)(8).

#### § 22.913

(a) (2) The ERP of mobile transmitters and auxiliary test transmitters must not exceed 7 Watts.

#### § 24.232

- (c) Mobile and portable stations are limited to 2 watts EIRP and the equipment must employ a means for limiting power to the minimum necessary for successful communications
- (d) Power measurements for transmissions by stations authorized under this section may be made either in accordance with a Commission-approved average power technique or in compliance with paragraph (e) of this section. In both instances, equipment employed must be authorized in accordance with the provisions of §24.51. In measuring transmissions in this band using an average power technique, the peak-to-average ratio (PAR) of the transmission may not exceed 13 dB.

#### § 27.50

- (b) (10) Portable stations (hand-held devices) in the 746-757 MHz, 776-788 MHz, and 805-806 MHz bands are limited to 3 watts ERP.
- (c) (10) Portable stations (hand-held devices) in the 600 MHz uplink band and the 698-746 MHz band, and fixed and mobile stations in the 600 MHz uplink band are limited to 3 watts ERP.
- (d) (4) Fixed, mobile, and portable (hand-held) stations operating in the 1710-1755 MHz band and mobile and portable stations operating in the 1695-1710 MHz and 1755-1780 MHz bands are limited to 1 watt EIRP. Fixed stations operating in the 1710-1755 MHz band are limited to a maximum antenna height of 10 meters above ground. Mobile and portable stations operating in these bands must employ a means for limiting power to the minimum necessary for successful communications.

#### 4.2 Test Procedure

The transmitter output was connected to a coaxial cable, the other end of which was connected to a Base Station Simulator. The Base Station Simulator was set to force the EUT to its maximum power setting. The EUT was placed into a call and the average power was measured. The power output at the transmitter antenna port was determined by adding the value of the cable insertion loss to the power reading. Tests were performed at three frequencies (low, middle, and high channels) and on the highest power levels, which can be setup on the transmitters.

The peak-to-average ratio (PAR) was measured using a spectrum analyzer with a RBW wider than the EBW of the measured signal. The delta between the peak and average trace was recorded.

#### 4.3 Test Equipment Used:

Description	Serial Number	Manufacturer	Model	Cal. Date	Cal. Due
Base Station Simulator	3917	Rohde & Schwarz	CMW500	9/19/2015	9/19/2016
Spectrum Analyzer	3099	Rohde & Schwarz	FSP7	9/18/2015	9/18/2016
Power Divider	E18106	Weinschell Engineering	1506A	Time of Use	Time of Use

**4.4 Results:**

The table below shows the conducted output power delivered to the radiating antenna. Plots are also provided showing that the peak to average ratio (crest in the attached plots) is below the 13dB limit.

**Conducted Output Power Band 2**

BW	Channel	Frequency	Modulation	No RB	RB Offset	Avg. Power (dBm)	Peak Power (dBm)		
5MHz	18625	1852.5 MHz	QPSK	1	Low	19.95	20.49		
				1	High	19.84	20.42		
				25	Low	19.72	22.51		
			16QAM	1	Low	20.69	21.59		
				1	High	21.35	22.32		
				25	Low	20.05	23.51		
	18900	1880.0 MHz	QPSK	1	Low	21.18	21.78		
				1	High	20.35	20.96		
				25	Low	20.29	23.16		
			16QAM	1	Low	21.35	22.15		
				1	High	21.06	21.92		
				25	Low	19.72	23.43		
			19175	1907.5 MHz	QPSK	1	Low	20.57	21.17
						1	High	18.47	19.13
						25	Low	19.54	22.03
16QAM	1	Low			19.97	21.14			
	1	High			20.56	21.42			
	25	Low			18.75	21.93			

**Conducted Output Power Band 2**

BW	Channel	Frequency	Modulation	No RB	RB Offset	Avg. Power (dBm)	Peak Power (dBm)		
10MHz	18650	1855.0 MHz	QPSK	1	Low	20.75	21.39		
				1	High	20.96	21.71		
				50	Low	20.46	23.29		
			16QAM	1	Low	20.38	21.27		
				1	High	20.98	23.11		
				50	Low	20.42	23.45		
	18900	1880.0 MHz	QPSK	1	Low	21.47	22.01		
				1	High	20.06	20.51		
				50	Low	20.17	23.11		
			16QAM	1	Low	20.81	22.28		
				1	High	20.42	21.65		
				50	Low	19.66	23.32		
			19150	1905.0 MHz	QPSK	1	Low	20.77	21.89
						1	High	18.45	19.09
						50	Low	20.03	22.88
16QAM	1	Low			20.73	22.19			
	1	High			20.32	21.4			
	50	Low			19.89	23.38			



**Conducted Output Power Band 2**

BW	Channel	Frequency	Modulation	No RB	RB Offset	Avg. Power (dBm)	Peak Power (dBm)
15MHz	18675	1857.5 MHz	QPSK	1	Low	20.77	21.34
				1	High	21.62	22.35
				75	Low	20.68	23.57
			16QAM	1	Low	20.47	21.43
				1	High	20.89	22.48
				75	Low	19.41	22.36
	18900	1880.0 MHz	QPSK	1	Low	21.81	22.34
				1	High	19.87	20.44
				75	Low	20.38	23.45
			16QAM	1	Low	21.08	22.38
				1	High	19.41	20.45
				75	Low	19.34	23.31
	19125	1902.5 MHz	QPSK	1	Low	20.59	21.62
				1	High	18.49	19.12
				75	Low	20.41	23.13
16QAM			1	Low	19.97	21.66	
			1	High	18.71	19.75	
			75	Low	19.73	23.65	

**Conducted Output Power Band 2**

BW	Channel	Frequency	Modulation	No RB	RB Offset	Avg. Power (dBm)	Peak Power (dBm)
20MHz	18700	1860.0 MHz	QPSK	1	Low	20.61	21.37
				1	High	21.52	22.49
				100	Low	20.69	23.78
			16QAM	1	Low	19.67	21.39
				1	High	20.93	22.54
				100	Low	19.43	23.47
	18900	1880.0 MHz	QPSK	1	Low	21.79	22.49
				1	High	19.71	20.54
				100	Low	20.31	23.25
			16QAM	1	Low	21.63	22.61
				1	High	19.65	20.62
				100	Low	19.56	23.19
	19100	1900.0 MHz	QPSK	1	Low	20.14	20.82
				1	High	18.81	19.31
				100	Low	20.45	23.29
16QAM			1	Low	19.45	20.83	
			1	High	18.31	19.36	
			100	Low	19.25	23.01	

**Conducted Output Power Band 4**

BW	Channel	Frequency	Modulation	RB Size	RB Offset	Max. Avg. Power (dBm)	Peak Power (dBm)
5MHz	19975	1712.5 MHz	QPSK	1	Low	22.15	23.91
				1	High	22.08	23.63
				25	Low	21.09	25.15
			16QAM	1	Low	21.79	23.97
				1	High	21.76	23.69
				25	Low	19.99	24.76
	20175	1732.5 MHz	QPSK	1	Low	22.16	25.04
				1	High	22.18	24.91
				25	Low	21.24	26.13
			16QAM	1	Low	21.75	24.87
				1	High	21.58	24.81
				25	Low	20.06	26.31
	20375	1752.5 MHz	QPSK	1	Low	22.12	23.65
				1	High	22.39	23.68
				25	Low	21.21	25.13
16QAM			1	Low	21.71	23.69	
			1	High	21.88	23.63	
			25	Low	20.09	24.72	

**Conducted Output Power Band 4**

BW	Channel	Frequency	Modulation	RB Size	RB Offset	Max. Avg. Power (dBm)	Peak Power (dBm)
10MHz	20000	1715.0 MHz	QPSK	1	Low	22.58	23.94
				1	High	22.36	23.99
				50	Low	20.92	25.28
			16QAM	1	Low	21.93	23.99
				1	High	21.64	24.05
				50	Low	19.72	24.81
	20175	1732.5 MHz	QPSK	1	Low	22.28	24.83
				1	High	21.79	24.27
				50	Low	21.01	26.28
			16QAM	1	Low	21.98	24.85
				1	High	21.62	24.33
				50	Low	20.14	25.58
	20350	1750.0 MHz	QPSK	1	Low	22.07	23.41
				1	High	22.75	23.73
				50	Low	21.01	24.97
16QAM			1	Low	20.98	23.41	
			1	High	21.37	23.65	
			50	Low	20.08	24.57	

**Conducted Output Power Band 4**

BW	Channel	Frequency	Modulation	RB Size	RB Offset	Max. Avg. Power (dBm)	Peak Power (dBm)
15MHz	20025	1717.5 MHz	QPSK	1	Low	22.61	23.87
				1	High	22.26	24.53
				75	Low	21.09	25.55
			16QAM	1	Low	22.01	24.05
				1	High	22.29	24.74
				75	Low	20.16	25.35
	20175	1732.5 MHz	QPSK	1	Low	22.37	24.69
				1	High	22.16	23.91
				75	Low	21.19	26.08
			16QAM	1	Low	21.19	24.79
				1	High	20.81	23.95
				75	Low	20.15	26.07
	20325	1747.5 MHz	QPSK	1	Low	22.02	23.64
				1	High	22.95	23.76
				75	Low	21.04	25.09
16QAM			1	Low	21.11	23.77	
			1	High	21.53	23.65	
			75	Low	20.98	25.05	

**Conducted Output Power Band 4**

BW	Channel	Frequency (MHz)	Modulation	RB Size	RB Offset	Max. Avg. Power (dBm)	Peak Power (dBm)
20MHz	20050	1720.0 MHz	QPSK	1	Low	22.51	24.03
				1	High	22.66	24.79
				100	Low	21.07	25.56
			16QAM	1	Low	21.09	23.69
				1	High	21.79	24.69
				100	Low	20.11	25.33
20MHz	20175	1732.5 MHz	QPSK	1	Low	22.28	24.52
				1	High	21.96	23.61
				100	Low	21.02	25.72
			16QAM	1	Low	22.21	24.58
				1	High	21.54	23.53
				100	Low	20.09	25.77
20MHz	20300	1745.0 MHz	QPSK	1	Low	22.39	24.22
				1	High	22.68	23.71
				100	Low	20.91	25.07
			16QAM	1	Low	21.91	24.18
				1	High	22.16	23.56
				100	Low	19.75	24.59

**Conducted Output Power Band 5**

BW	Channel	Frequency	Modulation	RB Size	RB Offset	Max. Avg. Power (dBm)	Peak Power (dBm)
5MHz	20425	826.5 MHz	QPSK	1	Low	21.25	24.26
				1	High	21.28	23.52
				25	Low	20.03	25.35
			16QAM	1	Low	20.76	24.53
				1	High	20.26	23.61
				25	Low	18.83	25.28
	20525	836.5 MHz	QPSK	1	Low	20.88	24.76
				1	High	21.03	26.18
				25	Low	20.02	19.95
			16QAM	1	Low	21.08	24.75
				1	High	21.49	26.17
				25	Low	19.13	25.47
	20625	846.5 MHz	QPSK	1	Low	20.99	24.86
				1	High	20.89	24.48
				25	Low	20.18	25.03
16QAM			1	Low	21.11	24.63	
			1	High	21.03	24.32	
			25	Low	18.93	24.32	

**Conducted Output Power Band 5**

BW	Channel	Frequency	Modulation	RB Size	RB Offset	Max. Avg. Power (dBm)	Peak Power (dBm)
10MHz	20450	829.0 MHz	QPSK	1	Low	21.26	24.34
				1	High	21.21	23.94
				50	Low	20.02	25.28
			16QAM	1	Low	21.12	25.58
				1	High	20.58	24.57
				50	Low	18.78	24.61
	20525	836.5 MHz	QPSK	1	Low	20.91	23.95
				1	High	21.12	26.07
				50	Low	20.07	26.75
			16QAM	1	Low	20.79	23.91
				1	High	21.33	25.88
				50	Low	19.18	26.02
	20600	844.0 MHz	QPSK	1	Low	21.72	25.03
				1	High	21.89	24.57
				50	Low	20.54	25.96
16QAM			1	Low	21.69	27.55	
			1	High	21.16	25.05	
			50	Low	19.45	25.19	

**Conducted Output Power Band 12**

BW	Channel	Frequency	Modulation	RB Size	RB Offset	Max. Avg. Power (dBm)	Peak Power (dBm)
5MHz	23060	704.0 MHz	QPSK	1	Low	22.36	25.47
				1	High	22.27	26.22
				25	Low	21.33	26.63
			16QAM	1	Low	22.04	25.38
				1	High	22.31	26.11
				25	Low	20.37	26.24
	23095	707.5 MHz	QPSK	1	Low	22.31	26.13
				1	High	22.37	25.82
				25	Low	21.41	26.83
			16QAM	1	Low	22.39	26.07
				1	High	22.26	25.71
				25	Low	20.51	26.55
	23130	711.0 MHz	QPSK	1	Low	22.33	24.89
				1	High	22.37	24.82
				25	Low	21.29	26.65
16QAM			1	Low	21.76	25.24	
			1	High	21.31	24.93	
			25	Low	20.11	26.85	

**Conducted Output Power Band 12**

BW	Channel	Frequency	Modulation	RB Size	RB Offset	Max. Avg. Power (dBm)	Peak Power (dBm)
10MHz	23060	704.0 MHz	QPSK	1	Low	22.63	24.95
				1	High	22.59	25.17
				50	Low	21.41	26.96
			16QAM	1	Low	22.18	25.46
				1	High	21.88	26.54
				50	Low	20.11	26.24
	23095	707.5 MHz	QPSK	1	Low	21.65	25.02
				1	High	21.71	24.89
				50	Low	21.35	26.84
			16QAM	1	Low	21.45	25.45
				1	High	21.55	25.35
				50	Low	20.38	26.63
	23130	711.0 MHz	QPSK	1	Low	22.27	25.17
				1	High	21.08	23.92
				50	Low	21.22	26.64
			16QAM	1	Low	22.23	26.68
				1	High	20.46	25.64
				50	Low	20.06	26.24

**Conducted Output Power Band 13**

BW	Channel	Frequency	Modulation	RB Size	RB Offset	Max. Avg. Power (dBm)	Peak Power (dBm)
5MHz	23205	779.5 MHz	QPSK	1	Low	20.58	23.81
				1	High	20.91	24.27
				25	Low	19.89	24.09
			16QAM	1	Low	20.97	23.73
				1	High	20.71	23.96
				25	Low	18.75	24.32
	23230	782.0 MHz	QPSK	1	Low	20.99	24.06
				1	High	21.04	25.02
				25	Low	19.99	25.31
			16QAM	1	Low	20.98	24.04
				1	High	21.03	24.88
				25	Low	18.96	24.85
	23255	784.5 MHz	QPSK	1	Low	20.86	23.28
				1	High	20.59	23.58
				25	Low	19.81	24.62
16QAM			1	Low	20.48	23.26	
			1	High	20.63	23.81	
			25	Low	18.58	23.87	

**Conducted Output Power Band 13**

BW	Channel	Frequency	Modulation	RB Size	RB Offset	Max. Avg. Power (dBm)	Peak Power (dBm)
10MHz	23230	782.0 MHz	QPSK	1	Low	21.59	23.95
				1	High	20.34	24.11
				50	Low	20.12	25.63
			16QAM	1	Low	20.26	24.01
				1	High	20.36	24.77
				50	Low	19.21	25.52

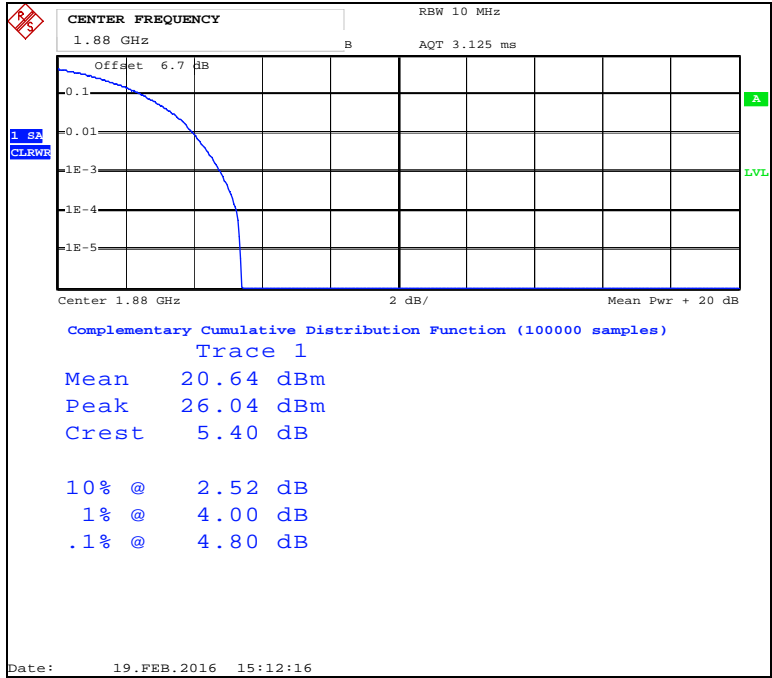
**Conducted Output Power Band 17**

BW	Channel	Frequency	Modulation	RB Size	RB Offset	Max. Avg. Power (dBm)	Peak Power (dBm)
5MHz	23755	706.5 MHz	QPSK	1	Low	22.31	24.59
				1	High	22.34	24.87
				25	Low	21.35	26.56
			16QAM	1	Low	21.69	24.75
				1	High	21.47	25.11
				25	Low	20.29	26.73
	23790	710.0 MHz	QPSK	1	Low	20.88	24.44
				1	High	20.98	24.34
				25	Low	19.93	25.12
			16QAM	1	Low	21.11	24.36
				1	High	20.83	24.28
				25	Low	18.91	24.68
	23825	713.5 MHz	QPSK	1	Low	22.21	25.56
				1	High	21.81	24.96
				25	Low	21.22	26.37
16QAM			1	Low	21.47	24.31	
			1	High	21.18	24.12	
			25	Low	20.21	25.95	

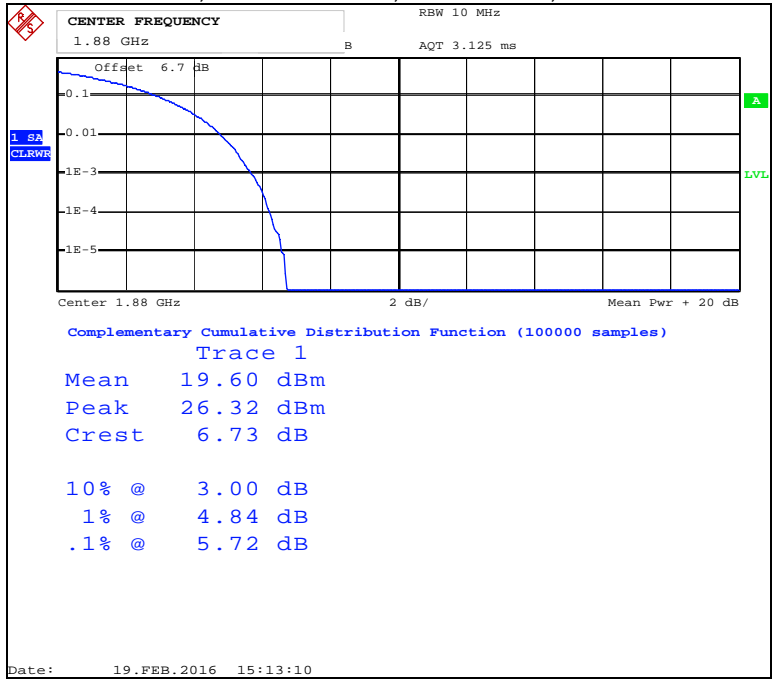
**Conducted Output Power Band 17**

BW	Channel	Frequency	Modulation	RB Size	RB Offset	Max. Avg. Power (dBm)	Target MPR (dB)
10MHz	23790	710.0 MHz	QPSK	1	Low	20.84	23.63
				1	High	20.41	23.57
				50	Low	19.95	24.99
			16QAM	1	Low	20.24	23.97
				1	High	20.19	23.93
				50	Low	18.98	24.94

Band 2, Channel 18900, 1880.0 MHz, QPSK

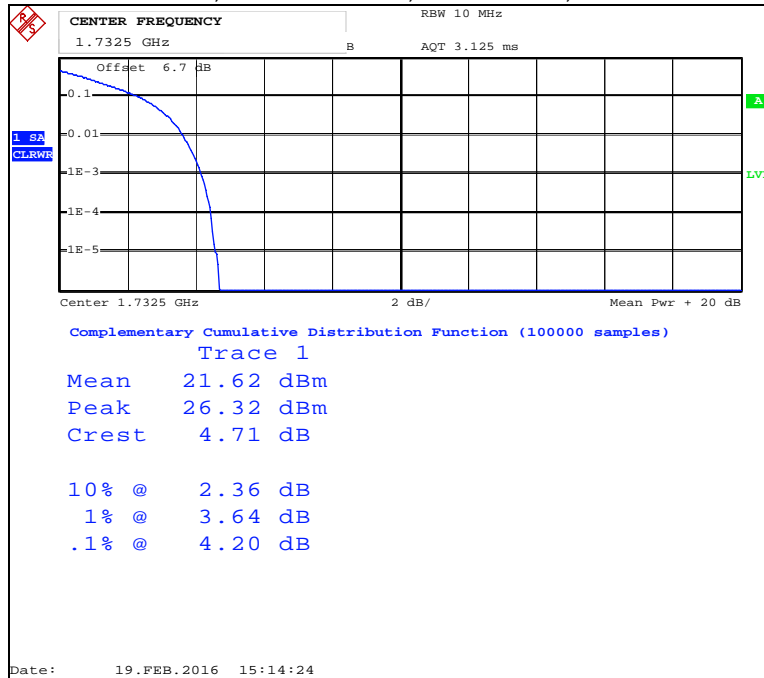


Band 2, Channel 18900, 1880.0 MHz, 16-QAM

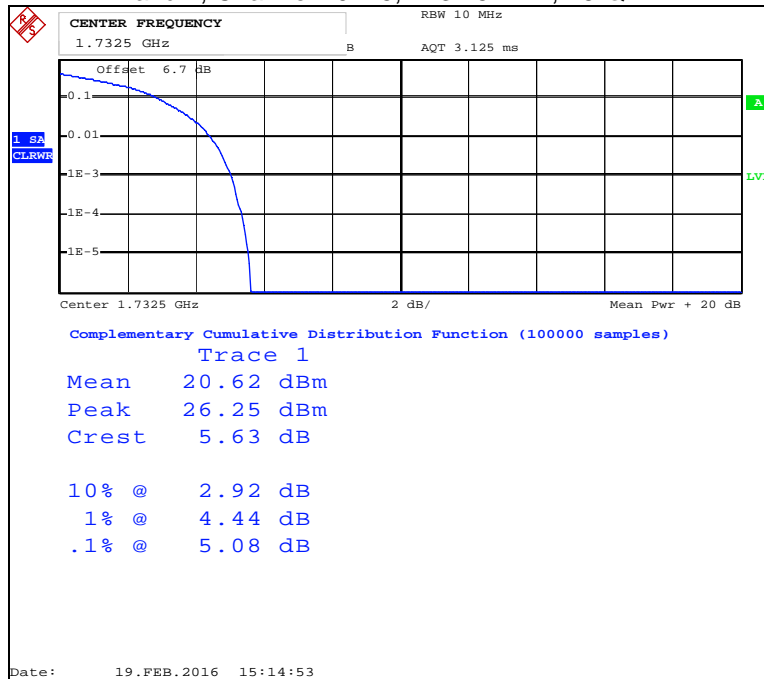




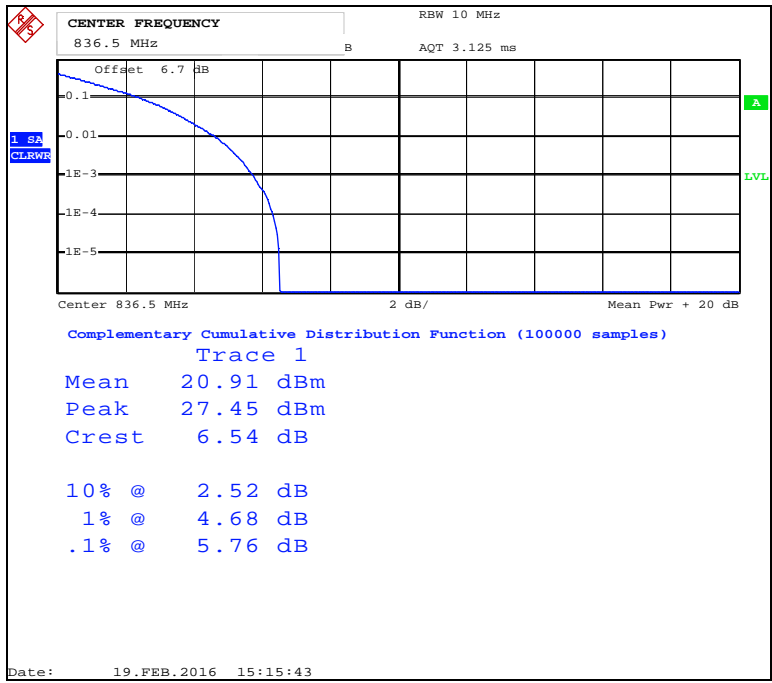
Band 4, Channel 20175, 1732.5 MHz, QPSK



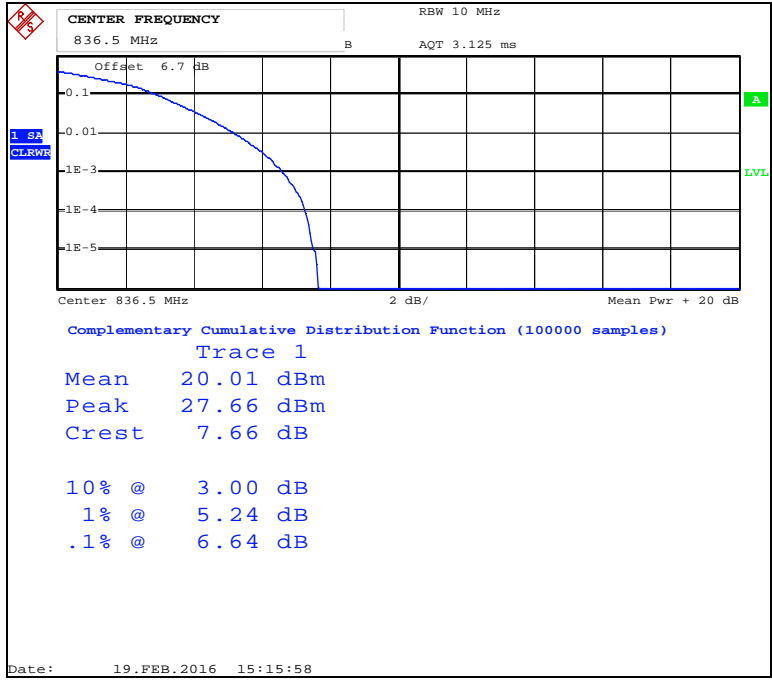
Band 4, Channel 20175, 1732.5 MHz, 16-QAM



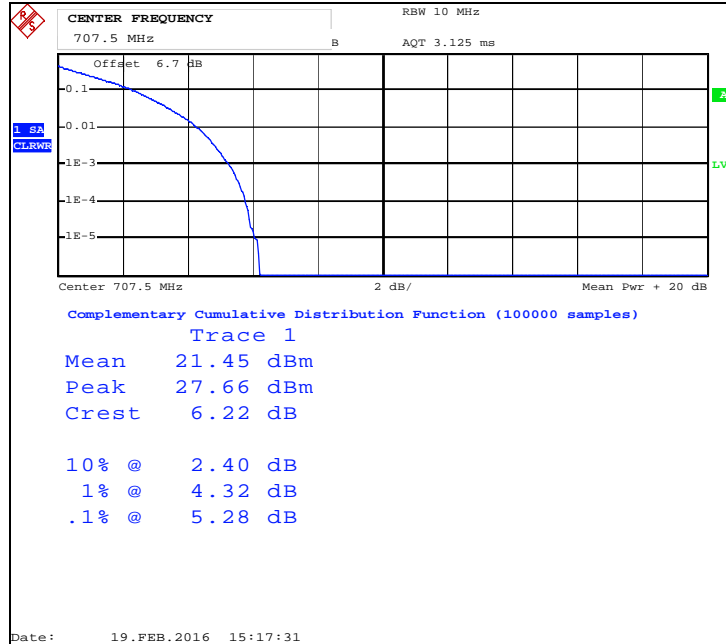
Band 5, Channel 20525, 836.5 MHz, QPSK



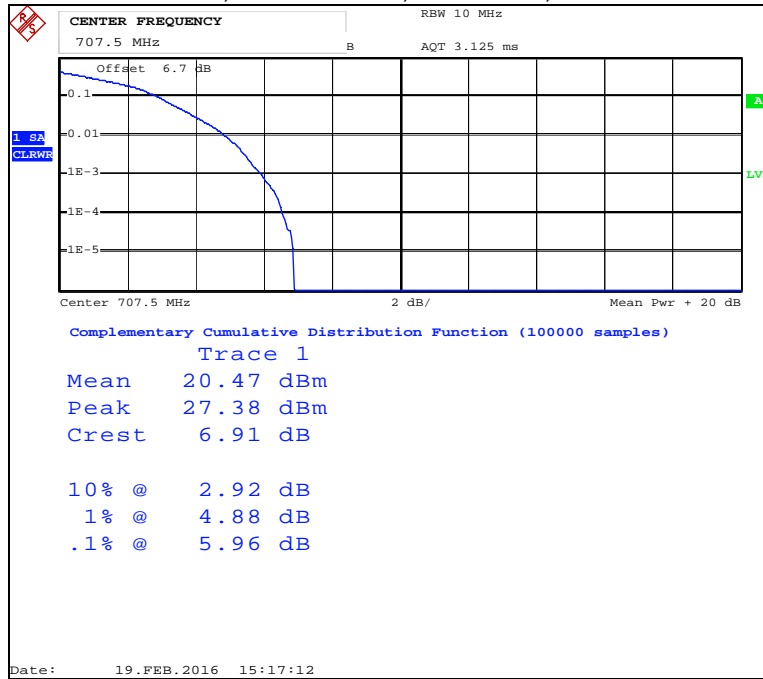
Band 5, Channel 20525, 836.5 MHz, 16-QAM



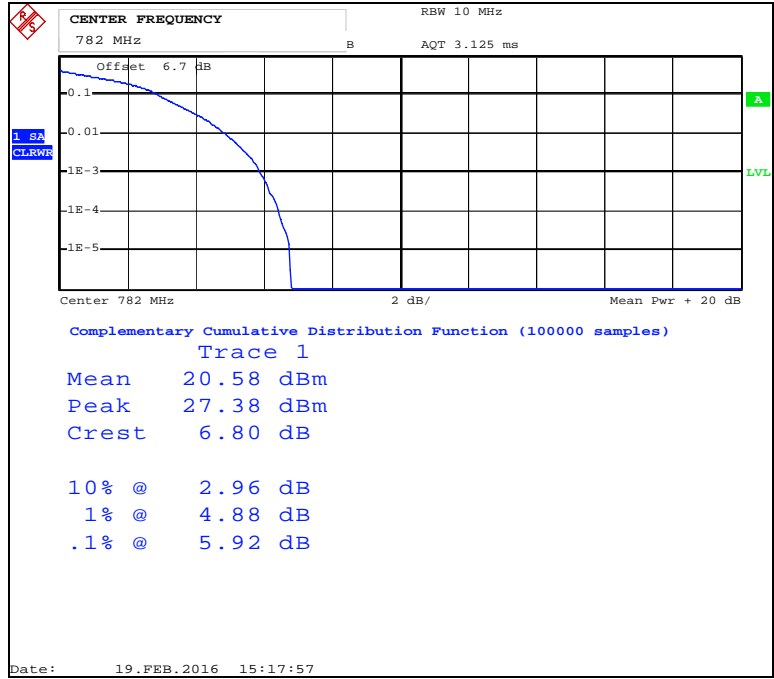
Band 12, Channel 3095, 707.5 MHz, QPSK



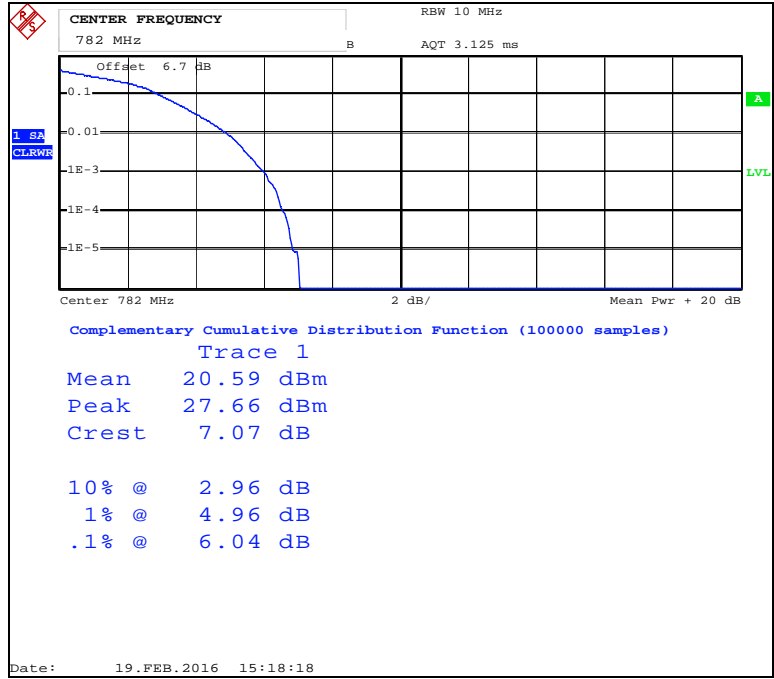
Band 12, Channel 3095, 707.5 MHz, 16-QAM



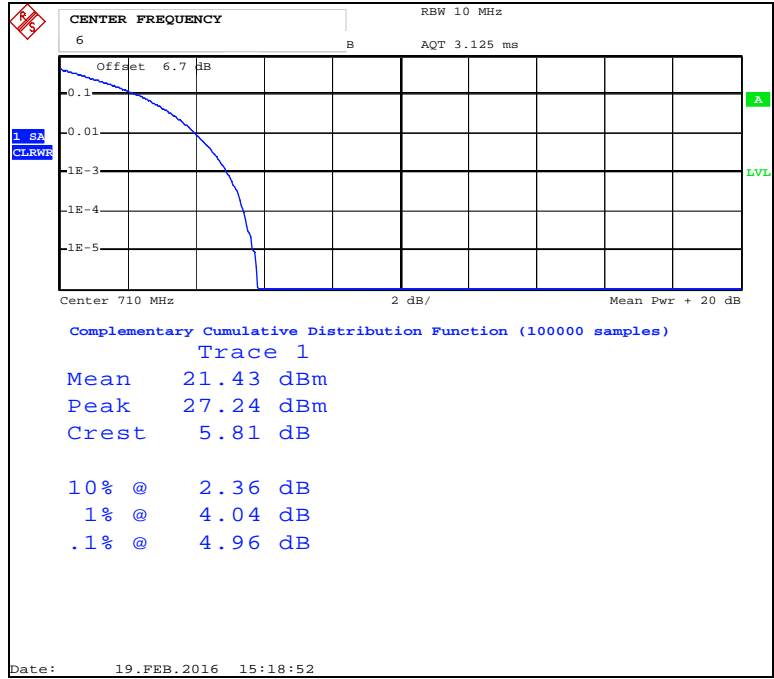
Band 13, Channel 23230, 782.0 MHz, QPSK



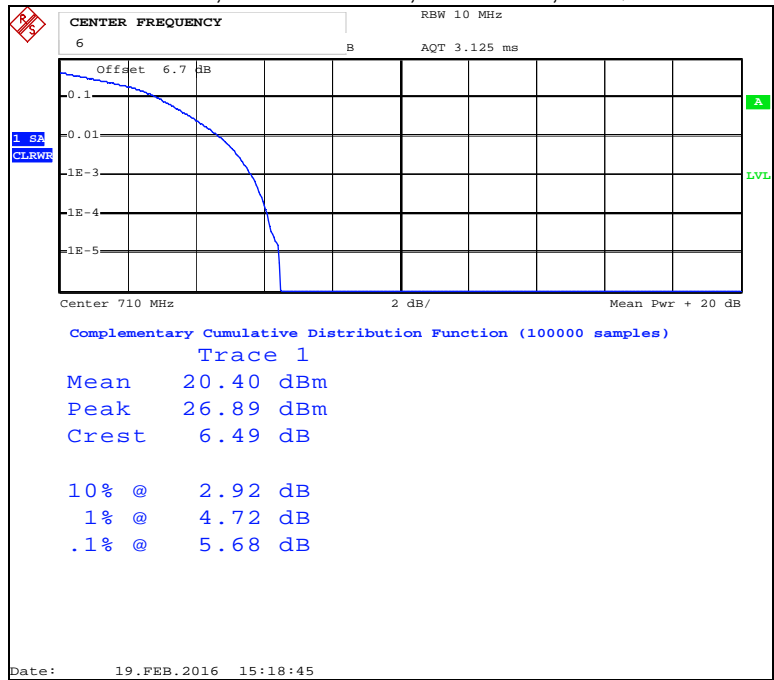
Band 13, Channel 23230, 782.0 MHz, 16-QAM



Band 17, Channel 23790, 710.0 MHz, QPSK



Band 17, Channel 23790, 710.0 MHz, 16-QAM



## 5 Occupied Bandwidth

### 5.1 Test Limits

#### §2.1049:

The occupied bandwidth is the frequency bandwidth such that, below its lower and above its upper frequency limits, the mean powers radiated are each equal to 0.5 percent of the total mean power radiated by a given emission.

### 5.2 Test Procedure

The EUT was connected to a spectrum analyzer using a coaxial cable and power divider. The EUT was placed into a call using base station simulator. The base station simulator was set to force the EUT to its maximum power setting. The occupied bandwidth function of the analyzer was used to automatically generate the occupied bandwidth plots. The ndB down function of the analyzer was used to automatically measure the 26dB emission bandwidth. A peak detector was used for this measurement.

### 5.3 Test Equipment Used:

Description	Serial Number	Manufacturer	Model	Cal. Date	Cal. Due
Base Station Simulator	3917	Rohde & Schwarz	CMW500	9/19/2015	9/19/2016
Spectrum Analyzer	3099	Rohde & Schwarz	FSP7	9/18/2015	9/18/2016
Power Divider	E18106	Weinschell Engineering	1506A	Time of Use	Time of Use

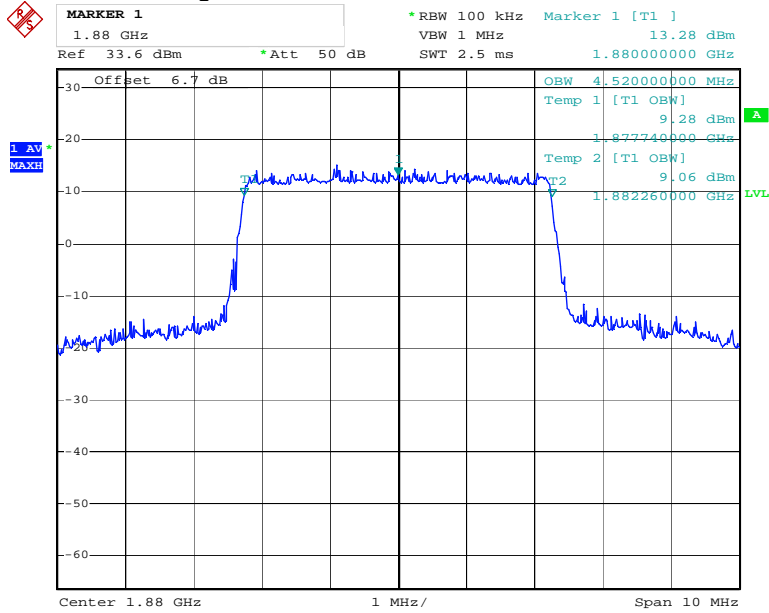
**5.4 Results:**

The bandwidth measurements are shown in the table below and the plots that follow.

**Occupied Bandwidth Data**

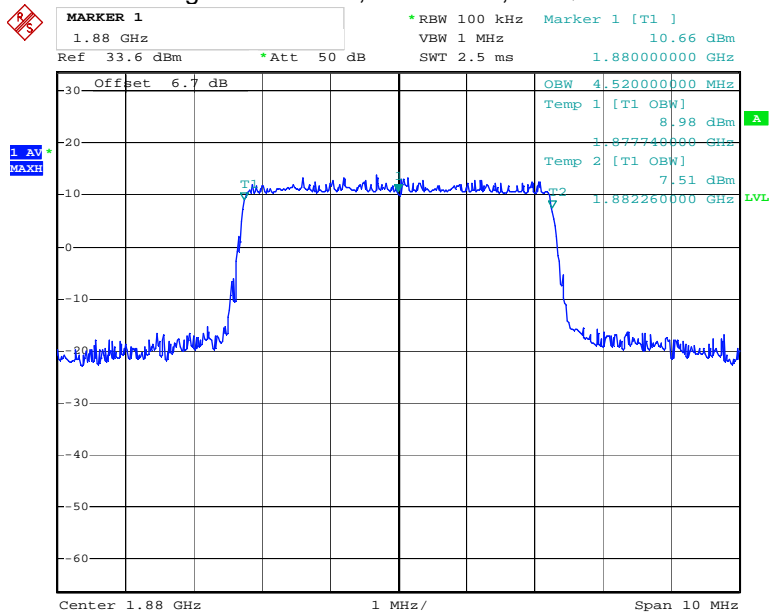
Band	Frequency (MHz)	Channel	BW (MHz)	# RB	Mode	-26dBc Occupied Bandwidth (MHz)	99% Occupied Bandwidth (MHz)	Corresponding Figure Number
B2	1880.0	18900	5	25	QPSK	5.00	4.52	1
					16-QAM	5.04	4.52	2
			10	50	QPSK	9.60	8.92	3
					16-QAM	9.76	8.92	4
			15	75	QPSK	14.22	13.38	5
					16-QAM	14.04	13.38	6
			20	100	QPSK	18.48	17.76	7
					16-QAM	18.48	17.76	8
B4	1732.5	20175	5	25	QPSK	4.94	4.52	9
					16-QAM	4.94	4.52	10
			10	50	QPSK	9.76	8.96	11
					16-QAM	9.48	8.96	12
			15	75	QPSK	14.22	13.44	13
					16-QAM	14.10	13.38	14
			20	100	QPSK	18.56	17.84	15
					16-QAM	18.80	17.84	16
B5	836.5	20525	5	25	QPSK	5.00	4.50	17
					16-QAM	5.00	4.52	18
			10	50	QPSK	9.68	8.96	19
					16-QAM	9.64	8.96	20
B12	707.5	23095	5	25	QPSK	4.96	4.52	21
					16-QAM	4.92	4.52	22
			10	50	QPSK	9.68	9.00	23
					16-QAM	9.60	9.00	24
B13	782.0	23230	5	25	QPSK	4.98	4.52	25
					16-QAM	4.92	4.52	26
			10	50	QPSK	9.44	8.96	27
					16-QAM	9.48	8.88	28
B17	710.0	23790	5	25	QPSK	4.80	4.52	29
					16-QAM	4.92	4.52	30
			10	50	QPSK	9.52	8.96	31
					16-QAM	9.68	8.96	32

Figure 1: Band 2, BW=5MHz, QPSK



Date: 19.FEB.2016 13:36:07

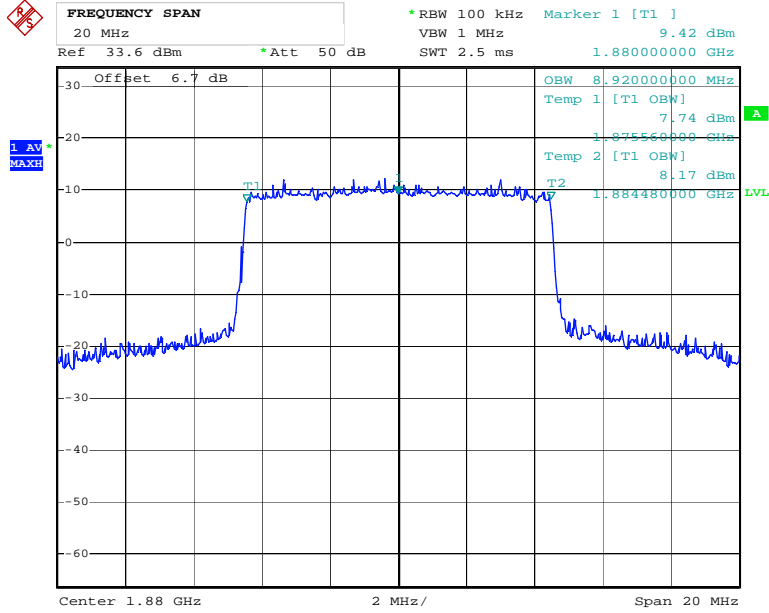
Figure 2: Band 2, BW=5MHz, 16-QAM



Date: 19.FEB.2016 13:37:59

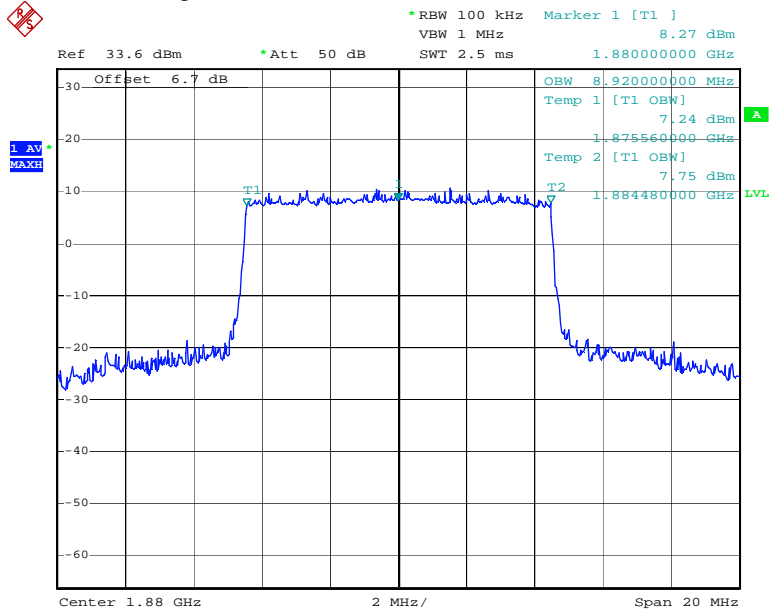


Figure 3: Band 2, BW=10MHz, QPSK



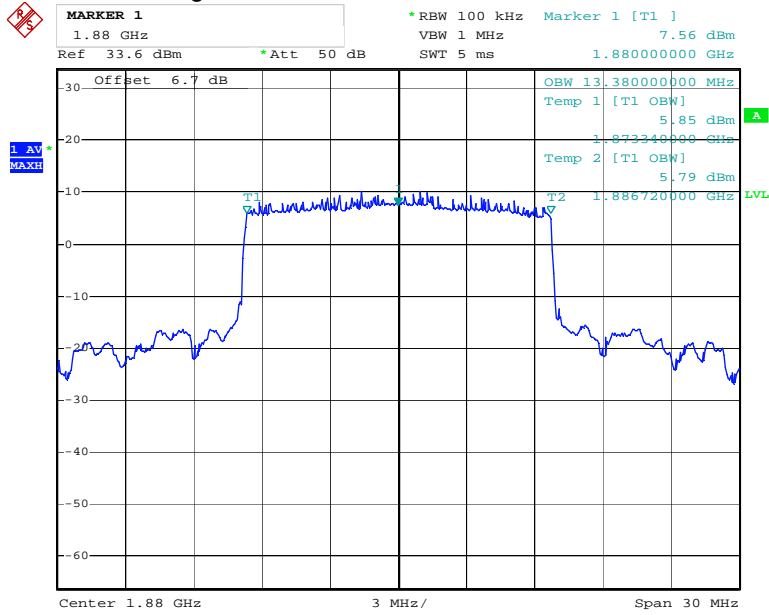
Date: 19.FEB.2016 13:38:42

Figure 4: Band 2, BW=10MHz, 16-QAM



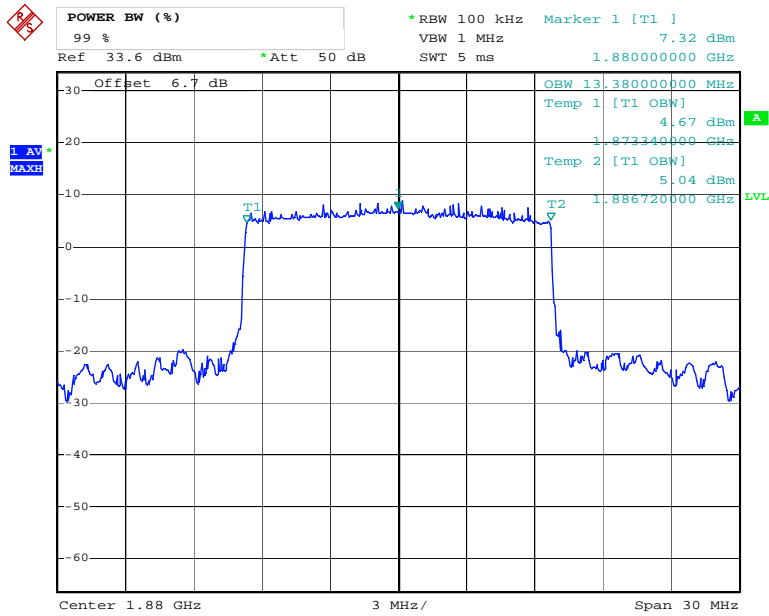
Date: 19.FEB.2016 13:39:17

Figure 5: Band 2, BW=15MHz, QPSK



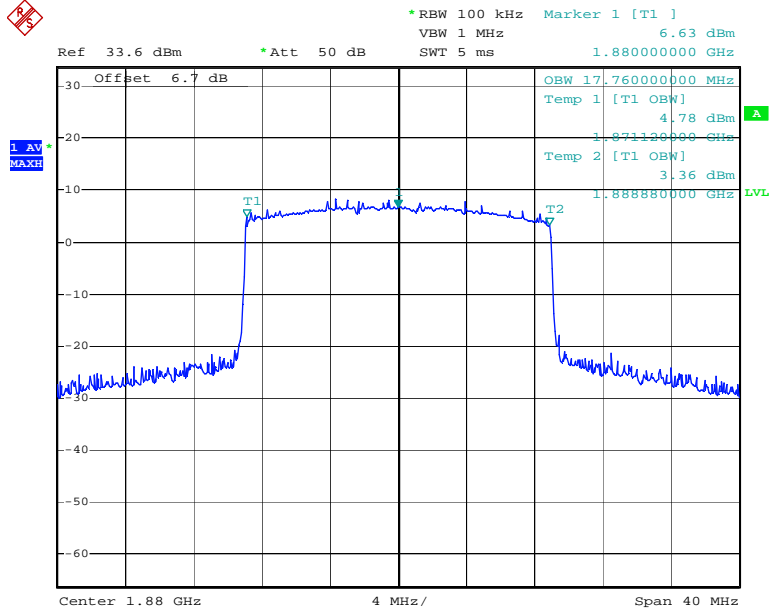
Date: 19.FEB.2016 13:41:50

Figure 6: Band 2, BW=15MHz, 16-QAM



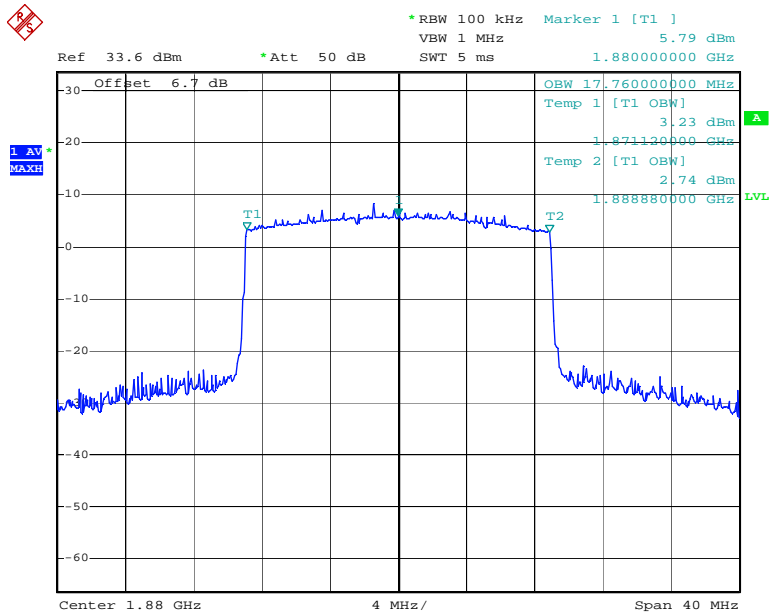
Date: 19.FEB.2016 13:42:16

Figure 7: Band 2, BW=20MHz, QPSK



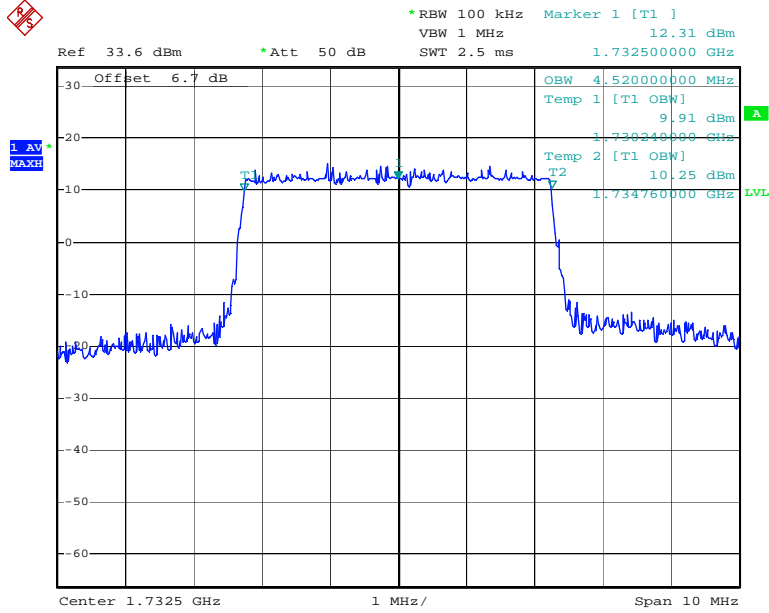
Date: 19.FEB.2016 13:43:21

Figure 8: Band 2, BW=20MHz, 16-QAM



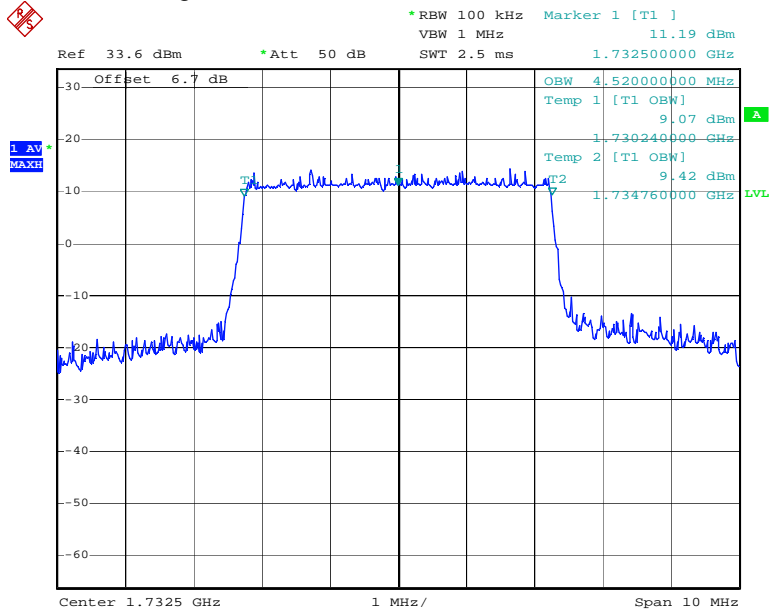
Date: 19.FEB.2016 13:43:41

Figure 9: Band 4, BW=5MHz, QPSK



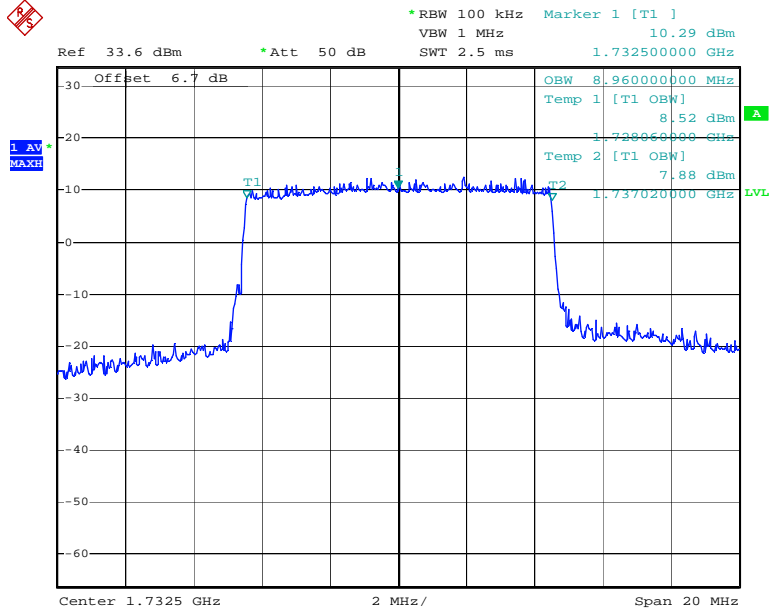
Date: 19.FEB.2016 13:45:51

Figure 10: Band 4, BW=5MHz, 16-QAM



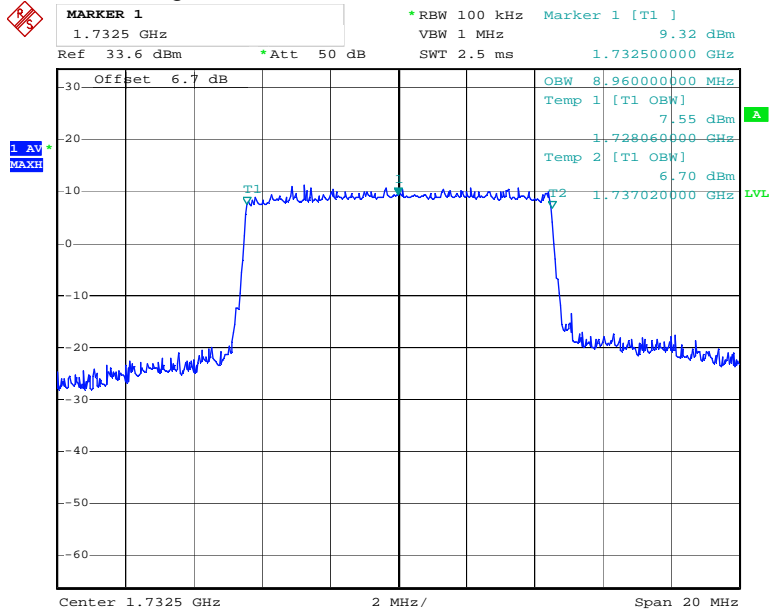
Date: 19.FEB.2016 13:46:32

Figure 11: Band 4, BW=10MHz, QPSK



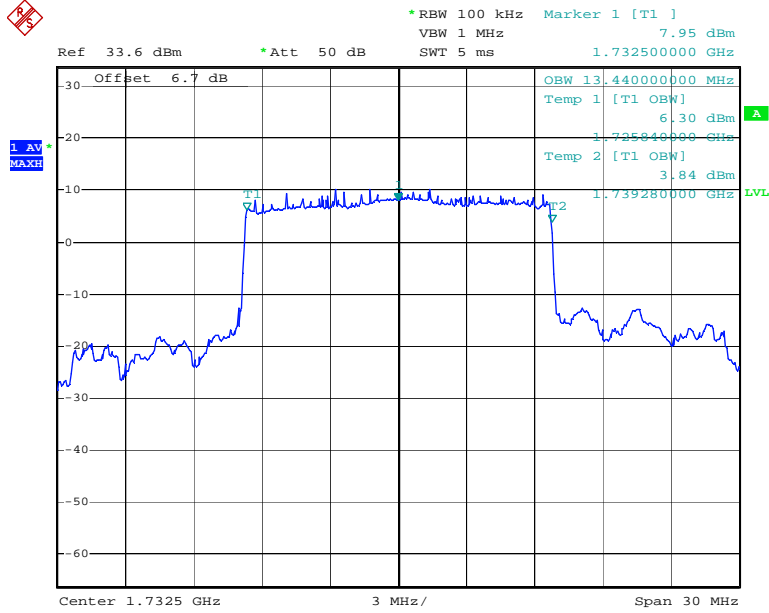
Date: 19.FEB.2016 13:48:50

Figure 12: Band 4, BW=10MHz, 16-QAM



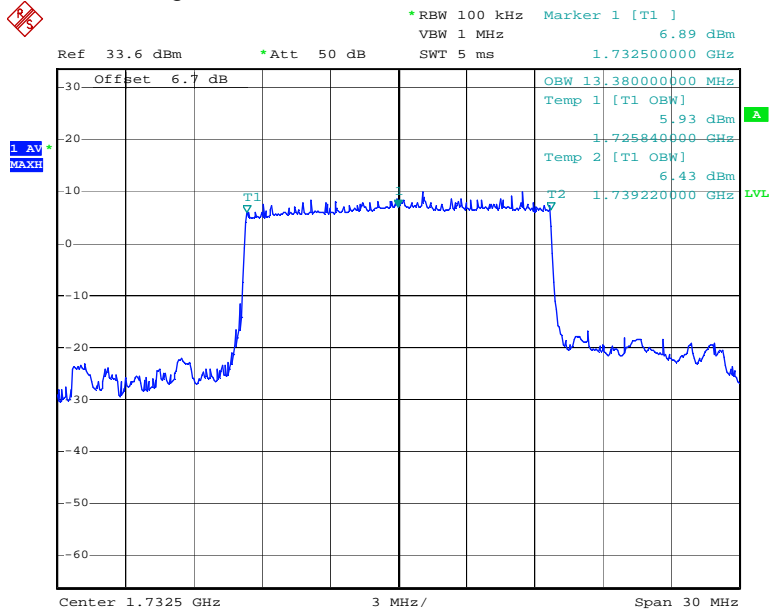
Date: 19.FEB.2016 13:48:26

Figure 13: Band 4, BW=15MHz, QPSK



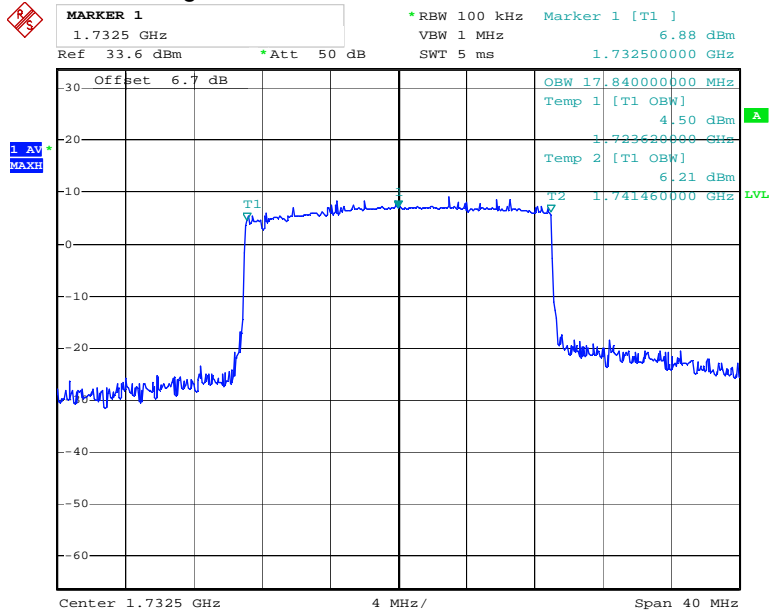
Date: 19.FEB.2016 13:51:19

Figure 14: Band 4, BW=15MHz, 16-QAM



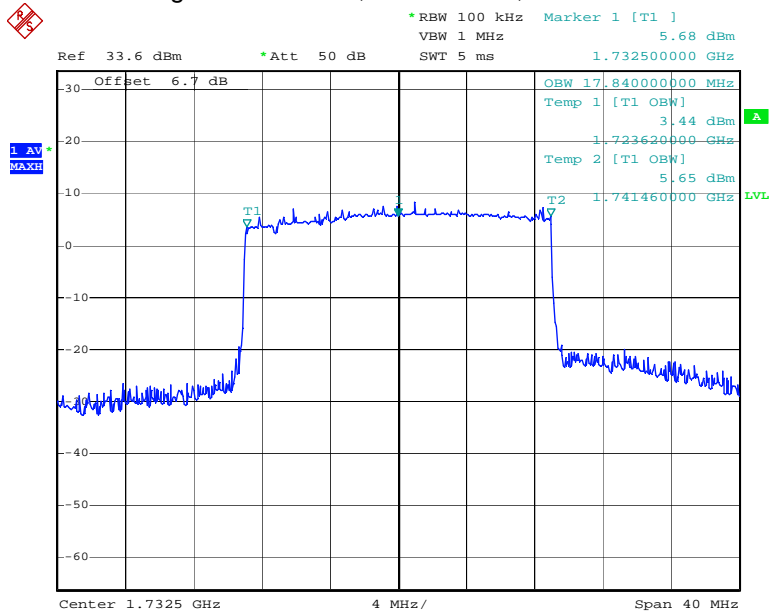
Date: 19.FEB.2016 13:50:55

Figure 15: Band 4, BW=20MHz, QPSK



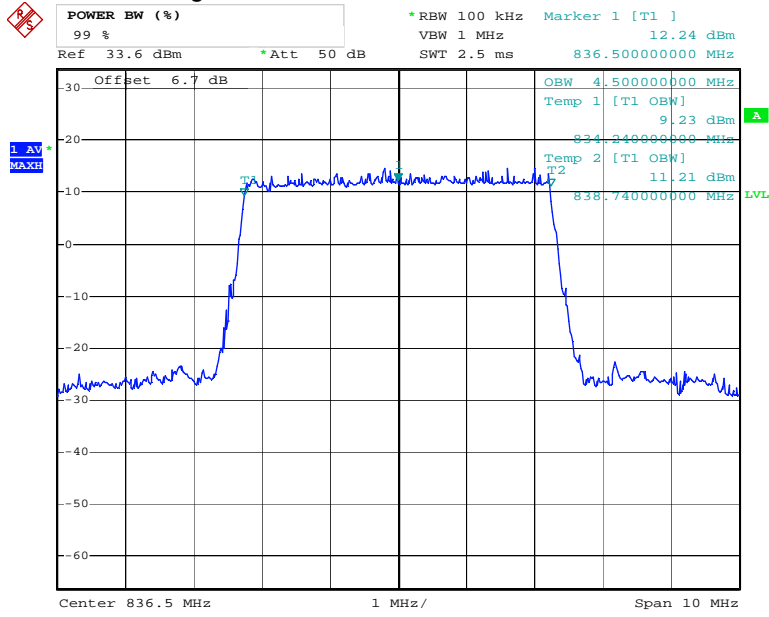
Date: 19.FEB.2016 13:54:35

Figure 16: Band 4, BW=20MHz, 16-QAM



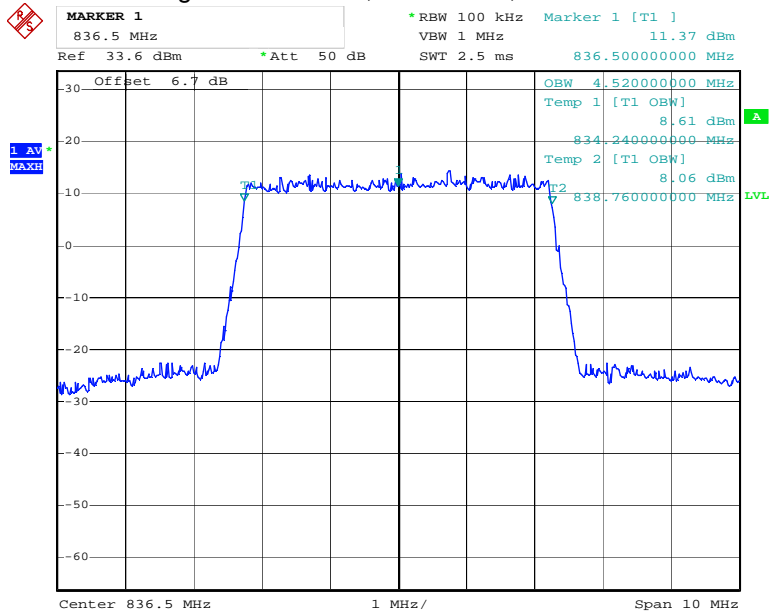
Date: 19.FEB.2016 13:55:05

Figure 17: Band 5, BW=5MHz, QPSK



Date: 19.FEB.2016 14:04:20

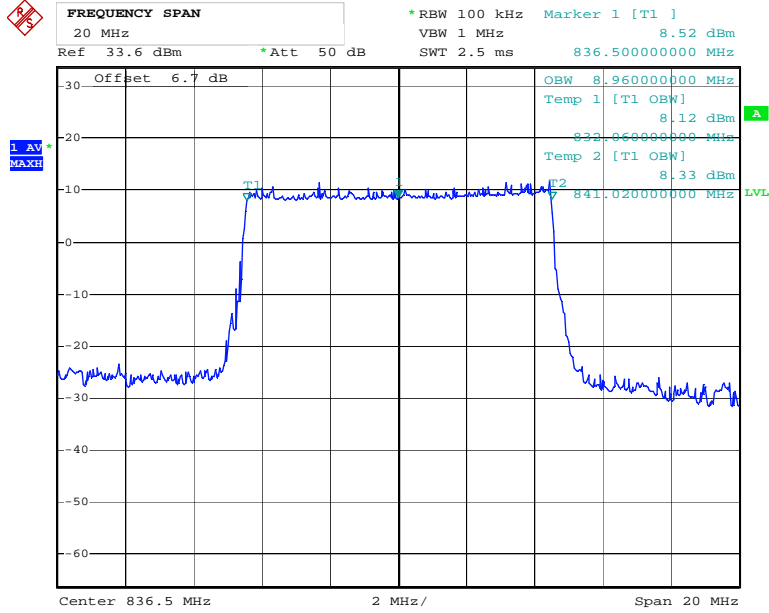
Figure 18: Band 5, BW=5MHz, 16-QAM



Date: 19.FEB.2016 14:03:33

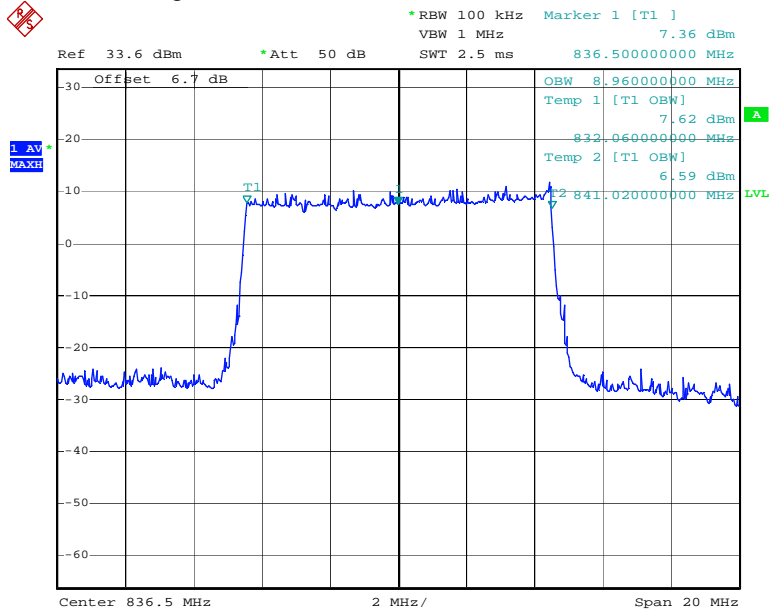


Figure 19: Band 5, BW=10MHz, QPSK



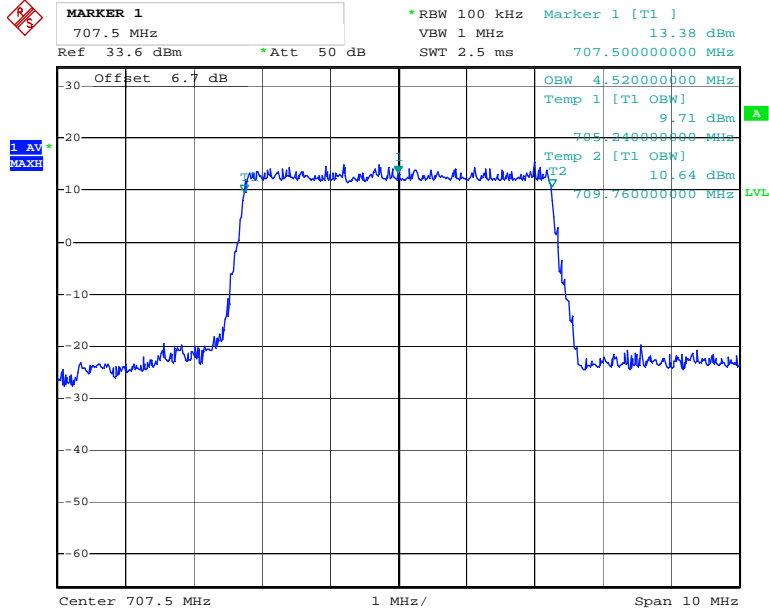
Date: 19.FEB.2016 14:06:12

Figure 20: Band 5, BW=10MHz, 16-QAM



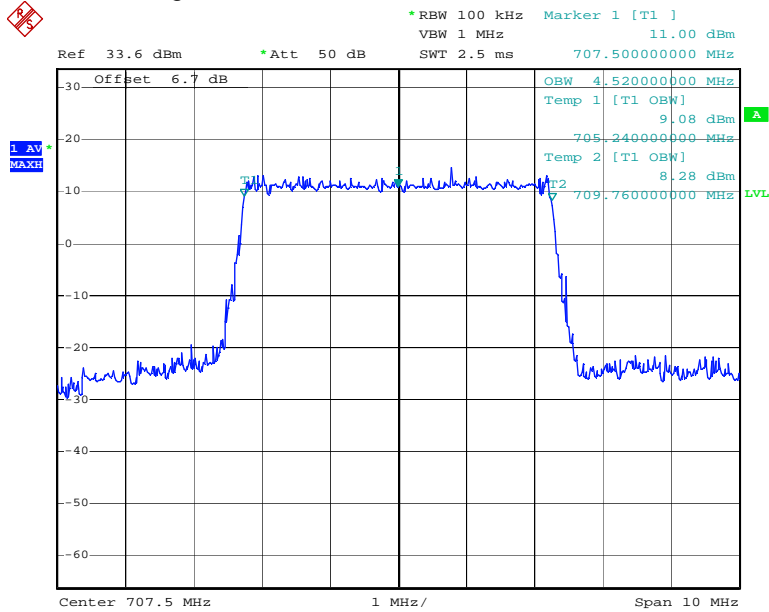
Date: 19.FEB.2016 14:06:32

Figure 21: Band 12, BW=5MHz, QPSK



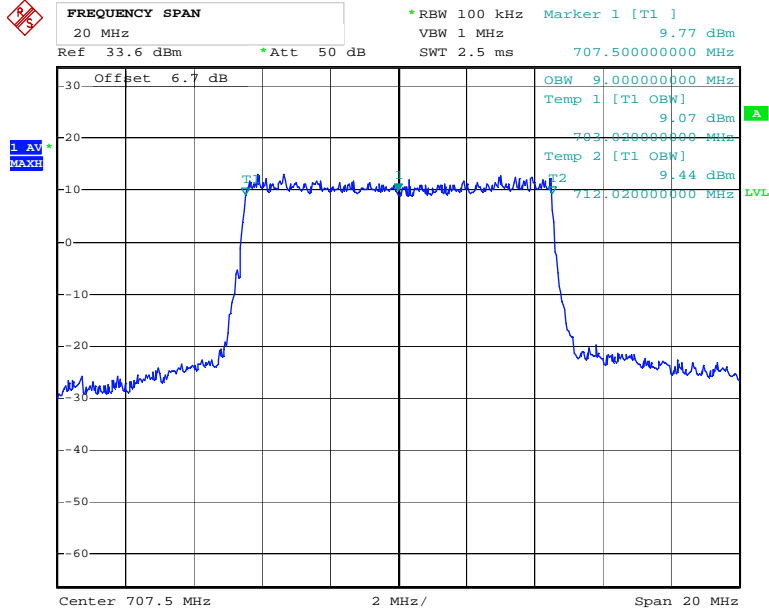
Date: 19.FEB.2016 14:10:45

Figure 22: Band 12, BW=5MHz, 16-QAM



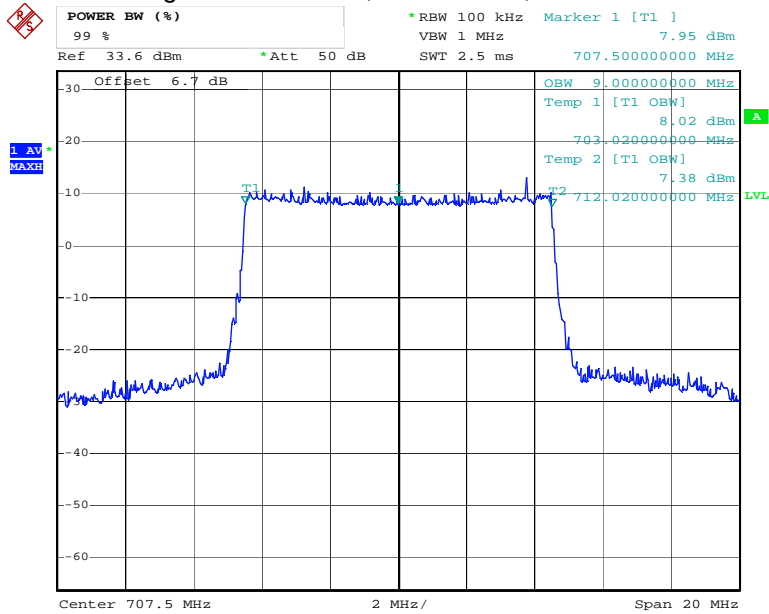
Date: 19.FEB.2016 14:10:58

Figure 23: Band 12, BW=10MHz, QPSK



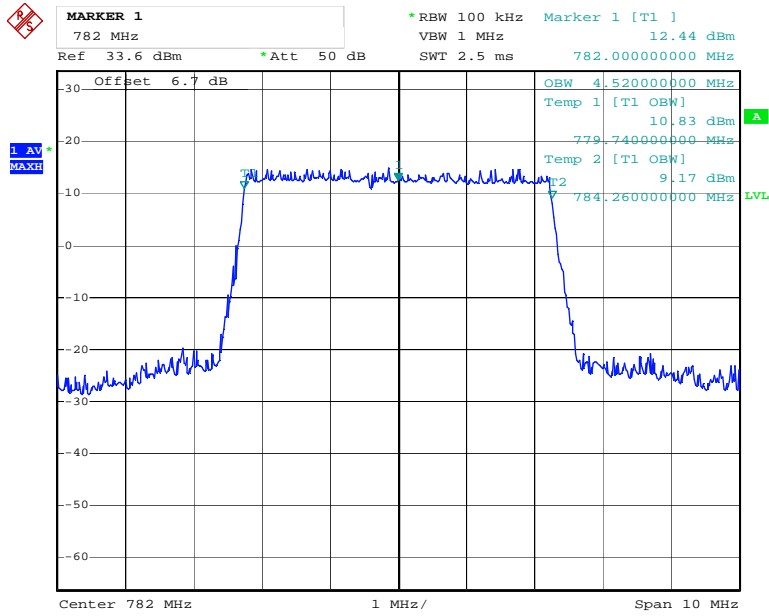
Date: 19.FEB.2016 14:16:21

Figure 24: Band 12, BW=10MHz, 16-QAM



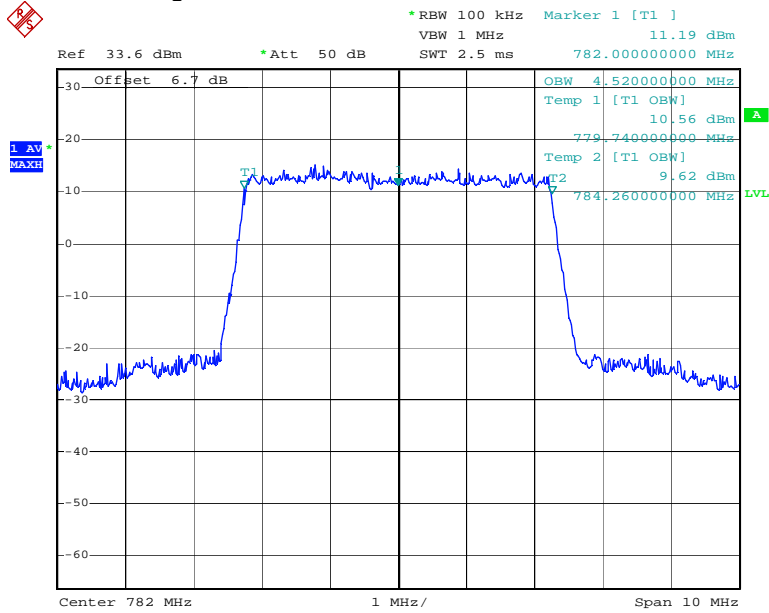
Date: 19.FEB.2016 14:16:49

Figure 25: Band 13, BW=5MHz, QPSK



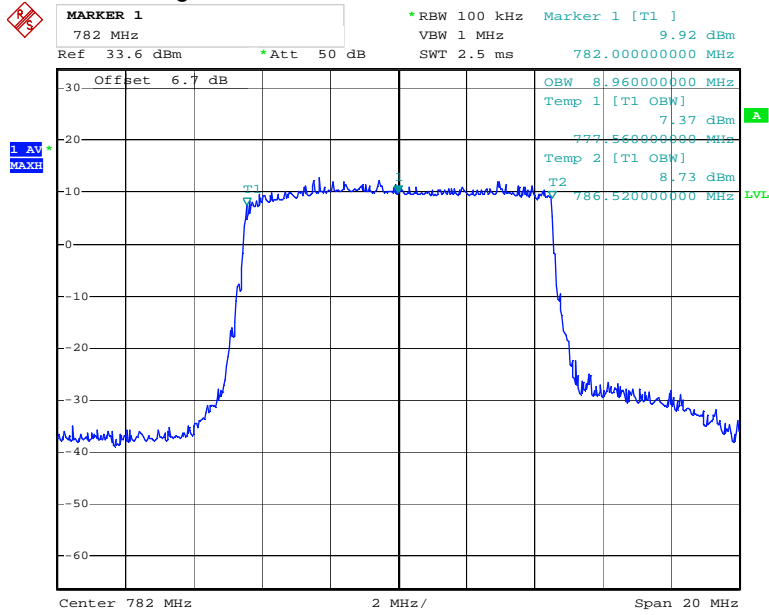
Date: 19.FEB.2016 14:41:38

Figure 26: Band 13, BW=5MHz, 16-QAM



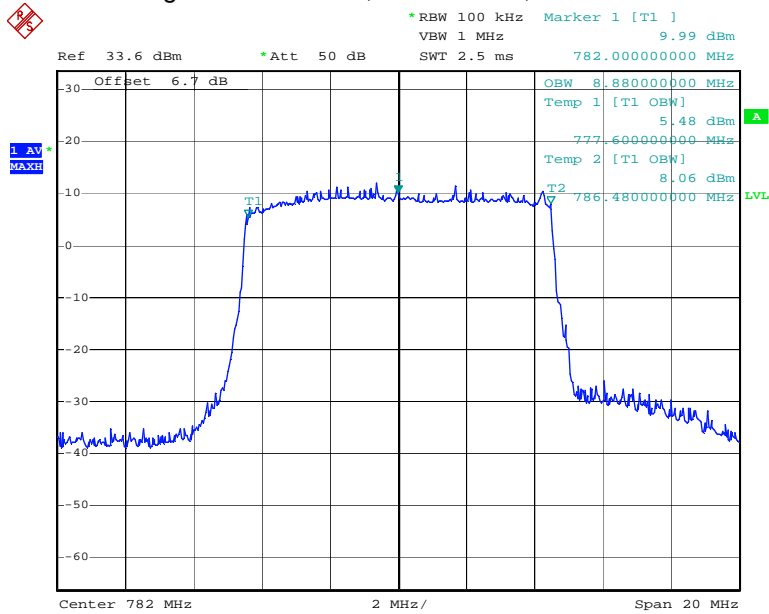
Date: 19.FEB.2016 14:42:46

Figure 27: Band 13, BW=10MHz, QPSK



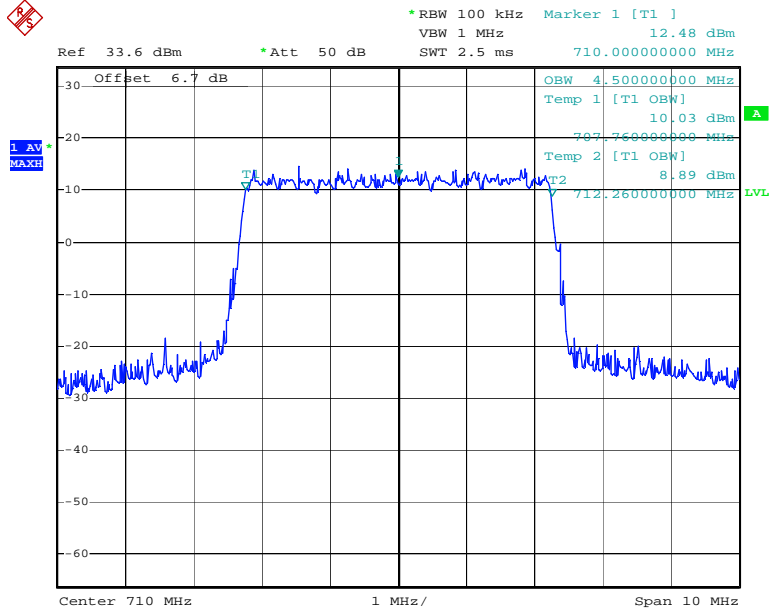
Date: 19.FEB.2016 14:44:37

Figure 28: Band 13, BW=10MHz, 16-QAM



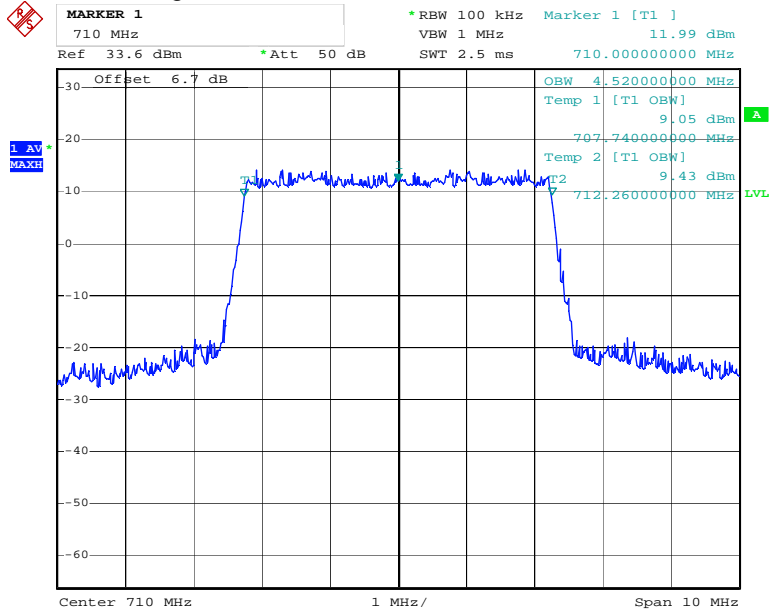
Date: 19.FEB.2016 14:44:53

Figure 29: Band 17, BW=5MHz, QPSK



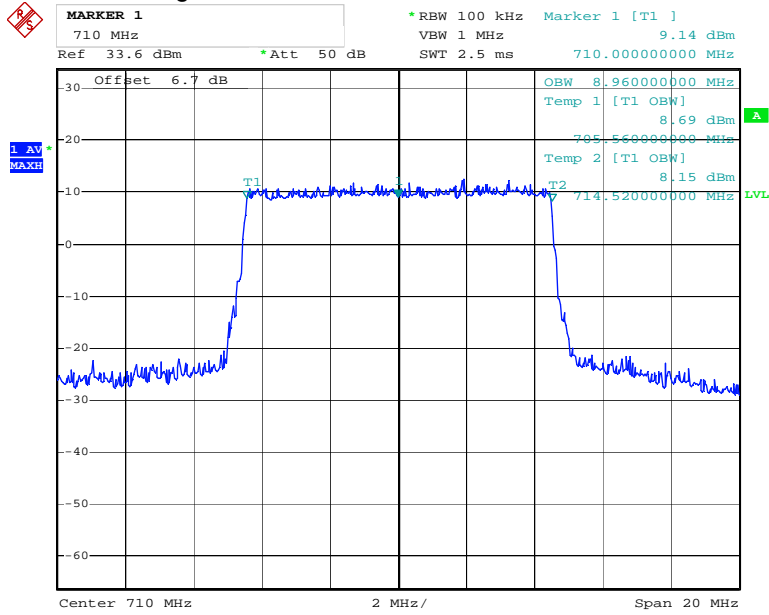
Date: 19.FEB.2016 14:48:40

Figure 30: Band 17, BW=5MHz, 16-QAM



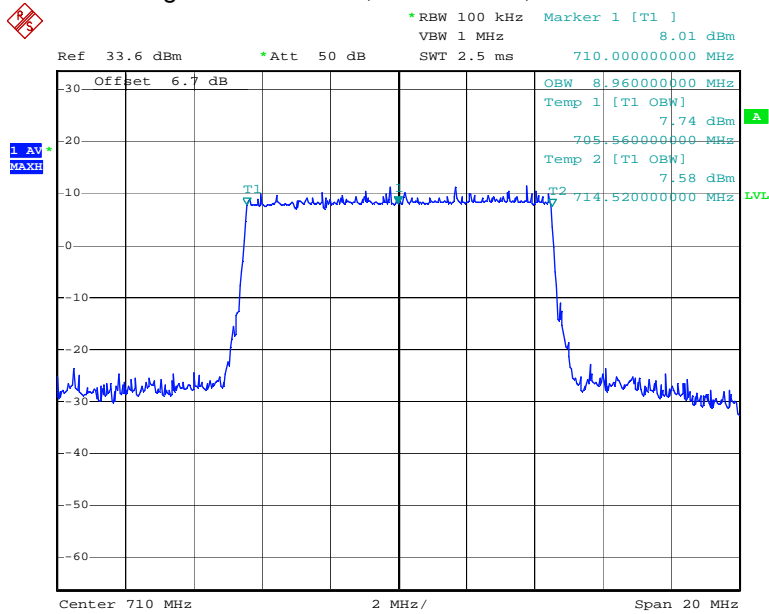
Date: 19.FEB.2016 14:48:34

Figure 31: Band 17, BW=10MHz, QPSK



Date: 19.FEB.2016 14:51:37

Figure 32: Band 17, BW=10MHz, 16-QAM



Date: 19.FEB.2016 14:51:50

## 6 Conducted Spurious Emissions at Antenna Terminals

### 6.1 Test Limits

#### § 2.1051

The radio frequency voltage or powers generated within the equipment and appearing on a spurious frequency shall be checked at the equipment output terminals when properly loaded with a suitable artificial antenna. Curves or equivalent data shall show the magnitude of each harmonic and other spurious emission that can be detected when the equipment is operated under the conditions specified in §2.1049 as appropriate. The magnitude of spurious emissions which are attenuated more than 20 dB below the permissible value need not be specified.

#### § 22.917

- (a) Out of band emissions. The power of any emission outside of the authorized operating frequency ranges must be attenuated below the transmitting power (P) by a factor of at least  $43 + 10 \log(P)$  dB.
- (b) Measurement procedure. Compliance with these rules is based on the use of measurement instrumentation employing a resolution bandwidth of 100 kHz or greater. In the 1 MHz bands immediately outside and adjacent to the frequency block a resolution bandwidth of at least one percent of the emission bandwidth of the fundamental emission of the transmitter may be employed. A narrower resolution bandwidth is permitted in all cases to improve measurement accuracy provided the measured power is integrated over the full required measurement bandwidth ( i.e. 100 kHz or 1 percent of emission bandwidth, as specified). The emission bandwidth is defined as the width of the signal between two points, one below the carrier center frequency and one above the carrier center frequency, outside of which all emissions are attenuated at least 26 dB below the transmitter power.

#### § 24.238

- (a) Out of band emissions. The power of any emission outside of the authorized operating frequency ranges must be attenuated below the transmitting power (P) by a factor of at least  $43 + 10 \log(P)$  dB.
- (b) Measurement procedure. Compliance with these rules is based on the use of measurement instrumentation employing a resolution bandwidth of 1 MHz or greater. However, in the 1 MHz bands immediately outside and adjacent to the frequency block a resolution bandwidth of at least one percent of the emission bandwidth of the fundamental emission of the transmitter may be employed. A narrower resolution bandwidth is permitted in all cases to improve measurement accuracy provided the measured power is integrated over the full required measurement bandwidth ( i.e. 1 MHz or 1 percent of emission bandwidth, as specified). The emission bandwidth is defined as the width of the signal between two points, one below the carrier center frequency and one above the carrier center frequency, outside of which all emissions are attenuated at least 26 dB below the transmitter power.



**§ 27.53**

- (c) For operations in the 746-758 MHz band and the 776-788 MHz band, the power of an emission outside the licensee's frequency band(s) of operation shall be attenuated below the transmitter power (P) within the licensed band(s) of operation, measured in watts, in accordance with the following:
- (c) (2) On any frequency outside the 776-788 MHz band, the power of any emission shall be attenuated outside the band below the transmitter power (P) by at least  $43 + 10 \log (P)$  dB;
- (c) (5) Compliance with the provisions of paragraphs (c)(1) and (c)(2) of this section is based on the use of measurement instrumentation employing a resolution bandwidth of 100 kHz or greater. However, in the 100 kHz bands immediately outside and adjacent to the frequency block, a resolution bandwidth of at least 30 kHz may be employed.
- (g) For operations in the 600 MHz band and the 698-746 MHz band, the power of any emission outside a licensee's frequency band(s) of operation shall be attenuated below the transmitter power (P) within the licensed band(s) of operation, measured in watts, by at least  $43 + 10 \log (P)$  dB. Compliance with this provision is based on the use of measurement instrumentation employing a resolution bandwidth of 100 kilohertz or greater. However, in the 100 kilohertz bands immediately outside and adjacent to a licensee's frequency block, a resolution bandwidth of at least 30 kHz may be employed.
- (h) *AWS emission limits—(1) General protection levels.* Except as otherwise specified below, for operations in the 1695-1710 MHz, 1710-1755 MHz, 1755-1780 MHz, 1915-1920 MHz, 1995-2000 MHz, 2000-2020 MHz, 2110-2155 MHz, 2155-2180 MHz, and 2180-2200 bands, the power of any emission outside a licensee's frequency block shall be attenuated below the transmitter power (P) in watts by at least  $43 + 10 \log_{10} (P)$  dB.

**6.2 Test Procedure**

The RF output of the EUT was connected to a spectrum analyzer through appropriate attenuation. The base station simulator was set to force the EUT to its maximum power setting. The resolution bandwidth of the spectrum analyzer was set at 100kHz or 1MHz depending on the transmit band and the detector was set to peak detection for general scans up to the 10<sup>th</sup> harmonic. Emissions scans near the fundamental were measured using an RMS detector. Sufficient scans were taken to show the out of band Emissions if any up to 10th harmonic.

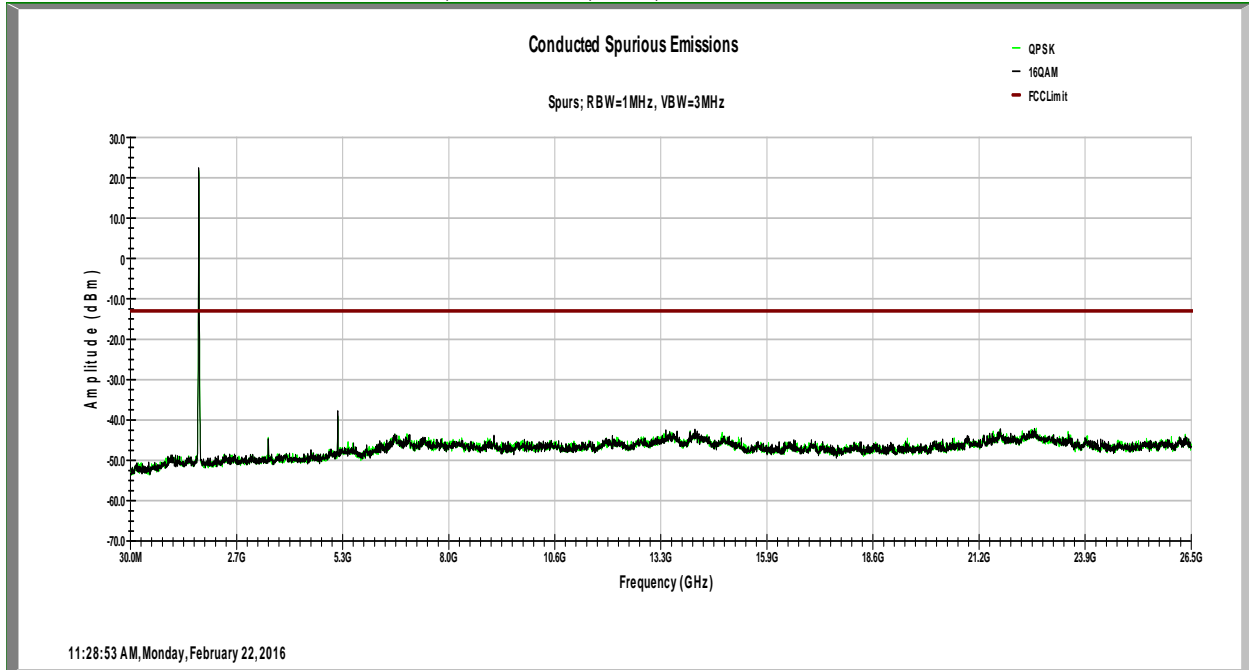
**6.3 Test Equipment Used:**

Description	Serial Number	Manufacturer	Model	Cal. Date	Cal. Due
Base Station Simulator	3917	Rohde & Schwarz	CMW500	9/19/2015	9/19/2016
Spectrum Analyzer	3099	Rohde & Schwarz	FSP7	9/18/2015	9/18/2016
Spectrum Analyzer	3720	Rohde & Schwarz	FSEK30	9/19/2015	9/19/2016
Power Divider	E18106	Weinschell Engineering	1506A	Time of Use	Time of Use

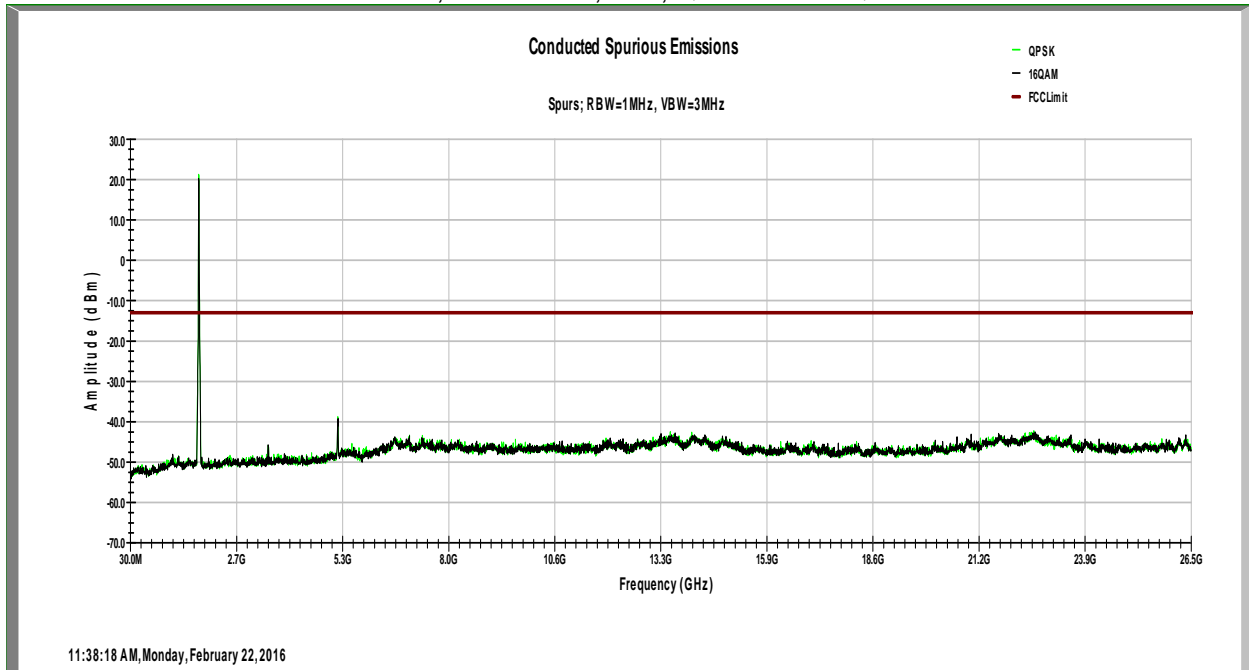
**6.4 Results:**

The following plots show that all spurious emissions are attenuated below the transmitting power (P) by a factor of at least 43 + 10 log(P) dB. Plots for emissions within 1MHz of the transmit block edge as well as for emission outside of this range are shown.

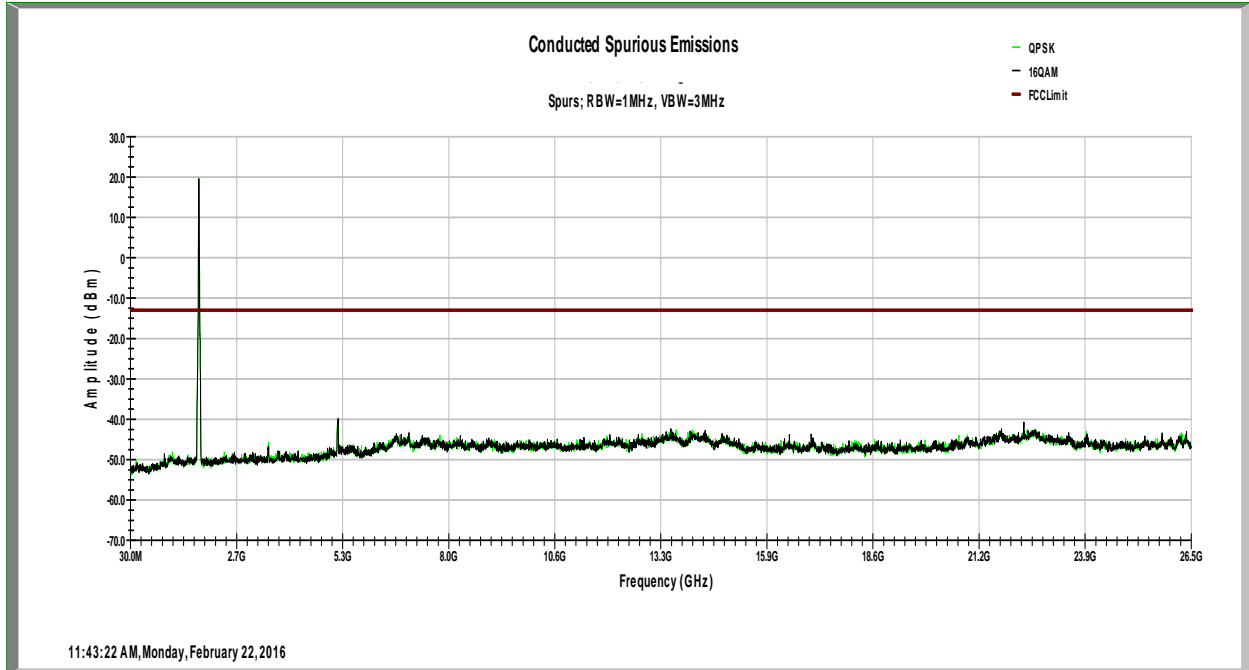
Band 2, BW=5MHz, 1RB, QPSK and 16-QAM



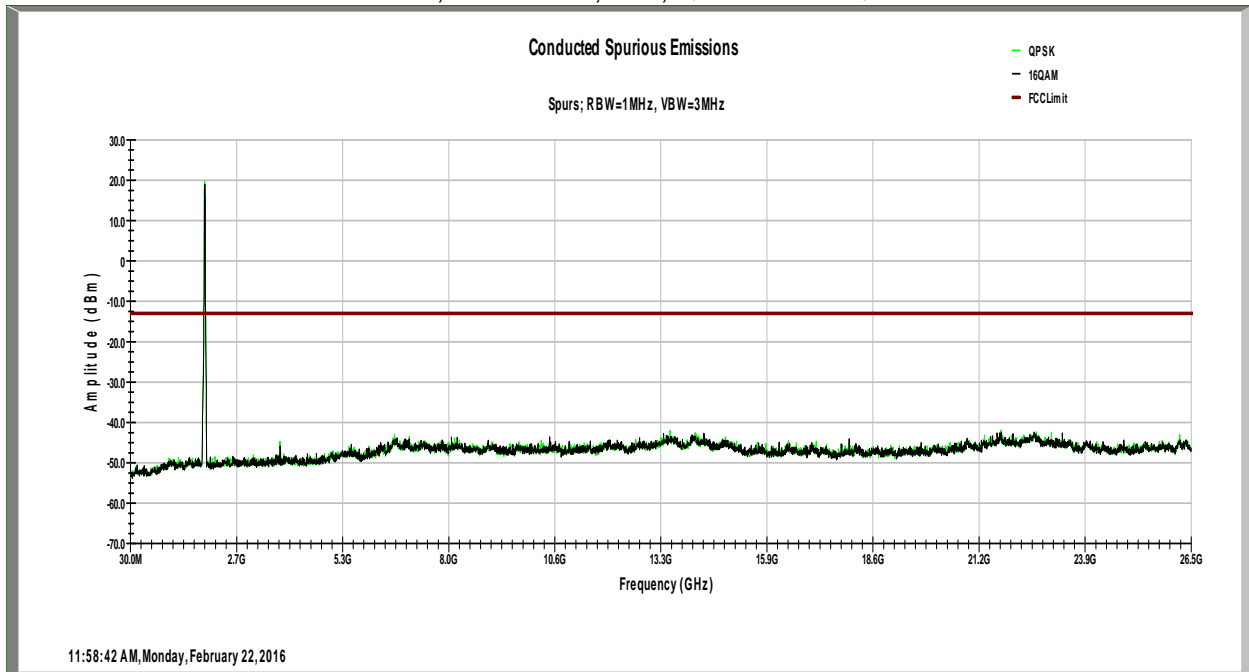
Band 2, BW=10MHz, 1RB, QPSK and 16-QAM



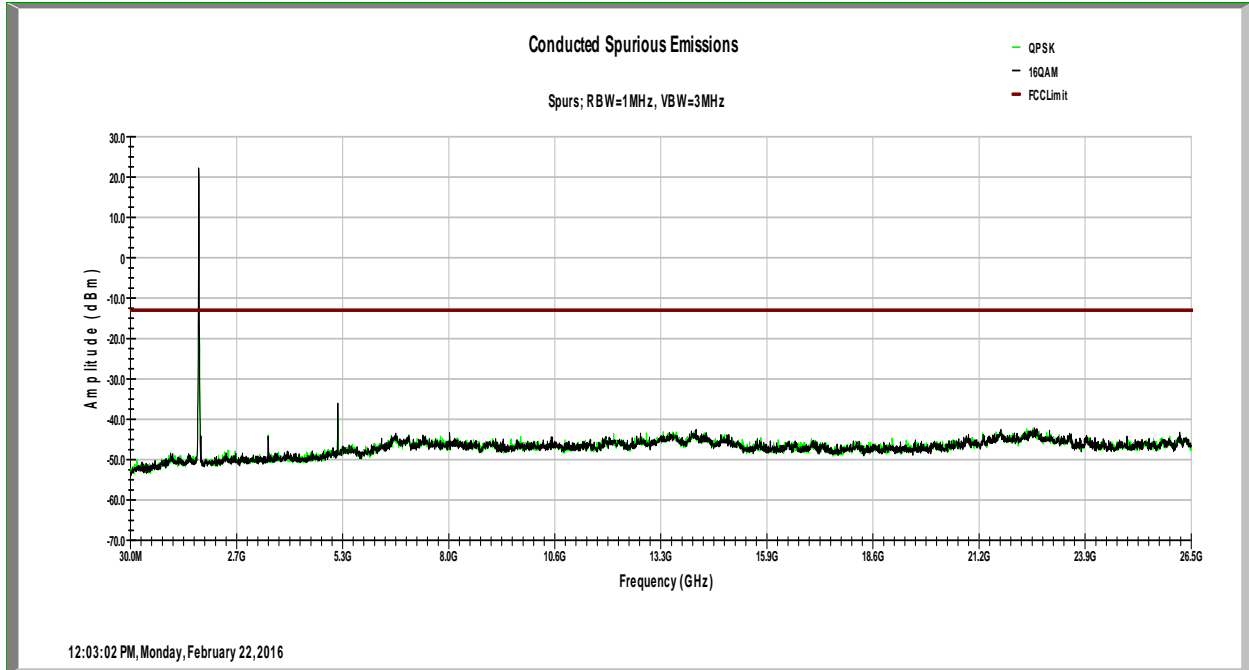
Band 2, BW=15MHz, 1RB, QPSK and 16-QAM



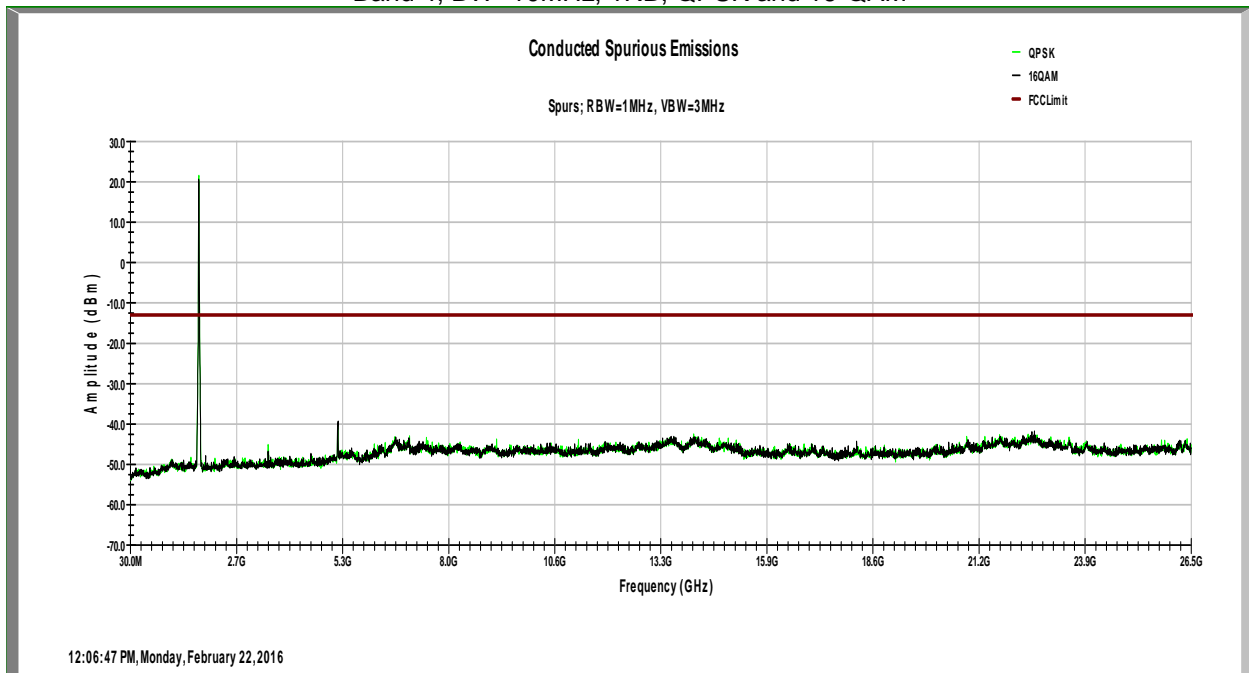
Band 2, BW=20MHz, 1RB, QPSK and 16-QAM



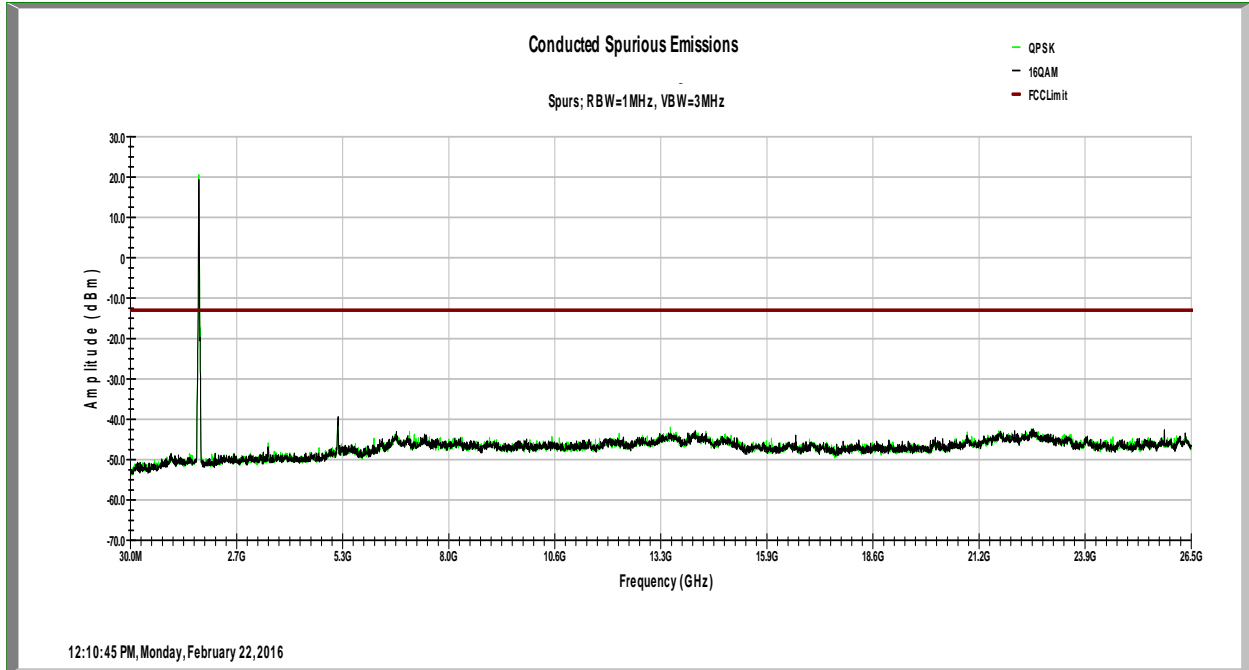
Band 4, BW=5MHz, 1RB, QPSK and 16-QAM



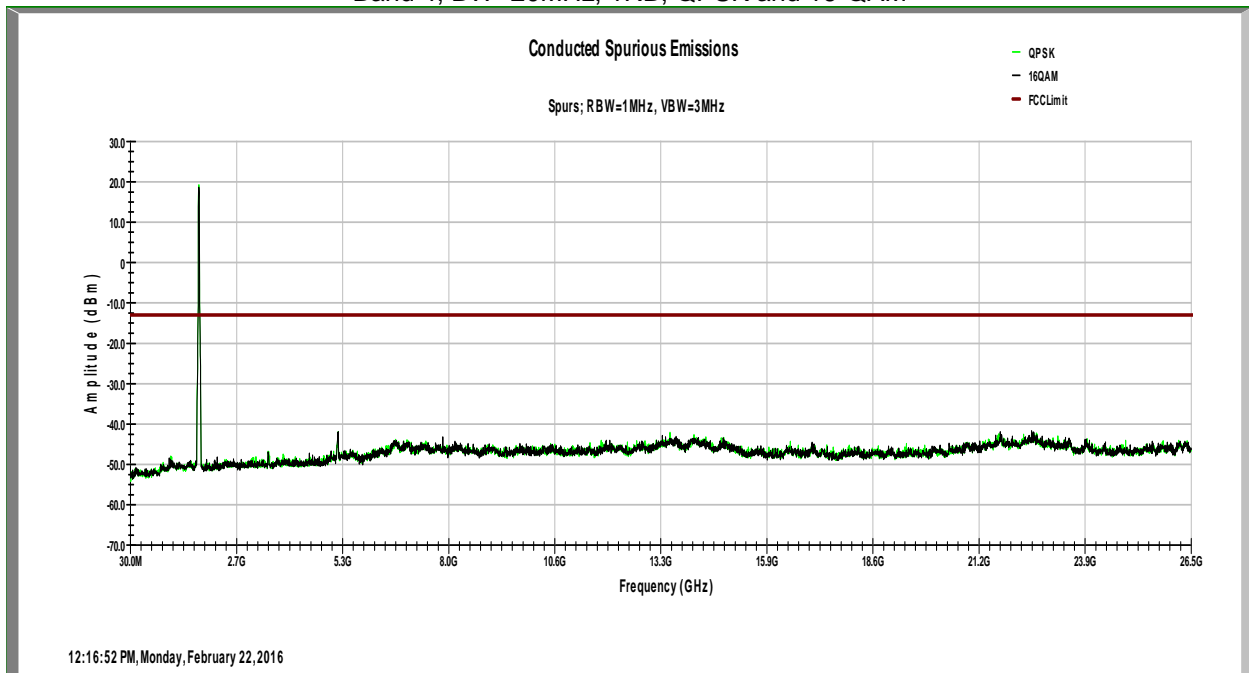
Band 4, BW=10MHz, 1RB, QPSK and 16-QAM



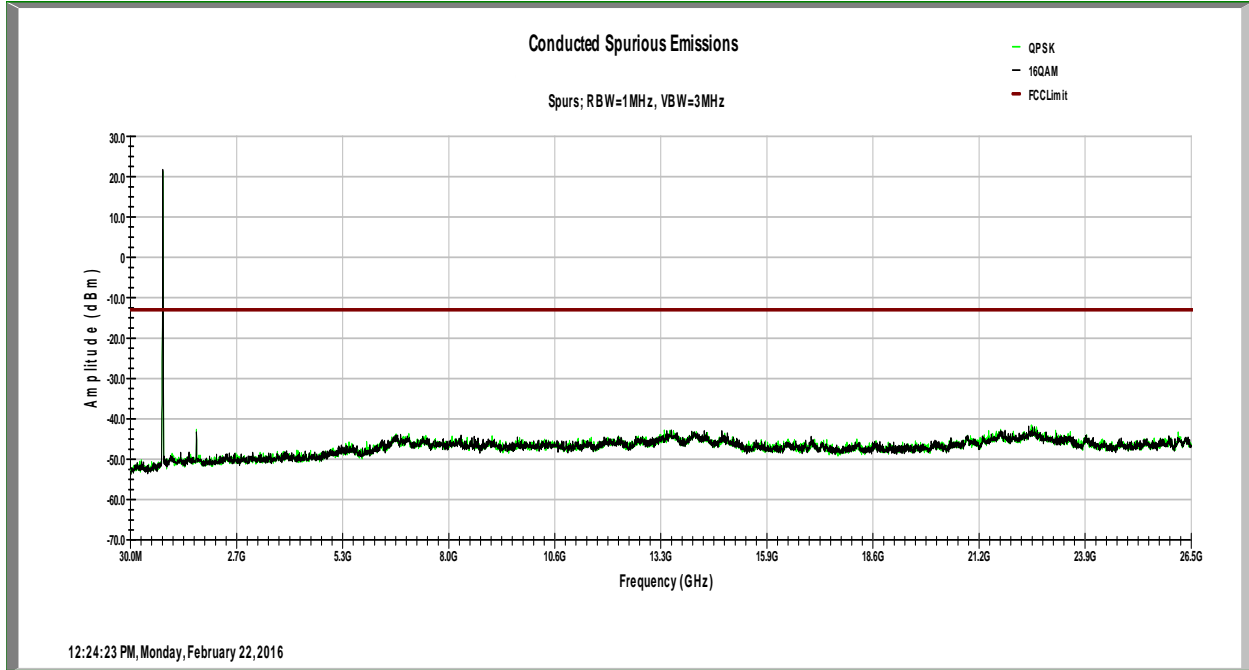
Band 4, BW=15MHz, 1RB, QPSK and 16-QAM



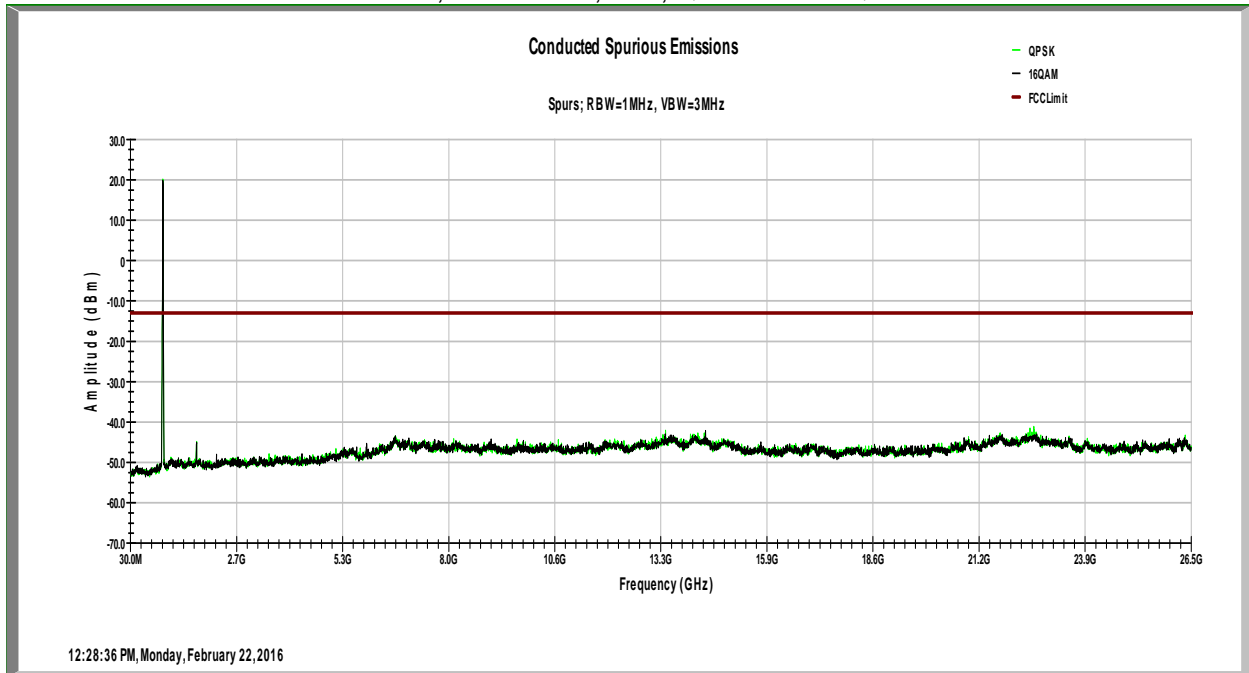
Band 4, BW=20MHz, 1RB, QPSK and 16-QAM



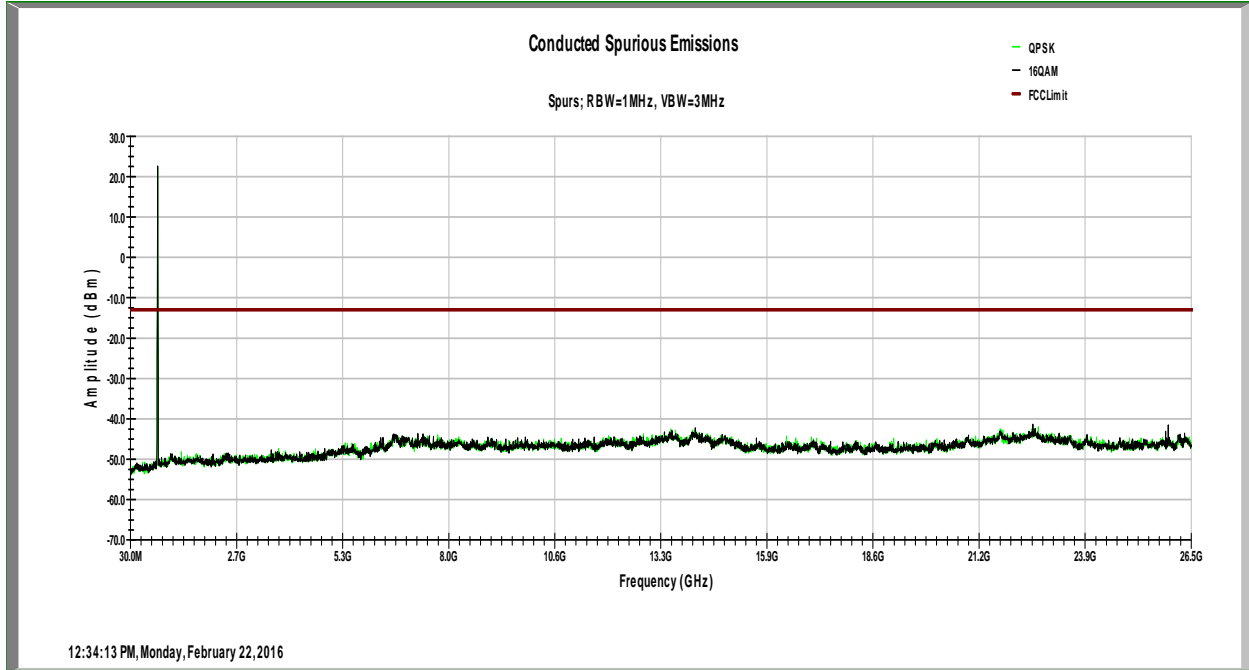
Band 5, BW=5MHz, 1RB, QPSK and 16-QAM



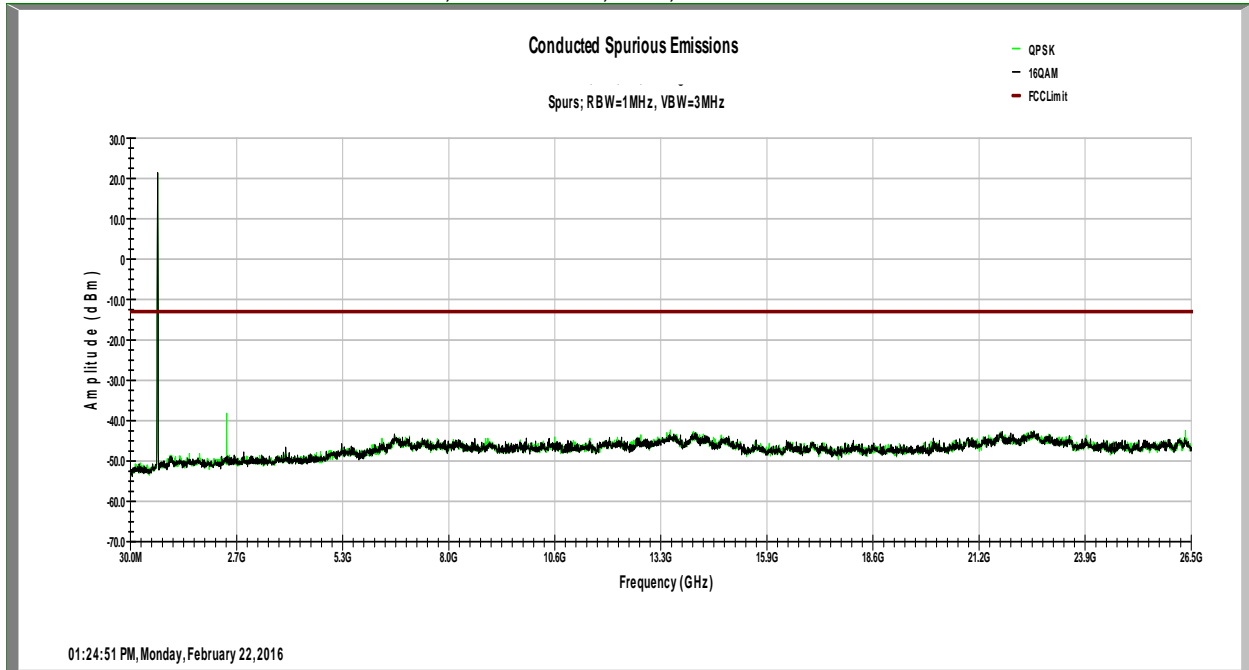
Band 5, BW=10MHz, 1RB, QPSK and 16-QAM



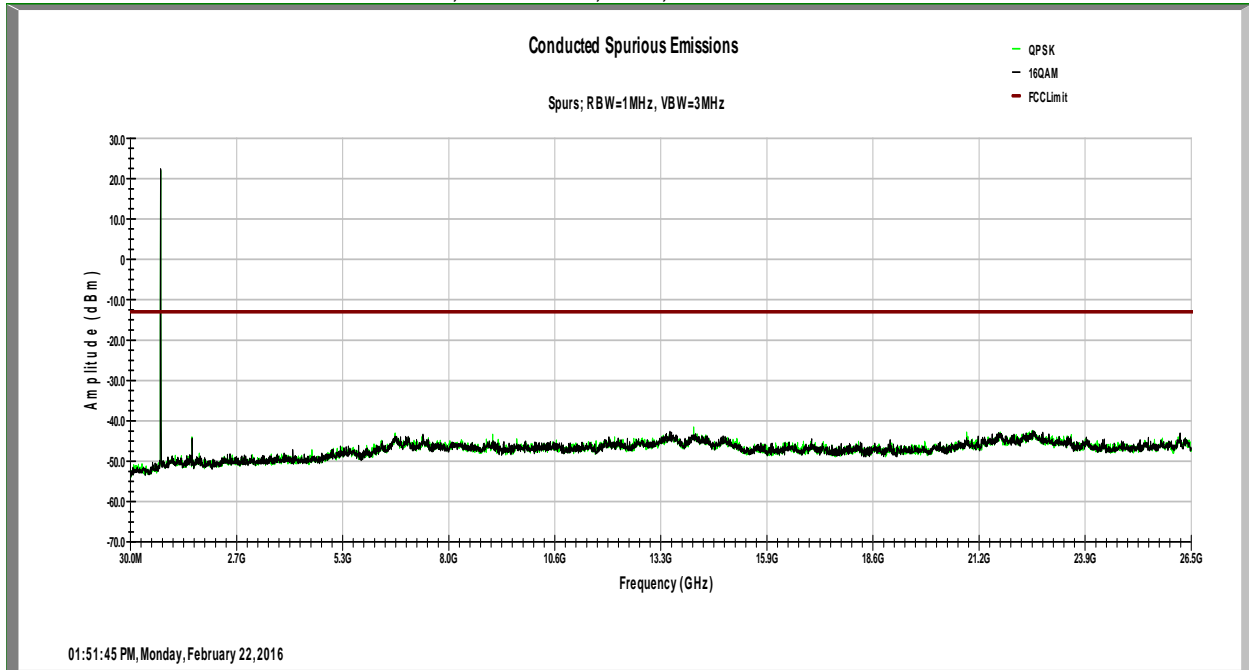
Band 12, BW=5MHz, 1RB, QPSK and 16-QAM



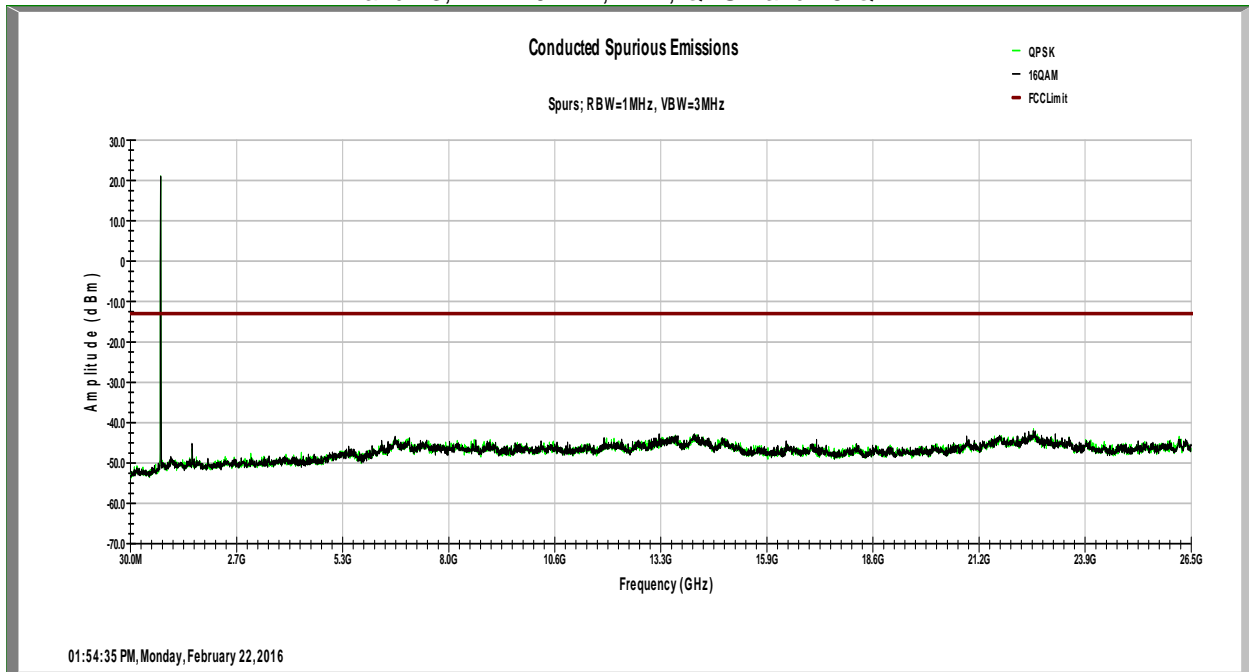
Band 12, BW=10MHz, 1RB, QPSK and 16-QAM



Band 13, BW=5MHz, 1RB, QPSK and 16-QAM

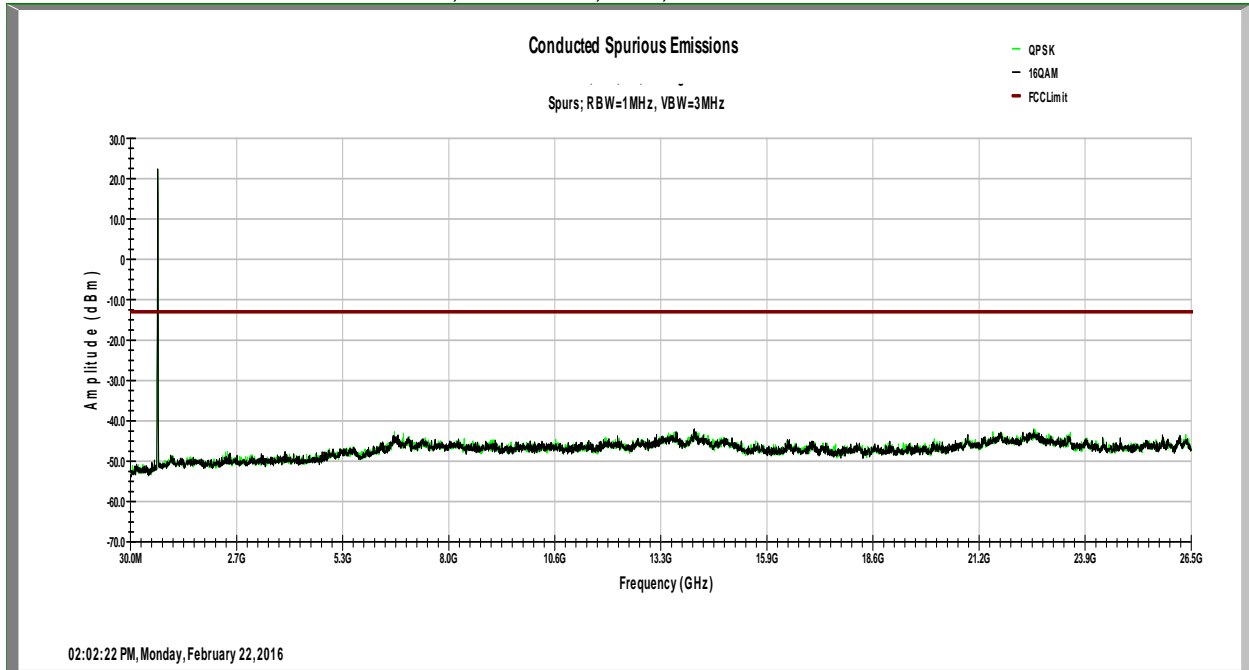


Band 13, BW=10MHz, 1RB, QPSK and 16-QAM

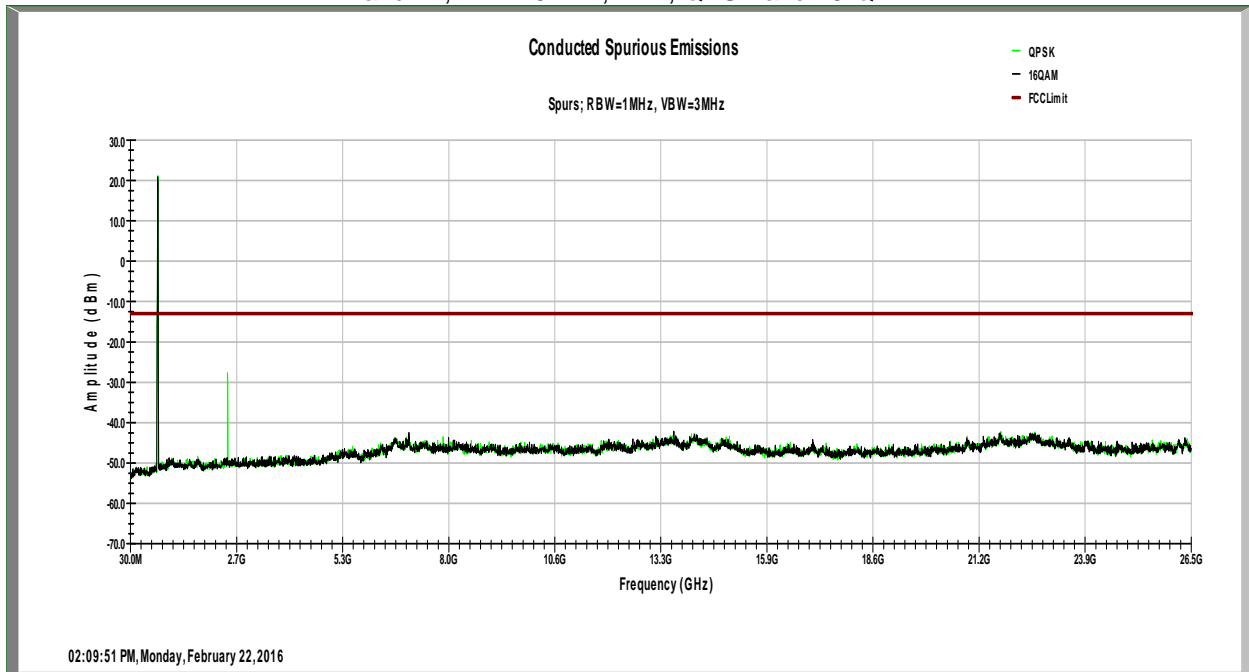




Band 17, BW=5MHz, 1RB, QPSK and 16-QAM

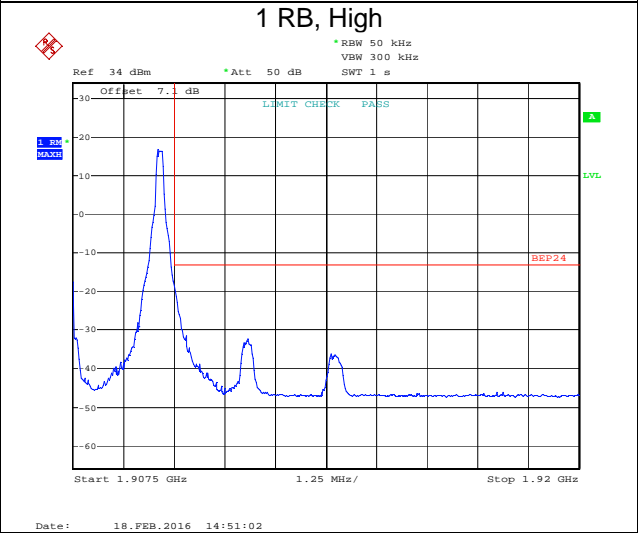
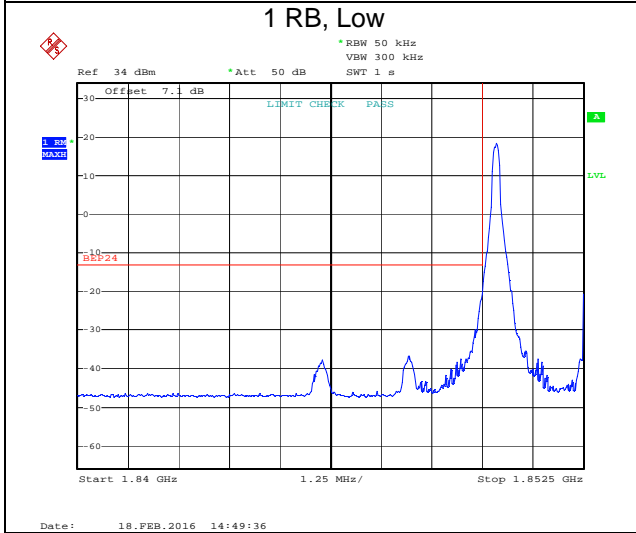
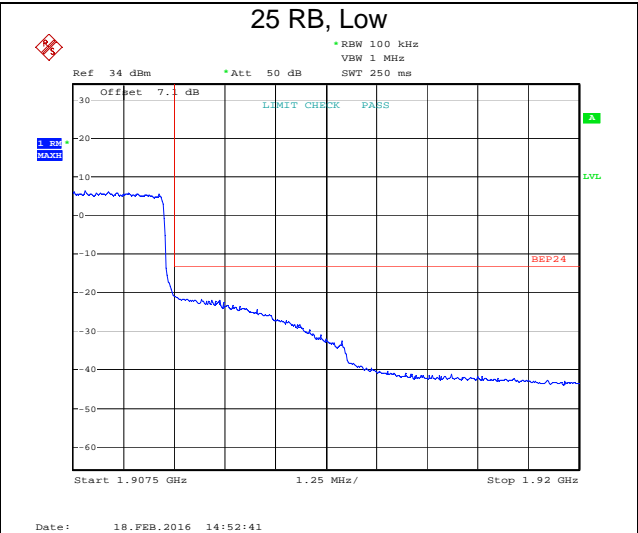
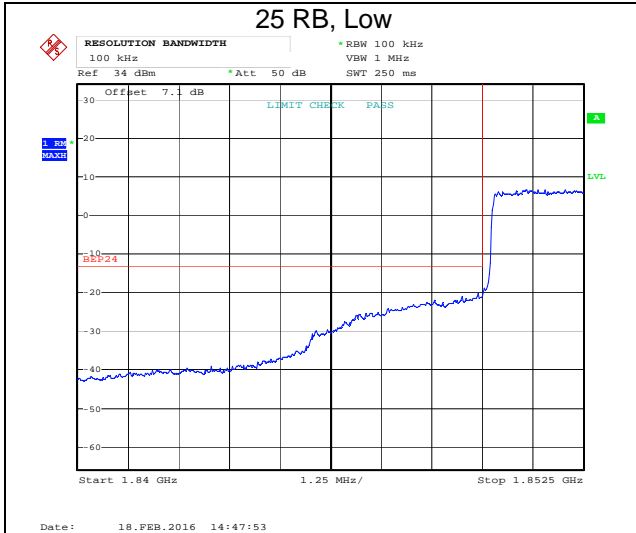


Band 17, BW=10MHz, 1RB, QPSK and 16-QAM



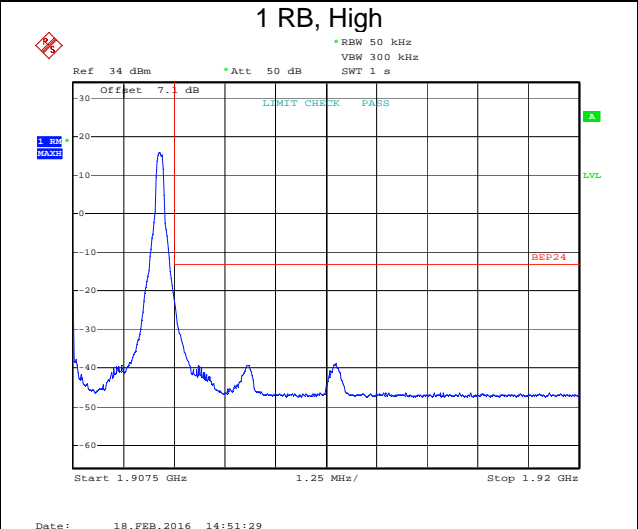
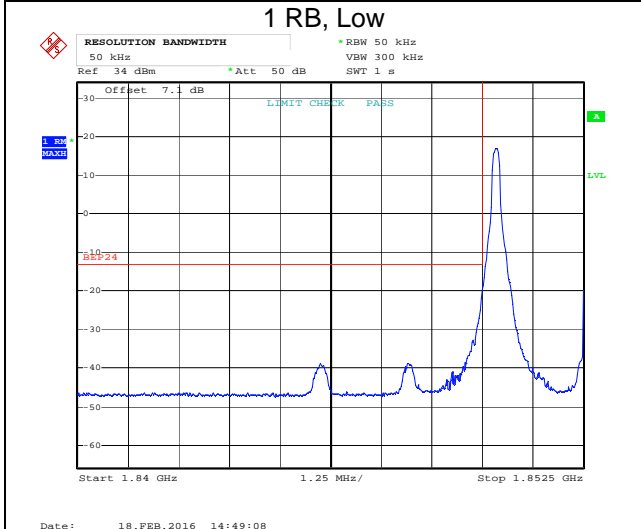
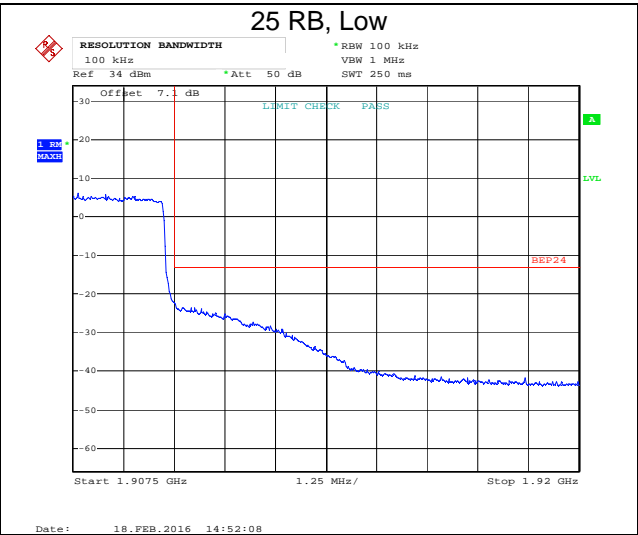
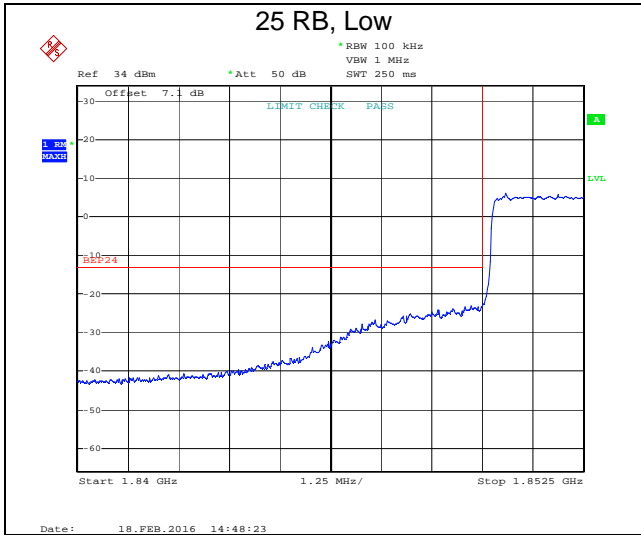
Band 2, 5 MHz BW, QPSK

Channel 18625, 1852.5 MHz Below 1850 MHz	Channel 19175, 1907.5 MHz Above 1910 MHz
---	---



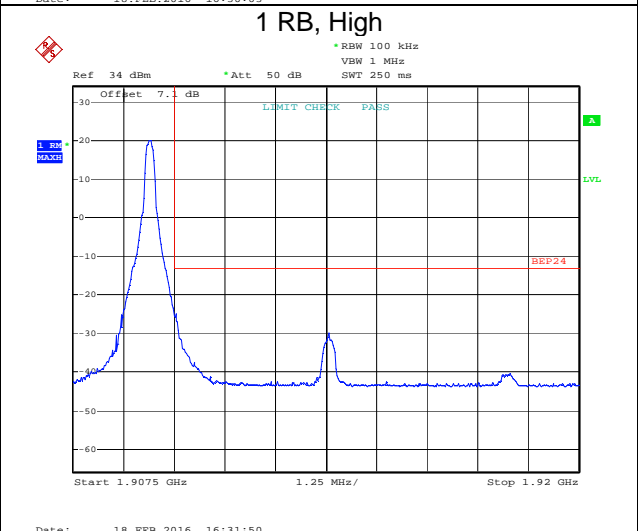
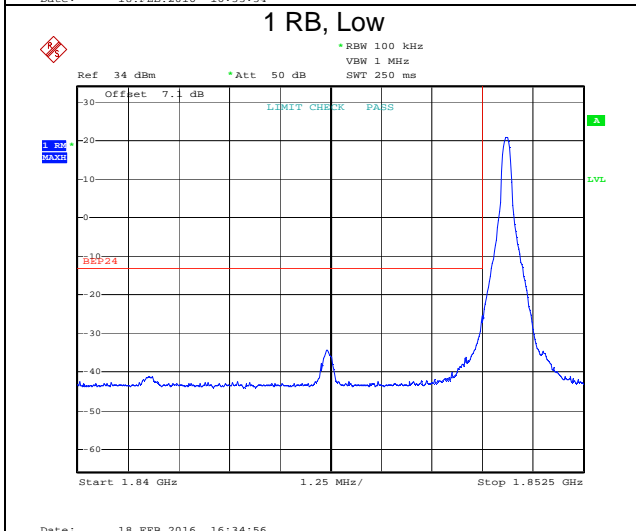
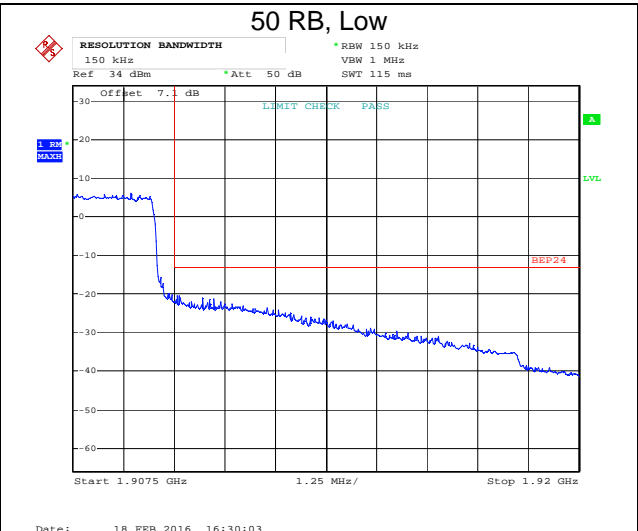
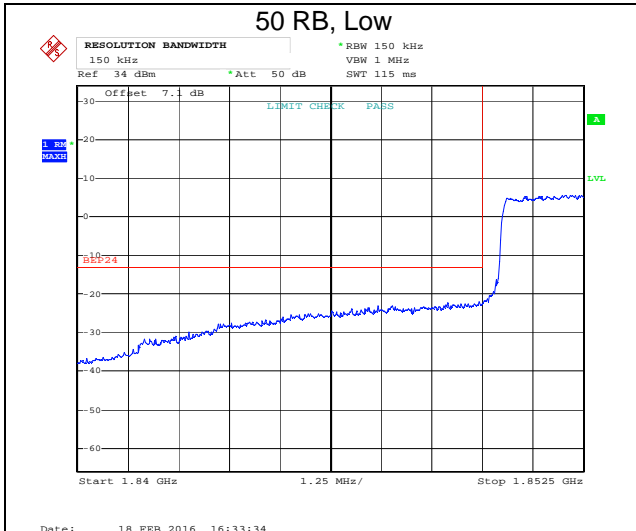
Band 2, 5 MHz BW, 16-QAM

Channel 18625, 1852.5 MHz Below 1850 MHz	Channel 19175, 1907.5 MHz Above 1910 MHz
---	---



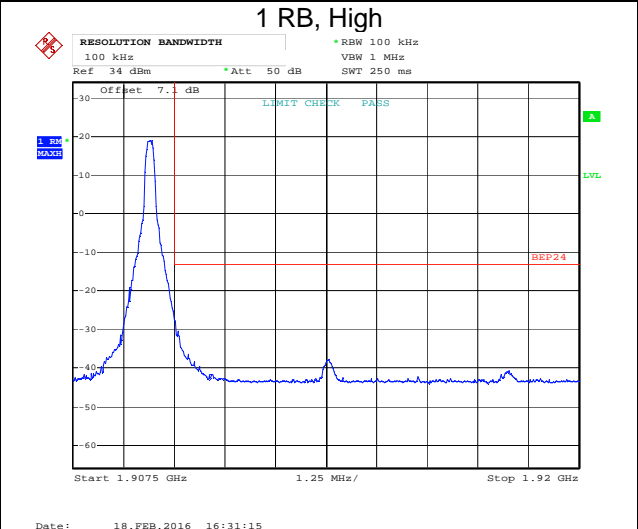
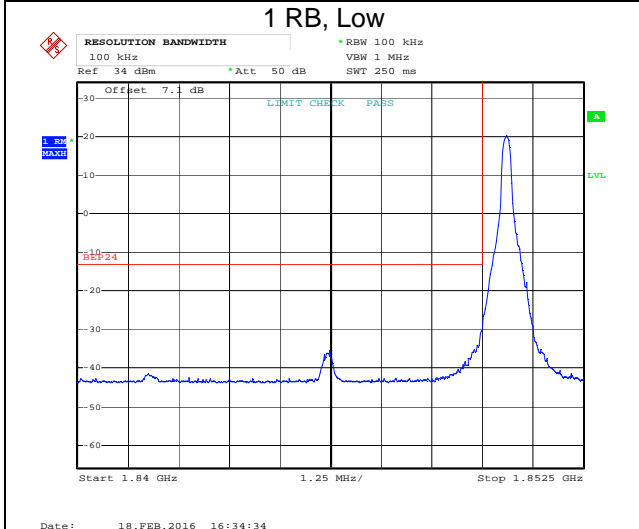
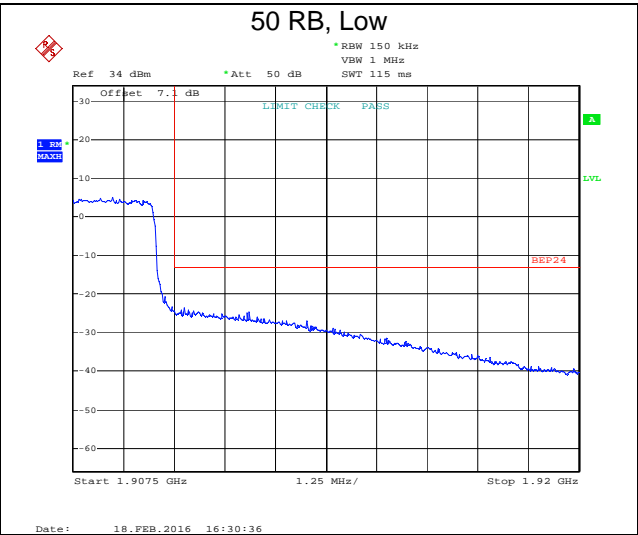
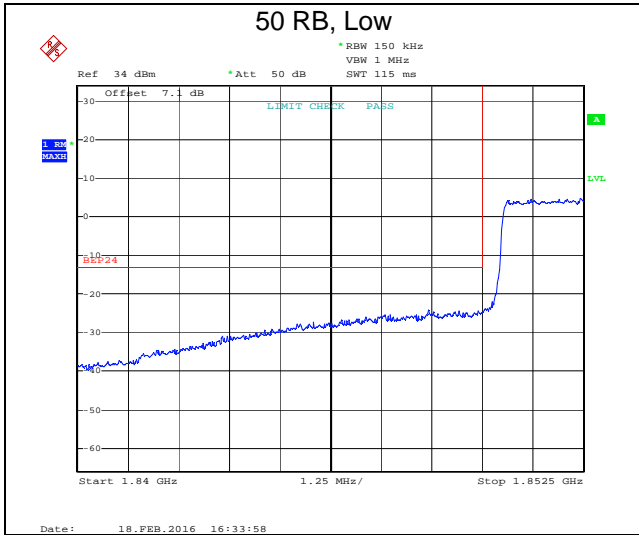
Band 2, 10 MHz BW, QPSK

Channel 18650, 1855.0 MHz Below 1850 MHz	Channel 19150, 1905.0 MHz Above 1910 MHz
---	---



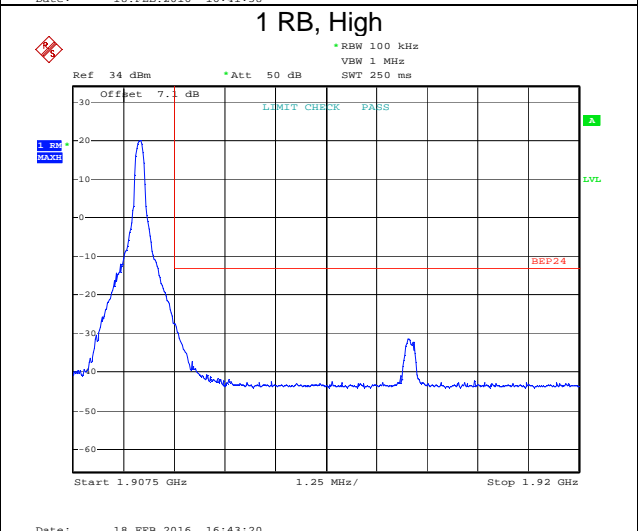
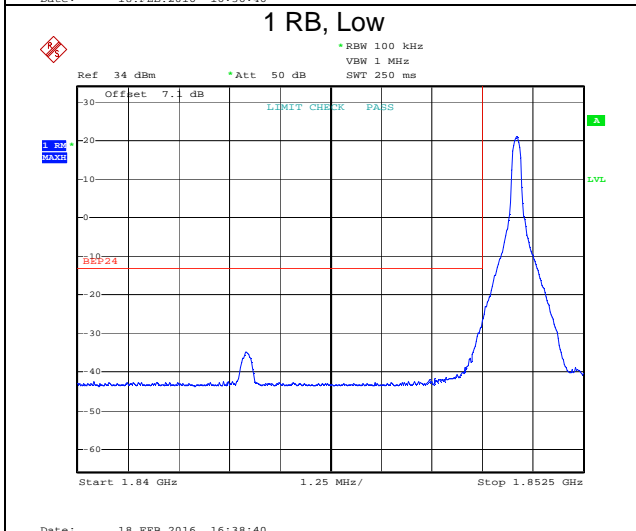
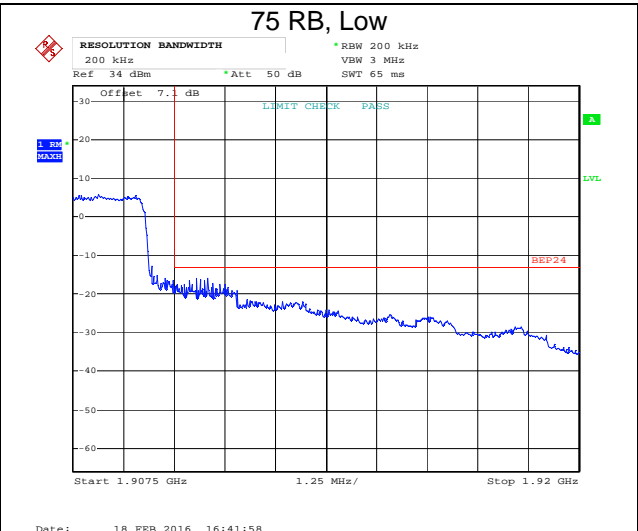
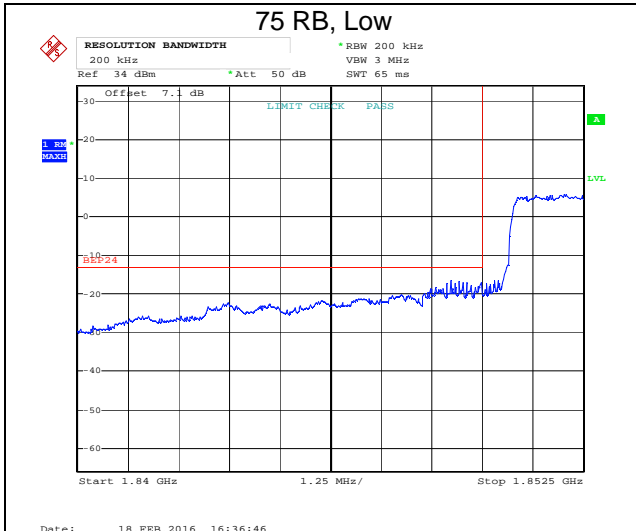
Band 2, 10 MHz BW, 16-QAM

Channel 18650, 1855.0 MHz Below 1850 MHz	Channel 19150, 1905.0 MHz Above 1910 MHz
---	---



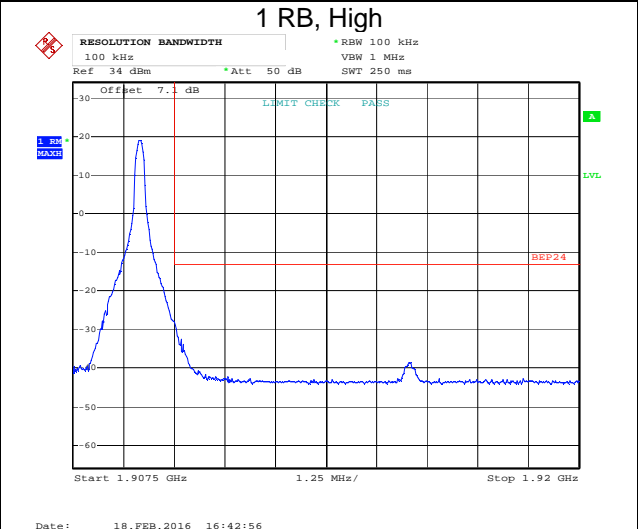
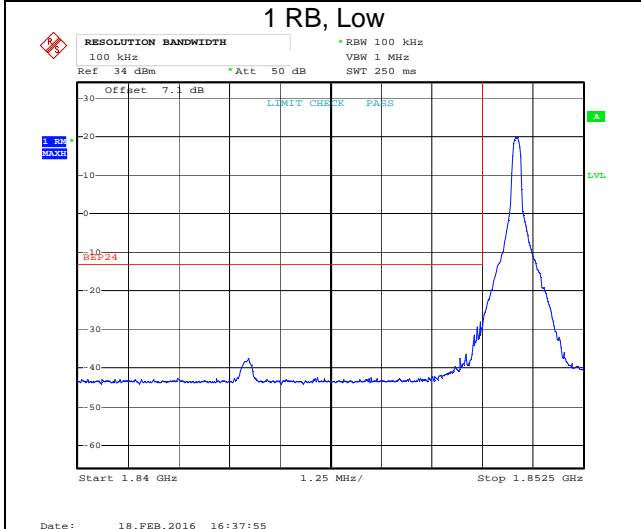
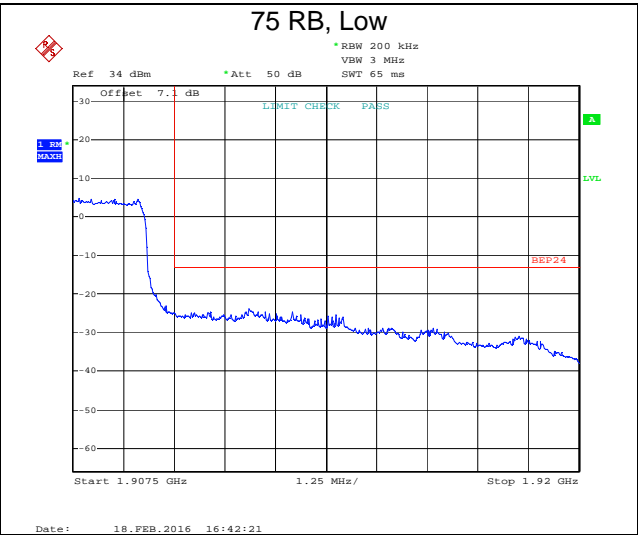
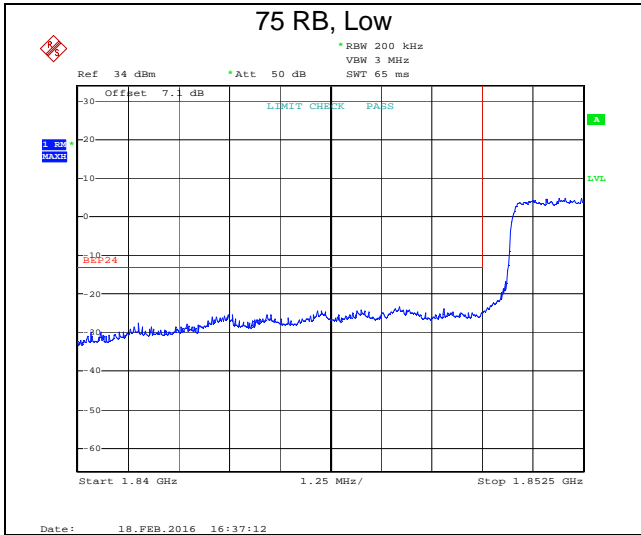
Band 2, 15 MHz BW, QPSK

Channel 18675, 1857.5 MHz Below 1850 MHz	Channel 19125, 1902.5 MHz Above 1910 MHz
---	---



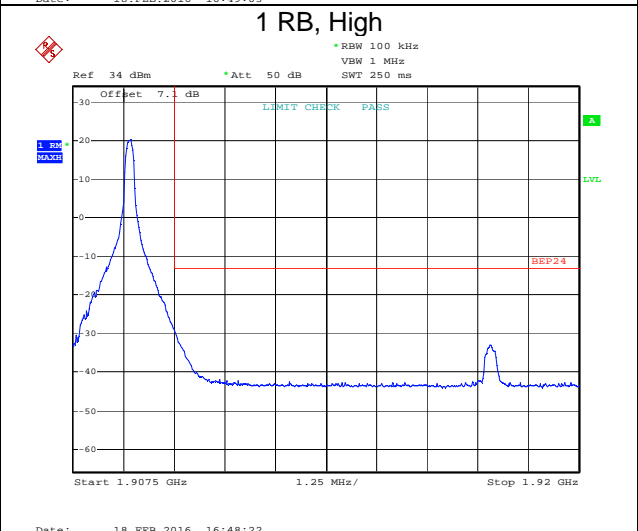
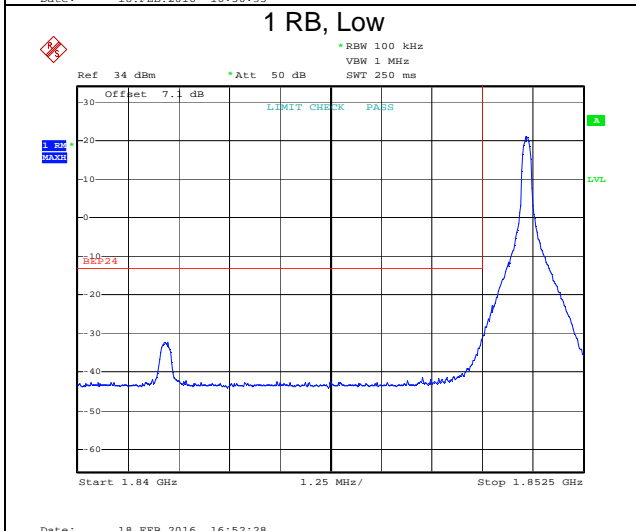
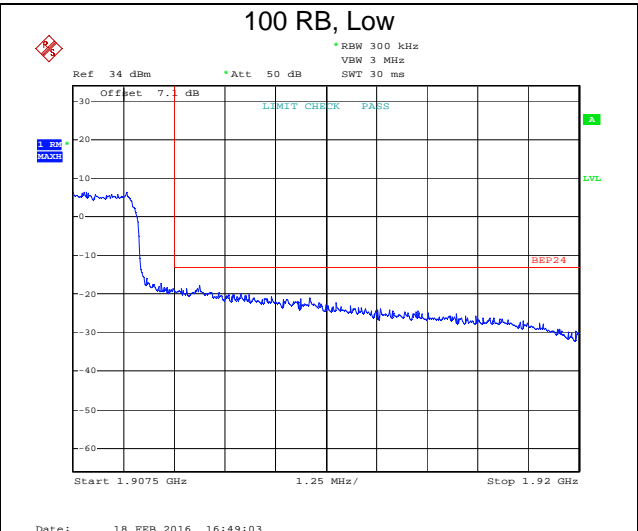
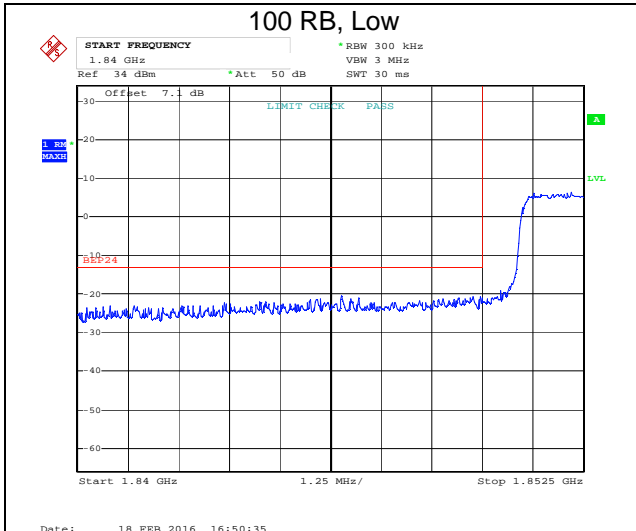
Band 2, 15 MHz BW, 16-QAM

Channel 18675, 1857.5 MHz Below 1850 MHz	Channel 19125, 1902.5 MHz Above 1910 MHz
---	---



Band 2, 20 MHz BW, QPSK

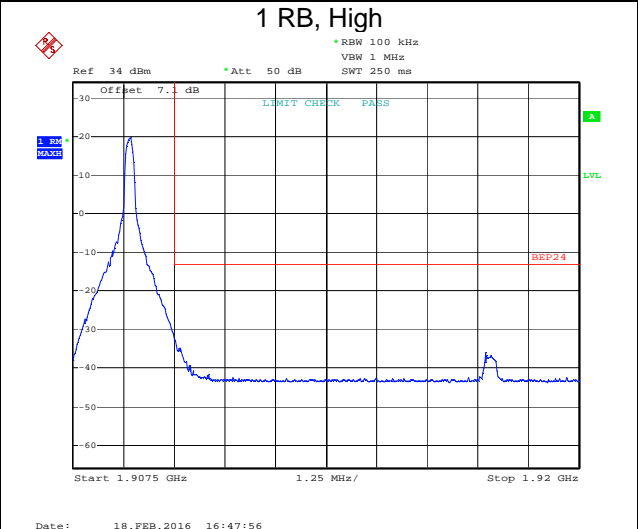
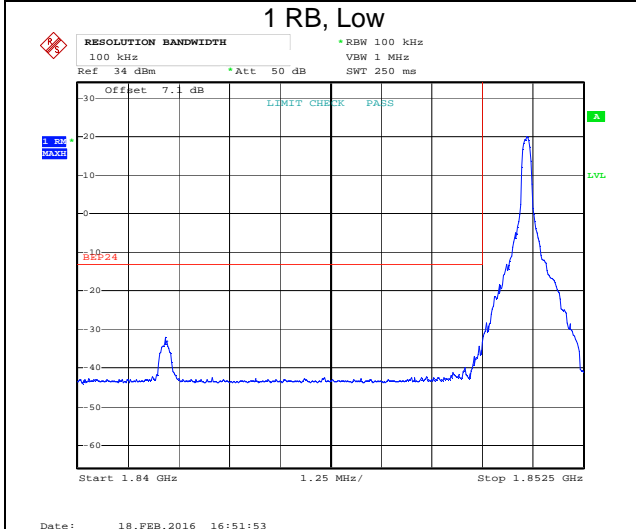
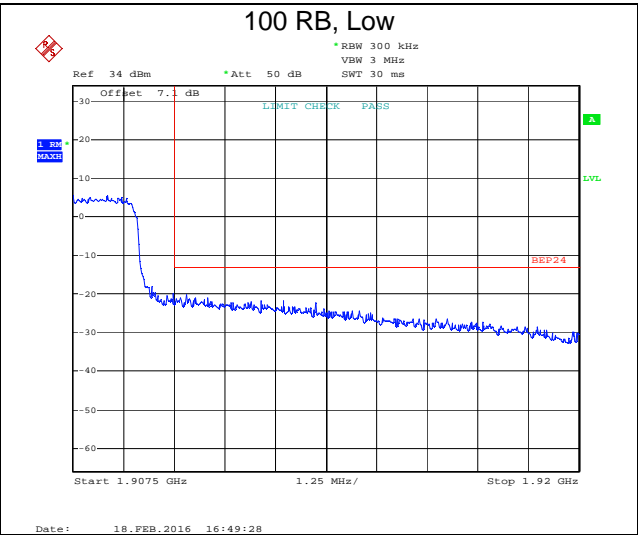
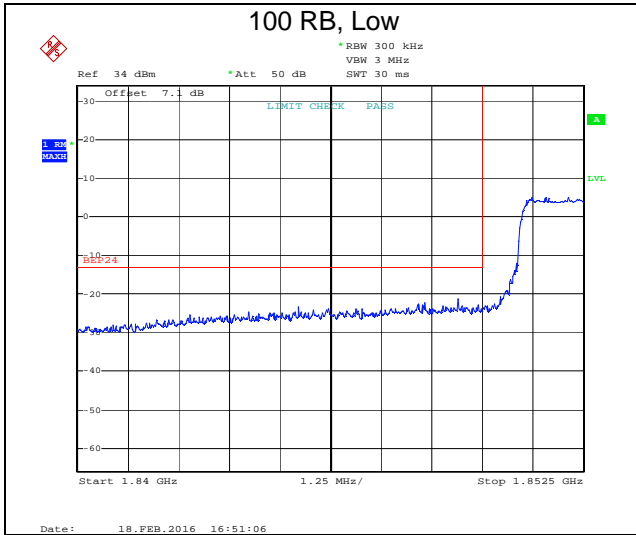
Channel 18700, 1860.0 MHz Below 1850 MHz	Channel 19100, 1900.0 MHz Above 1910 MHz
---	---





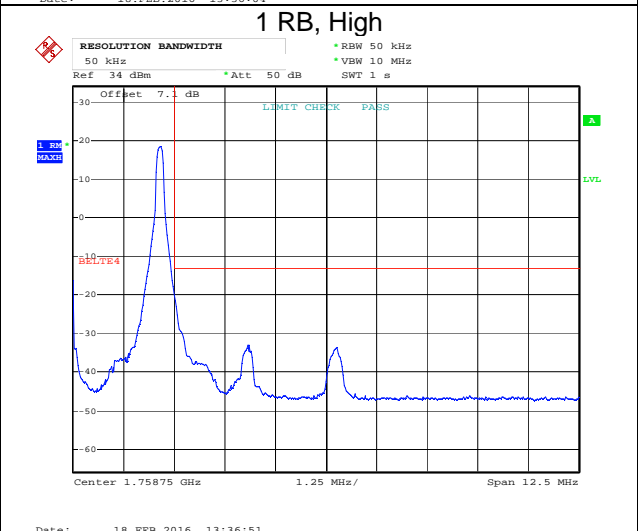
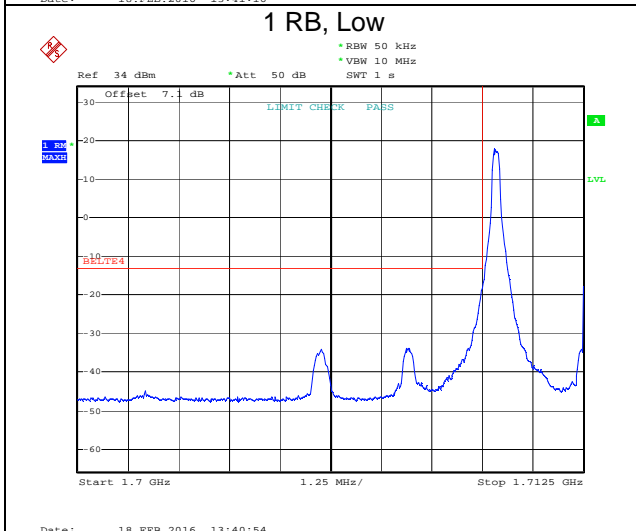
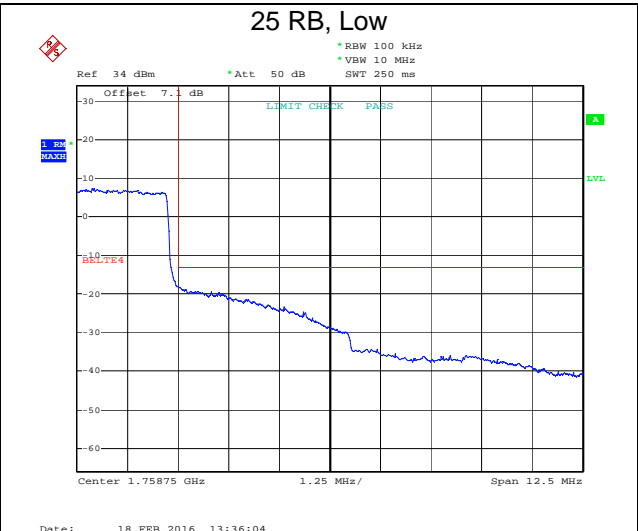
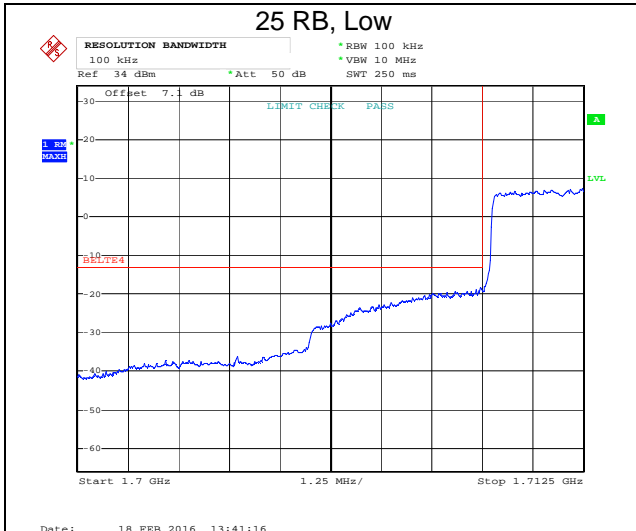
Band 2, 20 MHz BW, 16-QAM

Channel 18700, 1860.0 MHz Below 1850 MHz	Channel 19100, 1900.0 MHz Above 1910 MHz
---	---



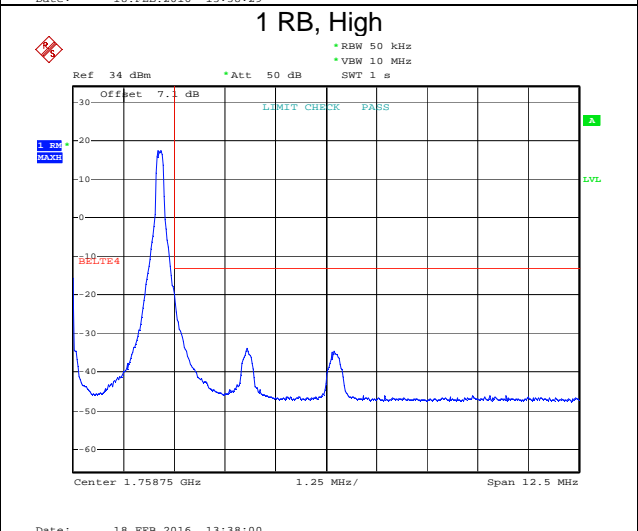
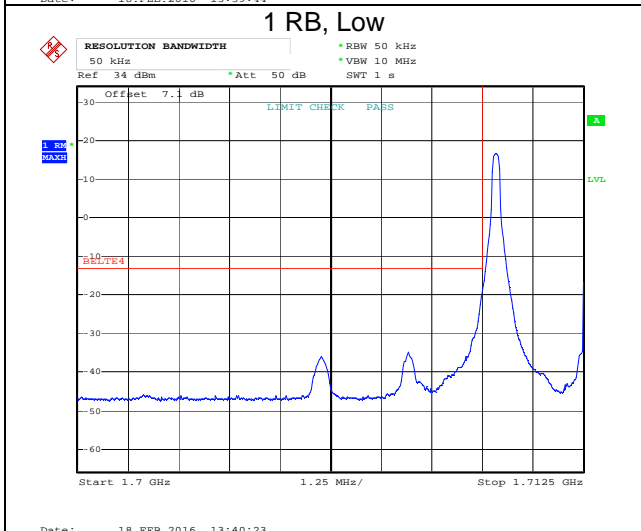
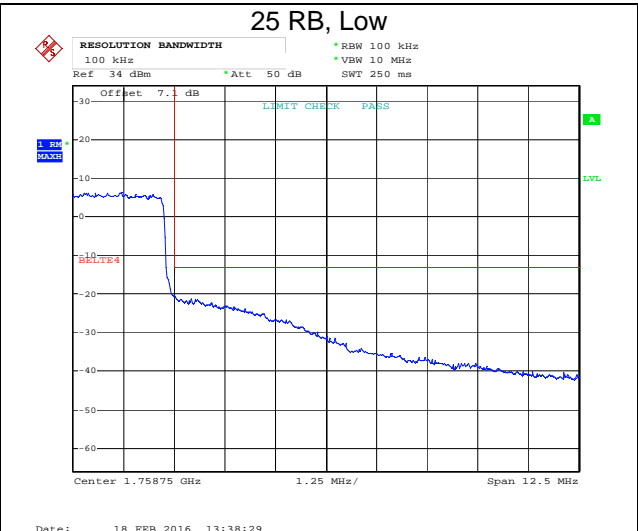
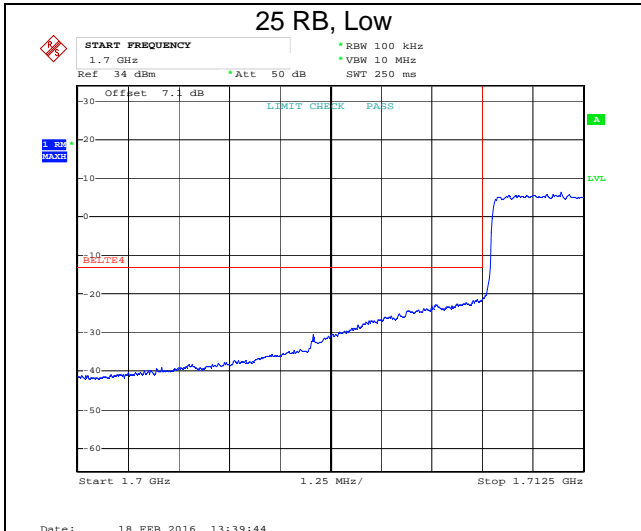
Band 4, 5 MHz BW, QPSK

Channel 19975, 1712.5 MHz Below 1710 MHz	Channel 20375, 1752.5 MHz Above 1755 MHz
---	---



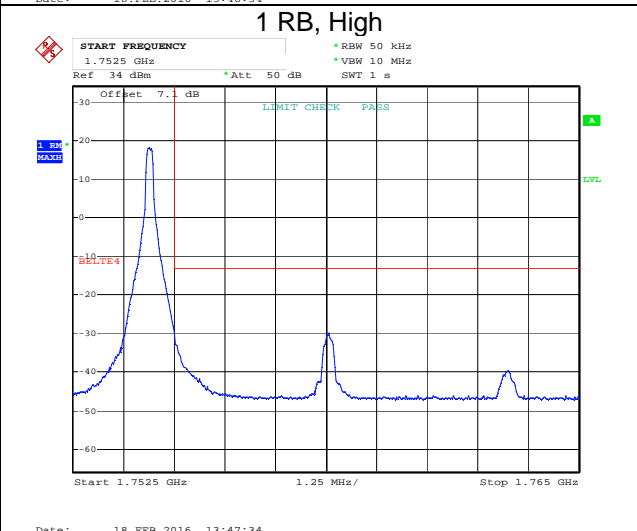
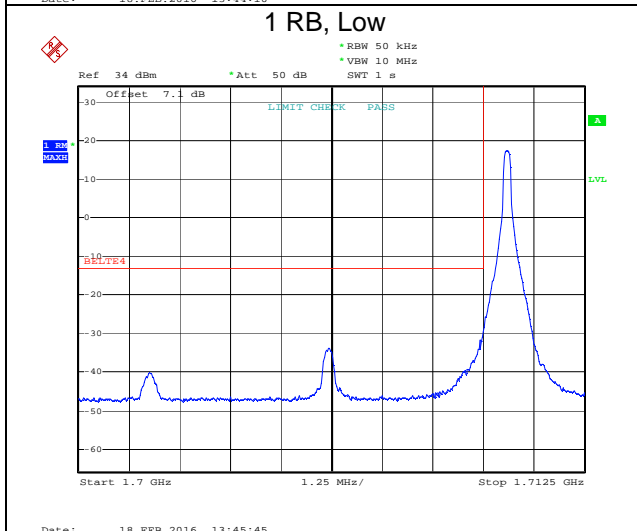
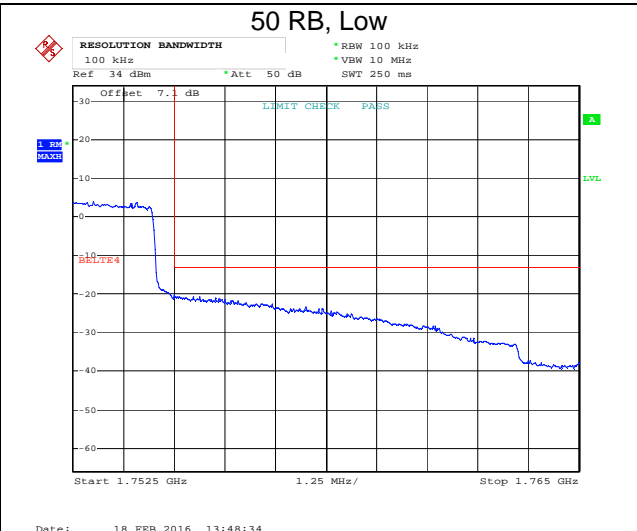
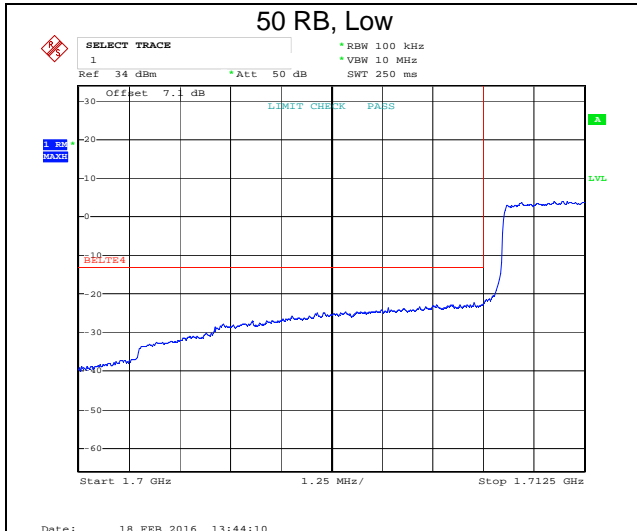
Band 4, 5 MHz BW, 16-QAM

Channel 19975, 1712.5 MHz Below 1710 MHz	Channel 20375, 1752.5 MHz Above 1755 MHz
---	---



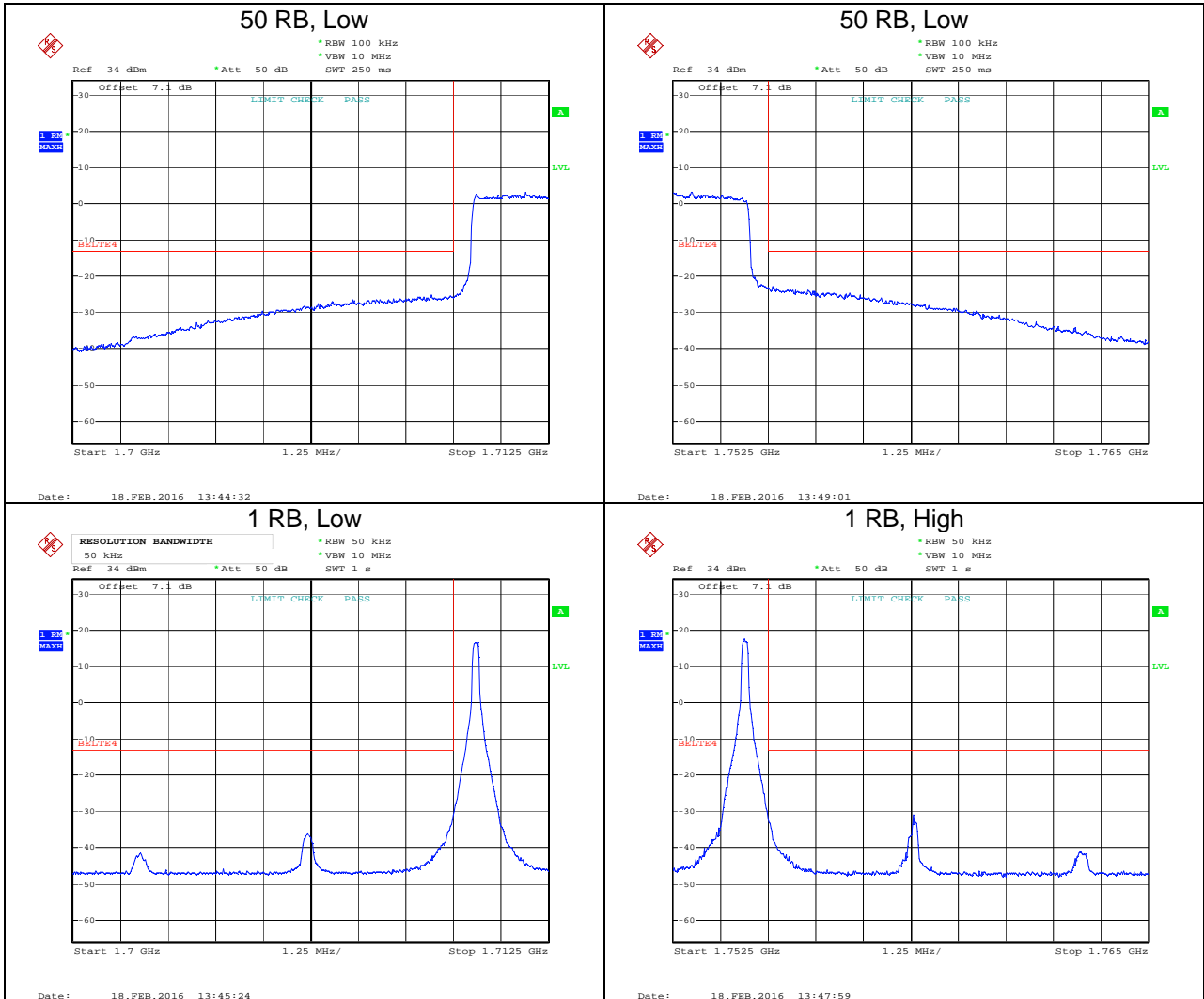
Band 4, 10 MHz BW, QPSK

Channel 20000, 1715.0 MHz Below 1710 MHz	Channel 20350, 1750.0 MHz Above 1755 MHz
---	---



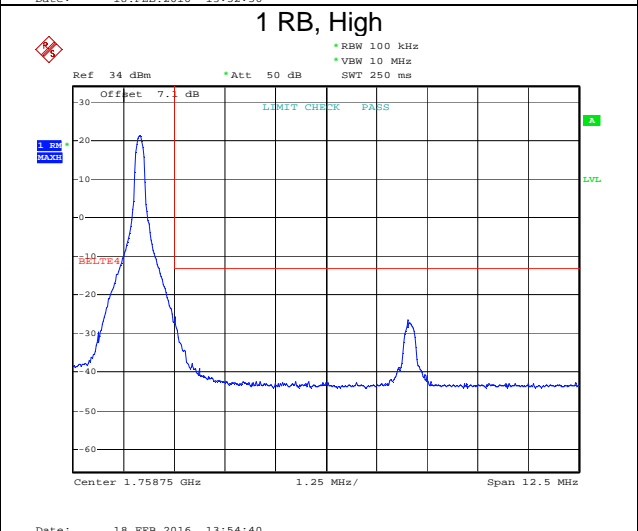
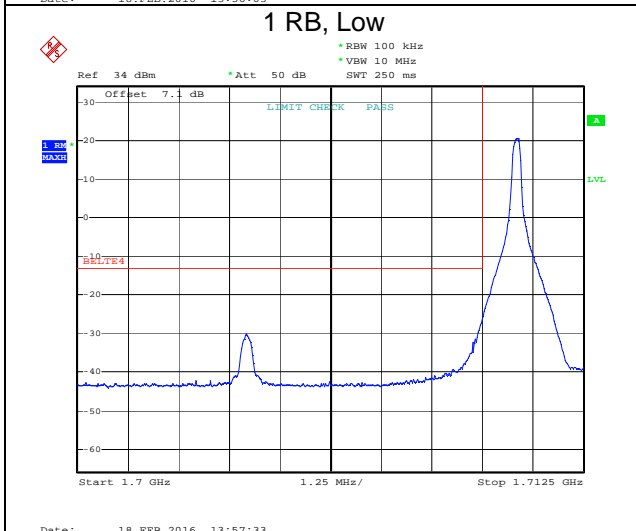
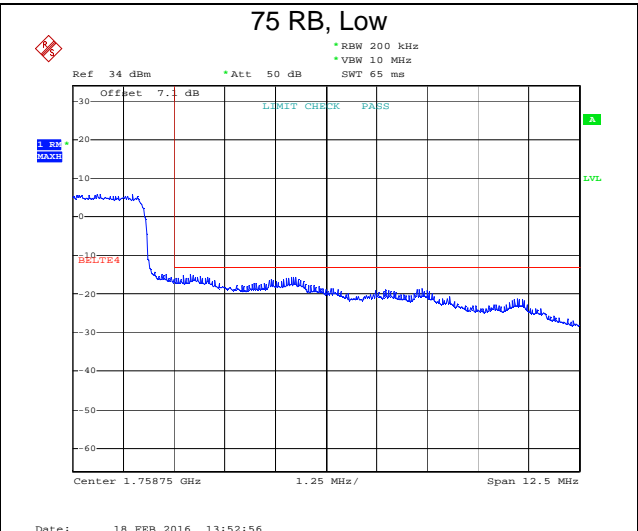
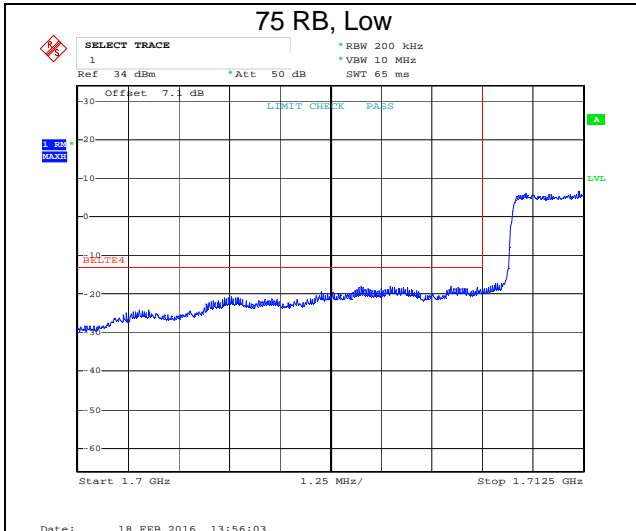
Band 4, 10 MHz BW, 16-QAM

Channel 20000, 1715.0 MHz Below 1710 MHz	Channel 20350, 1750.0 MHz Above 1755 MHz
---	---



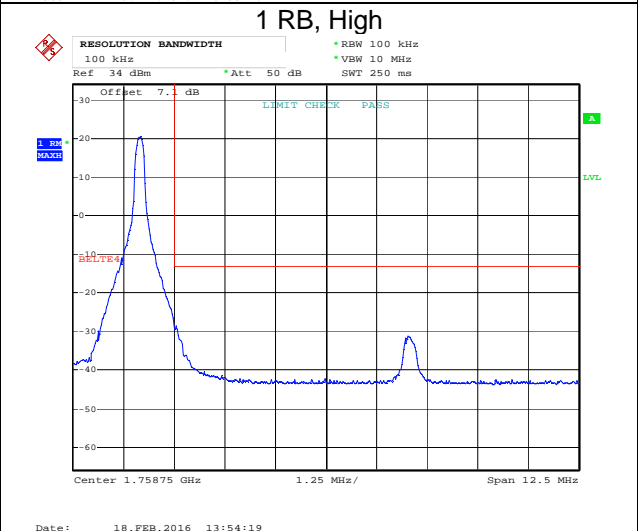
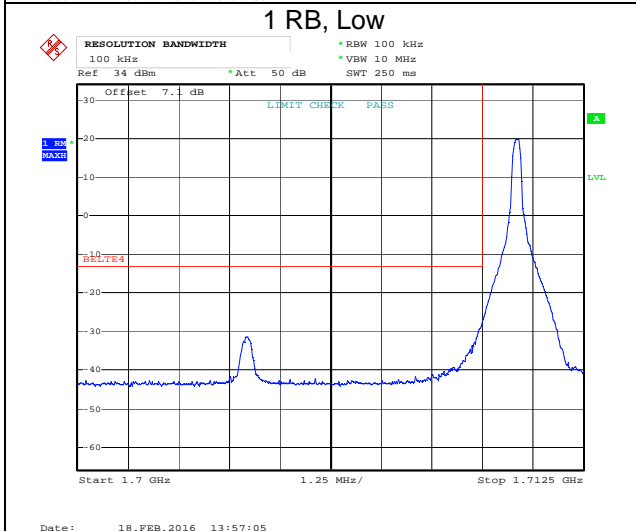
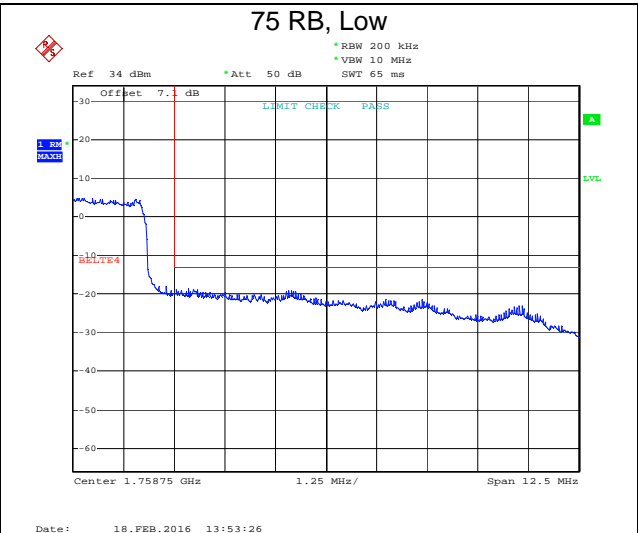
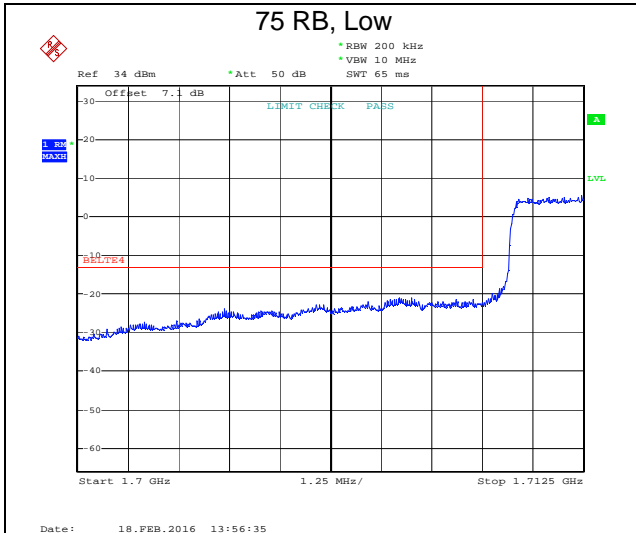
Band 4, 15 MHz BW, QPSK

Channel 20025, 1717.5 MHz Below 1710 MHz	Channel 20325, 1747.5 MHz Above 1755 MHz
---	---



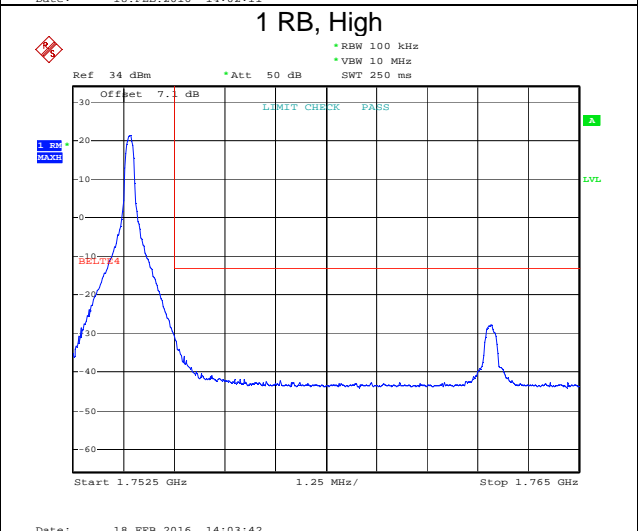
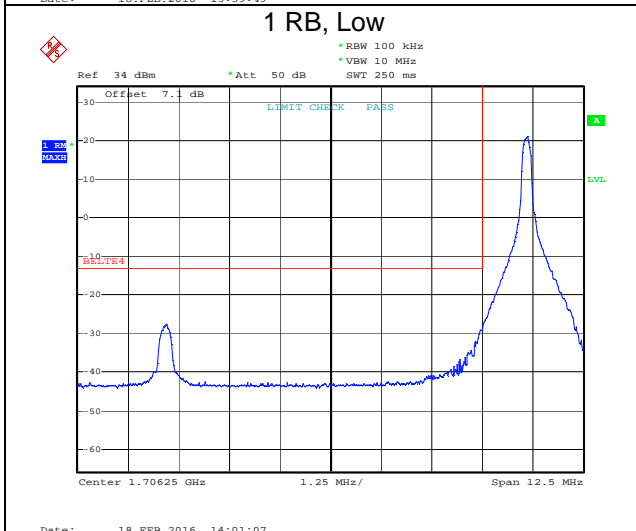
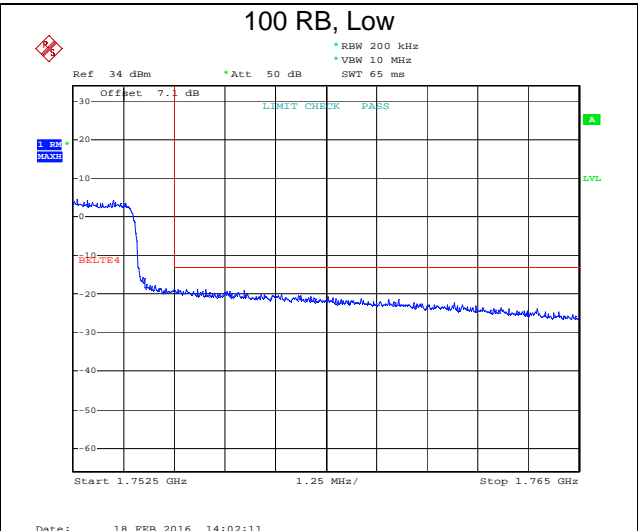
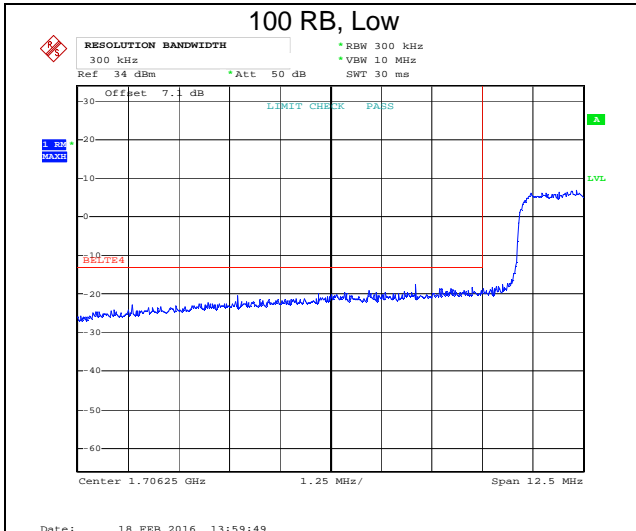
Band 4, 15 MHz BW, 16-QAM

Channel 20025, 1717.5 MHz Below 1710 MHz	Channel 20325, 1747.5 MHz Above 1755 MHz
---	---



Band 4, 20 MHz BW, QPSK

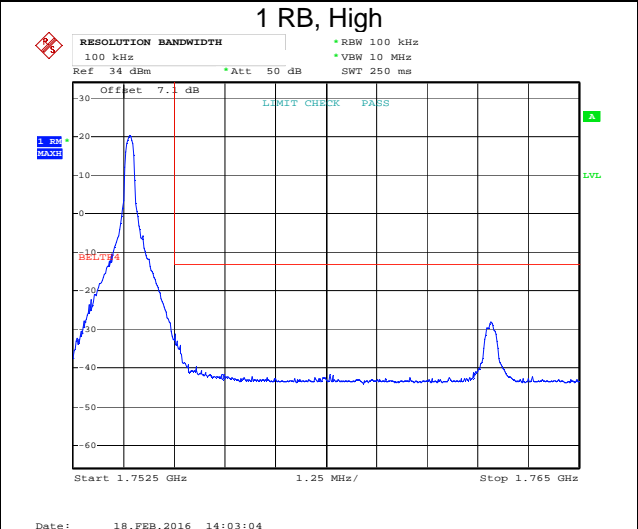
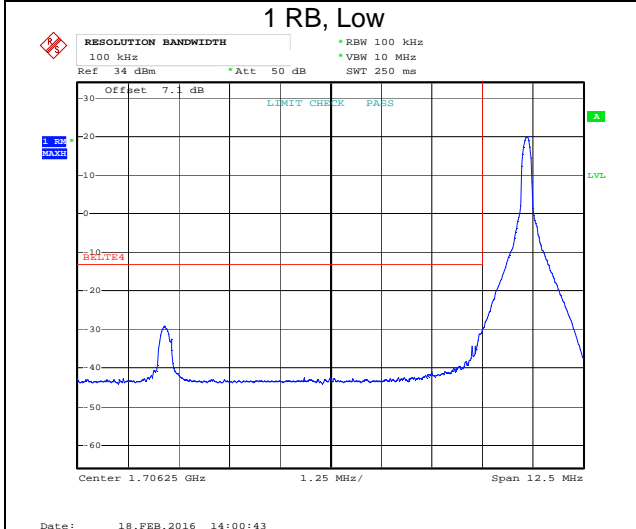
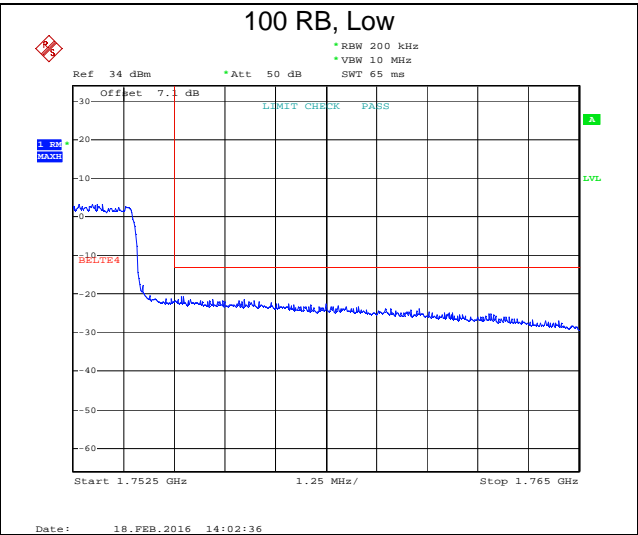
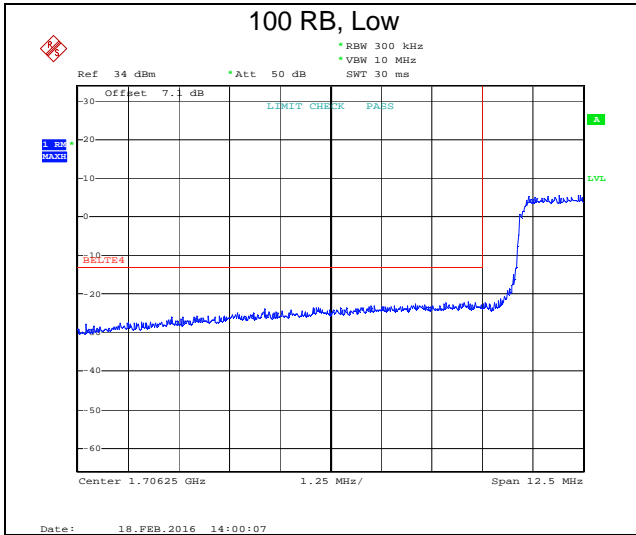
Channel 20050, 1720.0 MHz Below 1710 MHz	Channel 20300, 1745.0 MHz Above 1755 MHz
---	---





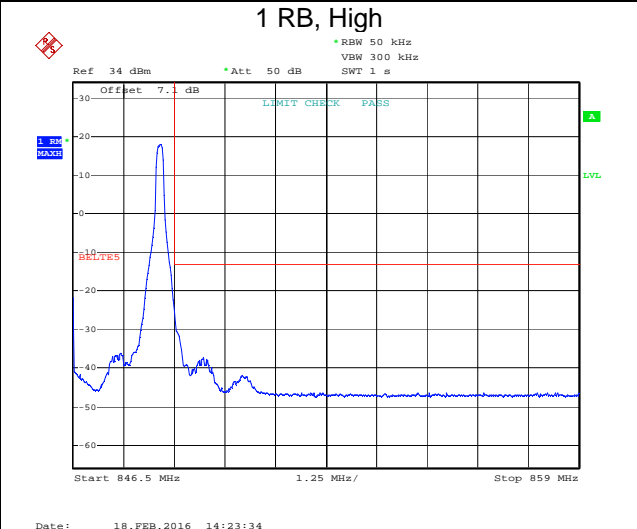
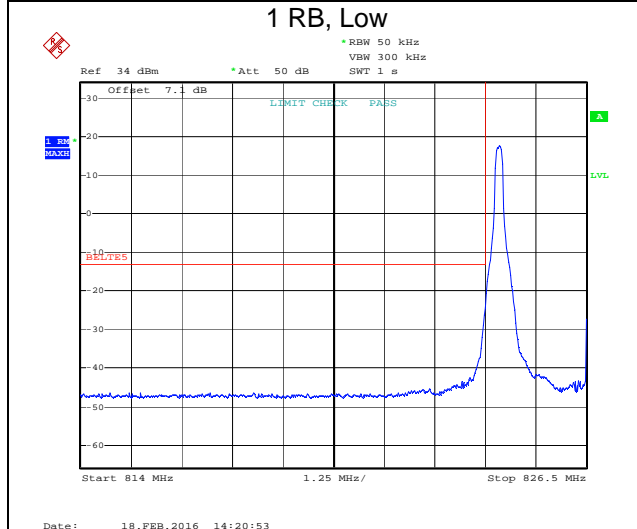
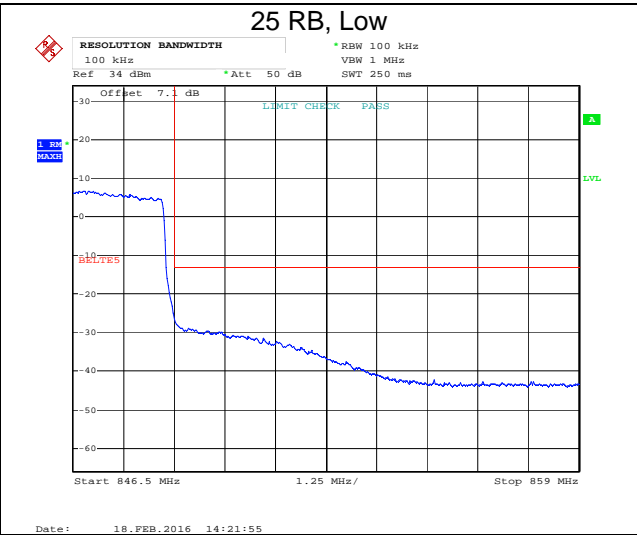
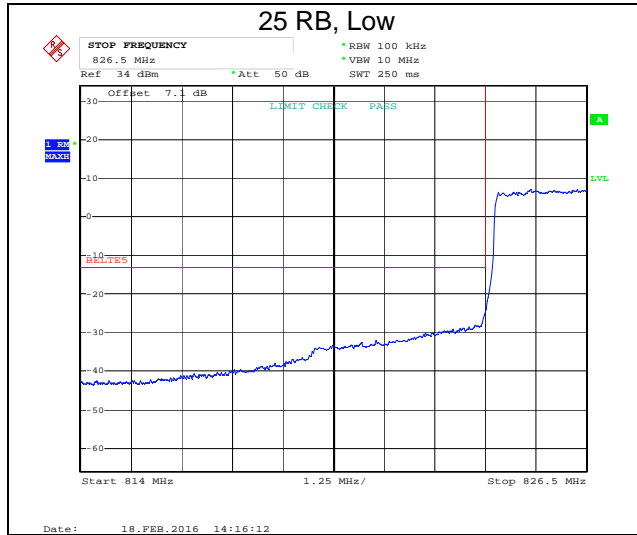
Band 4, 20 MHz BW, 16-QAM

Channel 20050, 1720.0 MHz Below 1710 MHz	Channel 20300, 1745.0 MHz Above 1755 MHz
---	---



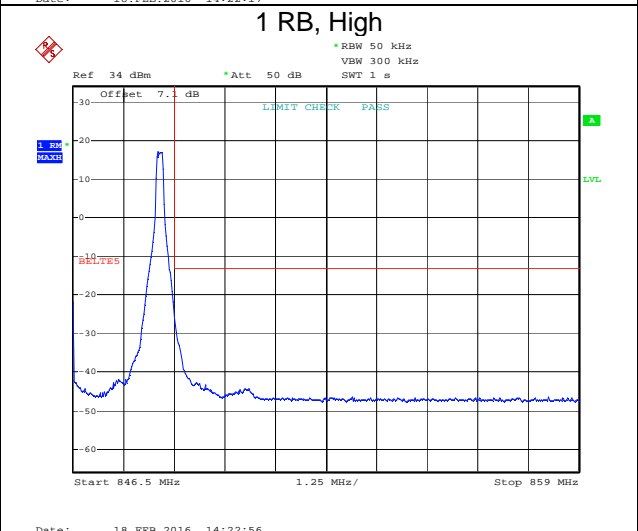
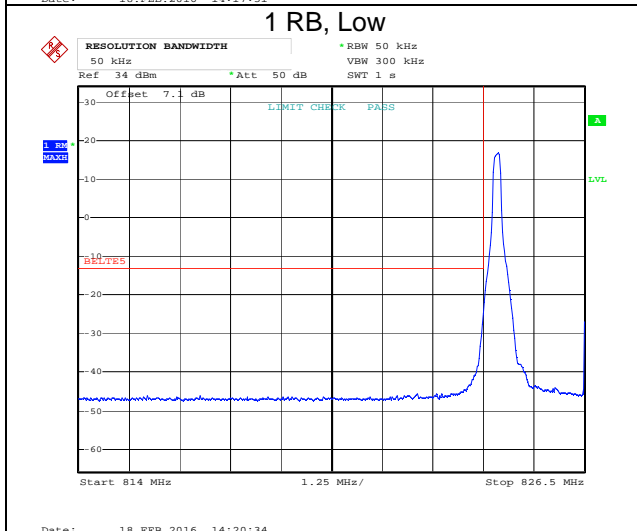
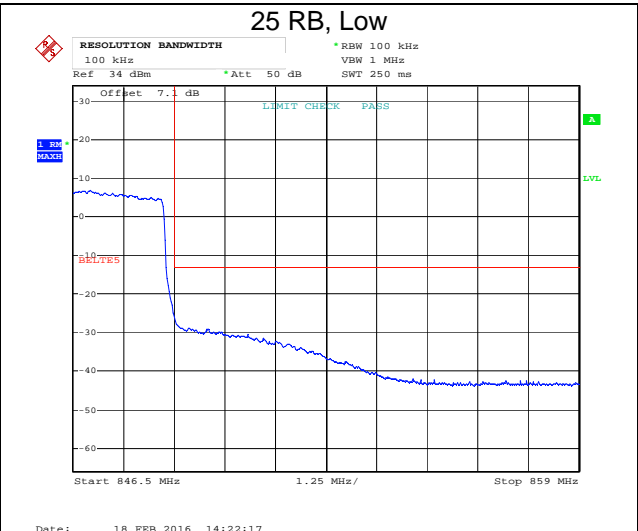
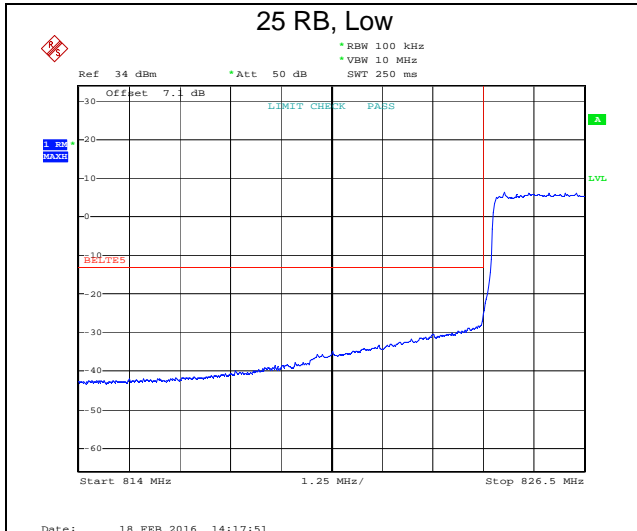
Band 5, 5 MHz BW, QPSK

Channel 20425, 826.5 MHz Below 824 MHz	Channel 20625, 846.5 MHz Above 849 MHz
---	---



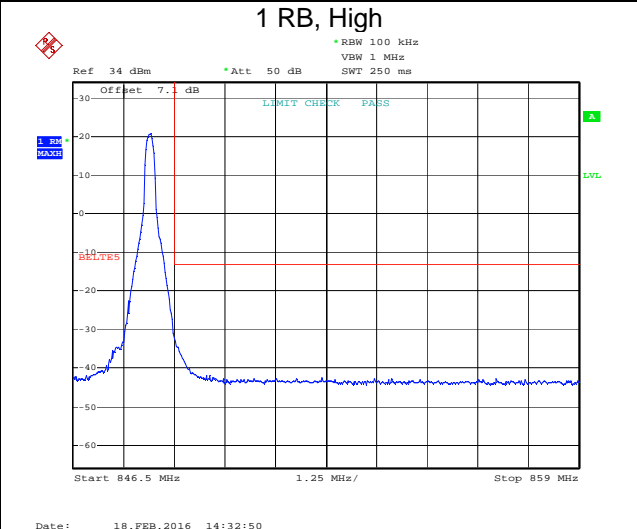
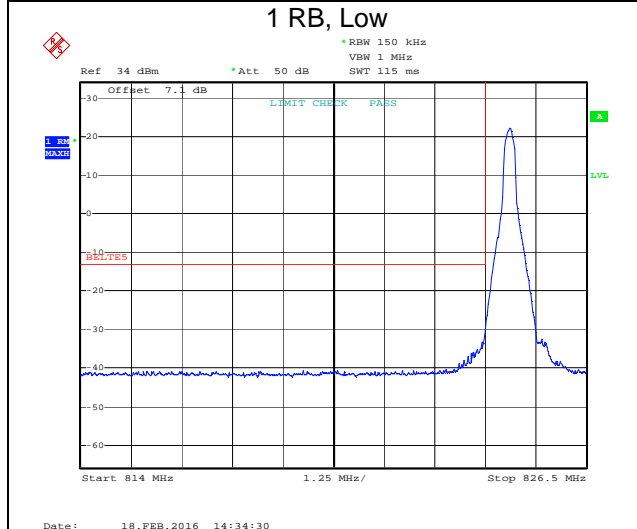
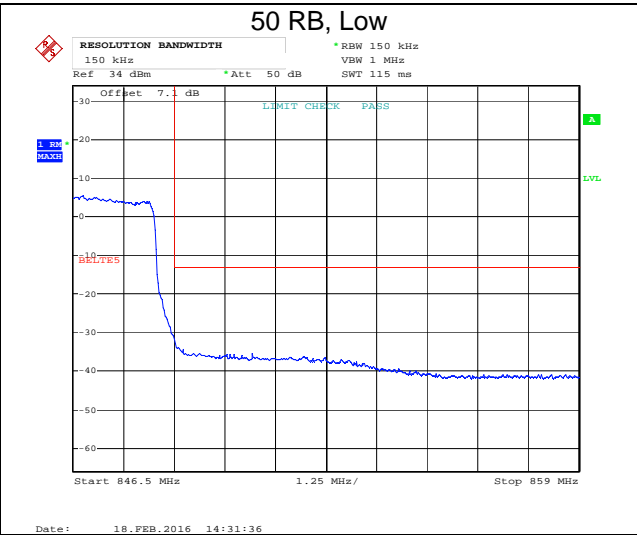
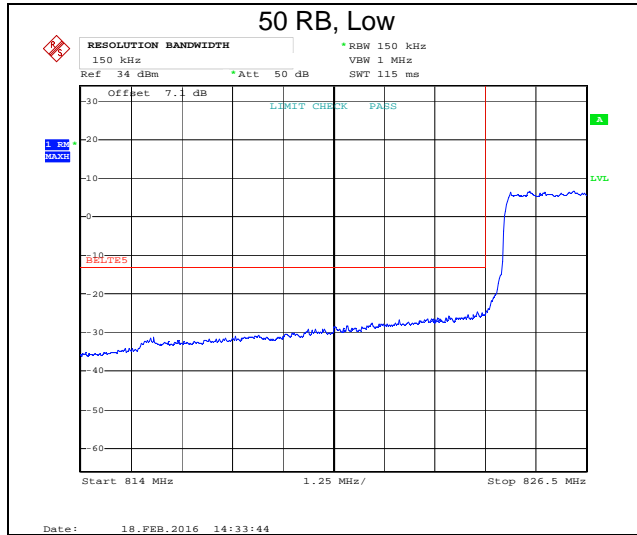
Band 5, 5 MHz BW, 16-QAM

Channel 20425, 826.5 MHz Below 824 MHz	Channel 20625, 846.5 MHz Above 849 MHz
---	---



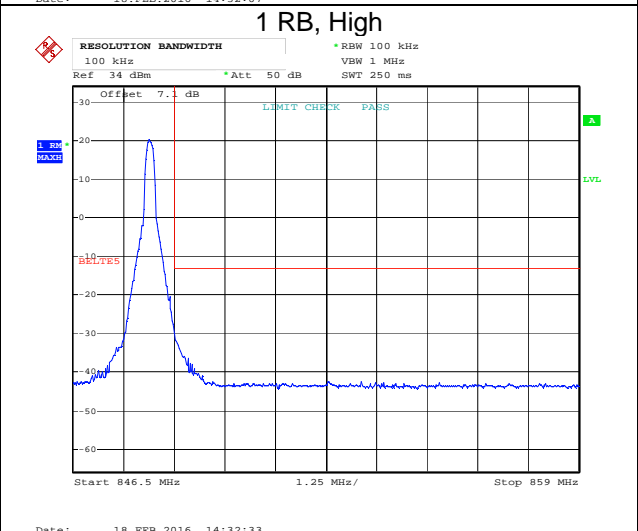
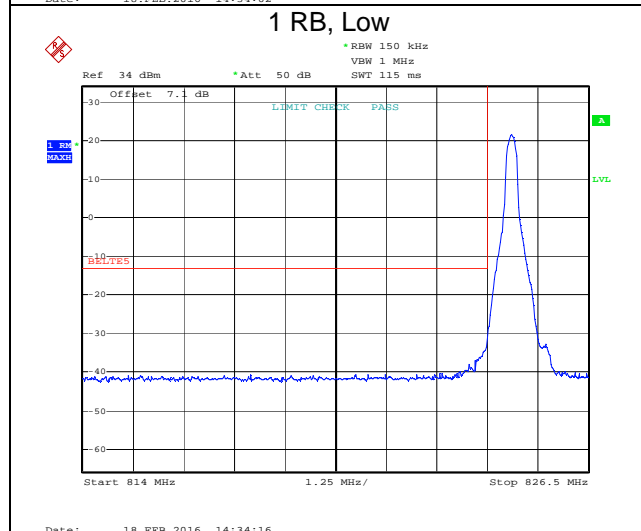
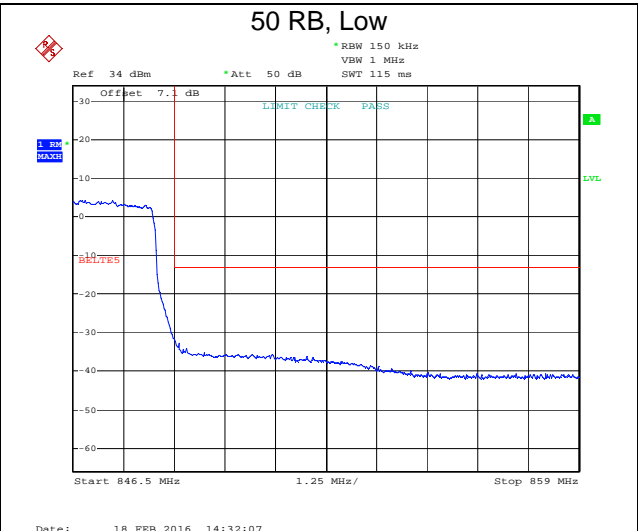
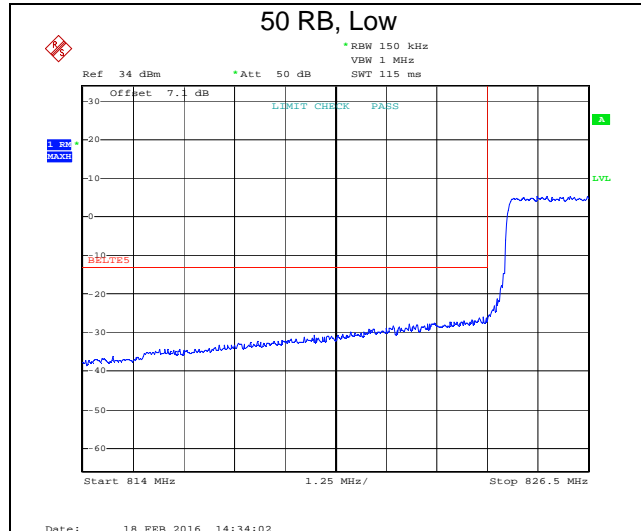
Band 5, 10 MHz BW, QPSK

Channel 20450, 829.0 MHz Below 824 MHz	Channel 20600, 844.0 MHz Above 849 MHz
---	---



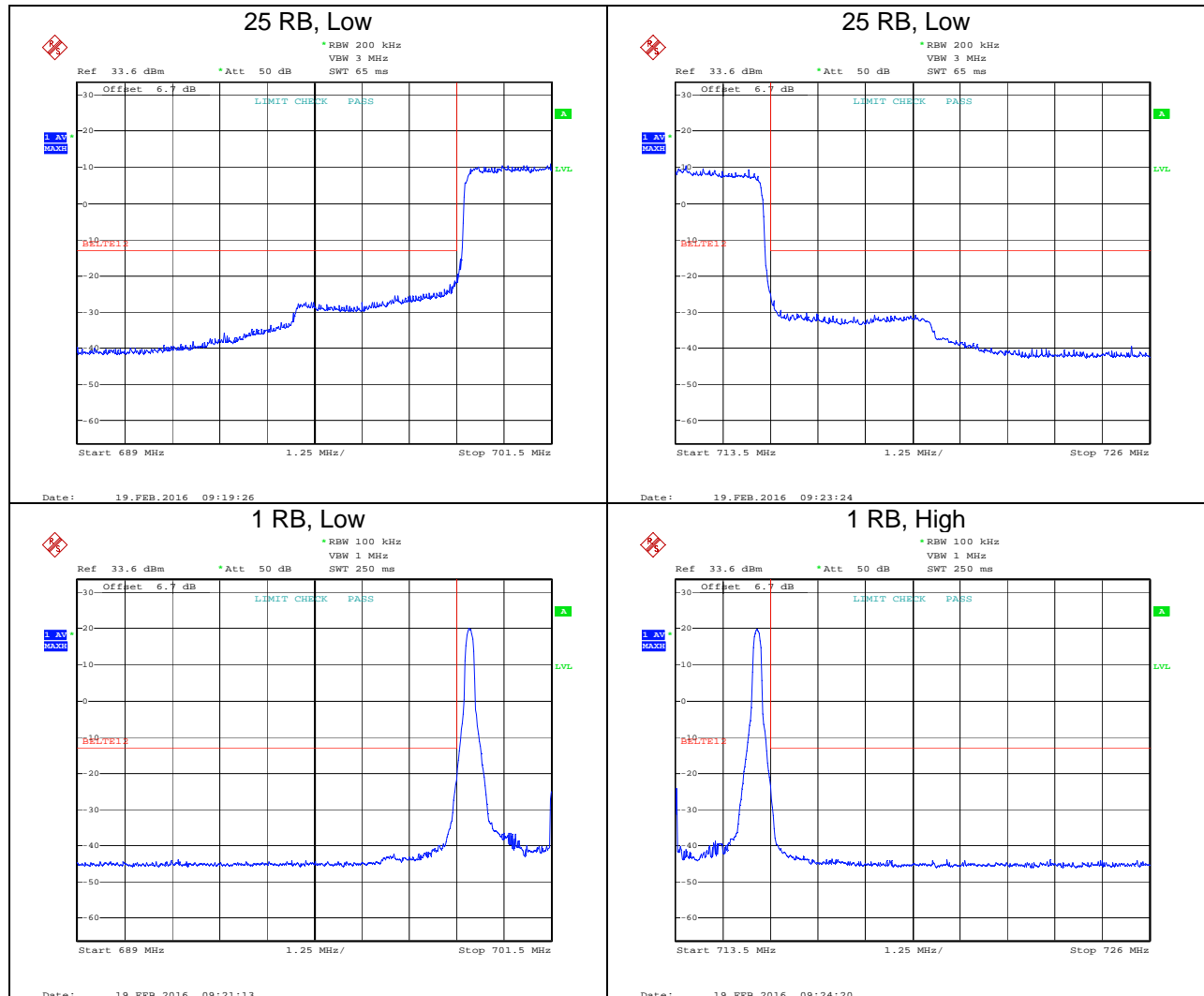
Band 5, 10 MHz BW, 16-QAM

Channel 20450, 829.0 MHz Below 824 MHz	Channel 20600, 844.0 MHz Above 849 MHz
---	---



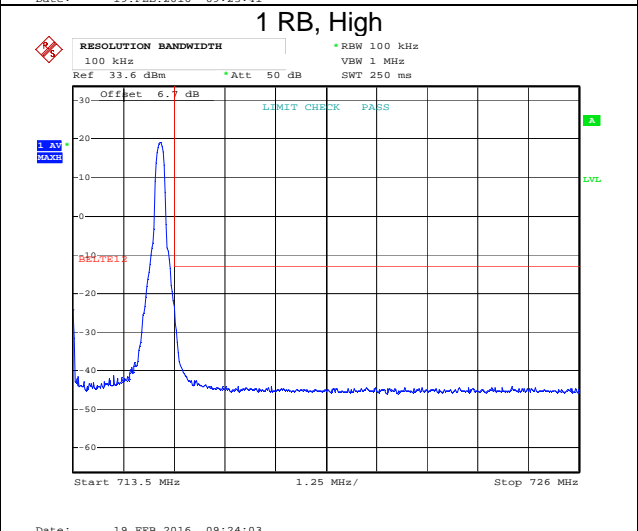
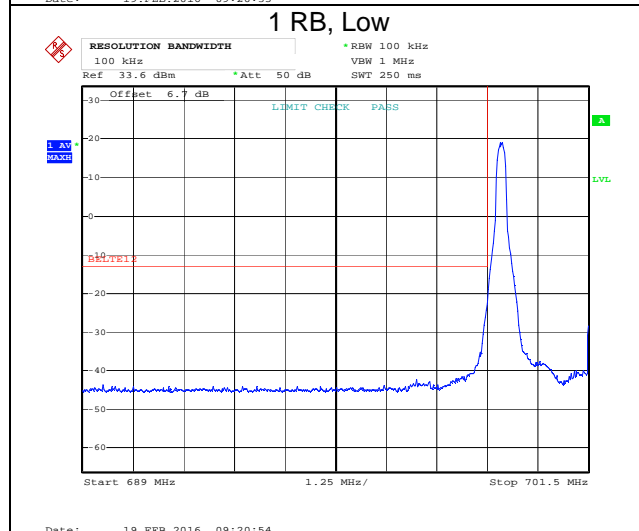
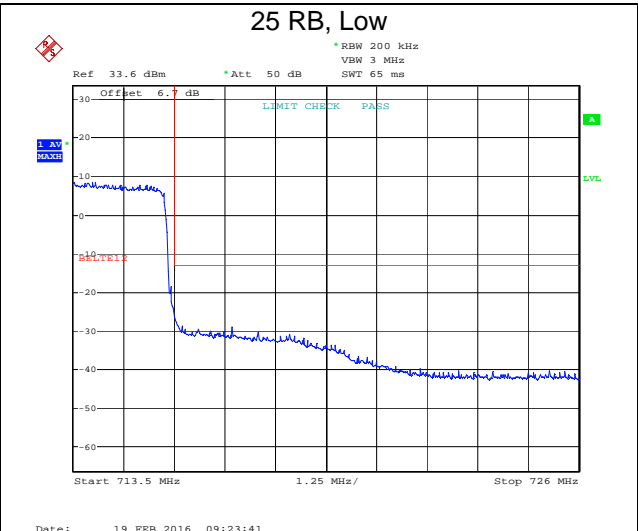
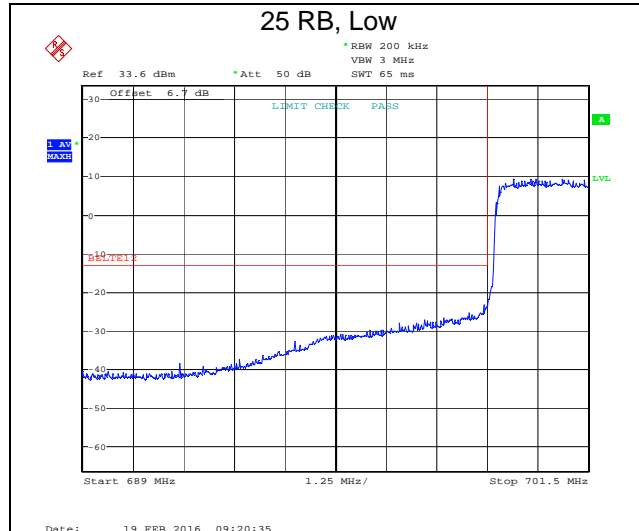
Band 12, 5 MHz BW, QPSK

Channel 23025, 701.5 MHz Below 698 MHz	Channel 23155, 713.5 MHz Above 716 MHz
---	---



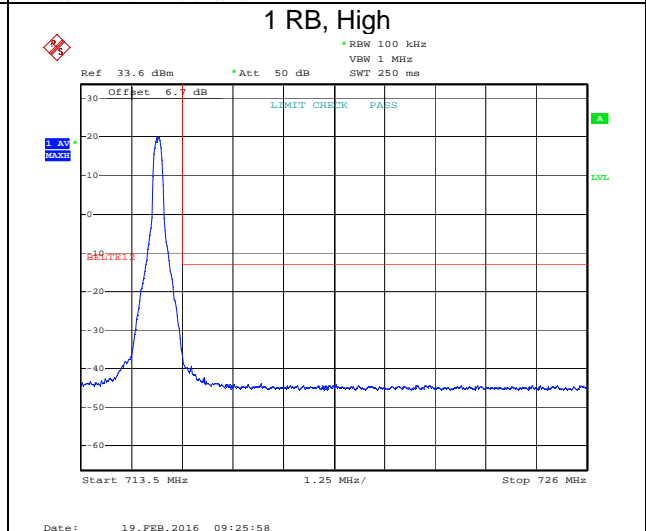
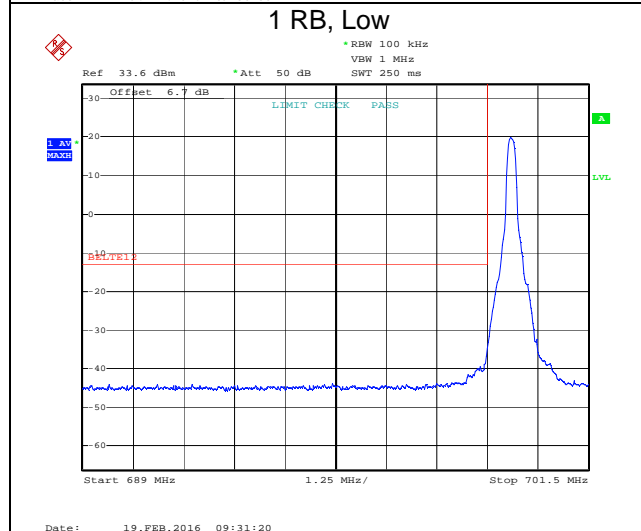
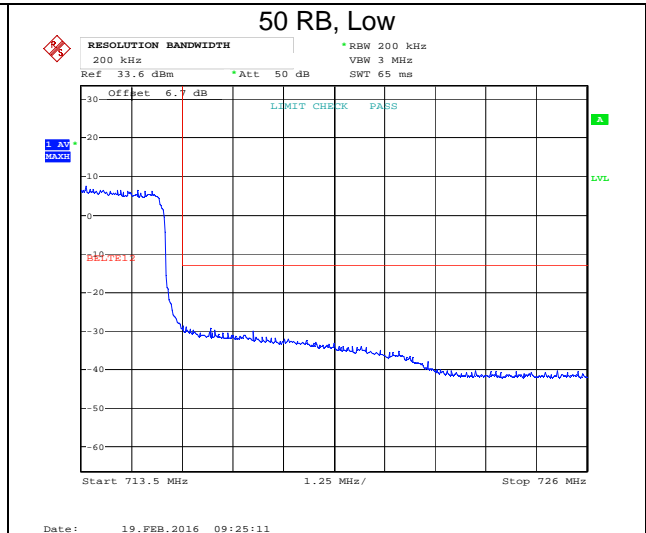
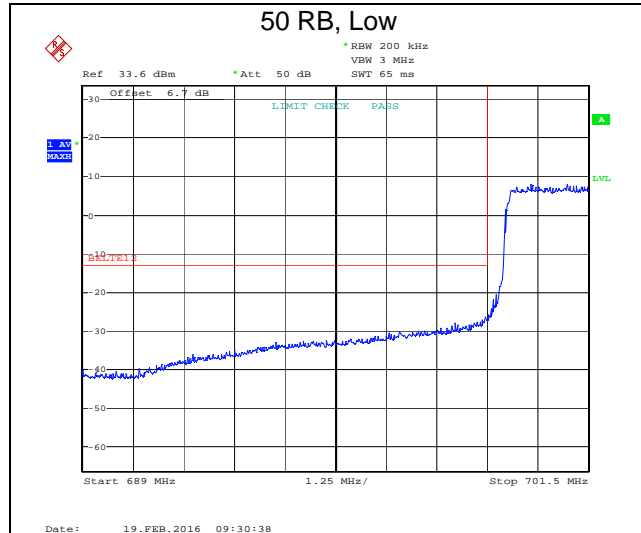
Band 12, 5 MHz BW, 16-QAM

Channel 23025, 700.5 MHz Below 698 MHz	Channel 23155, 713.5 MHz Above 716 MHz
---	---



Band 12, 10 MHz BW, QPSK

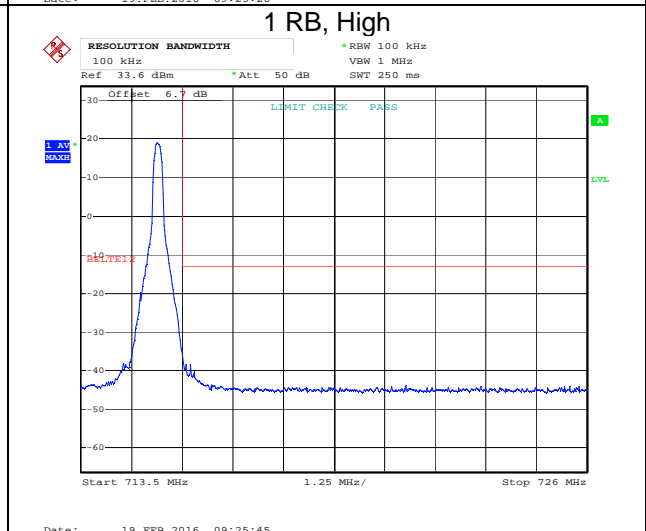
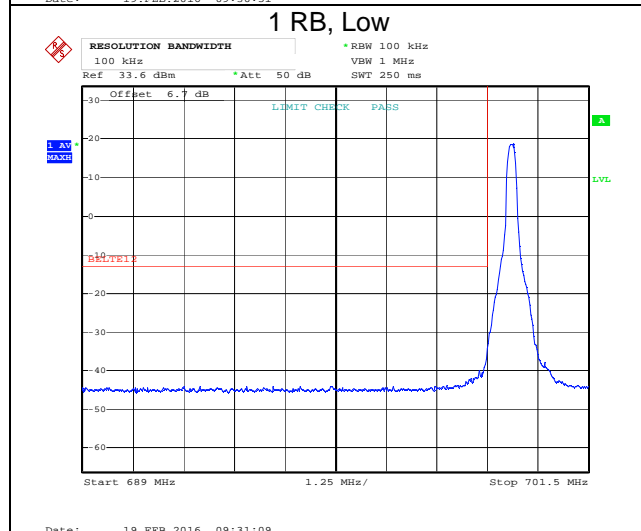
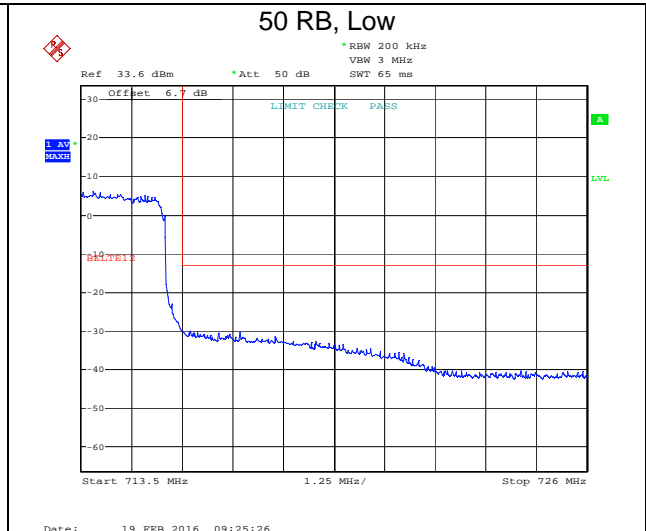
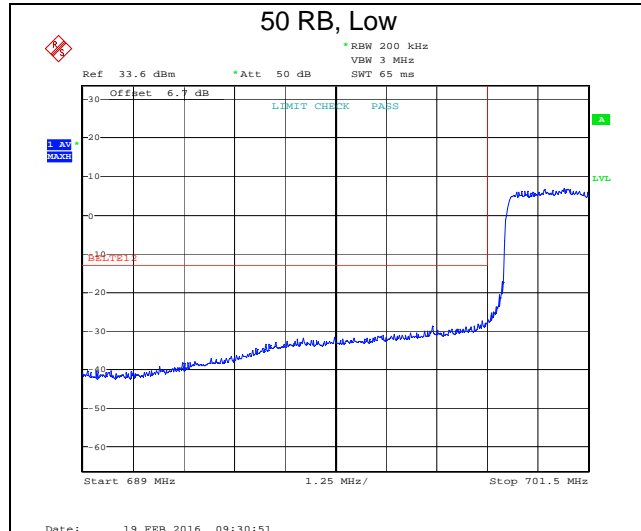
Channel 23050, 703.0 MHz Below 698 MHz	Channel 23130, 711.0 MHz Above 716 MHz
---	---





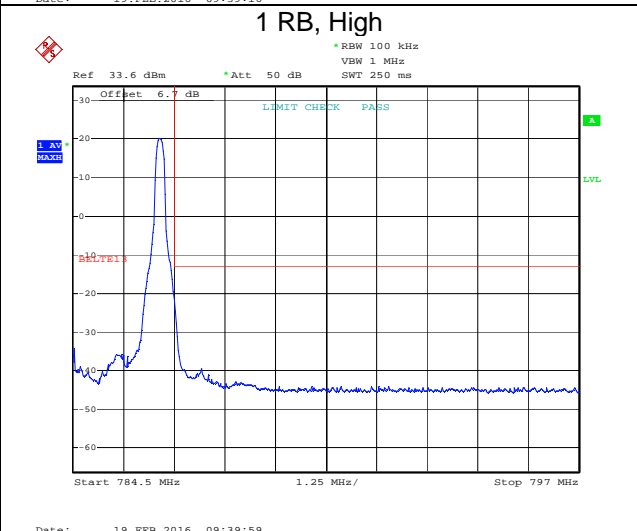
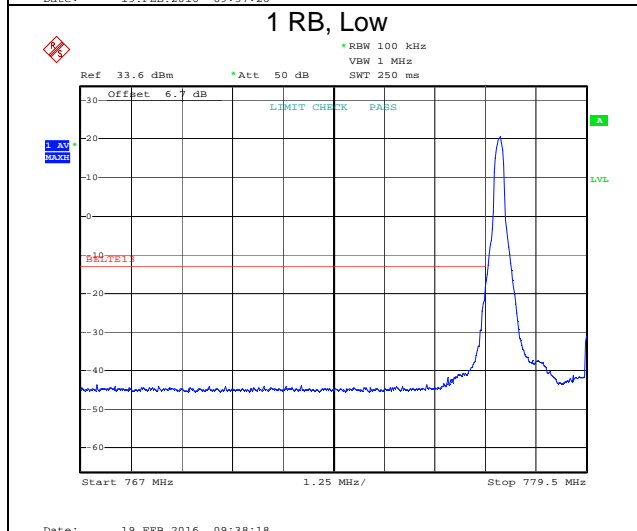
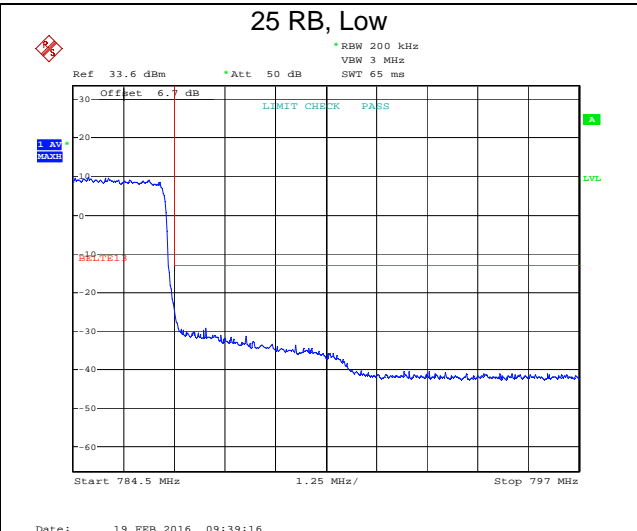
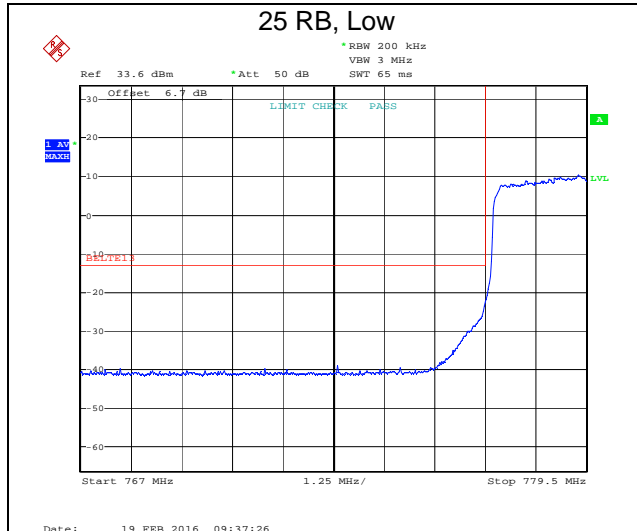
Band 12, 10 MHz BW, 16-QAM

Channel 23050, 703.0 MHz Below 698 MHz	Channel 23130, 711.0 MHz Above 716 MHz
---	---



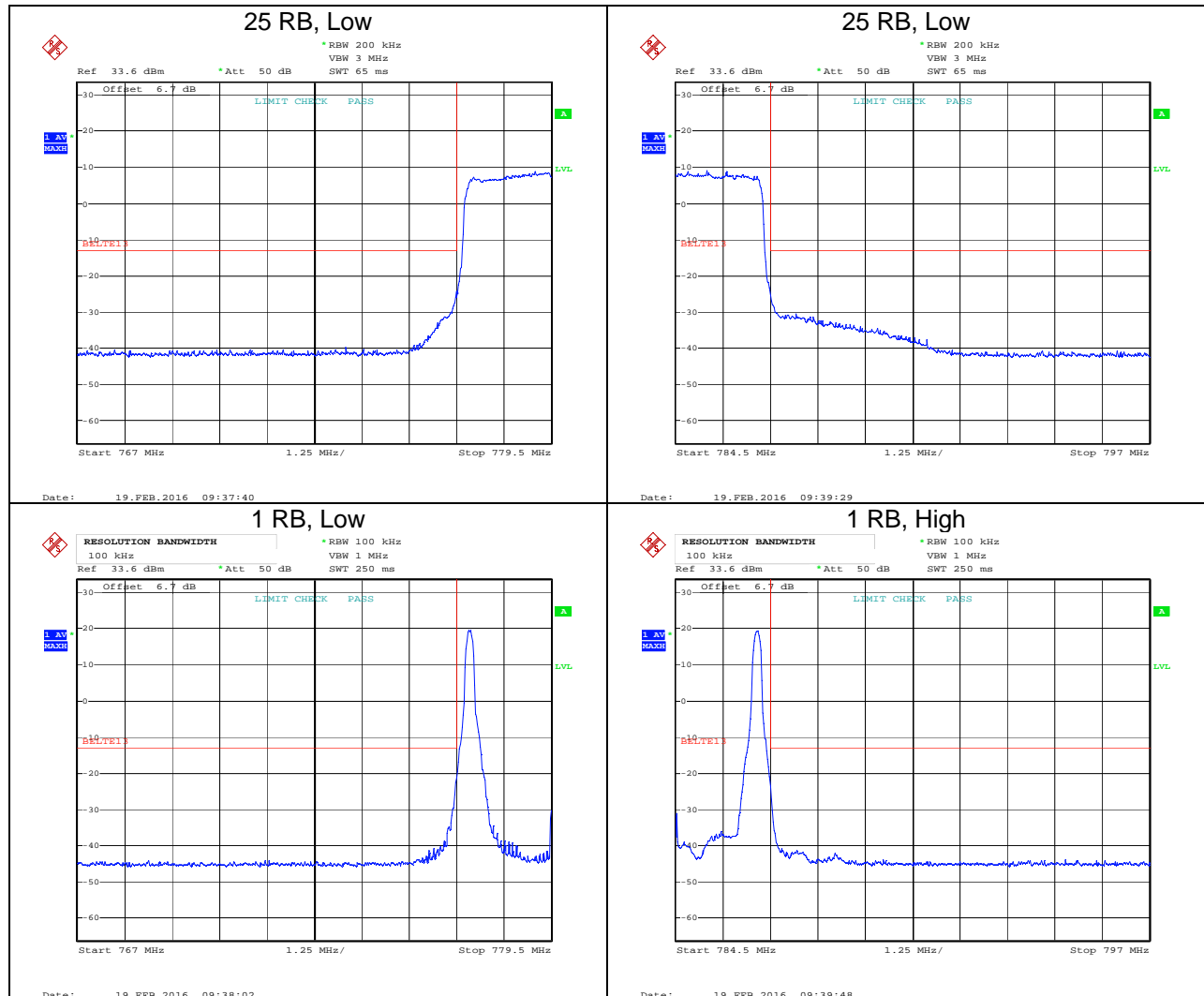
Band 13, 5 MHz BW, QPSK

Channel 23205, 779.5 MHz Below 777 MHz	Channel 23255, 784.5 MHz Above 787 MHz
---	---



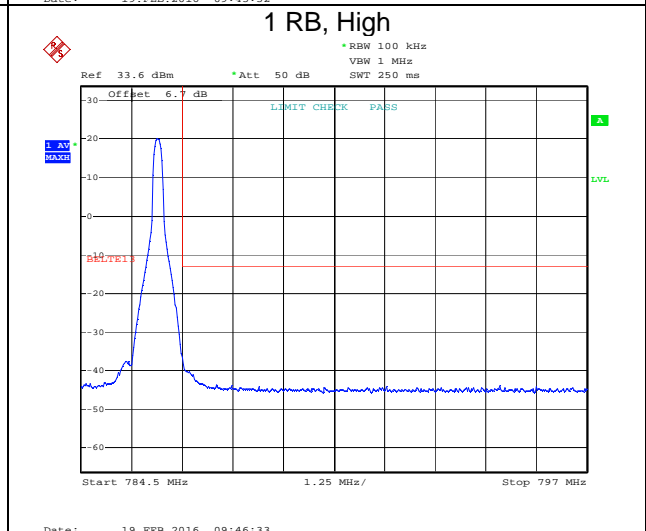
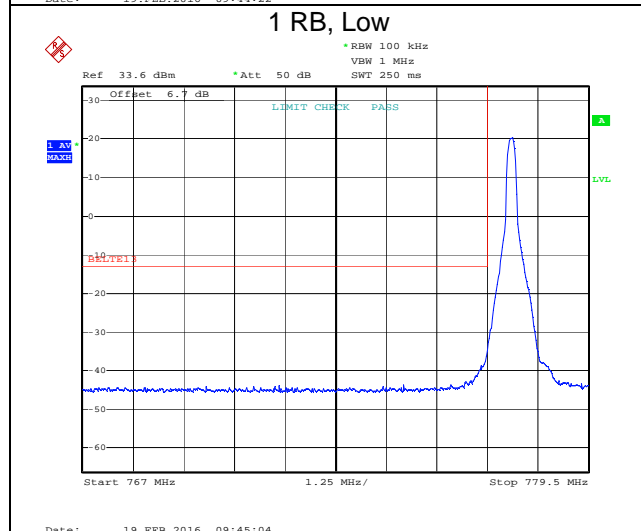
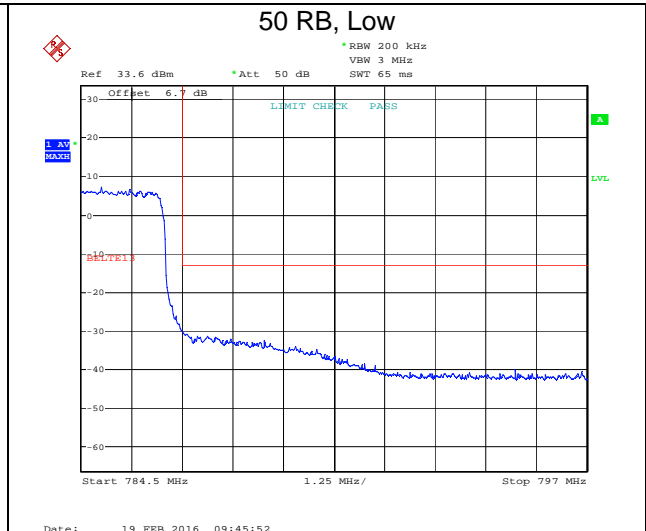
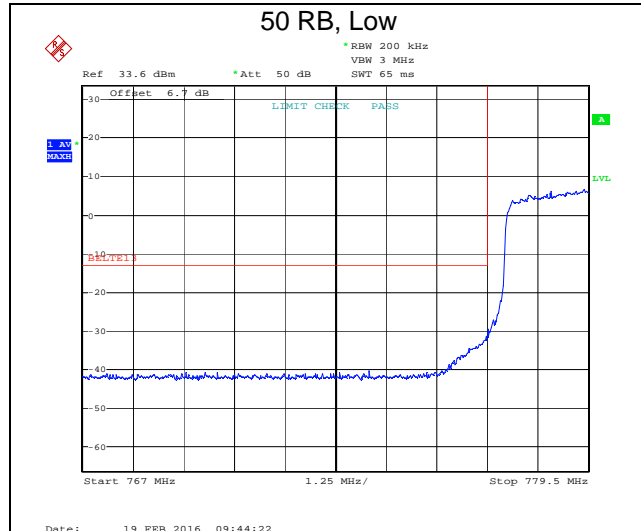
Band 13, 5 MHz BW, 16-QAM

Channel 23205, 779.5 MHz Below 777 MHz	Channel 23255, 784.5 MHz Above 787 MHz
---	---



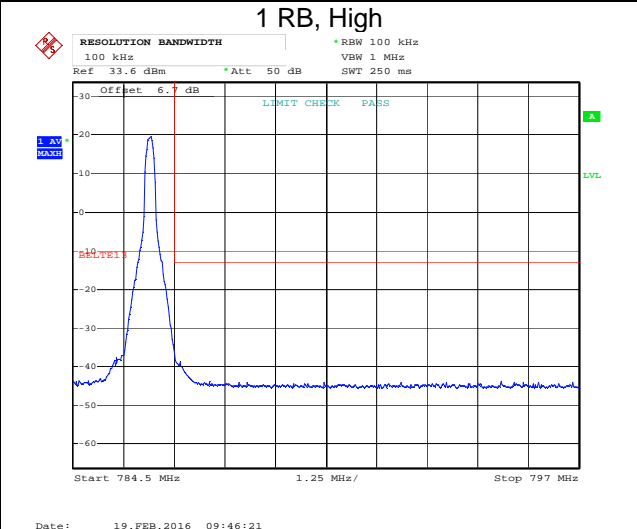
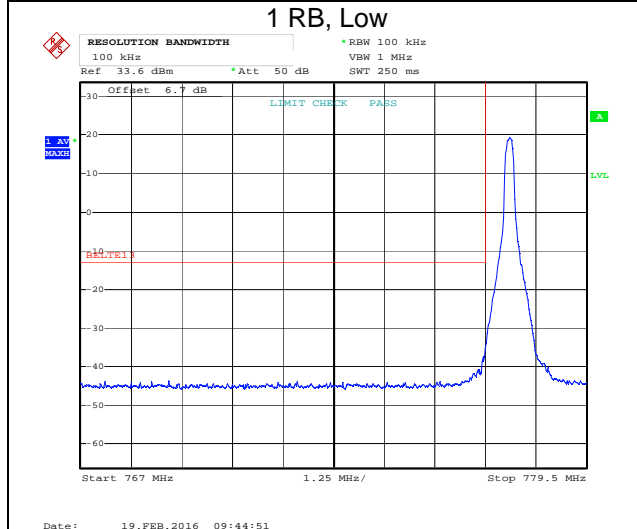
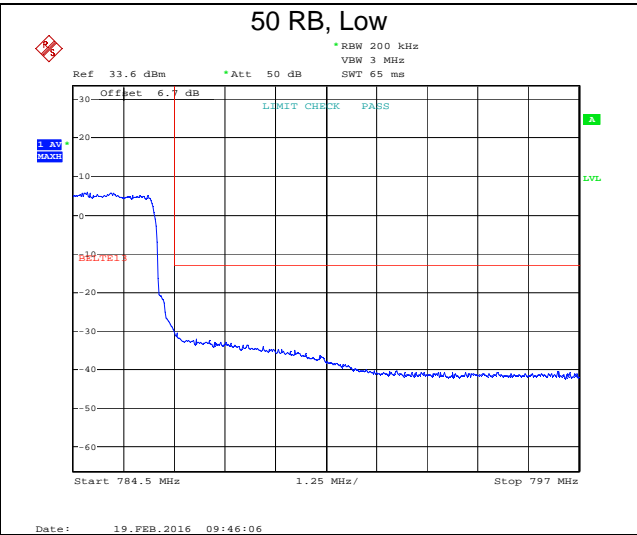
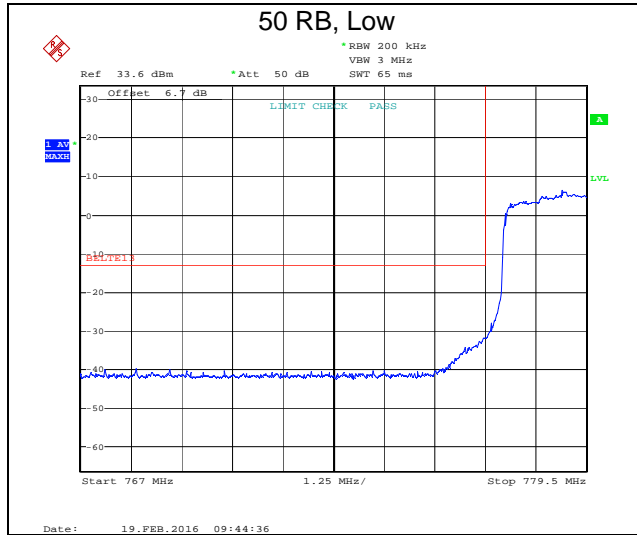
Band 13, 10 MHz BW, QPSK

Channel 23230, 782.0 MHz Below 777 MHz	Channel 23230, 782.0 MHz Above 787 MHz
---	---



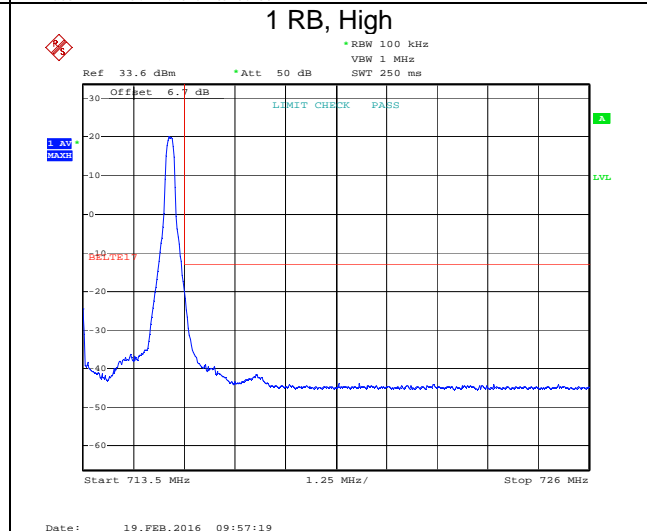
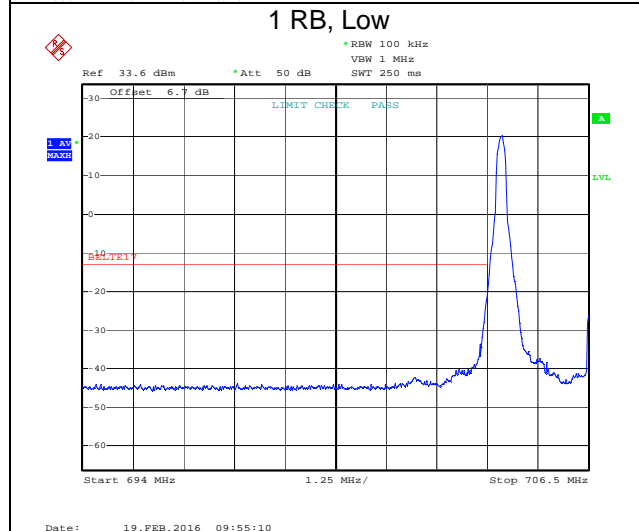
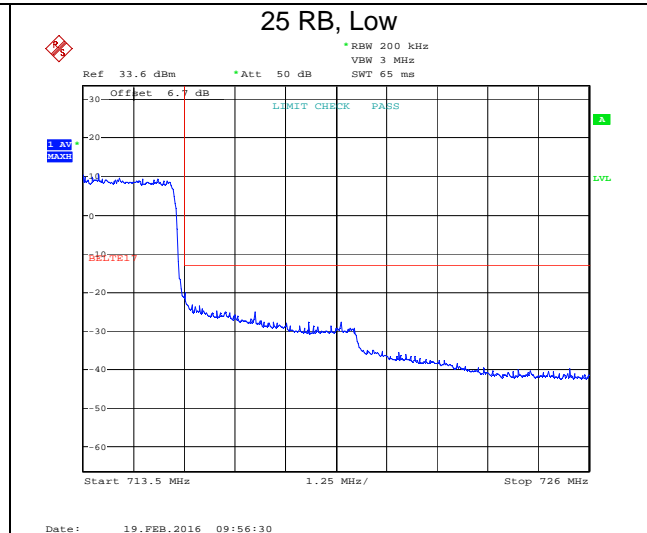
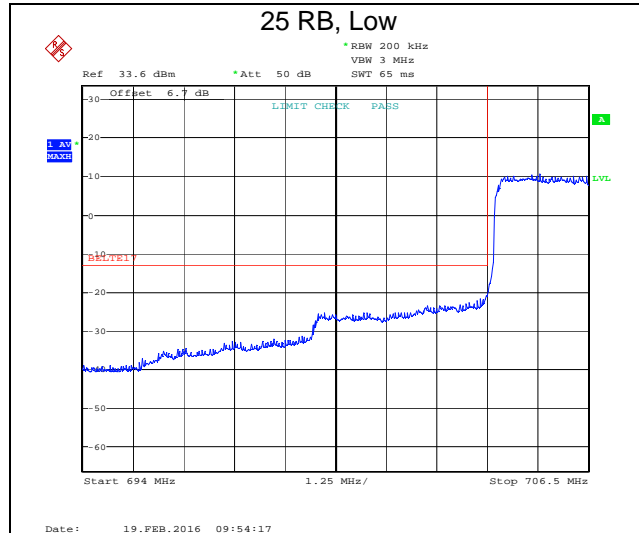
Band 13, 10 MHz BW, 16-QAM

Channel 23230, 782.0 MHz Below 777 MHz	Channel 23230, 782.0 MHz Above 787 MHz
---	---



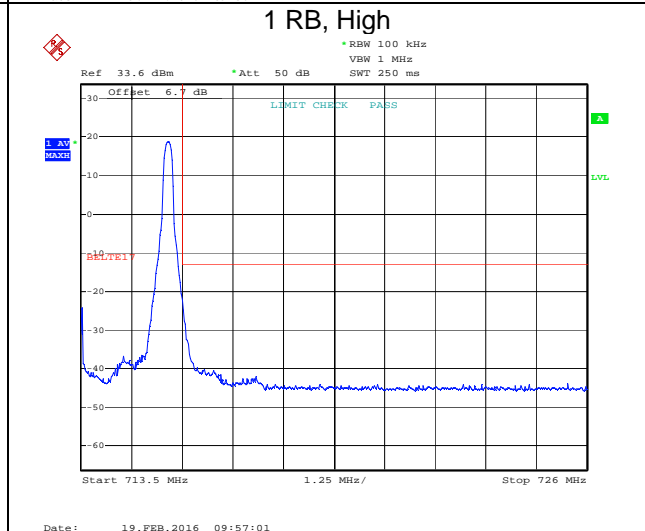
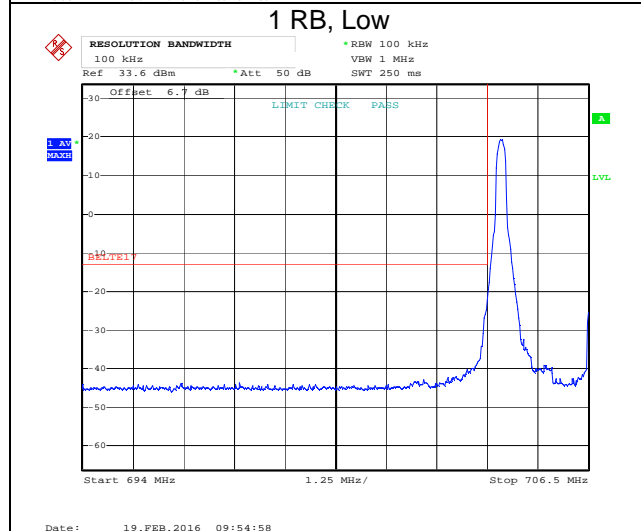
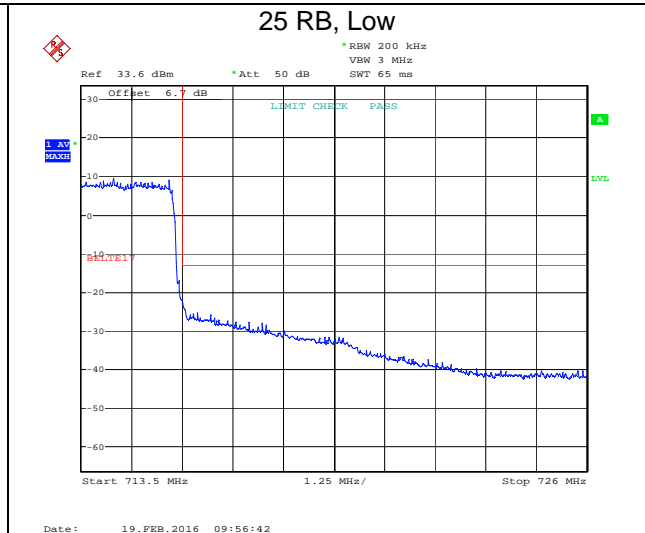
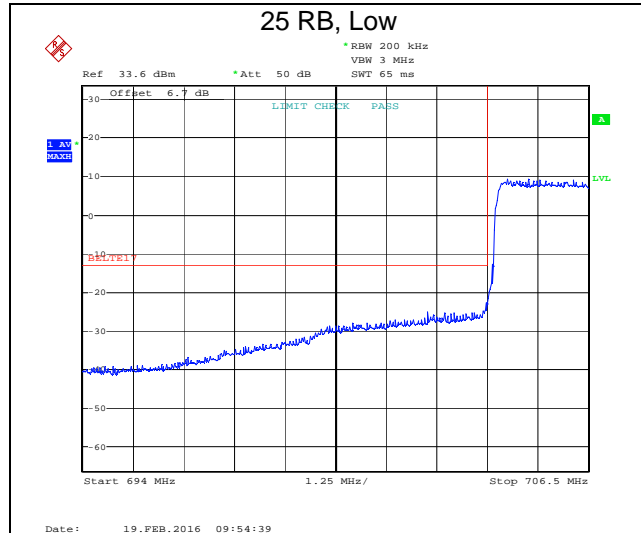
Band 17, 5 MHz BW, QPSK

Channel 23755, 706.5 MHz Below 704 MHz	Channel 23825, 713.5 MHz Above 716 MHz
---	---



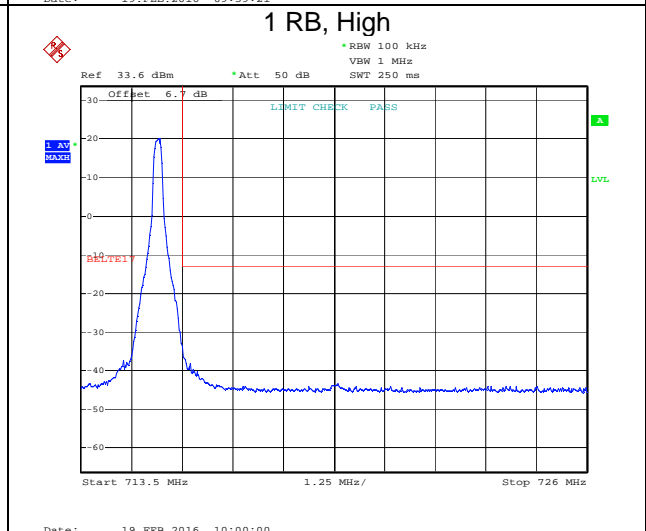
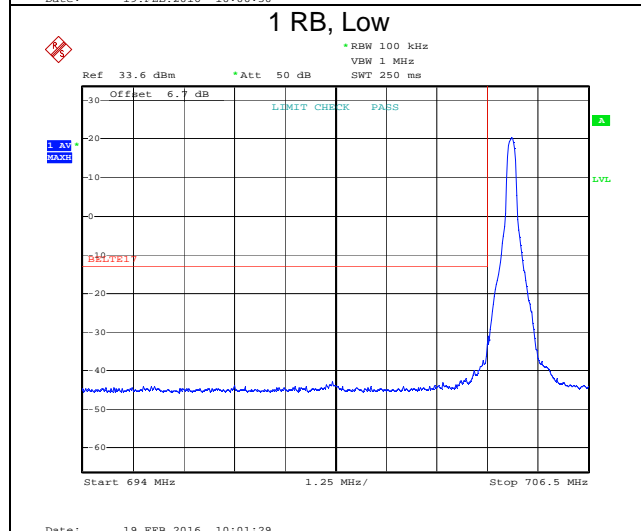
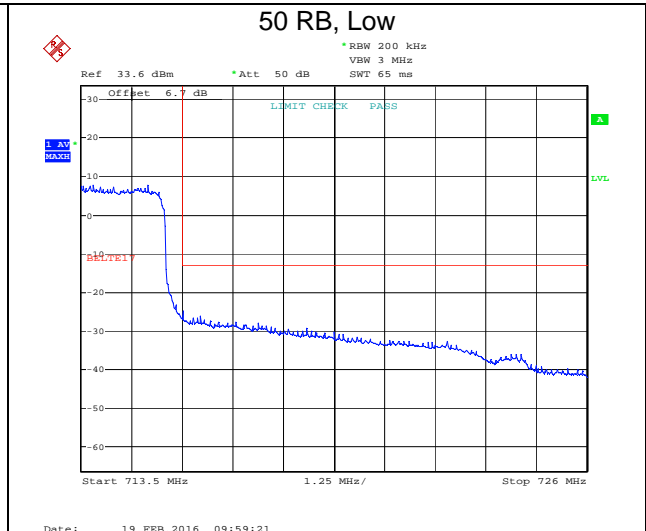
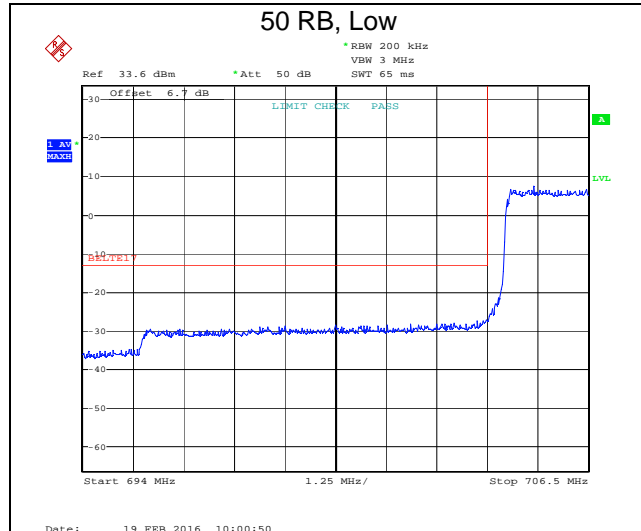
Band 17, 5 MHz BW, 16-QAM

Channel 23755, 706.5 MHz Below 704 MHz	Channel , MHz Above MHz
---	----------------------------



Band 17, 10 MHz BW, QPSK

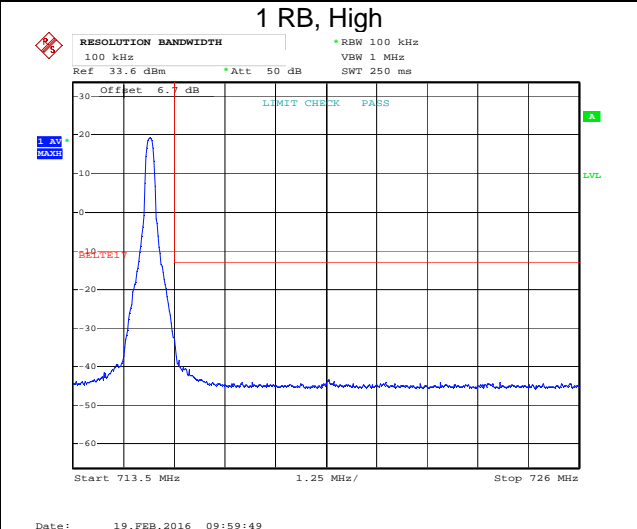
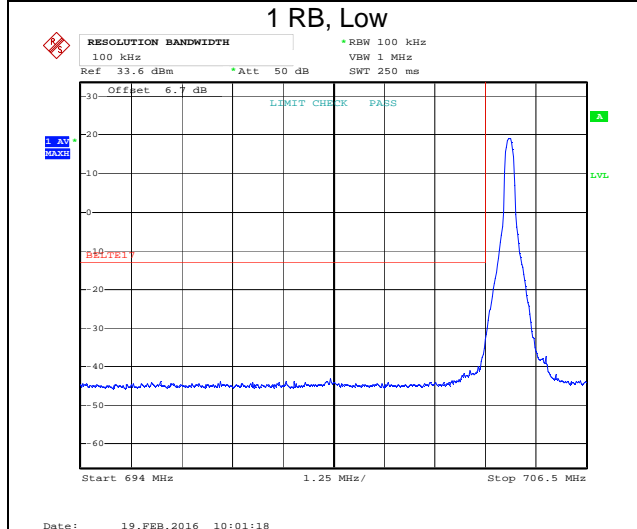
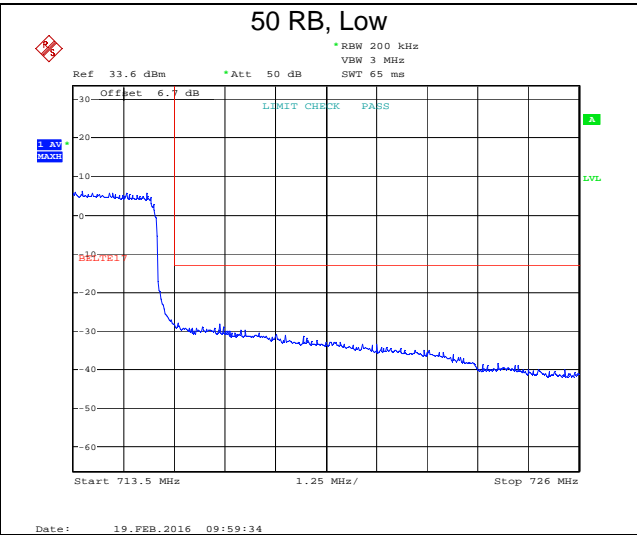
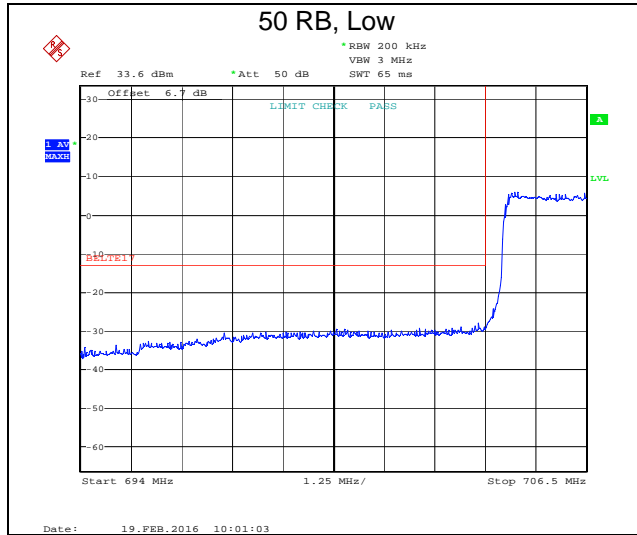
Channel 23780, 709.0 MHz Below 704 MHz	Channel 23800, 711.0 MHz Above 716 MHz
---	---





Band 17, 10 MHz BW, 16-QAM

Channel 23780, 709.0 MHz Below 704 MHz	Channel 23800, 711.0 MHz Above 716 MHz
---	---



## 7 Radiated Output Power

### 7.1 Test Limits

#### § 22.913

- (a) (2) The ERP of mobile transmitters and auxiliary test transmitters must not exceed 7 Watts.

#### § 24.232

- (c) Mobile and portable stations are limited to 2 watts EIRP and the equipment must employ a means for limiting power to the minimum necessary for successful communications.

#### § 27.50

- (b) (10) Portable stations (hand-held devices) transmitting in the 746-757 MHz, 776-788 MHz, and 805-806 MHz bands are limited to 3 watts ERP.
- (c) (10) Portable stations (hand-held devices) in the 600 MHz uplink band and the 698-746 MHz band, and fixed and mobile stations in the 600 MHz uplink band are limited to 3 watts ERP.
- (d) (4) Fixed, mobile, and portable (hand-held) stations operating in the 1710-1755 MHz band and mobile and portable stations operating in the 1695-1710 MHz and 1755-1780 MHz bands are limited to 1 watt EIRP. Fixed stations operating in the 1710-1755 MHz band are limited to a maximum antenna height of 10 meters above ground. Mobile and portable stations operating in these bands must employ a means for limiting power to the minimum necessary for successful communications.

### 7.2 Test Procedure

The radiated output power was determined by adding the peak antenna gain to the highest measured conducted output power to determine the maximum radiated power. The peak antenna gain was calculated by taking into account the ERP / EIRP limits as well as the Maximum Permissible Exposure (MPE) limits at 20cm.

$$ERP = ConductedOutputPower(dBm) + AntennaGain(dBi) - 2.15$$

$$EIRP = ConductedOutputPower(dBm) + AntennaGain(dBi)$$

**7.3 Results:**

The IQ Panel meets the radiated power requirements of FCC §22.91, §24.232, and §27.50. The ERP / EIRP results are shown as well as the MPE calculations used to determine the maximum allowable gain for each frequency band.

**ERP / EIRP Results (QPSK)**

Band	Conducted Power (dBm)	Max Antenna Gain (dBi)	EIRP (dBm)	ERP(dBm)
Band 2	<b>23.78</b>	<b>3.70</b>	<b>27.48</b>	<b>25.33</b>
Band 4	<b>26.31</b>	<b>3.70</b>	<b>30.01</b>	<b>27.86</b>
Band 5	<b>27.55</b>	<b>3.70</b>	<b>31.25</b>	<b>29.10</b>
Band 12	<b>26.96</b>	<b>3.70</b>	<b>30.66</b>	<b>28.51</b>
Band 13	<b>25.73</b>	<b>3.70</b>	<b>29.43</b>	<b>27.28</b>
Band 17	<b>26.73</b>	<b>3.70</b>	<b>30.43</b>	<b>28.28</b>

**ERP / EIRP Results (16QAM)**

Band	Conducted Power (dBm)	Max Antenna Gain (dBi)	EIRP (dBm)	ERP(dBm)
Band 2	<b>23.78</b>	<b>3.70</b>	<b>27.48</b>	<b>25.33</b>
Band 4	<b>26.31</b>	<b>3.70</b>	<b>30.01</b>	<b>27.86</b>
Band 5	<b>27.55</b>	<b>3.70</b>	<b>31.25</b>	<b>29.10</b>
Band 12	<b>26.96</b>	<b>3.70</b>	<b>30.66</b>	<b>28.51</b>
Band 13	<b>25.73</b>	<b>3.70</b>	<b>29.43</b>	<b>27.28</b>
Band 17	<b>26.73</b>	<b>3.70</b>	<b>30.43</b>	<b>28.28</b>

**MPE Calculations for Maximum Antenna Gain**

<p><b>Band 2 (part 24.232, c)</b></p> <table border="1"> <tr><td>Frequency</td><td>1852.5 MHz</td></tr> <tr><td>MPE Limit</td><td style="color: green;">1.000 mW/cm<sup>2</sup></td></tr> <tr><td>Distance</td><td>20 cm</td></tr> <tr><td>Maximum Scaled Power</td><td>26 dBm</td></tr> <tr><td>TX Ant Gain</td><td>3.7 dBi</td></tr> <tr><td>EIRP</td><td>29.7      933.2543 mW</td></tr> <tr><td>Power Density</td><td style="color: green;">0.1857 mW/cm<sup>2</sup> at 20cm</td></tr> <tr><td>EIRP Limit</td><td>2000mW</td></tr> </table>	Frequency	1852.5 MHz	MPE Limit	1.000 mW/cm <sup>2</sup>	Distance	20 cm	Maximum Scaled Power	26 dBm	TX Ant Gain	3.7 dBi	EIRP	29.7      933.2543 mW	Power Density	0.1857 mW/cm <sup>2</sup> at 20cm	EIRP Limit	2000mW	<p><b>Band 4 (part 27.50, d, 4)</b></p> <table border="1"> <tr><td>Frequency</td><td>1732.5 MHz</td></tr> <tr><td>MPE Limit</td><td style="color: green;">1.000 mW/cm<sup>2</sup></td></tr> <tr><td>Distance</td><td>20 cm</td></tr> <tr><td>Maximum Scaled Power</td><td>26 dBm</td></tr> <tr><td>TX Ant Gain</td><td>3.7 dBi</td></tr> <tr><td>EIRP</td><td>29.7      933.2543 mW</td></tr> <tr><td>Power Density</td><td style="color: green;">0.1857 mW/cm<sup>2</sup> at 20cm</td></tr> <tr><td>EIRP Limit</td><td>1000mW</td></tr> </table>	Frequency	1732.5 MHz	MPE Limit	1.000 mW/cm <sup>2</sup>	Distance	20 cm	Maximum Scaled Power	26 dBm	TX Ant Gain	3.7 dBi	EIRP	29.7      933.2543 mW	Power Density	0.1857 mW/cm <sup>2</sup> at 20cm	EIRP Limit	1000mW				
Frequency	1852.5 MHz																																				
MPE Limit	1.000 mW/cm <sup>2</sup>																																				
Distance	20 cm																																				
Maximum Scaled Power	26 dBm																																				
TX Ant Gain	3.7 dBi																																				
EIRP	29.7      933.2543 mW																																				
Power Density	0.1857 mW/cm <sup>2</sup> at 20cm																																				
EIRP Limit	2000mW																																				
Frequency	1732.5 MHz																																				
MPE Limit	1.000 mW/cm <sup>2</sup>																																				
Distance	20 cm																																				
Maximum Scaled Power	26 dBm																																				
TX Ant Gain	3.7 dBi																																				
EIRP	29.7      933.2543 mW																																				
Power Density	0.1857 mW/cm <sup>2</sup> at 20cm																																				
EIRP Limit	1000mW																																				
<p><b>Band 5 (part 22.913, a, 2)</b></p> <table border="1"> <tr><td>Frequency</td><td>826.5 MHz</td></tr> <tr><td>MPE Limit</td><td style="color: green;">0.551 mW/cm<sup>2</sup></td></tr> <tr><td>Distance</td><td>20 cm</td></tr> <tr><td>Maximum Scaled Power</td><td>26 dBm</td></tr> <tr><td>TX Ant Gain</td><td>3.7 dBi</td></tr> <tr><td>EIRP</td><td>29.7      933.2543 mW</td></tr> <tr><td>ERP</td><td>27.55      568.8529 mW</td></tr> <tr><td>Power Density</td><td style="color: green;">0.1857 mW/cm<sup>2</sup> at 20cm</td></tr> <tr><td>ERP Limit</td><td>7000mW</td></tr> </table>	Frequency	826.5 MHz	MPE Limit	0.551 mW/cm <sup>2</sup>	Distance	20 cm	Maximum Scaled Power	26 dBm	TX Ant Gain	3.7 dBi	EIRP	29.7      933.2543 mW	ERP	27.55      568.8529 mW	Power Density	0.1857 mW/cm <sup>2</sup> at 20cm	ERP Limit	7000mW	<p><b>Band 12 (part 27.50, c, 10)</b></p> <table border="1"> <tr><td>Frequency</td><td>701.5 MHz</td></tr> <tr><td>MPE Limit</td><td style="color: green;">0.468 mW/cm<sup>2</sup></td></tr> <tr><td>Distance</td><td>20 cm</td></tr> <tr><td>Maximum Scaled Power</td><td>26 dBm</td></tr> <tr><td>TX Ant Gain</td><td>3.7 dBi</td></tr> <tr><td>EIRP</td><td>29.7      933.2543 mW</td></tr> <tr><td>ERP</td><td>27.55      568.8529 mW</td></tr> <tr><td>Power Density</td><td style="color: green;">0.1857 mW/cm<sup>2</sup> at 20cm</td></tr> <tr><td>ERP Limit</td><td>3000mW</td></tr> </table>	Frequency	701.5 MHz	MPE Limit	0.468 mW/cm <sup>2</sup>	Distance	20 cm	Maximum Scaled Power	26 dBm	TX Ant Gain	3.7 dBi	EIRP	29.7      933.2543 mW	ERP	27.55      568.8529 mW	Power Density	0.1857 mW/cm <sup>2</sup> at 20cm	ERP Limit	3000mW
Frequency	826.5 MHz																																				
MPE Limit	0.551 mW/cm <sup>2</sup>																																				
Distance	20 cm																																				
Maximum Scaled Power	26 dBm																																				
TX Ant Gain	3.7 dBi																																				
EIRP	29.7      933.2543 mW																																				
ERP	27.55      568.8529 mW																																				
Power Density	0.1857 mW/cm <sup>2</sup> at 20cm																																				
ERP Limit	7000mW																																				
Frequency	701.5 MHz																																				
MPE Limit	0.468 mW/cm <sup>2</sup>																																				
Distance	20 cm																																				
Maximum Scaled Power	26 dBm																																				
TX Ant Gain	3.7 dBi																																				
EIRP	29.7      933.2543 mW																																				
ERP	27.55      568.8529 mW																																				
Power Density	0.1857 mW/cm <sup>2</sup> at 20cm																																				
ERP Limit	3000mW																																				
<p><b>Band 13 (part 27.50, b, 10)</b></p> <table border="1"> <tr><td>Frequency</td><td>782 MHz</td></tr> <tr><td>MPE Limit</td><td style="color: green;">0.521 mW/cm<sup>2</sup></td></tr> <tr><td>Distance</td><td>20 cm</td></tr> <tr><td>Maximum Scaled Power</td><td>26 dBm</td></tr> <tr><td>TX Ant Gain</td><td>3.7 dBi</td></tr> <tr><td>EIRP</td><td>29.7      933.2543 mW</td></tr> <tr><td>ERP</td><td>27.55      568.8529 mW</td></tr> <tr><td>Power Density</td><td style="color: green;">0.1857 mW/cm<sup>2</sup> at 20cm</td></tr> <tr><td>ERP Limit</td><td>3000mW</td></tr> </table>	Frequency	782 MHz	MPE Limit	0.521 mW/cm <sup>2</sup>	Distance	20 cm	Maximum Scaled Power	26 dBm	TX Ant Gain	3.7 dBi	EIRP	29.7      933.2543 mW	ERP	27.55      568.8529 mW	Power Density	0.1857 mW/cm <sup>2</sup> at 20cm	ERP Limit	3000mW	<p><b>Band 17 (part 27.50, c, 10)</b></p> <table border="1"> <tr><td>Frequency</td><td>710 MHz</td></tr> <tr><td>MPE Limit</td><td style="color: green;">0.473 mW/cm<sup>2</sup></td></tr> <tr><td>Distance</td><td>20 cm</td></tr> <tr><td>Maximum Scaled Power</td><td>26 dBm</td></tr> <tr><td>TX Ant Gain</td><td>3.7 dBi</td></tr> <tr><td>EIRP</td><td>29.7      933.2543 mW</td></tr> <tr><td>ERP</td><td>27.55      568.8529 mW</td></tr> <tr><td>Power Density</td><td style="color: green;">0.1857 mW/cm<sup>2</sup> at 20cm</td></tr> <tr><td>ERP Limit</td><td>3000mW</td></tr> </table>	Frequency	710 MHz	MPE Limit	0.473 mW/cm <sup>2</sup>	Distance	20 cm	Maximum Scaled Power	26 dBm	TX Ant Gain	3.7 dBi	EIRP	29.7      933.2543 mW	ERP	27.55      568.8529 mW	Power Density	0.1857 mW/cm <sup>2</sup> at 20cm	ERP Limit	3000mW
Frequency	782 MHz																																				
MPE Limit	0.521 mW/cm <sup>2</sup>																																				
Distance	20 cm																																				
Maximum Scaled Power	26 dBm																																				
TX Ant Gain	3.7 dBi																																				
EIRP	29.7      933.2543 mW																																				
ERP	27.55      568.8529 mW																																				
Power Density	0.1857 mW/cm <sup>2</sup> at 20cm																																				
ERP Limit	3000mW																																				
Frequency	710 MHz																																				
MPE Limit	0.473 mW/cm <sup>2</sup>																																				
Distance	20 cm																																				
Maximum Scaled Power	26 dBm																																				
TX Ant Gain	3.7 dBi																																				
EIRP	29.7      933.2543 mW																																				
ERP	27.55      568.8529 mW																																				
Power Density	0.1857 mW/cm <sup>2</sup> at 20cm																																				
ERP Limit	3000mW																																				

## 8 Radiated Spurious Emissions (Transmitter)

### 8.1 Test Limits

#### § 2.1051

The radio frequency voltage or powers generated within the equipment and appearing on a spurious frequency shall be checked at the equipment output terminals when properly loaded with a suitable artificial antenna. Curves or equivalent data shall show the magnitude of each harmonic and other spurious emission that can be detected when the equipment is operated under the conditions specified in §2.1049 as appropriate. The magnitude of spurious emissions which are attenuated more than 20 dB below the permissible value need not be specified.

#### § 22.917

- (a) Out of band emissions. The power of any emission outside of the authorized operating frequency ranges must be attenuated below the transmitting power (P) by a factor of at least  $43 + 10 \log(P)$  dB.
- (b) Measurement procedure. Compliance with these rules is based on the use of measurement instrumentation employing a resolution bandwidth of 100 kHz or greater. In the 1 MHz bands immediately outside and adjacent to the frequency block a resolution bandwidth of at least one percent of the emission bandwidth of the fundamental emission of the transmitter may be employed. A narrower resolution bandwidth is permitted in all cases to improve measurement accuracy provided the measured power is integrated over the full required measurement bandwidth ( i.e. 100 kHz or 1 percent of emission bandwidth, as specified). The emission bandwidth is defined as the width of the signal between two points, one below the carrier center frequency and one above the carrier center frequency, outside of which all emissions are attenuated at least 26 dB below the transmitter power.

#### § 24.238

- (a) Out of band emissions. The power of any emission outside of the authorized operating frequency ranges must be attenuated below the transmitting power (P) by a factor of at least  $43 + 10 \log(P)$  dB.
- (b) Measurement procedure. Compliance with these rules is based on the use of measurement instrumentation employing a resolution bandwidth of 1 MHz or greater. However, in the 1 MHz bands immediately outside and adjacent to the frequency block a resolution bandwidth of at least one percent of the emission bandwidth of the fundamental emission of the transmitter may be employed. A narrower resolution bandwidth is permitted in all cases to improve measurement accuracy provided the measured power is integrated over the full required measurement bandwidth (i.e. 1 MHz or 1 percent of emission bandwidth, as specified). The emission bandwidth is defined as the width of the signal between two points, one below the carrier center frequency and one above the carrier center frequency, outside of which all emissions are attenuated at least 26 dB below the transmitter power.

**§ 27.53**

- (c) For operations in the 746-758 MHz band and the 776-788 MHz band, the power of an emission outside the licensee's frequency band(s) of operation shall be attenuated below the transmitter power (P) within the licensed band(s) of operation, measured in watts, in accordance with the following:
- (c) (2) On any frequency outside the 776-788 MHz band, the power of any emission shall be attenuated outside the band below the transmitter power (P) by at least  $43 + 10 \log (P)$  dB;
- (c) (5) Compliance with the provisions of paragraphs (c)(1) and (c)(2) of this section is based on the use of measurement instrumentation employing a resolution bandwidth of 100 kHz or greater. However, in the 100 kHz bands immediately outside and adjacent to the frequency block, a resolution bandwidth of at least 30 kHz may be employed.
- (g) For operations in the 600 MHz band and the 698-746 MHz band, the power of any emission outside a licensee's frequency band(s) of operation shall be attenuated below the transmitter power (P) within the licensed band(s) of operation, measured in watts, by at least  $43 + 10 \log (P)$  dB. Compliance with this provision is based on the use of measurement instrumentation employing a resolution bandwidth of 100 kilohertz or greater. However, in the 100 kilohertz bands immediately outside and adjacent to a licensee's frequency block, a resolution bandwidth of at least 30 kHz may be employed.
- (h) *AWS emission limits*—(1) *General protection levels*. Except as otherwise specified below, for operations in the 1695-1710 MHz, 1710-1755 MHz, 1755-1780 MHz, 1915-1920 MHz, 1995-2000 MHz, 2000-2020 MHz, 2110-2155 MHz, 2155-2180 MHz, and 2180-2200 bands, the power of any emission outside a licensee's frequency block shall be attenuated below the transmitter power (P) in watts by at least  $43 + 10 \log_{10} (P)$  dB.

## 8.2 Test Procedure

The EUT was placed on a non-conductive turntable. The measurement antenna was placed at a distance of 3 meters from the EUT. The EUT was forced to transmit at its maximum output power setting. During the tests, the antenna height and EUT azimuth were varied in order to identify the maximum level of emissions from the EUT.

The frequency range up to tenth harmonic was investigated in order to identify the spurious emission. Once the spurious emissions were identified, the power of the emission was determined using the substitution method described in TIA-603-C. The spurious emissions attenuation was calculated as the difference between radiated power at the fundamental frequency and at the spurious emissions frequency.

## 8.3 Test Equipment Used:

Description	Serial Number	Manufacturer	Model	Cal. Date	Cal. Due
EMI Test Receiver	1302.6005.40	Rohde&Schwarz	ESU40	9/20/2015	9/20/2016
Pre-amplifier	122005	Rohde&Schwarz	TS-PR18	11/19/2015	11/19/2016
Horn Antenna	00156319	ETS	3117	5/15/2015	5/15/2016
Horn Antenna	00154521	ETS	3117	11/3/2015	11/3/2016
Bilog Antenna	2362	ETS	3142B	1/16/2015	1/16/2016
Bilog Antenna	00051864	ETS	3142C	1/20/2015	1/20/2016
System Controller	121701-1	Sunol Sciences	SC99V	Time of Use	Time of Use
High Pass Filter	1	Wainwright	WHKX12-2533.85-2710-18000-40SS	Time of Use	Time of Use
High Pass Filter	25	Wainwright	WHKX12-1028.5-1100-1500-40SS	Time of Use	Time of Use
Base Station Simulator	3917	Rohde & Schwarz	CMW500	9/19/2015	9/19/2016
Signal Generator	3915	Rohde&Schwarz	SMB100A	9/18/2015	9/18/2016

**8.4 Results:**

All radiated spurious emissions were attenuated below the transmitting power (P) by a factor of at least 43 + 10 log(P) dB which is equivalent to -13dBm. The emissions were measured using an RMS detector and the analyzer was gated so that the emission was only measured during the on-times of the transmitter.

**Worst Case Spurious Measurements – Band 2**

Radiated Spurious Emissions Measurement								
Test Engineer:	Brian Daffin		Start Date:	2/29/2016		End Date:	2/29/2016	
Temperature:	22.5 C		Humidity:	29.10%		Pressure:	982mbar	
RBW:	1MHz		VBW:	3MHz				
Notes:	Results represent the worst case from 3 orthogonal axis positions.							
			A	B	C	D	E	F
Band/Channel	Spurious Frequency (MHz)	Polarity	Device Reading (dBm)	Signal Generator Level (dBm)	Cable Loss (dB)	Tx Antenna Gain (dBd)	Limit (dBm)	Radiated Spurious Emission Level (dBm)
Band 2 Low Ch (1852.5 MHz)	3705.0	H	-57.65	-47.09	4.85	8.26	-13	-43.68
	3705.0	V	-57.11	-46.05	4.85	8.26	-13	-42.64
	5557.5	H	-58.11	-43.66	6.91	10.40	-13	-40.18
	5557.5	V	-54.99	-40.33	6.91	10.40	-13	-36.85
	7410.0	H	-56.82	-38.25	7.75	11.84	-13	-34.16
	7410.0	V	-55.8	-38.39	7.75	11.84	-13	-34.30
	9262.5	H	-68.09	-47.39	9.08	13.19	-13	-43.28
	9262.5	V	-64.28	-44.75	9.08	13.19	-13	-40.64
	11115.0	H	-69.43	-44.89	10.47	13.23	-13	-42.13
11115.0	V	-66.86	-43.92	10.47	13.23	-13	-41.16	
Band 2 Mid Ch (1880.0 MHz)	3760.0	H	-57.62	-46.59	5.20	8.26	-13	-43.53
	3760.0	V	-56.31	-44.93	5.20	8.26	-13	-41.87
	5640.0	H	-57.74	-40.49	7.09	10.56	-13	-37.02
	5640.0	V	-53.32	-37.37	7.09	10.56	-13	-33.90
	7520.0	H	-55.21	-36.5	8.01	11.93	-13	-32.59
	7520.0	V	-54.73	-37.14	8.01	11.93	-13	-33.23
	9400.0	H	-68.05	-46.52	9.15	13.12	-13	-42.56
	9400.0	V	-63.82	-43.76	9.15	13.12	-13	-39.80
	11280.0	H	-71.77	-46.9	10.16	13.26	-13	-43.80
11280.0	V	-68.7	-45.53	10.16	13.26	-13	-42.43	
Band 2 High Ch (1907.5 MHz)	3815.0	H	-54.77	-43.84	5.00	8.25	-13	-40.59
	3815.0	V	-53.17	-41.98	5.00	8.25	-13	-38.73
	5722.5	H	-54.74	-36.93	6.61	10.66	-13	-32.88
	5722.5	V	-52.15	-35.4	6.61	10.66	-13	-31.35
	7630.0	H	-54.96	-36.18	8.15	11.98	-13	-32.35
	7630.0	V	-51.59	-34.11	8.15	11.98	-13	-30.28
	9537.5	H	-69.83	-47.84	8.41	13.09	-13	-43.17
	9537.5	V	-68.52	-47.9	8.41	13.09	-13	-43.23
	11445.0	H	-70.89	-45.76	9.13	13.25	-13	-41.64
11445.0	V	-65.23	-41.33	9.13	13.25	-13	-37.21	
								F=B-C+D

**Worst Case Spurious Measurements – Band 4**

Radiated Spurious Emissions Measurement								
Test Engineer:	Brian Daffin		Start Date:	2/29/2016		End Date:	2/29/2016	
Temperature:	22.5 C		Humidity:	29.10%		Pressure:	982mbar	
RBW:	1MHz		VBW:	3MHz				
Notes:	Results represent the worst case from 3 orthogonal axis positions.							
			A	B	C	D	E	F
Band/Channel	Spurious Frequency (MHz)	Polarity	Device Reading (dBm)	Signal Generator Level (dBm)	Cable Loss (dB)	Tx Antenna Gain (dBd)	Limit (dBm)	Radiated Spurious Emission Level (dBm)
Band 4 Low Ch (1712.5MHz)	3425.0	H	-63.23	-53.72	4.60	7.83	-13	-50.49
	3425.0	V	-63.03	-52.50	4.60	7.83	-13	-49.27
	5137.5	H	-44.91	-30.81	6.06	10.12	-13	-26.75
	5137.5	V	-42.99	-29.53	6.06	10.12	-13	-25.47
	6850.0	H	-60.05	-41.84	7.59	11.11	-13	-38.32
	6850.0	V	-57.29	-40.26	7.59	11.11	-13	-36.74
	8562.5	H	-66.69	-47.17	8.76	12.91	-13	-43.02
	8562.5	V	-65.28	-46.98	8.76	12.91	-13	-42.83
	10275.0	H	-69.50	-46.49	9.89	13.06	-13	-43.33
10275.0	V	-66.37	-44.96	9.89	13.06	-13	-41.80	
Band 4 Mid Ch (1732.5MHz)	3465.0	H	-61.24	-51.79	4.80	7.83	-13	-48.76
	3465.0	V	-62.92	-52.46	4.80	7.83	-13	-49.43
	5197.5	H	-48.35	-33.74	6.18	10.12	-13	-29.80
	5197.5	V	-44.31	-30.72	6.18	10.12	-13	-26.78
	6930.0	H	-47.83	-29.91	7.60	11.26	-13	-26.25
	6930.0	V	-45.87	-29.60	7.60	11.26	-13	-25.94
	8662.5	H	-69.35	-49.15	8.79	12.98	-13	-44.96
	8662.5	V	-67.90	-49.20	8.79	12.98	-13	-45.01
	10395.0	H	-70.48	-46.68	11.05	13.08	-13	-44.65
10395.0	V	-70.27	-47.62	11.05	13.08	-13	-45.59	
Band 4 High Ch (1752.5MHz)	3505.0	H	-59.37	-49.56	4.56	8.15	-13	-45.97
	3505.0	V	-60.26	-49.51	4.56	8.15	-13	-45.92
	5257.5	H	-50.36	-36.58	6.27	10.27	-13	-32.58
	5257.5	V	-46.09	-33.15	6.27	10.27	-13	-29.15
	7010.0	H	-58.36	-39.97	7.73	11.36	-13	-36.34
	7010.0	V	-56.34	-39.53	7.73	11.36	-13	-35.90
	8762.5	H	-68.76	-47.70	8.50	12.92	-13	-43.28
	8762.5	V	-67.15	-47.35	8.50	12.92	-13	-42.93
	10515.0	H	-69.02	-45.14	9.30	13.08	-13	-41.36
10515.0	V	-67.83	-44.80	9.30	13.08	-13	-41.02	
								F=B-C+D



**Worst Case Spurious Measurements – Band 5**

Radiated Spurious Emissions Measurement								
<b>Test Engineer:</b>	Brian Daffin		<b>Start Date:</b>	2/29/2016		<b>End Date:</b>	2/29/2016	
<b>Temperature:</b>	22.5 C		<b>Humidity:</b>	29.10%		<b>Pressure:</b>	982mbar	
<b>RBW:</b>	1MHz		<b>VBW:</b>	3MHz				
<b>Notes:</b>	Results represent the worst case from 3 orthogonal axis positions.							
			A	B	C	D	E	F
Band/Channel	Spurious Frequency (MHz)	Polarity	Device Reading (dBm)	Signal Generator Level (dBm)	Cable Loss (dB)	Tx Antenna Gain (dBd)	Limit (dBm)	Radiated Spurious Emission Level (dBm)
Band 5 Low Ch (824.0 MHz)	1653.0	H	-57.66	-55.00	3.30	5.64	-13	-52.66
	1653.0	V	-60.65	-56.87	3.30	5.64	-13	-54.53
	2479.5	H	-50.13	-43.89	4.17	5.87	-13	-42.19
	2479.5	V	-46.35	-38.35	4.17	5.87	-13	-36.65
	3306.0	H	-58.09	-49.31	4.58	7.67	-13	-46.22
	3306.0	V	-57.28	-47.89	4.58	7.67	-13	-44.80
	4132.5	H	-65.70	-55.19	5.22	8.91	-13	-51.50
	4132.5	V	-67.05	-56.54	5.22	8.91	-13	-52.85
	4959.0	H	-66.95	-53.48	5.82	9.90	-13	-49.40
4959.0	V	-66.54	-54.38	5.82	9.90	-13	-50.30	
Band 5 Mid Ch (836.5 Hz)	1673.0	H	-52.79	-49.94	3.30	5.64	-13	-47.60
	1673.0	V	-55.12	-50.55	3.30	5.64	-13	-48.21
	2509.5	H	-49.37	-43.05	3.97	5.65	-13	-41.37
	2509.5	V	-48.03	-40.06	3.97	5.65	-13	-38.38
	3346.0	H	-53.33	-44.79	4.63	7.67	-13	-41.75
	3346.0	V	-53.08	-43.26	4.63	7.67	-13	-40.22
	4182.5	H	-63.05	-52.22	5.19	8.91	-13	-48.50
	4182.5	V	-60.74	-49.77	5.19	8.91	-13	-46.05
	5019.0	H	-67.26	-52.46	6.19	9.99	-13	-48.66
5019.0	V	-67.74	-53.99	6.19	9.99	-13	-50.19	
Band 5 High Ch (846.5 MHz)	1693.0	H	-63.74	-60.40	3.48	5.64	-13	-58.24
	1693.0	V	-63.09	-57.93	3.48	5.64	-13	-55.77
	2539.5	H	-45.59	-39.38	4.09	5.65	-13	-37.82
	2539.5	V	-47.13	-39.58	4.09	5.65	-13	-38.02
	3386.0	H	-55.31	-45.96	4.84	7.67	-13	-43.13
	3386.0	V	-55.82	-45.50	4.84	7.67	-13	-42.67
	4232.5	H	-67.47	-56.78	4.87	9.01	-13	-52.64
	4232.5	V	-65.64	-55.10	4.87	9.01	-13	-50.96
	5079.0	H	-67.78	-53.65	6.25	9.99	-13	-49.91
5079.0	V	-67.75	-54.57	6.25	9.99	-13	-50.83	
								F=B-C+D

**Worst Case Spurious Measurements – Band 12**

Radiated Spurious Emissions Measurement								
Test Engineer:	Brian Daffin		Start Date:	2/29/2016		End Date:	2/29/2016	
Temperature:	22.5 C		Humidity:	29.10%		Pressure:	982mbar	
RBW:	1MHz		VBW:	3MHz				
Notes:	Results represent the worst case from 3 orthogonal axis positions.							
			A	B	C	D	E	F
Band/Channel	Spurious Frequency (MHz)	Polarity	Device Reading (dBm)	Signal Generator Level (dBm)	Cable Loss (dB)	Tx Antenna Gain (dBd)	Limit (dBm)	Radiated Spurious Emission Level (dBm)
Band 12 Low Ch (701.5MHz)	1401.0	H	-59.16	-56.51	3.06	4.28	-13	-55.29
	1401.0	V	-64.28	-61.29	3.06	4.28	-13	-60.07
	2101.5	H	-45.95	-40.93	3.65	4.89	-13	-39.69
	2101.5	V	-55.93	-49.76	3.65	4.89	-13	-48.52
	2802.0	H	-53.45	-46.46	4.16	6.89	-13	-43.73
	2802.0	V	-50.38	-42.17	4.16	6.89	-13	-39.44
	3502.5	H	-61.97	-52.91	4.56	8.15	-13	-49.32
	3502.5	V	-64.03	-54.21	4.56	8.15	-13	-50.62
	4203.0	H	-67.64	-57.18	4.98	9.01	-13	-53.15
4203.0	V	-67.15	-56.24	4.98	9.01	-13	-52.21	
Band 12 Mid Ch (707.5MHz)	1415.0	H	-59.67	-56.85	2.80	4.28	-13	-55.37
	1415.0	V	-64.93	-62.22	2.80	4.28	-13	-60.74
	2122.5	H	-46.08	-41.31	3.69	4.89	-13	-40.11
	2122.5	V	-52.50	-46.27	3.69	4.89	-13	-45.07
	2830.0	H	-54.35	-47.19	4.21	6.89	-13	-44.51
	2830.0	V	-49.26	-40.79	4.21	6.89	-13	-38.11
	3537.5	H	-63.49	-54.20	4.60	8.15	-13	-50.65
	3537.5	V	-64.32	-54.10	4.60	8.15	-13	-50.55
	4245.0	H	-67.44	-56.82	5.00	9.01	-13	-52.81
4245.0	V	-67.28	-56.37	5.00	9.01	-13	-52.36	
Band 12 High Ch (713.5MHz)	1427.0	H	-58.15	-55.67	2.80	4.28	-13	-54.19
	1427.0	V	-62.77	-59.94	2.80	4.28	-13	-58.46
	2140.5	H	-46.76	-41.85	3.71	4.89	-13	-40.67
	2140.5	V	-49.77	-43.29	3.71	4.89	-13	-42.11
	2854.0	H	-54.21	-46.75	4.26	6.89	-13	-44.12
	2854.0	V	-48.50	-40.01	4.26	6.89	-13	-37.38
	3567.5	H	-63.22	-53.73	4.73	8.15	-13	-50.31
	3567.5	V	-64.35	-53.87	4.73	8.15	-13	-50.45
	4281.0	H	-67.76	-56.95	5.33	9.01	-13	-53.27
4281.0	V	-67.55	-56.74	5.33	9.01	-13	-53.06	
								F=B-C+D

**Worst Case Spurious Measurements – Band 13**

Radiated Spurious Emissions Measurement								
Test Engineer:	Brian Daffin		Start Date:	2/29/2016		End Date:	2/29/2016	
Temperature:	22.5 C		Humidity:	29.10%		Pressure:	982mbar	
RBW:	1MHz		VBW:	3MHz				
Notes:	Results represent the worst case from 3 orthogonal axis positions.							
			A	B	C	D	E	F
Band/Channel	Spurious Frequency (MHz)	Polarity	Device Reading (dBm)	Signal Generator Level (dBm)	Cable Loss (dB)	Tx Antenna Gain (dBd)	Limit (dBm)	Radiated Spurious Emission Level (dBm)
Band 13 Low Ch (779.5 MHz)	1559.0	H	-52.87	-47.77	3.03	5.40	-13	-45.40
	1559.0	V	-54.83	-49.38	3.03	5.40	-13	-47.01
	2338.5	H	-61.60	-43.19	4.18	6.07	-13	-41.30
	2338.5	V	-59.48	-41.94	4.18	6.07	-13	-40.05
	3118.0	H	-58.32	-48.29	4.36	7.09	-13	-45.56
	3118.0	V	-58.47	-47.35	4.36	7.09	-13	-44.62
	3897.5	H	-67.49	-54.28	5.05	8.25	-13	-51.08
	3897.5	V	-67.12	-51.00	5.05	8.25	-13	-47.80
	4677.0	H	-66.99	-47.83	5.28	9.33	-13	-43.78
4677.0	V	-67.03	-51.80	5.28	9.33	-13	-47.75	
Band 13 Mid Ch (782.0 MHz)	1564.0	H	-59.80	-54.47	3.03	5.40	-13	-52.10
	1564.0	V	-62.67	-57.23	3.03	5.40	-13	-54.86
	2346.0	H	-61.11	-41.52	4.18	6.07	-13	-39.63
	2346.0	V	-60.46	-42.75	4.18	6.07	-13	-40.86
	3128.0	H	-61.82	-51.57	4.36	7.09	-13	-48.84
	3128.0	V	-63.62	-52.23	4.36	7.09	-13	-49.50
	3910.0	H	-66.70	-53.75	5.04	8.43	-13	-50.36
	3910.0	V	-67.75	-52.45	5.04	8.43	-13	-49.06
	4692.0	H	-68.07	-47.50	5.54	9.33	-13	-43.71
4692.0	V	-66.92	-50.18	5.54	9.33	-13	-46.39	
Band 13 High Ch (784.5 MHz)	1569.0	H	-58.32	-53.41	3.03	5.40	-13	-51.04
	1569.0	V	-58.26	-52.74	3.03	5.40	-13	-50.37
	2353.5	H	-63.04	-42.47	4.07	6.07	-13	-40.47
	2353.5	V	-60.92	-43.77	4.07	6.07	-13	-41.77
	3138.0	H	-63.56	-53.10	4.45	7.09	-13	-50.46
	3138.0	V	-61.57	-50.09	4.45	7.09	-13	-47.45
	3922.5	H	-67.31	-54.82	5.04	8.43	-13	-51.43
	3922.5	V	-67.71	-52.83	5.04	8.43	-13	-49.44
	4707.0	H	-67.73	-45.28	5.54	9.39	-13	-41.43
4707.0	V	-66.87	-48.06	5.54	9.39	-13	-44.21	
								F=B-C+D

**Worst Case Spurious Measurements – Band 17**

Radiated Spurious Emissions Measurement								
<b>Test Engineer:</b>	Brian Daffin		<b>Start Date:</b>	3/1/2016		<b>End Date:</b>	3/1/2016	
<b>Temperature:</b>	22.1 C		<b>Humidity:</b>	26.20%		<b>Pressure:</b>	978.6 mbar	
<b>RBW:</b>	1MHz		<b>VBW:</b>	3MHz				
<b>Notes:</b>	Results represent the worst case from 3 orthogonal axis positions.							
			A	B	C	D	E	F
Band/Channel	Spurious Frequency (MHz)	Polarity	Device Reading (dBm)	Signal Generator Level (dBm)	Cable Loss (dB)	Tx Antenna Gain (dBd)	Limit (dBm)	Radiated Spurious Emission Level (dBm)
Band 17 Low Ch (706.5 MHz)	1413.0	H	-61.57	-46.56	2.80	4.28	-13	-45.08
	1413.0	V	-63.76	-56.26	2.80	4.28	-13	-54.78
	2119.5	H	-37.45	-30.07	3.69	4.89	-13	-28.87
	2119.5	V	-45.22	-35.27	3.69	4.89	-13	-34.07
	2826.0	H	-56.17	-34.38	4.21	6.89	-13	-31.70
	2826.0	V	-50.04	-31.23	4.21	6.89	-13	-28.55
	3532.5	H	-65.76	-55.80	4.60	8.15	-13	-52.25
	3532.5	V	-65.18	-54.19	4.60	8.15	-13	-50.64
	4239.0	H	-67.02	-48.38	4.87	9.01	-13	-44.24
4239.0	V	-66.15	-51.48	4.87	9.01	-13	-47.34	
Band Mid Ch (710.0 MHz)	1420.0	H	-57.60	-43.79	2.80	4.28	-13	-42.31
	1420.0	V	-63.35	-56.30	2.80	4.28	-13	-54.82
	2130.0	H	-38.74	-30.71	3.71	4.89	-13	-29.53
	2130.0	V	-43.34	-33.75	3.71	4.89	-13	-32.57
	2840.0	H	-52.76	-30.13	4.21	6.89	-13	-27.45
	2840.0	V	-51.02	-33.01	4.21	6.89	-13	-30.33
	3550.0	H	-65.89	-55.97	4.61	8.15	-13	-52.43
	3550.0	V	-66.83	-55.97	4.61	8.15	-13	-52.43
	4260.0	H	-67.53	-48.87	5.00	9.01	-13	-44.86
4260.0	V	-66.65	-51.14	5.00	9.01	-13	-47.13	
Band 17 High Ch (713.5 MHz)	1427.0	H	-54.27	-40.39	2.80	4.28	-13	-38.91
	1427.0	V	-60.16	-53.33	2.80	4.28	-13	-51.85
	2140.5	H	-40.85	-33.40	3.71	4.89	-13	-32.22
	2140.5	V	-43.47	-33.46	3.71	4.89	-13	-32.28
	2854.0	H	-54.36	-31.72	4.26	6.89	-13	-29.09
	2854.0	V	-49.50	-32.27	4.26	6.89	-13	-29.64
	3567.5	H	-64.15	-53.74	4.73	8.15	-13	-50.32
	3567.5	V	-65.90	-54.63	4.73	8.15	-13	-51.21
	4281.0	H	-67.17	-49.25	5.33	9.01	-13	-45.57
4281.0	V	-66.94	-50.93	5.33	9.01	-13	-47.25	
								F=B-C+D

## 9 Frequency Stability

### 9.1 Test Limits

#### § 2.1055, §22.355, §24.235, §27.54

The frequency stability of the transmitter was required to maintain a  $\pm 2.5$ ppm tolerance.

### 9.2 Test Procedure

The equipment under test was connected to a DC power source and the RF output was connected to a Base Station Simulator. The Base Station Simulator was set to force the EUT to its maximum power setting. The EUT was placed inside the temperature chamber. The DC leads and RF output cable exited the chamber through an opening made for that purpose. After the temperature stabilized for approximately 30 minutes, the frequency error was read from the base station simulator. At 20C the input voltage was varied from 85% to 115% and the frequency stability vs input voltage was recorded.

### 9.3 Test Equipment Used:

Description	Serial Number	Manufacturer	Model	Cal. Date	Cal. Due
Base Station Simulator	3917	Rohde & Schwarz	CMW500	9/19/2015	9/19/2016
Environmental Chamber	32692	Thermotron	SM-8C	2/24/2015	2/24/2016
Multimeter	3550	Fluke	115	8/4/2015	8/4/2016
Power Supply	3513	Gwinstek	GPS1850	NCR	NCR

**9.4 Results:**

The tables below show the frequency stability data. In all cases the test sample met the  $\pm 2.5$ ppm limit.

**Frequency Stability Band 2**

<b>Operating Frequency:</b>		1,880,000,000 Hz			
<b>Channel:</b>		18900			
<b>Reference Voltage:</b>		5 VDC			
<b>Deviation Limit:</b>		2.5 ppm			
<b>Notes:</b>		Frequency Stability in Band 2			
Voltage (%)	Voltage (DC)	Temp (°C)	Frequency Error (Hz)	Deviation (%)	Deviation (ppm)
100%	5.0	-30	-2	-0.0000003	-0.0028
100%	5.0	-20	-2.5	-0.0000004	-0.0035
100%	5.0	-10	-2.7	-0.0000004	-0.0038
100%	5.0	0	-2.4	-0.0000003	-0.0034
100%	5.0	10	-1.2	-0.0000002	-0.0017
100%	5.0	20	-1	-0.0000001	-0.0014
100%	5.0	30	-1.4	-0.0000002	-0.0020
100%	5.0	40	-1.5	-0.0000002	-0.0021
100%	5.0	50	-1.7	-0.0000002	-0.0024
100%	5.0	60	-1.2	-0.0000002	-0.0017
115%	5.8	20	3.3	0.0000005	0.0047
85%	4.3	20	3.2	0.0000005	0.0045

**Frequency Stability Band 4**

<b>Operating Frequency:</b>		1,732,500,000 Hz			
<b>Channel:</b>		20175			
<b>Reference Voltage:</b>		5 VDC			
<b>Deviation Limit:</b>		2.5 ppm			
<b>Notes:</b>		Frequency Stability in Band 4			
Voltage (%)	Voltage (DC)	Temp (°C)	Frequency Error (Hz)	Deviation (%)	Deviation (ppm)
100%	5.0	-30	-1.5	-0.0000002	-0.0018
100%	5.0	-20	-1.7	-0.0000002	-0.0020
100%	5.0	-10	-1.8	-0.0000002	-0.0022
100%	5.0	0	-2.3	-0.0000003	-0.0027
100%	5.0	10	-1	-0.0000001	-0.0012
100%	5.0	20	-0.9	-0.0000001	-0.0011
100%	5.0	30	-0.2	0.0000000	-0.0002
100%	5.0	40	-1.4	-0.0000002	-0.0017
100%	5.0	50	-1.4	-0.0000002	-0.0017
100%	5.0	60	-1.2	-0.0000001	-0.0014
115%	5.8	20	-2.3	-0.0000003	-0.0027
85%	4.3	20	-1.8	-0.0000002	-0.0022

**Frequency Stability Band 5**

<b>Operating Frequency:</b>		836,500,000 Hz			
<b>Channel:</b>		20525			
<b>Reference Voltage:</b>		5 VDC			
<b>Deviation Limit:</b>		2.5 ppm			
<b>Notes:</b>		Frequency Stability in Band 5			
Voltage (%)	Voltage (DC)	Temp (°C)	Frequency Error (Hz)	Deviation (%)	Deviation (ppm)
100%	5.0	-30	-1.7	-0.0000002	-0.0020
100%	5.0	-20	-0.9	-0.0000001	-0.0011
100%	5.0	-10	-1.2	-0.0000001	-0.0014
100%	5.0	0	-1.3	-0.0000002	-0.0016
100%	5.0	10	-0.1	0.0000000	-0.0001
100%	5.0	20	-0.1	0.0000000	-0.0001
100%	5.0	30	0.2	0.0000000	0.0002
100%	5.0	40	-0.5	-0.0000001	-0.0006
100%	5.0	50	-0.3	0.0000000	-0.0004
100%	5.0	60	-0.1	0.0000000	-0.0001
115%	5.8	20	-1.8	-0.0000002	-0.0022
85%	4.3	20	-1.9	-0.0000002	-0.0023

**Frequency Stability Band 12**

<b>Operating Frequency:</b>		707,500,000 Hz			
<b>Channel:</b>		23095			
<b>Reference Voltage:</b>		5 VDC			
<b>Deviation Limit:</b>		2.5 ppm			
<b>Notes:</b>		Frequency Stability in Band 12			
Voltage (%)	Voltage (DC)	Temp (°C)	Frequency Error (Hz)	Deviation (%)	Deviation (ppm)
100%	5.0	-30	-2	-0.0000003	-0.0028
100%	5.0	-20	-2.2	-0.0000003	-0.0031
100%	5.0	-10	-1.7	-0.0000002	-0.0024
100%	5.0	0	-1.2	-0.0000002	-0.0017
100%	5.0	10	-0.3	0.0000000	-0.0004
100%	5.0	20	-0.5	-0.0000001	-0.0007
100%	5.0	30	-0.4	-0.0000001	-0.0006
100%	5.0	40	-0.5	-0.0000001	-0.0007
100%	5.0	50	-0.7	-0.0000001	-0.0010
100%	5.0	60	-0.6	-0.0000001	-0.0008
115%	5.8	20	-1.8	-0.0000003	-0.0025
85%	4.3	20	-1.7	-0.0000002	-0.0024

**Frequency Stability Band 13**

<b>Operating Frequency:</b>		782,000,000 Hz			
<b>Channel:</b>		18900			
<b>Reference Voltage:</b>		5 VDC			
<b>Deviation Limit:</b>		2.5 ppm			
<b>Notes:</b>		Frequency Stability in Band 13			
Voltage (%)	Voltage (DC)	Temp (°C)	Frequency Error (Hz)	Deviation (%)	Deviation (ppm)
100%	5.0	-30	-0.7	-0.0000001	-0.0008
100%	5.0	-20	-1.1	-0.0000001	-0.0013
100%	5.0	-10	-4.8	-0.0000006	-0.0057
100%	5.0	0	0.2	0.0000000	0.0002
100%	5.0	10	1.5	0.0000002	0.0018
100%	5.0	20	-0.7	-0.0000001	-0.0008
100%	5.0	30	-1.3	-0.0000002	-0.0016
100%	5.0	40	-4.6	-0.0000005	-0.0055
100%	5.0	50	1.8	0.0000002	0.0022
100%	5.0	60	-3.4	-0.0000004	-0.0041
115%	5.8	20	-2	-0.0000002	-0.0024
85%	4.3	20	-1.9	-0.0000002	-0.0023

**Frequency Stability Band 17**

<b>Operating Frequency:</b>		710,000,000 Hz			
<b>Channel:</b>		18900			
<b>Reference Voltage:</b>		5 VDC			
<b>Deviation Limit:</b>		2.5 ppm			
<b>Notes:</b>		Frequency Stability in Band 17			
Voltage (%)	Voltage (DC)	Temp (°C)	Frequency Error (Hz)	Deviation (%)	Deviation (ppm)
100%	5.0	-30	-1.2	-0.0000002	-0.0017
100%	5.0	-20	-1	-0.0000001	-0.0014
100%	5.0	-10	1.1	0.0000002	0.0016
100%	5.0	0	-0.9	-0.0000001	-0.0013
100%	5.0	10	-0.3	0.0000000	-0.0004
100%	5.0	20	1.3	0.0000002	0.0018
100%	5.0	30	0.9	0.0000001	0.0013
100%	5.0	40	0.7	0.0000001	0.0010
100%	5.0	50	0.3	0.0000000	0.0004
100%	5.0	60	1.7	0.0000002	0.0024
115%	5.8	20	-2	-0.0000003	-0.0028
85%	4.3	20	-2.1	-0.0000003	-0.0030



## 10 Measurement Uncertainty

The measured value related to the corresponding limit will be used to decide whether the equipment meets the requirements.

The measurement uncertainty figures were calculated and correspond to a coverage factor of  $k = 2$ , providing a confidence level of respectively 95.45 % in the case where the distributions characterizing the actual measurement uncertainties are normal (Gaussian).

Measurement uncertainty Table

Parameter	Uncertainty	Notes
Radiated emissions, 30 to 1000 MHz	+3.9dB	
Radiated emissions, 1 to 18 GHz	+4.2dB	
Radiated emissions, 18 to 40 GHz	+4.3dB	
Power Port Conducted emissions, 150kHz to 30 MHz	+2.8dB	

**11 Revision History**

<b>Revision Level</b>	<b>Date</b>	<b>Report Number</b>	<b>Notes</b>
0	3/11/2016	102374971LEX-001	Original Issue