



TEST REPORT

Report Number: 102374971MPK-009

Project Number: G102374971

March 29, 2016

**Testing performed on the
IQ Panel 2 Home Security Panel
Models: IQPANEL2, IQPANEL2-ZW, IQPANEL2-ZB, IQPANEL2-ZZ
FCC ID: 2AAJXQS-IQPANEL2
IC: 11205A-QSIQPANEL**

**to
FCC Part 15, Subpart E
RSS-247 Issue 1**

**For
Qolsys, Inc.**

Test Performed by:
Intertek
1365 Adams Court
Menlo Park, CA 94025 USA

Test Authorized by:
Qolsys, Inc.
1900 The Alameda #420
San Jose, CA 95126 USA

Prepared by: 
Anderson Soungpanya

Date: March 29, 2016

Reviewed by: 
Krishna K Vemuri

Date: March 29, 2016

This report is for the exclusive use of Intertek's Client and is provided pursuant to the agreement between Intertek and its Client. Intertek's responsibility and liability are limited to the terms and conditions of the agreement. Intertek assumes no liability to any party, other than to the Client in accordance with the agreement, for any loss, expense or damage occasioned by the use of this report. Only the Client is authorized to copy or distribute this report and then only in its entirety. Any use of the Intertek name or one of its marks for the sale or advertisement of the tested material, product or service must first be approved in writing by Intertek. The observations and test results in this report are relevant only to the sample tested. This report by itself does not imply that the material, product, or service is or has ever been under an Intertek certification program. This report must not be used to claim product endorsement by A2LA, NIST nor any other agency of the U.S. Government.

VERIFICATION OF COMPLIANCE
Report No. 102374971MPK-009

Verification is hereby issued to the named APPLICANT and is VALID ONLY for the equipment identified hereon for use under the rules and regulations listed below.

Equipment Under Test:	IQ Panel 2 Home Security Panel
Trade Name:	Qolsys, Inc.
Model No.:	IQPANEL2, IQPANEL2-ZW, IQPANEL2-ZB, IQPANEL2-ZZ
Serial No.:	QV903154300142AA & QV903154300152AA
Applicant:	Qolsys, Inc.
Contact:	Mark Skeen
Address:	1900 The Alameda #420 San Jose, CA 95126
Country	USA
Tel. Number:	(408) 857-8415
Email:	Mark.Skeen@qolsys.com
Applicable Regulation:	FCC Part 15, Subpart E RSS-247 Issue 1
Date of Test:	February 12 – March 7, 2016

We attest to the accuracy of this report:



Anderson Soungpanya
EMC Project Engineer



Krishna K Vemuri
EMC Engineering Team Lead



TABLE OF CONTENTS

1.0	Introduction.....	5
1.1	Summary of Tests.....	5
2.0	General Description	6
2.1	Product Description.....	6
2.2	Related Submittal(s) Grants	7
2.3	Test Methodology	7
2.4	Test Facility.....	7
2.5	Measurement Uncertainty	7
3.0	System Test Configuration.....	8
3.1	Support Equipment	8
3.2	Block Diagram of Test Setup	8
3.3	Justification	9
3.4	Mode of Operation During Test	10
3.5	Modifications required for Compliance	10
3.6	Additions, deviations and exclusions from standards.....	10
4.0	Measurement Results.....	11
4.1	Emission Bandwidth and 99% Occupied Bandwidth.....	11
4.1.1	Procedure	11
4.1.2	Test Result	12
4.2	Maximum Conducted Output Power.....	24
4.2.1	Requirement.....	24
4.2.2	Procedure	24
4.2.3	Test Results.....	25
4.3	Peak Power Spectral Density.....	37
4.3.1	Requirement.....	37
4.3.2	Procedure	37
4.3.3	Test Result	38
4.4	Frequency stability	39
4.4.1	Requirement.....	39
4.4.2	Procedure	39
4.4.3	Result	40
4.5	Transmitter Radiated Emissions.....	41
4.5.1	Requirement.....	41
4.5.2	Procedure	42
4.5.3	Field Strength Calculation.....	43
4.5.4	Antenna-port conducted measurements.....	44
4.5.6	General Procedure for conducted measurements in restricted bands.....	44
4.5.7	Test Results.....	44
4.5.8	Test setup photographs.....	71
4.6	Dynamic Frequency Selection (DFS).....	73
4.6.1	Requirement.....	73



4.6.2	Procedure	76
4.6.3	Test Results	81
6.0	Document History	88

1.0 Introduction

1.1 Summary of Tests

Test	Reference FCC	Reference RSS-247	Result
26 dB Emission Band width and 99% Occupied Bandwidth	15.407(a)(1)(2)(3)	RSS-247, 6.2.3	Complies
Conducted Output Power	15.407(a)(1)(2)(3)	RSS-247, 6.2.3	Complies
Peak Power Spectral Density	15.407(a)(1)(2)(3)	RSS-247, 6.2.3	Complies
Undesirable Emissions	15.407(b)(1-8)	RSS-247, 6.2.3	Complies
Transmitter Radiated Emissions	15.407(b)(1-8) 15.209, 15.205	RSS-247, 6.2.3	Complies
Frequency stability	15.407(g)	RSS-Gen	Complies
Transmit power control (TPC)	15.407(h)(1)	RSS-247, 6.2.3	NA, EUT is less 250mW EIRP
Radar Detection Function of Dynamic Frequency Selection (DFS)	15.407(h)(2)	RSS-247, 6.3	Complies
Antenna Requirement	15.203	RSS-Gen	Complies. The EUT uses internal antenna and a unique connector

EUT receive date: January 18, 2016

EUT receive condition: The pre-production version of the EUT was received in good condition with no apparent damage. As declared by the Applicant, it is identical to the production units.

Test start date: February 12, 2016

Test completion date: March 07, 2016

The test results in this report pertain only to the item tested.

2.0 General Description

2.1 Product Description

Qolsys, Inc. supplied the following description of the EUT:

As described by the manufacturer, the EUT is a home security panel with cellular and WiFi/BT connection to the cloud, as well as specific radios for security sensors and automation.

The information about the 5GHz radio, installed in the IQ Panel 2 Home Security Panel, is presented below.

Applicant	Qolsys, Inc.
Model No.	QS9201-1230-840
FCC Identifier	2AAJXQS-IQPANEL2
IC Identifier	11205A-QSIQPANEL2
Use of Product	WIFI Client (Client without radar detection)
Rated RF Output	17.96 dBm
Frequency Range	5470 – 5725 MHz
Type of modulation	OFDM
Antenna(s) & Gain	Internal Antenna, 2.7dBi peak gain
Manufacturer Name & Address	Qolsys, Inc. 1900 The Alameda #420 San Jose, CA 95126 USA

The EUT supports the following configurations:

Number	Frequency, MHz	802.11a/n/ac 20MHz Channels		802.11n/ac 40MHz Channels		802.11ac 80MHz Channels	
100	5500	√	X				
102	5510			√	X		
104	5520	√					
106	5530					√	X
108	5540	√					
110	5550			√	X		
112	5560	√					
116	5580	√	X				
132	5660	√					
134	5670			√			
136	5680	√					
138	5690					√	X
140	5700	√					
142	5710			√	X		
144	5720	√	X				

List of channels:

√ - available

X - tested



2.2 Related Submittal(s) Grants

None.

2.3 Test Methodology

Antenna conducted measurements were performed according to the FCC documents “Guidelines for Compliance Testing of Unlicensed National Information Infrastructure (U-NII) Devices Part 15, Subpart E” (789033 D02 General U-NII Test Procedures New Rules).

Both AC mains line-conducted and radiated emissions measurements were performed according to the procedures in ANSI C63.4. Radiated tests were performed at an antenna to EUT distance of 3 meters, unless stated otherwise in the "**Data Sheet**" of this Application.

All other measurements were made in accordance with the procedures in part 2 of CFR 47.

2.4 Test Facility

The test site used to collect the radiated data is site 1 (10-m semi-anechoic chamber). This test facility and site measurement data have been fully placed on file with the FCC, IC and A2LA accredited.

2.5 Measurement Uncertainty

Compliance with the limits was based on the results of the measurements and doesn't take into account the measurement uncertainty.

Estimated Measurement Uncertainty

Measurement	Expanded Uncertainty (k=2)		
	0.15 MHz – 1 GHz	1 GHz – 6 GHz	> 6 GHz
RF Power and Power Density – antenna conducted	1.1 dB	1.5 dB	–
Unwanted emissions - antenna conducted	1.2 dB	1.7 dB	2.0 dB
Bandwidth – antenna conducted	50 Hz	100 Hz	–
Radiated emissions	4.2 dB	5.4 dB	
AC mains conducted emissions	2.4 dB	-	-

3.0 System Test Configuration

3.1 Support Equipment

Description	Manufacturer	Model No./ Part No.
Laptop	Dell	Inspiron 14

3.2 Block Diagram of Test Setup

Antenna was removed and co-axial connector with a cable was installed for Conducted Measurements.
500ohm Load was used for Radiated Measurements.

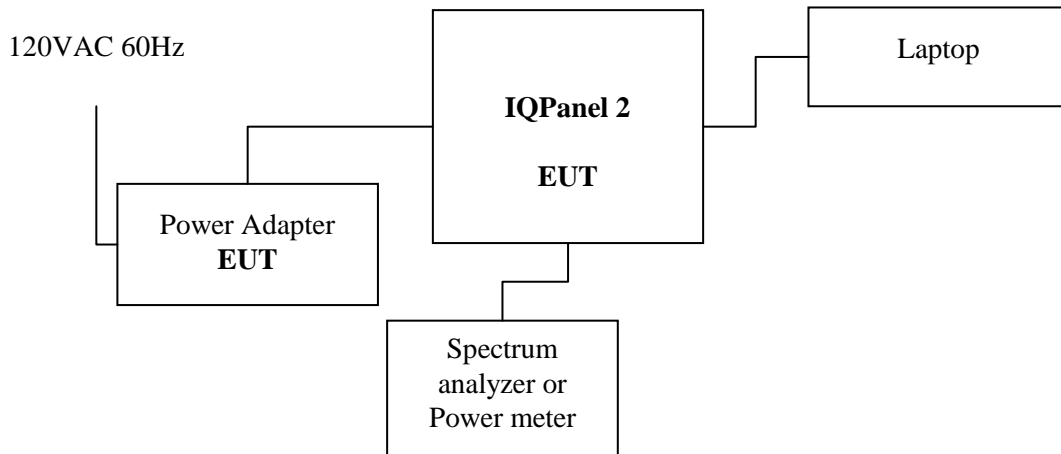

Note: Power Adapter: Manufacturer: Sure Power; Model: SW-050200A

S = Shielded	F = With Ferrite
U = Unshielded	m = Meter

3.3 Justification

Preliminary testing was performed for all modulation/data rate modes. The following modes, in which the highest power was detected, were selected for final measurements:

OFDM, 6MB/s – for 802.11a
OFDM, MCS0 – for 802.11n/ac 20MHz
OFDM, MCS0 – for 802.11n/ac 40MHz
OFDM, MCS0 – for 802.11ac 80MHz

The difference between the models: IQPANEL2, IQPANEL2-ZW, IQPANEL2-ZB, IQPANEL2-ZZ are as below:

Model: IQPANEL2: Home Security Panel consists of WiFi/BT/LTE radios and SRF receiver.

Model: IQPANEL2-ZW: model: IQPANEL2 with approved module having FCC ID: 2AAJXQS-ZWAVE and IC: 11205A-QSZWAVE.

Model: IQPANEL2-ZB: model: IQPANEL2 with approved module having FCC ID: 2AAJXQS-IS and IC: 11205A-QSIS.

Model: IQPANEL2-ZZ: model: IQPANEL2 with approved modules having FCC ID: 2AAJXQS-IS, FCC ID: 2AAJXQS-ZWAVE, IC: 11205A-QSIS and IC: 11205A-QSZWAVE.

All tests were performed on the fully populated Model: IQPANEL2-ZZ. The results in this report are valid for the other models IQPANEL2, IQPANEL2-ZW and IQPANEL2-ZB as well.

3.4 Mode of Operation During Test

During transmitter testing, the transmitter was setup to transmit continuously at maximum RF power on low, middle and high channels.

Frequency (MHz)	Channel	802.11a	802.11n 20 MHz	802.11n 40 MHz	802.11ac 80 MHz
100	5500	17	17	14	-
106	5530	-	-	-	14
110	5550	-	-	19	-
116	5580	19	19	-	-
138	5690	-	-	-	15
142	5710	-	-	15	-
144	5720	15	15	-	-

3.5 Modifications required for Compliance

Intertek installed no modifications during compliance testing in order to bring the product into compliance.

3.6 Additions, deviations and exclusions from standards

No additions, deviations or exclusion have been made from standard.

4.0 Measurement Results

4.1 Emission Bandwidth and 99% Occupied Bandwidth

15.407(a)(1)(2)

4.1.1 Procedure

The Procedure, described in the FCC Publication 789033 D02 General U-NII Test Procedures New Rules, was used. Specifically Section C for Emission Bandwidth and Minimum Emission Bandwidth for the band 5.725-5.850 GHz. Section D was used for 99% Occupied Bandwidth.

The antenna port of the EUT was connected to the input of a spectrum analyzer (SA). For each RF output channel investigated, the spectrum analyzer center frequency was set to the channel carrier.

The Occupied bandwidth was measured using the build-in spectrum analyzer facility for 99% power bandwidth measurement.

Tested By:	Anderson Soungpanya
Test Date:	February 18 and 21, 2016



4.1.2 Test Result

Refer to the following plots for the test result:

Mode	Channel	Frequency, MHz	26-dB Bandwidth, MHz	Occupied Bandwidth, MHz	Plot #
802.11a	100	5500	22.44	17.19	1.1
	116	5580	22.94	17.41	1.2
	140	5720	22.20	17.25	1.3
802.11n 20MHz	100	5500	23.33	18.22	1.4
	116	5580	23.78	18.29	1.5
	140	5720	22.84	18.19	1.6
802.11n 40MHz	102	5510	44.49	36.34	1.7
	110	5550	43.85	36.38	1.8
	134	5710	43.33	36.38	1.9
802.11ac 80MHz	106	5530	84.36	74.80	1.10
	155	5690	84.62	74.72	1.11



Plot 1.1

802.11a 5500MHz

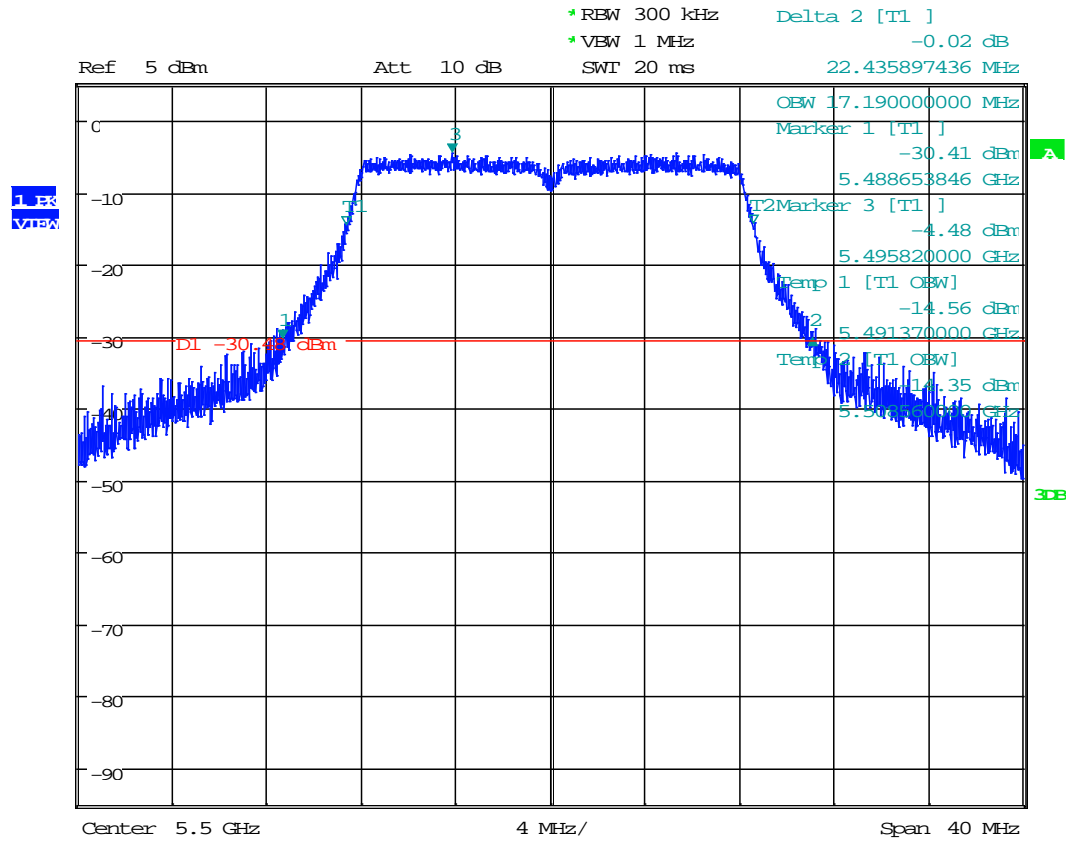

Date: 18.FEB.2016 02:09:32



Plot 1.2
802.11a 5580MHz

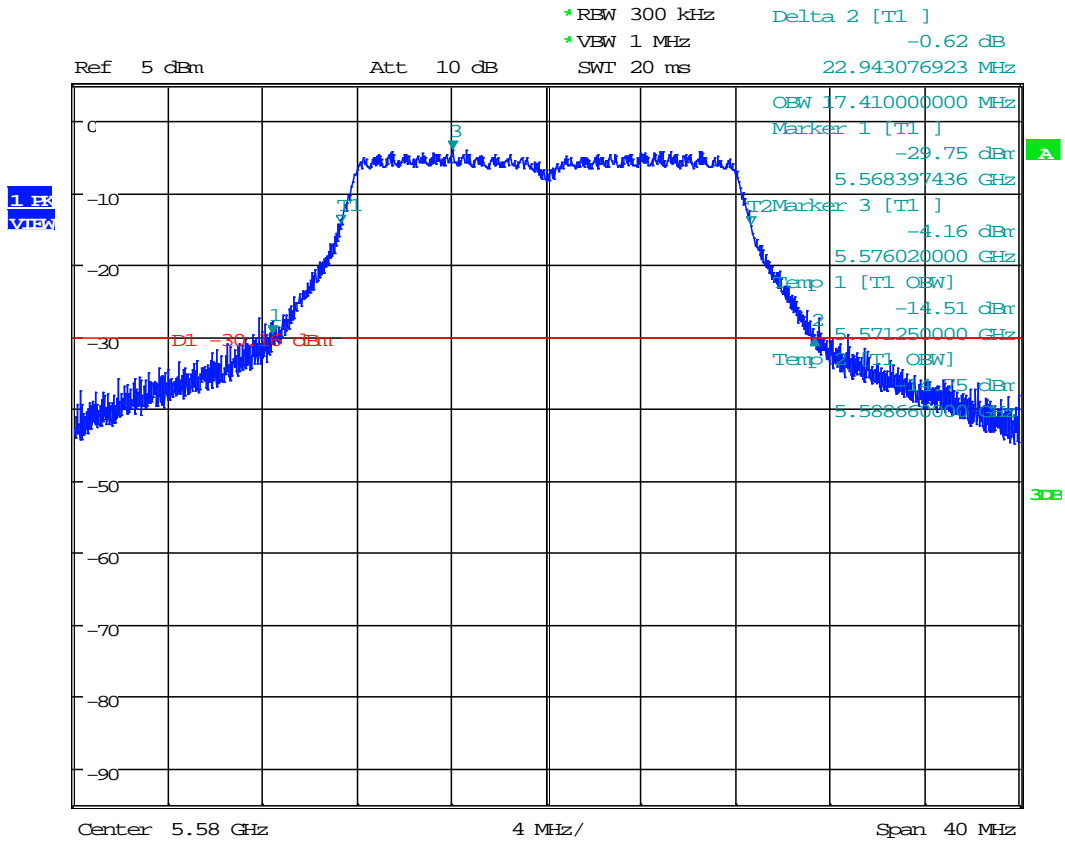

Date: 18.FEB.2016 03:12:28



Plot 1.3
802.11a 5700MHz

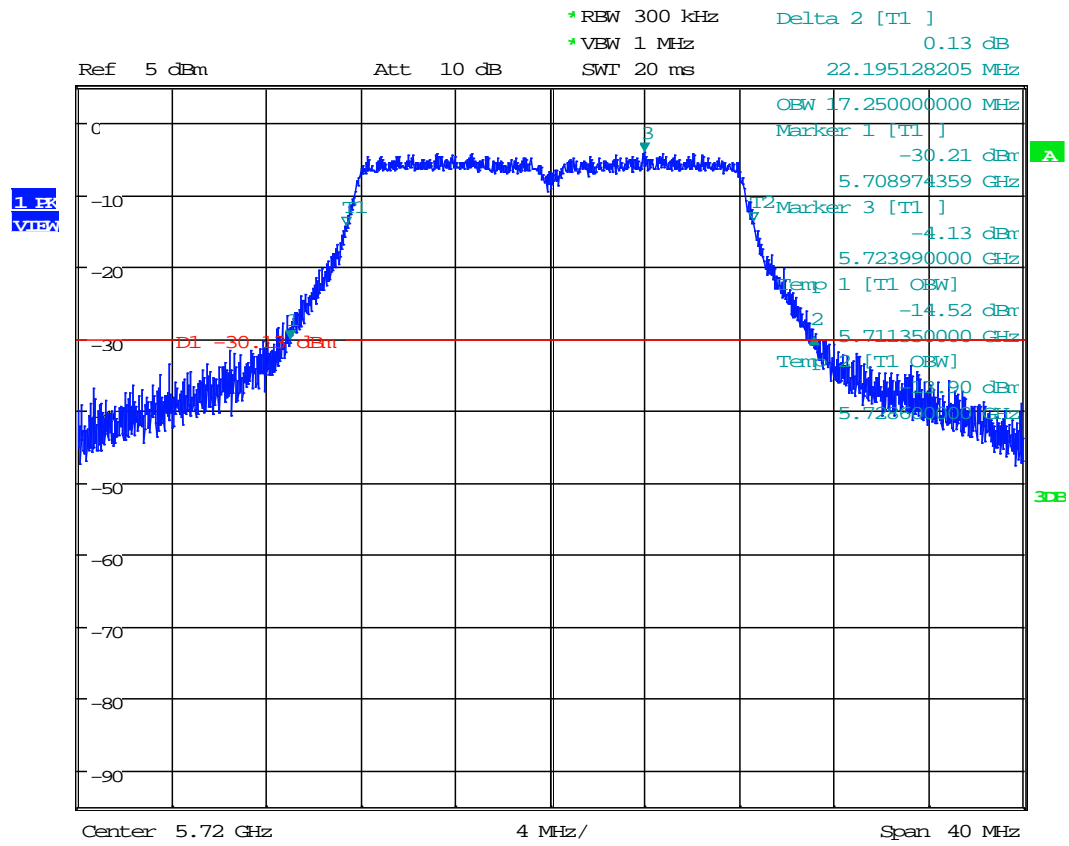

Date: 18.FEB.2016 03:28:54



Plot 1.4
802.11n 20MHz, 5500MHz

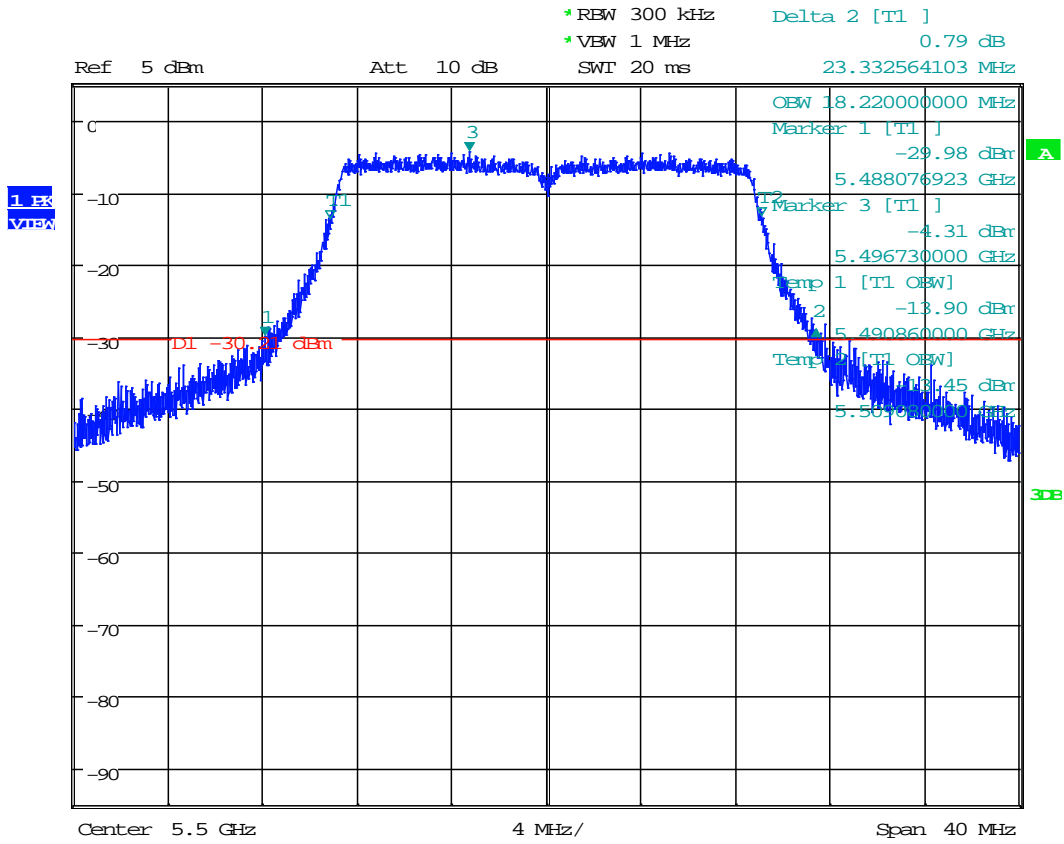

Date: 18.FEB.2016 02:12:28



Plot 1.5
802.11n 20MHz, 5580MHz

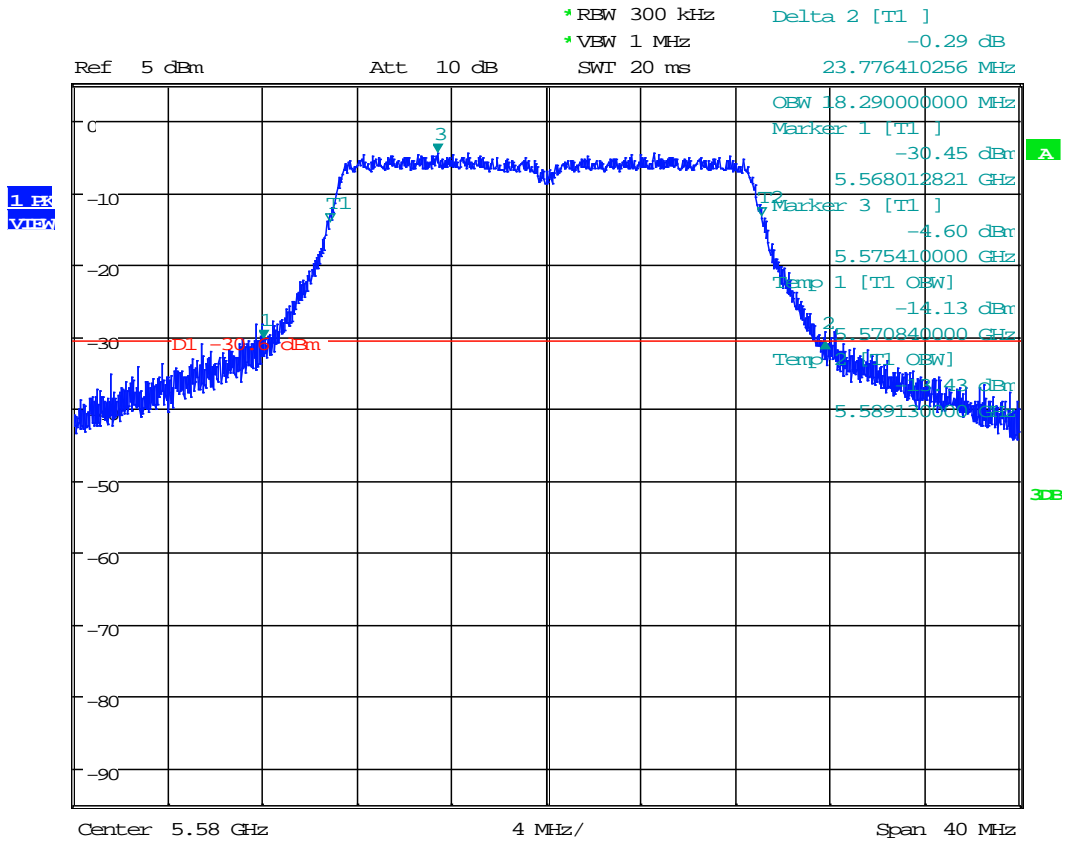

Date: 18.FEB.2016 03:15:47



Plot 1.6
802.11n 20MHz, 5720MHz

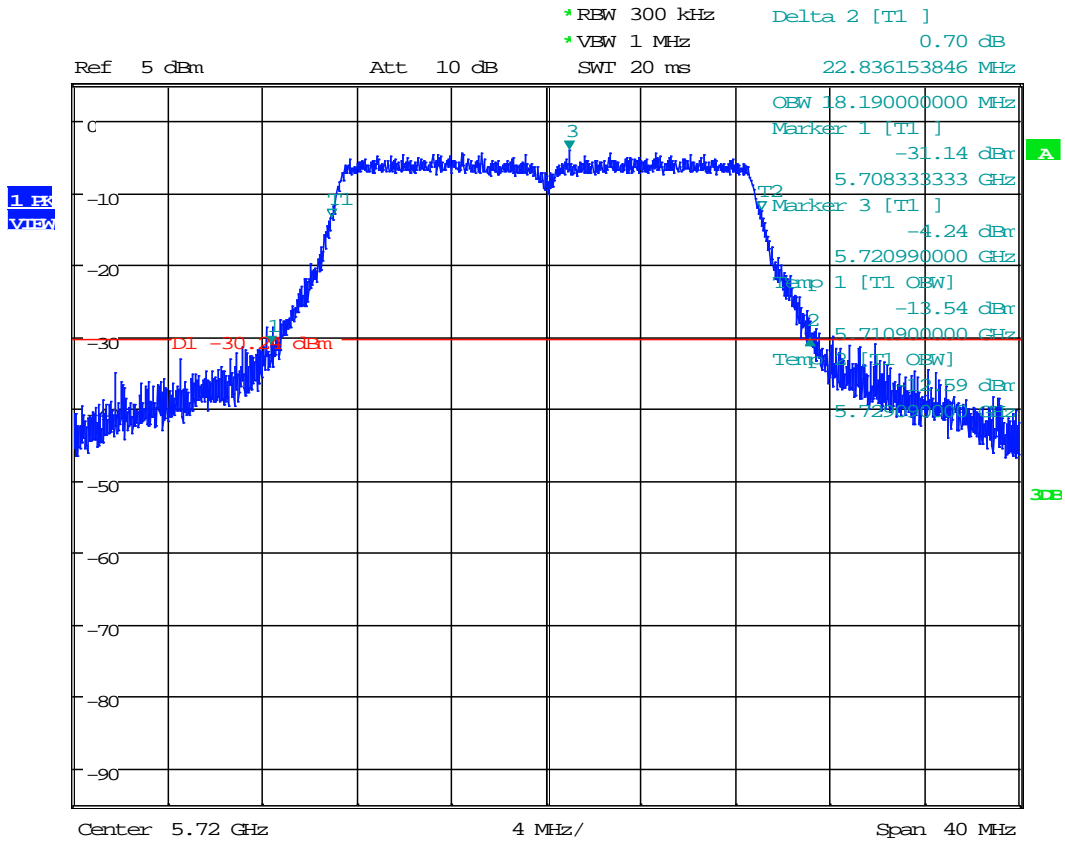

Date: 18.FEB.2016 03:31:08



Plot 1.7
802.11n 40MHz, 5510MHz

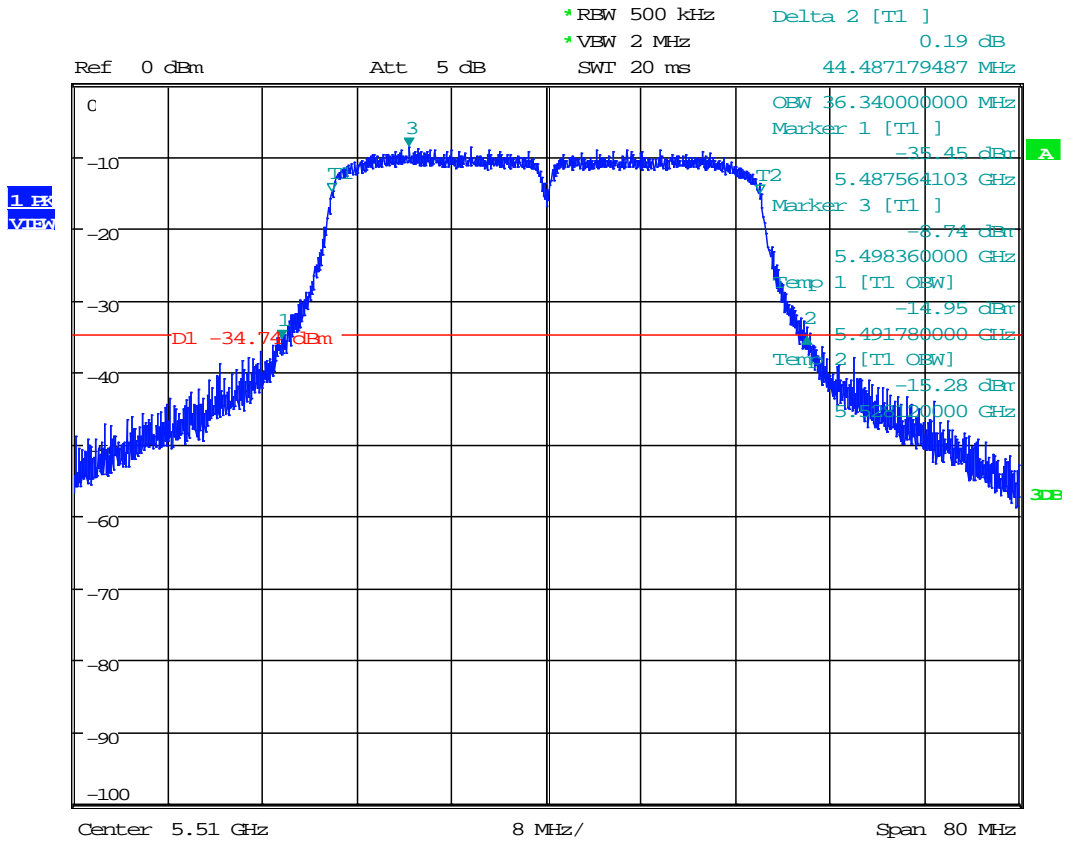

Date: 21.FEB.2016 01:18:33



Plot 1.8
802.11n 40MHz, 5550MHz

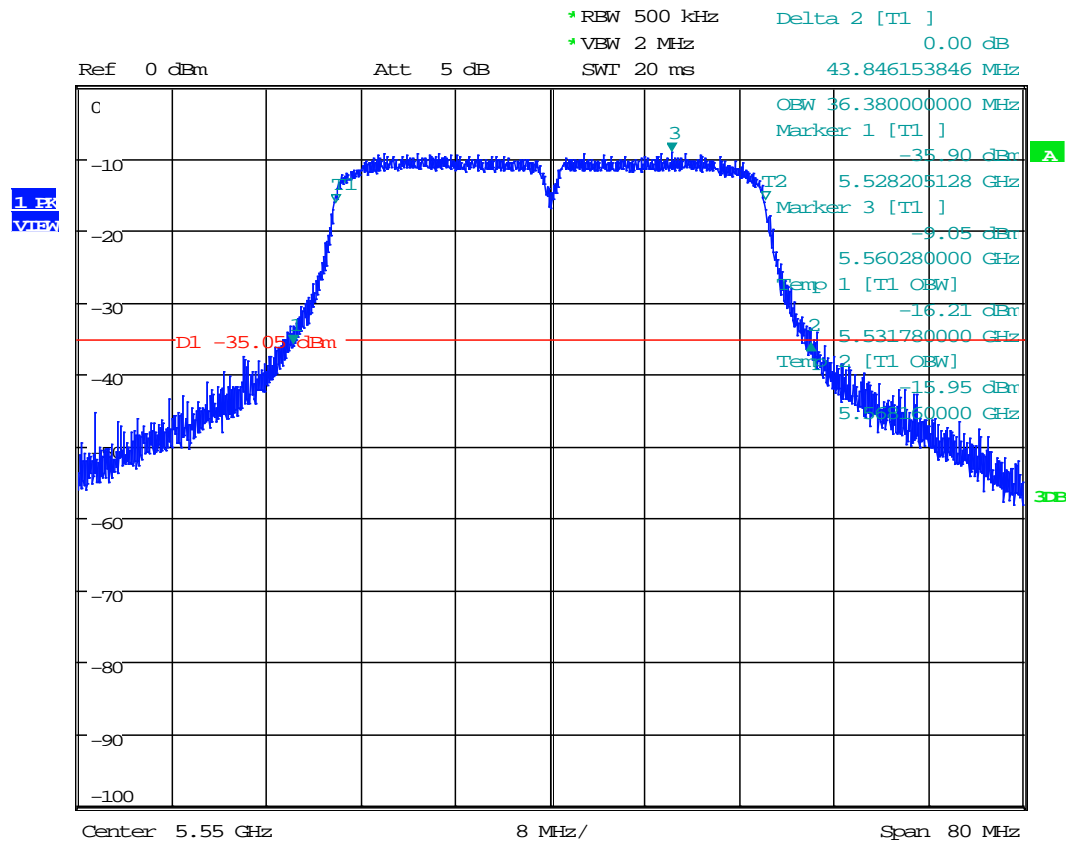

Date: 21.FEB.2016 01:20:35



Plot 1.9
802.11n 40MHz, 5710MHz

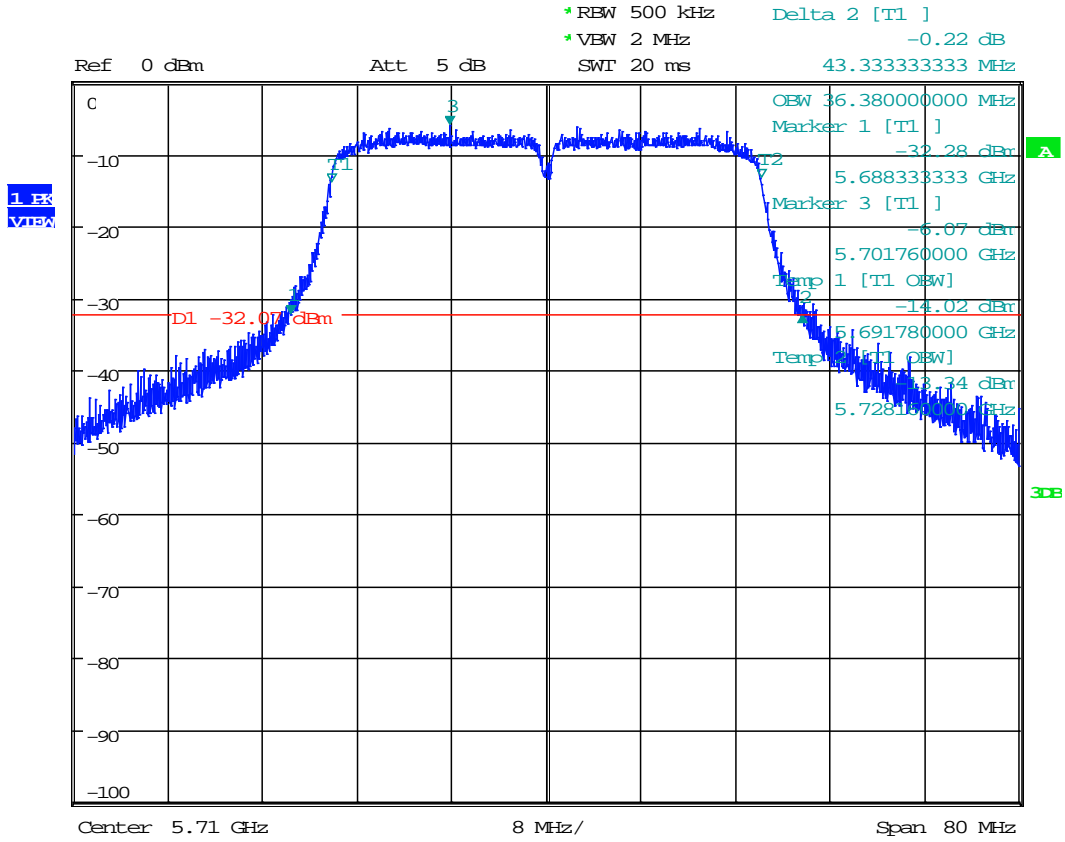

Date: 21.FEB.2016 01:25:37



Plot 1. 10
802.11ac 80MHz, 5530MHz

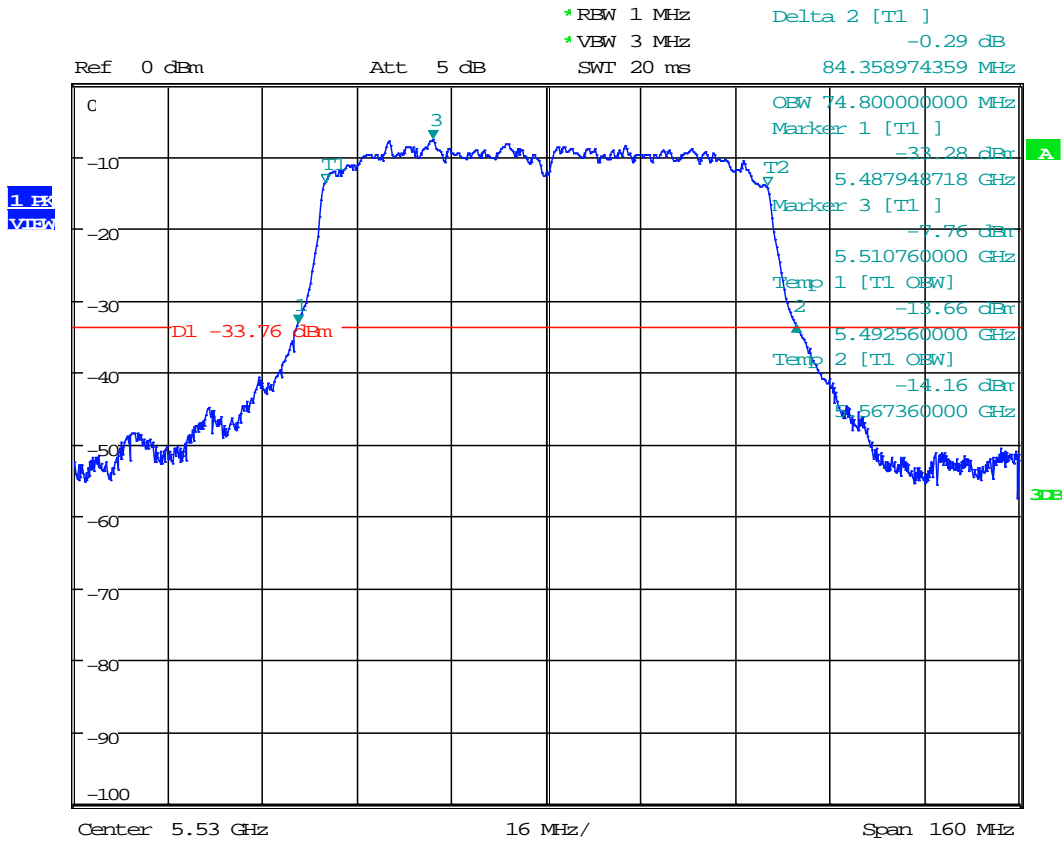

Date: 21.FEB.2016 01:38:21



Plot 1. 11
802.11ac 80MHz, 5690MHz

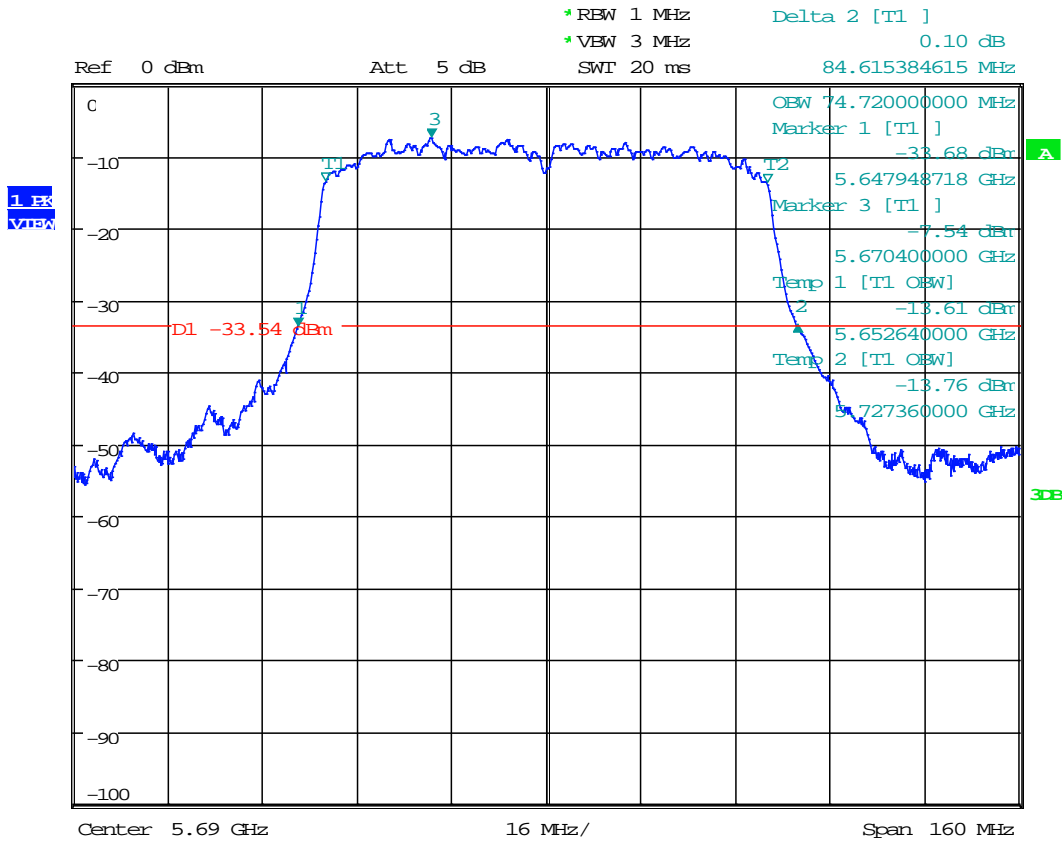

Date: 21.FEB.2016 01:40:48



4.2 Maximum Conducted Output Power
FCC Rule 15.407(a)(1)(iv)

4.2.1 Requirement

For the 5.25-5.35 GHz and 5.47-5.725 GHz bands, the maximum conducted output power over the frequency bands of operation shall not exceed the lesser of 250 mW or $11 \text{ dBm} + 10 \log B$, where B is the 26 dB emission bandwidth in megahertz. In addition, the maximum power spectral density shall not exceed 11 dBm in any 1 megahertz band. If transmitting antennas of directional gain greater than 6 dBi are used, both the maximum conducted output power and the maximum power spectral density shall be reduced by the amount in dB that the directional gain of the antenna exceeds 6 dBi.

4.2.2 Procedure

The Procedure, described in the FCC Publication 789033 D02 General U-NII Test Procedures New Rules, was used. Specifically Section E (2) (b) Method SA-1 for Maximum Conducted Output Power.

The antenna port output of the EUT was connected to the input of a spectrum analyzer to measure the Maximum Conducted Transmitter Output Power.

Tested By:	Anderson Soungpanya
Test Date:	February 22-23, 2016



4.2.3 Test Results

Refer to the following plots for the test result:

Mode	Channel	Frequency, MHz	Conducted power (average) dBm	Conducted power Limit dBm	Plot #
802.11a	100	5500	16.14	24	2.1
	116	5580	17.96	24	2.2
	140	5720	17.71	24	2.3
802.11n 20MHz	100	5500	16.13	24	2.4
	116	5580	17.96	24	2.5
	140	5720	17.73	24	2.6
802.11n 40MHz	102	5510	11.60	24	2.7
	110	5550	16.52	24	2.8
	134	5710	16.08	24	2.9
802.11ac 80MHz	106	5530	11.36	24	2.10
	155	5690	12.13	24	2.11



Plot 2.1
802.11a, 5500MHz

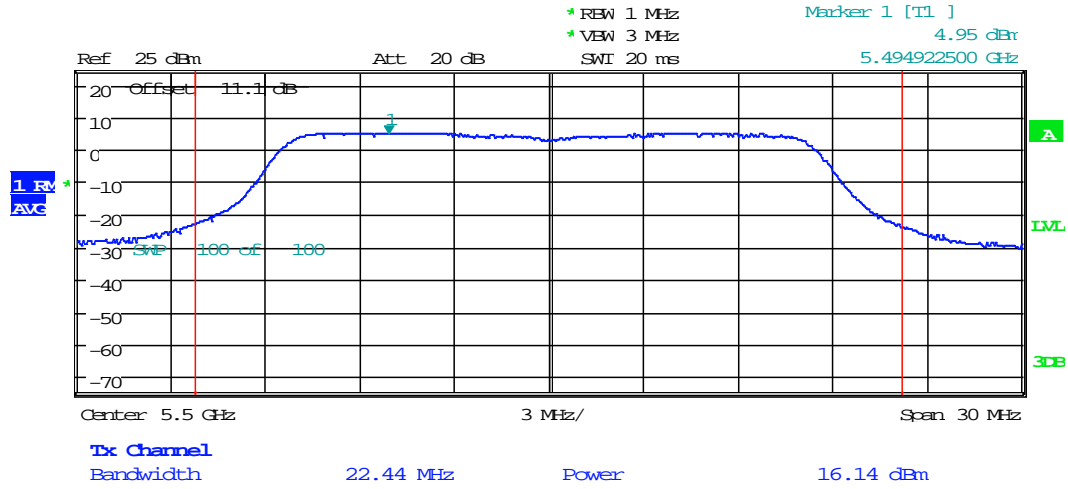

Date: 22.FEB.2016 11:38:02



Plot 2.2
802.11a, 5580MHz

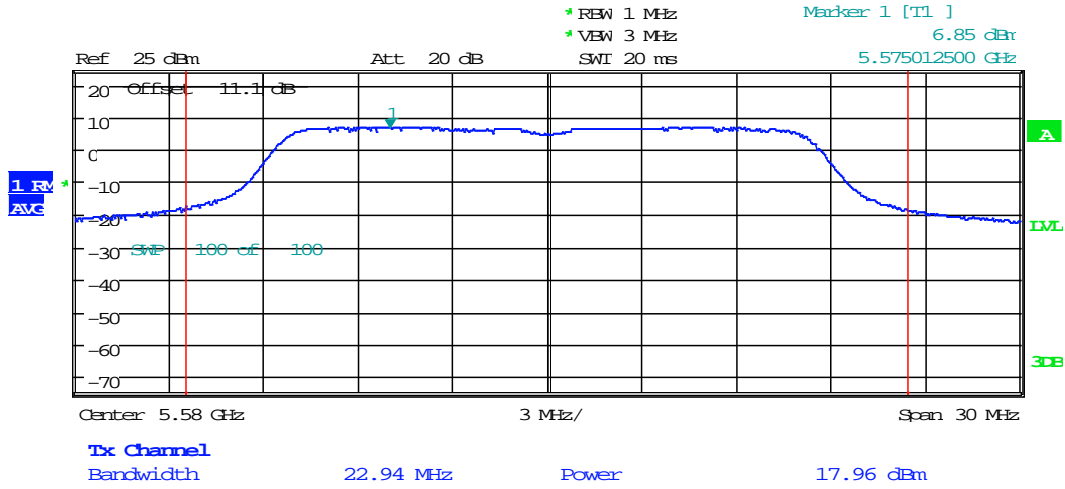

Date: 23.FEB.2016 07:56:56



Plot 2.3
802.11a, 5720MHz

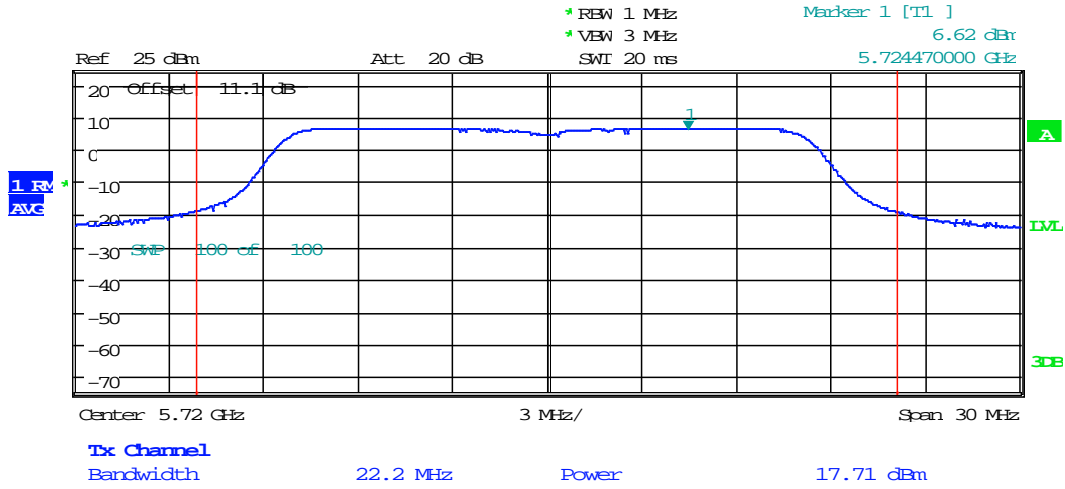

Date: 23.FEB.2016 08:04:24



Plot 2.4
802.11n 20MHz, 5500MHz

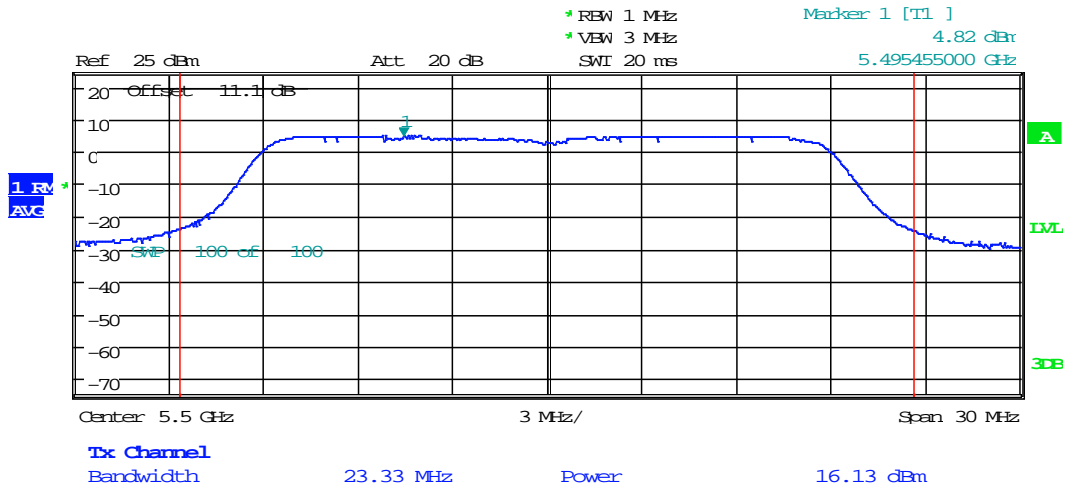

Date: 22.FEB.2016 11:39:40



Plot 2.5

H802.11n 20MHz, 5580MHz

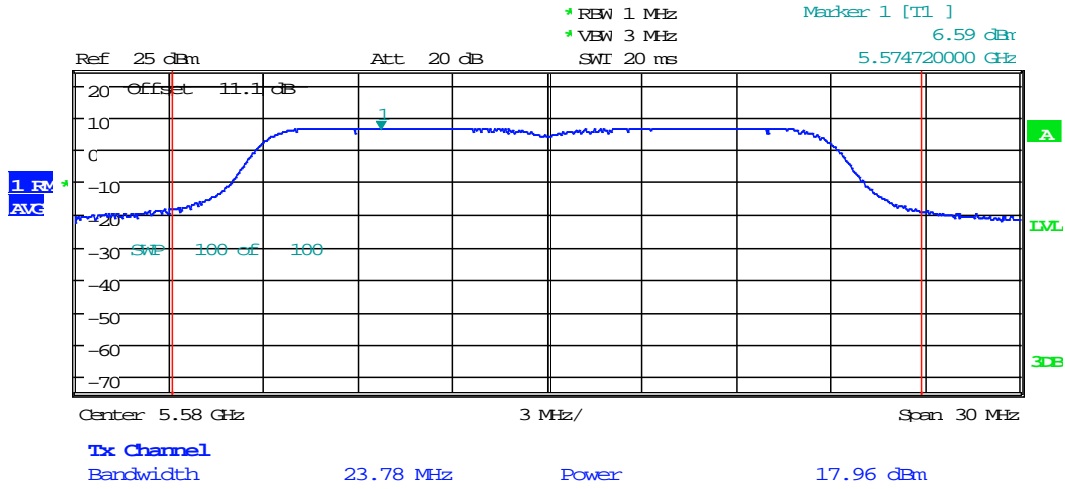

Date: 23.FEB.2016 07:58:07



Plot 2.6
802.11n 20MHz, 5720MHz

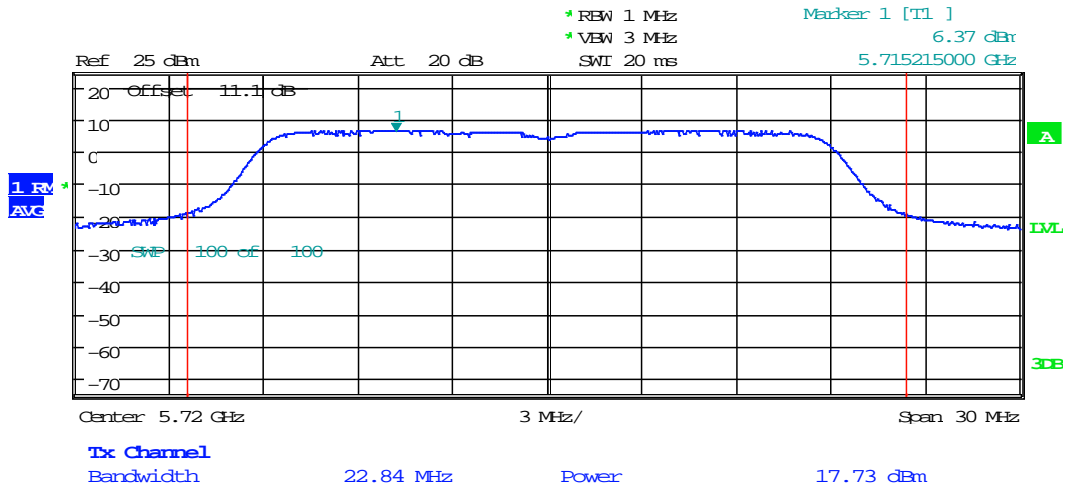

Date: 23.FEB.2016 08:05:16



Plot 2.7
802.11n 40MHz, 5510MHz

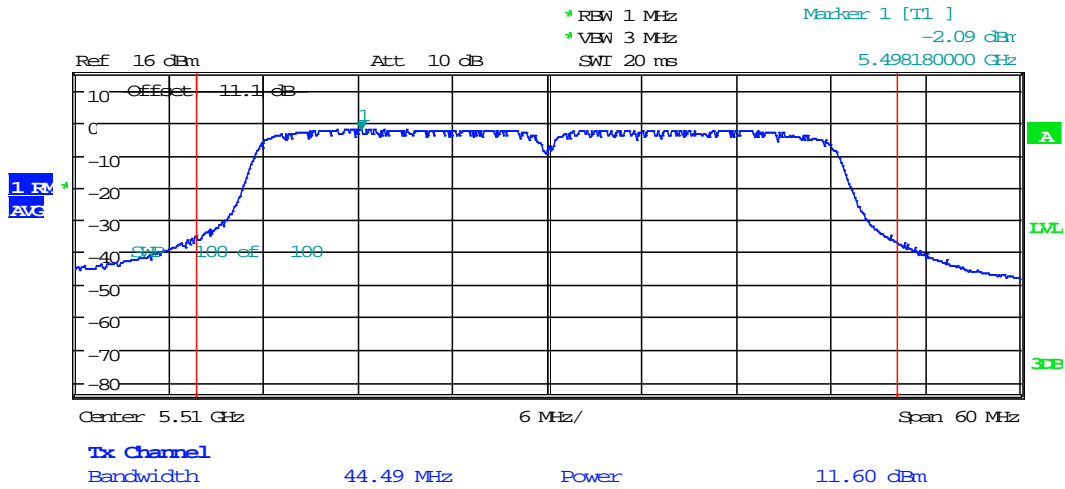

Date: 23.FEB.2016 09:51:21



Plot 2.8
802.11n 40MHz, 5550MHz

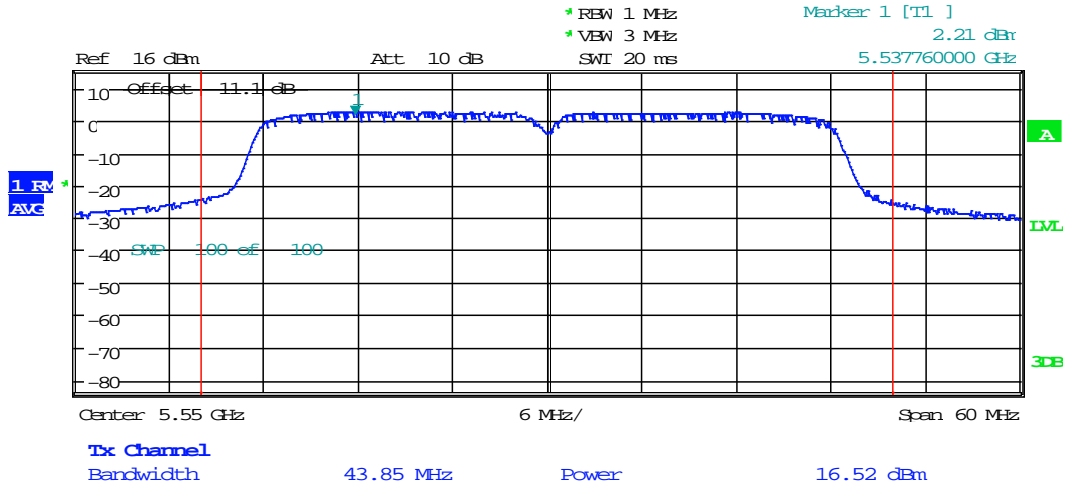

Date: 23.FEB.2016 09:52:40



Plot 2.9
802.11n 40MHz, 5710MHz

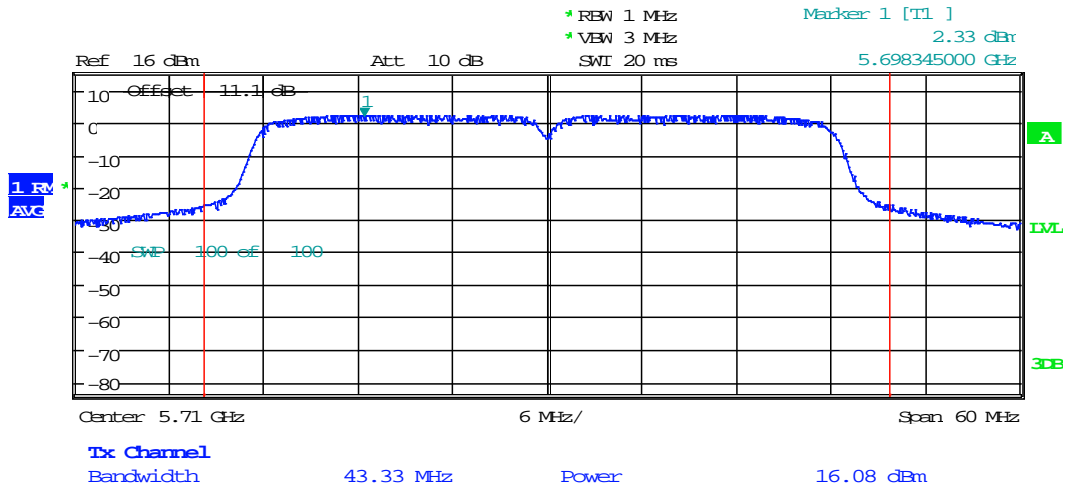

Date: 23.FEB.2016 09:56:09



Plot 2. 10
802.11ac 80MHz, 5530MHz

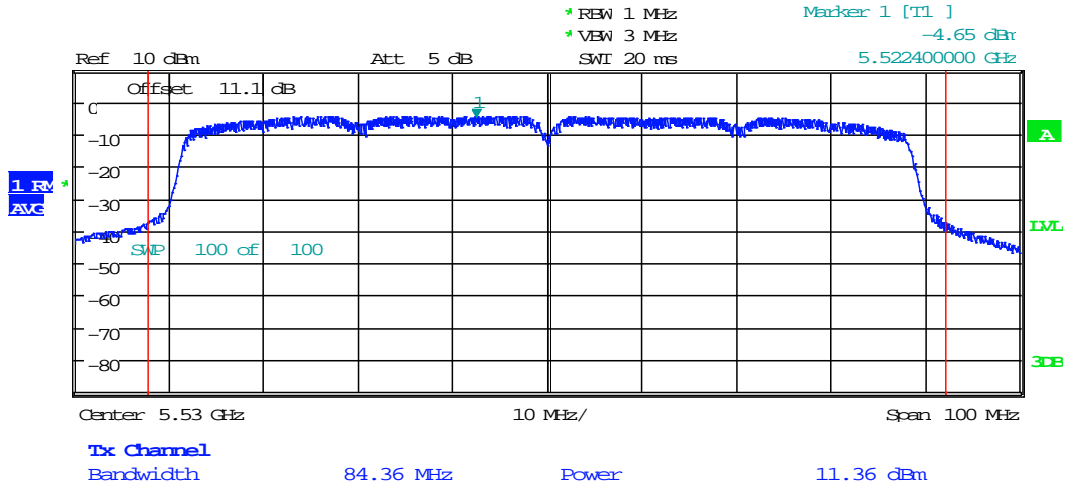

Date: 23.FEB.2016 10:09:50



Plot 2. 11
802.11ac 80MHz, 5690MHz

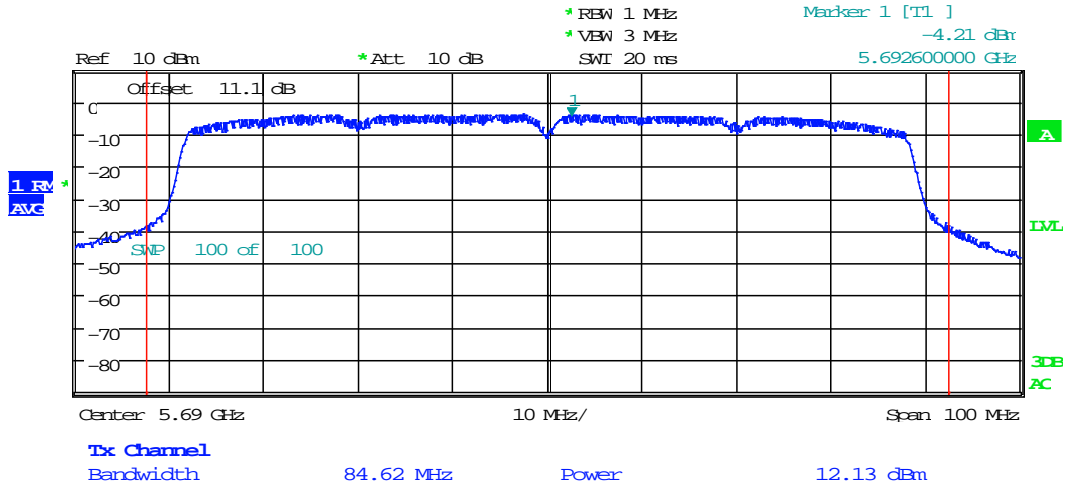

Date: 23.FEB.2016 10:21:58



4.3 Peak Power Spectral Density
FCC Rule 15.407(a)(1)(iv)

4.3.1 Requirement

For the 5.25-5.35 GHz and 5.47-5.725 GHz bands, the maximum conducted output power over the frequency bands of operation shall not exceed the lesser of 250 mW or $11 \text{ dBm} + 10 \log B$, where B is the 26 dB emission bandwidth in megahertz. In addition, the maximum power spectral density shall not exceed 11 dBm in any 1 megahertz band. If transmitting antennas of directional gain greater than 6 dBi are used, both the maximum conducted output power and the maximum power spectral density shall be reduced by the amount in dB that the directional gain of the antenna exceeds 6 dBi.

4.3.2 Procedure

Each antenna port of the EUT was connected to the input of a spectrum analyzer to measure the Peak Power Spectral Density (PPSD) and recorded.

The Procedure, described in the FCC Publication 789033 D02 General U-NII Test Procedures New Rules v01r01, was used. Specifically procedure from Section F was utilized for Maximum Power Spectral Density (PSD).

Tested By:	Anderson Soungpanya
Test Date:	February 22-23, 2016



4.3.3 Test Result

Refer to the following plots located in section 4.2 for the test result:

Mode	Channel	Frequency, MHz	PSD(Peak) dBm	PSD Limit dBm	Plot #
802.11a	100	5500	4.95	11	2.1
	116	5580	6.85	11	2.2
	140	5720	6.62	11	2.3
802.11n 20MHz	100	5500	4.82	11	2.4
	116	5580	6.59	11	2.5
	140	5720	6.37	11	2.6
802.11n 40MHz	102	5510	-2.09	11	2.7
	110	5550	2.21	11	2.8
	134	5710	2.33	11	2.9
802.11ac 80MHz	106	5530	-3.76	11	2.10
	155	5690	-4.21	11	2.11



4.4 Frequency stability
FCC 15.407(g)

4.4.1 Requirement

Manufacturers of U-NII devices are responsible for ensuring frequency stability such that an emission is maintained within the band of operation under all conditions of normal operation as specified in the user's manual.

4.4.2 Procedure

The EUT was placed in a temperature chamber and setup to transmit. Procedures for frequency stability in ANSIC63.10:2013 section 6.8 was utilized.

The carrier frequency was measured with the spectrum analyzer with resolution bandwidth of 1 kHz. The temperature was varied from -10°C to 55°C , as stated in the user manual.

The radio module in this report is powered by 120VAC which was varied to 85% and 115% for testing. Testing was performed at a temperature of 20°C .

After the temperature stabilized for approximately 20 minutes, the transmitting frequency was measured.

Tested By:	Anderson Soungpanya
Test Date:	February 16, 2016



4.4.3 Result

Temperature, °C	Frequency at nominal voltage, (GHz)	Maximum deviation from frequency at 20°C, ppm
Nominal Frequency: 5500 MHz		
55	5499.988233	0.528
50	5499.989422	0.312
40	5499.990420	0.130
30	5499.990547	0.107
20	5499.991137	0.000
10	5499.999112	1.450
0	5500.010471	3.515
-10	5500.032694	7.556
Voltage at 20°C	Frequency at nominal voltage, (GHz)	Maximum deviation from frequency at 20°C, ppm
120VAC – 15%	5499.991417	0.051
120VAC + 15%	5499.991284	0.027

Temperature, °C	Frequency at nominal voltage, (GHz)	Maximum deviation from frequency at 20°C, ppm
Nominal Frequency: 5720 MHz		
55	5719.987932	0.511
50	5719.989371	0.260
40	5719.990141	0.125
30	5719.990499	0.063
20	5719.990857	0.000
10	5720.000481	1.683
0	5720.023810	5.761
-10	5720.033940	7.532
Voltage at 20°C	Frequency at nominal voltage, (GHz)	Maximum deviation from frequency at 20°C, ppm
120VAC – 15%	5719.991031	0.030
120VAC + 15%	5719.991103	0.043

4.5 Transmitter Radiated Emissions
FCC Rule 15.407(b) (1-8) 15.209, 15.205

4.5.1 Requirement

(b) Undesirable emission limits. Except as shown in paragraph (b) (7) of this section, the maximum emissions outside of the frequency bands of operation shall be attenuated in accordance with the following limits:

- (1) For transmitters operating in the 5.15-5.25 GHz band: All emissions outside of the 5.15-5.35 GHz band shall not exceed an e.i.r.p. of -27 dBm/MHz.
- (2) For transmitters operating in the 5.25-5.35 GHz band: All emissions outside of the 5.15-5.35 GHz band shall not exceed an e.i.r.p. of -27 dBm/MHz.
- (3) For transmitters operating in the 5.47-5.725 GHz band: All emissions outside of the 5.47-5.725 GHz band shall not exceed an e.i.r.p. of -27 dBm/MHz.
- (4) For transmitters operating in the 5.725-5.85 GHz band: All emissions within the frequency range from the band edge to 10 MHz above or below the band edge shall not exceed an e.i.r.p. of -17 dBm/MHz; for frequencies 10 MHz or greater above or below the band edge, emissions shall not exceed an e.i.r.p. of -27 dBm/MHz.
- (5) The emission measurements shall be performed using a minimum resolution bandwidth of 1 MHz. A lower resolution bandwidth may be employed near the band edge, when necessary, provided the measured energy is integrated to show the total power over 1 MHz.
- (6) Unwanted emissions below 1 GHz must comply with the general field strength limits set forth in §15.209. Further, any U-NII devices using an AC power line are required to comply also with the conducted limits set forth in §15.207.
- (7) The provisions of §15.205 apply to intentional radiators operating under this section.
- (8) When measuring the emission limits, the nominal carrier frequency shall be adjusted as close to the upper and lower frequency band edges as the design of the equipment permits.

Emissions which fall in the restricted bands, as defined in §15.205(a), must comply with the radiated emission limits specified in §15.209(a) (see §15.205(c)).

For transmitters operating in the 5.15–5.25 GHz band: all emissions outside of the 5.15–5.35 GHz band shall not exceed an EIRP of -27 dBm/MHz.

Note: This corresponds to the field strength level of 68.3 dB(μ V/m) at 3 m distance when measure with 1 MHz resolution bandwidth.

4.5.2 Procedure

Radiated emission measurements were performed from 30 MHz to 40 GHz according to the procedure described in ANSI C64.10. Spectrum Analyzer Resolution Bandwidth is 100 kHz or greater for frequencies 30 MHz to 1000 MHz, 1 MHz for frequencies above 1000 MHz. Above 1000 MHz Peak and Average measurements were performed.

The EUT is placed on a plastic turntable that is 80 cm in height for below 1000MHz and 1.5m in height for above 1GHz. If the EUT attaches to peripherals, they are connected and operational (as typical as possible). During testing, all cables were manipulated to produce worst-case emissions. The signal is maximized through rotation. The antenna height and polarization are varied during the search for maximum signal level. The antenna height is varied from 1 to 4 meters.

Radiated emissions are taken at 3 meters for frequencies above 1 GHz and at 10 meters for frequencies below 1 GHz.

Measurements made from 30 MHz to 40 GHz were measured with 50 ohm terminator on the output of the EUT RF port. A preamp was used from 30MHz to 40GHz.

All measurements were made with a Peak Detector and compared to QP limits for 30MHz – 1GHz and Average limits for 1GHz – 40 GHz.

Data is included of the worst-case configuration (the configuration which resulted in the highest emission levels).

EUT utilizes the Use of IEEE 802.11 Channels that straddles the U-NII-2C and U-NII-3 band at 5725 MHz

IEEE 802.11ac specifies channels that straddle the U-NII-2C and U-NII-3 bands at 5725 MHz (i.e., Ch. 138, 80 MHz BW; Ch. 142, 40 MHz BW; Ch. 144, 20 MHz BW). Use of these channels is permitted, but the channels must comply with the U-NII rules. This provision is applicable for the U-NII-2C band operating under the Old Rules and the New Rules, and for those devices with the U-NII-3 band extensions of § 15.407 (per FCC 15-61 and FCC 15-163). Specifically, these channels must be tested for conducted power and power spectral density under the U-NII rules. In addition, the channels must comply with the Transmit Power Control (TPC) requirements of § 15.407(h) along with all DFS requirements. When these channels are used, there are no band edge requirements at 5725 MHz.

4.5.3 Field Strength Calculation

Field Strength Calculation

The field strength is calculated by adding the Antenna Factor and Cable Factor, and subtracting the Amplifier Gain (if any) from the measured reading. The basic equation with a sample calculation is as follows:

$FS = RA + AF + CF - AG$; if measurement is performed at a distance other than specified in the rule, a Distance Correction Factor (DCF) shall be added.

Where FS = Field Strength in dB(μ V/m)

RA = Receiver Amplitude (including preamplifier) in dB(μ V); AF = Antenna Factor in dB(1/m)

CF = Cable Attenuation Factor in dB; AG = Amplifier Gain in dB

Assume a receiver reading of 52.0 dB(μ V) is obtained. The antennas factor of 7.4 dB(1/m) and cable factor of 1.6 dB is added. The amplifier gain of 29 dB is subtracted, giving field strength of 32 dB(μ V/m). This value in dB(μ V/m) was converted to its corresponding level in μ V/m.

RA = 52.0 dB(μ V)

AF = 7.4 dB(1/m)

CF = 1.6 dB

AG = 29.0 dB

$FS = 52.0 + 7.4 + 1.6 - 29.0 = 32$ dB(μ V/m).

Level in μ V/m = Common Antilogarithm [(32 dB μ V/m)/20] = 39.8 μ V/m.

4.5.4 Antenna-port conducted measurements

Antenna-port conducted measurements may also be used as an alternative to radiated measurements for demonstrating compliance in the restricted frequency bands. If conducted measurements are performed, then proper impedance matching must be ensured and an additional radiated test for cabinet/case spurious emissions is required.

4.5.6 General Procedure for conducted measurements in restricted bands

- a) Measure the conducted output power (in dBm) using the detector specified for determining quasi-peak, peak, and average conducted output power, respectively.
- b) Add the maximum transmit antenna gain (in dBi) to the measured output power level to determine the EIRP level (see 12.2.5 for guidance on determining the applicable antenna gain)
- c) Add the appropriate maximum ground reflection factor to the EIRP level (6 dB for frequencies \leq 30 MHz, 4.7 dB for frequencies between 30 MHz and 1000 MHz, inclusive and 0 dB for frequencies $>$ 1000 MHz).
- d) For devices with multiple antenna-ports, measure the power of each individual chain and sum the EIRP of all chains in linear terms (*e.g.*, Watts, mW).
- e) Convert the resultant EIRP level to an equivalent electric field strength using the following relationship:
 $E = \text{EIRP} - 20\log D + 104.8$
where:
E = electric field strength in dB μ V/m,
EIRP = equivalent isotropic radiated power in dBm
D = specified measurement distance in meters.
- f) Compare the resultant electric field strength level to the applicable limit.
- g) Perform radiated spurious emission test

4.5.7 Test Results

The data on the following pages list the significant emission frequencies, the limit and the margin of compliance where emissions are within 3dB of the limit.

All conducted antenna port plots are corrected with the consideration of a 4.51 dBi Antenna Gain.

Radiated emission measurements were performed up to 40GHz. No Emissions were identified when scanned from 18-40 GHz.

Test Results: 15.209/15.205 Restricted Band Emissions at Antenna Port

Tested By:	Anderson Soungpanya
Test Date:	February 18-19, 2016

Out-of-Band Spurious Emissions at the Band Edge - 802.11a, 5500 MHz

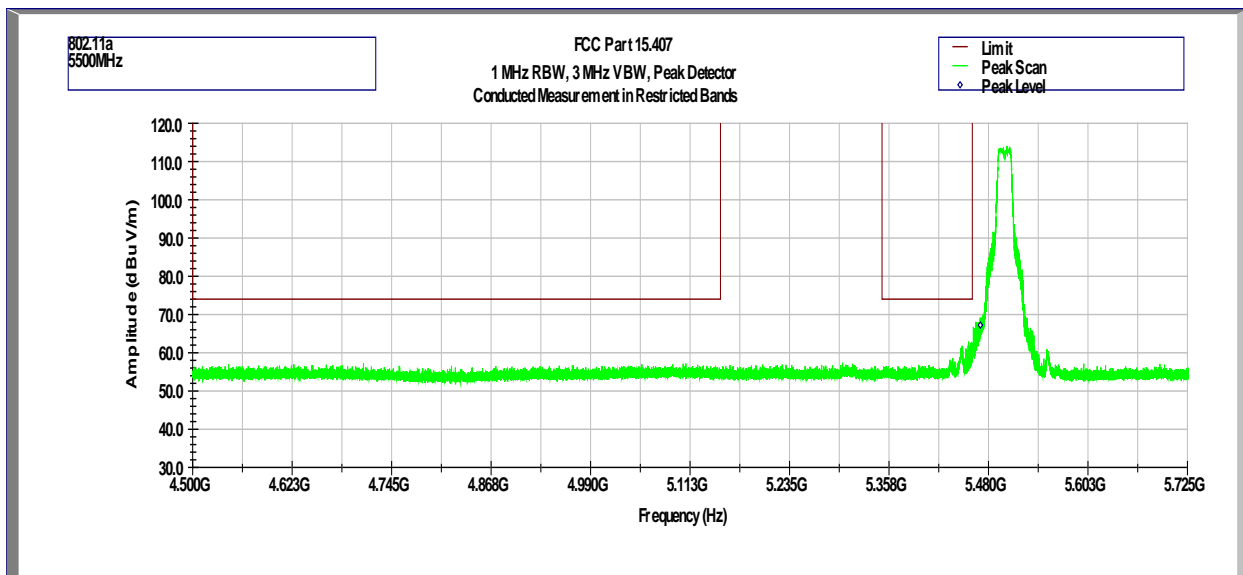
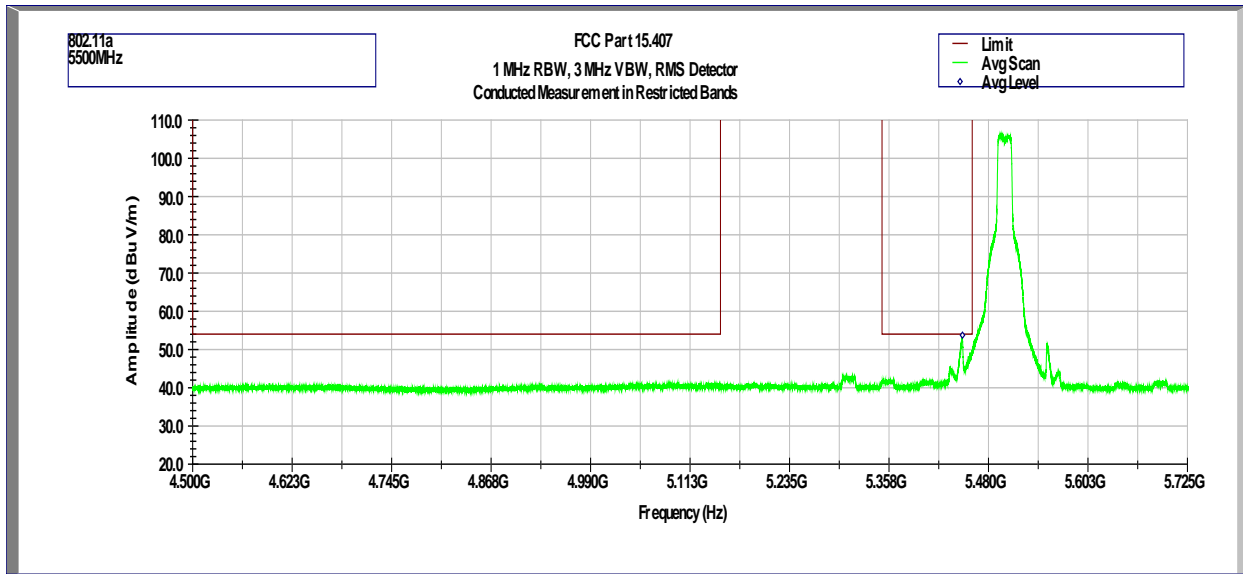

Frequency	Corrected Amplitude	Limit	Margin	Detector	Results
GHz	dB μ V/m	dB μ V/m	dB		
5.448	53.7	54	-0.3	Avg	Pass
5.470	67.2	68.2	-1.0	Peak	Pass

Out-of-Band Spurious Emissions at the Band Edge - 802.11n 20MHz, 5500 MHz

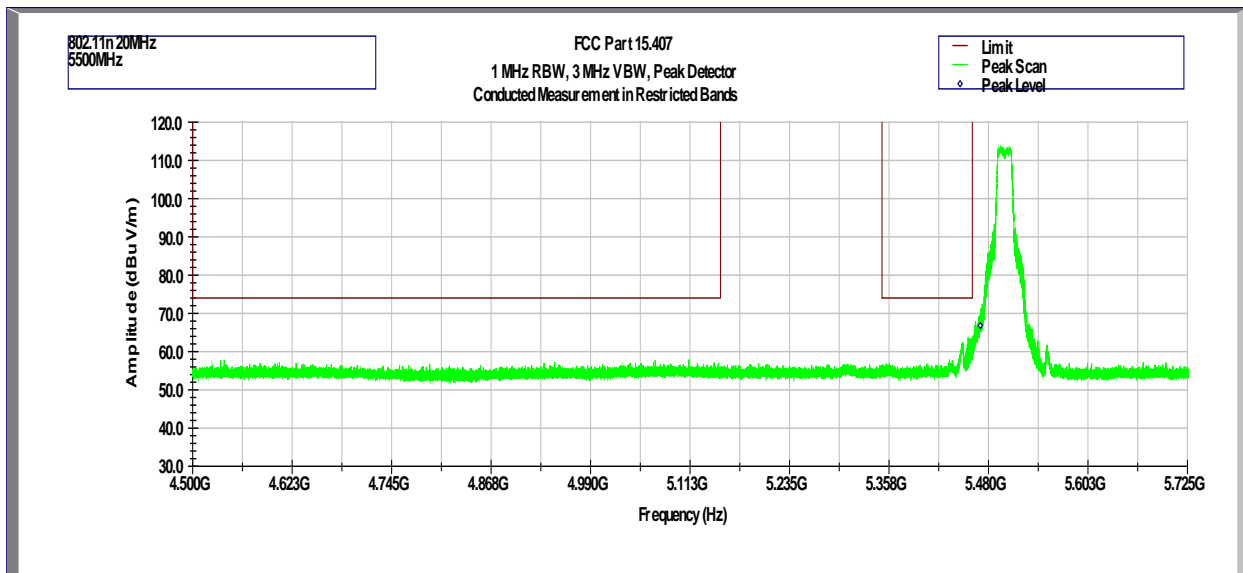
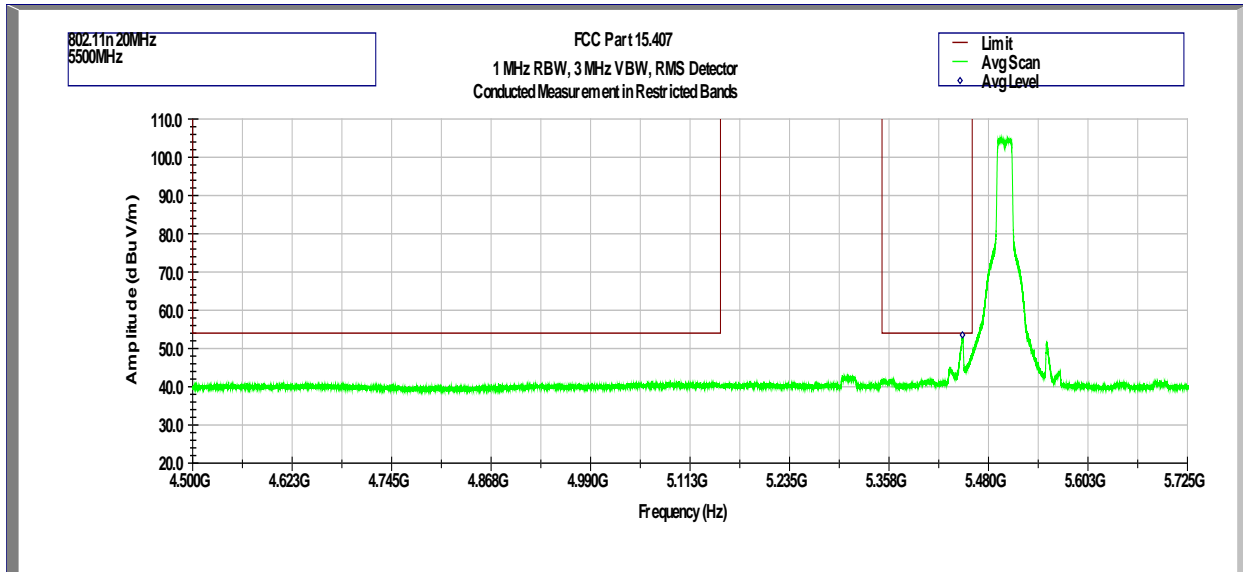

Frequency	Corrected Amplitude	Limit	Margin	Detector	Results
GHz	dB μ V/m	dB μ V/m	dB		
5.448	53.5	54	-0.5	Avg	Pass
5.470	66.8	68.2	-1.4	Peak	Pass

Out-of-Band Spurious Emissions at the Band Edge - 802.11n 40MHz, 5510 MHz

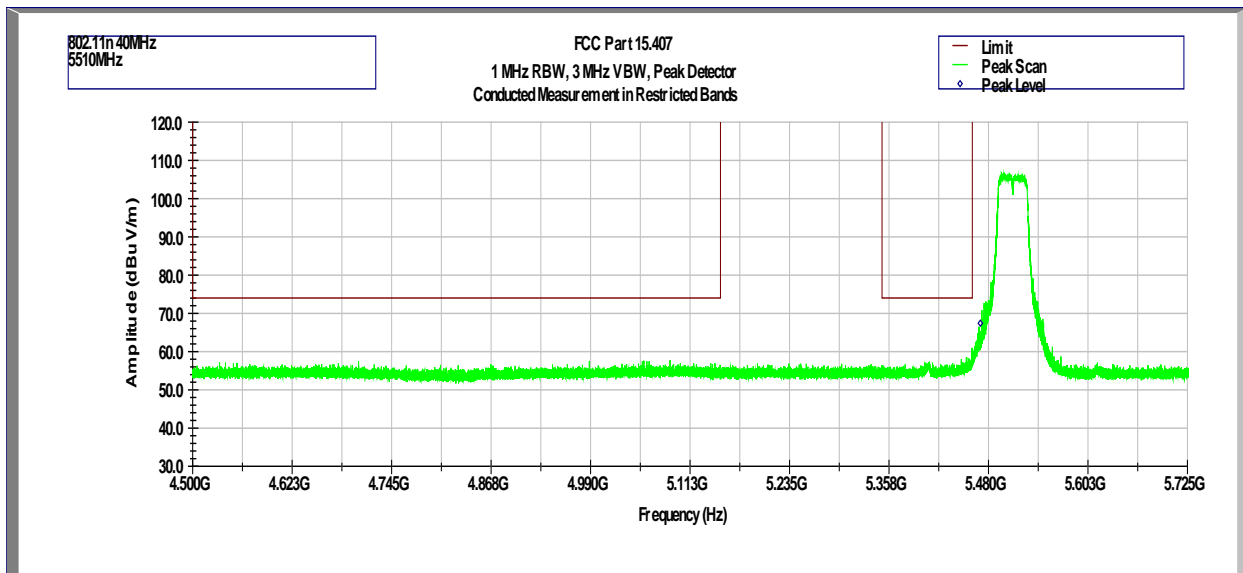
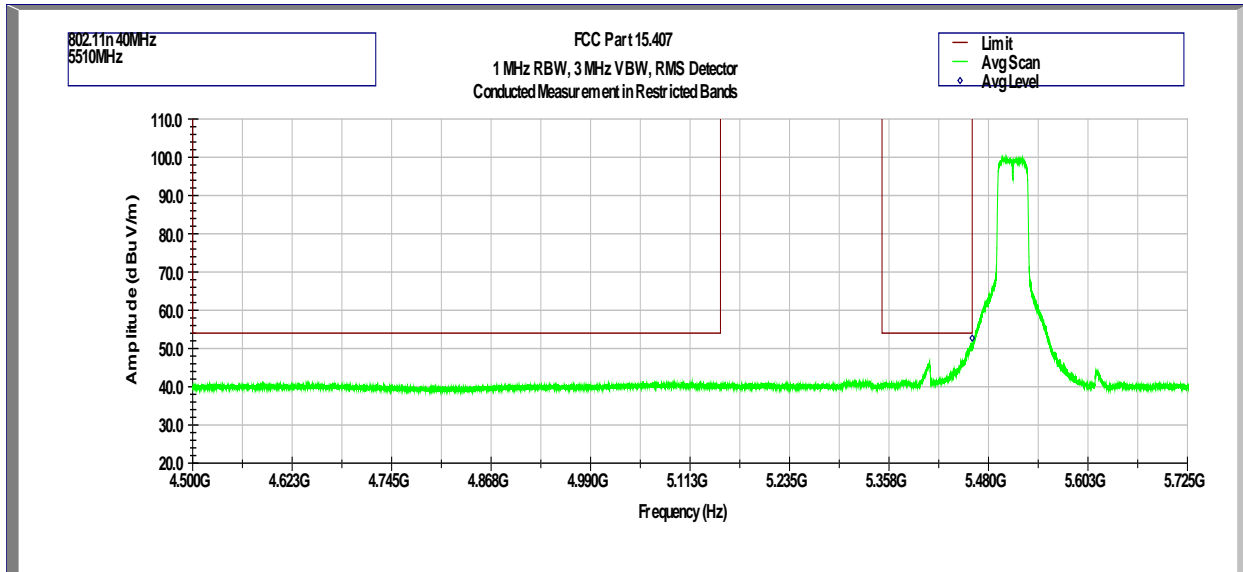

Frequency	Corrected Amplitude	Limit	Margin	Detector	Results
GHz	dB μ V/m	dB μ V/m	dB		
5.460	52.7	54	1.3	Avg	Pass
5.470	67.4	68.2	-0.8	Peak	Pass

Out-of-Band Spurious Emissions at the Band Edge - 802.11ac 80MHz, 5530 MHz

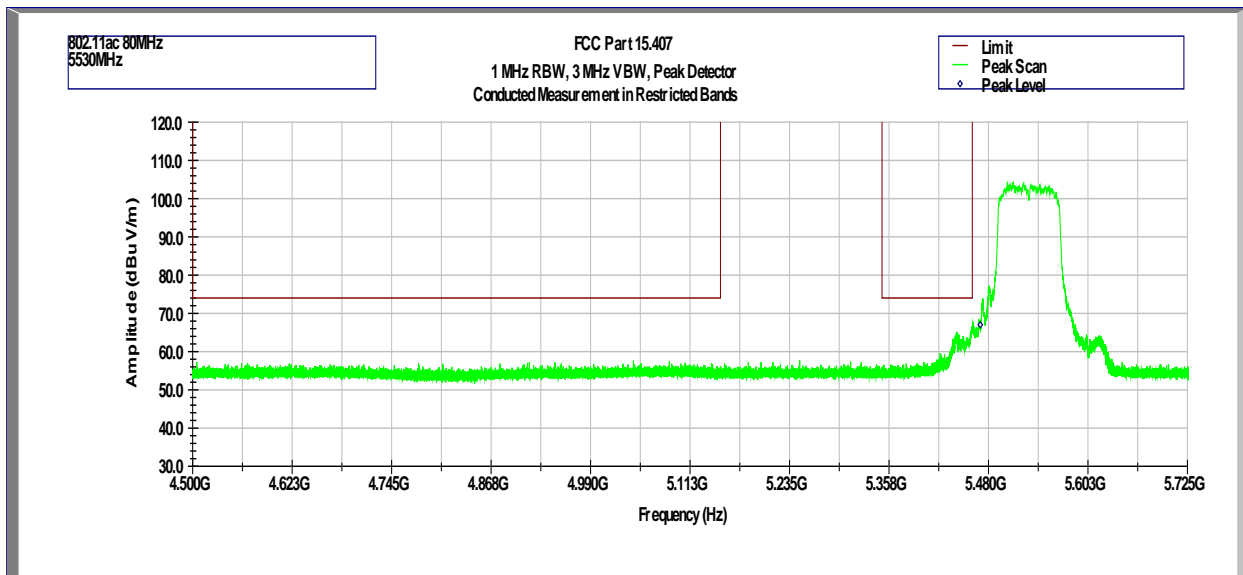
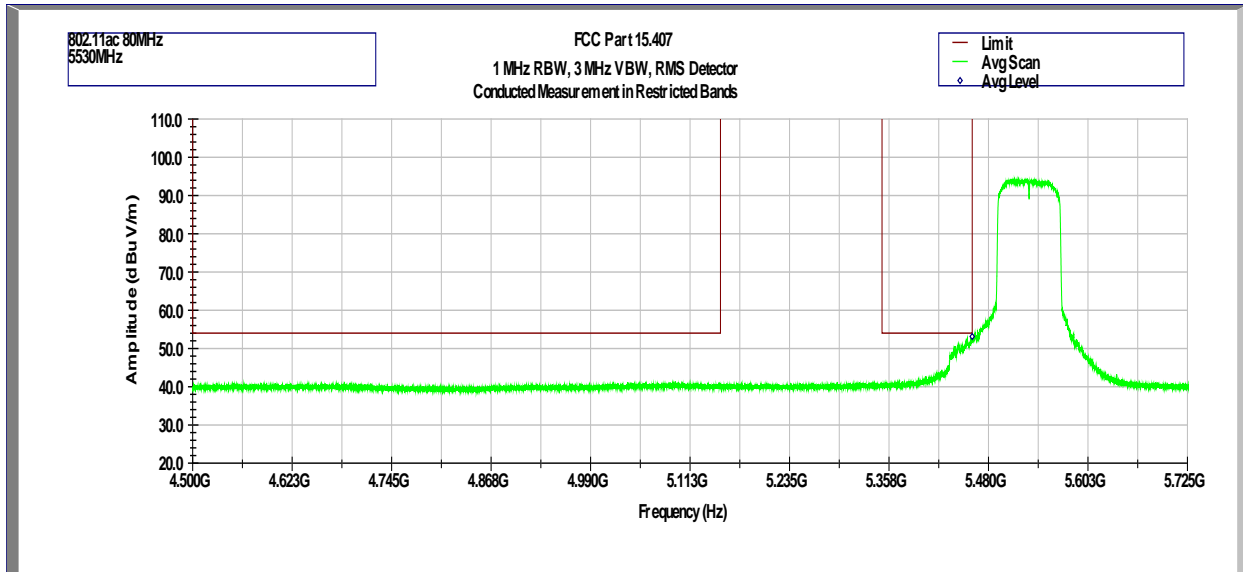

Frequency	Corrected Amplitude	Limit	Margin	Detector	Results
GHz	dB μ V/m	dB μ V/m	dB		
5.460	53.1	54	-0.9	Avg	Pass
5.470	67.0	68.2	-1.2	Peak	Pass

Out-of-Band Conducted Spurious Emissions (at Antenna Port)

Tx @ 5500MHz 802.11a

Out-of-Band Spurious Emissions at Antenna Port - 30 MHz to 1 GHz

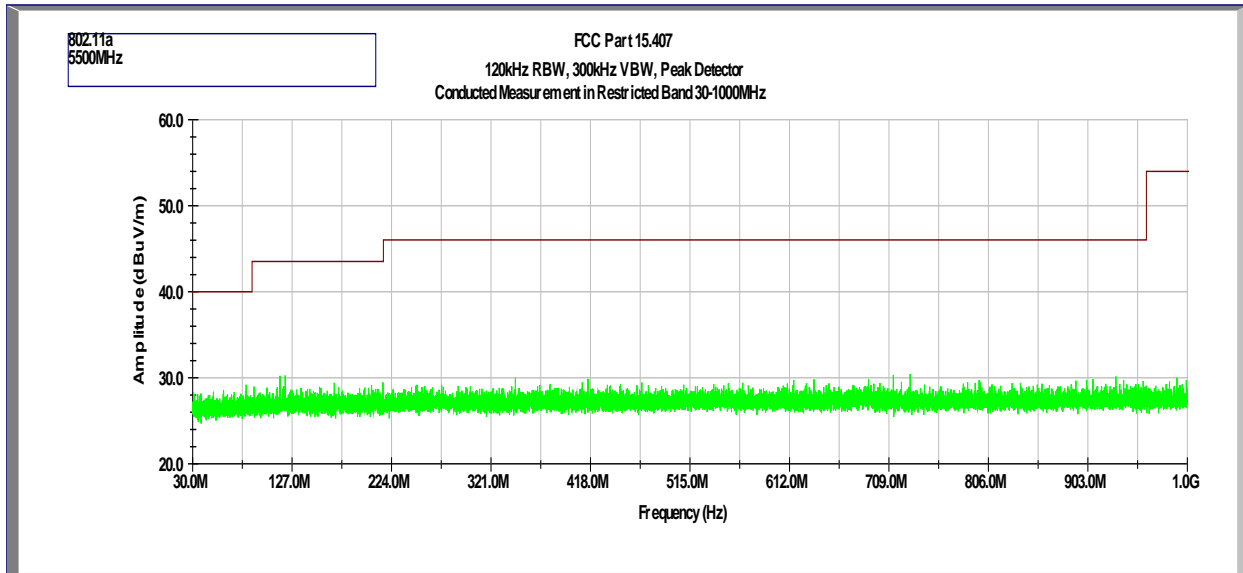

Out-of-Band Spurious Emissions at Antenna Port - 1 GHz to 40 GHz

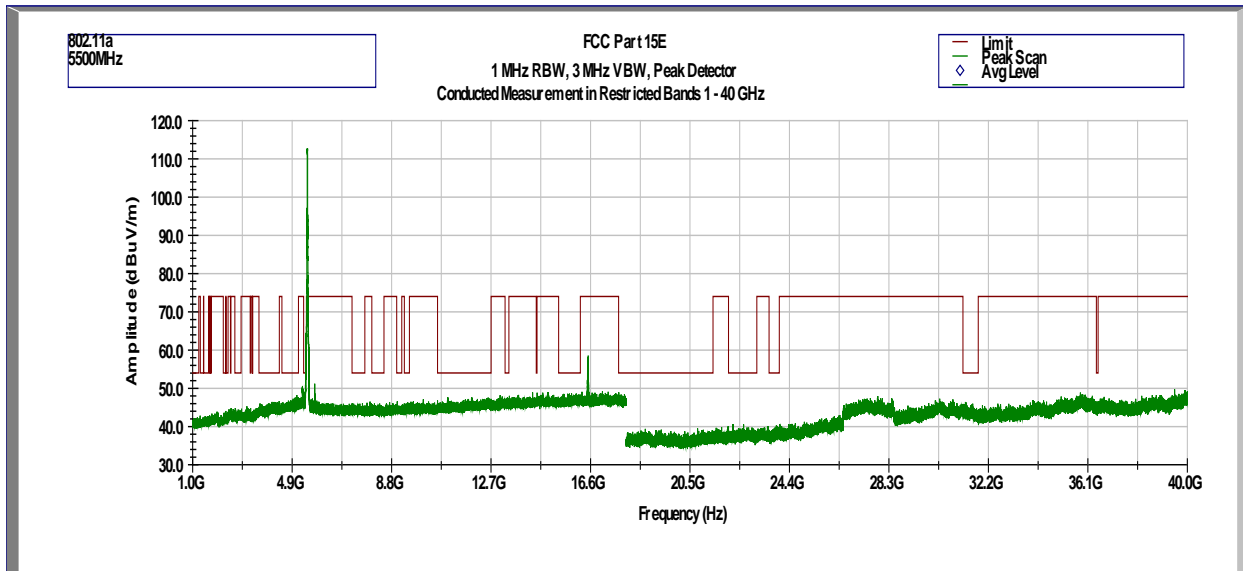

Tx @ 5580MHz 802.11a
 Out-of-Band Spurious Emissions at Antenna Port - 30 MHz to 1 GHz

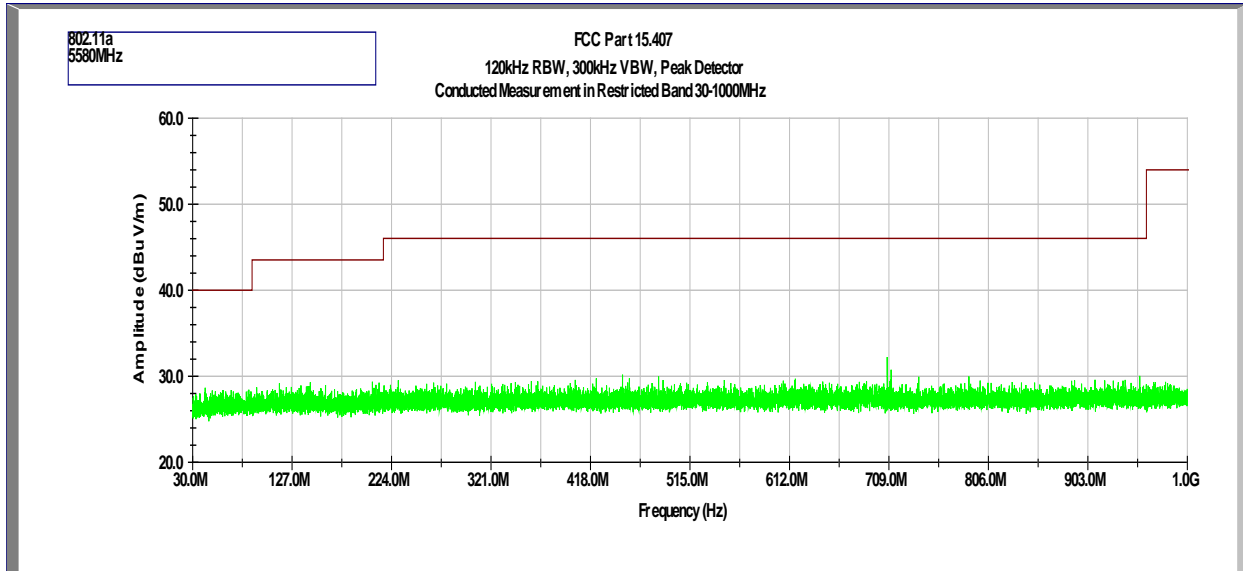

Out-of-Band Spurious Emissions at Antenna Port - 1 GHz to 40 GHz

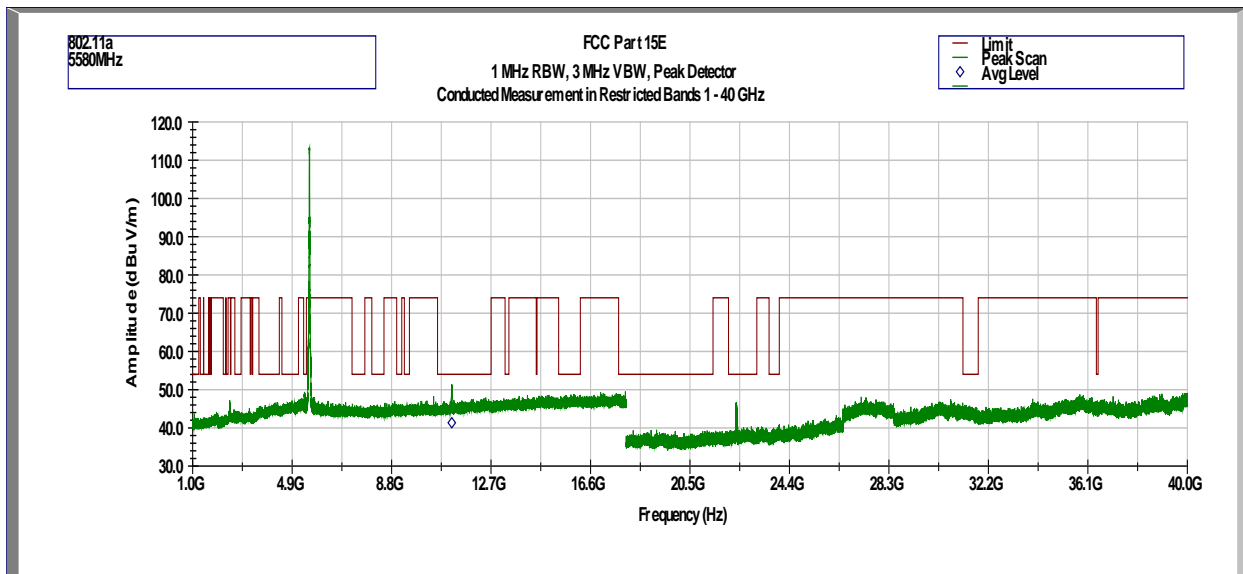

Frequency	Corrected Amplitude	Limit	Margin	Detector	Results
GHz	dB μ V/m	dB μ V/m	dB		
11.160	41.3	54	-12.7	Avg	Pass

Tx @ 5720MHz 802.11a
 Out-of-Band Spurious Emissions at Antenna Port - 30 MHz to 1 GHz

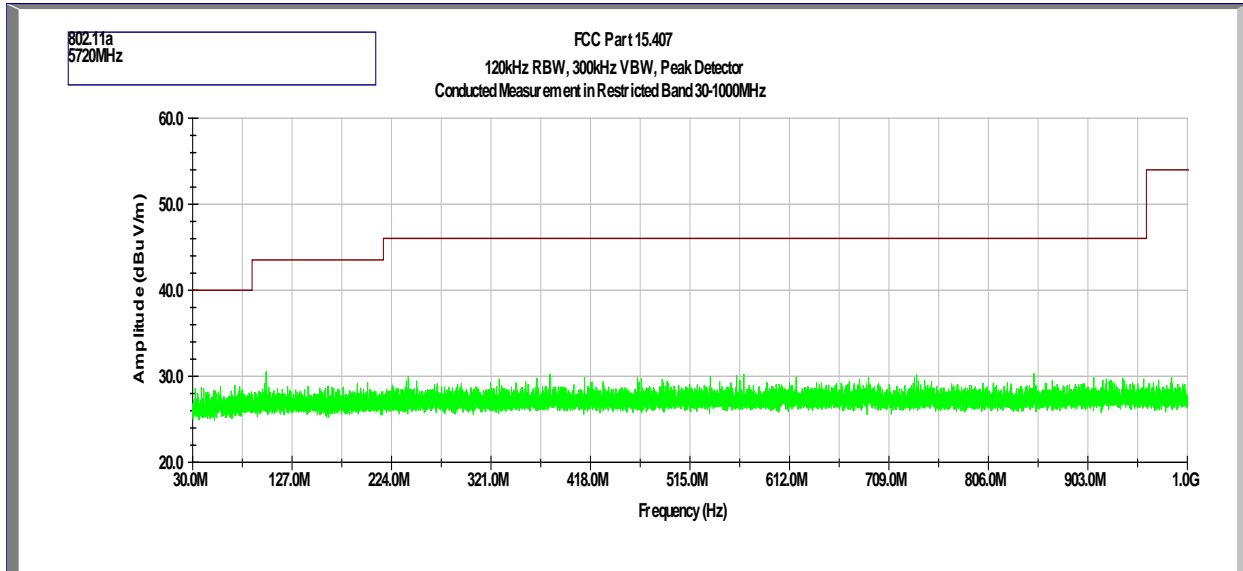

Out-of-Band Spurious Emissions at Antenna Port - 1 GHz to 40 GHz

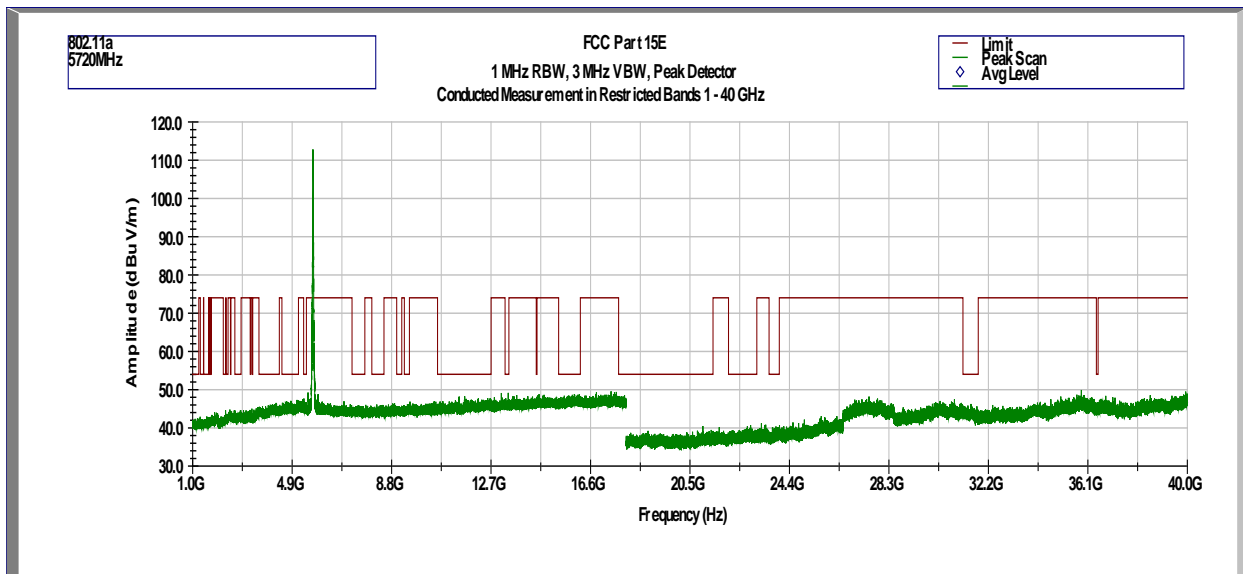



Tx @ 5500MHz 802.11n 20MHz
Out-of-Band Spurious Emissions at Antenna Port - 30 MHz to 1 GHz

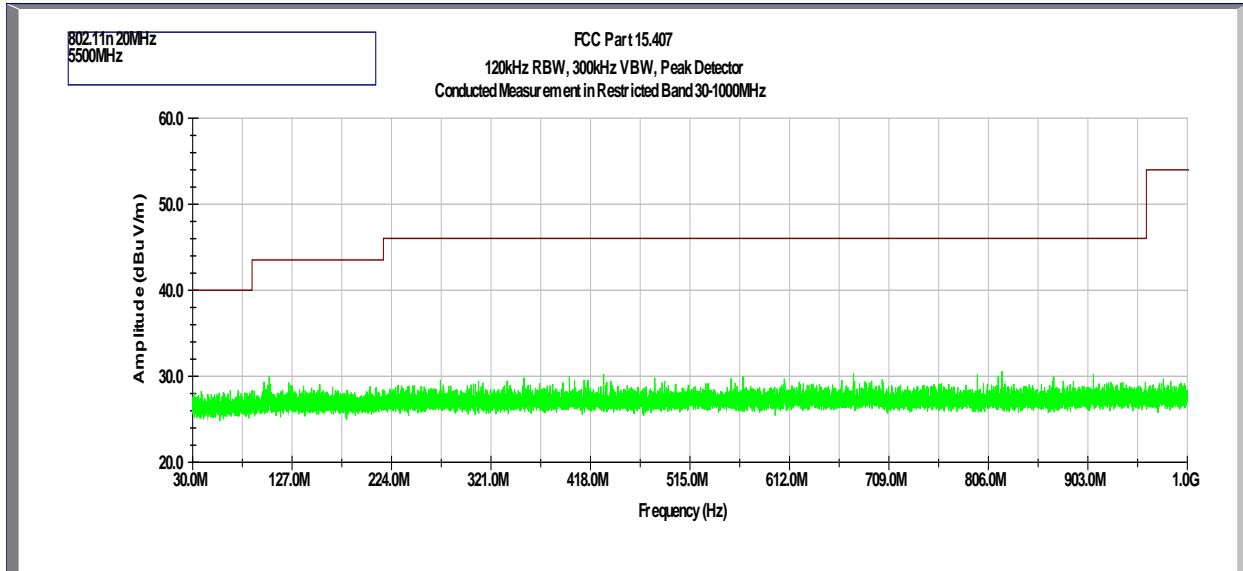

Out-of-Band Spurious Emissions at Antenna Port - 1 GHz to 40 GHz

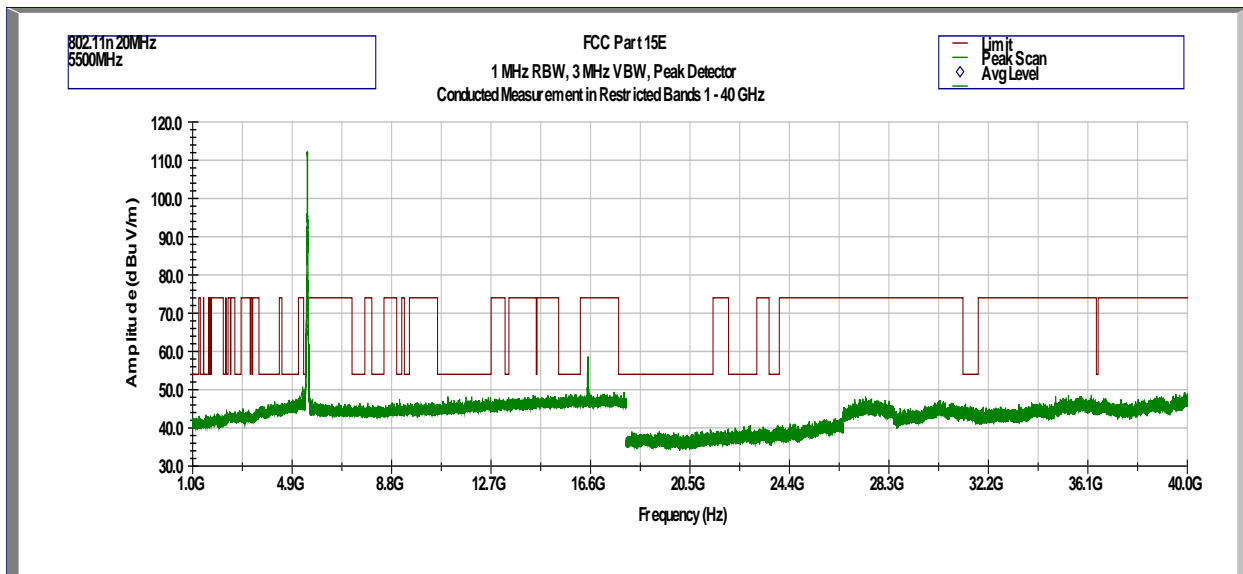

Tx @ 5580MHz 802.11n 20MHz
 Out-of-Band Spurious Emissions at Antenna Port - 30 MHz to 1 GHz

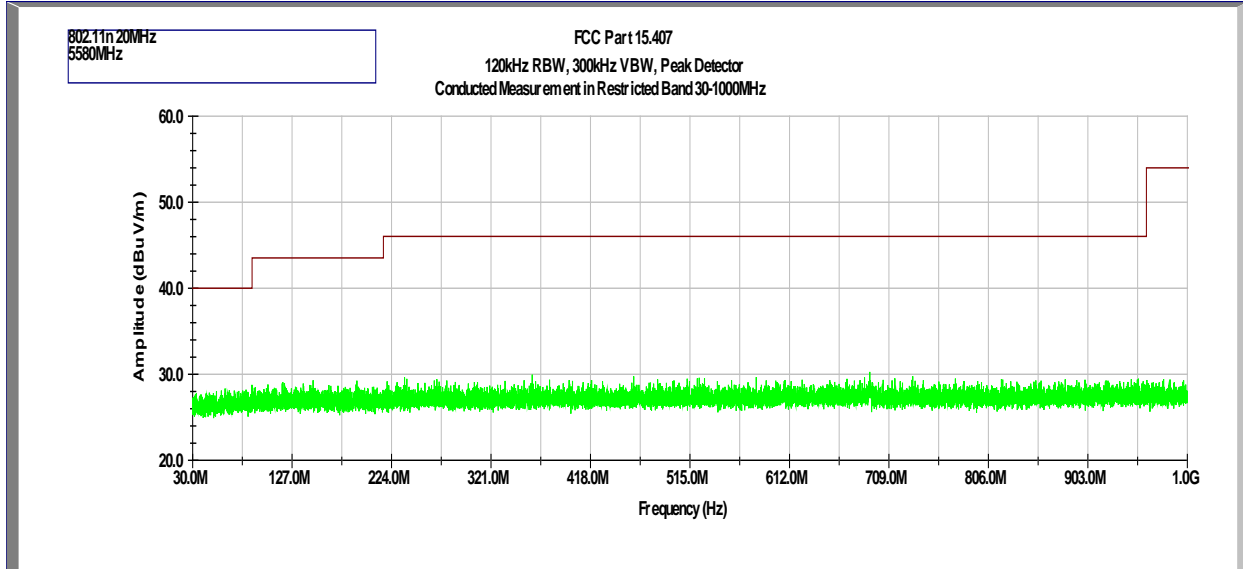

Out-of-Band Spurious Emissions at Antenna Port - 1 GHz to 40 GHz

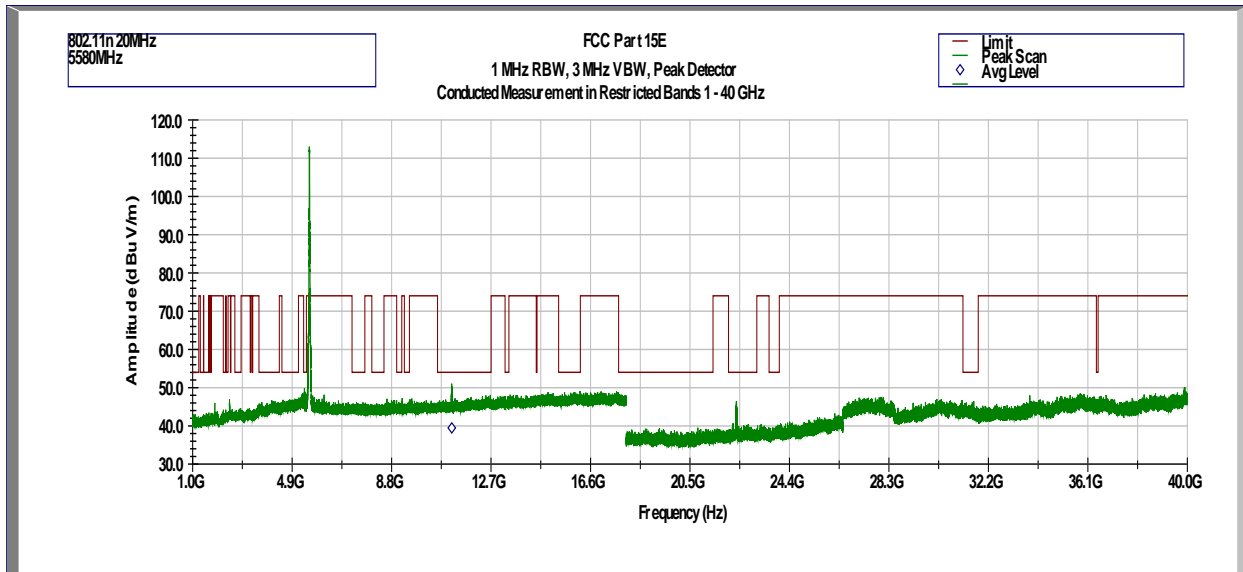

Frequency	Corrected Amplitude	Limit	Margin	Detector	Results
GHz	dBμV/m	dBμV/m	dB		
11.160	39.4	54	-14.6	Avg	Pass



Tx @ 5720MHz 802.11n 20MHz
Out-of-Band Spurious Emissions at Antenna Port - 30 MHz to 1 GHz

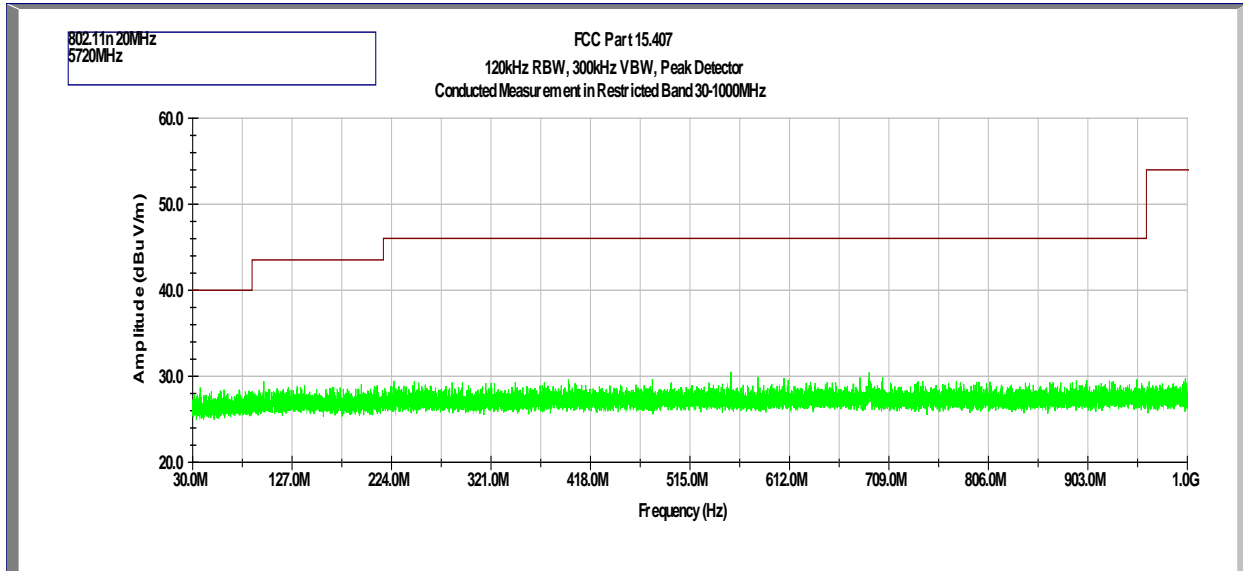

Out-of-Band Spurious Emissions at Antenna Port - 1 GHz to 40 GHz

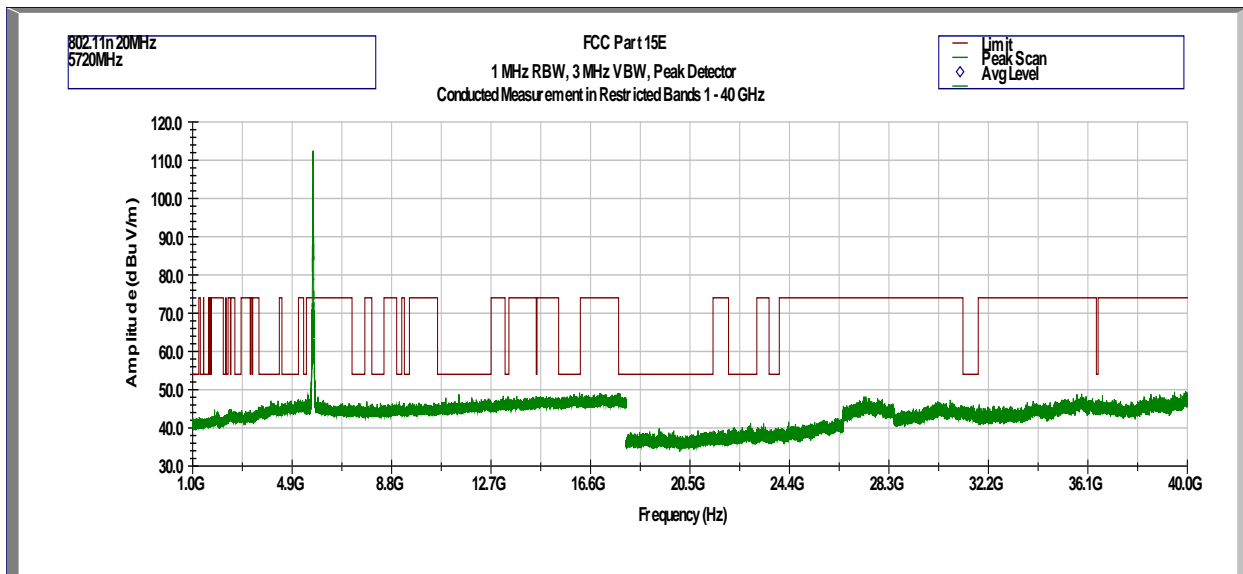

Tx @ 5510MHz 802.11n 40MHz
 Out-of-Band Spurious Emissions at Antenna Port - 30 MHz to 1 GHz

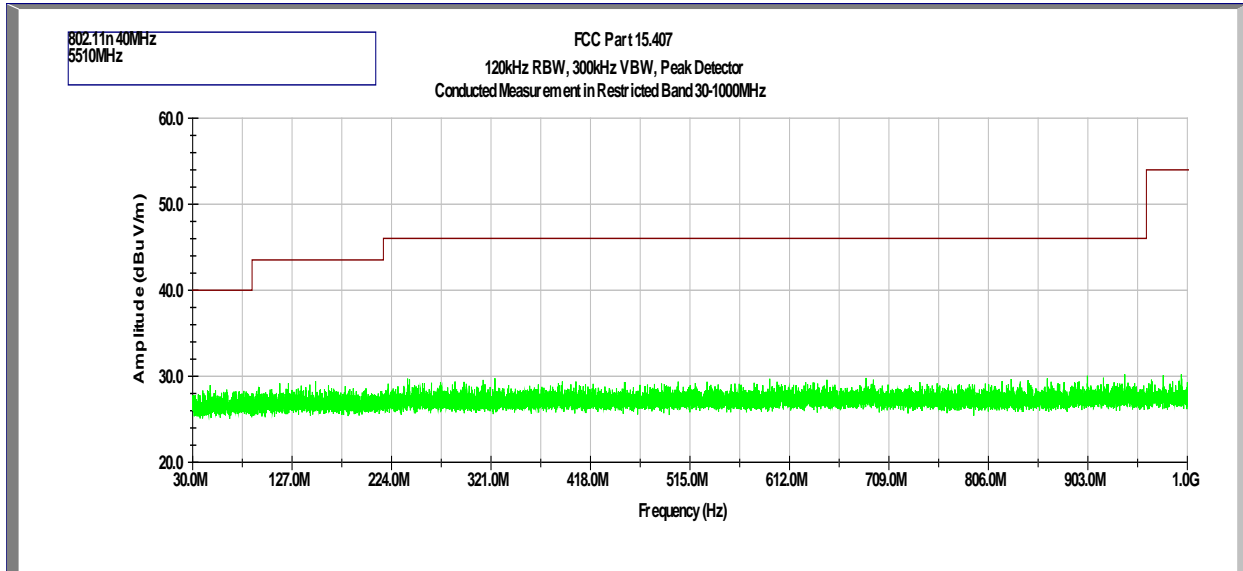

Out-of-Band Spurious Emissions at Antenna Port - 1 GHz to 40 GHz

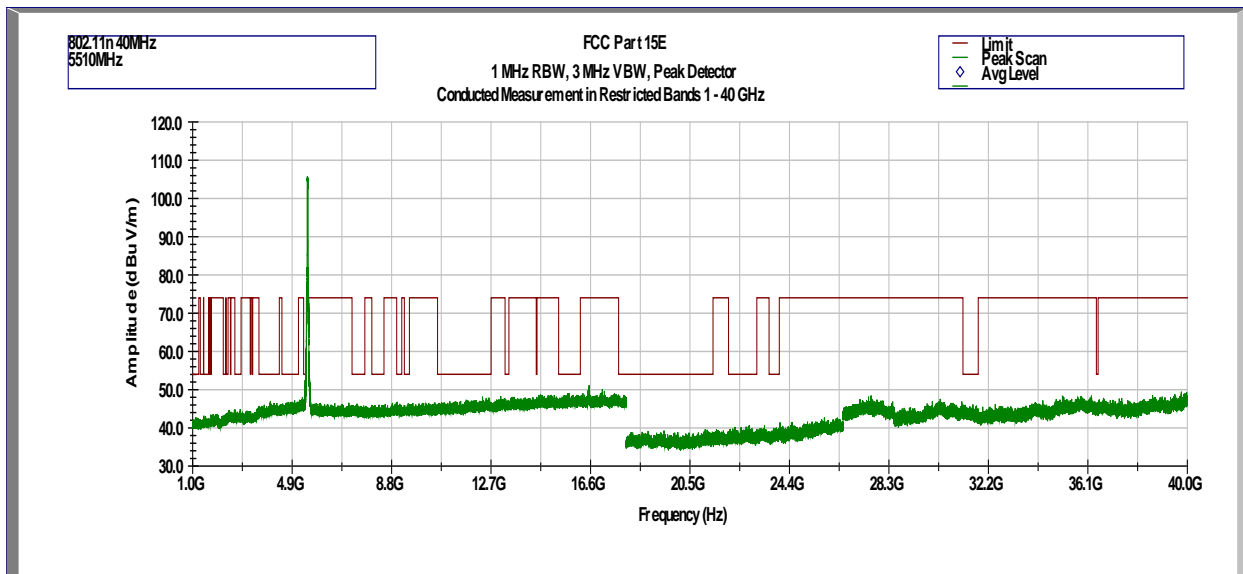



Tx @ 5550MHz 802.11n 40MHz
Out-of-Band Spurious Emissions at Antenna Port - 30 MHz to 1 GHz

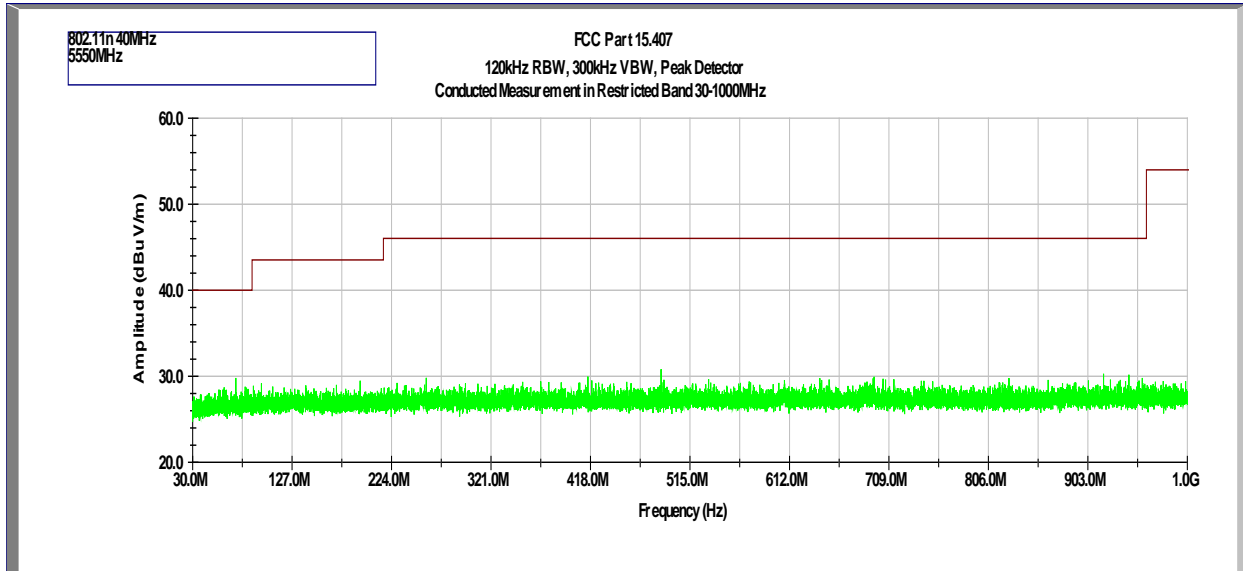

Out-of-Band Spurious Emissions at Antenna Port - 1 GHz to 40 GHz

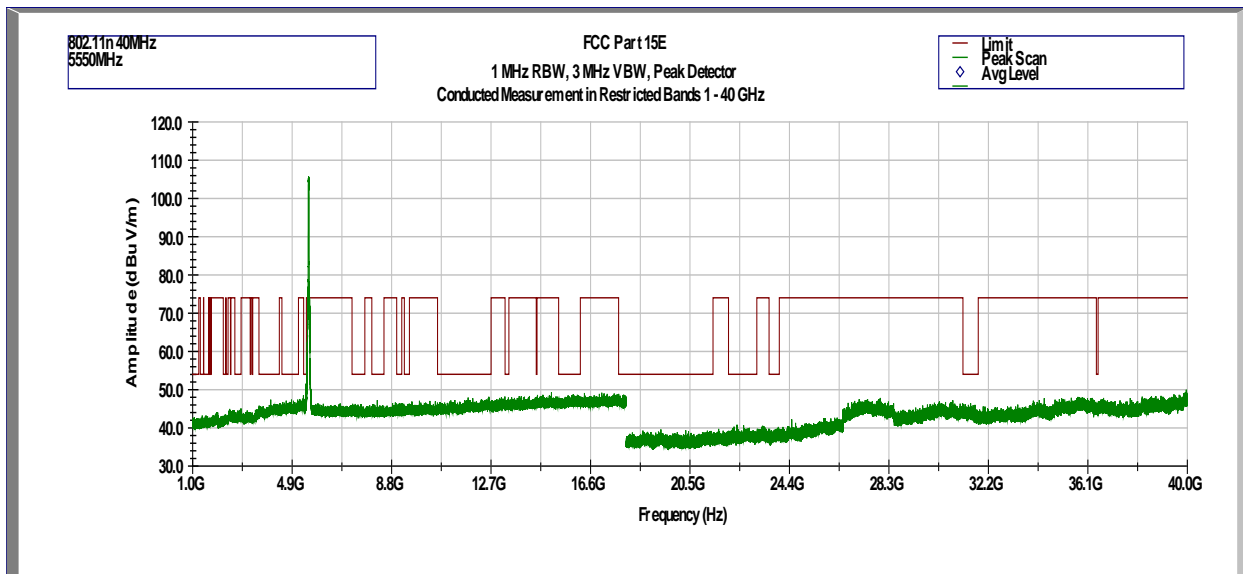

Tx @ 5710MHz 802.11n 40MHz
Out-of-Band Spurious Emissions at Antenna Port - 30 MHz to 1 GHz

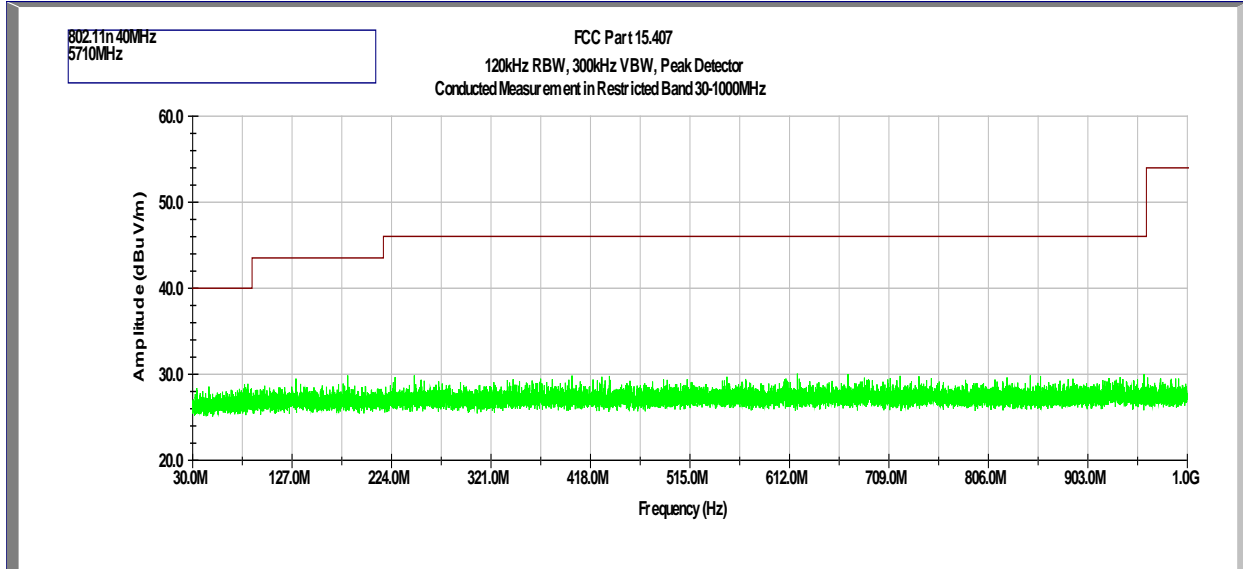

Out-of-Band Spurious Emissions at Antenna Port - 1 GHz to 40 GHz

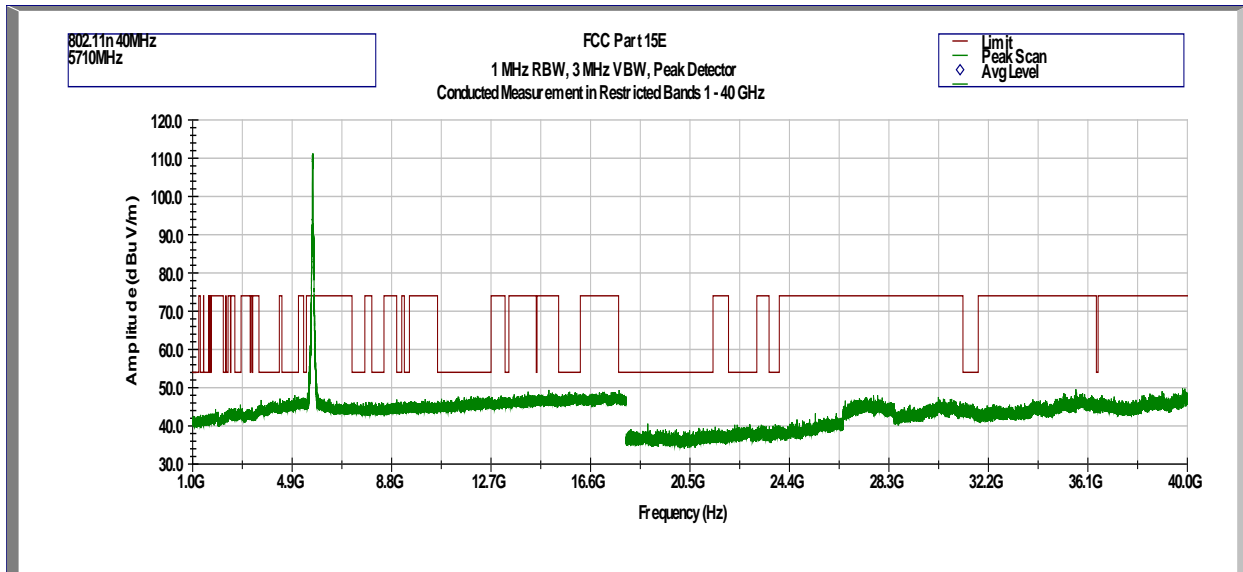

Tx @ 5530MHz 802.11ac 80MHz
 Out-of-Band Spurious Emissions at Antenna Port - 30 MHz to 1 GHz

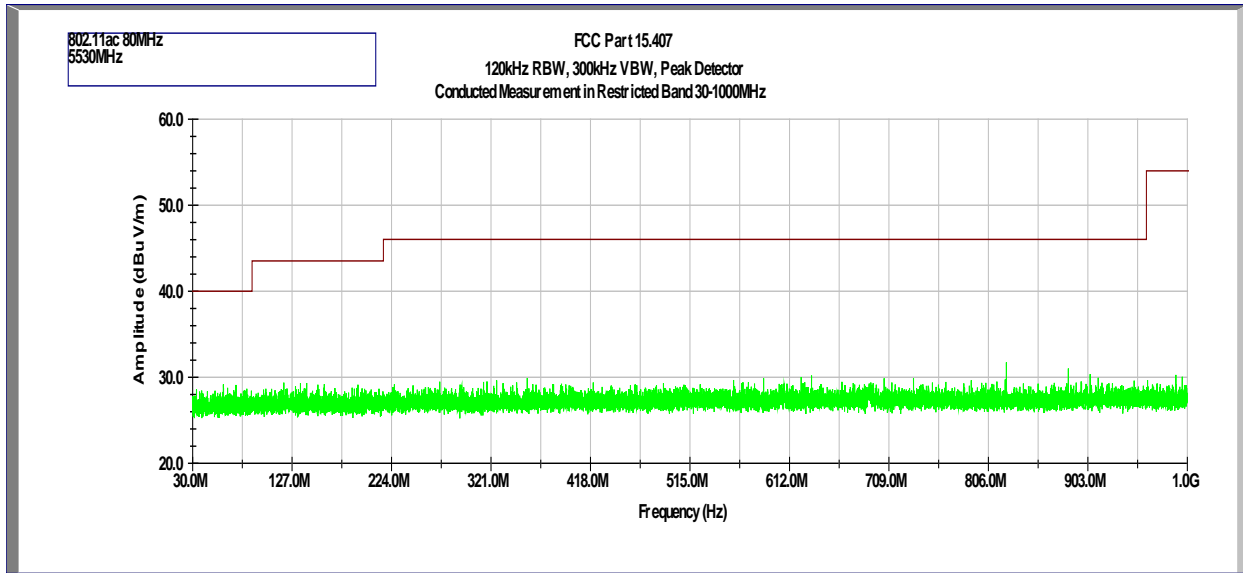

Out-of-Band Spurious Emissions at Antenna Port - 1 GHz to 40 GHz

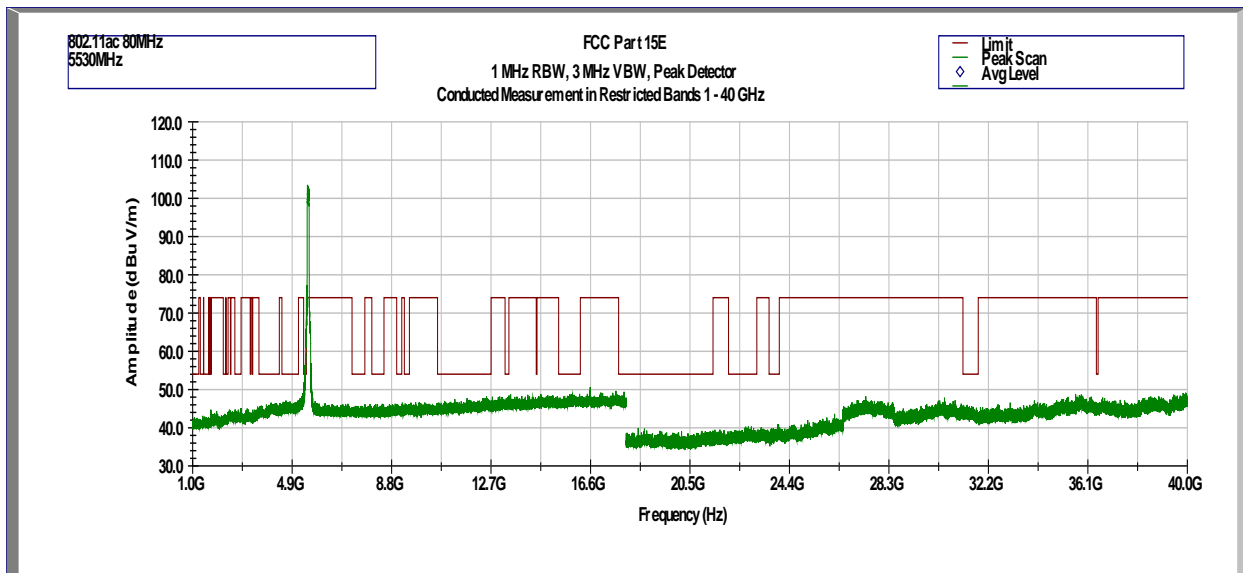



Tx @ 5690MHz 802.11ac 80MHz
Out-of-Band Spurious Emissions at Antenna Port - 30 MHz to 1 GHz

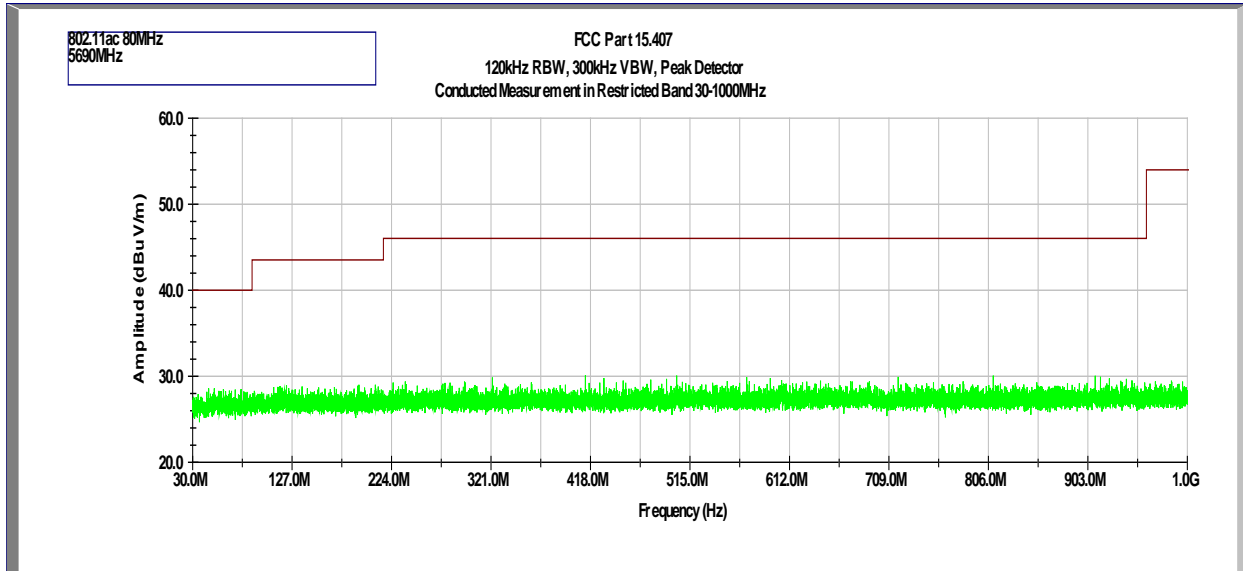

Out-of-Band Spurious Emissions at Antenna Port - 1 GHz to 40 GHz

