

R5020

Hardware Manual

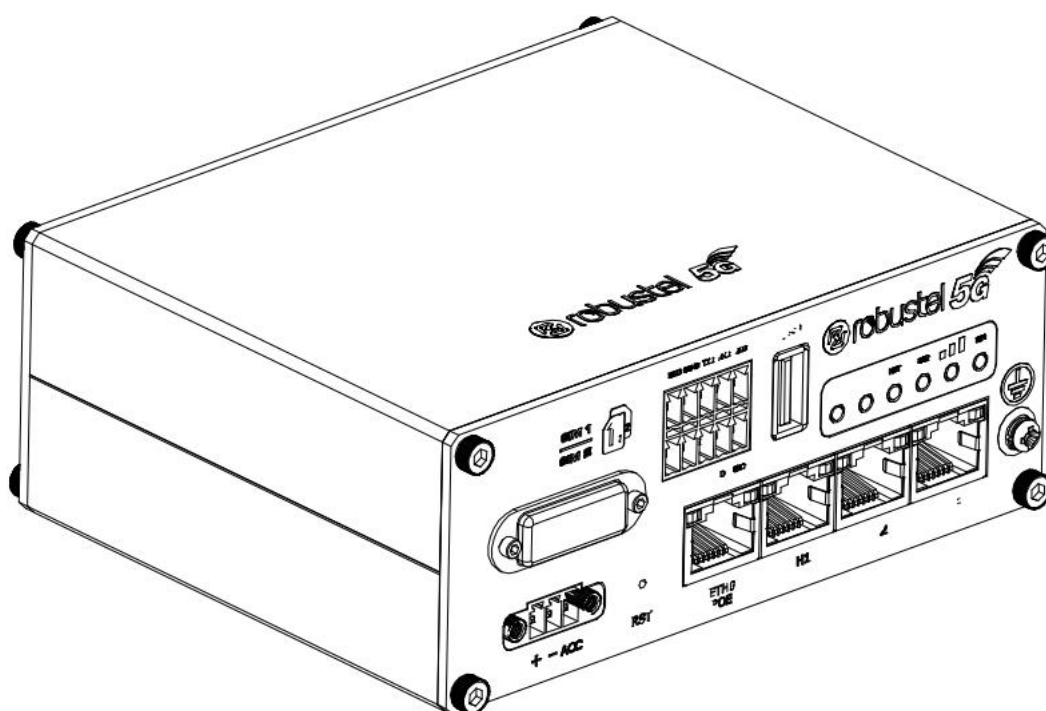

Version: 1.0.0

Date: July 6, 2022

Regulatory and Type Approval Information

Table 1: Toxic or Hazardous Substances or Elements with Defined Concentration Limits

Name of the Part	Hazardous Substances									
	(Pb)	(Hg)	(Cd)	(Cr(VI))	(PBB)	(PBDE)	(DEHP)	(BBP)	(DBP)	(DIBP)
Metal parts	o	o	o	o	-	-	-	-	-	-
Circuit modules	o	o	o	o	o	o	o	o	o	o
Cables and cable assemblies	o	o	o	o	o	o	o	o	o	o
Plastic and polymeric parts	o	o	o	o	o	o	o	o	o	o

o:
Indicates that this toxic or hazardous substance contained in all of the homogeneous materials for this part is below the limit requirement in RoHS2.0.

X:
Indicates that this toxic or hazardous substance contained in at least one of the homogeneous materials for this part *might exceed* the limit requirement in RoHS2.0.

-:
Indicates that it does not contain the toxic or hazardous substance.

Radio Specifications

RF technologies	3G, 4G, 5G, GNSS*, Wi-Fi
Cellular Frequency*	3G: WCDMA: B1/B2/B3/B4/B5/B6/B8/B19 4G: LTE FDD: B1/B2/B3/B4/B5/B7/B8/B12(B17)/B13/B14/B18/B19/B20/B25/B26/B28/B29/B30/B32/B66/B71 LTE TDD: B34/B38/B39/B40/B41/B42/B43/B48 LAA: B46 5G: NSA/SA: n1/n2/n3/n5/n7/n8/n12/n20/n25/n28/n38/n40/n41/n48*/n66/n71/n77/n78/n79
Wi-Fi Frequency	2.4 GHz: 2.412 - 2.472 GHz 5 GHz: 5.15 - 5.825 GHz
Max RF power	28 dBm@5G, 25 dBm@WCDMA, 28 dBm@LTE, 22.96dBm@Wi-Fi

* *May vary on difference models.*

Simplified EU Declaration of Conformity

We, Guangzhou Robustel Co., Ltd. are located at 501, Building #2, 63 Yongan Road, Huangpu District, Guangzhou, China, declare that this radio equipment complies with all applicable EU directives. The full text of the EU DoC is available at the following internet address:

www.robustel.com/certifications/

FCC Statement

This equipment has been tested and found to comply with the limits for a Class B digital device, pursuant to part 15 of the FCC Rules. These limits are designed to provide reasonable protection against harmful interference in a residential installation. This equipment generates, uses and can radiate radio frequency energy and, if not installed and used in accordance with the instructions, may cause harmful interference to radio communications. However, there is no guarantee that interference will not occur in a particular installation. If this equipment does cause harmful interference to radio or television reception, which can be determined by turning the equipment off and on, the user is encouraged to try to correct the interference by one or more of the following measures:

Reorient or relocate the receiving antenna.

Increase the separation between the equipment and receiver.

Connect the equipment into an outlet on a circuit different from that to which the receiver is connected.

Consult the dealer or an experienced radio/TV technician for help.

This device complies with part 15 of the FCC rules. Operation is subject to the following two conditions: (1) This device may not cause harmful interference, and (2) this device must accept any interference received, including interference that may cause undesired operation.

Caution: Any changes or modifications not expressly approved by Guangzhou Robustel Co., Ltd for compliance could void the user's authority to operate this equipment.

RF Exposure

This equipment complies with FCC RF radiation exposure limits set forth for an uncontrolled environment. This device and its antenna must not be co-located or operating in conjunction with any other antenna or transmitter.

The antennas used for this transmitter must be installed to provide a separation distance of at least 24 cm from all persons and must not be co-located or operating in conjunction with any other antenna or transmitter.

FCC ID: 2AAJGR5020

Contains FCC ID: XMR2020RM500QAE

ISED Notice:

This device contains licence-exempt transmitter(s)/receiver(s) that comply with Innovation, Science and Economic Development Canada's licence-exempt RSS(s). Operation is subject to the following two conditions:

This device may not cause interference.

This device must accept any interference, including interference that may cause undesired operation of the device.

Cet appareil est conforme à la norme RSS d'Industrie Canada. Son fonctionnement est sujet aux deux conditions suivantes:

(1) le dispositif ne doit pas produire de brouillage préjudiciable, et

(2) le dispositif doit accepter tout brouillage reçu, y compris un brouillage susceptible de provoquer un fonctionnement indésirable.

RF Exposure

This equipment complies with IC radiation exposure limits set forth for an uncontrolled environment. This equipment should be installed and operated with minimum distance 24 cm between the radiator & your body.

Déclaration d'exposition aux radiations:

Cet équipement est conforme aux limites d'exposition aux rayonnements IC établies pour un environnement non contrôlé. Cet équipement doit être installé et utilisé avec un minimum de 24 cm de distance entre la source de rayonnement et votre corps.

IC: 11610A-R5020

Contains IC: 10224A-2021RM500AE

Related download link

Find more product documents or tools at:

www.robustel.com/en/documentations/

Technical Support

Tel: +86-20-82321505

Email: support@robustel.com

Web: www.robustel.com



Document History

Updates between document versions are cumulative. Therefore, the latest document version contains all updates made to previous versions.







Date	Firmware Version	Document Version	Change Description
July 6, 2022	5.0.0	1.0.0	Initial release.
November 7, 2022	5.0.0	1.0.1	FCC statement and ISED notice updated.

Overview

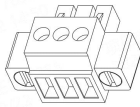
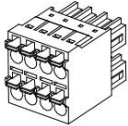
Robustel R5020 supports WCDMA 3G network, LTE 4G network, and 5G network to provide high-speed wireless network bandwidth for devices through wireless connection, and it has dual-SIM card backup to ensure stable wireless network connection.

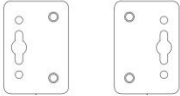
Package Checklist

Before commencing installation ensure your package has the following components:

<p>Device</p> 	<p>3PIN Terminal Block</p> 	<p>2x5PIN Terminal Block</p> 	<p>Power Supply</p> 	<p>Mounting Kit</p> 
<p>RCMS Card</p> 	<p>Quick Start Guide Card</p> 	<p>Cellular Antenna (Rubber)</p> 	<p>Wi-Fi Antenna</p> 	

Note: The accessories could be different on specific order.

Panel Layout (May Vary on Different Models)

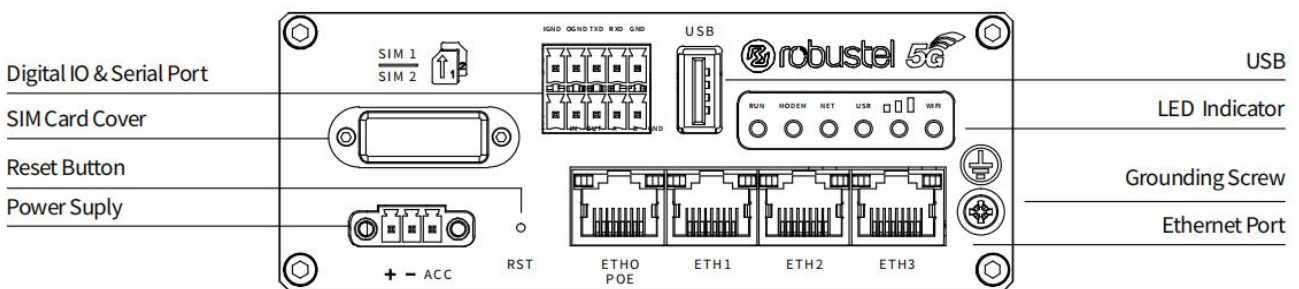

Front-View

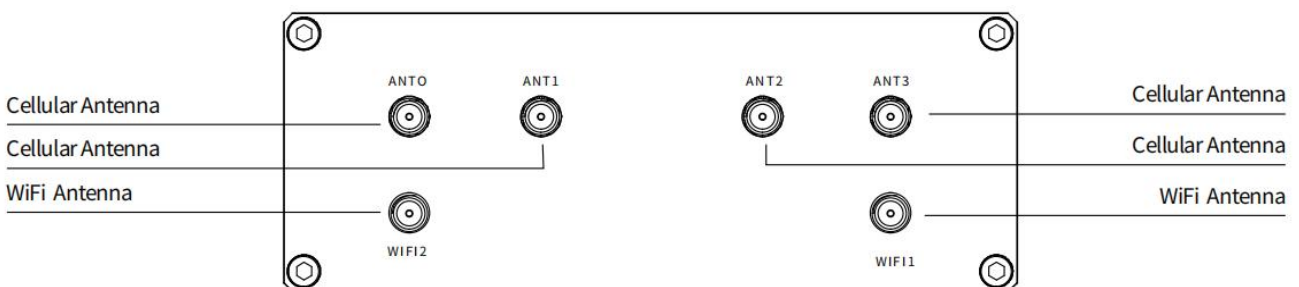

Back-View

Interface Descriptions

1. Power Supply. 3PIN 3.5mm pitch terminal block.

PIN	Description	Note	
1	V+	Connect adapter or battery positive (red line)	
2	V-	Connect adapter or battery negative (yellow line)	
3	ACC (Optional)	Car ignition and flameout detection (green line) Note: when the car ignition and flameout detection function is not used, the ACC pin need to be connected to the V+ and cannot be left floating.	

With ACC Function **With POE Function**

Note:

- 1) ACC and POE function can only be selected one
- 2) The input voltage is 10 to 30V DC(With ignition sensing) or 9 to 36V DC(Without ignition sensing)

2. LED Indicator.

Name	Color	Status	Description	
RUN	Green	On, solid	Router is powered on	
		On, blinking	Router starts operating	
		Off	Router is powered off	
MODEM	Green	On, solid	Link connection is working	
		On, blinking	Data is sent and received	
		Off	Link connection is not working	
NET	Green	On, solid	Connection to 5G network is established(5g signal is the best)	
		On, blinking	Connection to Legacy network (4G or 3G) is established(3G signal difference / 4G signal medium)	
		Off	Network is not joined or joining	
USR-OpenVPN	Green	On, solid	OpenVPN connection is established	
		Off	OpenVPN connection is not established	
USR-IPsec	Green	On, solid	IPsec connection is established	
		Off	IPsec connection is not established	
USR-SIM	Green	On, solid	Main SIM card is being used	
		On, blinking	Backup SIM card is being used	
		Off	No SIM card is being used	
	Green	On, solid	5G network: Reference Signal Received Power greater than -86 dBm (Strong signal) Non-5G network: Received Signal Strength Indication greater than -73 dBm (Strong signal)	
		Yellow	On, solid	5G network: Reference Signal Received Power -105 to -86 dBm (Moderate signal) Non-5G network: Received Signal Strength Indication -91 to -73 dBm (Moderate signal)
		Red	On, solid	5G network: Reference Signal Received Power -140 to -106 dBm (Weak signal) Non-5G network: Received Signal Strength Indication -111 to -93dBm (Weak signal)
		--	Off	No signal
WiFi	Green	On, solid	Wi-Fi is enabled and working properly	
		Off	Wi-Fi is disabled or not working properly	

Note: You can choose the display type of USR LED. For more details, please refer to

RT123_SM_RobustOS Software Manual, Services > Advanced > System >System Settings > User LED Type.

3. Reset Button.

Function	Operation
Reboot	Press and hold the RST button for 2~ 5 seconds under the operating status.
Restore to default configuration	Press and hold the RST button for 5~10 seconds, the RUN LED starts blinking quickly, the router will restore to default configuration.
Restore to factory default settings	Once the operation of restoring default configuration is performed twice within one minute, the router will restore to factory default settings.

Note: The more details please refer to *RT123_SM_RobustOS Software Manual, 2.3 Factory Reset.*

4. Ethernet Ports. There are four Ethernet ports on R5020, including ETH0 (Optional POE supported), ETH1, ETH2, ETH3. The ETH0 on the router can be configured as a WAN port, while ETH1, ETH2 and ETH3 can only be configured as a LAN port. By default, ETH1, ETH2 and ETH3 are lan0, and their IP are 192.168.0.1/255.255.255.0.

Ethernet LED Indicator	Status	Description
Link indicator (Yellow)	On, solid	Connection is established
	On, blinking	Data is being transferred
	Off	Connection is not established

5. Digital IO & Serial Port. 2x5PIN 3.5mm pitch terminal block, 1 set of DO, 1 set of DI, 1 x RS232 and 1 x RS485. DI signal access, can be used for NPN/PNP type sensor signal or switch signal acquisition. DO signal output, can be used for NPN/PNP sensor control, please connect signals by referring to typical applications .

PIN	DI/DO	RS232	RS485	Direction
1	IGND	--	--	--
2	OGND	--	--	--
3	--	TXD	--	Router → Device
4	--	RXD	--	Router ← Device
5	--	GND	--	--
6	IN	--	--	--
7	OUT	--	--	--
8	--	--	A	--
9	--	--	B	--
10	--	--	GND	--

Internal diagram of DI&DO

Typical Application:

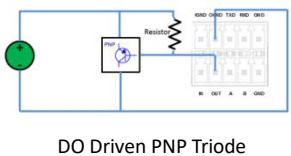
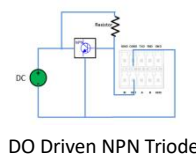
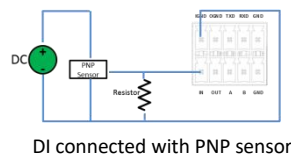
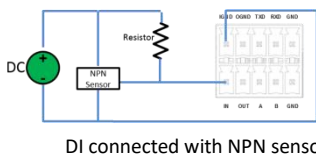

Note: The external power supply DC voltage range is 3V~30V.

6. USB Interface.

Function	Operation
Firmware upgrade	USB interface is used for batch firmware upgrading, but cannot be used for sending or receiving data from slave devices which connected to it. You can insert a USB storage device into the router's USB interface, such as a U disk or a hard disk. If there have a supported configuration file or a router firmware in this USB storage device, the router will automatically update the configuration file or the firmware. For more details, please refer to <i>RT123_SM_RobustOS Software Manual.</i>

Hardware Installation

- 1. SIM Card Installation.** Remove the SIM card cover to insert the SIM cards into the device, then screw up the cover.

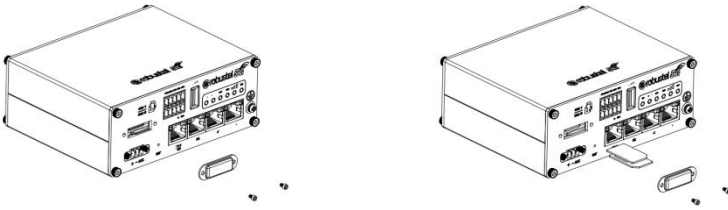

- 2. Antenna Installation.** Rotate the antenna into the antenna connector accordingly. Here take the cellular antenna as example. For 5G 4-IN-1 combo antenna, LHM# cable need to be connected to ANT1 and ANT2 while the MH# cable need to be connected to ANT0 and ANT3. GPS function is available when using the 4 in 1 combo antenna.

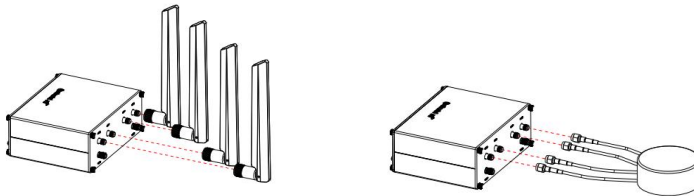

- 3. Terminal Block Installation.** Insert the 2x5PIN terminal blocks into the interfaces connector, then can connect the devices or sensors to the gateway via corresponding interfaces e.g. RS232/RS485, DIDO...

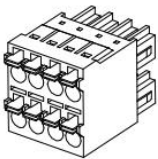

- 4. Mounting Kit installation.**

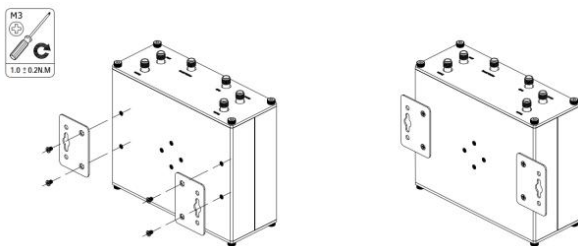

5. Grounding the Device. Grounding will help to prevent the noise effect due to electromagnetic interference (EMI). Connect the device to the site ground wire by the grounding screw before powering on.

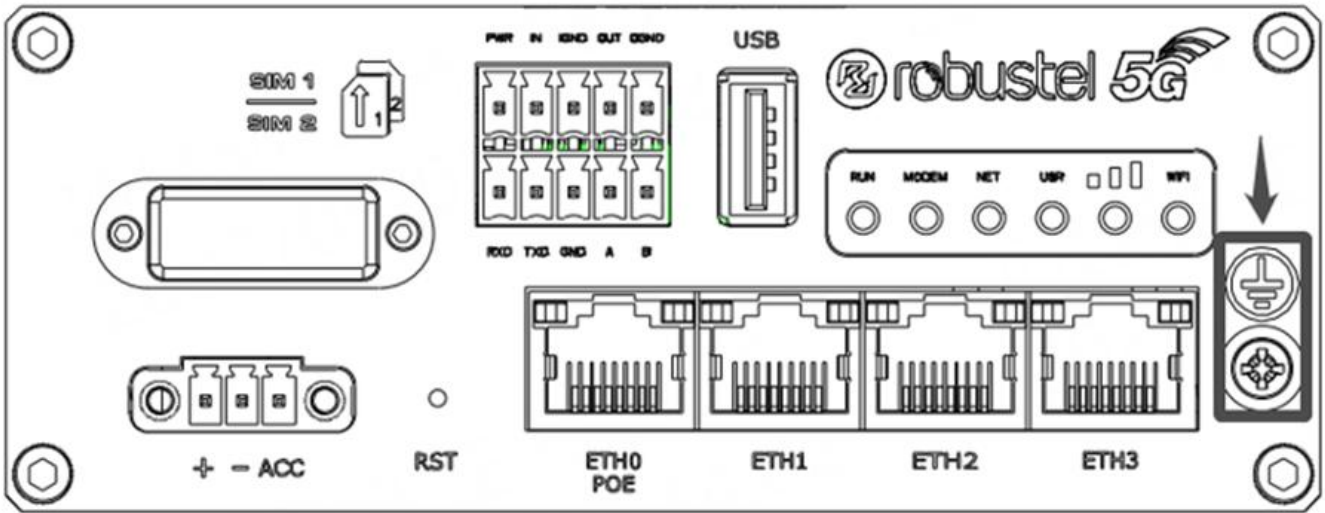

6. Power Supply installation. Insert the power supply cord into the corresponding terminal block if needed, then insert the terminal block into the power connector.

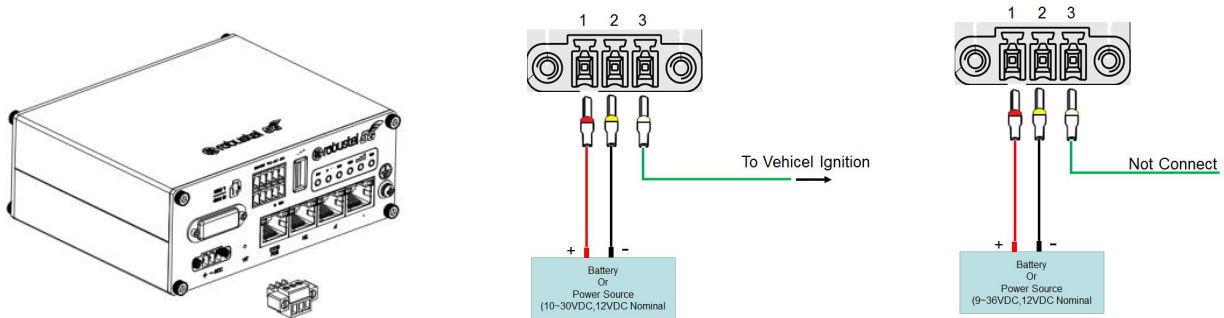

7. Connect the router to the computer. Connect the Ethernet cable to any port labeled ETH0 to ETH3 on the bottom of the router, and connect the other end of the cable to your computer.

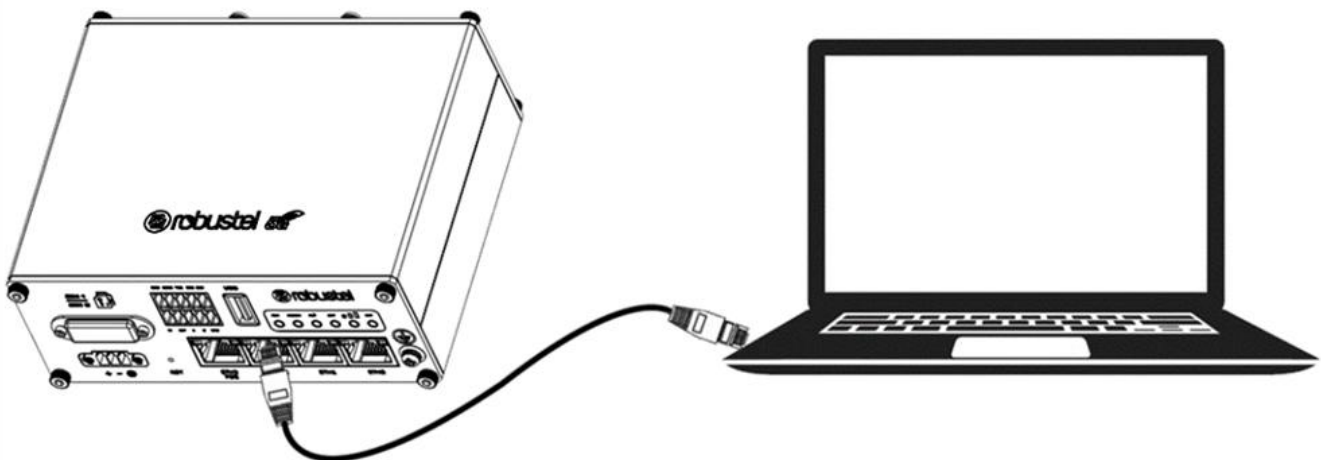

Login to the Device

1. Connect the router’s Ethernet port to a PC with a standard Ethernet cable.
2. Before logging in, manually configure the PC with a static IP address on the same subnet as the gateway address, click and configure "Use the following IP address".

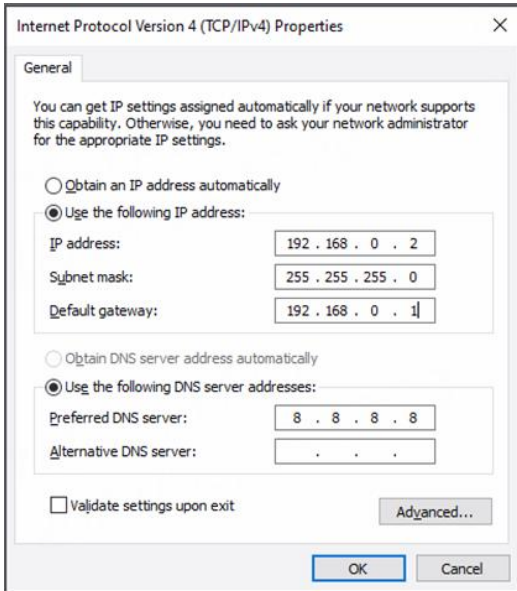

3. To enter the gateway's web interface, type <http://192.168.0.1> into the URL field of your Internet browser.
4. Use login information shown in the product label when prompted for authentication.



5. After logging in, the home page of the web interface is displayed, then you can view system information and perform configuration on the device.

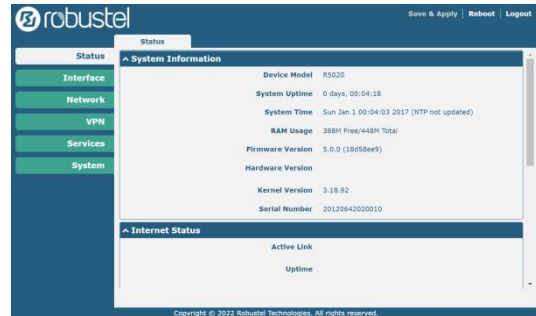

6. The automatic APN selection is ON by default, if need to specify your own APN, please go to the menu **Interface->Link Manager->Link Setting->WWAN Settings** to finish the specific setting.

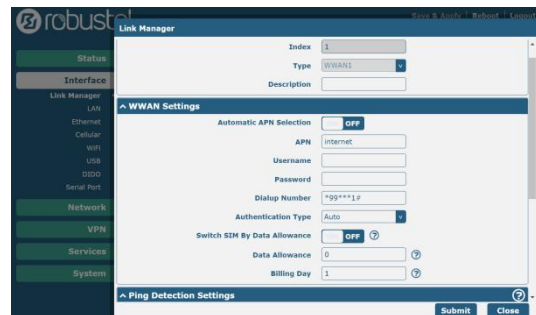

7. The more configuration details please refer to **RT123_SM_RobustOS Software Manual**.
(END)