



TEST REPORT

For

Applicant : ACOUSTMAX INTERNATIONAL CO., LTD

**Address : Unit D16/F Cheuk Nang Plaza 250 Hennessy Road
WanchaiHongKong**

Product Name : Monster Solara

Model Name : MNSOL-BLK

Remark : N/A

Brand Name : Monster

FCC Number : FCC ID: 2AAIN-MNSOLBLK

Report No. : MTE/CEC/B17040673

Date of Issue : Apr.25,2017

Issued by : Most Technology Service Co., Limited .

**Address : No.5, 2nd Langshan Road, North District, Hi-tech Industrial
Park, Nanshan, Shenzhen, Guangdong, China**

Tel : 86-755-8602 6850

Fax : 86-755-2601 3350

The report consists 37 pages in total. It may be duplicated completely for legal use with the approval of the applicant. It should not be reproduced except in full, without the written approval of our laboratory. The client should not use it to claim product endorsement by MOST. The test results in the report only apply to the tested sample. The test report shall be invalid without all the signatures of testing engineers, reviewer and approver.

TABLE OF CONTENTS

1. PRODUCT INFORMATION	4
2. GENERAL INFORMATION	5
2.1 Product Information.....	5
2.2 Objective	5
2.3 Test Standards and Results.....	6
2.4 Environmental Conditions.....	6
3. TEST METHODOLOGY.....	7
3.1 TEST FACILITY	7
3.2 GENERAL TEST PROCEDURES	7
4. SETUP OF EQUIPMENT UNDER TEST	8
4.1 SETUP CONFIGURATION OF EUT.....	8
4.2 SUPPORT EQUIPMENT	8
4.3 TEST EQUIPMENT LIST	9
5. 47 CFR Part 15 C Requirements	10
5.1 ANTENNA REQUIREMENT	10
5.1.1 Applicable Standard	10
5.1.2 Evaluation Criteria.....	10
5.1.3 Result: Compliance.	10
5.2 AC Power Line Conducted Emission.....	11
5.2.1 Requirement	11
5.2.2 Block Diagram of Test Setup	11
5.2.3 Test procedure	11
5.2.4 Test Result	11
5.3 Radiated Emission	14
5.3.1 Requirement	14
5.3.2 Test Configuration	14
5.3.3 Test Procedure:	15
5.3.4 Test Result	16
5.4 Conducted Peak Output Power.....	23
5.4.1 Requirement	23
5.4.2 Block Diagram of Test Setup	23
5.4.3 Test Procedure	23
5.4.4 Test Result	23
5.5 6dB Emission Bandwidth	25
5.5.1 Test Requirement.....	25
5.5.2 Block Diagram of Test Setup	25
5.5.3 Test Procedure	25
5.5.4 Test Result	25
5.6 POWER SPECTRAL DENSITY.....	27
5.6.1 Applicable Standard	27
5.6.2 Block Diagram of Test Setup	27
5.6.3 Test Procedure	27
5.6.4 Test Result	27
5.7 Band Edge and Conducted Spurious Emissions	29
5.7.1 Test Requirement.....	29
5.7.2 Test Procedure	29
5.7.3 Test Result	29

5.8 Restricted Frequency Bands..... 33
5.8.1 Test Requirement 33
5.8.2 Test Configuration 33
5.8.3 Test Procedure: 33
5.8.4 Test Result 33

1. PRODUCT INFORMATION

Equipment Under Test:	Monster Solara
Brand Name:	Monster
Model Number:	MNSOL-BLK
FCC Number:	FCC ID: 2AAIN-MNSOLBLK
Applicant:	ACOUSTMAX INTERNATIONAL CO., LTD Unit D16/F Cheuk Nang Plaza 250 Hennessy Road WanchaiHongKong
Manufacturer:	Shenzhen AngSi Technology Co., LTD 902B,LingYun Buiding,Honglang North NO 2.Road ,Baoan District, Shenzhen
Technical Standards:	47 CFR Part 15 Subpart C (Part 15.247 of the FCC Rules)
File Number:	MTE/CEC/B17040673
Date of test:	Apr.11-24,2017
Deviation:	None
Condition of Test Sample:	Normal
Test Result:	PASS

The above equipment was tested by Most Technology Service Co., Ltd. for compliance with the requirements set forth in FCC rules and the Technical Standards mentioned above. This said equipment in the configuration described in this report shows the maximum emission levels emanating from equipment and the level of the immunity endurance of the equipment are within the compliance requirements.

The test results of this report relate only to the tested sample identified in this report.

Prepared by (+ signature):

chloe

Chloe Cai (Engineer)

Apr 11-20, 2017

Review by (+ signature):

John

John Lin (Engineer)

Apr 25, 2017



Approved by (+ signature):

Yvette Zhou

Yvette Zhou (Manager)

Apr.25,2017

2. GENERAL INFORMATION

2.1 Product Information

Product	Monster Solara
Brand Name	Monster
Model Number	MNSOL-BLK
Series Model Name:	N/A
Series Model Difference description:	N/A
Power Supply	1. DC 5V by Adapter 2. DC3.7VbyBattery
Frequency Range	2402MHz -2480MHz
Modulation Type:	GFSK
Channel Number	40
Antenna Type	PCB Antenna, Antenna Gain :4.0dBi
Temperature Range-	-10°C ~ +40°C

NOTE:

1. For a more detailed features description about the EUT, please refer to User's Manual.

2.2 Objective

The objective of the report is to perform tests according to FCC Part 15 Subpart C for the EUT FCC ID Certification:

No.	Identity	Document Title
1	47 CFR Part 15	Radio Frequency Devices
2	DA00-705	Filing and Measurement Guidelines for Frequency Hopping Spread Spectrum Systems.

2.3 Test Standards and Results

No.	Section	Test Items	Result	Date of Test
2	FCC 15.203	Antenna Requirement	PASS	2017-04-18
3	FCC15.207 (a)	AC Power Line Conducted Emission	PASS	2017-04-18
3	FCC15.209, 15.247(d)	Radiated Emission	PASS	2017-04-19
4	FCC15.247(b)(3)	Conducted Peak Output Power	PASS	2017-04-18
5	FCC15.247(a)(2)	6dB Emission Bandwidth	PASS	2017-04-18
6	FCC15.247(e)	Power Spectral Density	PASS	2017-04-18
7	FCC15.247(d)	Band Edge and Conducted Spurious Emissions	PASS	2017-04-18
8	FCC15.247(d)	Restricted Frequency Bands	PASS	2017-04-19

Note: 1. The test result judgment is decided by the limit of measurement standard
 2. The information of measurement uncertainty is available upon the customer's request.

2.4 Environmental Conditions

During the measurement the environmental conditions were within the listed ranges:

- Temperature: 15-35°C
- Humidity: 30-60 %
- Atmospheric pressure: 86-106 kPa

3. TEST METHODOLOGY

3.1 TEST FACILITY

Test Site:	Most Technology Service Co., Limited
Location:	No.5, 2nd Langshan Road, North District, Hi-tech Industrial Park, Nanshan, Shenzhen, Guangdong, China
Description:	There is one 3m semi-anechoic an area test sites and two line conducted labs for final test. The Open Area Test Sites and the Line Conducted labs are constructed and calibrated to meet the FCC requirements in documents ANSI C63.10:2013 and CISPR 16 requirements. The FCC Registration Number is 490827 . The IC Registration Number is 7103A-1 .
Site Filing:	The site description is on file with the Federal Communications Commission, 7435 Oakland Mills Road, Columbia, MD 21046.
Instrument	All measuring equipment is in accord with ANSI C63.10:2013 and CISPR 16
Tolerance:	requirements that meet industry regulatory agency and accreditation agency requirement.
Ground Plane:	Two conductive reference ground planes were used during the Line Conducted Emission, one in vertical and the other in horizontal. The dimensions of these ground planes are as below. The vertical ground plane was placed distancing 40 cm to the rear of the wooden test table on where the EUT and the support equipment were placed during test. The horizontal ground plane projected 50 cm beyond the footprint of the EUT system and distanced 80 cm to the wooden test table. For Radiated Emission Test, one horizontal conductive ground plane extended at least 1m beyond the periphery of the EUT and the largest measuring antenna, and covered the entire area between the EUT and the antenna.

3.2 GENERAL TEST PROCEDURES

Radiated Emissions

The EUT is placed on a turn table, which is 1.5 m above ground plane. The turntable shall rotate 360 degrees to determine the position of maximum emission level. EUT is set 3m away from the receiving antenna, which varied from 1m to 4m to find out the highest emission. And also, each emission was to be maximized by changing the polarization of receiving antenna both horizontal and vertical. In order to find out the maximum emissions, exploratory radiated emission measurements were made according to the requirements in Section 6.5 of ANSI C63.10:2013.

Conducted Emissions

The EUT is placed on the turntable, which is 0.8 m above ground plane. According to the requirements in Section 6.2 of ANSI C63.10:2013,Conducted emissions from the EUT measured in the frequency range between 0.15 MHz and 30MHz using CISPR Quasi-peak and average detector modes.

4. SETUP OF EQUIPMENT UNDER TEST

4.1 SETUP CONFIGURATION OF EUT

See test photographs attached in Appendix 1 for the actual connections between EUT and support equipment.

4.2 SUPPORT EQUIPMENT

Device Type	Manufacturer	Model Name	Serial No.	Data Cable	Power Cable
---	---	---	---	---	---

Remark:

All the equipment/cables were placed in the worst-case configuration to maximize the emission during the test. Grounding was established in accordance with the manufacturer's requirements and conditions for the intended use.

4.3 TEST EQUIPMENT LIST

Instrumentation: The following list contains equipment used at Most for testing. The equipment conforms to the CISPR 16-1 / ANSI C63.2 Specifications for Electromagnetic Interference and Field Strength Instrumentation from 10 kHz to 1.0 GHz or above.

No.	Equipment	Manufacturer	Model No.	S/N	Calibration date	Calibration Interval
1	Test Receiver	Rohde & Schwarz	ESCI	100492	2017/03/10	1 Year
2	Spectrum Analyzer	Agilent	E7405A	US44210471	2017/03/14	1 Year
3	L.I.S.N.	Rohde & Schwarz	ENV216	100093	2017/03/10	1 Year
4	Coaxial Switch	Anritsu Corp	MP59B	6200283933	2017/03/07	1 Year
5	Terminator	Hubersuhner	50Ω	No.1	2017/03/07	1 Year
6	RF Cable	SchwarzBeck	N/A	No.1	2017/03/07	1 Year
7	Test Receiver	Rohde & Schwarz	ESPI	101202	2017/03/10	1 Year
8	Bilog Antenna	Sunol	JB3	A121206	2017/03/14	1 Year
9	Horn Antenna	SCHWARZBECK	BBHA9120D	756	2017/03/14	1 Year
10	Horn Antenna	Penn Engineering	9034	8376	2017/03/14	1 Year
11	Cable	Resenberger	N/A	NO.1	2017/03/07	1 Year
12	Cable	SchwarzBeck	N/A	NO.2	2017/03/07	1 Year
13	Cable	SchwarzBeck	N/A	NO.3	2017/03/07	1 Year
14	Single Phase Power Line Filter	DuoJi	FNF 202B30	N/A	2017/03/07	1 Year
15	Test Receiver	Rohde & Schwarz	ESCI	100492	2017/03/10	1 Year
16	Loop antenna	ARA	PLA-1030/B	1039	2017/03/14	1 Year

NOTE: Equipments listed above have been calibrated and are in the period of validation.

5. 47 CFR Part 15 C Requirements

5.1 ANTENNA REQUIREMENT

5.1.1 Applicable Standard

According to FCC § 15.203 , An intentional radiator shall be designed to ensure that no antenna other than that furnished by the responsible party shall be used with the device. The use of a permanently attached antenna or of an antenna that uses a unique coupling to the intentional radiator shall be considered sufficient to comply with the provisions of this section. The manufacturer may design the unit so that a broken antenna can be replaced by the user, but the use of a standard antenna jack or electrical connector is prohibited. This requirement does not apply to carrier current devices or to devices operated under the provisions of §15.211, §15.213, §15.217, §15.219, or §15.221. Further, this requirement does not apply to intentional radiators that must be professionally installed, such as perimeter protection systems and some field disturbance sensors, or to other intentional radiators which, in accordance with §15.31(d), must be measured at the installation site. However, the installer shall be responsible for ensuring that the proper antenna is employed so that the limits in this part are not exceeded.

5.1.2 Evaluation Criteria

(a) Antenna must be permanently attached to the unit.

(b) Antenna must use a unique type of connector to attach to the EUT.

Unit must be professionally installed, Installer shall be responsible for verifying that the correct antenna is employed with the unit.

5.1.3 Result: Compliance.

The EUT has one integral antenna arrangement, which was permanently attached and the antenna gain is 4.0dBi, fulfill the requirement of this section.

5.2 AC Power Line Conducted Emission

5.2.1 Requirement

A radio apparatus that is designed to be connected to the public utility (AC) power line shall ensure that the radio frequency voltage, which is conducted back onto the AC power line on any frequency or frequencies within the and 150 kHz-30 MHz, shall not exceed the limits in the following table:

Frequency	Maximum RF Line Voltage	
	Q.P.(dBuV)	Average(dBuV)
150kHz-500kHz	66-56	56-46
500kHz-5MHz	56	46
5MHz-30MHz	60	50

****Note:** 1. the lower limit shall apply at the band edges.
2. The limit decreases linearly with the logarithm of the frequency in the range 0.15 MHz to 0.50 MHz

5.2.2 Block Diagram of Test Setup

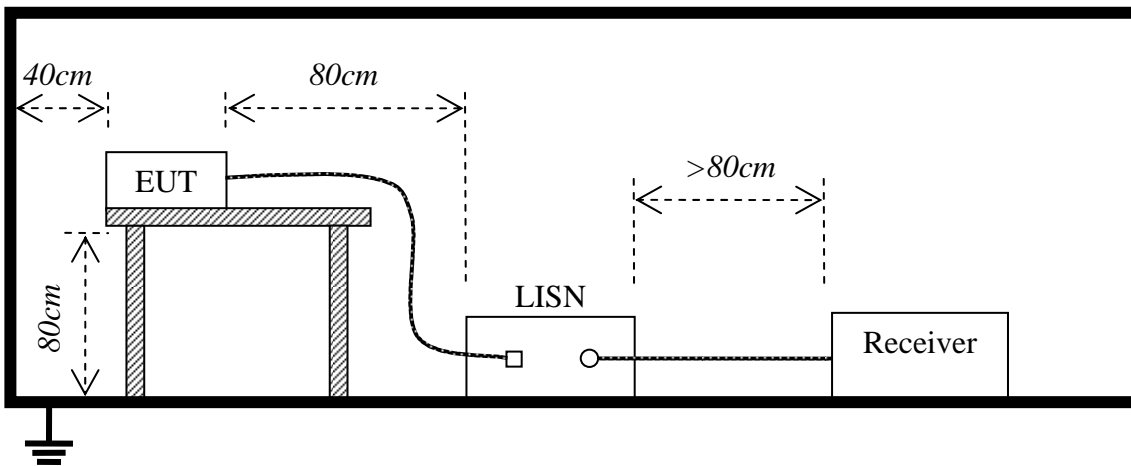

5.2.3 Test procedure

1. The E.U.T and simulators are connected to the main power through a line impedance stabilization network (L.I.S.N.). This provides a 50ohm/50uH coupling impedance for the measuring equipment.
2. Exploratory measurements were made to identify the frequency of the emission that has the highest amplitude relative to the limit;
3. The peripheral devices are also connected to the main power through a LISN that provides a 50ohm/50uH coupling impedance with 50ohm termination. (Please refer to the block diagram of the test setup and photographs).
4. Both sides of A.C. line are checked for maximum conducted interference. In order to find the maximum emission, the relative positions of equipment and all of the interface cables must be changed according to ANSI C63.10:2013 on conducted measurement.
5. The bandwidth of test receiver (ESCI) set at 9 KHz.
6. All data was recorded in the Quasi-peak and average detection mode.

5.2.4 Test Result

PASS

Note: All test modes are performed, only the worst case is recorded in this report.

Please refer the following pages.

EUT:	Monster Solara	M/N:	MNSOL-BLK
Mode:	GFSK	Phase:	L1
Tested by:	SKY(Engineer)	Power:	DC 5V by Adapter
Temperature: / Humidity	23.4°C/ 52.7%	Test date:	2017-04-18

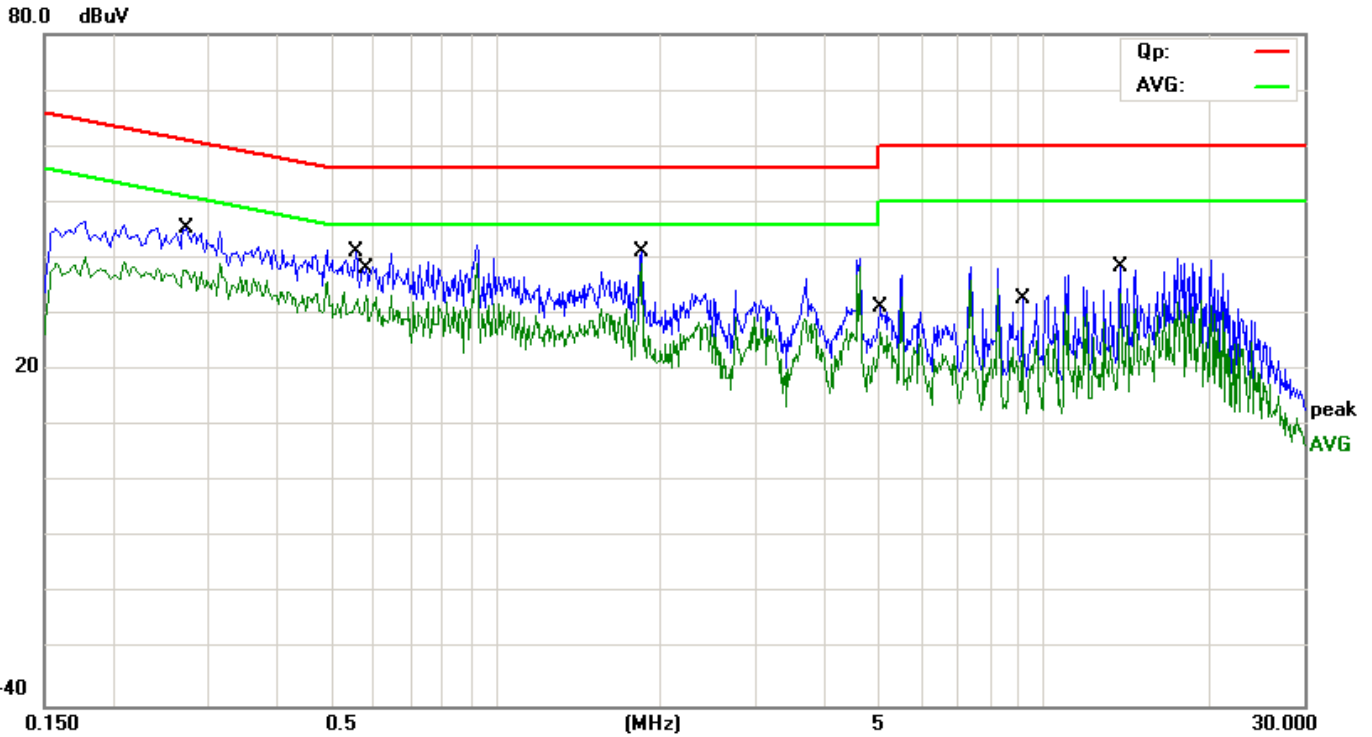

No.	Mk.	Freq. MHz	Reading Level dBuV	Correct Factor dB	Measure- ment dBuV	Limit dBuV	Over dB	Detector	Comment
1		0.2700	28.23	9.60	37.83	51.12	-13.29	AVG	
2		0.2740	35.64	9.60	45.24	61.00	-15.76	QP	
3		0.5580	31.47	9.59	41.06	56.00	-14.94	QP	
4		0.5820	23.61	9.59	33.20	46.00	-12.80	AVG	
5		1.8500	31.65	9.60	41.25	56.00	-14.75	QP	
6	*	1.8500	29.46	9.60	39.06	46.00	-6.94	AVG	
7		5.0460	21.62	9.63	31.25	60.00	-28.75	QP	
8		5.0460	17.03	9.63	26.66	50.00	-23.34	AVG	
9		9.1820	22.97	9.68	32.65	60.00	-27.35	QP	
10		9.1820	17.35	9.68	27.03	50.00	-22.97	AVG	
11		13.8860	28.74	9.70	38.44	60.00	-21.56	QP	
12		13.8860	23.91	9.70	33.61	50.00	-16.39	AVG	

*:Maximum data x:Over limit !:over margin

EUT:	Monster Solara	M/N:	MNSOL-BLK
Mode:	GFSK	Phase:	N
Tested by:	SKY(Engineer)	Power:	DC 5V by Adapter
Temperature: / Humidity	23.4°C/ 52.7%	Test date:	2017-04-18

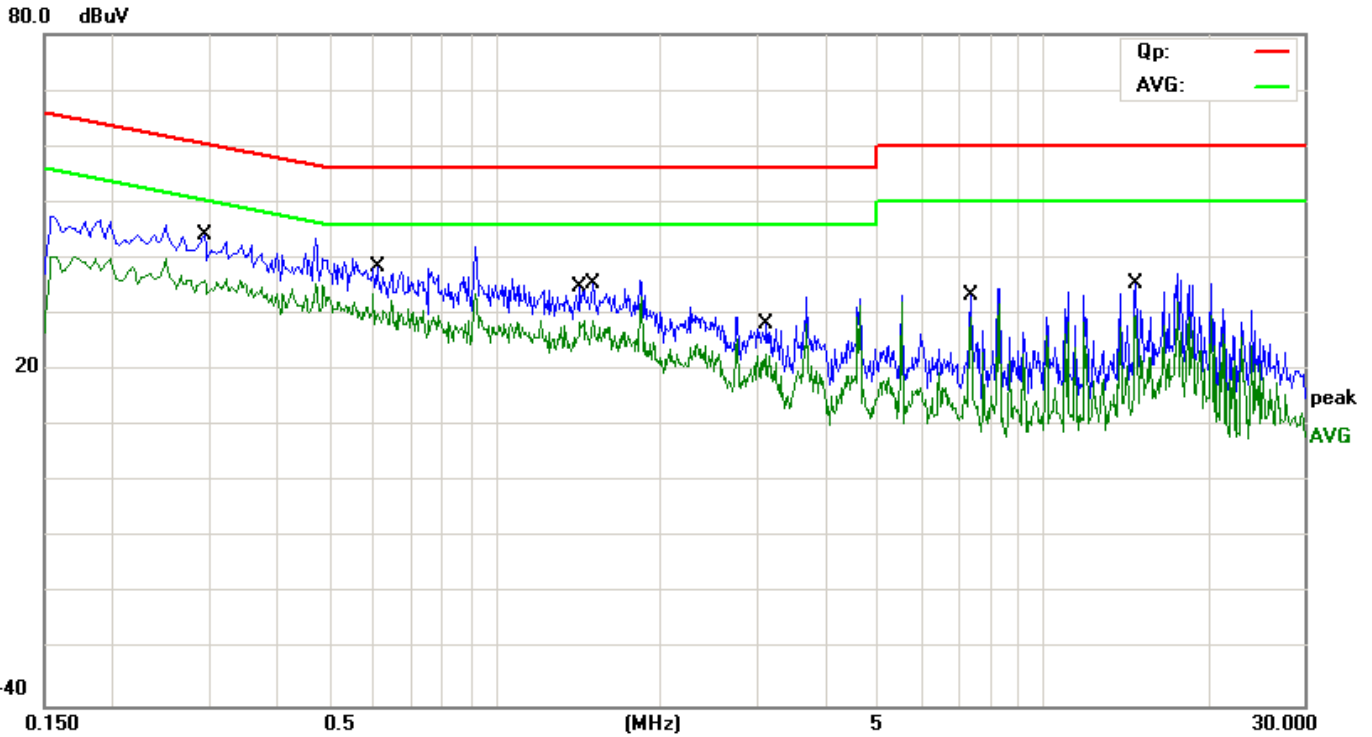

No.	Mk.	Freq. MHz	Reading Level dBuV	Correct Factor dB	Measure- ment dBuV	Limit dBuV	Over dB	Detector	Comment
1		0.2940	34.55	9.59	44.14	60.41	-16.27	QP	
2		0.2940	26.39	9.59	35.98	50.41	-14.43	AVG	
3	*	0.5980	24.19	9.59	33.78	46.00	-12.22	AVG	
4		0.6100	28.97	9.59	38.56	56.00	-17.44	QP	
5		1.4300	25.22	9.60	34.82	56.00	-21.18	QP	
6		1.5100	19.29	9.60	28.89	46.00	-17.11	AVG	
7		3.1260	18.70	9.61	28.31	56.00	-27.69	QP	
8		3.1260	13.32	9.61	22.93	46.00	-23.07	AVG	
9		7.4060	23.55	9.66	33.21	60.00	-26.79	QP	
10		7.4060	19.79	9.66	29.45	50.00	-20.55	AVG	
11		14.8100	25.63	9.70	35.33	60.00	-24.67	QP	
12		14.8100	19.94	9.70	29.64	50.00	-20.36	AVG	

*:Maximum data x:Over limit !:over margin

5.3 Radiated Emission

5.3.1 Requirement

According to FCC section 15.247(d), In addition, radiated emissions which fall in the restricted bands, as defined in §15.205(a), must also comply with the radiated emission limits specified in §15.209(a) (see §15.205(c)).

According to FCC section 15.209(a), Except as provided elsewhere in this subpart, the emissions from an intentional radiator shall not exceed the field strength levels specified in the following table:

Frequency (MHz)	Field Strength ($\mu\text{V}/\text{m}$ at 3-meter)	Test Distance (m)	Field Strength ($\text{dB}\mu\text{V}/\text{m}$ at 3-meter)
0.009 - 0.490	2400/F(kHz)	300	
0.490 - 1.705	24000/F(kHz)	30	
1.705-30	30	30	
30-88	100	3	40
88-216	150	3	43.5
216-960	200	3	46
Above 960	500	3	54

Note:

1. For Above 1000MHz, the emission limit in this paragraph is based on measurement instrumentation employing an average detector, measurement using instrumentation with a peak detector function, corresponding to 20dB above the maximum permitted average limit.

2. For above 1000MHz, limit field strength of harmonics: 54dBuV/m@3m (AV) and 74dBuV/m@3m (PK)

In addition, radiated emissions which fall in the restricted bands, as defined in §15.205(a), must also comply with the radiated emission limits specified in §15.209(a) (see §15.205(c)).

5.3.2 Test Configuration

Test Setup:

1) For radiated emissions from 9kHz to 30MHz

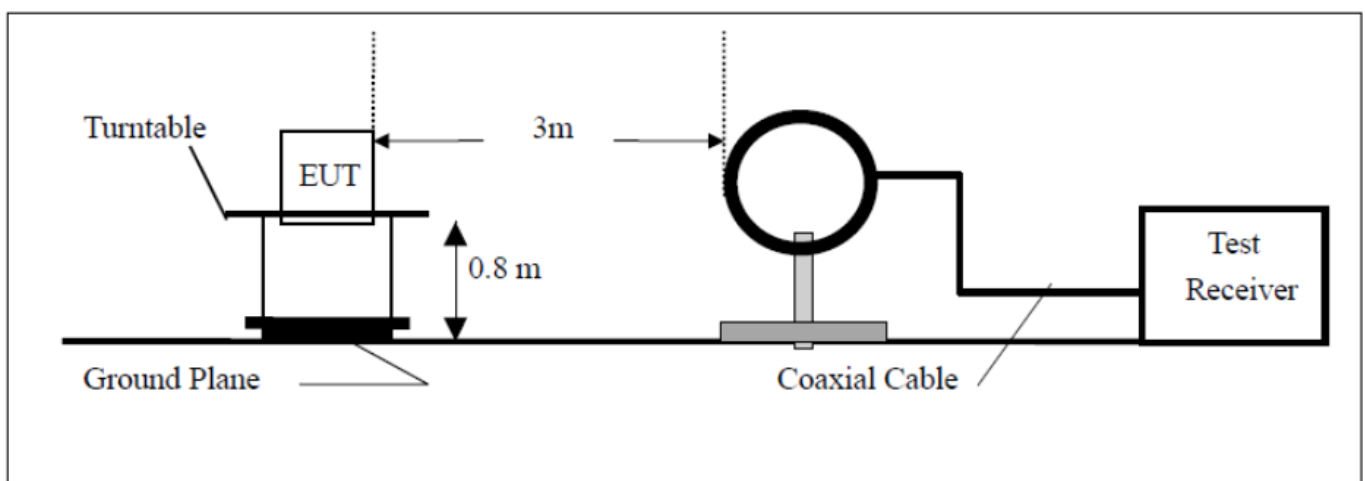

2) For radiated emissions from 30MHz to 1GHz

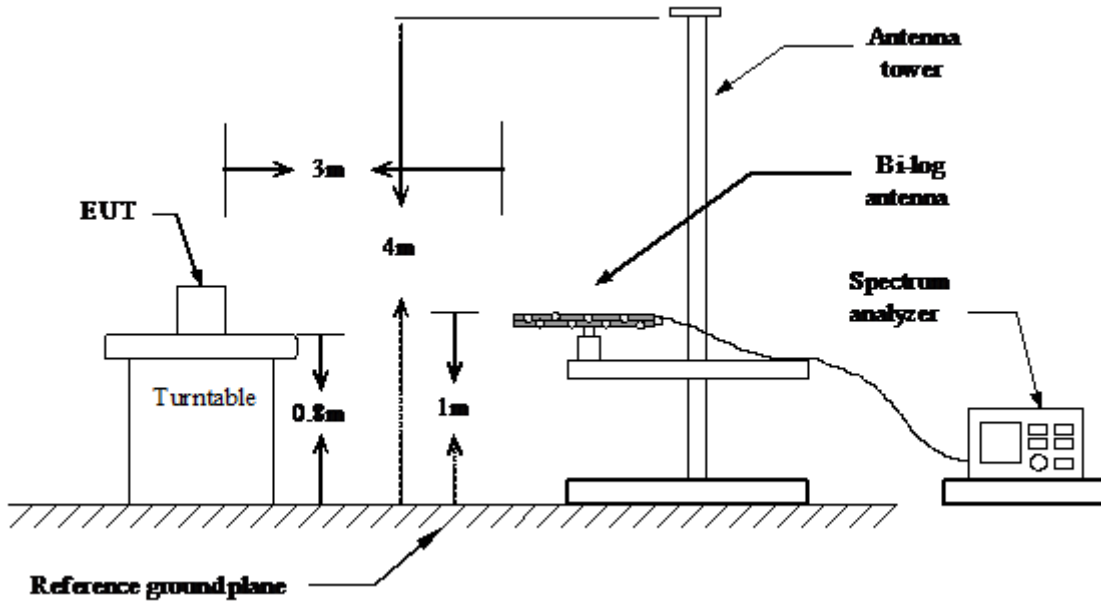

3) For radiated emissions above 1GHz

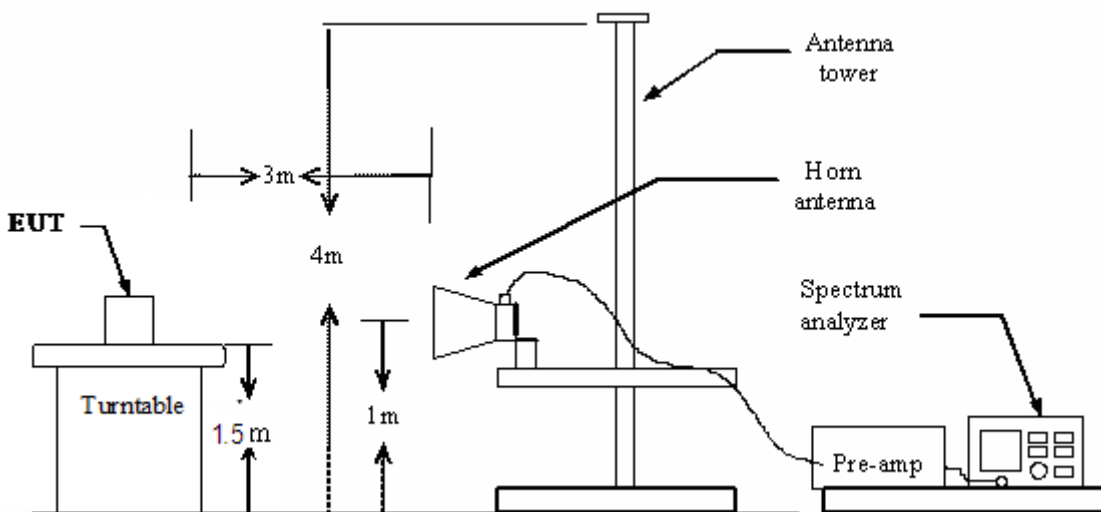
**5.3.3 Test Procedure:**

1. The EUT was placed on the top of a wooden table 0.8 meters (for measurement at frequency below 1GHz) and a wooden table 1.5 meters (for measurement at frequency above 1GHz) above the ground at a 3 meter semi-anechoic chamber. The table was rotated 360 degrees to determine the position of the highest radiation.
2. The EUT was set 3 meters away from the interference-receiving antenna, which was mounted on the top of a variable-height antenna tower.
3. The antenna height is varied from one meter to four meters above the ground to determine the maximum value of the field strength. Both horizontal and vertical polarizations of the antenna are set to make the measurement.
4. For each suspected emission, the EUT was arranged to its worst case and then the antenna was tuned to heights from 1 meter to 4 meters (for the test frequency of below 30MHz, the antenna was tuned to heights 1 meter, for the test frequency of above 1GHz, horn antenna opening in the test would have been facing the EUT when rise or fall) and the table was turned from 0 degrees to 360 degrees to find the maximum reading.

6. Set the spectrum analyzer in the following setting as:

Below 1GHz: PEAK: RBW=100 kHz / VBW=300 kHz / Sweep=AUTO QP: RBW=120 kHz / Sweep=AUTO
Above 1GHz: (a)PEAK: RBW=VBW=1MHz / Sweep=AUTO
(b)AVERAGE: RBW=1MHz / VBW=10Hz / Sweep=AUTO

The test-receiver system was set to Peak Detect Function and Specified Bandwidth with Maximum Hold Mode.

7. If the emission level of the EUT in peak mode was 10dB lower than the limit specified, then testing could be stopped and the peak values of the EUT would be reported. Otherwise the emissions that did not have 10dB margin would be re-tested one by one using peak, quasi-peak or average method as specified and then reported in a data sheet.

5.3.4 Test Result

Pass

Remark:

1. Pre-scan all kind of the place mode (X-axis, Y-axis, Z-axis), and found the Y-axis which it is worse case.
2. Found the GFSK modulation Low channel is worse case in above 1GHz and below 1GHz.
3. For radiated emissions from 9kHz to 30MHz, Test results show that the margin of over -20db.

Note: All test modes are performed, only the worst case is recorded in this report.

Please refer the following pages

Below 1GHz:

EUT:	Monster Solara	M/N:	MNSOL-BLK
Mode:	GFSK-CH0	Polarization:	Horizontal
Tested by:	SKY(Engineer)	Power:	DC 5V by Adapter
Temperature: / Humidity	24.0°C/ 50.5%	Test date:	2017-04-19

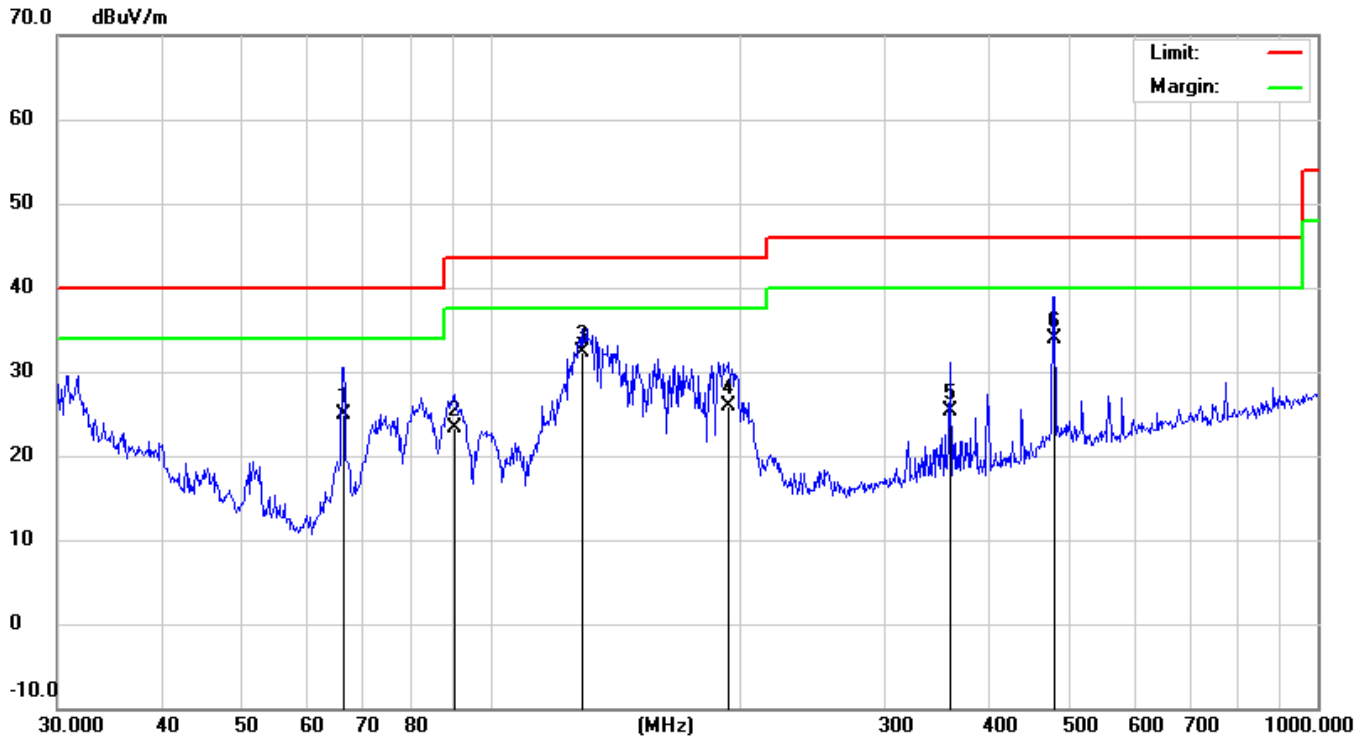

No.	Mk.	Freq.	Reading Level	Correct Factor	Measurement	Limit	Over	Antenna Height	Table Degree	
		MHz	dBuV	dB	dBuV/m	dBuV/m	dB	cm	degree	Comment
1		66.4989	16.84	8.05	24.89	40.00	-15.11			QP
2		90.5374	15.30	7.99	23.29	43.50	-20.21			QP
3	*	129.0146	18.37	13.84	32.21	43.50	-11.29			QP
4		194.4534	13.80	12.03	25.83	43.50	-17.67			QP
5		359.1860	10.60	14.62	25.22	46.00	-20.78			QP
6		480.5276	16.57	17.25	33.82	46.00	-12.18			QP

*:Maximum data x:Over limit !:over margin

EUT:	Monster Solara	M/N:	MNSOL-BLK
Mode:	GFSK-CH0	Polarization:	Vertical
Tested by:	SKY(Engineer)	Power:	DC 5V by Adapter
Temperature: / Humidity	24.0°C/ 50.5%	Test date:	2017-04-19

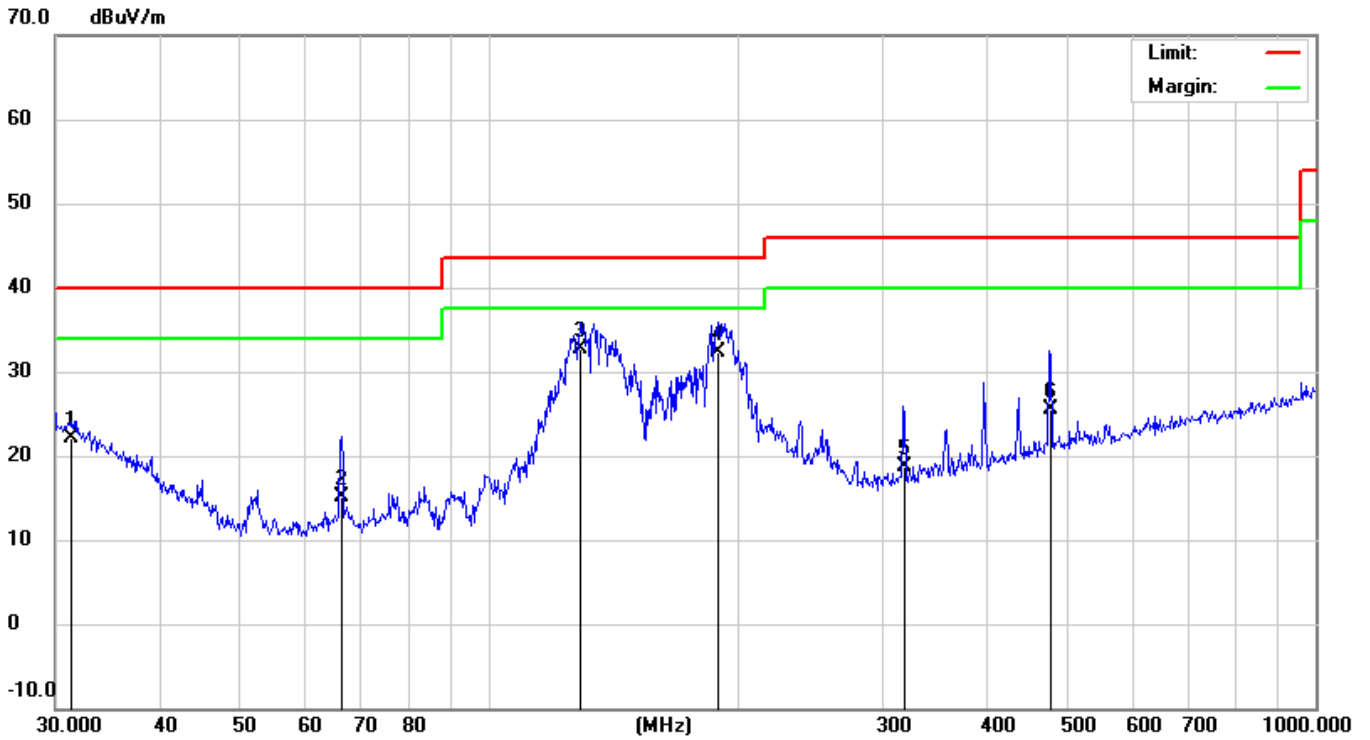

No.	Mk.	Freq. MHz	Reading Level dBuV	Correct Factor dB	Measure- ment dBuV/m	Limit dBuV/m	Over dB	Detector	Antenna Height cm	Table Degree degree	Comment
1		31.3992	2.10	19.95	22.05	40.00	-17.95	QP			
2		66.4989	6.98	8.05	15.03	40.00	-24.97	QP			
3	*	129.4677	18.97	13.82	32.79	43.50	-10.71	QP			
4		189.7385	20.36	11.89	32.25	43.50	-11.25	QP			
5		317.7011	4.80	13.84	18.64	46.00	-27.36	QP			
6		477.1694	8.40	17.17	25.57	46.00	-20.43	QP			

*:Maximum data x:Over limit !:over margin

Above 1GHz:

EUT:	Monster Solara	M/N:	MNSOL-BLK
Mode:	GFSK-CH0	Polarization:	Horizontal
Tested by:	SKY(Engineer)	Power:	DC 5V by Adapter
Temperature: / Humidity	24.2°C/ 51.3%	Test date:	2017-04-19

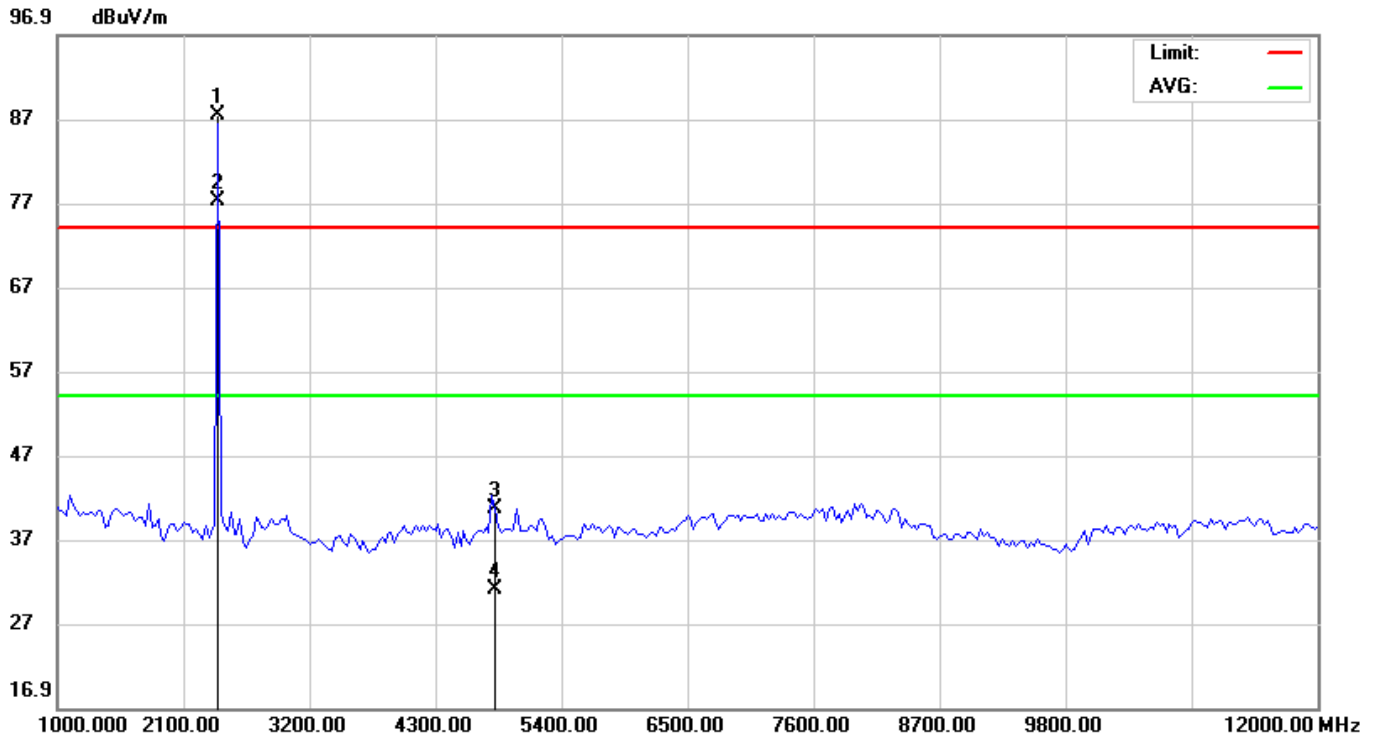

No.	Mk.	Freq. MHz	Reading Level dBuV	Correct Factor dB	Measure- ment dBuV/m	Limit dBuV/m	Over dB	Detector	Antenna Height cm	Table Degree degree	Comment
1	X	2402.500	95.86	-8.43	87.43	74.00	13.43	peak			
2	*	2402.500	85.60	-8.43	77.17	54.00	23.17	AVG			
3		4804.000	46.75	-6.15	40.60	74.00	-33.40	peak			
4		4804.000	37.20	-6.15	31.05	54.00	-22.95	AVG			

*:Maximum data x:Over limit !:over margin

EUT:	Monster Solara	M/N:	MNSOL-BLK
Mode:	GFSK-CH0	Polarization:	Horizontal
Tested by:	SKY(Engineer)	Power:	DC 5V by Adapter
Temperature: / Humidity	24.2°C/ 51.3%	Test date:	2017-04-19

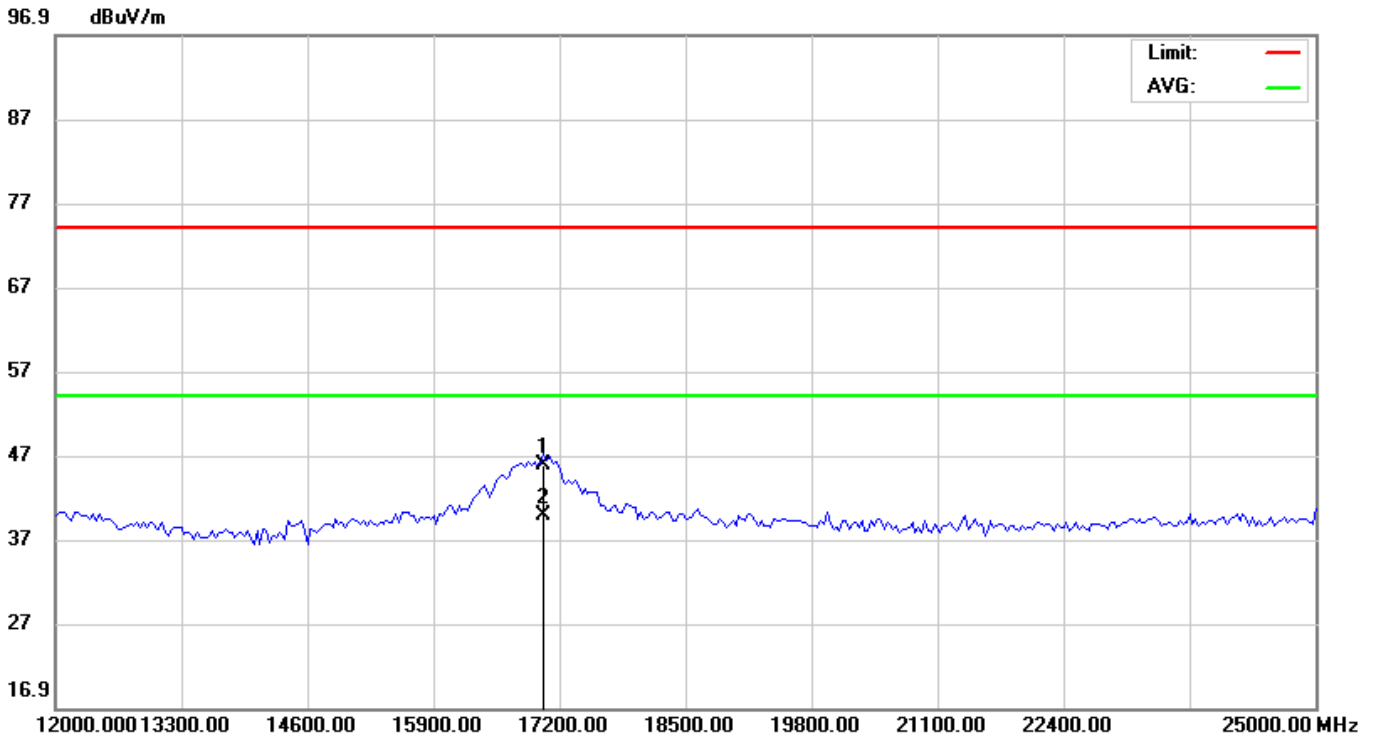

No.	Mk.	Freq. MHz	Reading Level dBuV	Correct Factor dB	Measure- ment dBuV/m	Limit dBuV/m	Over dB	Detector	Antenna Height cm	Table Degree degree	Comment
1		17037.50	39.01	6.73	45.74	74.00	-28.26	peak			
2	*	17037.50	33.15	6.73	39.88	54.00	-14.12	AVG			

*:Maximum data x:Over limit !:over margin

EUT:	Monster Solara	M/N:	MNSOL-BLK
Mode:	GFSK-CH0	Polarization:	Vertical
Tested by:	SKY(Engineer)	Power:	DC 5V by Adapter
Temperature: / Humidity	24.2°C/ 51.3%	Test date:	2017-04-19

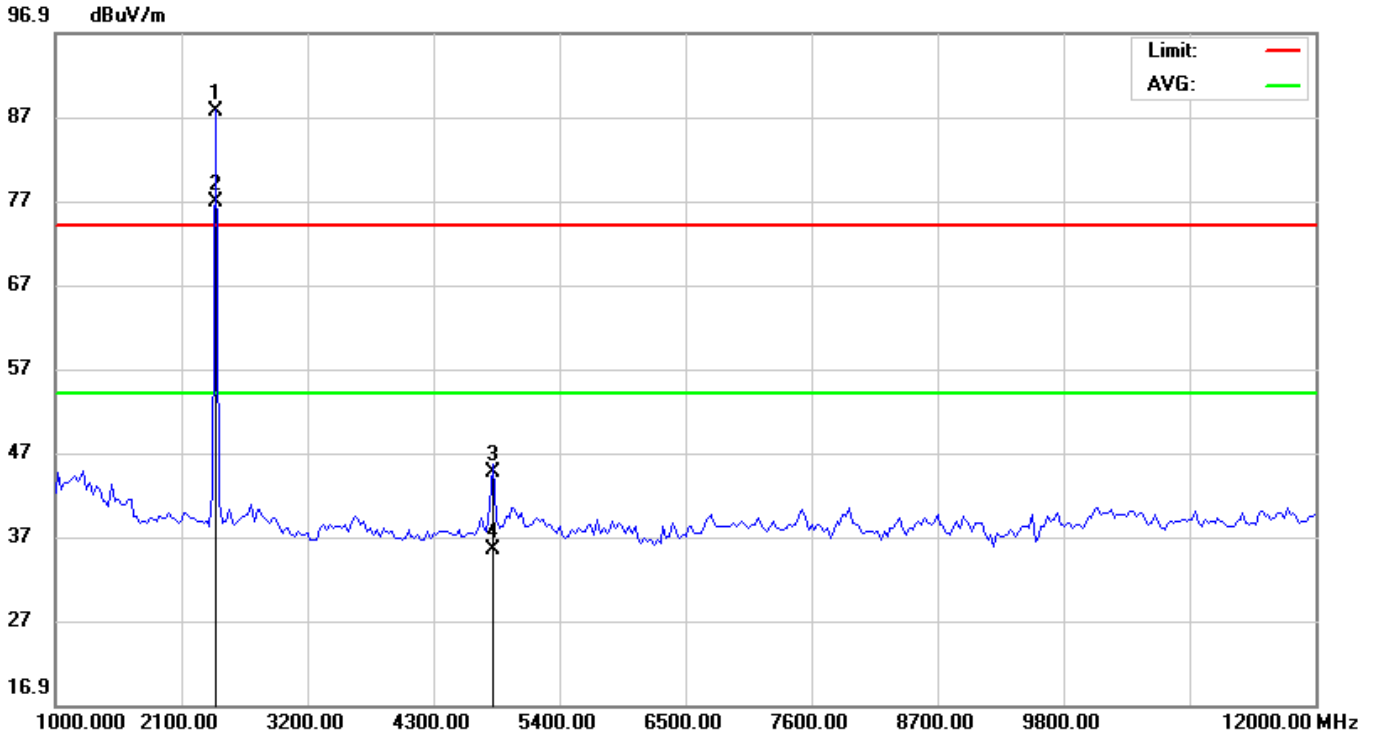

No.	Mk.	Freq. MHz	Reading Level dBuV	Correct Factor dB	Measure- ment dBuV/m	Limit dBuV/m	Over dB	Detector	Antenna Height cm	Table Degree	Comment
1	X	2402.500	96.01	-8.43	87.58	74.00	13.58	peak			
2	*	2402.500	85.20	-8.43	76.77	54.00	22.77	AVG			
3		4804.000	50.76	-6.15	44.61	74.00	-29.39	peak			
4		4804.000	41.50	-6.15	35.35	54.00	-18.65	AVG			

*:Maximum data x:Over limit !:over margin

EUT:	Monster Solara	M/N:	MNSOL-BLK
Mode:	GFSK-CH0	Polarization:	Vertical
Tested by:	SKY(Engineer)	Power:	DC 5V by Adapter
Temperature: / Humidity	24.2°C/ 51.3%	Test date:	2017-04-19

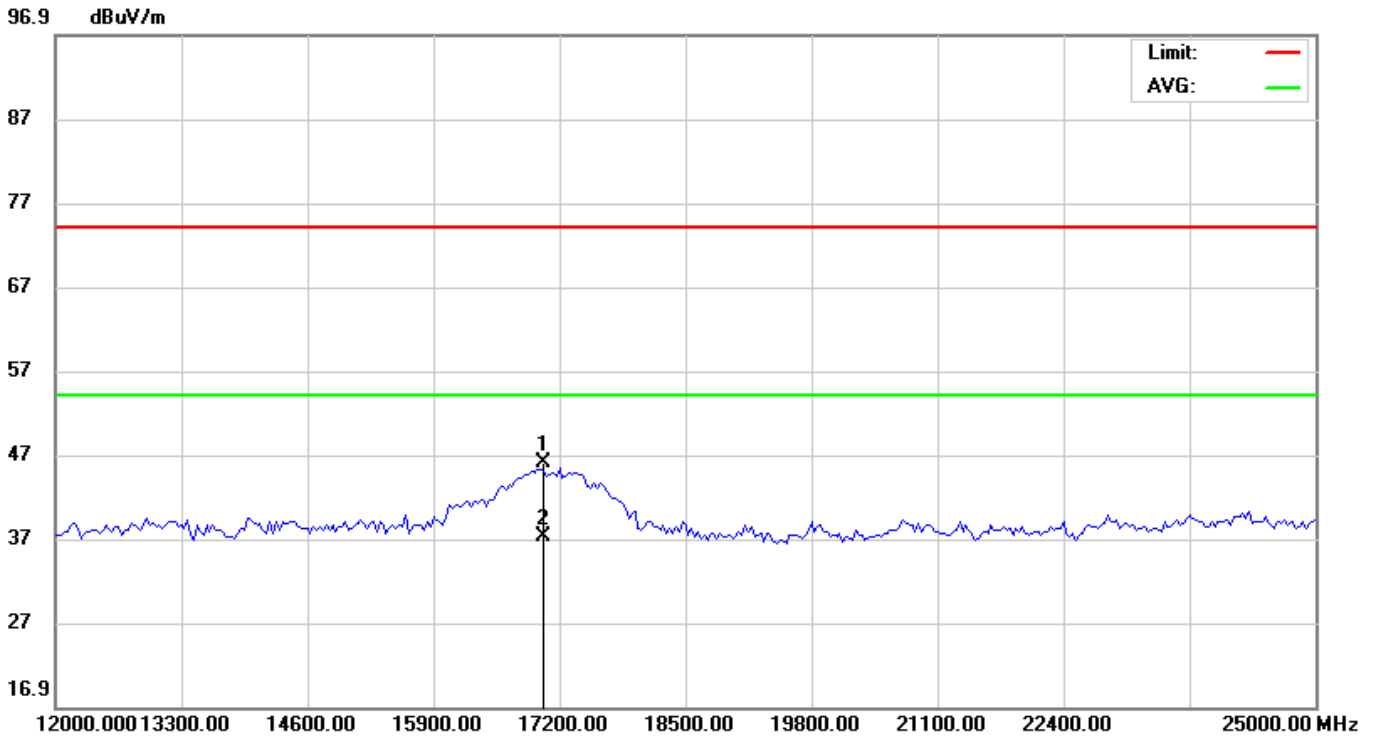

No.	Mk.	Freq. MHz	Reading Level dBuV	Correct Factor dB	Measure- ment dBuV/m	Limit dBuV/m	Over dB	Detector	Antenna Height cm	Table Degree degree	Comment
1		17006.00	39.01	6.90	45.91	74.00	-28.09	peak			
2	*	17006.00	30.24	6.90	37.14	54.00	-16.86	AVG			

*:Maximum data x:Over limit !:over margin

5.4 Conducted Peak Output Power

5.4.1 Requirement

According to FCC section 15.247(b)(3), for systems using digital modulation in the 902-928 MHz, 2400-2483.5 MHz, and 5725-5850 MHz bands: 1 Watt. As an alternative to a peak power measurement, compliance with the one Watt limit can be based on a measurement of the maximum conducted output power. Maximum Conducted Output Power is defined as the total transmit power delivered to all antennas and antenna elements averaged across all symbols in the signaling alphabet when the transmitter is operating at its maximum power control level. Power must be summed across all antennas and antenna elements. The average must not include any time intervals during which the transmitter is off or is transmitting at a reduced power level. If multiple modes of operation are possible (e.g., alternative modulation methods), the maximum conducted output power is the highest total transmit power occurring in any mode.

5.4.2 Block Diagram of Test Setup



5.5.3 Test Procedure

1. Place the EUT on a bench and set in transmitting mode.
2. Remove the antenna from the EUT and then connect a low loss RF cable from the antenna port to an EMI test receiver.
3. Add a correction factor to the display.

5.4.4 Test Result

Test Item:	Peak Output Power	Temperature :	21°C
Tested by:	Sunny (Engineer)	Relative Humidity :	57%

Mode	Channel	Frequency (MHz)	Peak Output Power(dBm)	Limit		Pass/Fail
				(mW)	(dBm)	
GFSK	Low	2402	-0.992	1000	30	Pass
	Middle	2440	-0.974	1000	30	Pass
	High	2480	0.188	1000	30	Pass

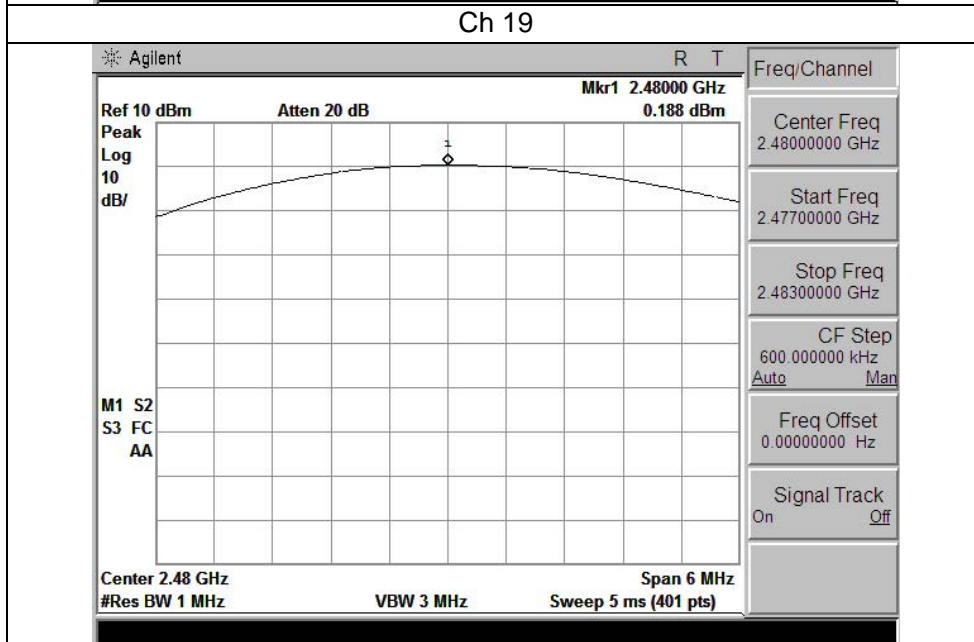
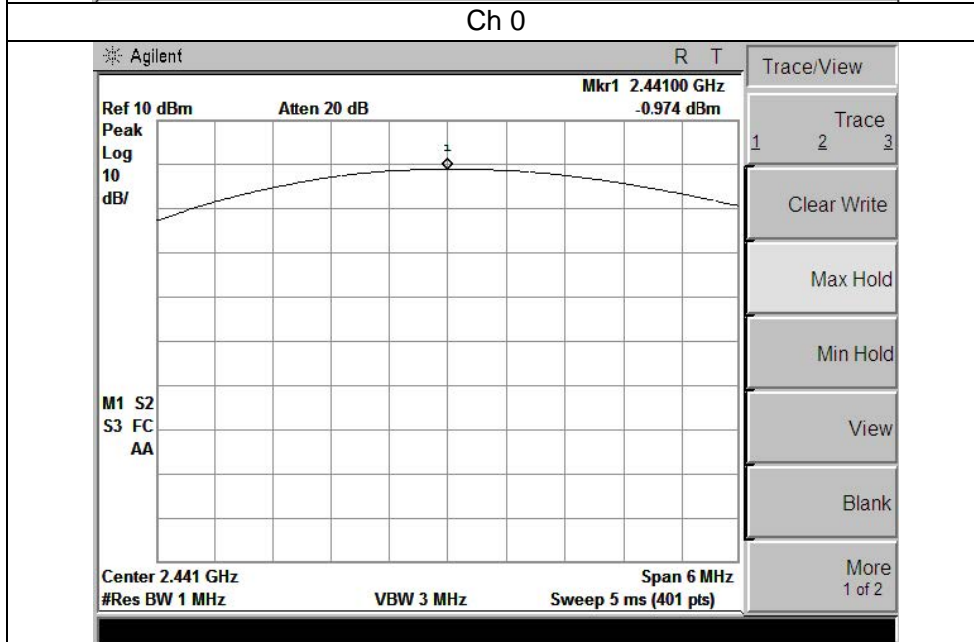
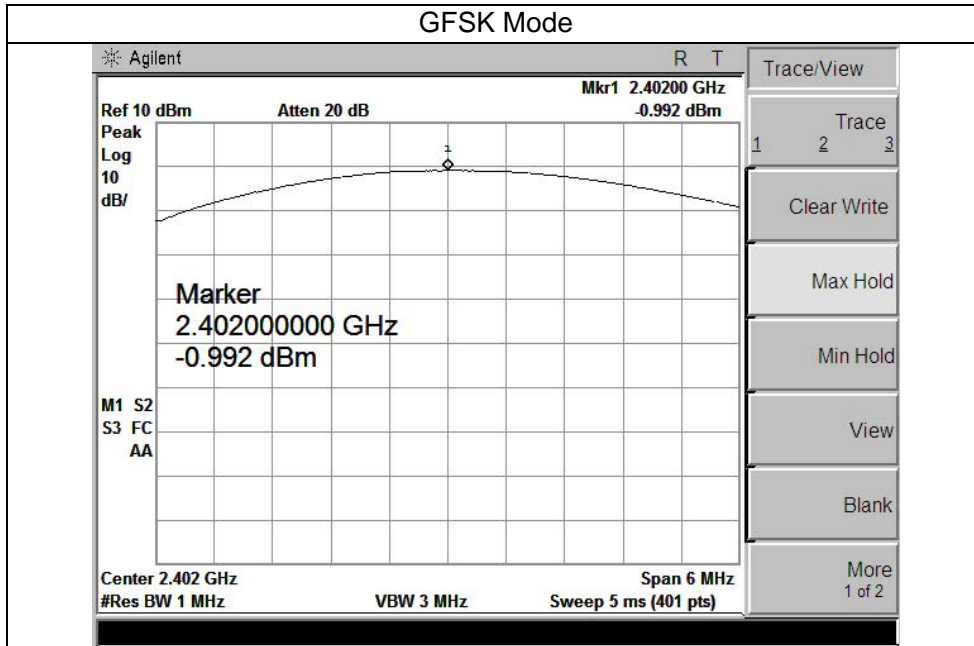

Ch 39

5.5 6dB Emission Bandwidth

5.5.1 Test Requirement

Systems using digital modulation techniques may operate in the 902–928 MHz, 2400–2483.5 MHz, and 5725–5850 MHz bands. The minimum 6 dB bandwidth shall be at least 500 kHz.

5.6.2 Block Diagram of Test Setup



5.5.3 Test Procedure

According to KDB 558074 D01 DTS Meas Guidance v03r02 clause 8.1 Option 1:

- a) Set RBW = 100 kHz.
- b) Set the video bandwidth (VBW) $\geq 3 \times \text{RBW}$.
- c) Detector = Peak.
- d) Trace mode = max hold.
- e) Sweep = auto couple.
- f) Allow the trace to stabilize.
- g) Measure the maximum width of the emission that is constrained by the frequencies associated with the two outermost amplitude points (upper and lower frequencies) that are attenuated by 6 dB relative to the maximum level measured in the fundamental emission.

5.5.4 Test Result

Test Item:	6dB Emission Bandwidth	Temperature :	21°C
Tested by:	Sunny (Engineer)	Relative Humidity :	57%

Mode	Channel	Frequency (MHz)	6dB Bandwidth(KHz)	Limit(KHz)
GFSK	Low	2402	532.973	≥ 500
	Middle	2440	539.399	≥ 500
	High	2480	536.062	≥ 500

GFSK Mode

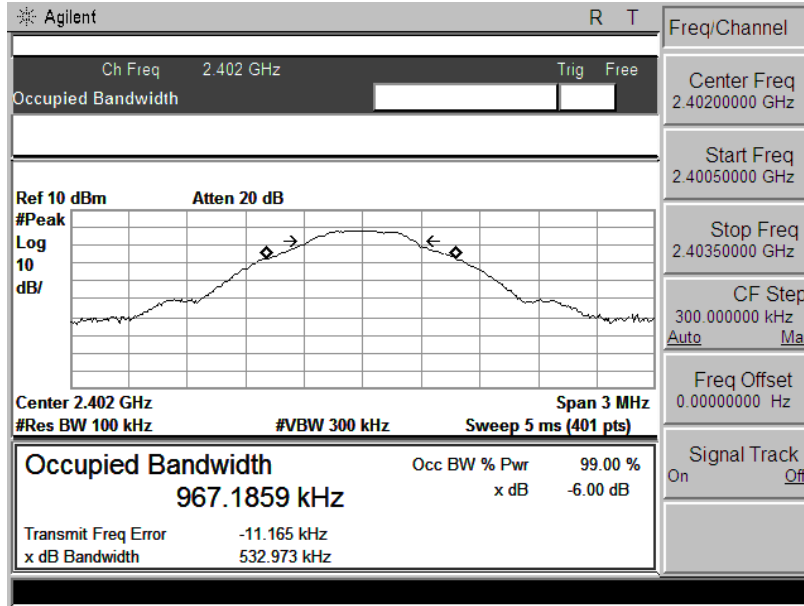

Ch 0

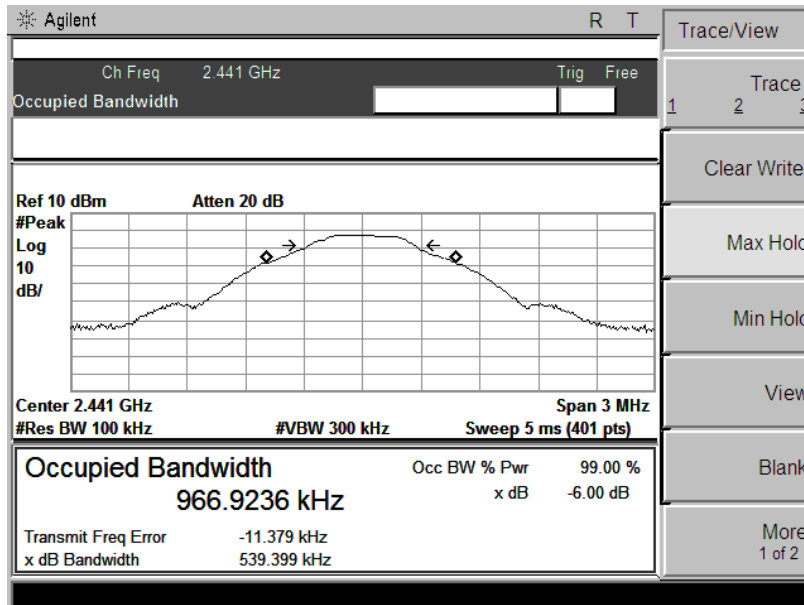

Ch 19

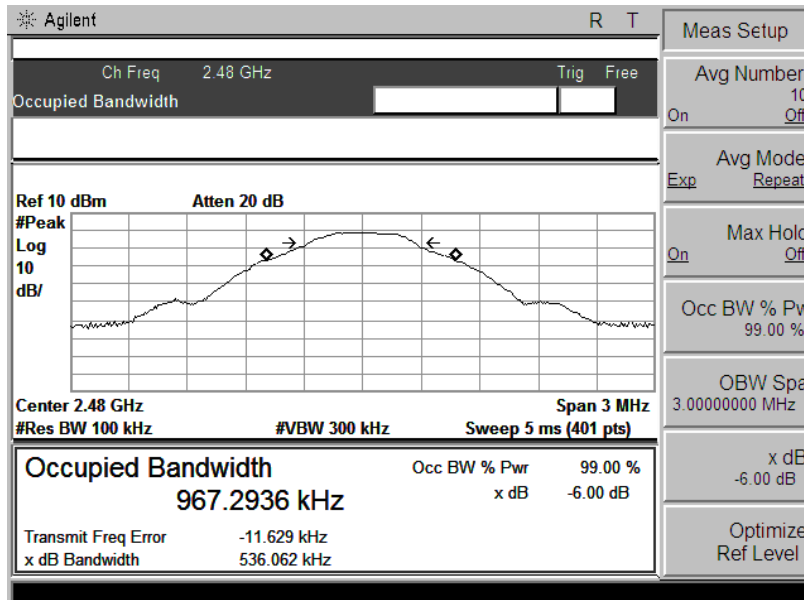

Ch 39

5.6 POWER SPECTRAL DENSITY

5.6.1 Applicable Standard

For digitally modulated systems, the power spectral density conducted from the intentional radiator to the antenna shall not be greater than 8 dBm in any 3 kHz band during any time interval of continuous transmission. This power spectral density shall be determined in accordance with the provisions of paragraph (b) of this section. The same method of determining the conducted output power shall be used to determine the power spectral density.

5.6.2 Block Diagram of Test Setup



5.6.3 Test Procedure

According to KDB 558074 D01 DTS Meas Guidance v03r01clause10.2:

- a) Set analyzer center frequency to DTS channel center frequency.
- b) Set the span to 1.5 times the DTS bandwidth.
- c) Set the RBW to: $3 \text{ kHz} \leq \text{RBW} \leq 100 \text{ kHz}$.
- d) Set the VBW $\geq 3 \times \text{RBW}$.
- e) Detector = peak.
- f) Sweep time = auto couple.
- g) Trace mode = max hold.
- h) Allow trace to fully stabilize.
- i) Use the peak marker function to determine the maximum amplitude level within the RBW.
- j) If measured value exceeds limit, reduce RBW (no less than 3 kHz) and repeat.

5.6.4 Test Result

Test Item:	POWER SPECTRAL DENSITY	Temperature :	21°C
Tested by:	Sunny (Engineer)	Relative Humidity :	57%

Mode	Channel	Frequency (MHz)	PSD (dBm/3kHz)	Limit (dBm/3kHz)	Result
GFSK	Low	2402	-11.09	≤ 8	Pass
	Middle	2440	-11.75	≤ 8	Pass
	High	2480	-10.37	≤ 8	Pass

GFSK Mode

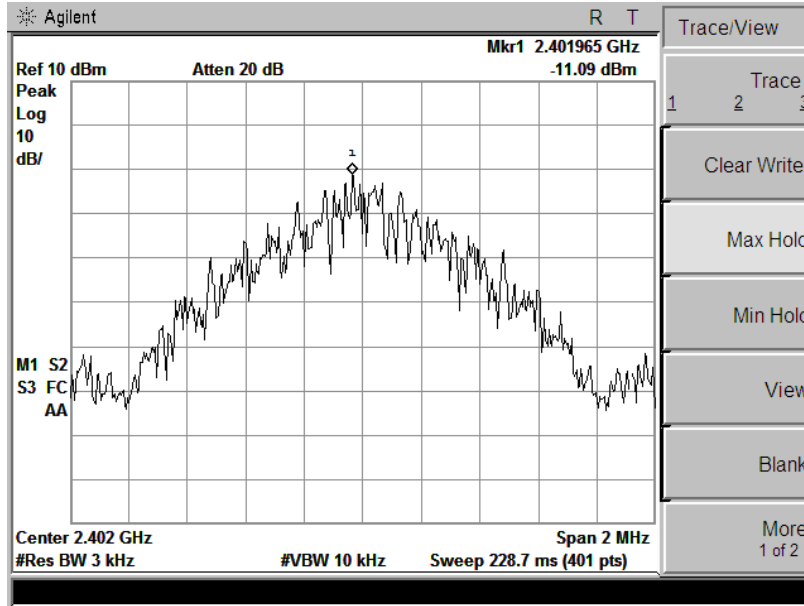

Ch 0

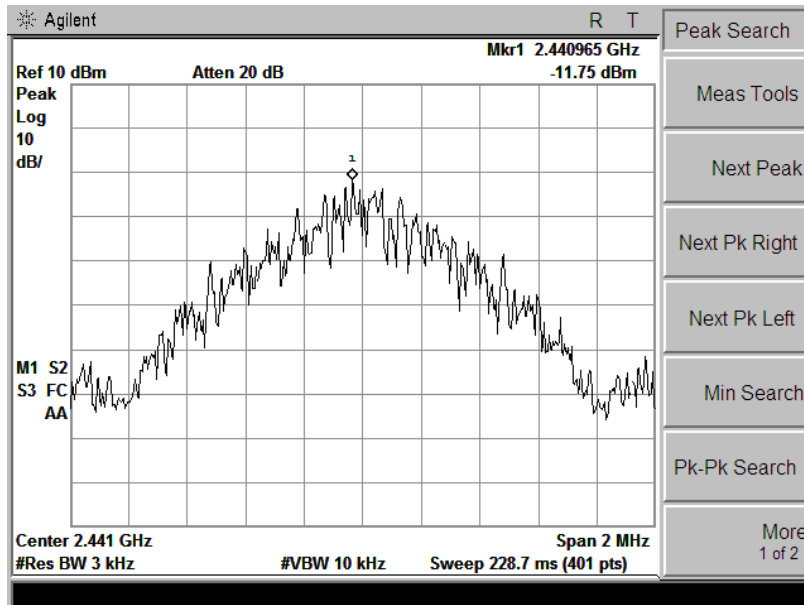

Ch 19

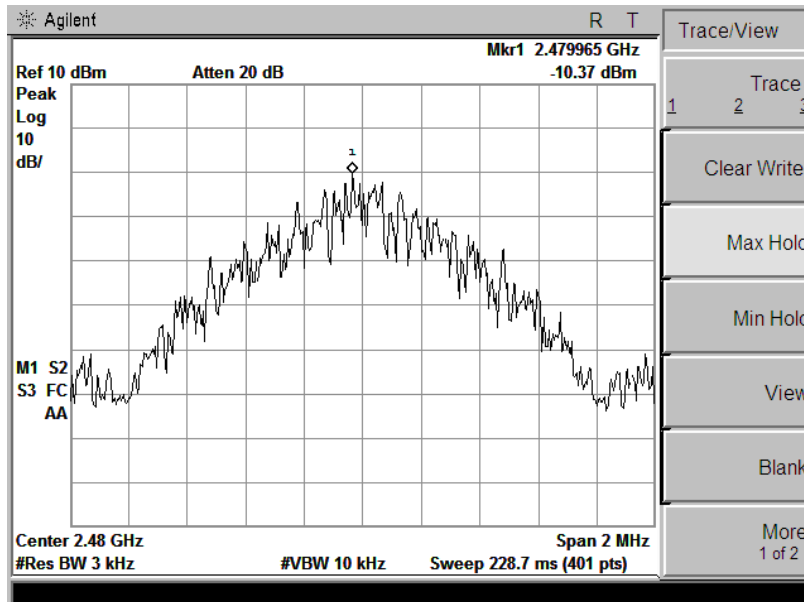

Ch 39

5.7 Band Edge and Conducted Spurious Emissions

5.7.1 Test Requirement

In any 100 kHz bandwidth outside the frequency band in which the spread spectrum or digitally modulated intentional radiator is operating, the radio frequency power that is produced by the intentional radiator shall be at least 20 dB below that in the 100 kHz bandwidth within the band that contains the highest level of the desired power, based on either an RF conducted or a radiated measurement, provided the transmitter demonstrates compliance with the peak conducted power limits. If the transmitter complies with the conducted power limits based on the use of RMS averaging over a time interval, as permitted under paragraph (b)(3) of this section, the attenuation required under this paragraph shall be 30 dB instead of 20 dB. Attenuation below the general limits specified in §15.209(a) is not required.

5.7.2 Test Procedure

1. Check the calibration of the measuring instrument using either an internal calibrator or a known signal from an external generator.
2. Remove the antenna from the EUT and then connect to a low loss RF cable from the antenna port to a EMI test receiver, then turn on the EUT and make it operate in transmitting mode. Then set it to Low Channel and High Channel within its operating range, and make sure the instrument is operated in its linear range.
3. Set both RBW and VBW of spectrum analyzer to 100 kHz with a convenient frequency span including 100 kHz bandwidth from band edge.
4. Measure the highest amplitude appearing on spectral display and set it as a reference level. Plot the graph with marking the highest point and edge frequency.
5. Repeat above procedures until all measured frequencies were complete.

5.7.3 Test Result

Pass

Remark:

Test Item:	Band Edge	Temperature :	21°C
Tested by:	Sunny (Engineer)	Relative Humidity :	57%

GFSK Mode

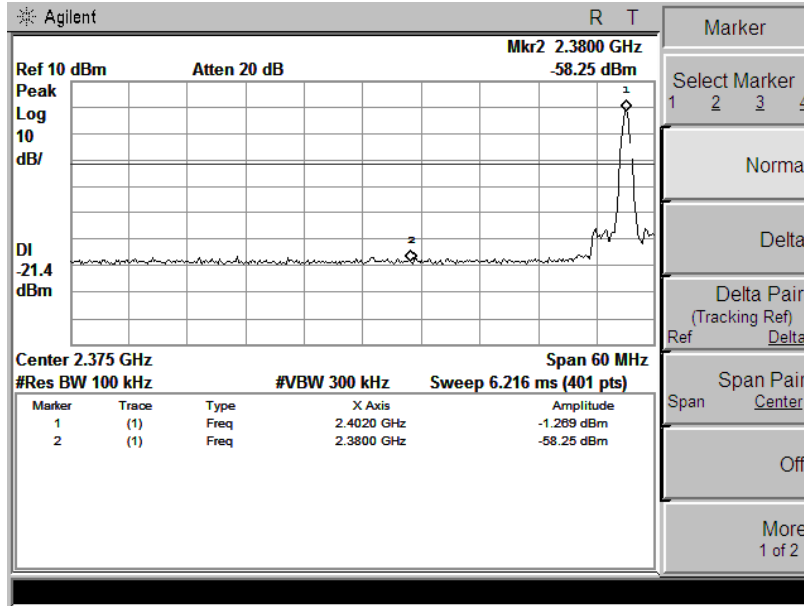

Band Edge, Left Side

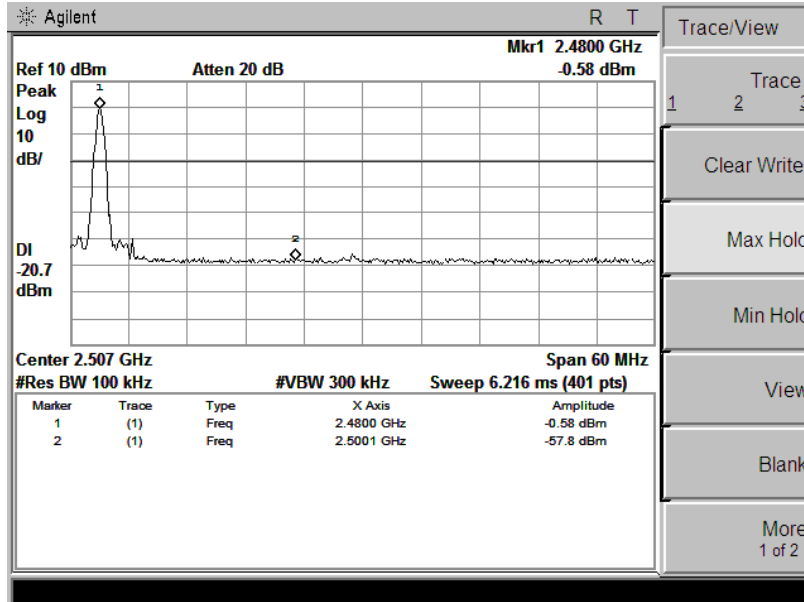

Band Edge, Right Side

Conducted Spurious Emissions

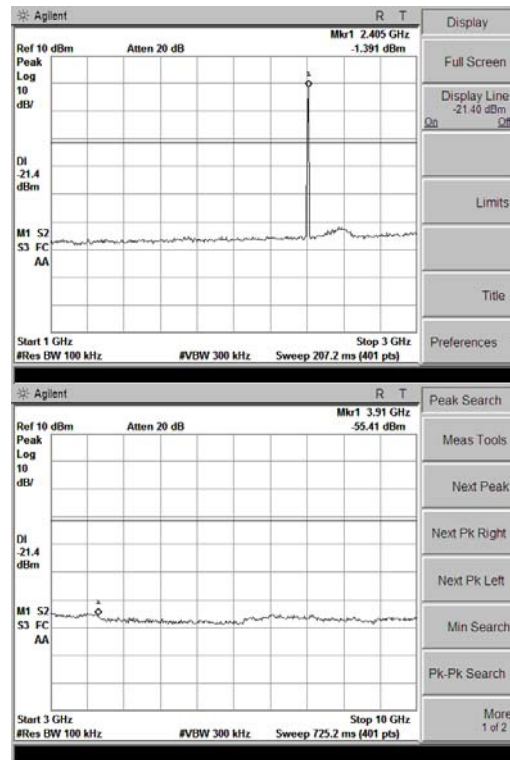

GFSK Mode, Ch0

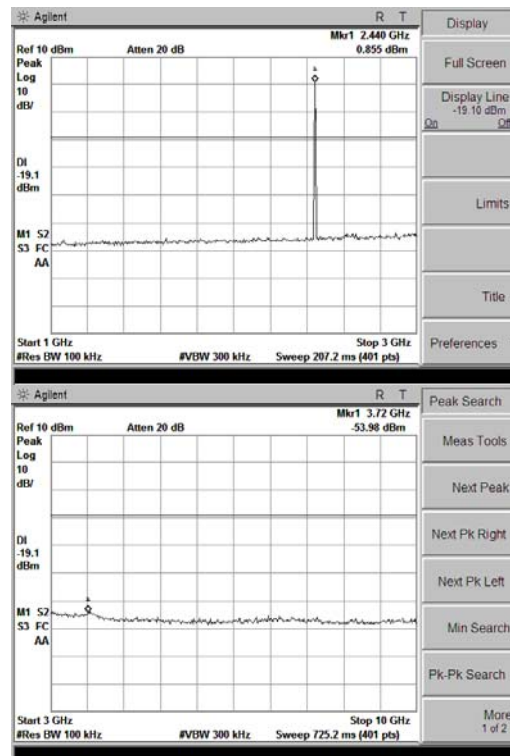
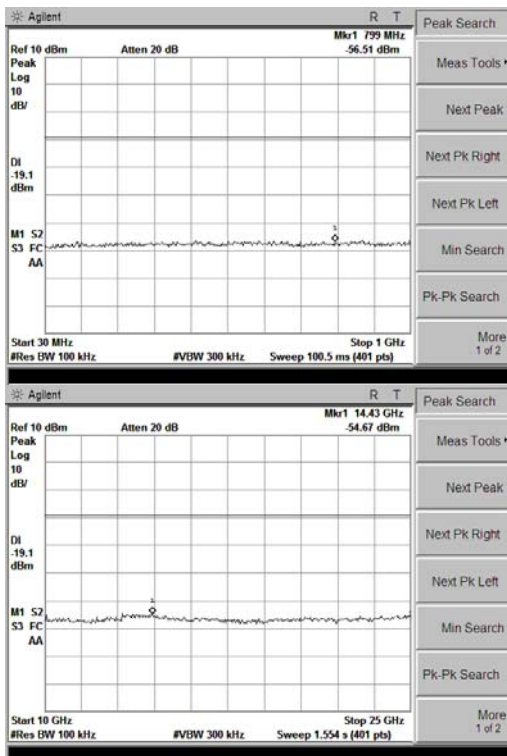

GFSK Mode, Ch19

Conducted Spurious Emissions

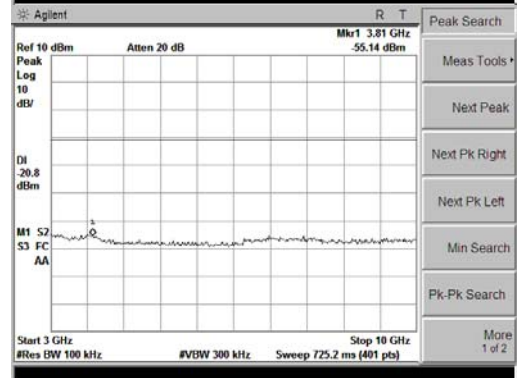
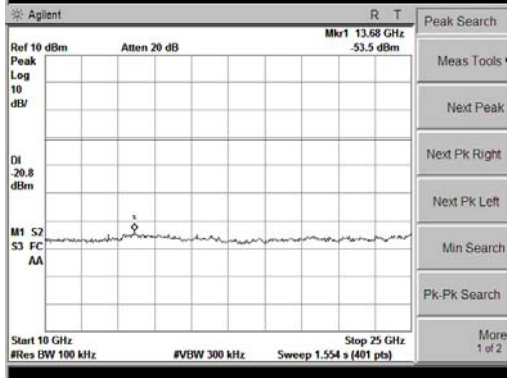
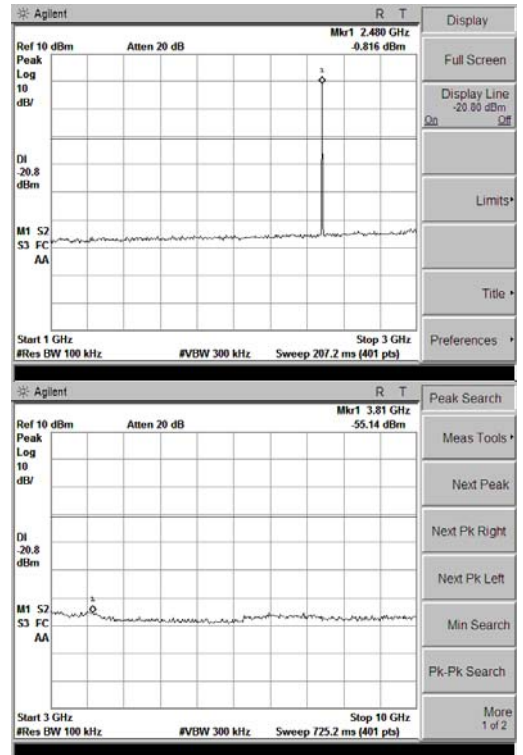
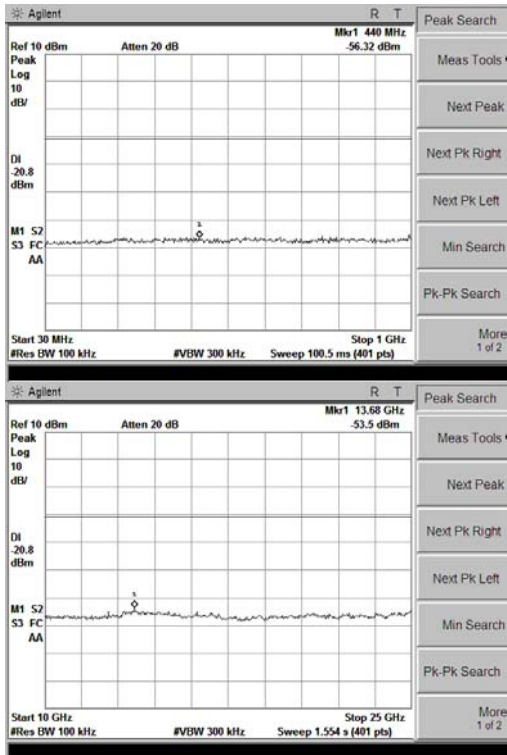

GFSK Mode, Ch39

5.8 Restricted Frequency Bands

5.8.1 Test Requirement

In any 100 kHz bandwidth outside the frequency band in which the spread spectrum or digitally modulated intentional radiator is operating, the radio frequency power that is produced by the intentional radiator shall be at least 20 dB below that in the 100 kHz bandwidth within the band that contains the highest level of the desired power. In addition, radiated emissions which fall in the restricted bands, as defined in §15.205(a), must also comply with the radiated emission limits specified in §15.209(a) (see §15.205(c)).

5.8.2 Test Configuration

Test Setup:

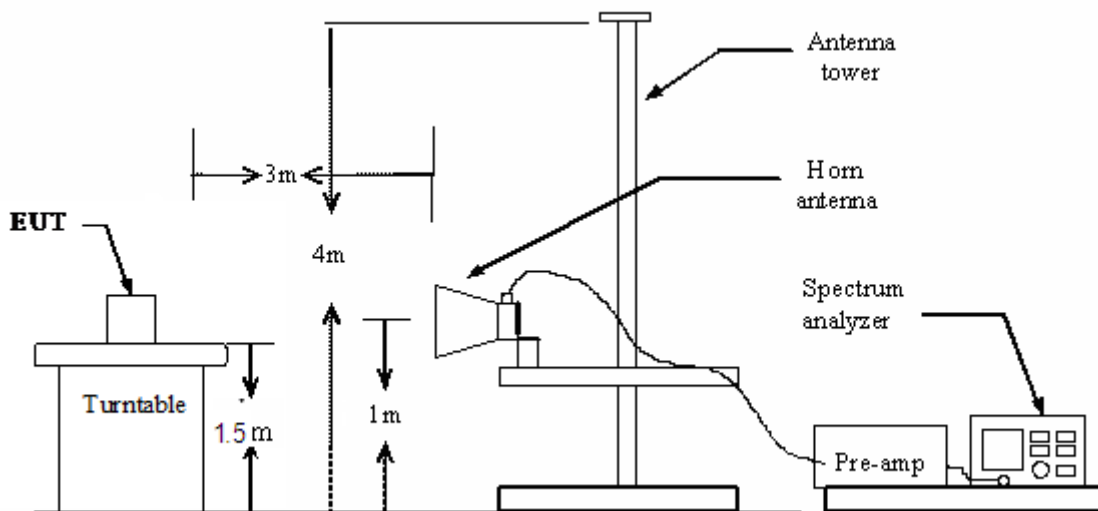

5.8.3 Test Procedure:

1. The EUT was placed on the top of a rotating table 1.5 meters above the ground at a 3 meter chamber. The table was rotated 360 degrees to determine the position of the highest radiation.
2. The EUT was set 3 meters away from the interference-receiving antenna, which was mounted on the top of a variable-height antenna tower.
3. The antenna height is varied from one meter to four meters above the ground to determine the maximum value of the field strength. Both horizontal and vertical polarizations of the antenna are set to make the measurement.
4. For each suspected emission, the EUT was arranged to its worst case and then the antenna was tuned to heights from 1 meter to 4 meters and the table was turned from 0 degrees to 360 degrees to find the maximum reading.

5.8.4 Test Result

Pass

Note: All test modes are performed, only the worst case is recorded in this report.

Please refer the following plots.

EUT:	Monster Solara	M/N:	MNSOL-BLK
Mode:	GFSK-CH0	Polarization:	Horizontal
Tested by:	SKY(Engineer)	Power:	DC 5V by Adapter
Temperature: / Humidity	24°C/ 54%	Test date:	2017-04-19

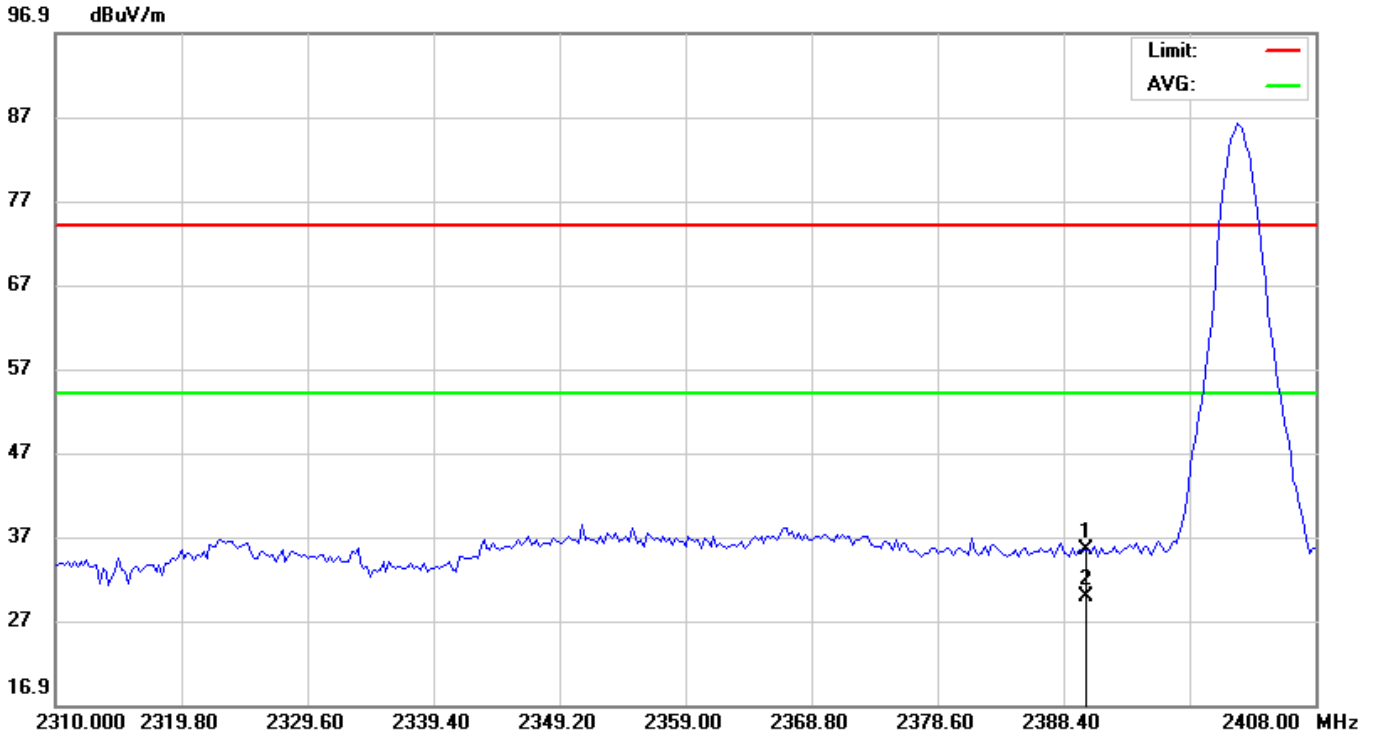

No.	Mk.	Freq. MHz	Reading Level dBuV	Correct Factor dB	Measure- ment dBuV/m	Limit dBuV/m	Over dB	Detector	Antenna Height cm	Table Degree	Comment
1		2390.000	43.76	-8.43	35.33	74.00	-38.67	peak			
2	*	2390.000	38.18	-8.43	29.75	54.00	-24.25	AVG			

*:Maximum data x:Over limit !:over margin

EUT:	Monster Solara	M/N:	MNSOL-BLK
Mode:	GFSK-CH0	Polarization:	Vertical
Tested by:	SKY(Engineer)	Power:	DC 5V by Adapter
Temperature: / Humidity	24°C/ 54%	Test date:	2017-04-19

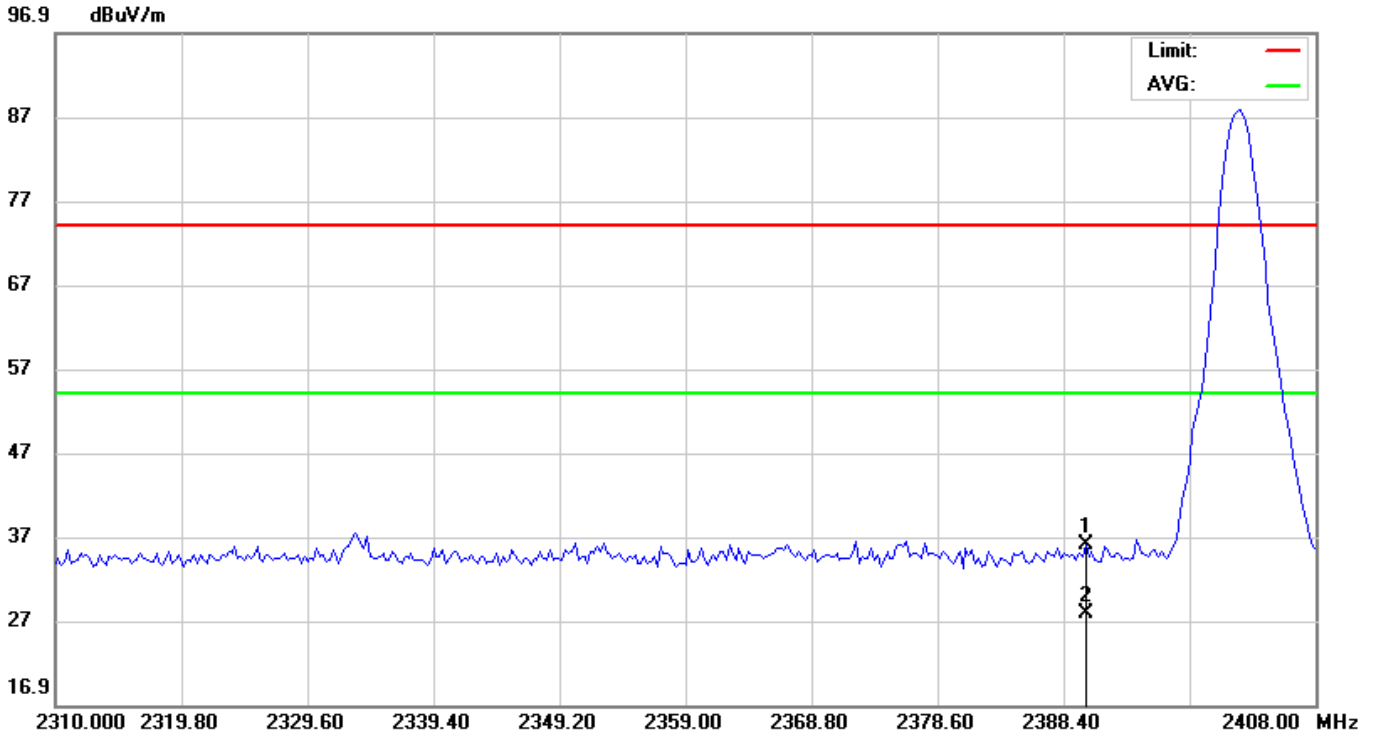

No.	Mk.	Freq.	Reading Level	Correct Factor	Measurement	Limit	Over	Antenna Height	Table Degree	
		MHz	dBuV	dB	dBuV/m	dBuV/m	dB	cm	degree	Comment
1		2390.000	44.47	-8.43	36.04	74.00	-37.96			peak
2	*	2390.000	36.18	-8.43	27.75	54.00	-26.25			AVG

*:Maximum data x:Over limit !:over margin

EUT:	Monster Solara	M/N:	MNSOL-BLK
Mode:	GFSK-CH78	Polarization:	Horizontal
Tested by:	SKY(Engineer)	Power:	DC 5V by Adapter
Temperature: / Humidity	24°C/ 54%	Test date:	2017-04-19

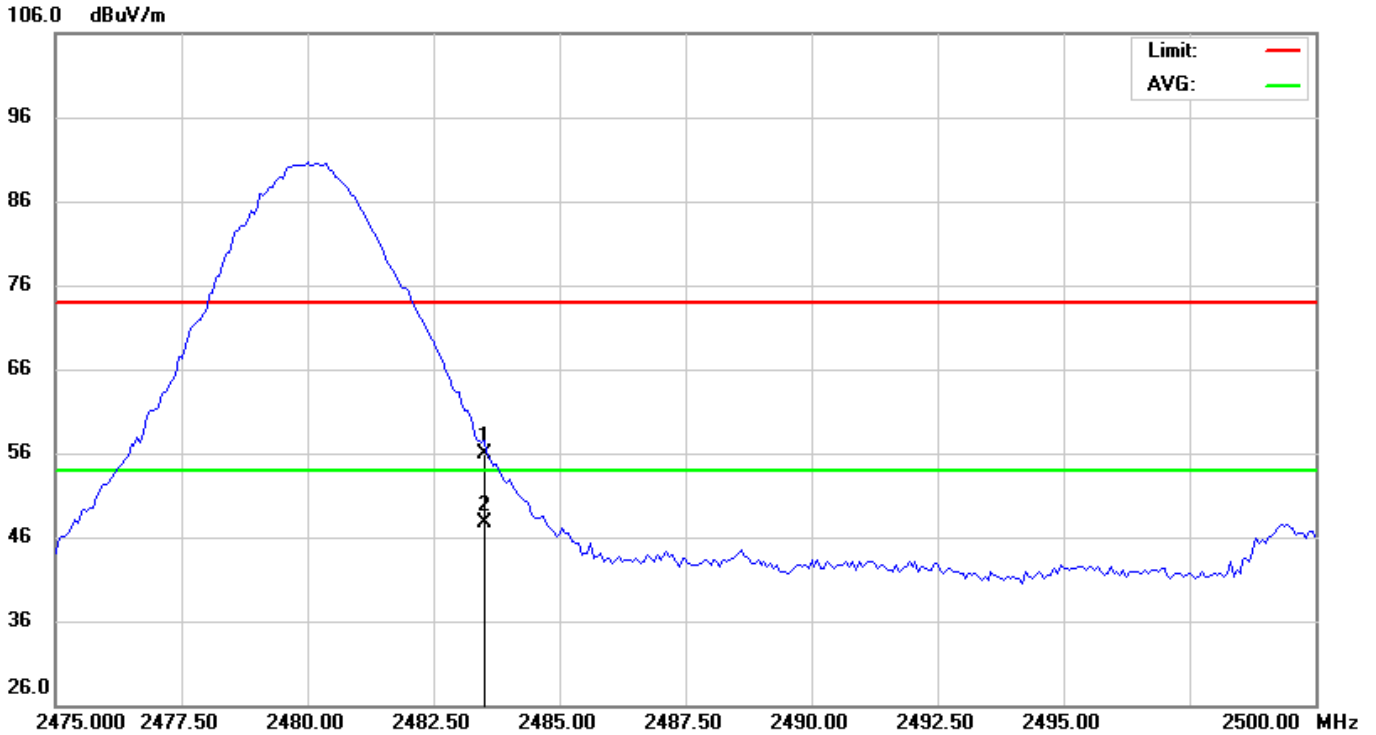

No.	Mk.	Freq.	Reading Level	Correct Factor	Measurement	Limit	Over	Antenna Height	Table Degree	
		MHz	dBuV	dB	dBuV/m	dBuV/m	dB	cm	degree	Comment
1		2483.500	64.20	-8.29	55.91	74.00	-18.09			peak
2	*	2483.500	56.07	-8.29	47.78	54.00	-6.22			AVG

*:Maximum data x:Over limit !:over margin

EUT:	Monster Solara	M/N:	MNSOL-BLK
Mode:	GFSK-CH78	Polarization:	Vertical
Tested by:	SKY(Engineer)	Power:	DC 5V by Adapter
Temperature: / Humidity	24°C/ 54%	Test date:	2017-04-19

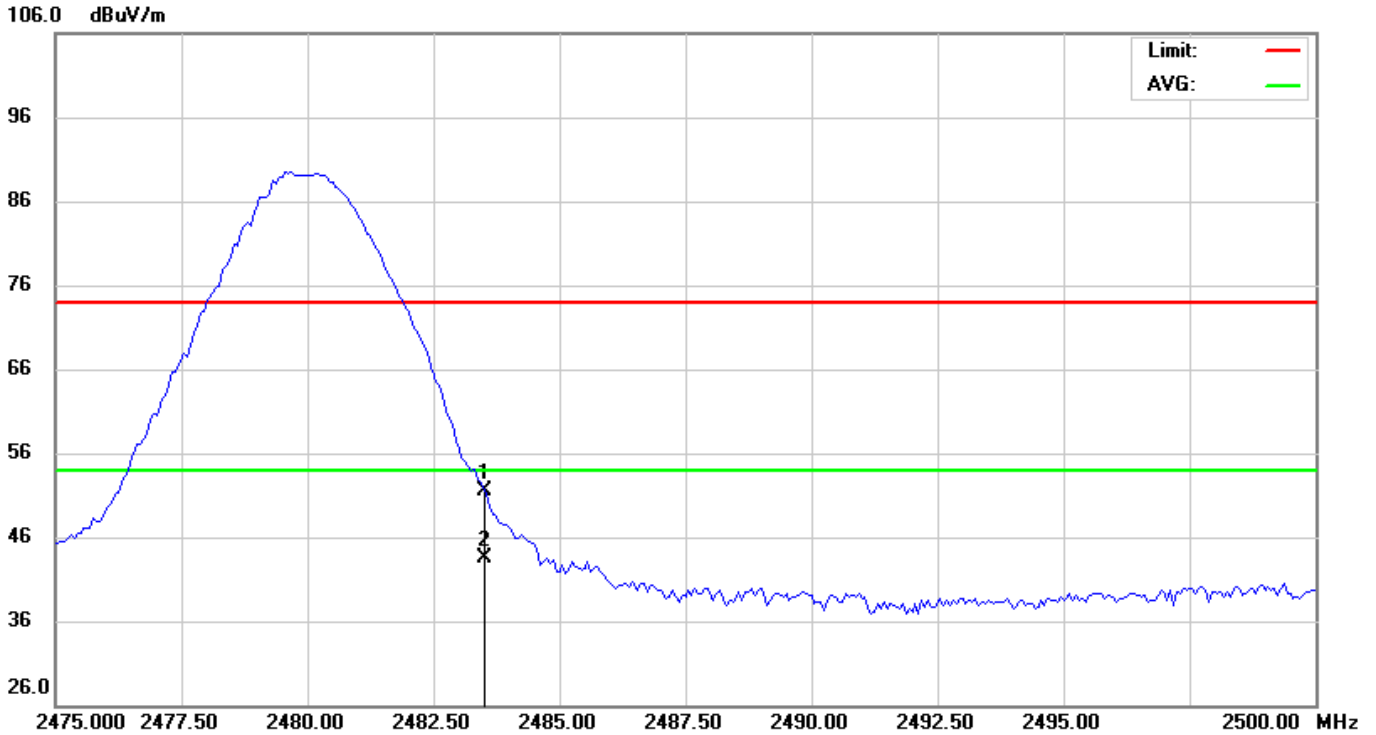

No.	Mk.	Freq. MHz	Reading Level dBuV	Correct Factor dB	Measure- ment dBuV/m	Limit dBuV/m	Over dB	Detector	Antenna Height cm	Table Degree degree	Comment
1		2483.500	59.79	-8.29	51.50	74.00	-22.50	peak			
2	*	2483.500	51.70	-8.29	43.41	54.00	-10.59	AVG			

*:Maximum data x:Over limit !:over margin

End of the Report