

CRAZON®

Product Operation Manual

Thank you for choosing our product! Please read this instruction manual carefully before using, as it contains all the informations you need to know about how to use this product correctly with fun.

Colors And Contents May Vary From Instruction.

3+
AGES

ROLLING STUNT CAR

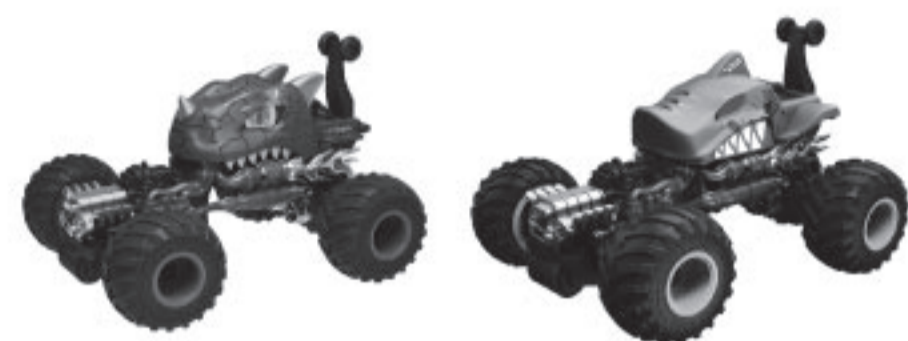

Battery Installation

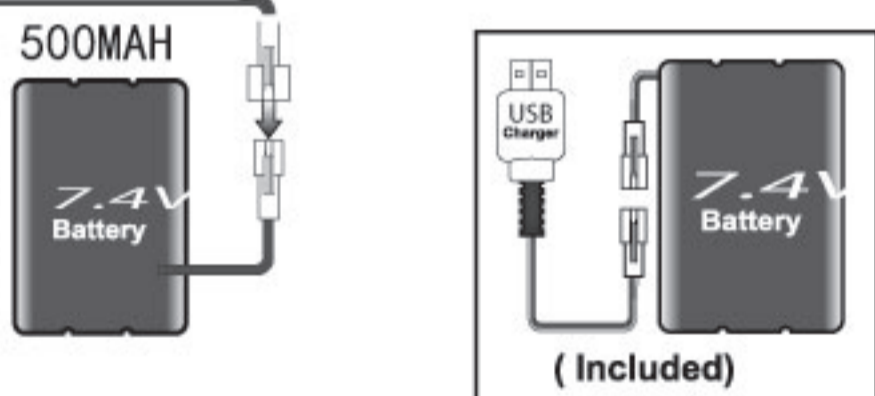
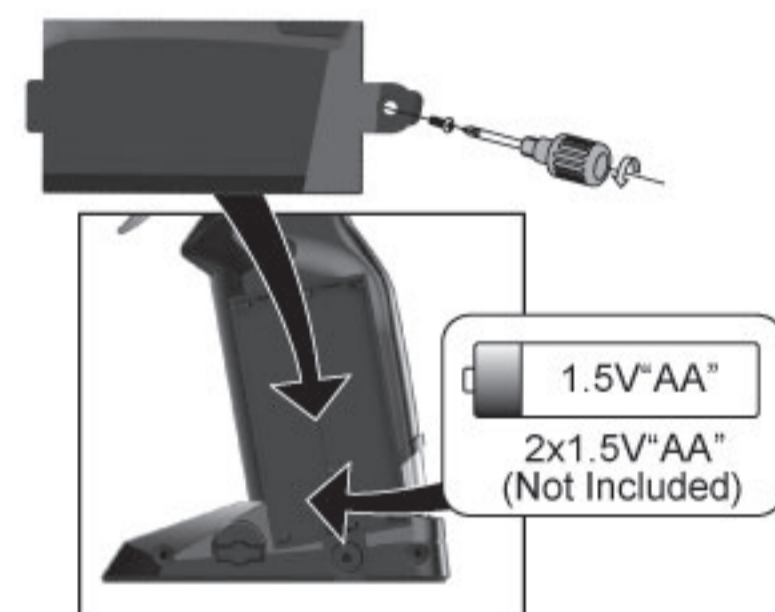
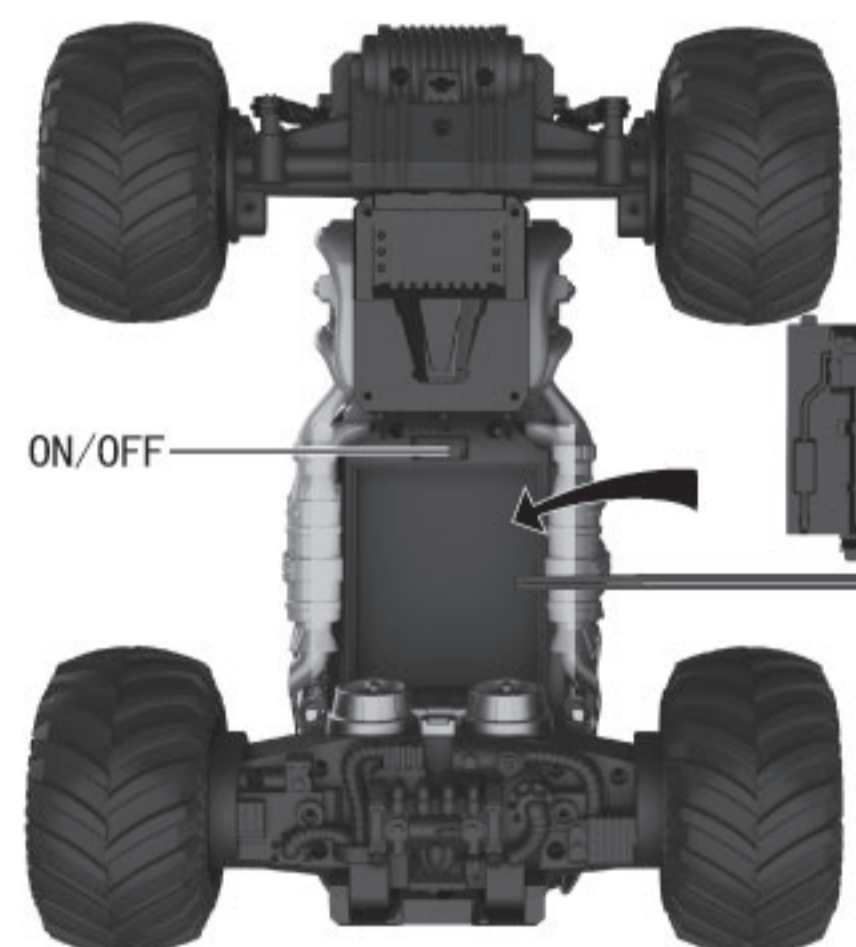

1. Take off the battery cover of R/C car, instal 7.4V rechargeable battery pack, fasten the cover,turn the switch to 'on'
2. Open the battery cover of transmitter, instal 2x1.5V"AA" batteries , close the cover.
3. The charging time is about 2.5 hours support about 20 minutes playing.

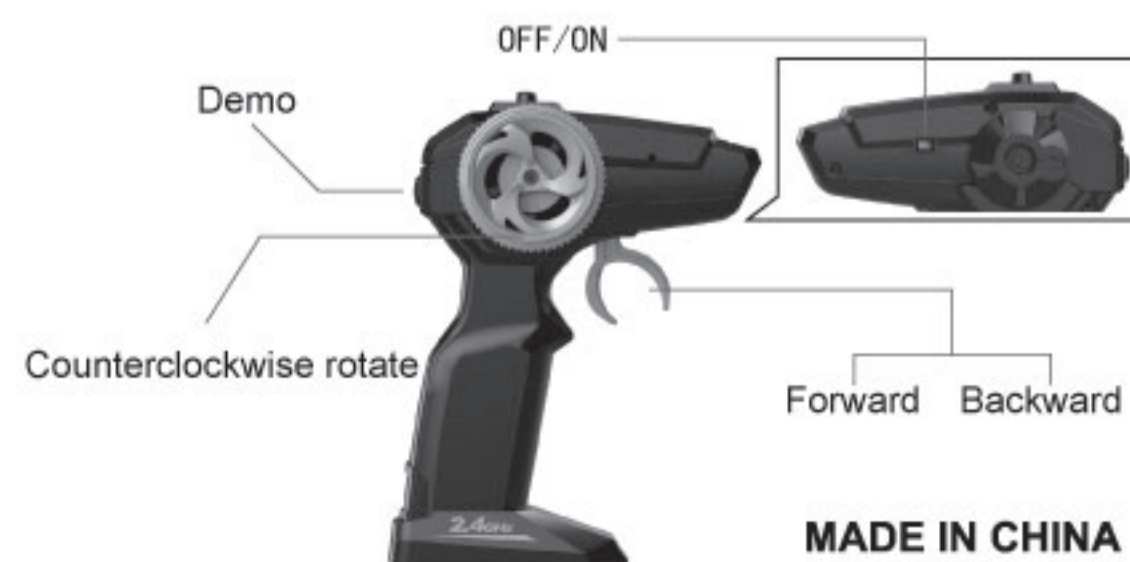

The Basic Operation of The Products

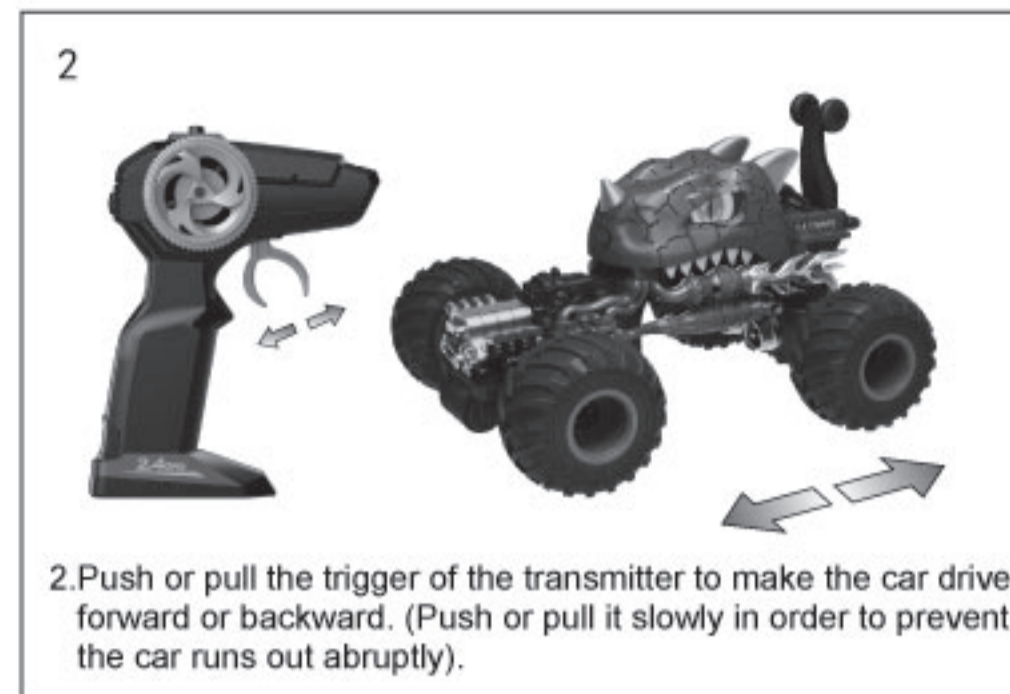

2.Push or pull the trigger of the transmitter to make the car drive forward or backward. (Push or pull it slowly in order to prevent the car runs out abruptly).

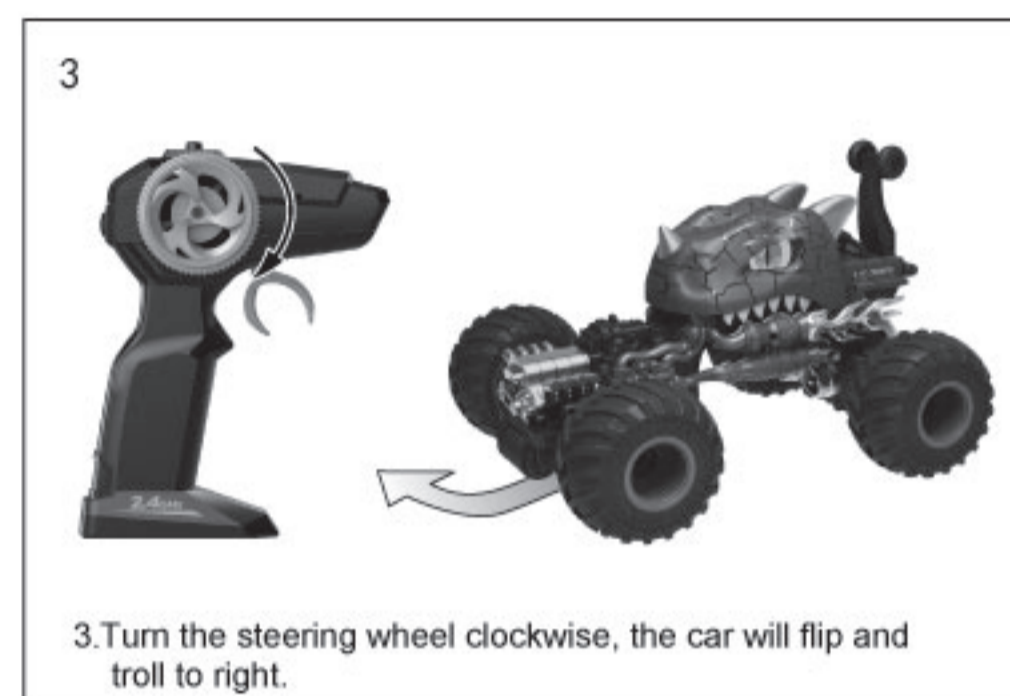

3.Turn the steering wheel clockwise, the car will flip and troll to right.

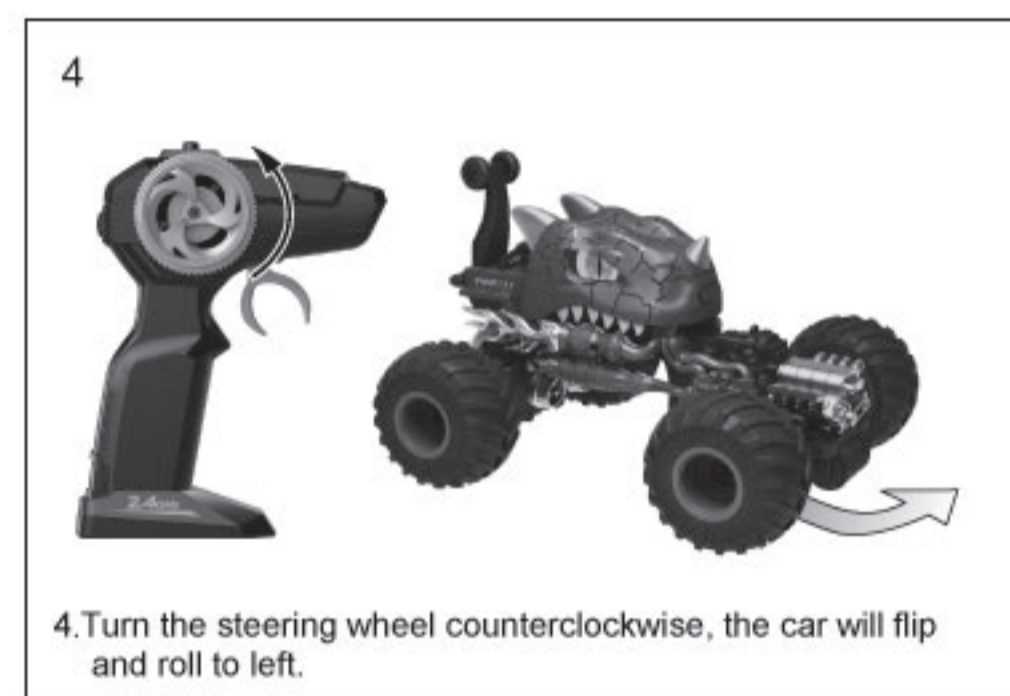

4.Turn the steering wheel counterclockwise, the car will flip and roll to left.

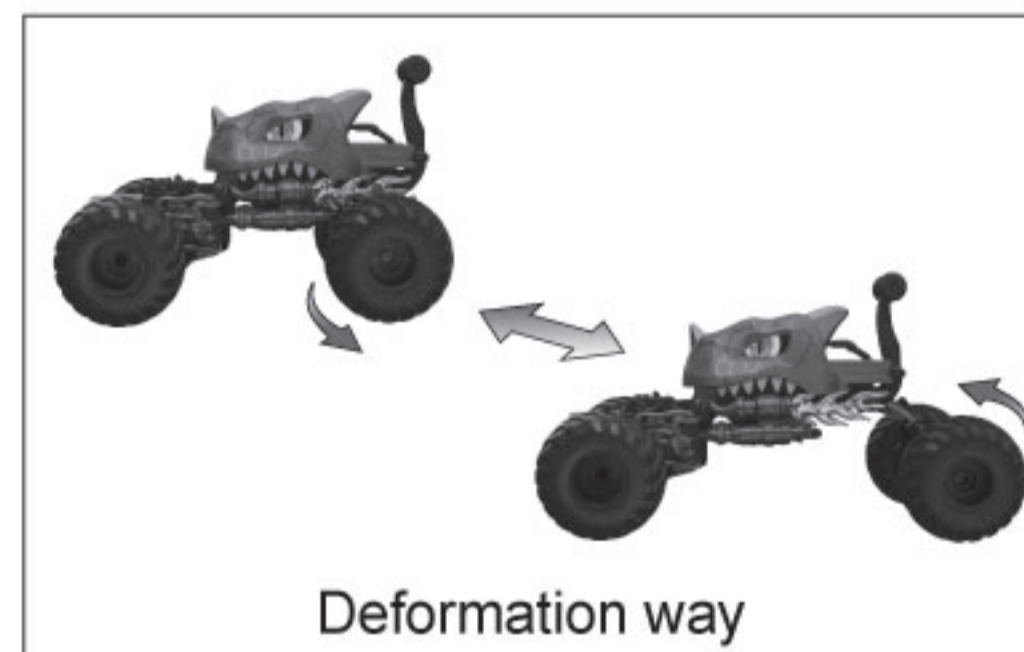

Deformation way

Charge by USB: About 2.5 hours(for B version);
Playing Time: About 20 Mins;
Control Distance: About 25M;
Battery Capacity and Voltage: 500MAH, 7.4V;

BATTERY SAFETY

- (1) The placement or replacement of batteries is to be performed by an adult.
- (2) Remove the rechargeable battery from the chassis before charging.
- (3) Always remove exhausted batteries from the car and the transmitter.
- (4) Make sure the main switch is set to OFF before installing the battery pack into the car body.
- (5) Batteries must be inserted with the correct polarity.
- (6) Non-chargeable batteries shall not be recharged.
- (7) Do not short-circuit the batteries.
- (8) Always remove the batteries from the car and the transmitter after playing.
- (9) Never throw the batteries into fire to avoid explosion or leakage.
- (10) Do not mix batteries from different producers or new and old batteries.
- (11) You should only use batteries of the same or equivalent types as recommended.
- (12) Check the batteries on a regular basis to avoid leakage.
- (13) Keep this manual well for future reference as it contains important information about this product.



Deformation way

ITEM NO:333-FD22162

NAME:R/C CAR

FCC compliance statement

This device complies with Part 15 of the FCC Rules. Operation is subject to the following two conditions: (1) this device may not cause harmful interference, and (2) this device must accept any interference received, including interference that may cause undesired operation.

changes or modifications not expressly approved by the party responsible for compliance could void the user's authority to operate the equipment.

This equipment has been tested and found to comply with the limits for a Class B digital device, pursuant to Part 15 of the FCC Rules. These limits are designed to provide reasonable protection against harmful interference in a residential installation. This equipment generates, uses and can radiate radio frequency energy and, if not installed and used in accordance with the instructions, may cause harmful interference to radio communications. However, there is no guarantee that interference will not occur in a particular installation.

If this equipment does cause harmful interference to radio or television reception, which can be determined by turning the equipment off and on, the user is encouraged to try to correct the interference by one or more of the following measures:

- Reorient or relocate the receiving antenna.
- Increase the separation between the equipment and receiver.
- Connect the equipment into an outlet on a circuit different from that to which the receiver is connected.
- Consult the dealer or an experienced radio/TV technician for help.

