

## **ELECTROMAGNETIC EMISSIONS COMPLIANCE REPORT**

### **INTENTIONAL RADIATOR CERTIFICATION TO FCC PART 90 R REQUIREMENT**

*OF*

**Product Name:** LM63S1  
**Marketing Name:** LM63S1  
**Brand Name:** N/A  
**Model No.:** LM63S1  
**Model Difference:** N/A  
**FCC ID:** 2AAGMLM63S1  
**Report No.:** ER/2015/40183  
**Issue Date:** May. 12, 2015  
**FCC Rule Part:** 2 , 90R  
**Prepared for:** Sequans Communications  
Portes de la Défense  
15-55, Boulevard Charles de Gaulle  
92700 Colombes, France  
SGS Taiwan Ltd.  
Electronics & Communication Laboratory  
**Prepared by:** No.134, Wu Kung Road, New Taipei Industrial  
Park, Wuku District, New Taipei City, Taiwan  
24803

*Note: This report shall not be reproduced except in full, without the written approval of SGS Taiwan Ltd. This document may be altered or revised by SGS Taiwan Ltd. personnel only, and shall be noted in the revision section of the document.*

**VERIFICATION OF COMPLIANCE**

**Applicant:** Sequans Communications  
Portes de la Défense 15-55, Boulevard Charles de Gaulle 92700 Co-  
lombes, France

**Product Name:** LM63S1

**Marketing Name:** LM63S1

**Brand Name:** N/A

**Model No.:** LM63S1

**Model Difference:** N/A

**FCC ID:** 2AAGMLM63S1

**Report No.:** ER/2015/40183

**Date of test:** Apr. 10, 2015 ~ May. 12, 2015

**Date of EUT Received:** Apr. 10, 2015

**We hereby certify that:**

The above equipment was tested by SGS Taiwan Ltd. Electronics & Communication Laboratory. The test data, data evaluation, test procedures, and equipment configurations shown in this report were made in accordance with the procedures given in TIA/EIA-603-C-2004 and the energy emitted by the sample EUT tested as described in this report is in compliance with conducted and radiated emission limits.

The test results of this report relate only to the tested sample identified in this report.

**Test By:** Jazz Huang **Date:** May. 12, 2015

*Jazz Huang / Asst. Supervisor*

**Prepared By:** Allen Tsai **Date:** May. 12, 2015

*Allen Tsai / Engineer*

**Approved By:** Jim Chang **Date:** May. 12, 2015

*Jim Chang / Asst. Manager*

## Revision History

Report Number	Revision	Description	Issue Date
ER/2015/40183	Rev.00	Initial creation of document	May. 12, 2015

**Table of Contents**

**1. GENERAL PRODUCT INFORMATION.....6**

1.1. Product Description.....6

1.2. Product Feature of Equipment Under Test.....7

1.3. Test Methodology of Applied Standards.....8

1.4. Test Facility.....8

1.5. Special Accessories.....8

1.6. Equipment Modifications.....8

**2. SYSTEM TEST CONFIGURATION.....9**

2.1. EUT Configuration.....9

2.2. EUT Exercise.....9

2.3. Test Procedure.....9

2.4. Measurement Results Explanation Example.....10

2.5. Final Amplifier Voltage and Current Information:.....10

2.6. Configuration of Tested System.....11

**3. SUMMARY OF TEST RESULTS.....12**

**4. DESCRIPTION OF TEST MODES.....12**

4.1. The Worst Test Modes and Channel Details.....12

**5. MEASUREMENT UNCERTAINTY.....14**

**6. RF CONDUCTED OUTPUT POWER MEASUREMENT.....15**

6.1. Standard Applicable.....15

6.2. Test Set-up.....15

6.3. Measurement Procedure.....15

6.4. Measurement Equipment Used.....16

6.5. Measurement Result.....16

**7. EFFECTIVE RADIATED POWER AND EQUIVALENT ISOTROPIC RADIATED POWER MEASUREMENT.....17**

7.1. Standard Applicable.....17

7.2. Test SET-UP.....17

7.3. Measurement Procedure.....19

7.4. Measurement Equipment Used.....21

7.5. Measurement Result: (Peak) –using option of peak measurement.....22

7.6. Measurement Result: (Average) –using option of peak measurement.....24

**8. OCCUPIED BANDWIDTH MEASUREMENT.....26**

8.1. Standard Applicable.....26

8.2. Test Set-up.....26

8.3. Measurement Procedure.....26

8.4. Measurement Equipment Used.....27

8.5. Measurement Result.....27

**9. OUT OF BAND EMISSION AT ANTENNA TERMINALS .....32**

9.1. Standard Applicable .....32

9.2. Test SET-UP .....33

9.3. Measurement Procedure.....33

9.4. Measurement Equipment Used .....34

9.5. Measurement Result:.....34

**10. FIELD STRENGTH OF SPURIOUS RADIATION MEASUREMENT.....47**

10.1. Standard Applicable .....47

10.2. EUT Setup .....47

10.3. Measurement Procedure:.....49

10.4. Measurement Equipment Used: .....50

10.5. Measurement Result (Below 1GHz): .....51

**15. FREQUENCY STABILITY MEASUREMENT .....53**

15.1. Standard Applicable: .....53

15.2. Test Set-up:.....53

15.3. Measurement Procedure:.....53

15.4. Measurement Equipment Used: .....54

15.5. Measurement Result:.....55

**16. PEAK TO AVERAGE RATIO .....56**

16.1. Standard Applicable .....56

16.2. Test SET-UP .....56

16.3. Measurement Procedure.....56

16.4. Measurement Equipment Used .....56

16.5. Measurement Result.....57

**PHOTOGRAPHS OF SET UP.....60**

**PHOTOGRAPHS OF EUT .....62**

## 1. GENERAL PRODUCT INFORMATION

### 1.1. Product Description

General:

Product Name:	LM63S1
Marketing Name:	LM63S1
Brand Name:	N/A
Model No.:	LM63S1
Model Difference:	N/A
Product SW/HW version	3.3.3-18888 / Rev01
Radio SW/HW version	3.3.3-18888 / Rev01
Test SW Version	N/A , no test SW was used during testing.
RF power setting in TEST SW	N/A , RF power setting was not able to alter during testing
Power Supply:	3.3 VDC from AC/DC power supply.
IMEI:	357498060000180

LTE:

Cellular Phone Standards Frequency Range and Power	Operating Frequency		Rated Power
	LTE-Band 14 (Bandwidth 5MHz)	790.5MHz – 795.5MHz	23dBm
	LTE-Band 14 (Bandwidth 10MHz)	793.0MHz – 793.0MHz	23dBm

Type of Emission:	LTE-Band 14 (Bandwidth 5MHz) QPSK	4M53G7D
	LTE-Band 14 (Bandwidth 5MHz) 16QAM	4M55D7W
	LTE-Band 14 (Bandwidth 10MHz) QPSK	9M04G7D
	LTE-Band 14 (Bandwidth 10MHz) 16QAM	9M03D7W

Max ERP/EIRP measurement result:

LTE Band 14/5MMz /QPSK RB 1 Offset 24	18.28	ERP	0.067
LTE Band 14/5MMz /16QAM RB 1 Offset 24	18.48	ERP	0.070
LTE Band 14/10MMz /QPSK RB 1 Offset 0	20.12	ERP	0.103
LTE Band 14/10MMz /16QAM RB 1 Offset 0	20.04	ERP	0.101

## 1.2. Product Feature of Equipment Under Test

The equipment under Test (Hereafter Called: EUT) is LTE Module, and below is details of information.

Product Feature	
Product Name:	LM63S1
Marketing Name:	LM63S1
Brand Name:	N/A
Model No.:	LM63S1
Model Difference:	N/A
FCC ID	2AAGMLM63S1
LTE Operating Band(s)	LTE Band 14
LTE Rel. Version	Rel.9

**Note:** The above EUT information was declared by manufacturer. Please refer to the specifications or user's manual for more detailed description.

### **1.3. Test Methodology of Applied Standards**

FCC 47 CFR Part 2 and Part 90R.

ANSI / TIA / EIA 603C-C-2004

KDB971168 D01 Power Meas license Digital System v02r01

TS 151 010-1 is used to set, and measure the output power.

Note:

1. All test items have been performed and record as per the above standards.
2. The composite system is compliance with FCC Subpart B is authorized under the certification procedure.

### **1.4. Test Facility**

SGS Taiwan Ltd. Electronics & Communication Laboratory No.134, Wu Kung Road, New Taipei Industrial Park, Wuku District, New Taipei City, Taiwan. (TAF code 0513)

FCC Registration Numbers are: 990257

Canada Registration Number: 4620A-5

### **1.5. Special Accessories**

No special accessories were used during testing.

### **1.6. Equipment Modifications**

There were no modifications incorporated into the EUT.



## **2. SYSTEM TEST CONFIGURATION**

### **2.1. EUT Configuration**

The EUT configuration for testing is installed on RF field strength measurement to meet the Commissions requirement and operating in a manner which intends to maximize its emission characteristics in a continuous normal application.

### **2.2. EUT Exercise**

The EUT (Transmitter) was operated in the continuous transmission mode employed with the simulator of the Base Station that fixates at test default channels to fix the Tx frequency which was for the purpose of the measurements.

### **2.3. Test Procedure**

#### **2.3.1 Conducted Measurement at Antenna Port**

According to measurement procured TIA/EIA 603C, the EUT is placed on a turn table which is 0.8 m above ground plane. A low loss of RF cable was used to connect the antenna port of EUT to measurement equipment.

#### **2.3.2 Radiated Emissions (ERP/EIRP)**

According to measurement procured TIA/EIA 603C, The EUT is a placed on as turn table which is 0.8 m above ground plane. The turn table shall rotate 360 degrees to determine the position of maximum emission level. EUT is set 3m away from the receiving antenna which varied from 1m to 4m to find out the highest emission. And also, each emission was to be maximized by changing the polarization of receiving antenna both Horizontal and Vertical. In order to find out the max. emission, the relative positions of this hand-held transmitter (EUT) was rotated through three orthogonal axes and measurement procedures for electric field radiated emissions above 1 GHz the EUT measurement is to be made “while keeping the antenna in the ‘cone of radiation’ from that area and pointed at the area both in azimuth and elevation, with polarization oriented for maximum response.” is still within the 3dB illumination BW of the measurement antenna according to the requirements in Section 8 and 13.

**2.4. Measurement Results Explanation Example**

**For all conducted test items:**

The offset level is set in the spectrum analyzer to compensate the RF cable loss and attenuation factor between EUT conducted port and spectrum analyzer. With the offset compensation, the spectrum analyzer reading level is exactly EUT RF output level.

**Note:**

The spectrum analyzer offset is derived from RF cable loss and attenuator factor.

Following shows an offset computation example with cable loss and attenuator.

Low Band: Offset = RF cable loss (dB) + attenuation factor (dB) = 13.9(dB)

**2.5. Final Amplifier Voltage and Current Information:**

Test Mode	DC voltage (V)	DC current (mA)
LTE Band 14	3.3V	806

**2.6. Configuration of Tested System**

**Fig. 2-1 Configuration of Tested System (Fixed Channel-Conducted)**

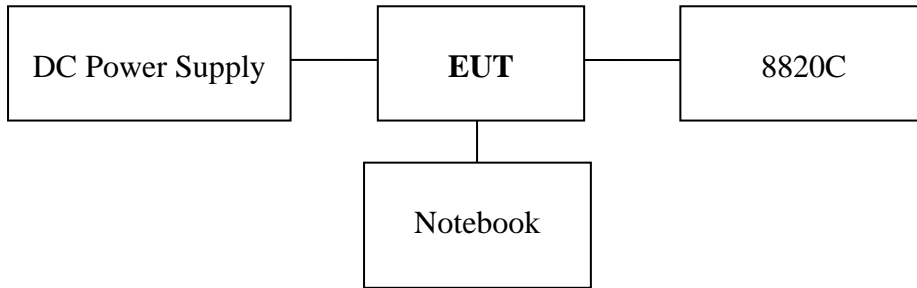

**Fig. 2-2 Configuration of Tested System (Fixed Channel-Radiated)**

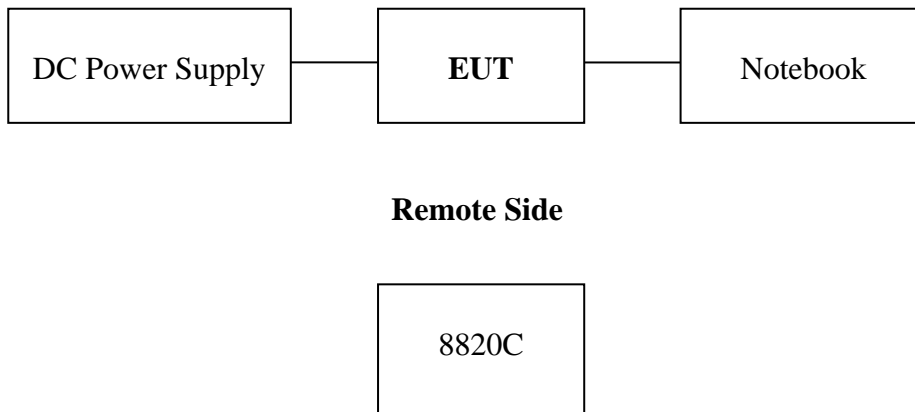

**Table 2-1 Equipment Used in**

Item	Equipment	Mfr/Brand	Model/ Type No.	Series No.	Data Cable	Power Cord
1.	Radio Communication Analyzer	Anritsu	8820C	6201107337	shielded	Un-shielded
2.	DC Power Supply	Agilent	E3640A	MY53140006	shielded	Un-shielded
3.	Test Software	DRTU	N/A	N/A	N/A	N/A
4.	Notebook	Lenovo	L420	LR-7HXZA	shielded	Un-shielded

### 3. SUMMARY OF TEST RESULTS

FCC Rules	Description Of Test	Result
§2.1046(a)	RF Power Output	Compliant
§2.1046(a) §90.542(a)(7)	ERP measurement	Compliant
§2.1049(h)	99% Occupied Bandwidth	Compliant
§2.1051 §90.543(c) §90.543(e)(2)	Out of Band Emissions at Antenna Terminals and Band Edge	Compliant
§2.1053 §90.543(c) §90.543(e) §90.543(f)	Field Strength of Spurious Radiation	Compliant
§2.1055(a)(1) §90.539	Frequency Stability	Compliant

### 4. DESCRIPTION OF TEST MODES

#### 4.1. The Worst Test Modes and Channel Details

1. The EUT has been tested under operating condition.
2. Pre-Scan has been conducted to determine the worst-case mode from all possible combinations between available modulations, data rates, XYZ axis and antenna ports. The worst case was found as listed below. Following channel(s) was (were) selected for the final test as listed below:

BAND	ERP/EIRP	RADIATED EMISSION
LTE Band 14	E2-plan	E2-plan

LTE Band 14 MODE

TEST ITEM	AVAILABLE CHANNEL	TESTED CHANNEL	CHANNEL BANDWIDTH	MODULATION	MODE
ERP	23305 to 23355	23305, 23330, 23355	5MHz	QPSK, 16QAM	1 RB/ 0,24 RB Offest
	23330	23330	10MHz	QPSK, 16QAM	1 RB/ 0,49 RB Offest
FREQUENCY STABILITY	23305 to 23355	23330	10MHz	QPSK,	Full RB
OCCUPIED BANDWIDTH	23305 to 23355	23305, 23330, 23355	5MHz	QPSK, 16QAM	Full RB
	23330	23330	10MHz	QPSK, 16QAM	Full RB
PEAK TO AVERAGE RATIO	23305 to 23355	23305, 23330, 23355	5MHz	16QAM	Full RB
	23330	23330	10MHz	16QAM	Full RB
BAND EDGE	23305 to 23355	23305, 23330, 23355	5MHz	QPSK,	1 RB/ 0,24 RB Offest Full RB
	23330	23330	10MHz	QPSK,	1 RB/ 0,49 RB Offest Full RB
CONDCUDED EMISSION	23305 to 23355	23305, 23330, 23355	5MHz	QPSK,	1 RB, 0 RB Offest
	23330	23330	10MHz	QPSK,	1 RB, 0 RB Offest
RADIATED EMISSION	23330	23330	10MHz	QPSK,	1 RB, 0 RB Offest

**5. MEASUREMENT UNCERTAINTY**

Test Items	Uncertainty
RF Power Output	+/- 1.10 dB
ERP/ EIRP measurement	Vertical Polarization = +/- 4.74dB Horizontal Polarization = +/- 4.62dB
99% Occupied Bandwidth	+/- 5.19 Hz
Out of Band Emissions at Antenna Terminals and Band Edge	+/- 0.70 dB
Peak to Average Ratio	+/- 0.70 dB
Frequency Stability vs. Temperature	+/- 5.19 Hz
Frequency Stability vs. Voltage	+/- 5.19 Hz
Temperature	+/- 0.65 °C
Humidity	+/- 4.6 %
DC / AC Power Source	DC= +/- 0.13%, AC= +/- 0.2%

Radiated Spurious Emission:

Measurement uncertainty (Polarization : <b>Vertical</b> )	30MHz - 180MHz: +/- 3.37dB
	180MHz - 417MHz: +/- 3.19dB
	0.417GHz-1GHz: +/- 3.19dB
	1GHz - 18GHz: +/- 4.04dB
	18GHz - 40GHz: +/- 4.04dB

Measurement uncertainty (Polarization : <b>Horizontal</b> )	30MHz - 167MHz: +/- 4.22dB
	167MHz - 500MHz: +/- 3.44dB
	0.5GHz-1GHz: +/- 3.39dB
	1GHz - 18GHz: +/- 4.08dB
	18GHz - 40GHz: +/- 4.08dB

This uncertainty represents an expanded uncertainty expressed at approximately the 95% confidence level using a coverage factor of k=2.

## 6. RF CONDUCTED OUTPUT POWER MEASUREMENT

### 6.1. Standard Applicable

A base station simulator was used to establish communication with the EUT. Its parameters were set to transmit the maximum power on the EUT. The measured power in the radio frequency on the transmitter output terminals.

### 6.2. Test Set-up

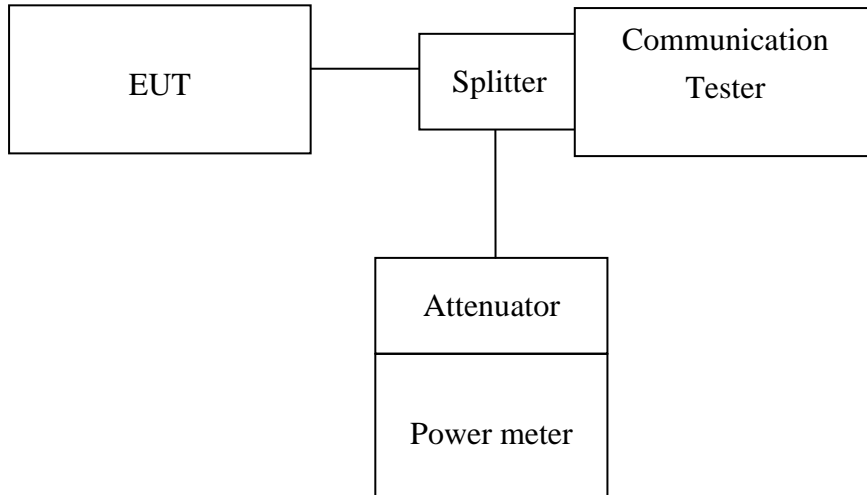

*Note: Measurement setup for testing on Antenna connector*

### 6.3. Measurement Procedure

The transmitter output was connected to a calibrated attenuator, the other end of which was connected to a power meter. Transmitter output was read off the power meter in dBm. The power output at the transmitter antenna port was determined by adding the value of the attenuator to the power meter reading. TS 151 010-1 is reference to conduct the test measurement of output power.

The Procedure of KDB941225 (SAR Measurement Procedures for 3G devices, (WCDMA/HSPA) was used for EUT and Base station setting. RMC 12.2kps is used for this testing, and KDB 971168 D01 Power Meas License Digital System as the supplemental test methodology to adjust the proper setting obtaining the measurement results

**6.4. Measurement Equipment Used**

Conducted Emission Test Site					
EQUIPMENT TYPE	MFR	MODEL NUMBER	SERIAL NUMBER	LAST CAL.	CAL DUE.
Spectrum Analyzer	Agilent	E4446A	MY51100003	05/19/2014	05/18/2015
Radio Communication Analyzer	Anritsu	MT8820C	6200995019	10/08/2014	10/09/2015
Temperature Chamber	TERCHY	MHG-120LF	911009	05/06/2015	05/05/2016
DC Block	Mini-Circuits	BLK-18-S+	1	01/02/2015	01/01/2016
Attenuator	Mini-Circuit	BW-S10W2+	002	01/02/2015	01/01/2016
Splitter	Agilent	11636B	N/A	01/02/2015	01/01/2016
DC Power Supply	Agilent	E3640A	MY52410006	11/10/2014	11/09/2015

**6.5. Measurement Result**

**RF Conducted Output Power**

**LTE Result:**

**LTE Band 14**

LTE Band 14_Uplink frequency band : 788 to 798 MHz								
BW (MHz)	RB Size	RB Offset	Conducted power (dBm)					
			QPSK			16QAM		
			Channel (Low) 23305	Channel (Mid) 23330	Channel (High) 23355	Channel (Low) 23305	Channel (Mid) 23330	Channel (High) 23355
5	1	0	22.78	22.86	23.16	22.78	22.89	23.06
	1	24	23.41	23.03	23.50	<b>23.50</b>	23.13	23.69
	12	6	22.84	22.90	22.87	22.97	23.08	22.97
	25	0	22.93	22.93	23.07	23.10	23.08	23.18

LTE Band 14_Uplink frequency band : 788 to 798 MHz				
BW (MHz)	RB Size	RB Offset	Conducted power (dBm)	
			QPSK	16QAM
			Channel 23330	Channel 23330
10	1	0	22.51	22.81
	1	49	<b>23.50</b>	23.48
	25	12	22.94	23.02
	50	0	22.83	22.99



## 7. EFFECTIVE RADIATED POWER AND EQUIVALENT ISOTROPIC RADIATED POWER MEASUREMENT

### 7.1. Standard Applicable

Per FCC Part 90.542 (a)(6)

(6) Control stations and mobile stations transmitting in the 758-768 MHz band and the 788-798 MHz band are limited to 30 watts ERP.

### 7.2. Test SET-UP

(A) Radiated Power Test Set-Up, Frequency Below 1000MHz

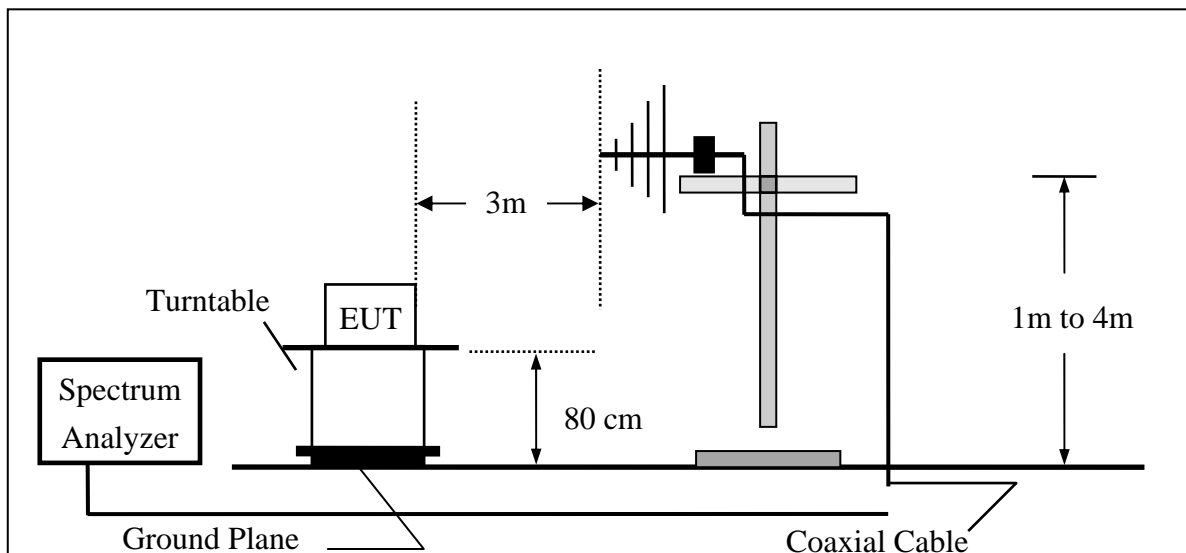

(B) Radiated Power Test Set-UP Frequency Over 1 GHz

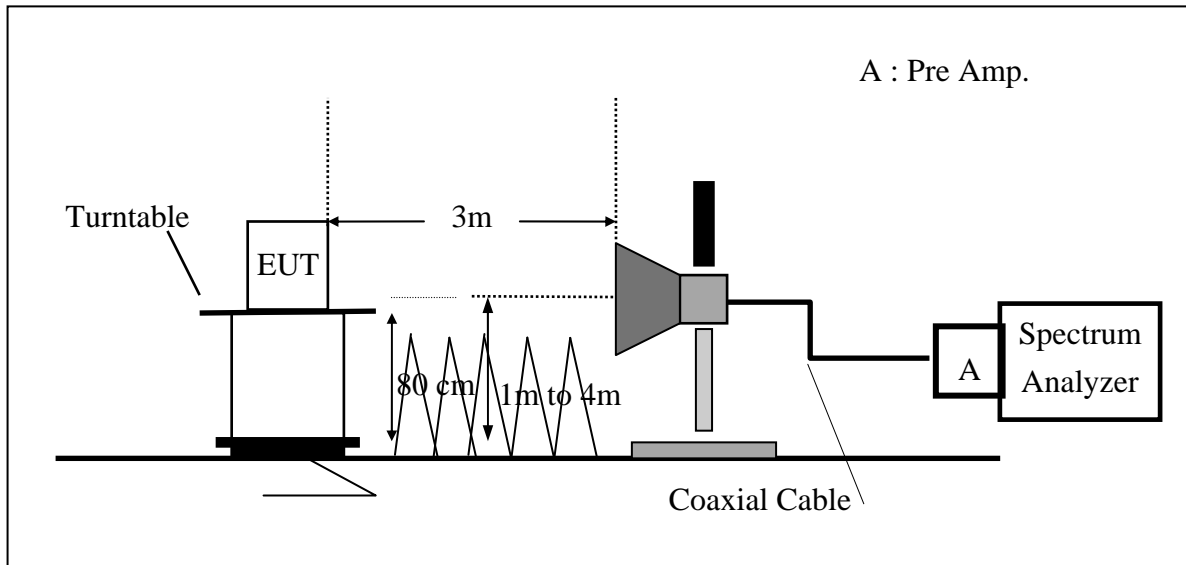

(C) Substituted Method Test Set-UP

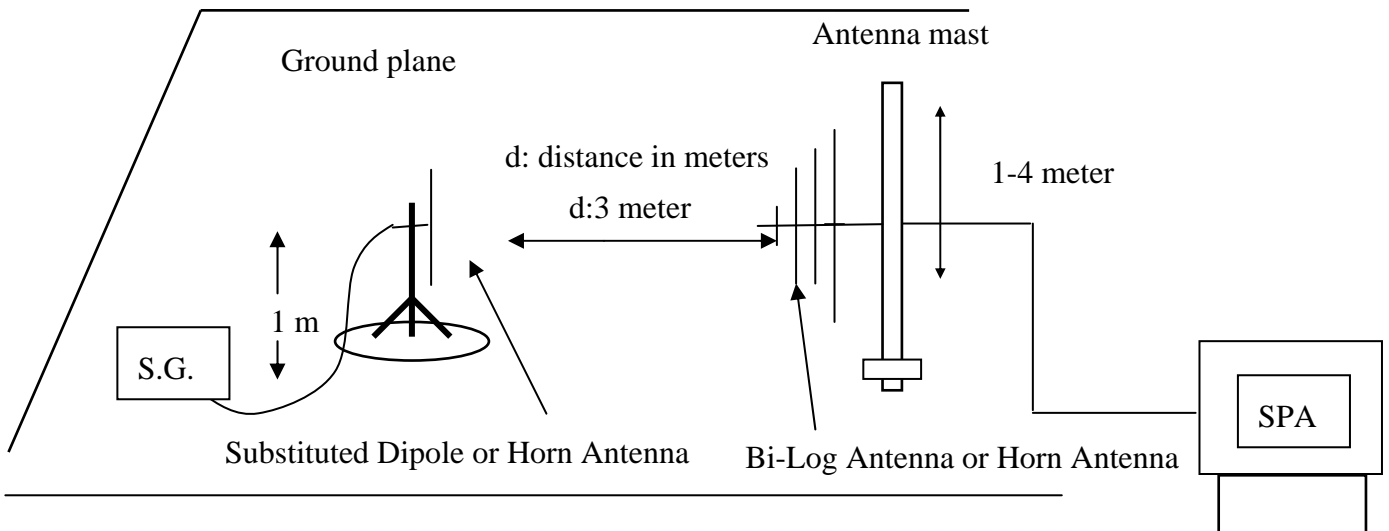

### 7.3. Measurement Procedure

1. The testing follows the Measurement Procedure of FCC KDB 971168 D01
2. The EUT was placed on a non-conductive turntable using a non-conductive support. The radiated emission at the fundamental frequency was measured at 3 m with a test antenna and EMI spectrum analyzer.
3. During the measurement, the EUT was communication with the station. The highest emission was recorded with the rotation of the turntable and the lowering of the test antenna from 4m to 1m. The reading was recorded and the field strength (E in dBuV/m) was calculated
4. The testing follows the Measurement Procedure of FCC KDB 971168 D01
5. The substitution horn antenna is substituted for EUT at the same position and signals generator export the CW signal to the substitution antenna via a tx cable. Rotated the Turn Table and moved receiving antenna to find the maximum radiation power. Adjust output power level of S.G to get a Value of spectrum reading equal to "Read Value" of step b. Record the power level of S.G.
6.  $ERP = S.G. \text{ output (dBm)} + \text{Antenna Gain (dBd)} + \text{Cable Loss (dB)}$
7.  $EIRP = S.G. \text{ output (dBm)} + \text{Antenna Gain (dBi)} + \text{Cable Loss (dB)}$
8. Spectrum setting:
  - (1) Detector = Peak, marker the highest value of the detector by maximum hold, set RBW wide enough to capture the entire signal of emission, and  $VBW > = 3 \times RBW$ .
  - (2) KDB 971168 D01 is adopted, and the procedure as lists under item 4, Measurement of the Average Power over the Fundamental Signal Bandwidth, is followed to set correspondingly for the acquisition of proper measurement data.

Set frequency = nominal signal center frequency;  
Set span = 2 X occupied BW;  
Set RBW  $\approx$  1~5% of the span, not to exceed 1 MHz  
Set VBW = 3 x RBW;  
Select average power (RMS) detector  
Set sweep time and number of measurement points to achieve a minimum of 1 millisecond/pt integration time (ex. Point = 601points, then sweet time =  $601 * 10^{-3} = 6s$ ).

Activate trace averaging routine over a minimum of 10 sweeps;  
Activate marker/span pair and set span = signal or channel bandwidth;  
Activate the band/interval power marker function;  
Record the band power level;

Record adjusted value as the average signal power level. Then activate the occupied bandwidth measurement function.

The proper adjustment due to limitation of spectrum capability is given compensated to spectrum with conversion factor of  $10 \cdot \log(TBW/RBW)$ , where TBW is the transmission of UE exceeding the maximum BW UE can extend, and RBW is the resolution BW in UE.

**7.4. Measurement Equipment Used**

SGS 966 Chamber No.C					
Name of Equipment	Manufacturer	Model	Serial Number	Calibration Date	Calibration Due
Spectrum Analyzer	Agilent	E4446A	MY51100003	05/19/2014	05/18/2015
EXA Spectrum Analyzer	Agilent	N9010A	MY50420195	12/22/2014	12/21/2015
Spectrum Analyzer	R&S	FSV-30	101398	10/07/2014	10/06/2015
Bilog Antenna	SCHWAZBECK	VULB9168	378	12/23/2014	12/22/2015
Bilog Antenna	SCHWAZBECK	VULB9160	3158	10/31/2014	10/30/2015
Horn antenna	ETS.LINDGREN	3117	123995	05/19/2014	05/18/2015
Horn antenna	ETS.LINDGREN	3117	123991	12/19/2014	12/18/2015
Horn Antenna	Schwarzbeck	BBHA9170	184	12/25/2014	12/24/2015
Horn Antenna	Schwarzbeck	BBHA9170	185	07/29/2014	07/28/2015
Network Analyze	Anritsu	MS4644A	1216312	05/24/2014	05/23/2015
Signal Generator	Agilent	E4438C	MY45093613	08/06/2014	08/05/2015
Pre-Amplifier	Agilent	8447D	1937A02834	01/02/2015	01/01/2016
Attenuator	Mini-Circuit	BW-S10W2+	004	01/02/2015	01/01/2016
Radio Communication Analyzer	R&S	CMU200	102189	02/11/2015	02/10/2016
Radio Communication Analyzer	Anritsu	MT8820C	6200995019	10/08/2014	10/09/2015
Turn Table	HD	DT420	N/A	N.C.R	N.C.R
Antenna Tower	HD	MA240-N	240/657	N.C.R	N.C.R
Controller	HD	HD100	N/A	N.C.R	N.C.R
Low Loss Cable	HUBER+SUHNER	966_Tx	10m	01/02/2015	01/01/2016
Low Loss Cable	HUBER+SUHNER	966_Rx	3m	01/02/2015	01/01/2016
Filter 800-1000	Micro-Tronics	EWT	M2	01/02/2015	01/01/2016
Filter 1800-2000	Micro-Tronics	EWT	M2	01/02/2015	01/01/2016
Filter 1700-1800	Micro-Tronics	BRC15751	001	01/02/2015	01/01/2016
1GHz High Pass Filter	Micro-Tronics	HPM50108	32	01/02/2015	01/01/2016
2GHz High Pass Filter	Micro-Tronics	HPM50110	36	01/02/2015	01/01/2016
3m Site NSA	SGS	966 chamber	N/A	07/15/2014	07/14/2015

**7.5. Measurement Result: (Peak) –using option of peak measurement**

EUT			Measurement					
Operation Band	Fundamental Frequency	CH	Antenna Pol.	S.G. Output	Antenna Gain	Cable Loss	ERP	Limit
	MHz		V/H	dBm	dBd	dB	dBm	dBm
<b>BAND 14 BW: 5M QPSK RB: 1,0</b>	790.5	23305	V	15.77	3.41	-2.81	16.36	44.77
			H	10.43	3.41	-2.81	11.03	44.77
	793.0	23330	V	16.79	3.42	-2.82	17.38	44.77
			H	11.43	3.42	-2.82	12.03	44.77
	795.5	23355	V	17.32	3.42	-2.83	<b>17.92</b>	44.77
			H	11.58	3.42	-2.83	12.17	44.77
<b>BAND 14 BW: 5M QPSK RB: 1,24</b>	790.5	23305	V	17.68	3.42	-2.82	<b>18.28</b>	44.77
			H	12.26	3.42	-2.82	12.86	44.77
	793.0	23330	V	16.07	3.42	-2.83	16.66	44.77
			H	10.41	3.42	-2.83	11.00	44.77
	795.5	23355	V	15.89	3.43	-2.84	16.48	44.77
			H	9.97	3.43	-2.84	10.56	44.77
<b>BAND 14 BW: 5M 16QAM RB: 1,0</b>	790.5	23305	V	15.58	3.4	-2.81	16.18	44.77
			H	10.54	3.41	-2.81	11.14	44.77
	793.0	23330	V	16.72	3.41	-2.82	17.31	44.77
			H	11.4	3.41	-2.82	12.00	44.77
	795.5	23355	V	17.76	3.42	-2.82	<b>18.36</b>	44.77
			H	12.25	3.42	-2.82	12.84	44.77
<b>BAND 14 BW: 5M 16QAM RB: 1,24</b>	790.5	23305	V	17.89	3.42	-2.82	<b>18.48</b>	44.77
			H	12.5	3.42	-2.82	13.1	44.77
	793.0	23330	V	16.5	3.42	-2.83	17.1	44.77
			H	10.94	3.42	-2.83	11.53	44.77
	795.5	23355	V	15.92	3.43	-2.84	16.52	44.77
			H	9.94	3.43	-2.84	10.53	44.77

**Remark :**

- (1) The RBW,VBW of SPA for frequency RBW= 8MHz , VBW= 8MHz

EUT			Measurement					
Operation Band	Fundamental Frequency	CH	Antenna Pol.	S.G. Output	Antenna Gain	Cable Loss	ERP	Limit
	MHz		V/H	dBm	dBd	dB	dBm	dBm
<b>BAND 14 BW: 10M QPSK RB: 1,0</b>	793.0	23330	V	19.52	3.4	-2.81	<b>20.12</b>	44.77
			H	10.49	3.4	-2.81	11.09	44.77
<b>BAND 14 BW: 10M QPSK RB: 1,49</b>	793.0	23330	V	18.67	3.41	-2.81	<b>19.26</b>	44.77
			H	8.52	3.41	-2.81	9.11	44.77
<b>BAND 14 BW: 10M 16QAM RB: 1,0</b>	793.0	23330	V	19.44	3.4	-2.81	<b>20.04</b>	44.77
			H	9.78	3.4	-2.81	10.38	44.77
<b>BAND 14 BW: 10M 16QAM RB: 1,49</b>	793.0	23330	V	18.06	3.41	-2.81	<b>18.65</b>	44.77
			H	9.26	3.41	-2.81	9.86	44.77

**Remark :**

- (1) The RBW,VBW of SPA for frequency RBW= 8MHz , VBW= 8MHz

**7.6. Measurement Result: (Average) –using option of peak measurement**

EUT			Measurement					
Operation Band	Fundamental Frequency	CH	Antenna Pol.	S.G. Output	Antenna Gain	Cable Loss	ERP	Limit
	MHz		V/H	dBm	dBd	dB	dBm	dBm
<b>BAND 14 BW: 5M QPSK RB: 1,0</b>	790.5	23305	V	12.45	3.41	-2.81	13.05	44.77
			H	7.04	3.41	-2.81	7.64	44.77
	793.0	23330	V	13.50	3.42	-2.82	<b>14.10</b>	44.77
			H	7.93	3.42	-2.82	8.53	44.77
	795.5	23355	V	13.41	3.42	-2.83	14.00	44.77
			H	7.64	3.42	-2.83	8.23	44.77
<b>BAND 14 BW: 5M QPSK RB: 1,24</b>	790.5	23305	V	14.44	3.42	-2.82	<b>15.04</b>	44.77
			H	8.28	3.42	-2.82	8.88	44.77
	793.0	23330	V	12.66	3.42	-2.83	13.25	44.77
			H	6.49	3.42	-2.83	7.08	44.77
	795.5	23355	V	12.83	3.43	-2.84	13.42	44.77
			H	6.95	3.43	-2.84	7.54	44.77
<b>BAND 14 BW: 5M 16QAM RB: 1,0</b>	790.5	23305	V	11.75	3.40	-2.81	12.34	44.77
			H	6.69	3.41	-2.81	7.29	44.77
	793.0	23330	V	13.34	3.41	-2.82	13.93	44.77
			H	8.29	3.41	-2.82	8.88	44.77
	795.5	23355	V	14.20	3.42	-2.82	<b>14.80</b>	44.77
			H	8.96	3.42	-2.82	9.56	44.77
<b>BAND 14 BW: 5M 16QAM RB: 1,24</b>	790.5	23305	V	14.06	3.42	-2.82	<b>14.66</b>	44.77
			H	9.13	3.42	-2.82	9.73	44.77
	793.0	23330	V	12.74	3.42	-2.83	13.33	44.77
			H	7.45	3.42	-2.83	8.04	44.77
	795.5	23355	V	12.24	3.43	-2.84	12.83	44.77
			H	6.34	3.43	-2.84	6.93	44.77

**Remark :**

- (1) The RBW,VBW of SPA for frequency RBW= 8MHz , VBW= 8MHz



EUT			Measurement					
Operation Band	Fundamental Frequency	CH	Antenna Pol.	S.G. Output	Antenna Gain	Cable Loss	ERP	Limit
	MHz		V/H	dBm	dBd	dB	dBm	dBm
<b>BAND 14 BW: 10M QPSK RB: 1,0</b>	793.0	23330	V	16.19	3.40	-2.81	<b>16.78</b>	44.77
			H	6.58	3.40	-2.81	7.17	44.77
<b>BAND 14 BW: 10M QPSK RB: 1,49</b>	793.0	23330	V	15.45	3.41	-2.81	<b>16.05</b>	44.77
			H	5.29	3.41	-2.81	5.89	44.77
<b>BAND 14 BW: 10M 16QAM RB: 1,0</b>	793.0	23330	V	16.07	3.40	-2.81	<b>16.66</b>	44.77
			H	6.23	3.40	-2.81	6.82	44.77
<b>BAND 14 BW: 10M 16QAM RB: 1,49</b>	793.0	23330	V	14.71	3.41	-2.81	<b>15.31</b>	44.77
			H	5.34	3.41	-2.81	5.94	44.77

**Remark :**

- (1) The RBW,VBW of SPA for frequency RBW= 8MHz , VBW= 8MHz

## 8. OCCUPIED BANDWIDTH MEASUREMENT

### 8.1. Standard Applicable

The occupied bandwidth is the frequency bandwidth such that, below its lower and above its upper frequency limits, the mean powers radiated are each equal to 0.5 percent of the total mean power.

According to §FCC 2.1049 (99%)

### 8.2. Test Set-up

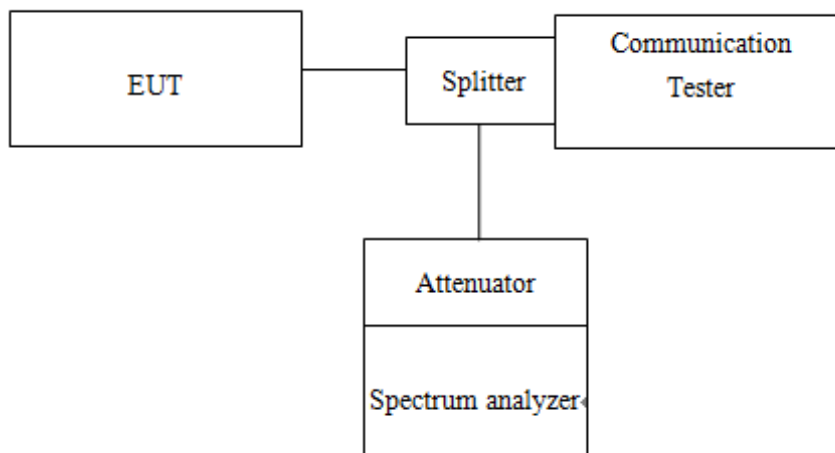

### 8.3. Measurement Procedure

The EUT's output RF connector was connected with a short cable to the spectrum analyzer, RBW was set to about 1% of emission BW, VBW= 3 times RBW, -20dBc display line was placed on the screen (or 20dB bandwidth), the occupied bandwidth is the delta frequency between the two points where the display line intersects the signal trace. Then set RBW to 99% bandwidth, RBW= 1%, VBW= 3 RBW, with span > 2 \* Signal BW, set % Power = 99%.

**NOTE:** For the plot of bandwidth measurement, the marker of the 99% bandwidth is diamond-shape while the marker of the 20dB BW is arrow-mark

**8.4. Measurement Equipment Used**

Conducted Emission Test Site					
EQUIPMENT TYPE	MFR	MODEL NUMBER	SERIAL NUMBER	LAST CAL.	CAL DUE.
Spectrum Analyzer	Agilent	E4446A	MY51100003	05/19/2014	05/18/2015
Radio Communication Analyzer	Anritsu	MT8820C	6200995019	10/08/2014	10/09/2015
Temperature Chamber	TERCHY	MHG-120LF	911009	05/06/2015	05/05/2016
DC Block	Mini-Circuits	BLK-18-S+	1	01/02/2015	01/01/2016
Attenuator	Mini-Circuit	BW-S10W2+	002	01/02/2015	01/01/2016
Splitter	Agilent	11636B	N/A	01/02/2015	01/01/2016
DC Power Supply	Agilent	E3640A	MY52410006	11/10/2014	11/09/2015

**8.5. Measurement Result**

**99% Bandwidth**

LTE BAND 14							
Channel bandwidth: 5MHz				Channel bandwidth: 10MHz			
Frequency (MHz)	CH	99% Bandwidth (MHz)		Frequency (MHz)	CH	99% Bandwidth (MHz)	
		QPSK	16QAM			QPSK	16QAM
790.5	23305	4.5239	<b>4.5540</b>	793.0	23330	<b>9.0360</b>	<b>9.0259</b>
793.0	23330	<b>4.5284</b>	4.5064				
795.5	23355	4.5270	4.5308				

LTE BAND 14							
Channel bandwidth: 5MHz				Channel bandwidth: 10MHz			
Frequency (MHz)	CH	26dB Bandwidth (MHz)		Frequency (MHz)	CH	26dB Bandwidth (MHz)	
		QPSK	16QAM			QPSK	16QAM
790.5	23305	<b>5.080</b>	<b>5.120</b>	793.0	23330	<b>10.015</b>	<b>9.906</b>
793.0	23330	5.035	4.970				
795.5	23355	5.072	5.082				

**99% Bandwidth Test Data**

**5MHz BW LTE-Band 14 QPSK Channel Low**

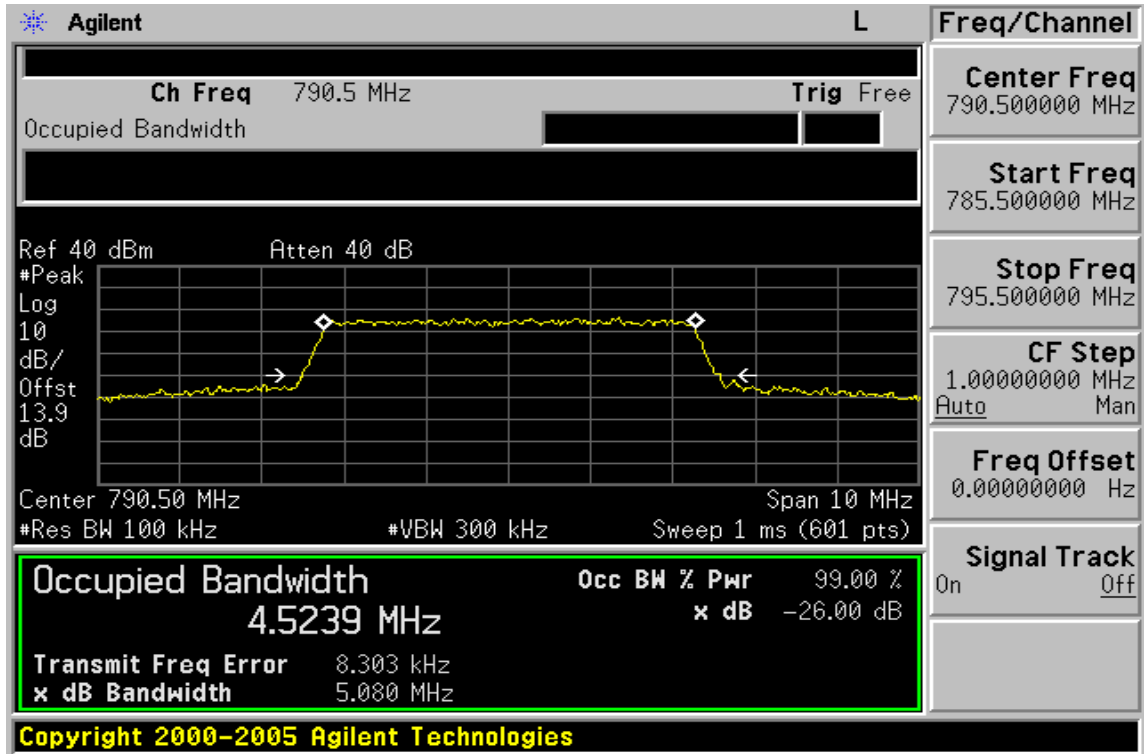

**5MHz BW LTE-Band 14 QPSK Channel Mid**

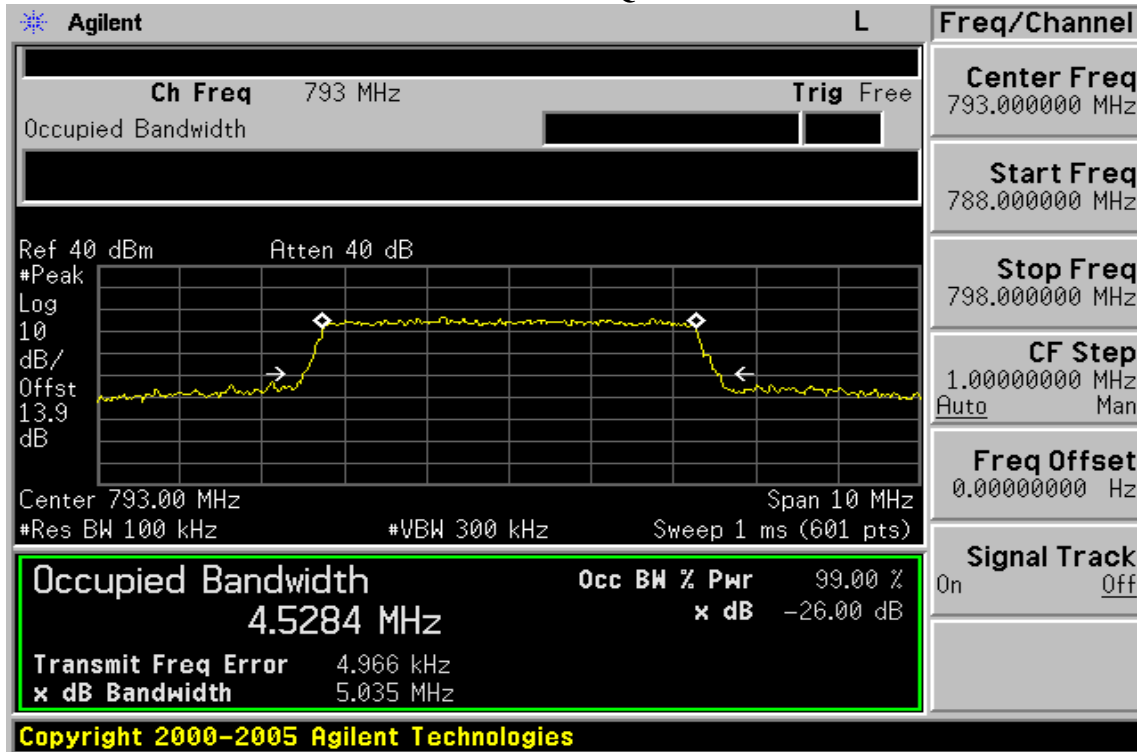

**5MHz BW LTE-Band 14 QPSK Channel High**

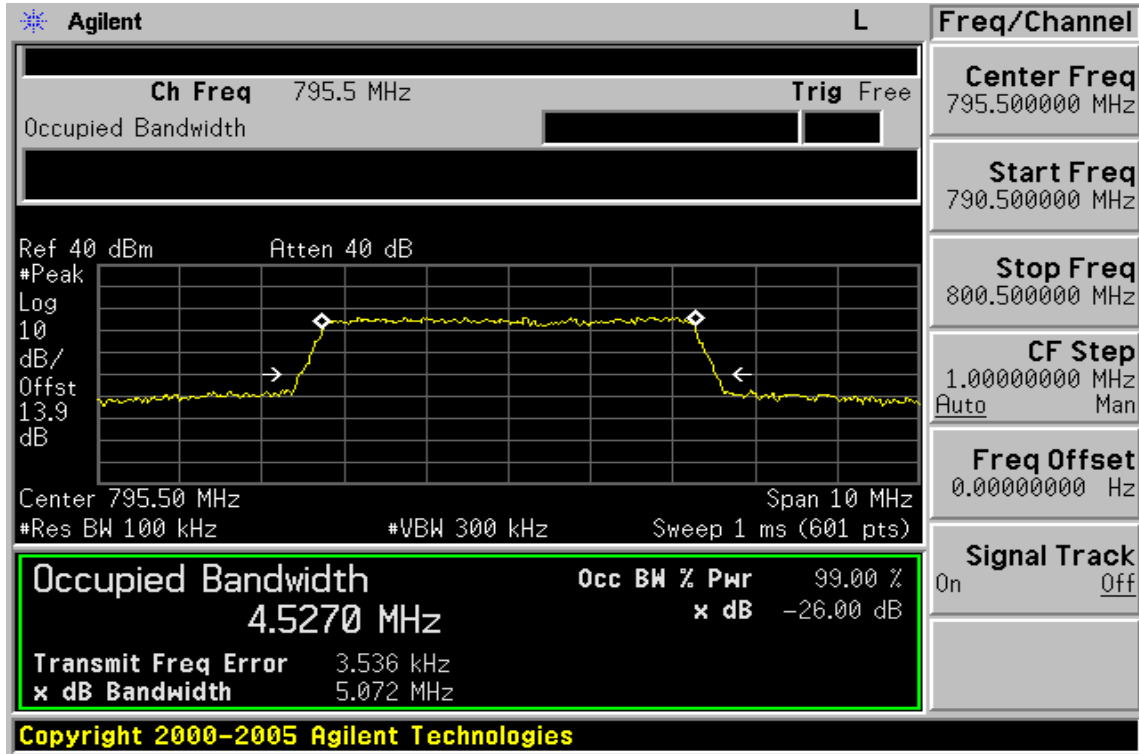

**5MHz BW LTE-Band 14 16QAM Channel Low**

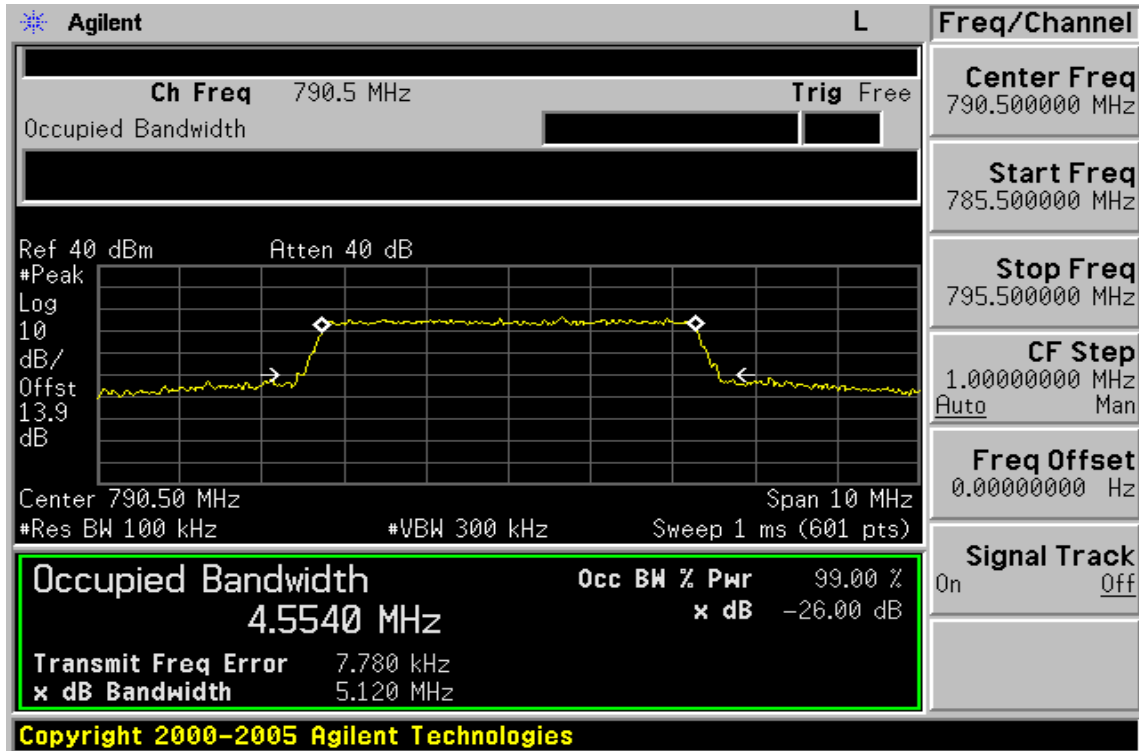

5MHz BW LTE-Band 14 Channel Mid

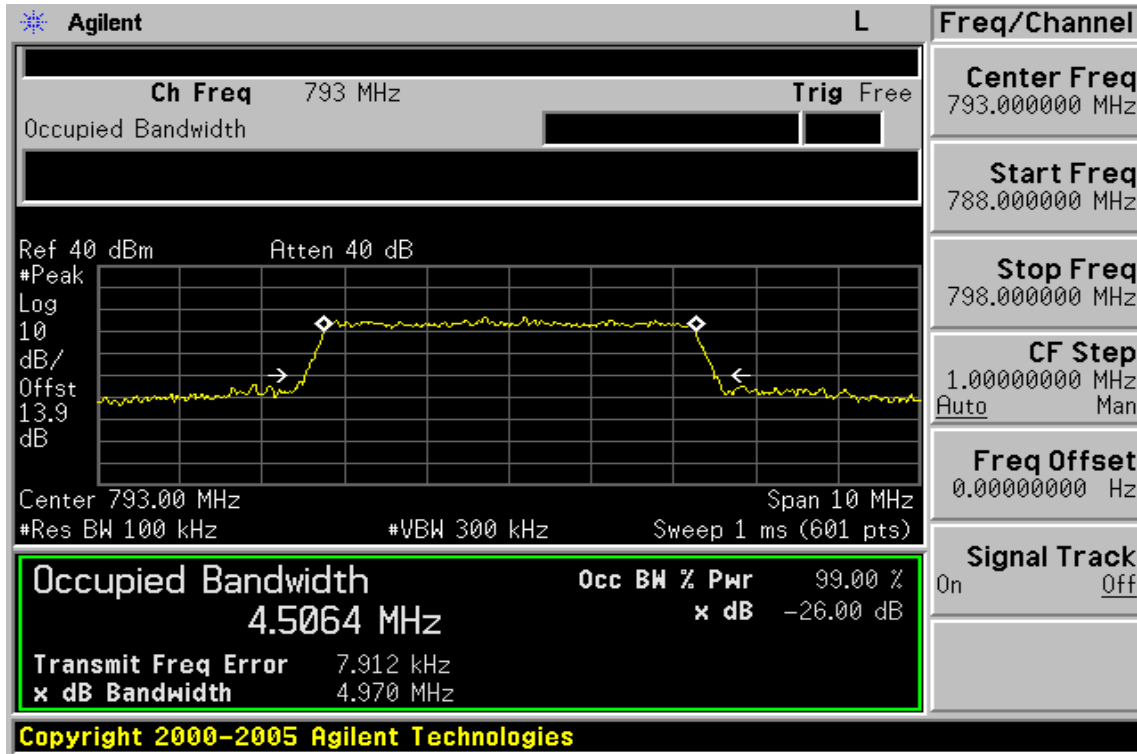

5MHz BW LTE-Band 14 16QAM Channel High

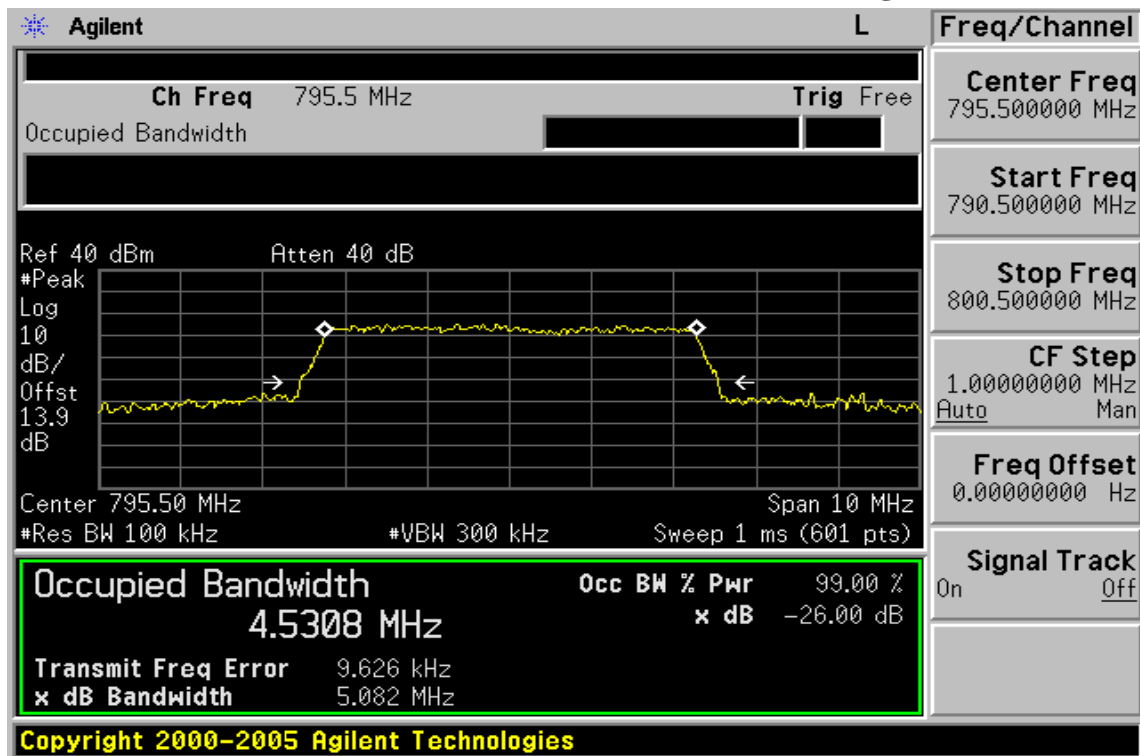

10MHz BW LTE-Band 14 QPSK Channel Mid

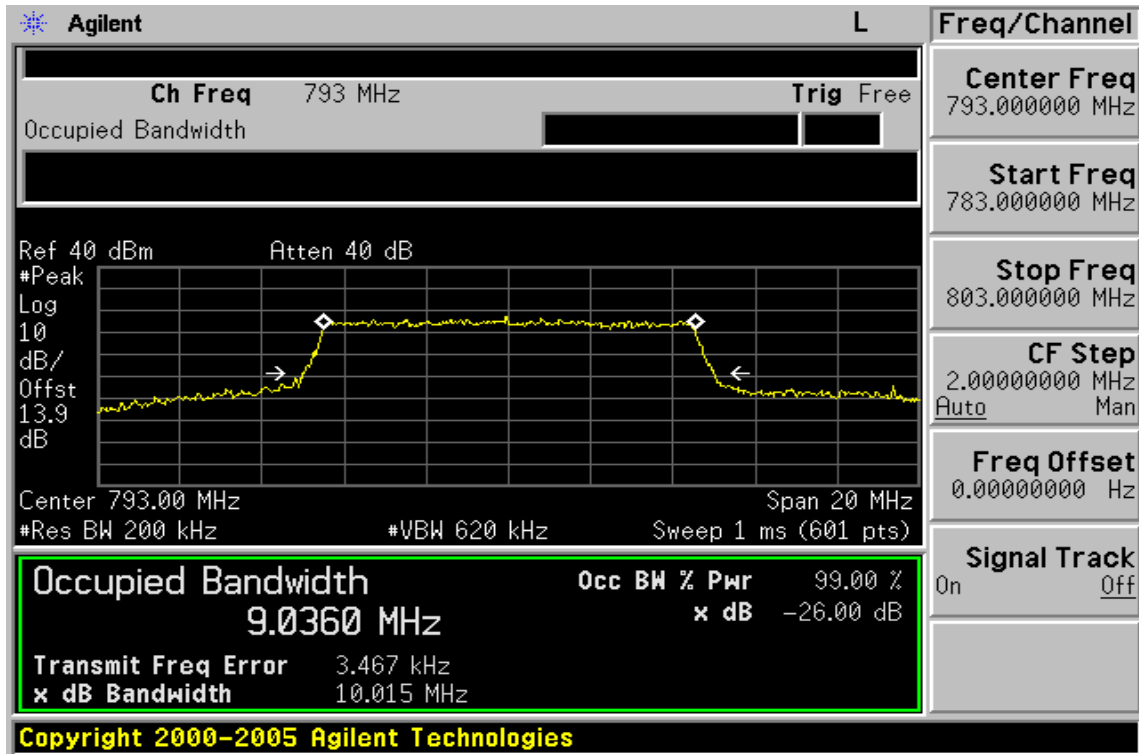

10MHz BW LTE-Band 14 16QAM Channel Mid

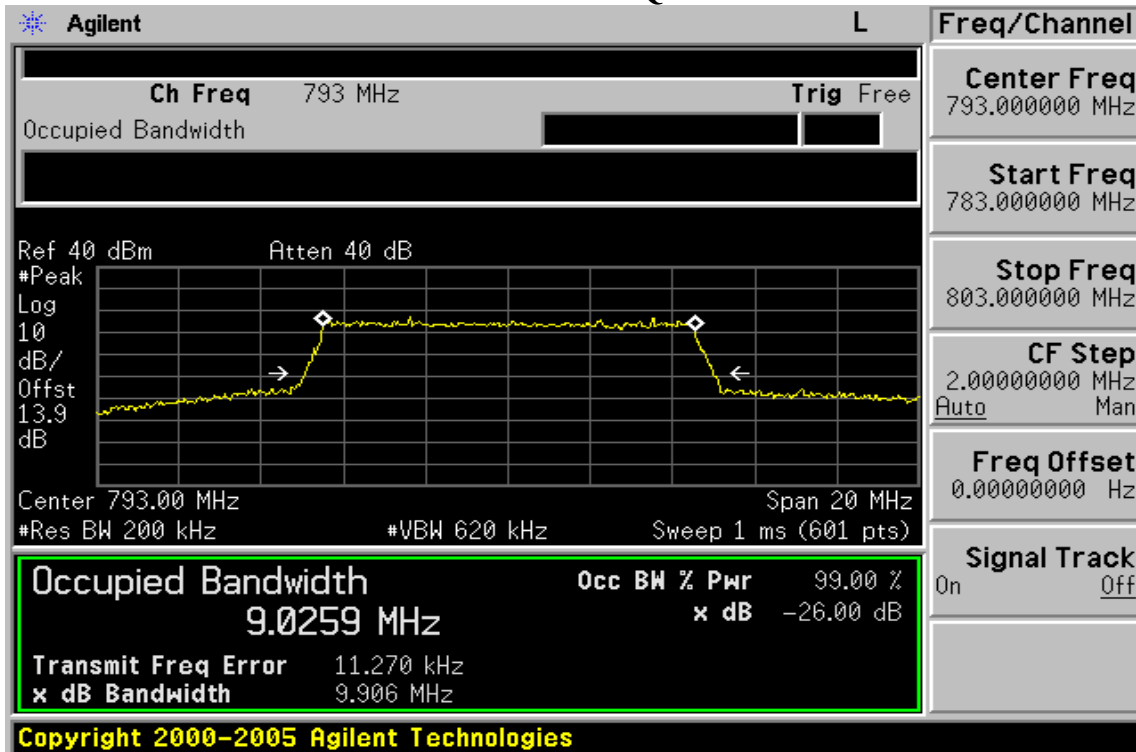

## **9. OUT OF BAND EMISSION AT ANTENNA TERMINALS**

### **9.1. Standard Applicable**

FCC §90.543(c) Out-of-band emission limit. On any frequency outside of the frequency ranges covered by the ACP tables in this section, the power of any emission must be reduced below the mean output power (P) by at least  $43 + 10\log(P)$  dB measured in a 100 kHz bandwidth for frequencies less than 1 GHz, and in a 1 MHz bandwidth for frequencies greater than 1 GHz..

FCC §90.543(e) (2)

On all frequencies between 769-775 MHz and 799-805 MHz, by a factor not less than  $65 + 10 \log(P)$  dB in a 6.25 kHz band segment, for mobile and portable stations.( -35dBm)



## 9.2. Test SET-UP

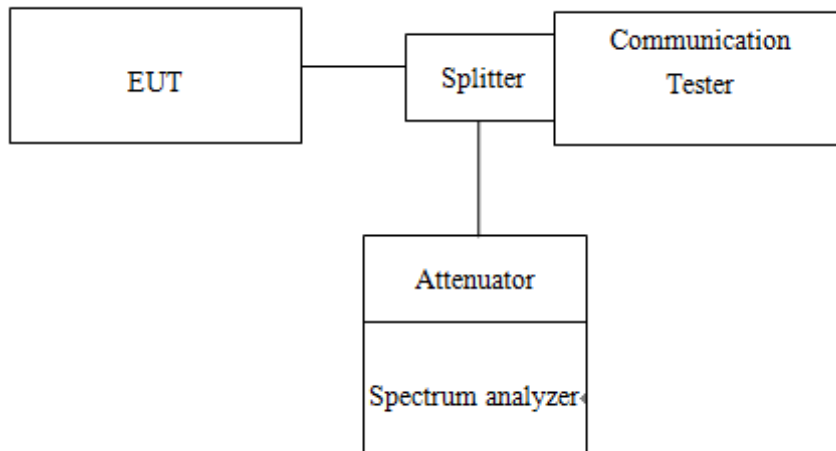

## 9.3. Measurement Procedure

### Conducted Emission

The RF output of the transceiver was connected to a spectrum analyzer through appropriate attenuation. The resolution bandwidth of the spectrum analyzer was set at 1MHz, sufficient scans were taken to show the out of band Emissions if any up to 10th harmonic.

1. To connect Antenna Port of EUT to Spectrum.
2. Set RBW = 1MHz & VBW = 1MHz on Spectrum.
3. Allow trace to fully stabilize
4. Repeat above procedures until all default test channel measured were complete.

### Band Edge

1. To connect Antenna Port of EUT to Spectrum.
2. The band edge of low and high channels for the highest RF powers was measured. Setting RBW  $\geq$  1% EBW.
3. Allow trace to fully stabilize
4. Repeat above procedures until all default test channel measured were complete.

**9.4. Measurement Equipment Used**

Conducted Emission Test Site					
EQUIPMENT TYPE	MFR	MODEL NUMBER	SERIAL NUMBER	LAST CAL.	CAL DUE.
Spectrum Analyzer	Agilent	E4446A	MY51100003	05/19/2014	05/18/2015
Radio Communication Analyzer	Anritsu	MT8820C	6200995019	10/08/2014	10/09/2015
Temperature Chamber	TERCHY	MHG-120LF	911009	05/06/2015	05/05/2016
DC Block	Mini-Circuits	BLK-18-S+	1	01/02/2015	01/01/2016
Attenuator	Mini-Circuit	BW-S10W2+	002	01/02/2015	01/01/2016
Splitter	Agilent	11636B	N/A	01/02/2015	01/01/2016
DC Power Supply	Agilent	E3640A	MY52410006	11/10/2014	11/09/2015

**9.5. Measurement Result:**

Refer to next pages.

*NOTE: The occurrence of the spike on the conducted emission is the signal of the fundamental emission.*

**Out of Band emission at antenna terminals –5MHz BW LTE-Band 14  
(QPSK RB Number: 1 Offset: 0) Channel Low**

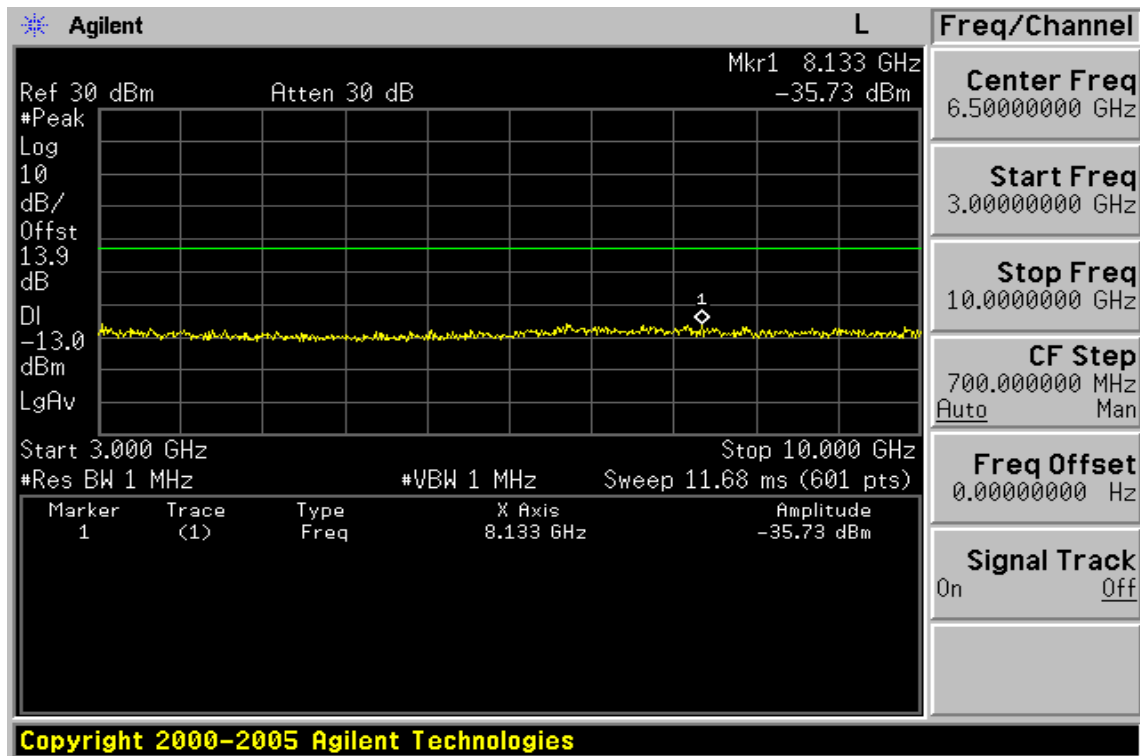
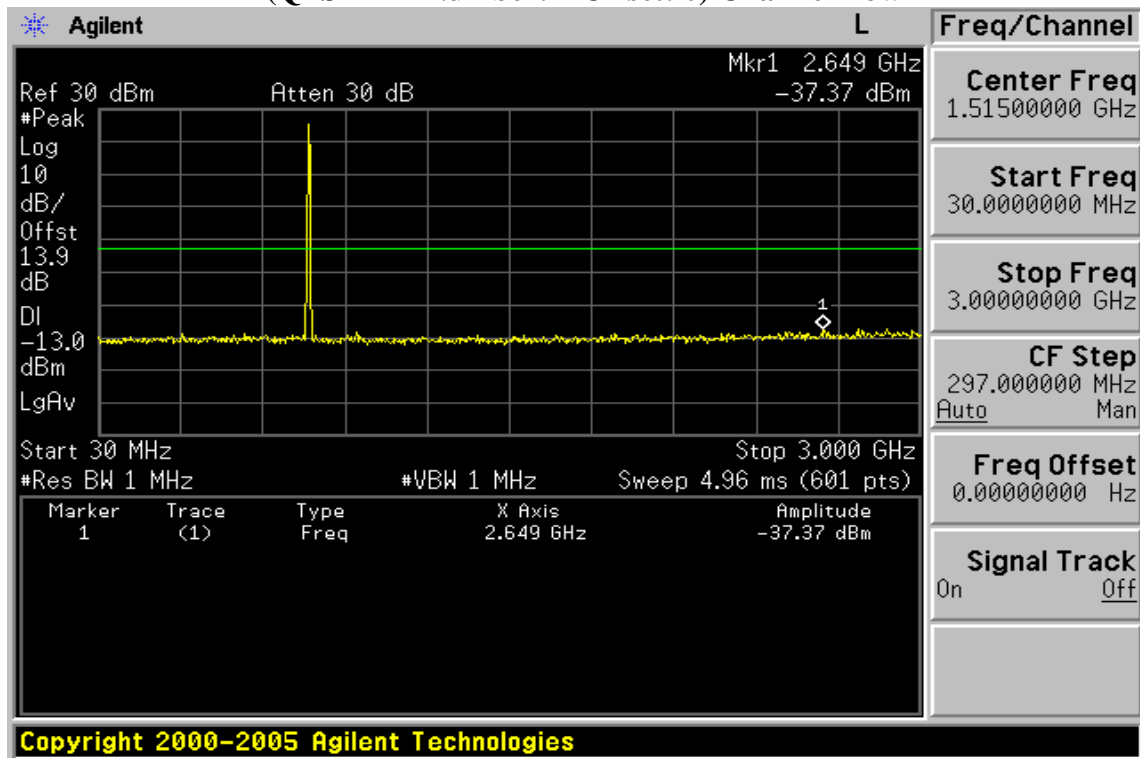

**Out of Band emission at antenna terminals –5MHz BW LTE-Band 14  
(QPSK RB Number: 1 Offset: 0) Channel Mid**

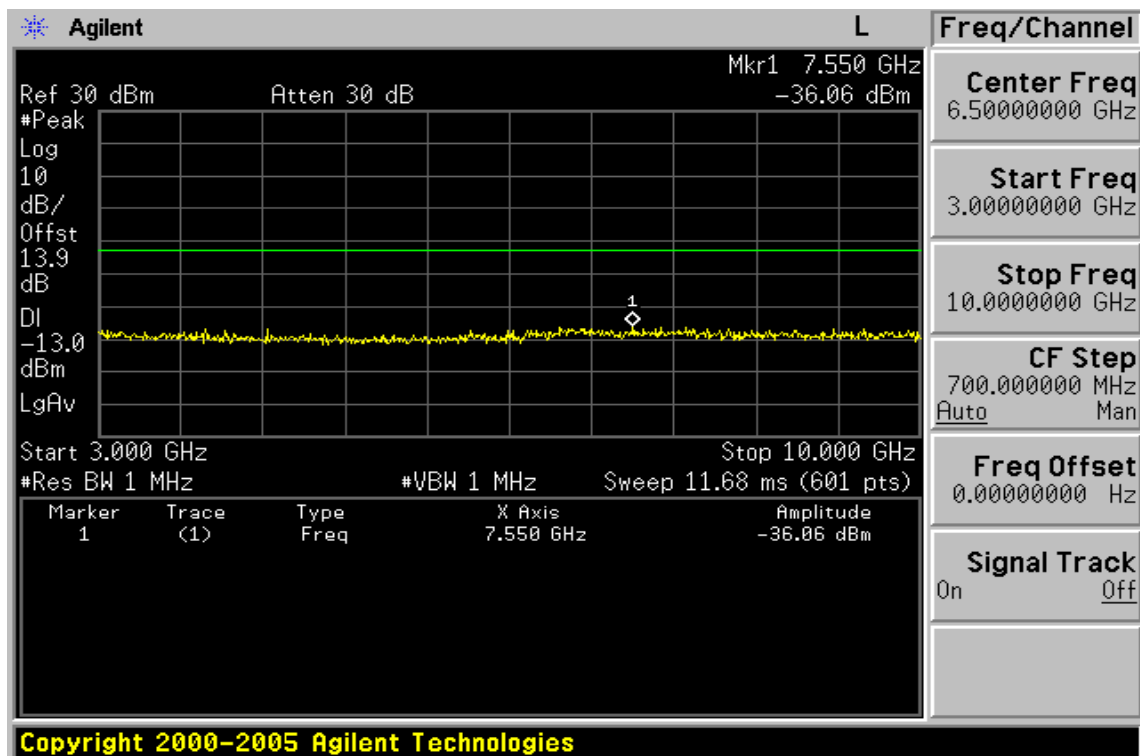
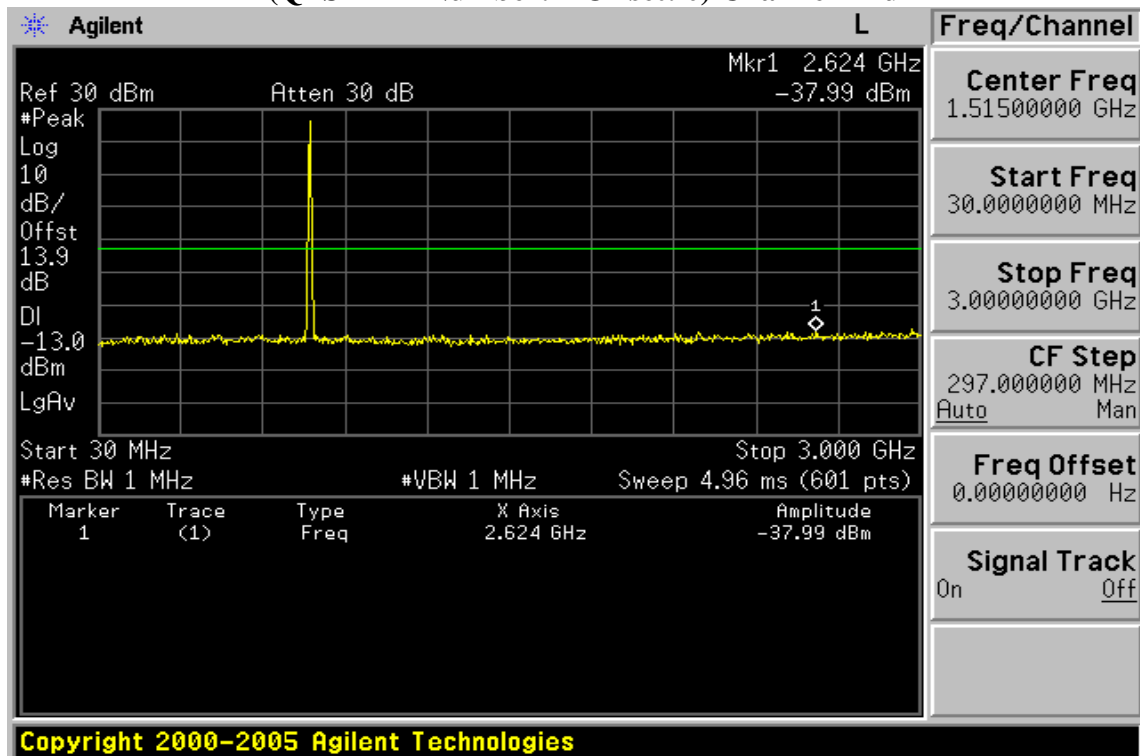

**Out of Band emission at antenna terminals–5MHz BW LTE-Band 14  
 (QPSK RB Number: 1 Offset: 0) Channel Highest**

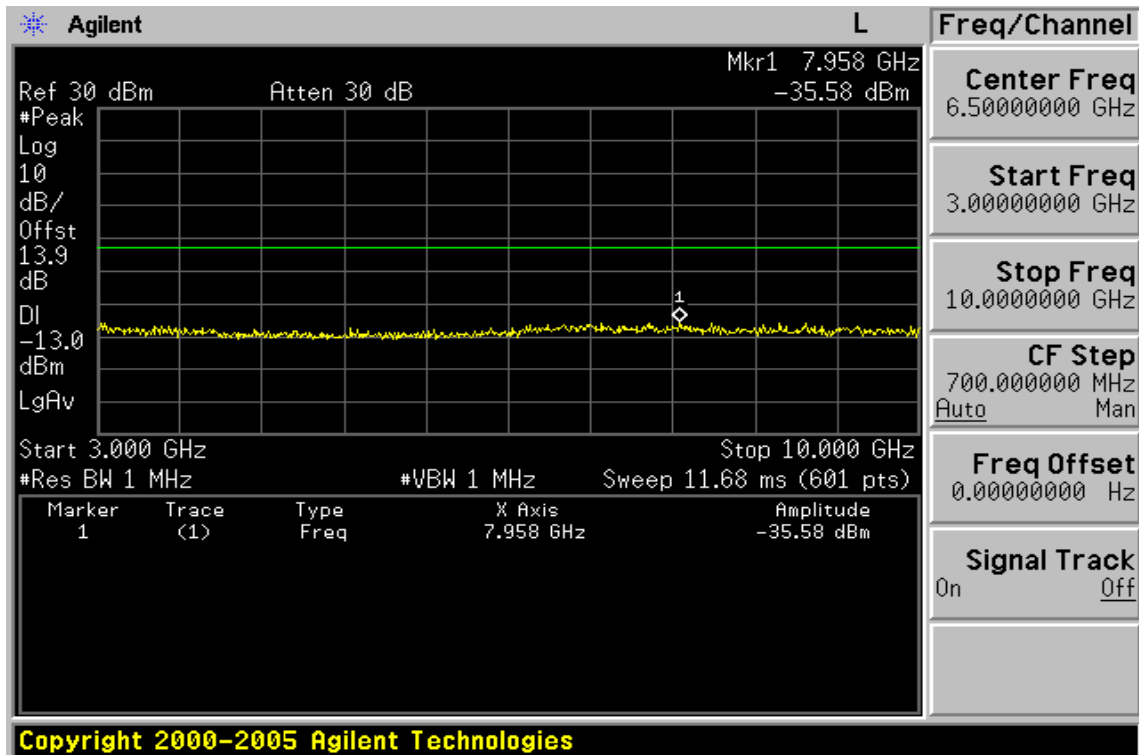
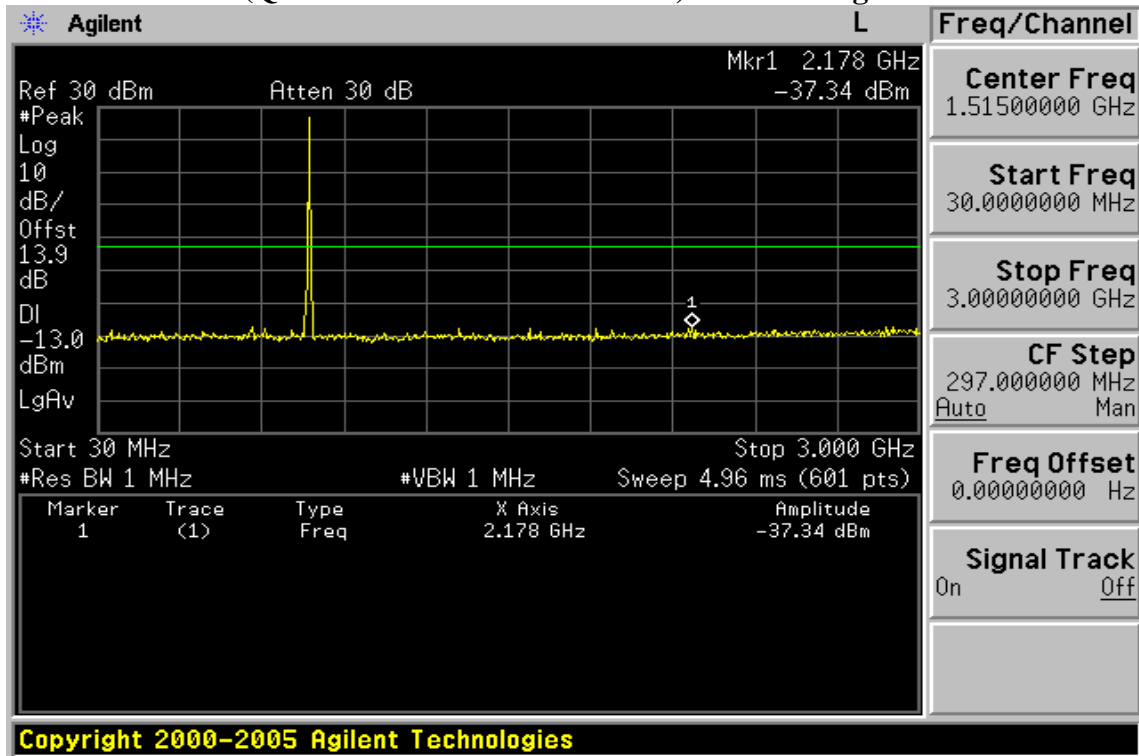

**Band edge emission at antenna terminals –5MHz BW LTE-Band 14  
 (QPSK RB Number: 1 Offset: 0) Channel Lowest**



**Band edge emission at antenna terminals –5MHz BW LTE-Band 14  
 (QPSK RB Number: 1 Offset: 24) Channel Highest**



**Band edge emission at antenna terminals –5MHz BW LTE-Band 14  
(QPSK RB Number: 25 Offset: 0) Channel Lowest**

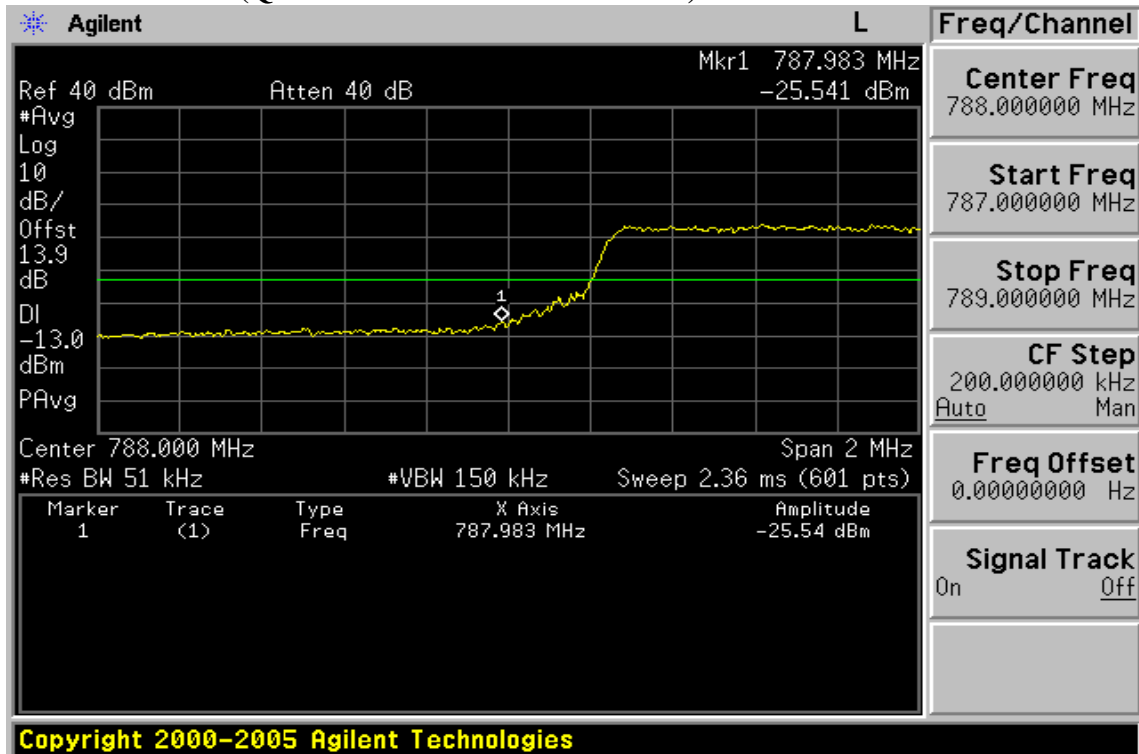

**Band edge emission at antenna terminals –5MHz BW LTE-Band 14  
(QPSK RB Number: 25 Offset: 0) Channel Highest**

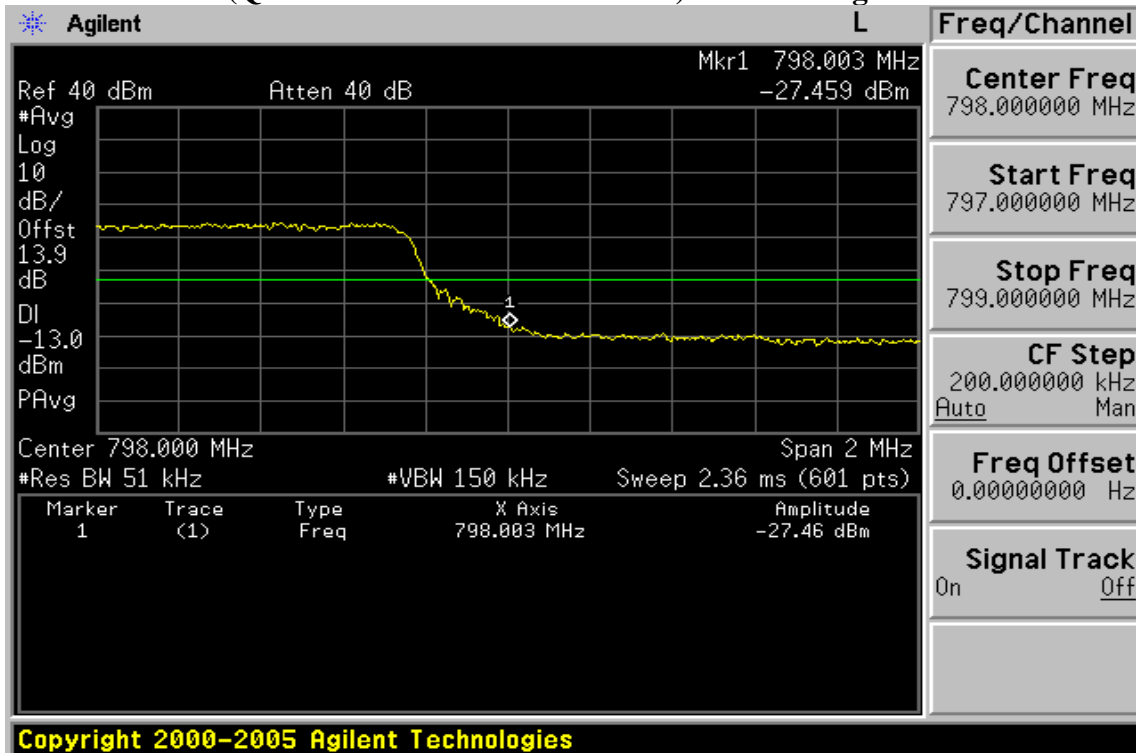

**Out of Band emission at antenna terminals–10MHz BW LTE-Band 14  
(QPSK RB Number: 1 Offset: 0) Channel Mid**

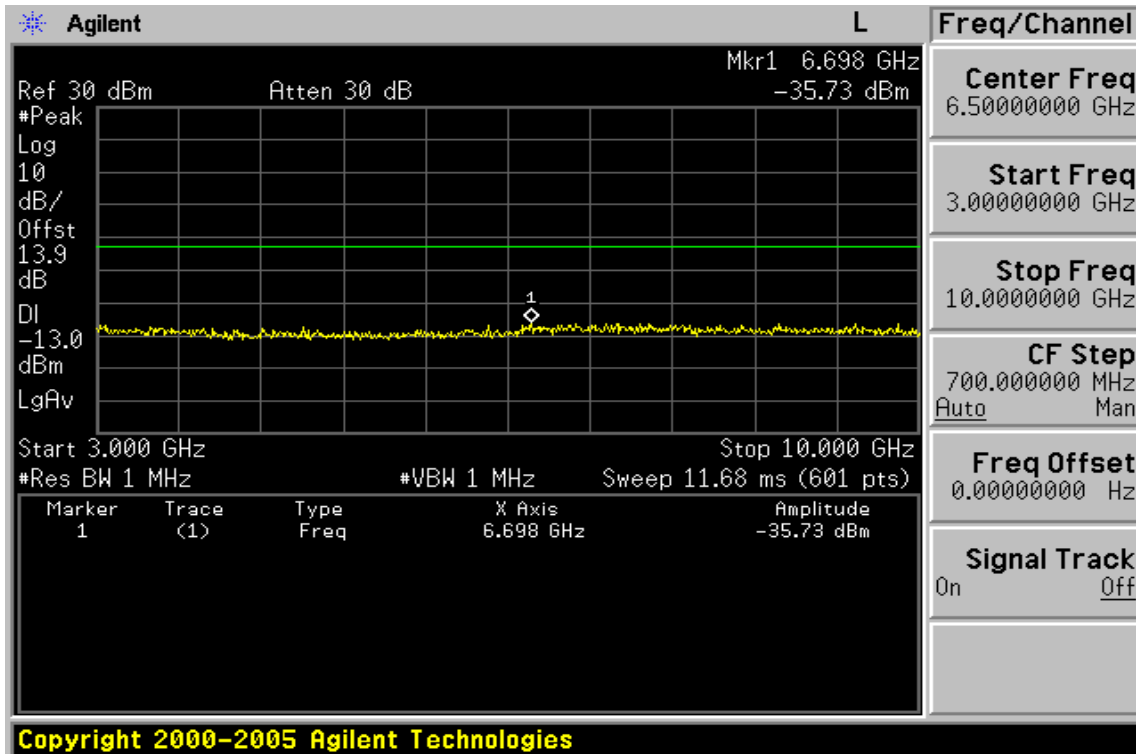
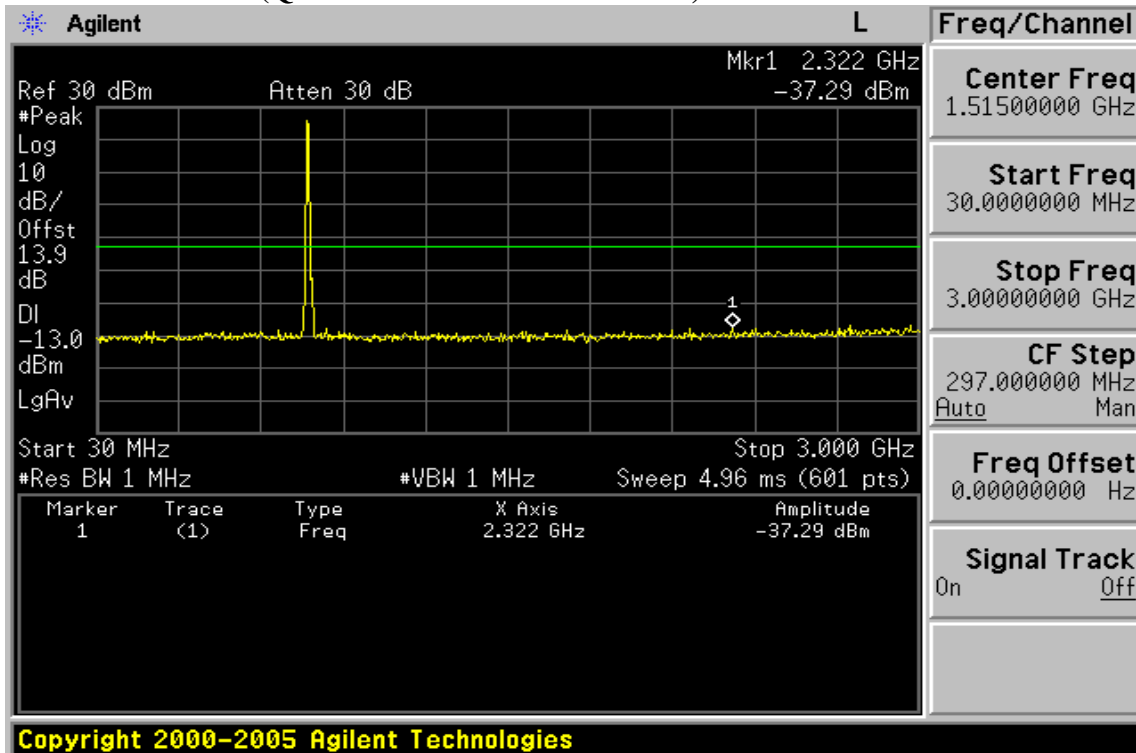



**Band edge emission at antenna terminals –10MHz BW LTE-Band 14  
(QPSK RB Number: 1 Offset: 0) Channel Lowest**



**Band edge emission at antenna terminals –10MHz BW LTE-Band 14  
(QPSK RB Number: 1 Offset: 49) Channel Highest**



**Band edge emission at antenna terminals –10MHz BW LTE-Band 14  
(QPSK RB Number: 50 Offset: 0) Channel Lowest**

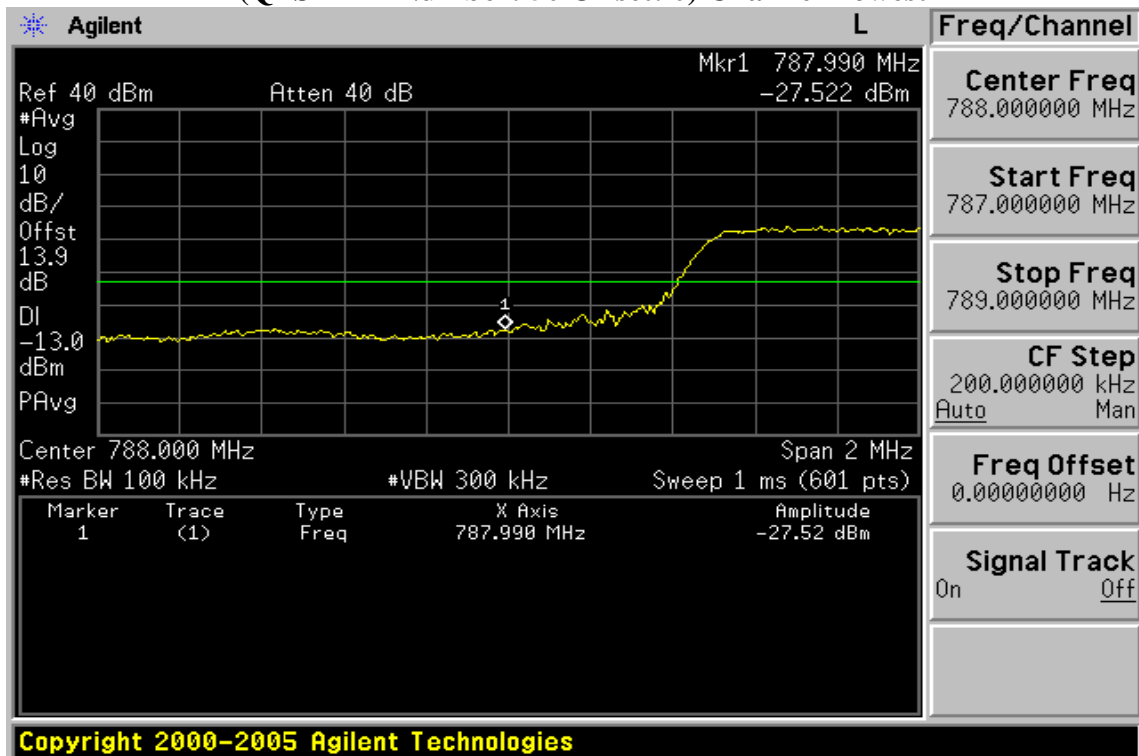

**Band edge emission at antenna terminals –10MHz BW LTE-Band 14  
(QPSK RB Number: 50 Offset: 0) Channel Highest**

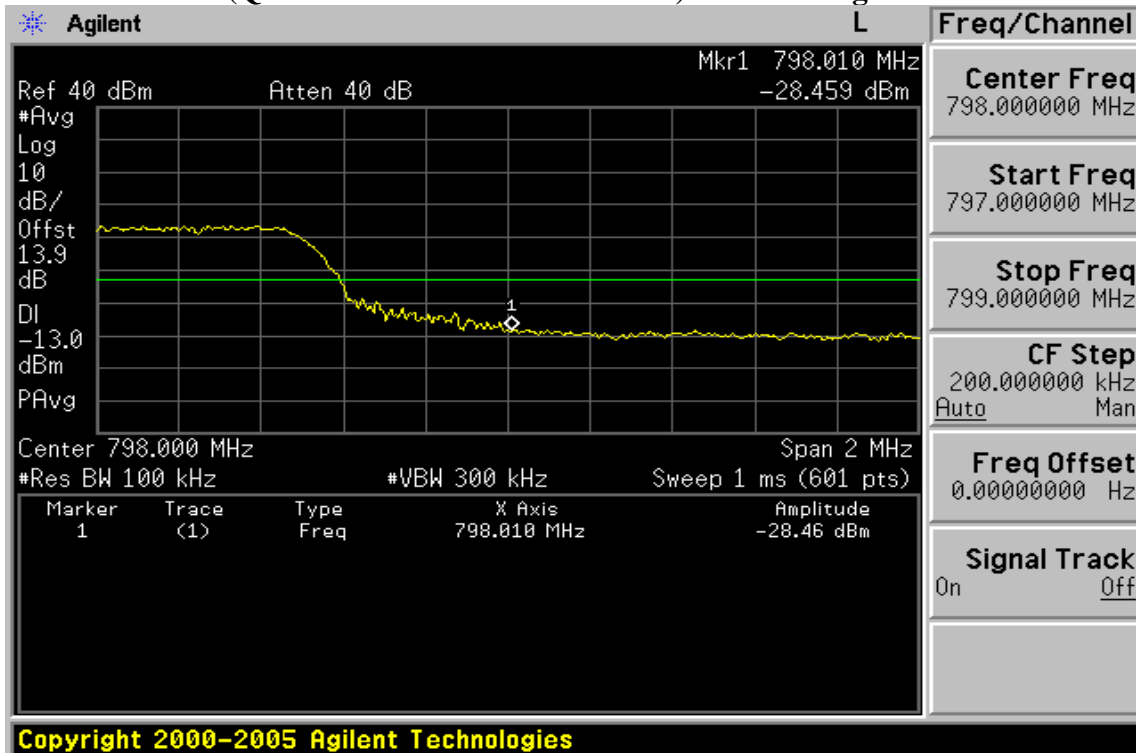

**Out of Band emission at antenna terminals–5MHz BW LTE-Band 14  
(QPSK RB Number: 1 Offset: 0) Channel Lowest (769-775MHz)**

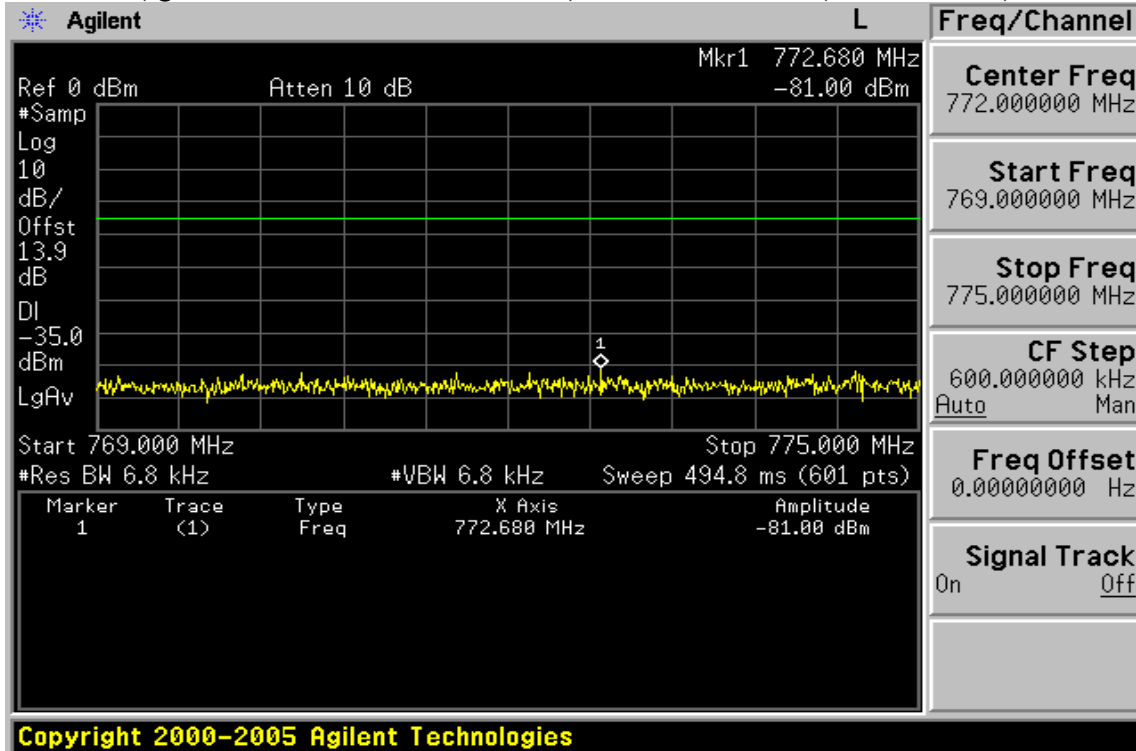

**Out of Band emission at antenna terminals–5MHz BW LTE-Band 14  
(QPSK RB Number: 1 Offset: 0) Channel Lowest (799-805MHz)**

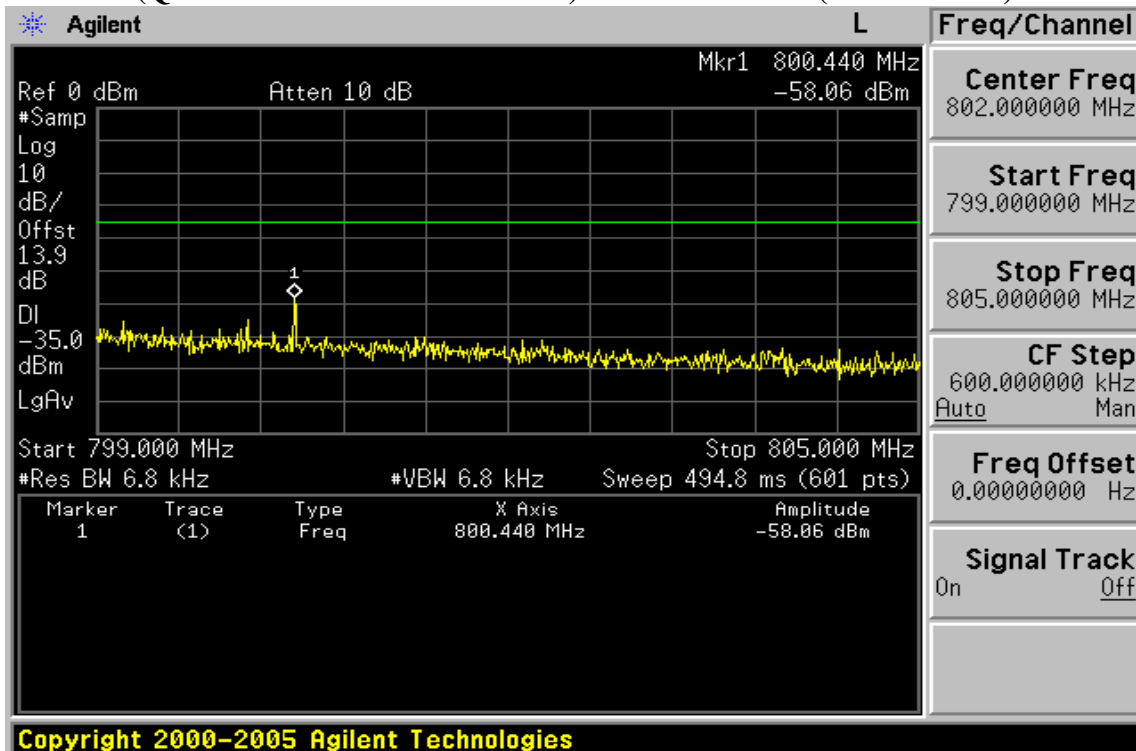

**Out of Band emission at antenna terminals –5MHz BW LTE-Band 14  
(QPSK RB Number: 1 Offset: 0) Channel Mid (769-775MHz)**

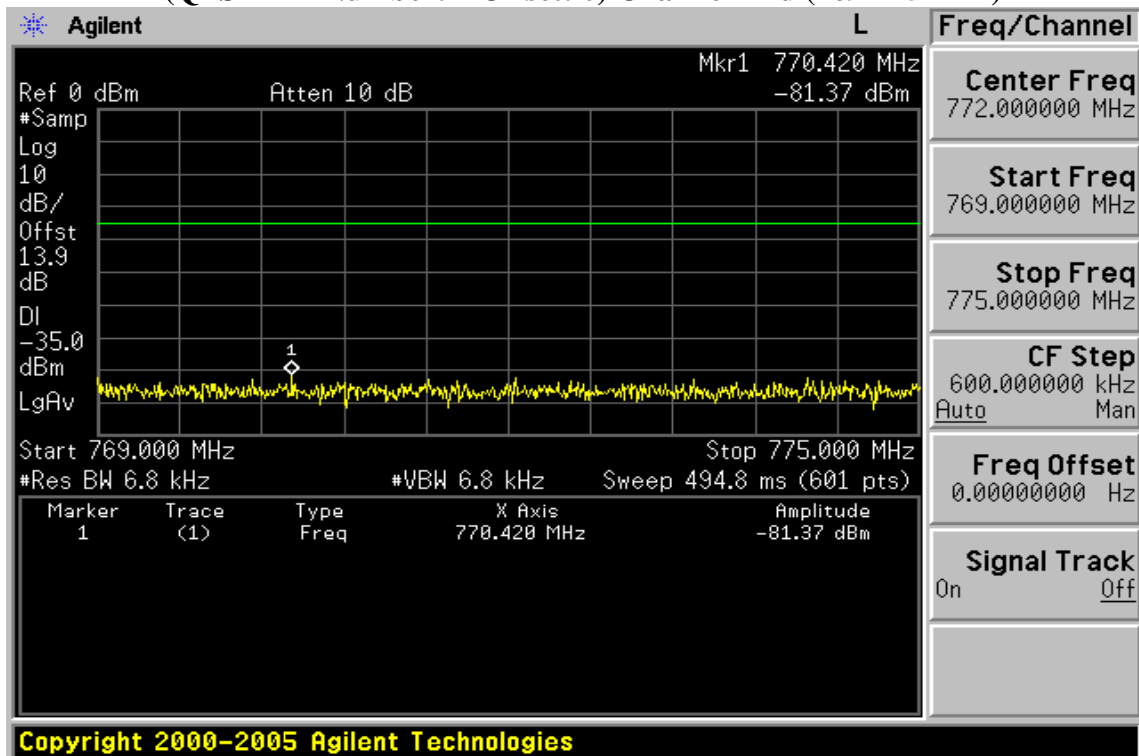

**Out of Band emission at antenna terminals –5MHz BW LTE-Band 14  
(QPSK RB Number: 1 Offset: 0) Channel Mid (799-805MHz)**

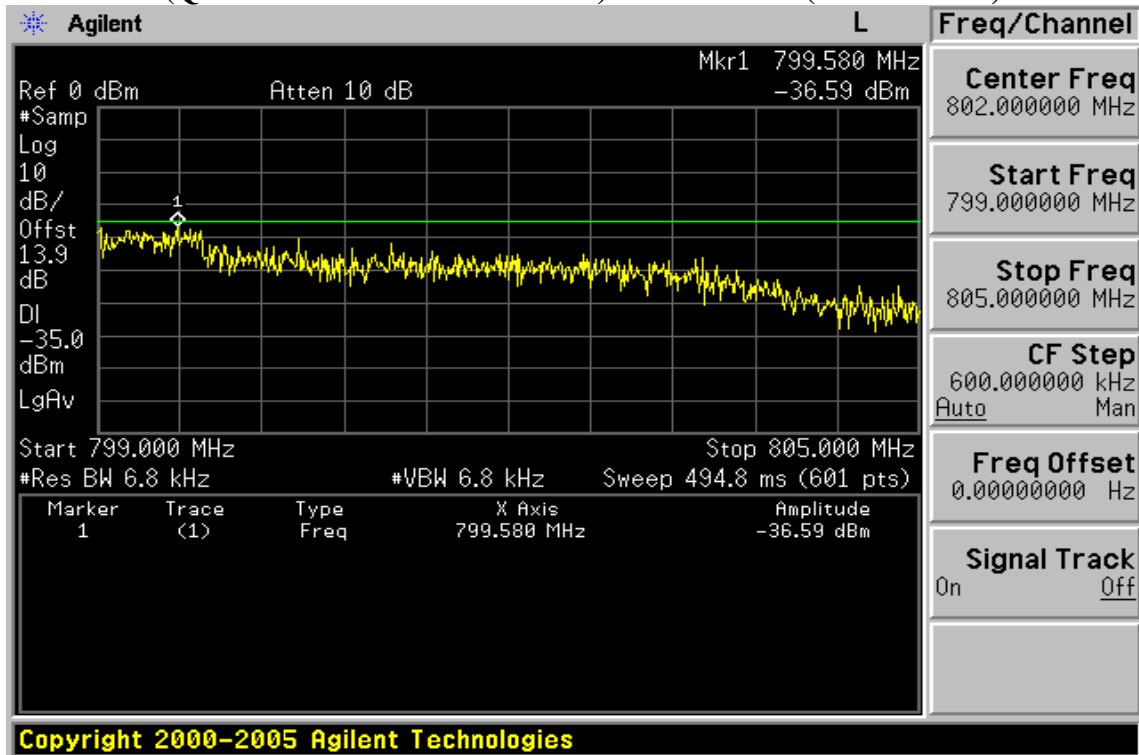

**Out of Band emission at antenna terminals–5MHz BW LTE-Band 14  
 (QPSK RB Number: 1 Offset: 0) Channel Highest (769-775MHz)**

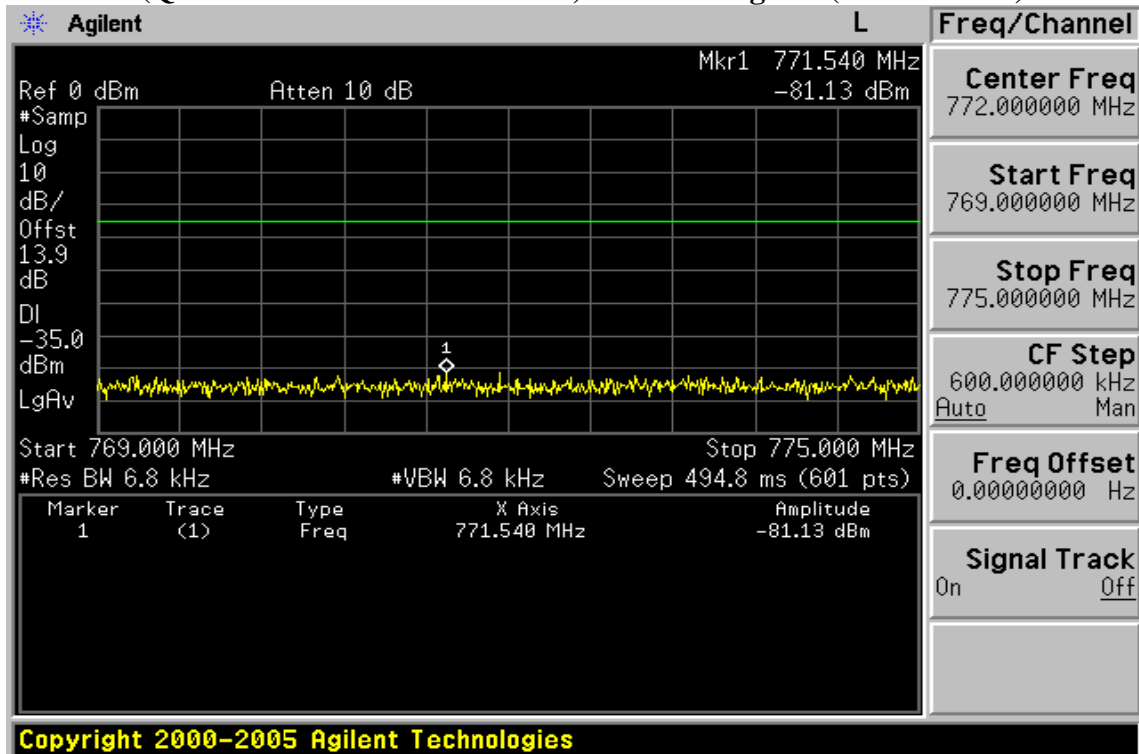

**Out of Band emission at antenna terminals–5MHz BW LTE-Band 14  
 (QPSK RB Number: 1 Offset: 0) Channel Highest (799-805MHz)**

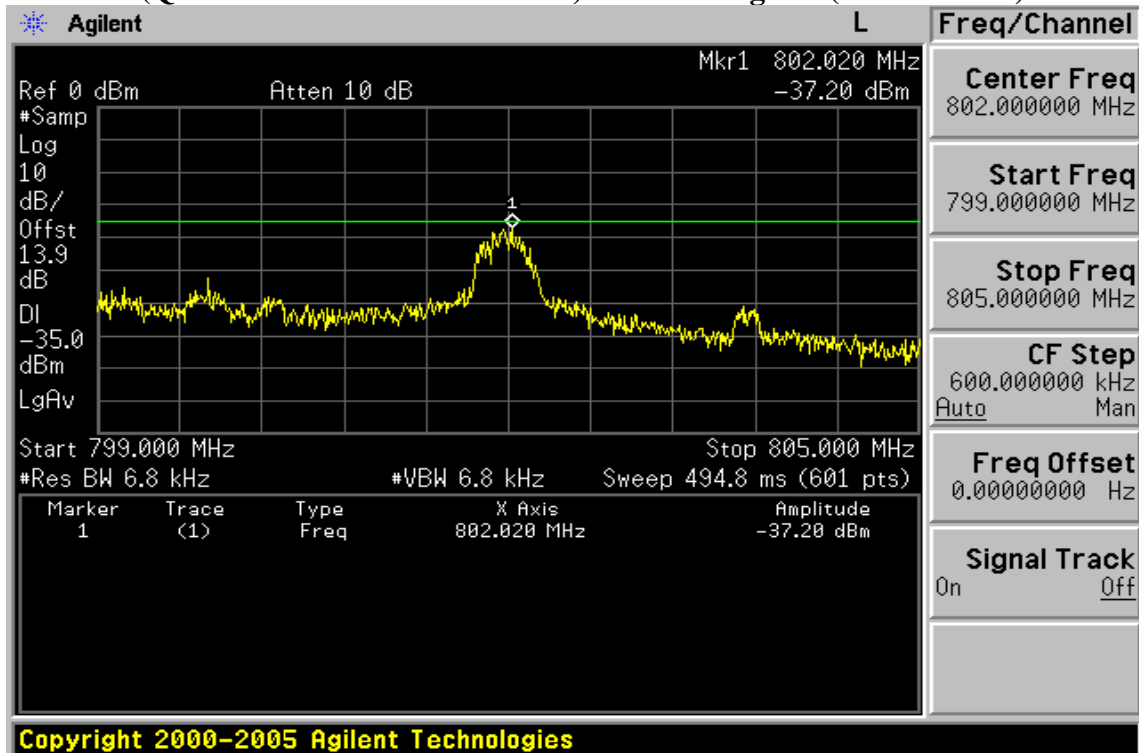

**Out of Band emission at antenna terminals–10MHz BW LTE-Band 14  
 (QPSK RB Number: 1 Offset: 0) Channel Mid (769-775MHz)**

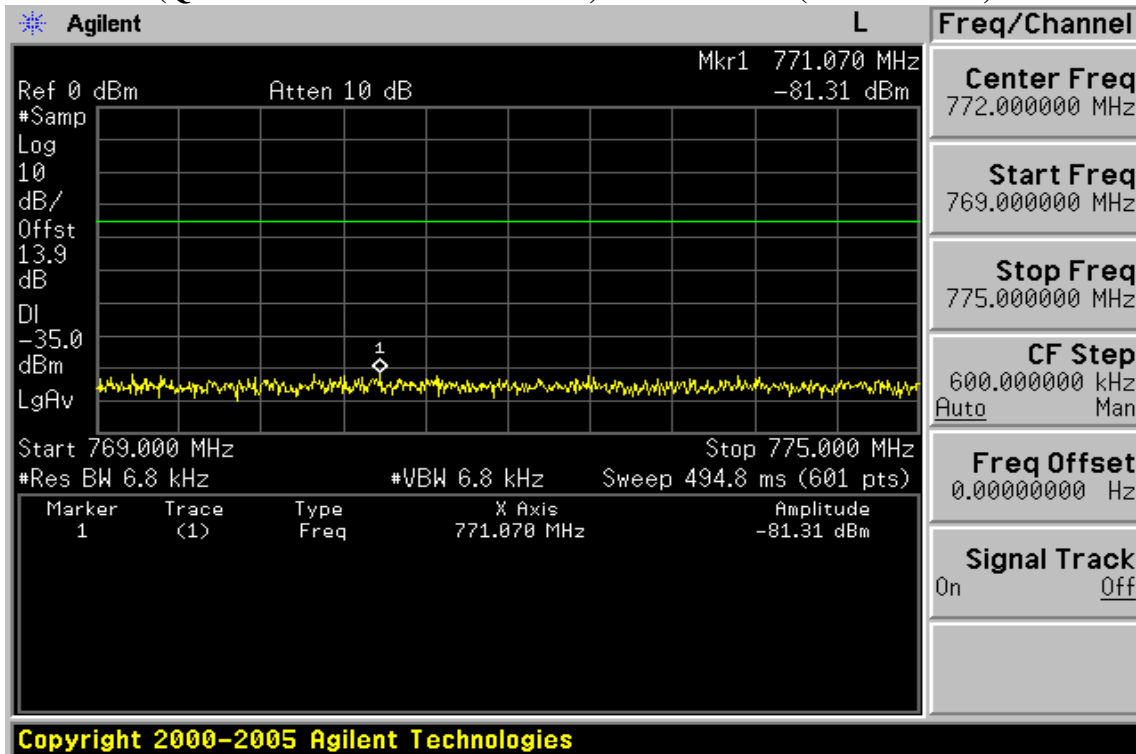

**Out of Band emission at antenna terminals–10MHz BW LTE-Band 14  
 (QPSK RB Number: 1 Offset: 0) Channel Mid (799-805MHz)**

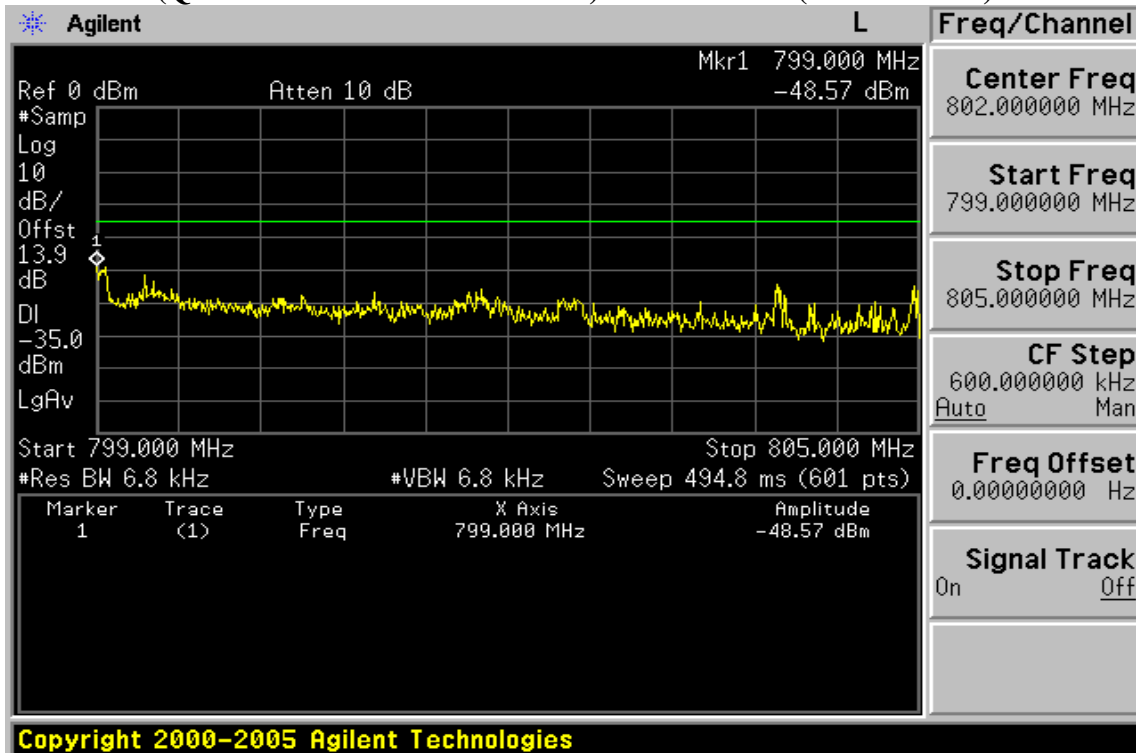

## 10. FIELD STRENGTH OF SPURIOUS RADIATION MEASUREMENT

### 10.1. Standard Applicable

FCC §90.543(c) Out-of-band emission limit. On any frequency outside of the frequency ranges covered by the ACP tables in this section, the power of any emission must be reduced below the mean output power (P) by at least  $43 + 10\log(P)$  dB measured in a 100 kHz bandwidth for frequencies less than 1 GHz, and in a 1 MHz bandwidth for frequencies greater than 1 GHz..

FCC §90.543(c)

For operations in the 758-775 MHz and 788-805 MHz bands, all emissions including harmonics in the band 1559-1610 MHz shall be limited to  $-70$  dBW/MHz ( $-40$ dBm) equivalent isotropically radiated power (EIRP) for wideband signals, and  $-80$  dBW EIRP ( $-50$ dBm) for discrete emissions of less than 700 Hz bandwidth. For the purpose of equipment authorization, a transmitter shall be tested with an antenna that is representative of the type that will be used with the equipment in normal operation.

### 10.2. EUT Setup

(A) Radiated Emission Test Set-UP Frequency Below 30MHz.

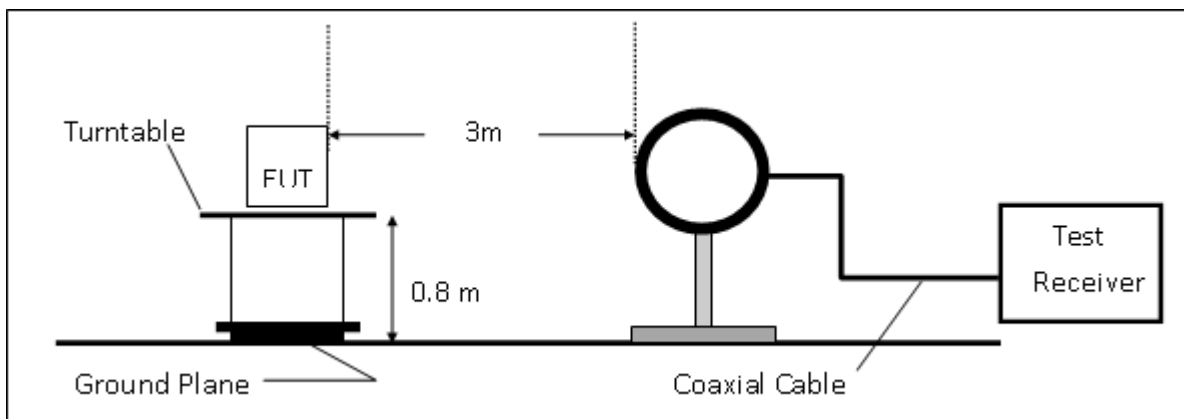

(B) Radiated Emission Test Set-Up, Frequency form 30MHz to 1000MHz

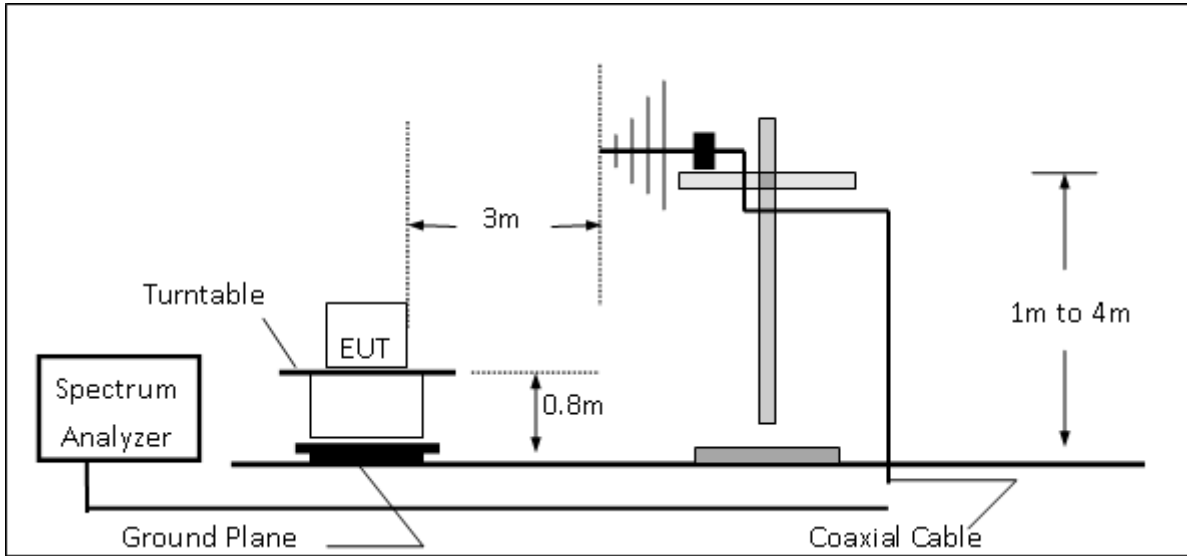

(C) Radiated Emission Test Set-UP Frequency Over 1 GHz

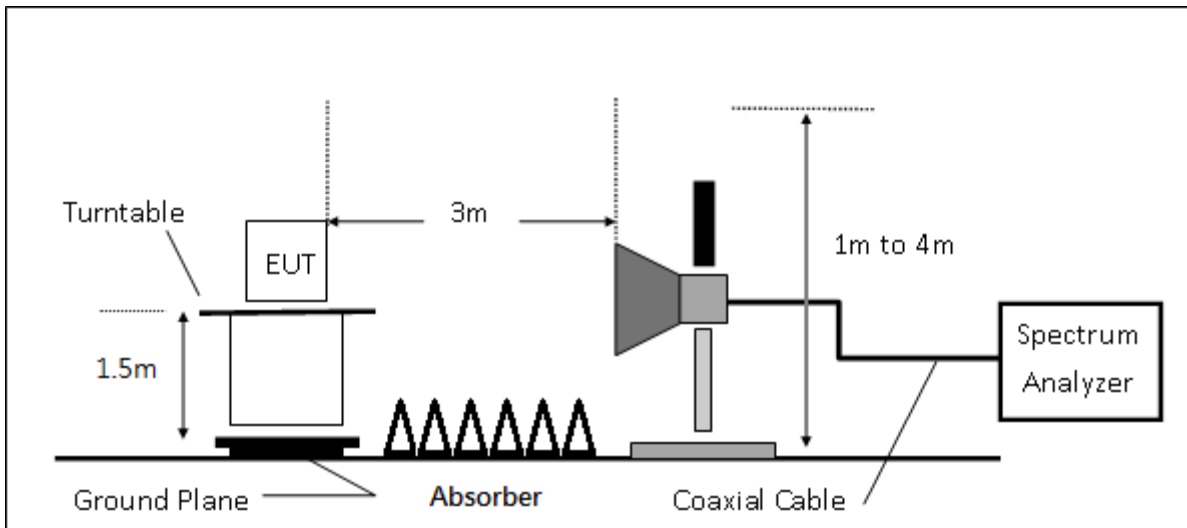



### 10.3. Measurement Procedure:

The EUT was placed on a non-conductive; the measurement antenna was placed at a distance of 3 meters from the EUT. During the tests, the antenna height and the EUT azimuth were varied in order to identify the maximum level of emissions from the EUT. This maximization process was repeated with the EUT positioned in each of its three orthogonal orientations.

The frequency range up to tenth harmonic was investigated for each of three fundamental frequencies (low, middle and high channels). Once spurious emission was identified, the power of the emission was determined using the substitution method.

The spurious emissions attenuation was calculated as the difference between radiated power at the fundamental frequency and the spurious emissions frequency.

$$\text{ERP (dBm)} = \text{SG Level(dBm)} + \text{Antenna Gain(dBd)} + \text{Cable Loss(dB)}$$

$$\text{EIRP (dBm)} = \text{SG Level(dBm)} + \text{Antenna Gain(dBi)} + \text{Cable Loss(dB)}$$

Note : “F” : denotes Fundamental Frequency. ; “H” : denotes Harmonic Frequency.

“E” : denotes Band Edge Frequency. ; “S” : denotes Spurious Frequency.

“---“ : denotes Noise Floor.

**10.4. Measurement Equipment Used:**

SGS 966 Chamber No.C					
Name of Equipment	Manufacturer	Model	Serial Number	Calibration Date	Calibration Due
Spectrum Analyzer	Agilent	E4446A	MY51100003	05/19/2014	05/18/2015
EXA Spectrum Analyzer	Agilent	N9010A	MY50420195	12/22/2014	12/21/2015
Spectrum Analyzer	R&S	FSV-30	101398	10/07/2014	10/06/2015
Bilog Antenna	SCHWAZBECK	VULB9168	378	12/23/2014	12/22/2015
Bilog Antenna	SCHWAZBECK	VULB9160	3158	10/31/2014	10/30/2015
Horn antenna	ETS.LINDGREN	3117	123995	05/19/2014	05/18/2015
Horn antenna	ETS.LINDGREN	3117	123991	12/19/2014	12/18/2015
Horn Antenna	Schwarzbeck	BBHA9170	184	12/25/2014	12/24/2015
Horn Antenna	Schwarzbeck	BBHA9170	185	07/29/2014	07/28/2015
Network Analyze	Anritsu	MS4644A	1216312	05/24/2014	05/23/2015
Signal Generator	Agilent	E4438C	MY45093613	08/06/2014	08/05/2015
Pre-Amplifier	Agilent	8447D	1937A02834	01/02/2015	01/01/2016
Attenuator	Mini-Circuit	BW-S10W2+	004	01/02/2015	01/01/2016
Radio Communication Analyzer	R&S	CMU200	102189	02/11/2015	02/10/2016
Radio Communication Analyzer	Anritsu	MT8820C	6200995019	10/08/2014	10/09/2015
Turn Table	HD	DT420	N/A	N.C.R	N.C.R
Antenna Tower	HD	MA240-N	240/657	N.C.R	N.C.R
Controller	HD	HD100	N/A	N.C.R	N.C.R
Low Loss Cable	HUBER+SUHNER	966_Tx	10m	01/02/2015	01/01/2016
Low Loss Cable	HUBER+SUHNER	966_Rx	3m	01/02/2015	01/01/2016
Filter 800-1000	Micro-Tronics	EWT	M2	01/02/2015	01/01/2016
Filter 1800-2000	Micro-Tronics	EWT	M2	01/02/2015	01/01/2016
Filter 1700-1800	Micro-Tronics	BRC15751	001	01/02/2015	01/01/2016
1GHz High Pass Filter	Micro-Tronics	HPM50108	32	01/02/2015	01/01/2016
2GHz High Pass Filter	Micro-Tronics	HPM50110	36	01/02/2015	01/01/2016
3m Site NSA	SGS	966 chamber	N/A	07/15/2014	07/14/2015

**10.5. Measurement Result (Below 1GHz):**

**11. Radiated Spurious Emission Measurement Result: 10MHz BW LTE-Band 14 (The Worst Case)**

ARFCN	: QPSK BW 10 RB1 0	Test Date	:2015-04-18
Operation Band	: LTE B14	Temp./Humi.	:23 deg_C / 52 RH
Fundamental Frequency	:793.0 MHz	Engineer	:Tin
Operation Mode	:TX MID		
EUT Pol.	:E2 Plane	Measurement Antenna Pol.	:VERTICAL

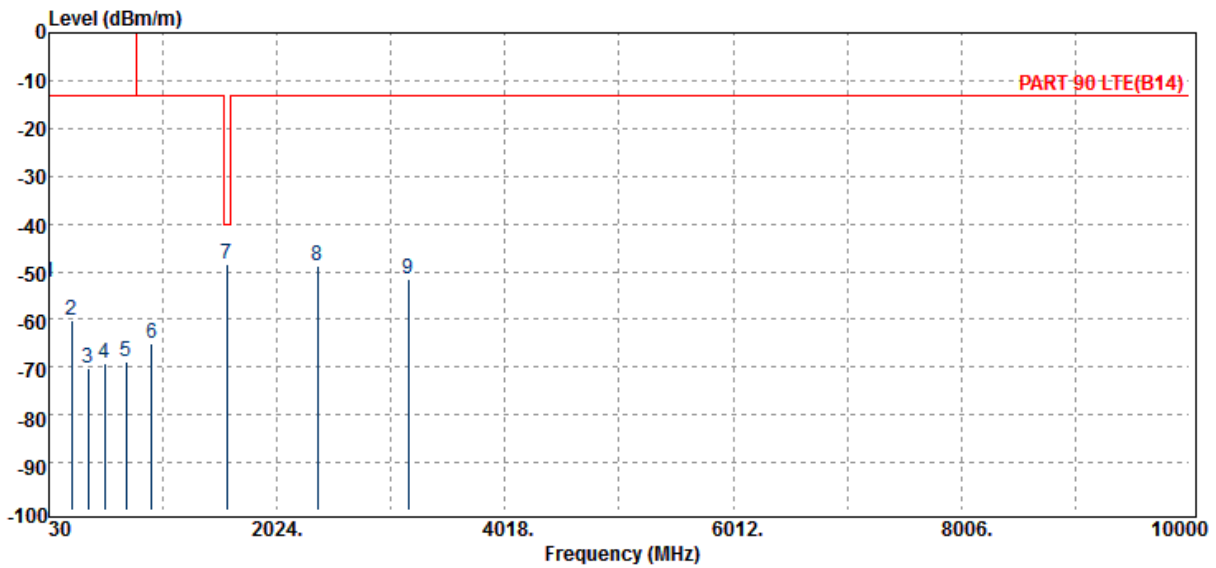

**12.**

Freq. MHz	Note F/H/E/S	ERP dBm	SG Output Level dBm	Antenna Gain dBd	Cable Loss dB	Limit dBm	Margin dB
35.82	S	-52.35	-38.07	-13.49	-0.79	-13.00	-39.35
229.82	S	-60.11	-61.85	3.31	-1.58	-13.00	-47.11
373.38	S	-70.11	-71.85	3.69	-1.96	-13.00	-57.11
515.97	S	-69.24	-70.56	3.70	-2.39	-13.00	-56.24
705.12	S	-68.88	-69.64	3.37	-2.60	-13.00	-55.88
927.25	S	-65.15	-65.22	3.25	-3.17	-13.00	-52.15
1586.00	H	-48.30	-47.35	3.18	-4.12	-40.00	-8.30
2379.00	H	-48.71	-46.94	3.38	-5.16	-13.00	-35.71
3172.00	H	-51.63	-50.41	5.19	-6.41	-13.00	-38.63

**13.**  
 ARFCN : QPSK BW 10 RB1 0 Test Date :2015-04-18  
 Operation Band : LTE B14 Temp./Humi. :23 deg\_C / 52 RH  
 Fundamental Frequency :793.0 MHz Engineer :Tin  
 Operation Mode :TX MID  
 EUT Pol. :E2 Plane Measurement Antenna Pol. :HORIZONTAL

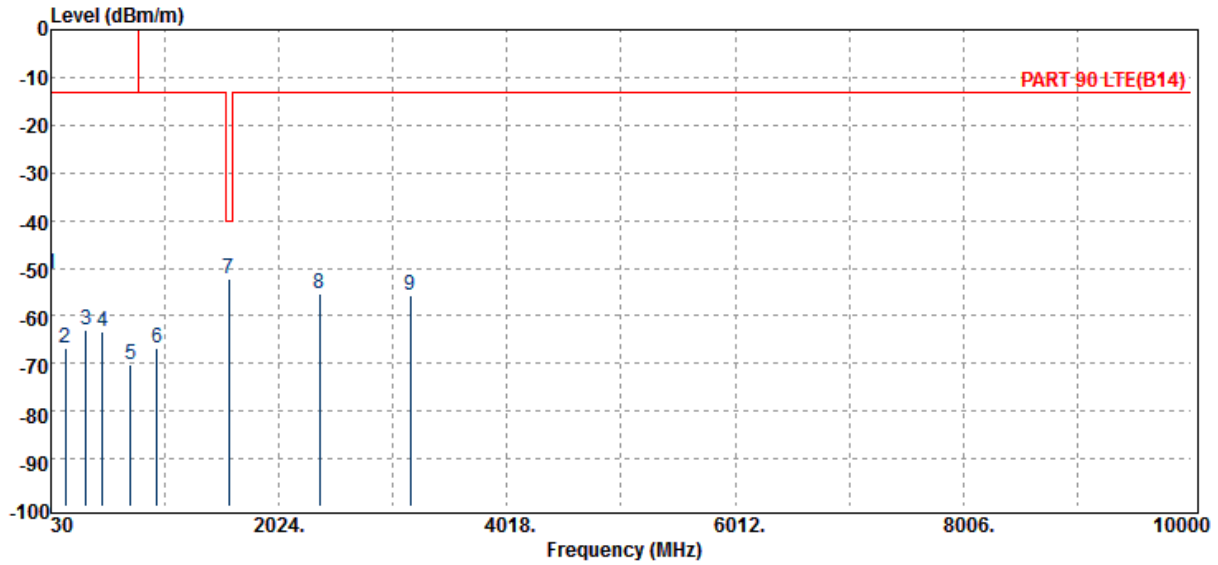

**14.**

Freq. MHz	Note F/H/E/S	ERP dBm	SG Output Level dBm	Antenna Gain dBd	Cable Loss dB	Limit dBm	Margin dB
35.82	S	-51.21	-36.93	-13.49	-0.79	-13.00	-38.21
153.19	S	-66.94	-63.65	-1.88	-1.40	-13.00	-53.94
337.49	S	-62.90	-64.70	3.73	-1.92	-13.00	-49.90
478.14	S	-63.31	-64.72	3.58	-2.17	-13.00	-50.31
723.55	S	-70.22	-70.92	3.33	-2.63	-13.00	-57.22
958.29	S	-66.95	-66.42	2.68	-3.21	-13.00	-53.95
1586.00	H	-52.31	-51.36	3.18	-4.12	-40.00	-12.31
2379.00	H	-55.40	-53.62	3.38	-5.16	-13.00	-42.40
3172.00	H	-55.70	-54.47	5.19	-6.41	-13.00	-42.70

## 15. FREQUENCY STABILITY MEASUREMENT

### 15.1. Standard Applicable:

The frequency stability shall be sufficient to ensure that the fundamental emission stays within the authorized frequency block.

### 15.2. Test Set-up:

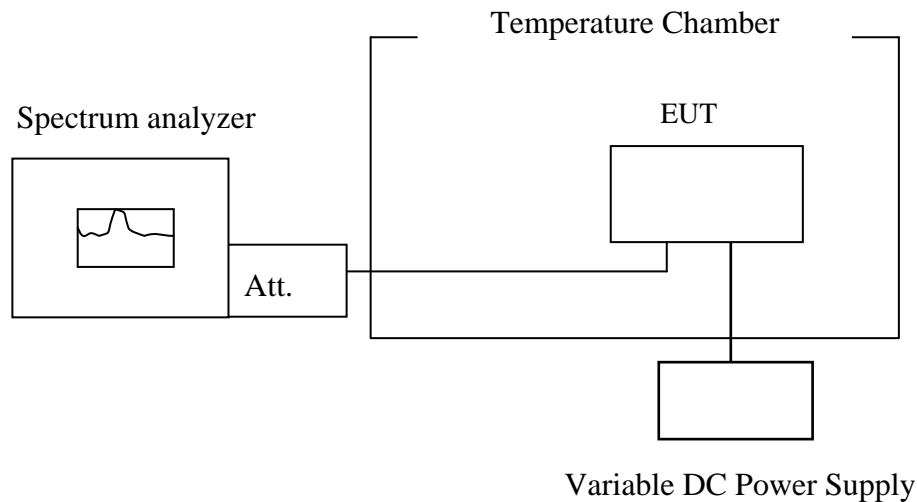

**Note:** Measurement setup for testing on Antenna connector

### 15.3. Measurement Procedure:

The equipment under test was connected to an external AC or DC power supply and input rated voltage. RF output was connected to a frequency counter or spectrum analyzer via feed through attenuators. The EUT was placed inside the temperature chamber. Set the spectrum analyzer RBW low enough to obtain the desired frequency resolution and measure EUT 25°C operating frequency as reference frequency. Turn EUT off and set the chamber temperature to -30°C. After the temperature stabilized for approximately 30 minutes recorded the frequency. Repeat step measure with 10°C increased per stage until the highest temperature of +50°C reached.

Set chamber temperature to 25 . Use a variable AC power supply / DC power source to power the EUT and set the voltage to rated voltage. Set the spectrum analyzer RBW low enough to obtain the desired frequency resolution and recorded the frequency.

Reduce the input voltage to specify extreme voltage variation (+/- 15%) and endpoint as declared by the manufacturer, record the maximum frequency change.

**15.4. Measurement Equipment Used:**

<b>Conducted Emission Test Site</b>					
<b>EQUIPMENT TYPE</b>	<b>MFR</b>	<b>MODEL NUMBER</b>	<b>SERIAL NUMBER</b>	<b>LAST CAL.</b>	<b>CAL DUE.</b>
Spectrum Analyzer	Agilent	E4446A	MY51100003	05/19/2014	05/18/2015
Radio Communication Analyzer	Anritsu	MT8820C	6200995019	10/08/2014	10/09/2015
Temperature Chamber	TERCHY	MHG-120LF	911009	05/06/2015	05/05/2016
DC Block	Mini-Circuits	BLK-18-S+	1	01/02/2015	01/01/2016
Attenuator	Mini-Circuit	BW-S10W2+	002	01/02/2015	01/01/2016
Splitter	Agilent	11636B	N/A	01/02/2015	01/01/2016
DC Power Supply	Agilent	E3640A	MY52410006	11/10/2014	11/09/2015

**15.5. Measurement Result:**

**FREQUENCY ERROR vs. VOLTAGE**

Reference Frequency:		LTE B14 Mid Channel	793.0	MHz	10M QPSK CH 23330
Limit: +/- 2.5 ppm					
Power Supply	Environment	Frequency	Delta (Hz)	Limit (Hz)	
Vdc	Temperature ( )	(MHz)			
3.465	25	792.999997	-0.70	1983	
3.300	25	792.999997	0.00	1983	
3.135	25	792.999995	-2.60	1983	
2.93 (End Point)	25	792.999994	-2.90	1983	

**FREQUENCY ERROR vs. TEMPERATURE**

Reference Frequency:		LTE B14 Mid Channel	793.0	MHz	10M QPSK CH 23330
Limit: +/- 2.5 ppm					
Power Supply	Environment	Frequency	Delta (Hz)	Limit (Hz)	
Vdc	Temperature ( )	(MHz)			
3.3	-30	793.000004	7.30	1983	
3.3	-20	793.000006	8.50	1983	
3.3	-10	793.000004	6.40	1983	
3.3	0	793.000006	9.10	1983	
3.3	10	793.000003	5.60	1983	
3.3	20	792.999997	0.00	1983	
3.3	30	792.999997	-0.30	1983	
3.3	40	793.000005	7.70	1983	
3.3	50	793.000006	8.80	1983	

**Note: The battery is rated 3.3Vdc.**

## 16. PEAK TO AVERAGE RATIO

### 16.1. Standard Applicable

The peak-to-average ration (PAR) of the transmission may not exceed 13dB.

### 16.2. Test SET-UP

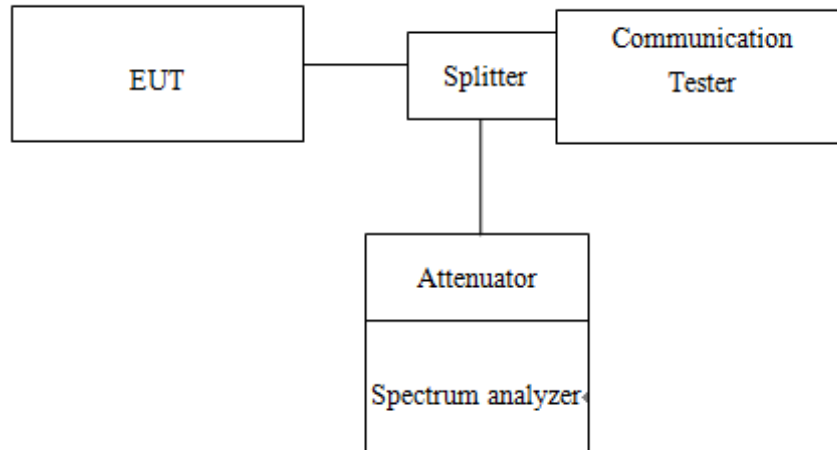

### 16.3. Measurement Procedure

1. KDB 971168 D01 is employed as the following procedure is proper adjusted accordingly:
2. Set resolution/measurement bandwidth  $\geq$  signal's occupied bandwidth; & internal =1ms
3. Set the number of counts to a value that stabilizes the measured CCDF curve.

### 16.4. Measurement Equipment Used

Conducted Emission Test Site					
EQUIPMENT TYPE	MFR	MODEL NUMBER	SERIAL NUMBER	LAST CAL.	CAL DUE.
Spectrum Analyzer	Agilent	E4446A	MY51100003	05/19/2014	05/18/2015
Radio Communication Analyzer	Anritsu	MT8820C	6200995019	10/08/2014	10/09/2015
Temperature Chamber	TERCHY	MHG-120LF	911009	05/06/2015	05/05/2016
DC Block	Mini-Circuits	BLK-18-S+	1	01/02/2015	01/01/2016
Attenuator	Mini-Circuit	BW-S10W2+	002	01/02/2015	01/01/2016
Splitter	Agilent	11636B	N/A	01/02/2015	01/01/2016
DC Power Supply	Agilent	E3640A	MY52410006	11/10/2014	11/09/2015



**16.5. Measurement Result**

**Tabular Results:**

<b>LTE BAND 14</b>							
<b>Channel bandwidth: 5MHz</b>				<b>Channel bandwidth: 10MHz</b>			
<b>Frequency (MHz)</b>	<b>CH</b>	<b>Peak-to-Average Ratio (dB)</b>		<b>Frequency (MHz)</b>	<b>CH</b>	<b>Peak-to-Average Ratio (dB)</b>	
		<b>16QAM</b>	<b>LIMIT</b>			<b>16QAM</b>	<b>LIMIT</b>
790.5	23305	5.44	13	793.0	23330	5.77	13
793.0	23330	5.57	13				
795.5	23355	5.63	13				

Measurement Results:

5MHz BW LTE-Band 14 16QAM Channel Low

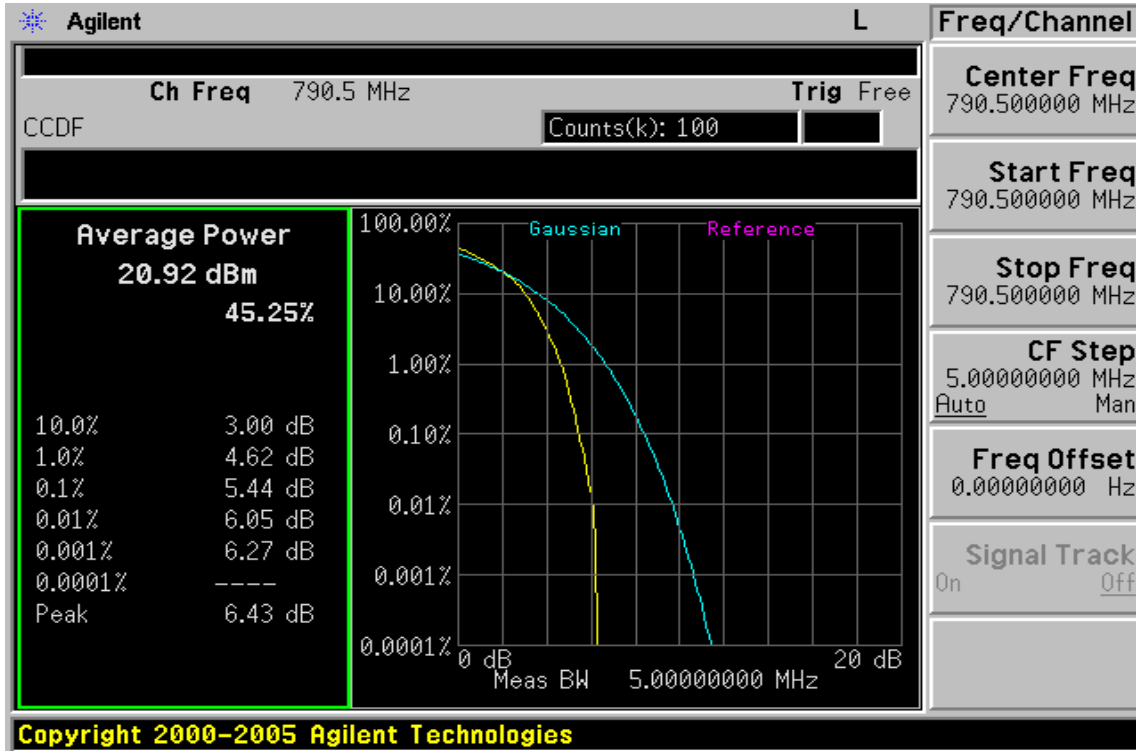

5MHz BW LTE-Band 14 16QAM Channel Mid

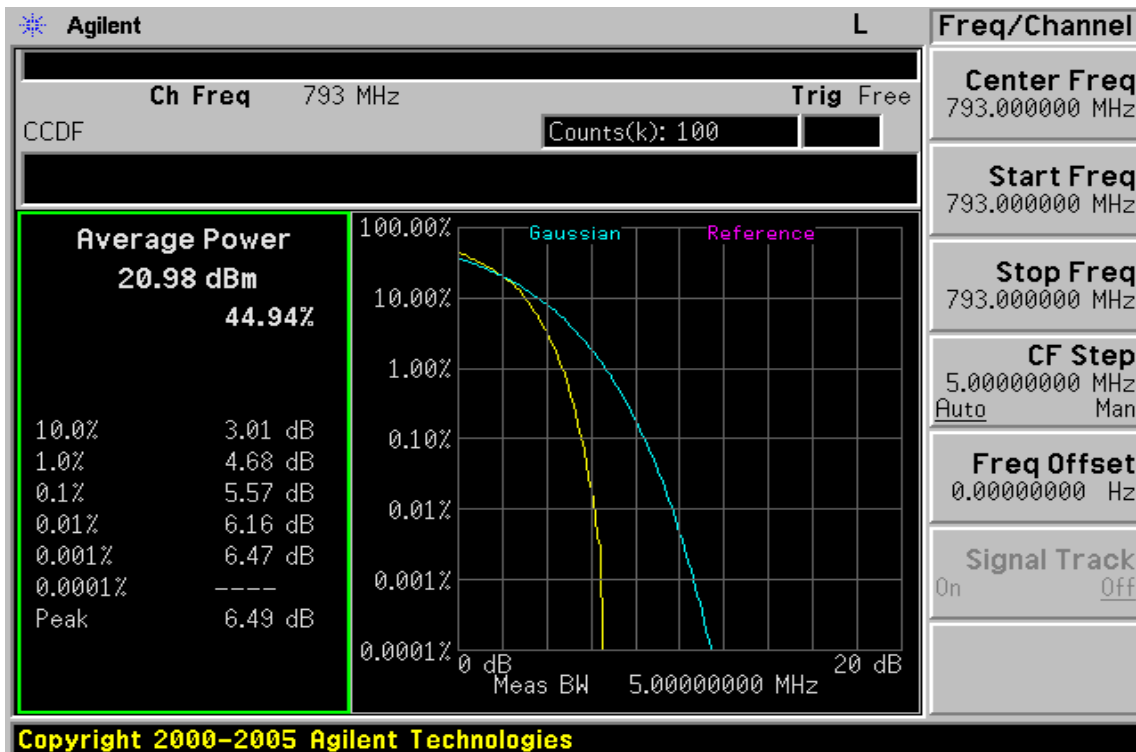

**5MHz BW LTE-Band 14 16QAM Channel High**

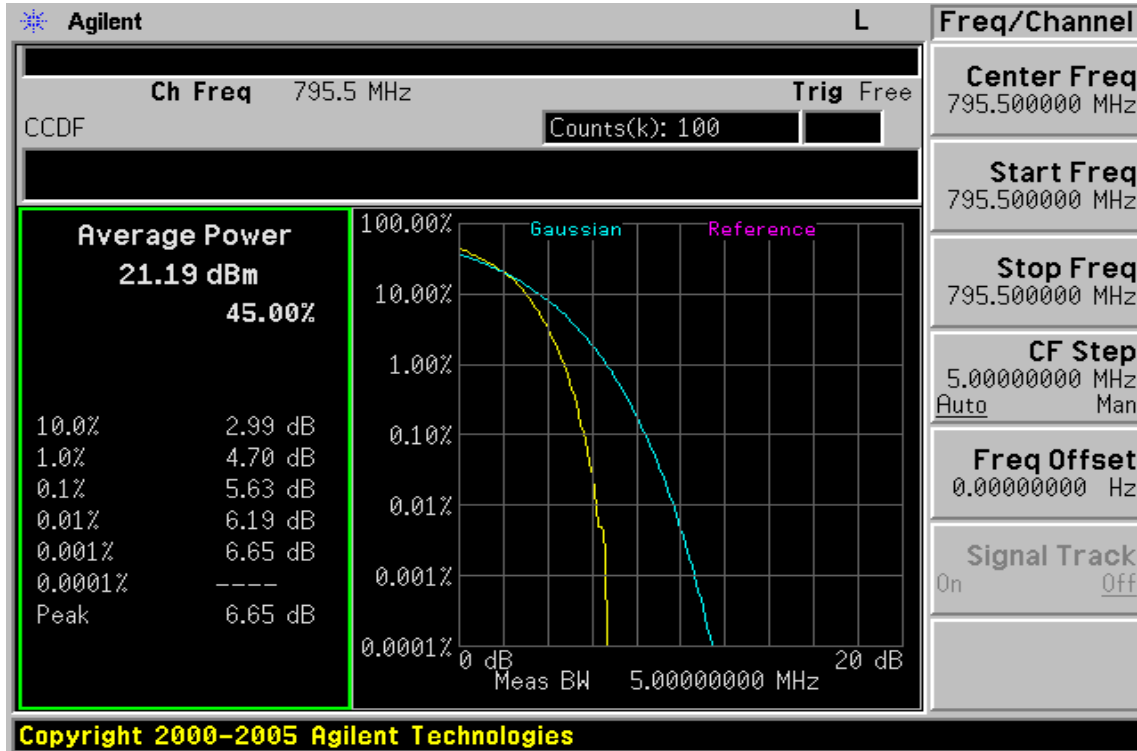

**10MHz BW LTE-Band 14 16QAM Channel Mid**

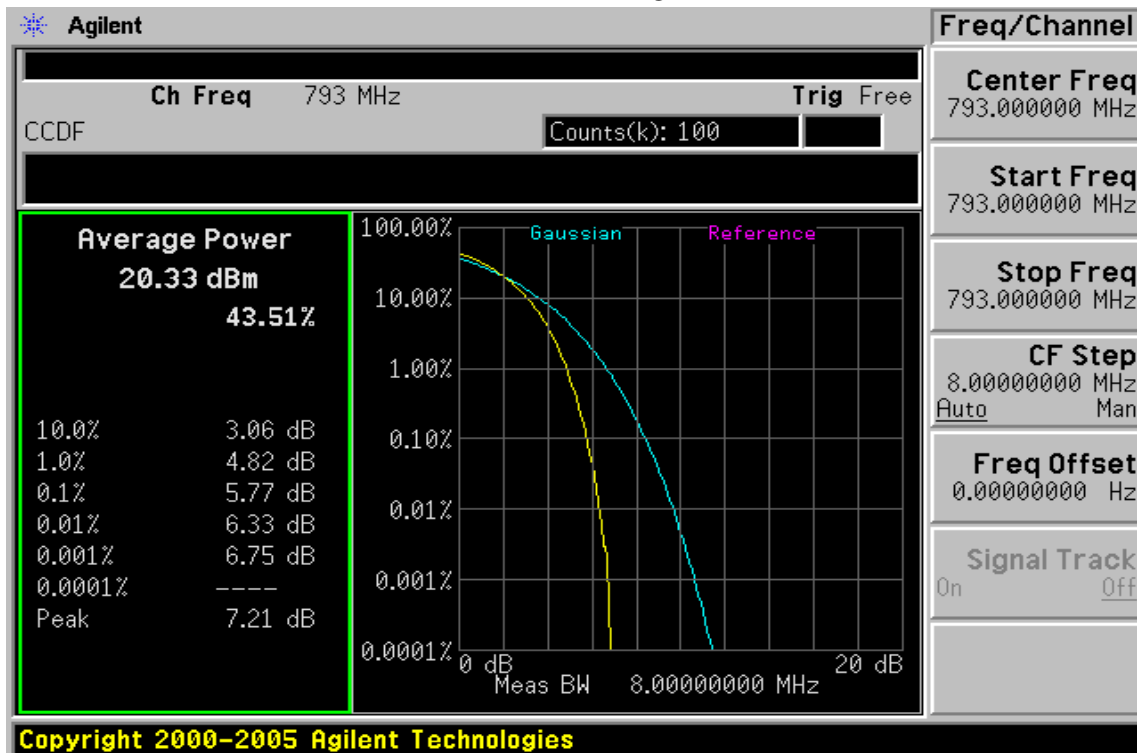

## PHOTOGRAPHS OF SET UP

### Radiated Emission Set up Photos (Below 1GHz)

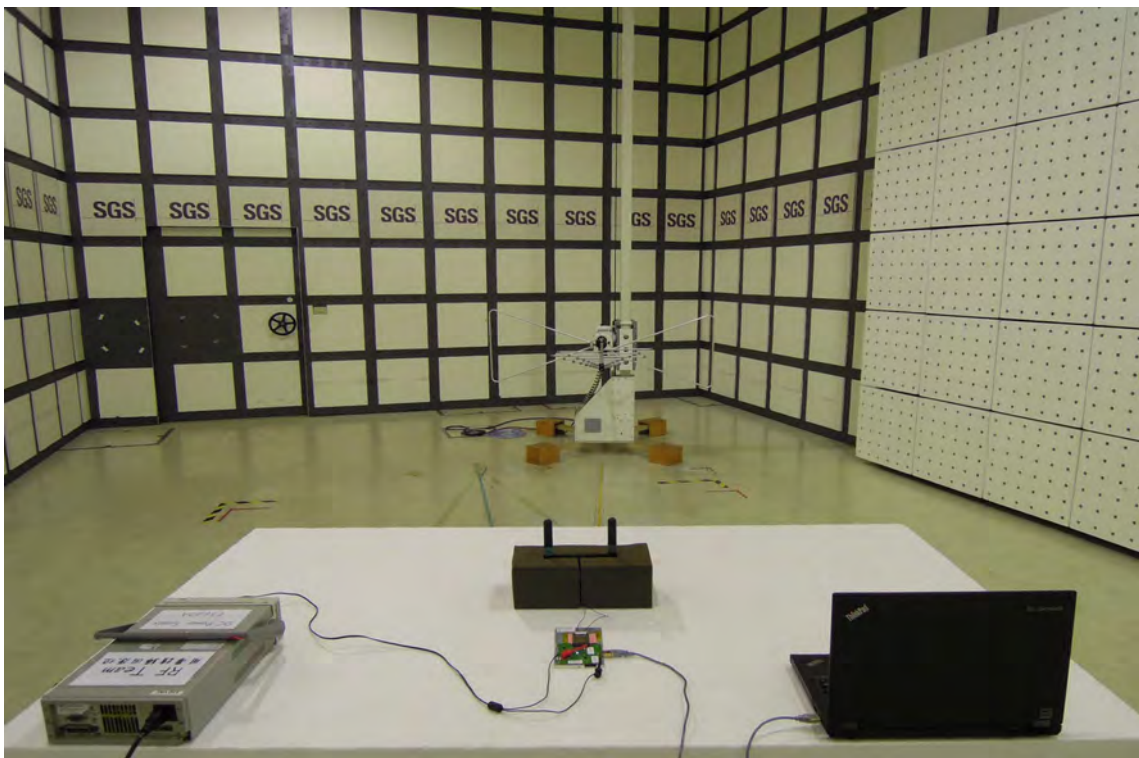
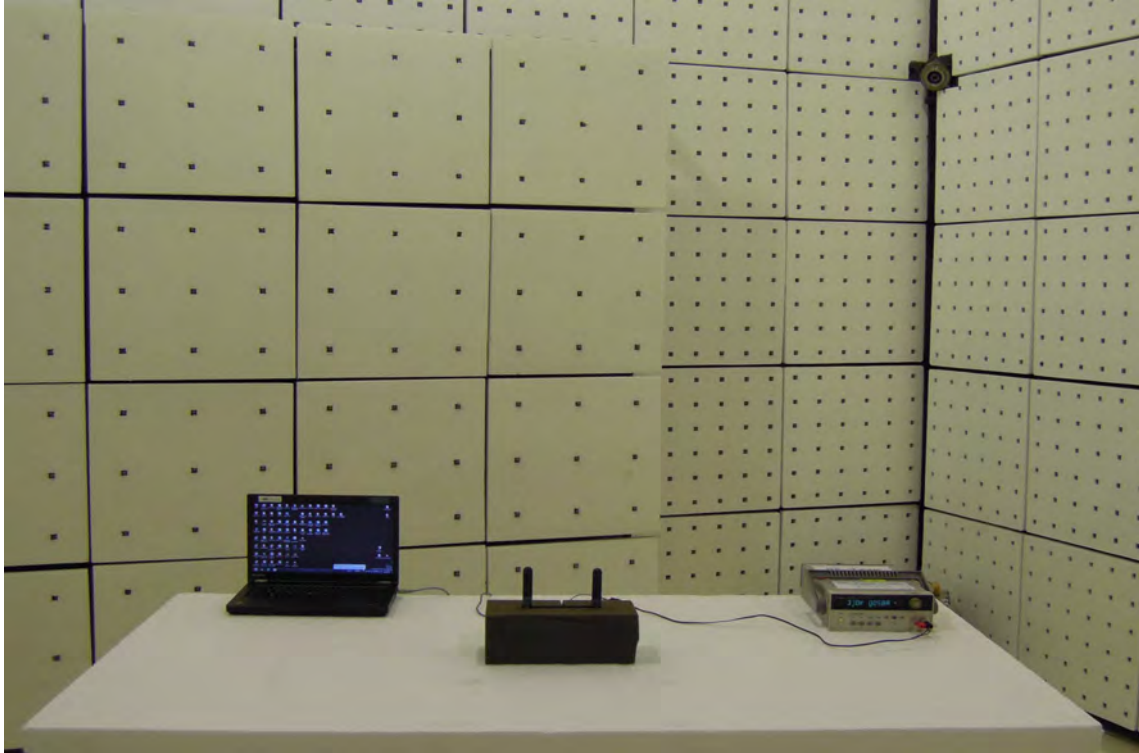

### Radiated Emission Set up Photos (Above 1GHz)

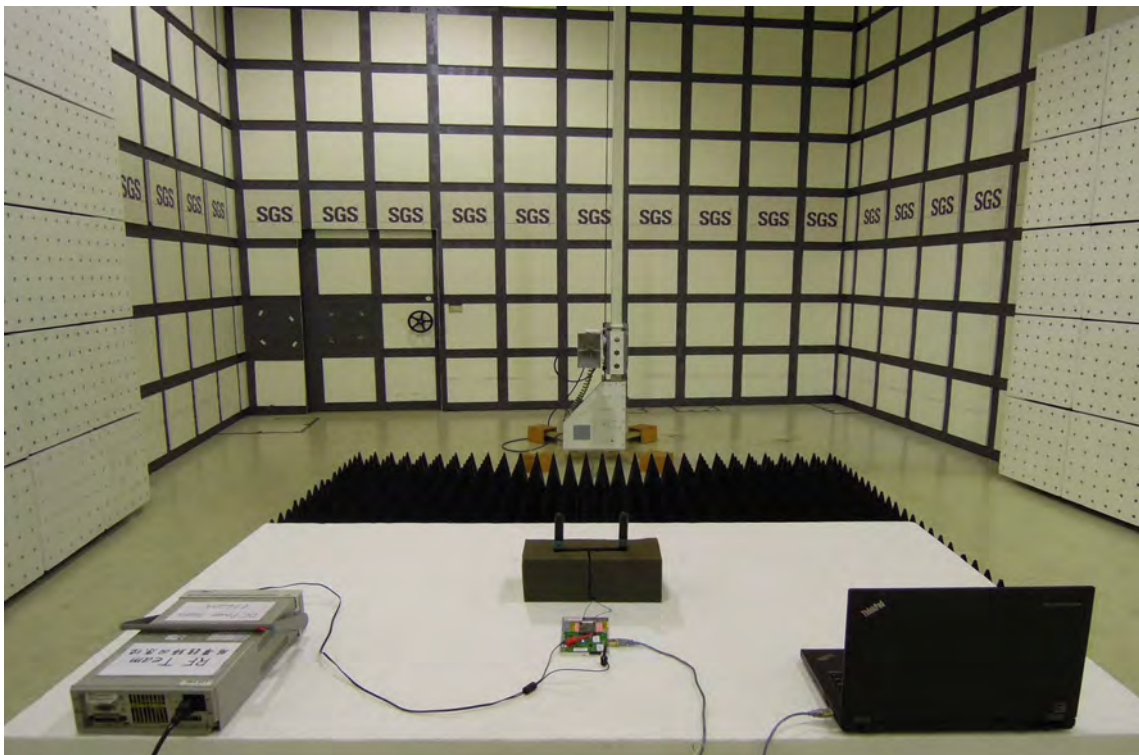

### Conducted Set up Photos

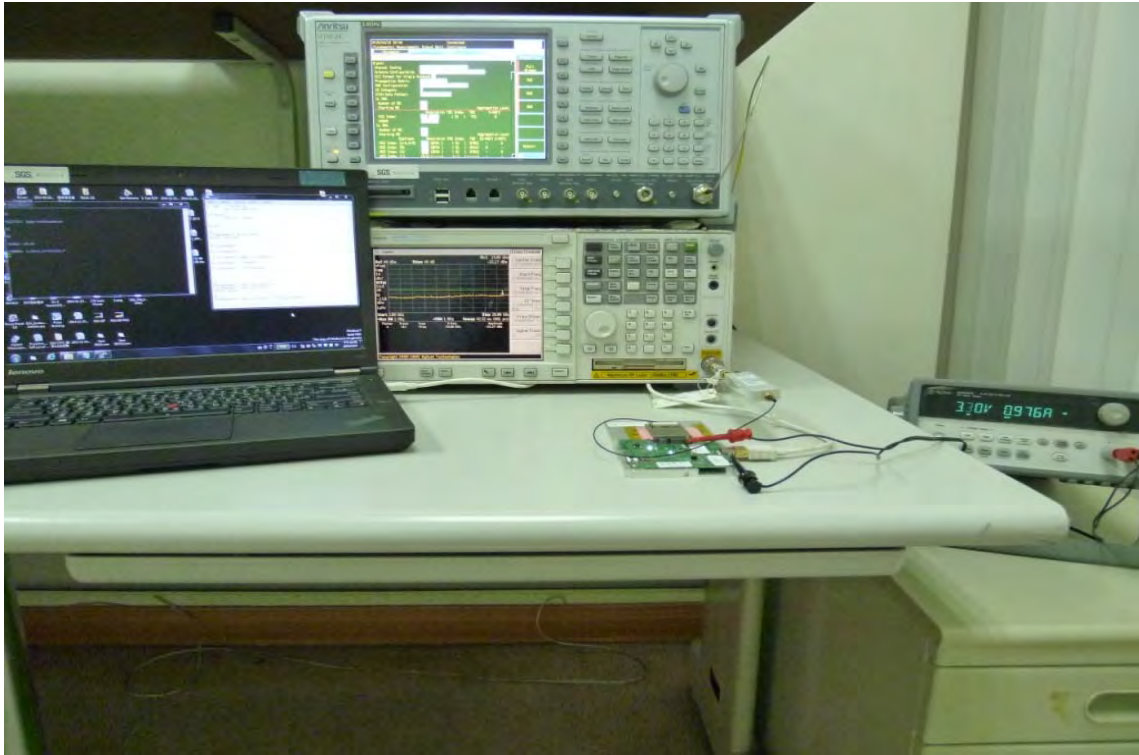

### PHOTOGRAPHS OF EUT

Please refer to the attached file (EUT Photo)

*~ End of Report ~*