

## FCC Test Report

### (PART 27)

**Report No.:** RF180521C04B-1 R1

**FCC ID:** 2AAGMGM01QA

**Test Model:** GM01Q

**Received Date:** Jan. 03, 2019

**Test Date:** Jan. 21, 2019 ~ Jun. 07, 2019

**Issued Date:** Jun. 14, 2019

**Applicant:** Sequans Communications

**Address:** 15-55 Boulevard Charles de Gaulle, 92700 Colombes France

**Issued By:** Bureau Veritas Consumer Products Services (H.K.) Ltd., Taoyuan Branch

**Lab Address:** No. 47-2, 14th Ling, Chia Pau Vil., Lin Kou Dist., New Taipei City, Taiwan  
( R.O.C )

**Test Location:** No. 19, Hwa Ya 2nd Rd, Wen Hwa Vil, Kwei Shan Dist., Taoyuan City  
33383, Taiwan (R.O.C)

**FCC Registration /  
Designation Number:** 788550 / TW0003



This report is for your exclusive use. Any copying or replication of this report to or for any other person or entity, or use of our name or trademark, is permitted only with our prior written permission. This report sets forth our findings solely with respect to the test samples identified herein. The results set forth in this report are not indicative or representative of the quality or characteristics of the lot from which a test sample was taken or any similar or identical product unless specifically and expressly noted. Our report includes all of the tests requested by you and the results thereof based upon the information that you provided to us. You have 60 days from date of issuance of this report to notify us of any material error or omission caused by our negligence, provided, however, that such notice shall be in writing and shall specifically address the issue you wish to raise. A failure to raise such issue within the prescribed time shall constitute your unqualified acceptance of the completeness of this report, the tests conducted and the correctness of the report contents. Unless specific mention, the uncertainty of measurement has been explicitly taken into account to declare the compliance or non-compliance to the specification. The report must not be used by the client to claim product certification, approval, or endorsement by TAF or any government agencies

## Table of Contents

<b>Release Control Record</b> .....	<b>4</b>
<b>1 Certificate of Conformity</b> .....	<b>5</b>
<b>2 Summary of Test Results</b> .....	<b>6</b>
2.1 Measurement Uncertainty .....	7
2.2 Test Site and Instruments .....	8
<b>3 General Information</b> .....	<b>9</b>
3.1 General Description of EUT .....	9
3.2 Configuration of System under Test .....	10
3.2.1 Description of Support Units .....	10
3.3 Test Mode Applicability and Tested Channel Detail .....	10
3.4 EUT Operating Conditions .....	14
3.5 General Description of Applied Standards .....	14
<b>4 Test Types and Results</b> .....	<b>15</b>
4.1 Output Power Measurement .....	15
4.1.1 Limits of Output Power Measurement .....	15
4.1.2 Test Procedures .....	15
4.1.3 Test Setup .....	16
4.1.4 Test Results .....	17
4.2 Modulation Characteristics Measurement .....	31
4.2.1 Limits of Modulation Characteristics .....	31
4.2.2 Test Setup .....	31
4.2.3 Test Procedure .....	31
4.2.4 Test Results .....	32
4.3 Frequency Stability Measurement .....	33
4.3.1 Limits of Frequency Stability Measurement .....	33
4.3.2 Test Procedure .....	33
4.3.3 Test Setup .....	33
4.3.4 Test Results .....	34
4.4 Occupied Bandwidth Measurement .....	42
4.4.1 Limits of Occupied Bandwidth Measurement .....	42
4.4.2 Test Procedure .....	42
4.4.3 Test Setup .....	42
4.4.4 Test Result .....	43
4.5 Band Edge Measurement .....	47
4.5.1 Limits of Band Edge Measurement .....	47
4.5.2 Test Setup .....	47
4.5.3 Test Procedures .....	47
4.5.4 Test Results .....	48
4.6 Peak to Average Ratio .....	58
4.6.1 Limits of Peak to Average Ratio Measurement .....	58
4.6.2 Test Setup .....	58
4.6.3 Test Procedures .....	58
4.6.4 Test Results .....	59
4.7 Conducted Spurious Emissions .....	63
4.7.1 Limits of Conducted Spurious Emissions Measurement .....	63
4.7.2 Test Setup .....	63
4.7.3 Test Procedure .....	63
4.7.4 Test Results .....	64
4.8 Radiated Emission Measurement .....	74
4.8.1 Limits of Radiated Emission Measurement .....	74
4.8.2 Test Procedure .....	74
4.8.3 Deviation from Test Standard .....	74
4.8.4 Test Setup .....	75

4.8.5 Test Results .....	76
<b>5 Pictures of Test Arrangements.....</b>	<b>108</b>
<b>Appendix – Information of the Testing Laboratories .....</b>	<b>109</b>

### Release Control Record

Issue No.	Description	Date Issued
RF180521C04B-1	Original Release	Apr. 16, 2019
RF180521C04B-1 R1	Re-test conducted test items	Jun. 14, 2019

## 1 Certificate of Conformity

**Product:** GM01Q EZlinkLTE modules

**Brand:** SEQUANS COMMUNICATIONS

**Test Model:** GM01Q

**Sample Status:** Mass Production

**Applicant:** Sequans Communications

**Test Date:** Jan. 21, 2019 ~ Jun. 07, 2019

**Standards:** FCC Part 27, Subpart C, H, F, L

The above equipment has been tested by **Bureau Veritas Consumer Products Services (H.K.) Ltd., Taoyuan Branch**, and found compliance with the requirement of the above standards. The test record, data evaluation & Equipment Under Test (EUT) configurations represented herein are true and accurate accounts of the measurements of the sample's RF characteristics under the conditions specified in this report.

**Prepared by :** , **Date:** Jun. 14, 2019  
Ivonne Wu / Supervisor

**Approved by :** , **Date:** Jun. 14, 2019  
Dylan Chiou / Project Engineer

## 2 Summary of Test Results

Applied Standard: FCC Part 27 & Part 2 (LTE 4)			
FCC Clause	Test Item	Result	Remarks
2.1046 27.50(d)(4)	Maximum Peak Output Power	Pass	Meet the requirement of limit.
2.1047	Modulation Characteristics	Pass	Meet the requirement.
2.1055 27.54	Frequency Stability	Pass	Meet the requirement of limit.
2.1049	Occupied Bandwidth	Pass	Meet the requirement of limit.
27.50(d)(5)	Peak to Average Ratio	Pass	Meet the requirement of limit.
27.53(h)	Band Edge Measurements	Pass	Meet the requirement of limit.
2.1051 27.53(h)	Conducted Spurious Emissions	Pass	Meet the requirement of limit.
2.1053 27.53(h)	Radiated Spurious Emissions	Pass	Meet the requirement of limit. Minimum passing margin is -17.25 dB at 8725.00 MHz.

Applied Standard: FCC Part 27 & Part 2 (LTE 12)			
FCC Clause	Test Item	Result	Remarks
2.1046 27.50(c)(10)	Maximum Peak Output Power	Pass	Meet the requirement of limit.
2.1047	Modulation Characteristics	Pass	Meet the requirement.
2.1055 27.54	Frequency Stability	Pass	Meet the requirement of limit.
2.1049	Occupied Bandwidth	Pass	Meet the requirement of limit.
---	Peak to Average Ratio	Pass	Meet the requirement of limit.
27.53(g)	Band Edge Measurements	Pass	Meet the requirement of limit.
2.1051 27.53(g)	Conducted Spurious Emissions	Pass	Meet the requirement of limit.
2.1053 27.53(g)	Radiated Spurious Emissions	Pass	Meet the requirement of limit. Minimum passing margin is -10.56 dB at 2133.00 MHz.

Applied Standard: FCC Part 27 & Part 2 (LTE 13)			
FCC Clause	Test Item	Result	Remarks
2.1046 27.50(b)(10)	Maximum Peak Output Power	Pass	Meet the requirement of limit.
2.1047	Modulation Characteristics	Pass	Meet the requirement.
2.1055 27.54	Frequency Stability	Pass	Meet the requirement of limit.
2.1049	Occupied Bandwidth	Pass	Meet the requirement of limit.
---	Peak to Average Ratio	Pass	Meet the requirement of limit.
27.53(c)(2)(4)	Band Edge Measurements	Pass	Meet the requirement of limit.
2.1051 27.53(c)(2)&(f)	Conducted Spurious Emissions	Pass	Meet the requirement of limit.
2.1053 27.53(c)(2)&(f)	Radiated Spurious Emissions	Pass	Meet the requirement of limit. Minimum passing margin is -6.28 dB at 1569.00 MHz.

Note: Determining compliance based on the results of the compliance measurement, not taking into account measurement instrumentation uncertainty.

## 2.1 Measurement Uncertainty

Where relevant, the following measurement uncertainty levels have been estimated for tests performed on the EUT as specified in CISPR 16-4-2:

Measurement	Frequency	Expanded Uncertainty (k=2) (±)
Radiated Emissions up to 1 GHz	9 kHz ~ 30 MHz	3.04 dB
	30 MHz ~ 200 MHz	2.93 dB
	200 MHz ~ 1000 MHz	2.95 dB
Radiated Emissions above 1 GHz	1 GHz ~ 18 GHz	2.26 dB
	18 GHz ~ 40 GHz	1.94 dB

## 2.2 Test Site and Instruments

Description & Manufacturer	Model No.	Serial No.	Date of Calibration	Due Date of Calibration
Test Receiver Agilent	N9038A	MY51210203	Mar. 18, 2019	Mar. 17, 2020
Spectrum Analyzer Agilent	N9010A	MY56070348	Sep. 06, 2018	Sep. 05, 2019
Spectrum Analyzer ROHDE & SCHWARZ	FSU43	100115	Jan. 21, 2019	Jan. 20, 2020
Spectrum Analyzer ROHDE & SCHWARZ	FSW26	102023	Oct. 11, 2018	Oct. 10, 2019
HORN Antenna SCHWARZBECK	3115	5619	Nov. 25, 2018	Nov. 24, 2019
HORN Antenna SCHWARZBECK	BBHA 9120 D	9120D-969	Nov. 25, 2018	Nov. 24, 2019
BILOG Antenna SCHWARZBECK	VULB9168	9168-472	Nov. 23, 2018	Nov. 22, 2019
Fixed Attenuator Mini-Circuits	MDCS18N-10	MDCS18N-10-01	Apr. 16, 2018	Apr. 15, 2019
			Apr. 15, 2019	Apr. 14, 2020
MXG Vector signal generator Agilent	N5182B	MY53052658	May 24, 2018	May 23, 2019
			May 20, 2019	May 19, 2020
Preamplifier EMCI	EMC 012645	980115	Oct. 12, 2018	Oct. 11, 2019
Preamplifier EMCI	EMC 330H	980112	Oct. 12, 2018	Oct. 11, 2019
RF Coaxial Cable HUBER+SUHNNER	EMC104-SM-SM-800 0&3000	140811+170717	Oct. 12, 2018	Oct. 11, 2019
RF Coaxial Cable HUBER+SUHNNER	SUCOFLEX 104	EMC104-SM-SM- 1000(140807)	Oct. 12, 2018	Oct. 11, 2019
RF Coaxial Cable WOKEN	8D-FB	Cable-Ch10-01	Oct. 12, 2018	Oct. 11, 2019
Boresight Antenna Fixture	FBA-01	FBA-SIP01	NA	NA
Software BV ADT	E3 6.120103	NA	NA	NA
Antenna Tower MF	MFA-440H	NA	NA	NA
Turn Table MF	MFT-201SS	NA	NA	NA
Antenna Tower & Turn Table Controller MF	MF-7802	NA	NA	NA
LTE Wireless Communication Test Set Keysight	E7515A	MY57270629	Feb. 22, 2019	Feb. 21, 2020
Temperature & Humidity Chamber	GTH-120-40-CP-AR	MAA1306-019	Sep. 05, 2018	Sep. 04, 2019
DC Power Supply Topward	33010D	807748	NA	NA

Note: 1. The calibration interval of the above test instruments is 12 / 24 months and the calibrations are traceable to NML/ROC and NIST/USA.

2. The test was performed in HwaYa Chamber 10.



### 3 General Information

#### 3.1 General Description of EUT

<b>Product</b>	GM01Q EZlinkLTE modules	
<b>Brand</b>	SEQUANS COMMUNICATIONS	
<b>Test Model</b>	GM01Q	
<b>Status of EUT</b>	Mass Production	
<b>Power Supply Rating</b>	5.0 Vdc (adapter) or 3.8 Vdc (form DC power supply)	
<b>Modulation Type</b>	LTE	QPSK, 16QAM
<b>Frequency Range</b>	LTE Band 4 (Channel Bandwidth: 5 MHz)	1712.5 ~ 1752.5 MHz
	LTE Band 4 (Channel Bandwidth: 10 MHz)	1715.0 ~ 1750.0 MHz
	LTE Band 4 (Channel Bandwidth: 15 MHz)	1717.5 ~ 1747.5 MHz
	LTE Band 4 (Channel Bandwidth: 20 MHz)	1720.0 ~ 1745.0 MHz
	LTE Band 12 (Channel Bandwidth: 5 MHz)	701.5 ~ 713.5 MHz
	LTE Band 12 (Channel Bandwidth: 10 MHz)	704.0 ~ 711.0 MHz
	LTE Band 13 (Channel Bandwidth: 5 MHz)	779.5 ~ 784.5 MHz
	LTE Band 13 (Channel Bandwidth: 10 MHz)	782.0 MHz
<b>Emission Designator</b>	LTE Band 4 (Channel Bandwidth: 5 MHz)	1M10G7D
	LTE Band 4 (Channel Bandwidth: 10 MHz)	1M09G7D
	LTE Band 4 (Channel Bandwidth: 15 MHz)	1M10G7D
	LTE Band 4 (Channel Bandwidth: 20 MHz)	1M10G7D
	LTE Band 12 (Channel Bandwidth: 5 MHz)	1M09G7D
	LTE Band 12 (Channel Bandwidth: 10 MHz)	1M09G7D
	LTE Band 13 (Channel Bandwidth: 5 MHz)	1M09G7D
	LTE Band 13 (Channel Bandwidth: 10 MHz)	1M09G7D
<b>Max. ERP Power</b>	LTE Band 12 (Channel Bandwidth: 5 MHz)	121.06 mW
	LTE Band 12 (Channel Bandwidth: 10 MHz)	128.53 mW
	LTE Band 13 (Channel Bandwidth: 5 MHz)	98.17 mW
	LTE Band 13 (Channel Bandwidth: 10 MHz)	104.71 mW
<b>Max. EIRP Power</b>	LTE Band 4 (Channel Bandwidth: 5 MHz)	220.29 mW
	LTE Band 4 (Channel Bandwidth: 10 MHz)	234.42 mW
	LTE Band 4 (Channel Bandwidth: 15 MHz)	250.03 mW
	LTE Band 4 (Channel Bandwidth: 20 MHz)	263.63 mW
<b>Antenna Type</b>	Broadband Omni-Directional	
<b>Antenna Gain</b>	LTE Band 4	2 dBi gain
	LTE Band 12	-2 dBi gain
	LTE Band 13	-2.4 dBi gain
<b>Accessory Device</b>	Refer to Note as below	
<b>Data Cable Supplied</b>	Refer to Note as below	

Note:

1. The above EUT information is declared by manufacturer and for more detailed features description, please refers to the manufacturer's specifications or user's manual.

### 3.2 Configuration of System under Test

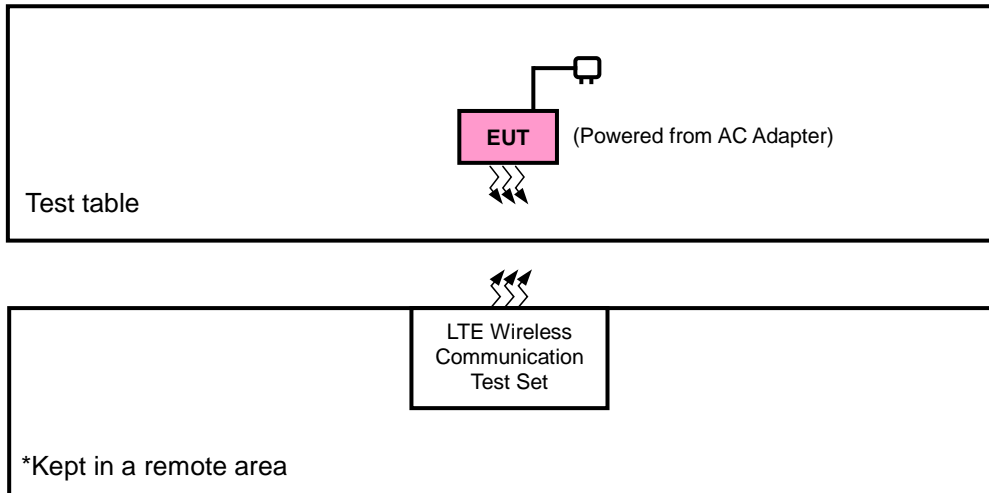

#### 3.2.1 Description of Support Units

The EUT has been tested as an independent unit together with other necessary accessories or support units.

### 3.3 Test Mode Applicability and Tested Channel Detail

Pre-Scan has been conducted to determine the worst-case mode from all possible combinations between available modulations, data rates, XYZ axis, and antenna ports

The worst case was found when positioned as the table below. Following channel(s) was (were) selected for the final test as listed below:

Band	ERP / EIRP	Radiated Emission
LTE Band 4	X-plane	X-axis
LTE Band 12	X-plane	Z-axis
LTE Band 13	X-plane	X-axis

### LTE Band 4

EUT Configure Mode	Test Item	Available Channel	Tested Channel	Channel Bandwidth	Modulation	Mode		
-	EIRP	19975 to 20375	19975, 20175, 20375	5 MHz	QPSK, 16QAM	5 RB / 0 RB Offset		
		20000 to 20350	20000, 20175, 20350	10 MHz	QPSK, 16QAM	1 RB / 5 RB Offset		
		20025 to 20325	20025, 20175, 20325	15 MHz	QPSK, 16QAM	1 RB / 0 RB Offset		
		20050 to 20300	20050, 20175, 20300	20 MHz	QPSK, 16QAM	1 RB / 0 RB Offset		
-	Modulation Characteristics	20000 to 20350	20175	10 MHz	QPSK, 16QAM	1 RB / 0 RB Offset		
-	Frequency Stability	19975 to 20375	19975, 20375	5 MHz	QPSK	6 RB / 0 RB Offset		
		20000 to 20350	20000, 20350	10 MHz	QPSK	6 RB / 0 RB Offset		
		20025 to 20325	20025, 20325	15 MHz	QPSK	6 RB / 0 RB Offset		
		20050 to 20300	20050, 20300	20 MHz	QPSK	6 RB / 0 RB Offset		
-	Occupied Bandwidth	19975 to 20375	19975, 20175, 20375	5 MHz	QPSK, 16QAM	6 RB / 0 RB Offset		
		20000 to 20350	20000, 20175, 20350	10 MHz	QPSK, 16QAM	6 RB / 0 RB Offset		
		20025 to 20325	20025, 20175, 20325	15 MHz	QPSK, 16QAM	6 RB / 0 RB Offset		
		20050 to 20300	20050, 20175, 20300	20 MHz	QPSK, 16QAM	6 RB / 0 RB Offset		
-	Peak to Average Ratio	19975 to 20375	19975, 20175, 20375	5 MHz	QPSK, 16QAM	5 RB / 0 RB Offset		
		20000 to 20350	20000, 20175, 20350	10 MHz	QPSK, 16QAM	1 RB / 5 RB Offset		
		20025 to 20325	20025, 20175, 20325	15 MHz	QPSK, 16QAM	1 RB / 0 RB Offset		
		20050 to 20300	20050, 20175, 20300	20 MHz	QPSK, 16QAM	1 RB / 0 RB Offset		
-	Band Edge	19975 to 20375	19975	5 MHz	QPSK	1 RB / 0 RB Offset		
			20375	5 MHz	QPSK	6 RB / 0 RB Offset		
		20000 to 20350	20000	10 MHz	QPSK	1 RB / 5 RB Offset		
			20350	10 MHz	QPSK	6 RB / 0 RB Offset		
		20025 to 20325	20025	15 MHz	QPSK	1 RB / 0 RB Offset		
			20325	15 MHz	QPSK	6 RB / 0 RB Offset		
		20050 to 20300	20050	20 MHz	QPSK	1 RB / 5 RB Offset		
			20300	20 MHz	QPSK	6 RB / 0 RB Offset		
		-	Conducted Emission	19975 to 20375	19975, 20175, 20375	5 MHz	QPSK	5 RB / 0 RB Offset
				20000 to 20350	20000, 20175, 20350	10 MHz	QPSK	1 RB / 5 RB Offset
				20025 to 20325	20025, 20175, 20325	15 MHz	QPSK	1 RB / 0 RB Offset
				20050 to 20300	20050, 20175, 20300	20 MHz	QPSK	1 RB / 0 RB Offset
-	Radiated Emission	19975 to 20375	19975, 20175, 20375	5 MHz	QPSK	5 RB / 0 RB Offset		
		20050 to 20300	20050, 20175, 20300	20 MHz	QPSK	1 RB / 0 RB Offset		

**Note:**

1. This device was tested under all bandwidths, RB configurations and modulations. The worst case was found in QPSK modulation.
2. For radiated emission above 1 GHz, according to 3GPP 36.521 Section 6.6.3.1.4, choose the lowest, 5 MHz & highest channel bandwidth for final test.

## LTE Band 12

EUT Configure Mode	Test Item	Available Channel	Tested Channel	Channel Bandwidth	Modulation	Mode
-	ERP	23035 to 23155	23035, 23095, 23155	5 MHz	QPSK, 16QAM	1 RB / 0 RB Offset
		23060 to 23130	23060, 23095, 23130	10 MHz	QPSK, 16QAM	1 RB / 5 RB Offset
-	Modulation Characteristics	23060 to 23130	23095	10 MHz	QPSK, 16QAM	1 RB / 0 RB Offset
-	Frequency Stability	23035 to 23155	23035, 23155	5 MHz	QPSK	6 RB / 0 RB Offset
		23060 to 23130	23060, 23130	10 MHz	QPSK	6 RB / 0 RB Offset
-	Occupied Bandwidth	23035 to 23155	23035, 23095, 23155	5 MHz	QPSK, 16QAM	6 RB / 0 RB Offset
		23060 to 23130	23060, 23095, 23130	10 MHz	QPSK, 16QAM	6 RB / 0 RB Offset
-	Peak to Average Ratio	23035 to 23155	23035, 23095, 23155	5 MHz	QPSK, 16QAM	1 RB / 0 RB Offset
		23060 to 23130	23060, 23095, 23130	10 MHz	QPSK, 16QAM	1 RB / 0 RB Offset
-	Band Edge	23035 to 23155	23035	5 MHz	QPSK	1 RB / 0 RB Offset
			23155	5 MHz	QPSK	6 RB / 0 RB Offset
		23060 to 23130	23060	10 MHz	QPSK	1 RB / 5 RB Offset
			23130	10 MHz	QPSK	6 RB / 0 RB Offset
						1 RB / 0 RB Offset
						6 RB / 0 RB Offset
-	Conducted Emission	23035 to 23155	23035, 23095, 23155	5 MHz	QPSK	1 RB / 0 RB Offset
		23060 to 23130	23060, 23095, 23130	10 MHz	QPSK	1 RB / 5 RB Offset
-	Radiated Emission	23035 to 23155	23035, 23095, 23155	5 MHz	QPSK	1 RB / 0 RB Offset
		23060 to 23130	23060, 23095, 23130	10 MHz	QPSK	1 RB / 5 RB Offset

### Note:

1. This device was tested under all bandwidths, RB configurations and modulations. The worst case was found in QPSK modulation.
2. For radiated emission above 1 GHz, according to 3GPP 36.521 Section 6.6.3.1.4, choose the lowest, 5 MHz & highest channel bandwidth for final test.

## LTE Band 13

EUT Configure Mode	Test Item	Available Channel	Tested Channel	Channel Bandwidth	Modulation	Mode		
-	ERP	23205 to 23255	23205, 23230, 23255	5 MHz	QPSK, 16QAM	1 RB / 5 RB Offset		
		23230	23230	10 MHz	QPSK, 16QAM	1 RB / 0 RB Offset		
-	Modulation Characteristics	23230	23230	10 MHz	QPSK, 16QAM	1 RB / 0 RB Offset		
-	Frequency Stability	23205 to 23255	23205, 23255	5 MHz	QPSK	6 RB / 0 RB Offset		
		23230	23230	10 MHz	QPSK	6 RB / 0 RB Offset		
-	Occupied Bandwidth	23205 to 23255	23205, 23230, 23255	5 MHz	QPSK, 16QAM	6 RB / 0 RB Offset		
		23230	23230	10 MHz	QPSK, 16QAM	6 RB / 0 RB Offset		
-	Peak to Average Ratio	23205 to 23255	23205, 23230, 23255	5 MHz	QPSK, 16QAM	1 RB / 5 RB Offset		
		23230	23230	10 MHz	QPSK, 16QAM	1 RB / 0 RB Offset		
-	Band Edge	23205 to 23255	23205	5 MHz	QPSK	1 RB / 0 RB Offset		
			23255	5 MHz	QPSK	6 RB / 0 RB Offset		
		23230	23230	10 MHz	QPSK	1 RB / 5 RB Offset		
			23230	10 MHz	QPSK	6 RB / 0 RB Offset		
		-	Conducted Emission	23205 to 23255	23205, 23230, 23255	5 MHz	QPSK	1 RB / 5 RB Offset
				23230	23230	10 MHz	QPSK	1 RB / 0 RB Offset
-	Radiated Emission	23205 to 23255	23205, 23230, 23255	5 MHz	QPSK	1 RB / 5 RB Offset		
		23230	23230	10 MHz	QPSK	1 RB / 0 RB Offset		

### Note:

1. This device was tested under all bandwidths, RB configurations and modulations. The worst case was found in QPSK modulation.
2. For radiated emission above 1 GHz, according to 3GPP 36.521 Section 6.6.3.1.4, choose the lowest, 5 MHz & highest channel bandwidth for final test.

### Test Condition:

Test Item	Environmental Conditions	Input Power	Tested By
ERP / EIRP	25 deg. C, 65 % RH	3.8 Vdc	Thomas Wei
Modulation Characteristics	25 deg. C, 65 % RH	3.8 Vdc	Getaz Yang
Frequency Stability	25 deg. C, 65 % RH	3.8 Vdc	Getaz Yang
Occupied Bandwidth	25 deg. C, 65 % RH	3.8 Vdc	Getaz Yang
Band Edge	25 deg. C, 65 % RH	3.8 Vdc	Getaz Yang
Peak to Average Ratio	25 deg. C, 65 % RH	3.8 Vdc	Getaz Yang
Conducted Emission	25 deg. C, 65 % RH	3.8 Vdc	Getaz Yang
Radiated Emission	25 deg. C, 65 % RH	120 Vac, 60 Hz	Thomas Wei

### 3.4 EUT Operating Conditions

The EUT makes a call to the communication simulator. The communication simulator station system controlled a EUT to export maximum output power under transmission mode and specific channel frequency

### 3.5 General Description of Applied Standards

The EUT is a RF Product. According to the specifications of the manufacturer, it must comply with the requirements of the following standards:

**FCC 47 CFR Part 2**

**FCC 47 CFR Part 27**

**KDB 971168 D01 Power Meas License Digital Systems v03r01**

**ANSI/TIA/EIA-603-E 2016**

**ANSI 63.26-2015**

**Note:** All test items have been performed and recorded as per the above standards.

## 4 Test Types and Results

### 4.1 Output Power Measurement

#### 4.1.1 Limits of Output Power Measurement

Fixed, mobile, and portable (hand-held) stations operating in the 1710–1755 MHz band and mobile and portable stations operating in the 1695-1710 MHz and 1755-1780 MHz bands are limited to 1 watt EIRP.

Portable stations (hand-held devices) operating in the 746-757 MHz, 776-788 MHz and 805-806 MHz band are limited to 3 watts ERP

Portable stations (hand-held device) operating in the 600 MHz uplink band and the 698-746 MHz band, and fixed and mobile stations in the 600 MHz uplink band are limited to 3 watts ERP.

#### 4.1.2 Test Procedures

##### **EIRP / ERP Measurement:**

- a. All measurements were done at low, middle and high operational frequency range. RBW and VBW is 10 MHz for LTE mode.
- b. Substitution method is used for E.I.R.P measurement. In the semi-anechoic chamber, EUT placed on the 0.8 m (below or equal 1 GHz) and/or 1.5 m (above 1 GHz) height of Turn Table, rotated the table around 360 degrees to search the maximum radiation power and receiver antenna shall be rotated vertical and horizontal polarization and moved height from 1 m to 4 m to find the maximum polar radiated power. The “Read Value” is the spectrum reading the maximum power value.
- c. The substitution horn antenna is substituted for EUT at the same position and signals generator export the CW signal to the substitution antenna via a tx cable. Rotated the Turn Table and moved receiving antenna to find the maximum radiation power. Adjust output power level of S.G to get a Value of spectrum reading equal to “Read Value” of step b. Record the power level of S.G.
- d.  $EIRP = \text{Output power level of S.G} - \text{TX cable loss} + \text{Antenna gain of substitution horn}$ . E.R.P power can be calculated form E.I.R.P power by subtracting the gain of dipole,  $E.R.P \text{ power} = E.I.R.P \text{ power} - 2.15 \text{ dB}$ .

##### **Conducted Power Measurement:**

- a. The EUT was set up for the maximum power with WCDMA and LTE link data modulation and link up with simulator.
- b. Set the EUT to transmit under low, middle and high channel and record the power level shown on simulator.

### 4.1.3 Test Setup

#### EIRP / ERP Measurement:

<Radiated Emission below or equal 1 GHz>

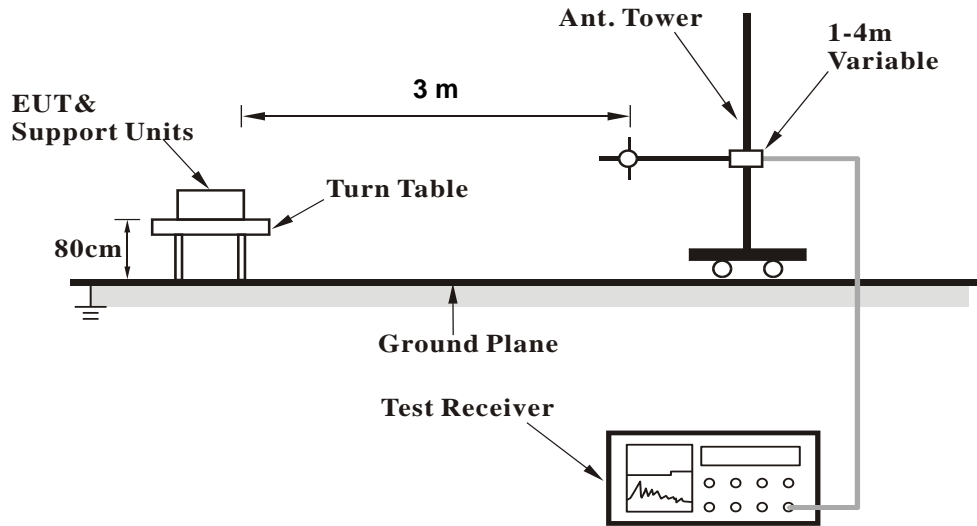

<Radiated Emission above 1 GHz>

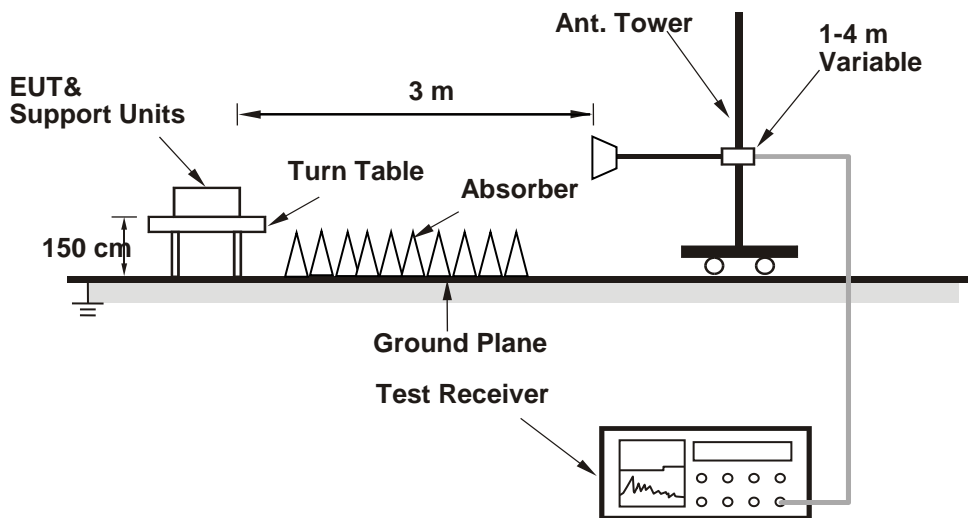

For the actual test configuration, please refer to the attached file (Test Setup Photo).

#### Conducted Power Measurement:

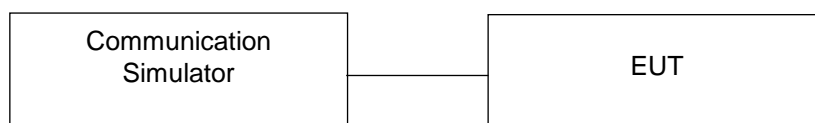



#### 4.1.4 Test Results

#### Conducted Output Power (dBm)

#### LTE Band 4

BW (MHz): 5										
Test Frequency ID	N <sub>UL</sub>	Frequency of Uplink [MHz]	N <sub>DL</sub>	Frequency of Downlink [MHz]	Test Configuration Initial of Power				EUT	
					Modulation	RB Size	RB Offset	Narrowband Index	Cell power (dBm/15kHz)	power (dBm)
Low Range	19975	1712.5	1975	2112.5	QPSK	1	0	0	-85	22.39
					QPSK	1	5	0	-85	22.27
					QPSK	1	0	1	-85	22.35
					QPSK	1	5	1	-85	22.29
					QPSK	1	0	3	-85	22.34
					QPSK	1	5	3	-85	22.32
					QPSK	3	0	0	-85	21.46
					QPSK	3	3	3	-85	21.65
					QPSK	6	0	0	-85	21.53
					QPSK	6	0	1	-85	21.58
					QPSK	6	0	3	-85	21.61
					16QAM	1	0	0	-85	22.36
					16QAM	1	5	0	-85	22.41
					16QAM	1	0	1	-85	22.72
					16QAM	1	5	1	-85	22.66
					16QAM	1	0	3	-85	22.78
					16QAM	1	5	3	-85	22.81
					Mid Range	20175	1732.5	2175	2132.5	QPSK
QPSK	1	5	0	-85						22.53
QPSK	1	0	1	-85						22.54
QPSK	1	5	1	-85						22.67
QPSK	1	0	3	-85						22.57
QPSK	1	5	3	-85						22.67
QPSK	3	0	0	-85						21.74
QPSK	3	3	3	-85						21.78
QPSK	6	0	0	-85						21.75
QPSK	6	0	1	-85						22.72
QPSK	6	0	3	-85						21.72
16QAM	1	0	0	-85						22.78
16QAM	1	5	0	-85						22.87
16QAM	1	0	1	-85						22.89
16QAM	1	5	1	-85						22.88
16QAM	1	0	3	-85						22.67
16QAM	1	5	3	-85						22.52
16QAM	3	0	0	-85						22.61
16QAM	3	3	3	-85	21.76					
16QAM	5	0	0	-85	22.97					
16QAM	5	0	1	-85	20.97					
16QAM	5	0	3	-85	21.71					

Test Frequency ID	N <sub>UL</sub>	Frequency of Uplink [MHz]	N <sub>DL</sub>	Frequency of Downlink [MHz]	Test Configuration Initial of Power				EUT	
					Modulation	RB Size	RB Offset	Narrowband Index	Cell power (dBm/15kHz)	power (dBm)
High Range	20375	1752.5	2375	2152.5	QPSK	1	0	0	-85	22.39
					QPSK	1	5	0	-85	22.38
					QPSK	1	0	1	-85	22.39
					QPSK	1	5	1	-85	22.34
					QPSK	1	0	3	-85	22.39
					QPSK	1	5	3	-85	22.37
					QPSK	3	0	0	-85	21.57
					QPSK	3	3	3	-85	21.61
					QPSK	6	0	0	-85	21.59
					QPSK	6	0	1	-85	21.58
					QPSK	6	0	3	-85	21.58
					16QAM	1	0	0	-85	22.74
					16QAM	1	5	0	-85	22.77
					16QAM	1	0	1	-85	22.74
					16QAM	1	5	1	-85	22.88
					16QAM	1	0	3	-85	22.94
					16QAM	1	5	3	-85	22.88
					16QAM	3	0	0	-85	21.87
					16QAM	3	3	3	-85	21.84
16QAM	5	0	0	-85	20.82					
16QAM	5	0	1	-85	20.89					
16QAM	5	0	3	-85	20.87					

BW (MHz): 10										
Test Frequency ID	N <sub>UL</sub>	Frequency of Uplink [MHz]	N <sub>DL</sub>	Frequency of Downlink [MHz]	Test Configuration Initial of Power				EUT	
					Modulation	RB Size	RB Offset	Narrowband Index	Cell power (dBm/15kHz)	power (dBm)
Low Range	20000	1715	2000	2115	QPSK	1	0	0	-85	22.34
					QPSK	1	5	0	-85	22.35
					QPSK	1	0	3	-85	22.41
					QPSK	1	5	3	-85	22.38
					QPSK	1	0	7	-85	22.47
					QPSK	1	5	7	-85	22.35
					QPSK	4	0	0	-85	22.25
					QPSK	4	2	7	-85	22.39
					QPSK	6	0	0	-85	21.37
					QPSK	6	0	7	-85	21.54
					16QAM	1	0	0	-85	22.86
					16QAM	1	5	0	-85	21.86
					16QAM	1	0	3	-85	21.97
					16QAM	1	5	3	-85	21.96
					16QAM	1	0	7	-85	22.11
					16QAM	1	5	7	-85	22.8
					16QAM	4	2	0	-85	21.21
					16QAM	4	2	7	-85	21.8
16QAM	5	0	0	-85	21.98					
16QAM	5	0	7	-85	21.49					
Mid Range	20175	1732.5	2175	2132.5	QPSK	1	0	0	-85	22.58
					QPSK	1	5	0	-85	22.44
					QPSK	1	0	3	-85	22.71
					QPSK	1	5	3	-85	22.71
					QPSK	1	0	7	-85	22.7
					QPSK	1	5	7	-85	22.68
					QPSK	4	0	0	-85	22.38
					QPSK	4	2	7	-85	22.72
					QPSK	6	0	0	-85	21.99
					QPSK	6	0	7	-85	21.81
					16QAM	1	0	0	-85	22.9
					16QAM	1	5	0	-85	22.87
					16QAM	1	0	3	-85	22.81
					16QAM	1	5	3	-85	22.56
					16QAM	1	0	7	-85	22.8
					16QAM	1	5	7	-85	22.73
					16QAM	4	2	0	-85	21.81
					16QAM	4	2	7	-85	21.81
16QAM	5	0	0	-85	22.01					
16QAM	5	0	7	-85	21.89					
High Range	20350	1750	2350	2150	QPSK	1	0	0	-85	22.43
					QPSK	1	5	0	-85	22.53
					QPSK	1	5	7	-85	22.42
					QPSK	1	0	3	-85	22.45
					QPSK	1	5	3	-85	22.42
					QPSK	1	0	7	-85	22.43
					QPSK	4	0	0	-85	22.55
					QPSK	4	2	7	-85	22.47
					QPSK	6	0	0	-85	21.67
					QPSK	6	0	7	-85	21.57
					16QAM	1	0	0	-85	22.62
					16QAM	1	5	0	-85	22.59
					16QAM	1	0	3	-85	22.55
					16QAM	1	5	3	-85	22.54
					16QAM	1	0	7	-85	22.53
					16QAM	1	5	7	-85	22.52
					16QAM	4	2	0	-85	21.69
					16QAM	4	2	7	-85	21.62
16QAM	5	0	0	-85	21.66					
16QAM	5	0	7	-85	21.61					

BW (MHz): 15										
Test Frequency ID	N <sub>UL</sub>	Frequency of Uplink [MHz]	N <sub>DL</sub>	Frequency of Downlink [MHz]	Test Configuration Initial of Power				EUT	
					Modulation	RB Size	RB Offset	Narrowband Index	Cell power (dBm/15kHz)	power (dBm)
Low Range	20025	1717.5	2025	2117.5	QPSK	1	0	0	-85	22.62
					QPSK	1	5	0	-85	22.61
					QPSK	1	0	5	-85	22.71
					QPSK	1	5	5	-85	22.69
					QPSK	1	0	11	-85	22.79
					QPSK	1	5	11	-85	22.81
					QPSK	3	0	0	-85	22.61
					QPSK	3	3	11	-85	22.8
					QPSK	6	0	0	-85	22.64
					QPSK	6	0	11	-85	22.81
					16QAM	1	0	0	-85	22.92
					16QAM	1	5	0	-85	22.91
					16QAM	1	0	5	-85	22.96
					16QAM	1	5	5	-85	22.98
					16QAM	1	0	11	-85	23.01
					16QAM	1	5	11	-85	22.84
					16QAM	3	0	0	-85	22.84
					16QAM	3	3	11	-85	22.98
16QAM	5	0	0	-85	22.65					
16QAM	5	0	11	-85	22.84					
Mid Range	20175	1732.5	2175	2132.5	QPSK	1	0	0	-85	22.81
					QPSK	1	5	0	-85	22.73
					QPSK	1	0	5	-85	22.79
					QPSK	1	5	5	-85	22.72
					QPSK	1	0	11	-85	22.62
					QPSK	1	5	11	-85	22.67
					QPSK	3	0	0	-85	22.79
					QPSK	3	3	11	-85	22.63
					QPSK	6	0	0	-85	22.8
					QPSK	6	0	11	-85	22.65
					16QAM	1	0	0	-85	23.06
					16QAM	1	5	0	-85	23.01
					16QAM	1	0	5	-85	22.97
					16QAM	1	5	5	-85	22.99
					16QAM	1	0	11	-85	22.72
					16QAM	1	5	11	-85	22.71
					16QAM	3	0	0	-85	22.94
					16QAM	3	3	11	-85	22.79
16QAM	5	0	0	-85	22.86					
16QAM	5	0	11	-85	22.64					
High Range	20325	1747.5	2325	2147.5	QPSK	1	0	0	-85	22.67
					QPSK	1	5	11	-85	22.56
					QPSK	1	0	5	-85	22.52
					QPSK	1	5	5	-85	22.45
					QPSK	1	0	11	-85	22.44
					QPSK	1	5	11	-85	22.56
					QPSK	3	0	0	-85	22.59
					QPSK	3	3	11	-85	22.43
					QPSK	6	0	0	-85	22.59
					QPSK	6	0	11	-85	22.43
					16QAM	1	0	0	-85	22.73
					16QAM	1	5	0	-85	22.63
					16QAM	1	0	5	-85	22.56
					16QAM	1	5	5	-85	22.63
					16QAM	1	0	11	-85	22.56
					16QAM	1	5	11	-85	22.42
					16QAM	3	0	0	-85	22.61
					16QAM	3	3	11	-85	22.58
16QAM	5	0	0	-85	22.67					
16QAM	5	0	11	-85	22.41					

BW (MHz): 20										
Test Frequency ID	N <sub>UL</sub>	Frequency of Uplink [MHz]	N <sub>DL</sub>	Frequency of Downlink [MHz]	Test Configuration Initial of Power				EUT	
					Modulation	RB Size	RB Offset	Narrowband Index	Cell power (dBm/15kHz)	power (dBm)
Low Range	20050	1720	2050	2120	QPSK	1	0	0	-85	22.62
					QPSK	1	5	0	-85	22.62
					QPSK	1	0	7	-85	22.81
					QPSK	1	5	7	-85	22.7
					QPSK	1	0	15	-85	22.8
					QPSK	1	5	15	-85	22.73
					QPSK	3	0	0	-85	22.63
					QPSK	3	3	15	-85	22.76
					QPSK	6	0	0	-85	22.65
					QPSK	6	0	15	-85	22.78
					16QAM	1	0	0	-85	22.72
					16QAM	1	5	0	-85	22.92
					16QAM	1	0	7	-85	23.03
					16QAM	1	5	7	-85	22.83
					16QAM	1	0	15	-85	22.83
					16QAM	1	5	15	-85	22.86
					16QAM	3	0	0	-85	22.79
					16QAM	3	3	15	-85	22.89
16QAM	5	0	0	-85	22.71					
16QAM	5	0	15	-85	22.81					
Mid Range	20175	1732.5	2175	2132.5	QPSK	1	0	0	-85	22.77
					QPSK	1	5	0	-85	22.77
					QPSK	1	0	7	-85	22.77
					QPSK	1	5	7	-85	22.72
					QPSK	1	0	15	-85	22.62
					QPSK	1	5	15	-85	22.6
					QPSK	3	0	0	-85	22.81
					QPSK	3	3	15	-85	22.64
					QPSK	6	0	0	-85	22.82
					QPSK	6	0	15	-85	22.66
					16QAM	1	0	0	-85	23.07
					16QAM	1	5	0	-85	22.91
					16QAM	1	0	7	-85	22.9
					16QAM	1	5	7	-85	22.99
					16QAM	1	0	15	-85	22.78
					16QAM	1	5	15	-85	22.85
					16QAM	3	0	0	-85	22.8
					16QAM	3	3	15	-85	22.73
16QAM	5	0	0	-85	22.74					
16QAM	5	0	15	-85	22.69					
High Range	20300	1745	2300	2145	QPSK	1	0	0	-85	22.65
					QPSK	1	5	0	-85	22.64
					QPSK	1	0	7	-85	22.55
					QPSK	1	5	7	-85	22.52
					QPSK	1	0	15	-85	22.43
					QPSK	1	5	15	-85	22.41
					QPSK	3	0	0	-85	22.67
					QPSK	3	3	15	-85	22.44
					QPSK	6	0	0	-85	22.73
					QPSK	6	0	15	-85	22.45
					16QAM	1	0	0	-85	22.85
					16QAM	1	5	0	-85	22.84
					16QAM	1	0	7	-85	22.72
					16QAM	1	5	7	-85	22.74
					16QAM	1	0	15	-85	22.62
					16QAM	1	5	15	-85	22.55
					16QAM	3	0	0	-85	22.94
					16QAM	3	3	15	-85	22.71
16QAM	5	0	0	-85	22.75					
16QAM	5	0	15	-85	22.48					

### LTE Band 12

BW (MHz): 5

Test Frequency ID	N <sub>UL</sub>	Frequency of Uplink [MHz]	N <sub>DL</sub>	Frequency of Downlink [MHz]	Test Configuration Initial of Power				EUT	
					Modulation	RB Size	RB Offset	Narrowband Index	Cell power (dBm/15kHz)	power (dBm)
Low Range	23035	701.5	5035	731.5	QPSK	1	0	0	-85	23.31
					QPSK	1	5	0	-85	23.34
					QPSK	1	0	1	-85	23.31
					QPSK	1	5	1	-85	23.32
					QPSK	1	0	3	-85	23.36
					QPSK	1	5	3	-85	23.33
					QPSK	3	0	0	-85	22.22
					QPSK	3	3	3	-85	22.31
					QPSK	6	0	0	-85	22.23
					QPSK	6	0	1	-85	22.29
					QPSK	6	0	3	-85	22.31
					16QAM	1	0	0	-85	23.76
					16QAM	1	5	0	-85	23.78
					16QAM	1	0	1	-85	23.71
					16QAM	1	5	1	-85	23.72
					16QAM	1	0	3	-85	23.74
					16QAM	1	5	3	-85	23.79
					16QAM	3	0	0	-85	22.64
16QAM	3	3	3	-85	22.66					
16QAM	5	0	0	-85	21.38					
16QAM	5	0	1	-85	21.46					
16QAM	5	0	3	-85	21.43					
Mid Range	23095	707.5	5095	737.5	QPSK	1	0	0	-85	23.39
					QPSK	1	5	0	-85	23.46
					QPSK	1	0	1	-85	23.4
					QPSK	1	5	1	-85	23.4
					QPSK	1	0	3	-85	23.46
					QPSK	1	5	3	-85	23.41
					QPSK	3	0	0	-85	22.37
					QPSK	3	3	3	-85	22.39
					QPSK	6	0	0	-85	22.44
					QPSK	6	0	1	-85	22.39
					QPSK	6	0	3	-85	22.38
					16QAM	1	0	0	-85	23.77
					16QAM	1	5	0	-85	23.85
					16QAM	1	0	1	-85	23.9
					16QAM	1	5	1	-85	23.74
					16QAM	1	0	3	-85	23.91
					16QAM	1	5	3	-85	23.86
					16QAM	3	0	0	-85	22.73
16QAM	3	3	3	-85	22.69					
16QAM	5	0	0	-85	21.49					
16QAM	5	0	1	-85	21.53					
16QAM	5	0	3	-85	21.56					

Test Frequency ID	N <sub>UL</sub>	Frequency of Uplink [MHz]	N <sub>DL</sub>	Frequency of Downlink [MHz]	Test Configuration Initial of Power				EUT	
					Modulation	RB Size	RB Offset	Narrowband Index	Cell power (dBm/15kHz)	power (dBm)
High Range	23155	713.5	5155	743.5	QPSK	1	0	0	-85	23.49
					QPSK	1	5	0	-85	23.48
					QPSK	1	0	1	-85	23.52
					QPSK	1	5	1	-85	23.52
					QPSK	1	0	3	-85	23.53
					QPSK	1	5	3	-85	23.52
					QPSK	3	0	0	-85	22.48
					QPSK	3	3	3	-85	22.53
					QPSK	6	0	0	-85	22.45
					QPSK	6	0	1	-85	22.49
					QPSK	6	0	3	-85	22.51
					16QAM	1	0	0	-85	23.75
					16QAM	1	5	0	-85	23.89
					16QAM	1	0	1	-85	23.72
					16QAM	1	5	1	-85	23.89
					16QAM	1	0	3	-85	23.88
					16QAM	1	5	3	-85	23.91
					16QAM	3	0	0	-85	22.83
					16QAM	3	3	3	-85	22.86
					16QAM	5	0	0	-85	21.69
16QAM	5	0	1	-85	21.65					
16QAM	5	0	3	-85	21.65					

BW (MHz): 10										
Test Frequency ID	N <sub>UL</sub>	Frequency of Uplink [MHz]	N <sub>DL</sub>	Frequency of Downlink [MHz]	Test Configuration Initial of Power				EUT	
					Modulation	RB Size	RB Offset	Narrowband Index	Cell power (dBm/15kHz)	power (dBm)
Low Range	23060	704	5060	734	QPSK	1	0	0	-85	23.31
					QPSK	1	5	0	-85	23.33
					QPSK	1	0	3	-85	23.41
					QPSK	1	5	3	-85	23.42
					QPSK	1	0	7	-85	23.45
					QPSK	1	5	7	-85	23.47
					QPSK	4	0	0	-85	23.32
					QPSK	4	2	7	-85	23.5
					QPSK	6	0	0	-85	22.32
					QPSK	6	0	7	-85	22.42
					16QAM	1	0	0	-85	23.8
					16QAM	1	5	0	-85	23.81
					16QAM	1	0	3	-85	23.85
					16QAM	1	5	3	-85	23.85
					16QAM	1	0	7	-85	23.84
					16QAM	1	5	7	-85	23.84
					16QAM	4	2	0	-85	22.45
					16QAM	4	2	7	-85	22.69
16QAM	5	0	0	-85	22.49					
16QAM	5	0	7	-85	22.59					
Mid Range	23095	707.5	5095	737.5	QPSK	1	0	0	-85	23.43
					QPSK	1	5	0	-85	23.44
					QPSK	1	0	3	-85	23.45
					QPSK	1	5	3	-85	23.45
					QPSK	1	0	7	-85	23.51
					QPSK	1	5	7	-85	23.45
					QPSK	4	0	0	-85	23.45
					QPSK	4	2	7	-85	23.48
					QPSK	6	0	0	-85	22.44
					QPSK	6	0	7	-85	22.46
					16QAM	1	0	0	-85	23.76
					16QAM	1	5	0	-85	23.95
					16QAM	1	0	3	-85	23.78
					16QAM	1	5	3	-85	23.97
					16QAM	1	0	7	-85	23.77
					16QAM	1	5	7	-85	23.85
					16QAM	4	2	0	-85	22.55
					16QAM	4	2	7	-85	22.53
16QAM	5	0	0	-85	22.61					
16QAM	5	0	7	-85	22.71					
High Range	23130	711	5130	741	QPSK	1	0	0	-85	23.48
					QPSK	1	5	0	-85	23.49
					QPSK	1	5	7	-85	23.52
					QPSK	1	0	3	-85	23.47
					QPSK	1	5	3	-85	23.53
					QPSK	1	0	7	-85	23.51
					QPSK	4	0	0	-85	23.56
					QPSK	4	2	7	-85	23.56
					QPSK	6	0	0	-85	22.51
					QPSK	6	0	7	-85	22.51
					16QAM	1	0	0	-85	23.82
					16QAM	1	5	0	-85	23.92
					16QAM	1	0	3	-85	23.83
					16QAM	1	5	3	-85	23.77
					16QAM	1	0	7	-85	23.81
					16QAM	1	5	7	-85	23.81
					16QAM	4	2	0	-85	22.66
					16QAM	4	2	7	-85	22.63
16QAM	5	0	0	-85	22.71					
16QAM	5	0	7	-85	22.72					



### LTE Band 13

BW (MHz): 5										
Test Frequency ID	N <sub>UL</sub>	Frequency of Uplink [MHz]	N <sub>DL</sub>	Frequency of Downlink [MHz]	Test Configuration Initial of Power				EUT	
					Modulation	RB Size	RB Offset	Narrowband Index	Cell power (dBm/15kHz)	power (dBm)
Low Range	23205	779.5	5205	748.5	QPSK	1	0	0	-85	23.38
					QPSK	1	5	0	-85	23.42
					QPSK	1	0	1	-85	23.38
					QPSK	1	5	1	-85	23.35
					QPSK	1	0	3	-85	23.31
					QPSK	1	5	3	-85	23.33
					QPSK	3	0	0	-85	22.49
					QPSK	3	3	3	-85	22.43
					QPSK	6	0	0	-85	22.51
					QPSK	6	0	1	-85	22.49
					QPSK	6	0	3	-85	22.49
					16QAM	1	0	0	-85	23.11
					16QAM	1	5	0	-85	23.21
					16QAM	1	0	1	-85	23.27
					16QAM	1	5	1	-85	23.24
					16QAM	1	0	3	-85	22.88
					16QAM	1	5	3	-85	22.96
					16QAM	3	0	0	-85	22.48
					16QAM	3	3	3	-85	22.51
					16QAM	5	0	0	-85	21.76
16QAM	5	0	1	-85	21.72					
16QAM	5	0	3	-85	21.67					
Mid Range	23230	782	5230	751	QPSK	1	0	0	-85	23.39
					QPSK	1	5	0	-85	23.34
					QPSK	1	0	1	-85	23.33
					QPSK	1	5	1	-85	23.35
					QPSK	1	0	3	-85	23.32
					QPSK	1	5	3	-85	23.29
					QPSK	3	0	0	-85	22.51
					QPSK	3	3	3	-85	22.48
					QPSK	6	0	0	-85	22.51
					QPSK	6	0	1	-85	22.48
					QPSK	6	0	3	-85	22.46
					16QAM	1	0	0	-85	23.12
					16QAM	1	5	0	-85	23.19
					16QAM	1	0	1	-85	23.16
					16QAM	1	5	1	-85	23.18
					16QAM	1	0	3	-85	23.12
					16QAM	1	5	3	-85	23.17
					16QAM	3	0	0	-85	22.51
					16QAM	3	3	3	-85	22.71
					16QAM	5	0	0	-85	21.64
16QAM	5	0	1	-85	21.55					
16QAM	5	0	3	-85	21.48					

Test Frequency ID	N <sub>UL</sub>	Frequency of Uplink [MHz]	N <sub>DL</sub>	Frequency of Downlink [MHz]	Test Configuration Initial of Power				EUT	
					Modulation	RB Size	RB Offset	Narrowband Index	Cell power (dBm/15kHz)	power (dBm)
High Range	23255	784.5	5255	753.5	QPSK	1	0	0	-85	23.36
					QPSK	1	5	0	-85	23.35
					QPSK	1	0	1	-85	23.39
					QPSK	1	5	1	-85	23.24
					QPSK	1	0	3	-85	23.24
					QPSK	1	5	3	-85	23.22
					QPSK	3	0	0	-85	22.46
					QPSK	3	3	3	-85	22.26
					QPSK	6	0	0	-85	22.53
					QPSK	6	0	1	-85	22.45
					QPSK	6	0	3	-85	22.38
					16QAM	1	0	0	-85	23.23
					16QAM	1	5	0	-85	23.13
					16QAM	1	0	1	-85	23.17
					16QAM	1	5	1	-85	23.08
					16QAM	1	0	3	-85	23.07
					16QAM	1	5	3	-85	23.06
					16QAM	3	0	0	-85	22.72
16QAM	3	3	3	-85	22.77					
16QAM	5	0	0	-85	21.49					
16QAM	5	0	1	-85	21.55					
16QAM	5	0	3	-85	21.67					

**BW (MHz): 10**

Test Frequency ID	N <sub>UL</sub>	Frequency of Uplink [MHz]	N <sub>DL</sub>	Frequency of Downlink [MHz]	Test Configuration Initial of Power				EUT	
					Modulation	RB Size	RB Offset	Narrowband Index	Cell power (dBm/15kHz)	power (dBm)
Mid Range	23230	782	5230	751	QPSK	1	0	0	-85	23.44
					QPSK	1	5	0	-85	23.29
					QPSK	1	0	3	-85	23.34
					QPSK	1	5	3	-85	23.31
					QPSK	1	0	7	-85	23.33
					QPSK	1	5	7	-85	23.27
					QPSK	4	0	0	-85	23.28
					QPSK	4	2	7	-85	23.25
					QPSK	6	0	0	-85	22.32
					QPSK	6	0	7	-85	22.23
					16QAM	1	0	0	-85	23.06
					16QAM	1	5	0	-85	23.01
					16QAM	1	0	3	-85	22.95
					16QAM	1	5	3	-85	22.98
					16QAM	1	0	7	-85	23.08
					16QAM	1	5	7	-85	22.95
					16QAM	4	2	0	-85	22.51
					16QAM	4	2	7	-85	22.56
16QAM	5	0	0	-85	22.72					
16QAM	5	0	7	-85	22.45					

**ERP Power (dBm)**

LTE Band 12							
Channel Bandwidth: 5 MHz / QPSK							
Plane	Channel	Frequency (MHz)	Reading (dBm)	Correction Factor (dB)	ERP (dBm)	ERP (mW)	Polarization (H/V)
X	23035	701.5	-7.33	30.17	20.69	117.22	H
	23095	707.5	-7.19	30.17	20.83	121.06	
	23155	713.5	-7.25	30.18	20.78	119.67	
	23035	701.5	-15.83	31.96	13.98	25.00	V
	23095	707.5	-15.76	31.98	14.07	25.53	
	23155	713.5	-15.87	32.03	14.01	25.18	
Channel Bandwidth: 5 MHz / 16QAM							
X	23035	701.5	-8.35	30.17	19.67	92.68	H
	23095	707.5	-8.23	30.17	19.79	95.28	
	23155	713.5	-8.29	30.18	19.74	94.19	
	23035	701.5	-16.73	31.96	13.08	20.32	V
	23095	707.5	-16.67	31.98	13.16	20.70	
	23155	713.5	-16.76	32.03	13.12	20.51	

Note: ERP (dBm) = Reading (dBm) + Correction Factor (dB) – 2.15

LTE Band 12							
Channel Bandwidth: 10 MHz / QPSK							
Plane	Channel	Frequency (MHz)	Reading (dBm)	Correction Factor (dB)	ERP (dBm)	ERP (mW)	Polarization (H/V)
X	23060	704.0	-7.10	30.17	20.92	123.59	H
	23095	707.5	-6.93	30.17	21.09	128.53	
	23130	711.0	-7.02	30.18	21.01	126.18	
	23060	704.0	-15.52	31.96	14.29	26.85	V
	23095	707.5	-15.42	31.98	14.41	27.61	
	23130	711.0	-15.55	32.03	14.33	27.10	
Channel Bandwidth: 10 MHz / 16QAM							
X	23060	704.0	-8.11	30.17	19.91	97.95	H
	23095	707.5	-7.92	30.17	20.10	102.33	
	23130	711.0	-8.04	30.18	19.99	99.77	
	23060	704.0	-16.48	31.96	13.33	21.53	V
	23095	707.5	-16.38	31.98	13.45	22.13	
	23130	711.0	-16.53	32.03	13.35	21.63	

Note: ERP (dBm) = Reading (dBm) + Correction Factor (dB) – 2.15

LTE Band 13							
Channel Bandwidth: 5 MHz / QPSK							
Plane	Channel	Frequency (MHz)	Reading (dBm)	Correction Factor (dB)	ERP (dBm)	ERP (mW)	Polarization (H/V)
X	23205	779.5	-10.33	32.24	19.76	94.62	H
	23230	782.0	-10.10	32.17	19.92	98.17	
	23255	784.5	-10.27	32.11	19.69	93.11	
	23205	779.5	-17.66	32.43	12.62	18.28	V
	23230	782.0	-17.45	32.42	12.82	19.14	
	23255	784.5	-17.72	32.46	12.59	18.16	
Channel Bandwidth: 5 MHz / 16QAM							
X	23205	779.5	-11.48	32.24	18.61	72.61	H
	23230	782.0	-11.30	32.17	18.72	74.47	
	23255	784.5	-11.38	32.11	18.58	72.11	
	23205	779.5	-18.84	32.43	11.44	13.93	V
	23230	782.0	-18.51	32.42	11.76	15.00	
	23255	784.5	-19.00	32.46	11.31	13.52	

Note: ERP (dBm) = Reading (dBm) + Correction Factor (dB) – 2.15

LTE Band 13							
Channel Bandwidth: 10 MHz / QPSK							
Plane	Channel	Frequency (MHz)	Reading (dBm)	Correction Factor (dB)	ERP (dBm)	ERP (mW)	Polarization (H/V)
X	23230	782.0	-9.82	32.17	20.20	104.71	H
	23230	782.0	-17.12	32.42	13.15	20.65	V
Channel Bandwidth: 10 MHz / 16QAM							
X	23230	782.0	-11.05	32.17	18.97	78.89	H
	23230	782.0	-18.26	32.42	12.01	15.89	V

Note: ERP (dBm) = Reading (dBm) + Correction Factor (dB) – 2.15

**EIRP Power (dBm)**

LTE Band 4							
Channel Bandwidth: 5 MHz / QPSK							
Plane	Channel	Frequency (MHz)	Reading (dBm)	Correction Factor (dB)	EIRP (dBm)	EIRP (mW)	Polarization (H/V)
X	19975	1712.5	-13.02	36.45	23.43	220.29	H
	20175	1732.5	-13.40	36.80	23.40	218.78	
	20375	1752.5	-13.76	36.94	23.18	207.97	
	19975	1712.5	-20.09	37.28	17.19	52.36	V
	20175	1732.5	-20.71	37.63	16.92	49.20	
	20375	1752.5	-21.02	37.64	16.62	45.92	
Channel Bandwidth: 5 MHz / 16QAM							
X	19975	1712.5	-14.18	36.45	22.27	168.66	H
	20175	1732.5	-14.57	36.80	22.23	167.11	
	20375	1752.5	-14.86	36.94	22.08	161.44	
	19975	1712.5	-21.15	37.28	16.13	41.02	V
	20175	1732.5	-21.75	37.63	15.88	38.73	
	20375	1752.5	-22.23	37.64	15.41	34.75	

Note: EIRP (dBm) = Reading (dBm) + Correction Factor (dB)

LTE Band 4							
Channel Bandwidth: 10 MHz / QPSK							
Plane	Channel	Frequency (MHz)	Reading (dBm)	Correction Factor (dB)	EIRP (dBm)	EIRP (mW)	Polarization (H/V)
X	20000	1715.0	-12.99	36.64	23.65	231.74	H
	20175	1732.5	-13.10	36.80	23.70	234.42	
	20350	1750.0	-13.32	36.80	23.48	222.84	
	20000	1715.0	-20.01	37.44	17.43	55.34	V
	20175	1732.5	-20.45	37.63	17.18	52.24	
	20350	1750.0	-20.76	37.64	16.88	48.75	
Channel Bandwidth: 10 MHz / 16QAM							
X	20000	1715.0	-14.14	36.64	22.50	177.83	H
	20175	1732.5	-14.33	36.80	22.47	176.60	
	20350	1750.0	-14.48	36.80	22.32	170.61	
	20000	1715.0	-21.03	37.44	16.41	43.75	V
	20175	1732.5	-21.50	37.63	16.13	41.02	
	20350	1750.0	-21.91	37.64	15.73	37.41	

Note: EIRP (dBm) = Reading (dBm) + Correction Factor (dB)

LTE Band 4							
Channel Bandwidth: 15 MHz / QPSK							
Plane	Channel	Frequency (MHz)	Reading (dBm)	Correction Factor (dB)	EIRP (dBm)	EIRP (mW)	Polarization (H/V)
X	20025	1717.5	-12.47	36.45	23.98	250.03	H
	20175	1732.5	-12.88	36.80	23.92	246.60	
	20325	1747.5	-13.12	36.94	23.82	240.99	
	20025	1717.5	-19.54	37.28	17.74	59.43	V
	20175	1732.5	-20.12	37.63	17.51	56.36	
	20325	1747.5	-20.56	37.64	17.08	51.05	
Channel Bandwidth: 15 MHz / 16QAM							
X	20025	1717.5	-13.70	36.45	22.75	188.36	H
	20175	1732.5	-14.12	36.80	22.68	185.35	
	20325	1747.5	-14.40	36.94	22.54	179.47	
	20025	1717.5	-20.56	37.28	16.72	46.99	V
	20175	1732.5	-21.25	37.63	16.38	43.45	
	20325	1747.5	-21.61	37.64	16.03	40.09	

Note: EIRP (dBm) = Reading (dBm) + Correction Factor (dB)

LTE Band 4							
Channel Bandwidth: 20 MHz / QPSK							
Plane	Channel	Frequency (MHz)	Reading (dBm)	Correction Factor (dB)	EIRP (dBm)	EIRP (mW)	Polarization (H/V)
X	20050	1720.0	-12.24	36.45	24.21	263.63	H
	20175	1732.5	-12.64	36.80	24.16	260.62	
	20300	1745.0	-12.84	36.94	24.10	257.04	
	20050	1720.0	-19.27	37.28	18.01	63.24	V
	20175	1732.5	-19.84	37.63	17.79	60.12	
	20300	1745.0	-20.26	37.64	17.38	54.70	
Channel Bandwidth: 20 MHz / 16QAM							
X	20050	1720.0	-13.39	36.45	23.06	202.30	H
	20175	1732.5	-13.78	36.80	23.02	200.45	
	20300	1745.0	-14.10	36.94	22.84	192.31	
	20050	1720.0	-20.26	37.28	17.02	50.35	V
	20175	1732.5	-20.97	37.63	16.66	46.34	
	20300	1745.0	-21.35	37.64	16.29	42.56	

Note: EIRP (dBm) = Reading (dBm) + Correction Factor (dB)

## 4.2 Modulation Characteristics Measurement

### 4.2.1 Limits of Modulation Characteristics

N/A

### 4.2.2 Test Setup



### 4.2.3 Test Procedure

Connect the EUT to Communication Simulator via the antenna connector. The frequency band is set as EUT supported Modulation and Channels, the EUT output is matched with 50 ohm load, the waveform quality and constellation of the EUT was tested.

### 4.2.4 Test Results

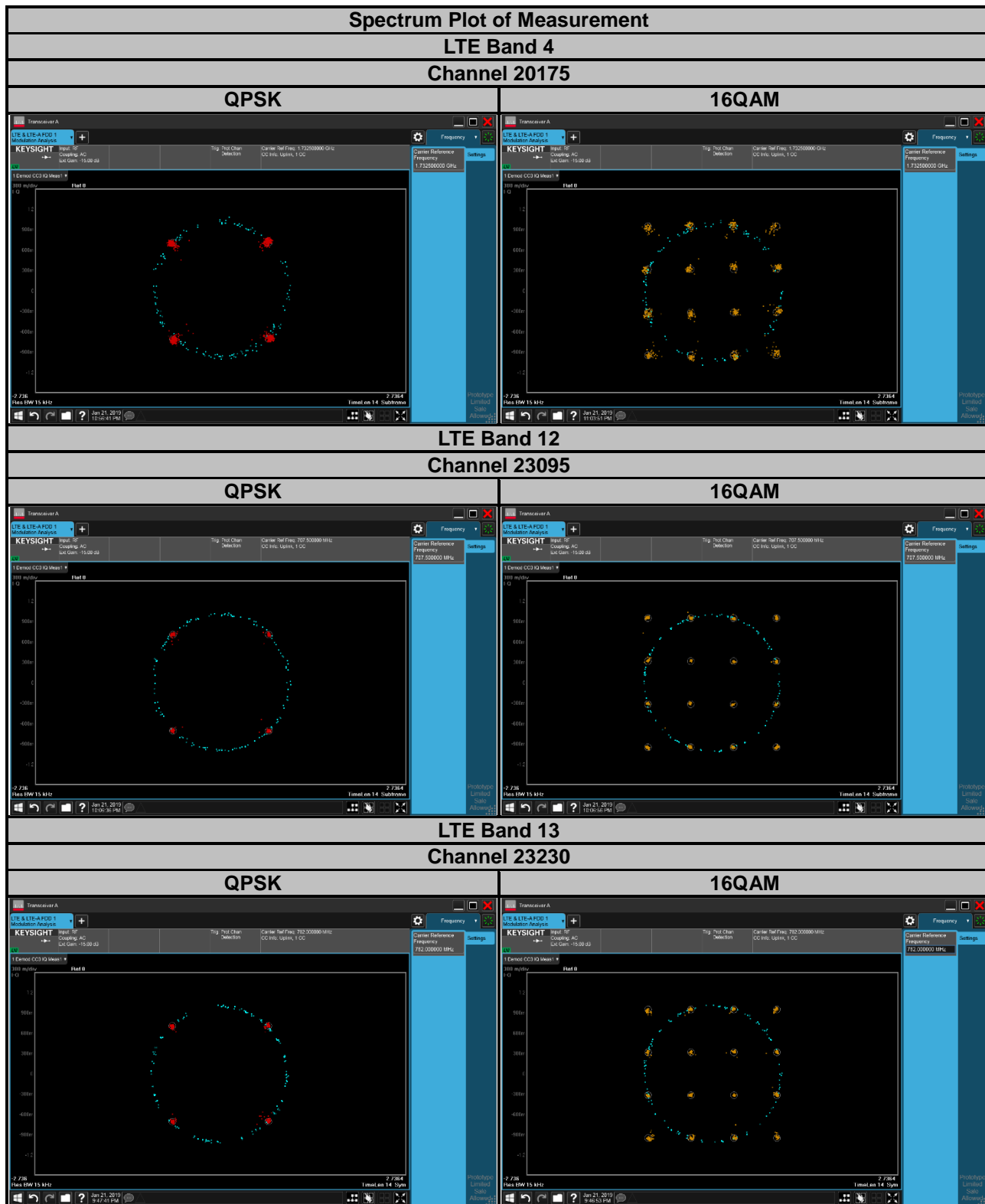



### 4.3 Frequency Stability Measurement

#### 4.3.1 Limits of Frequency Stability Measurement

The frequency stability shall be sufficient to ensure that the fundamental emissions stay within the authorized bands of operation.

#### 4.3.2 Test Procedure

- a. Device is placed at the oven room. The oven room could control the temperatures and humidity. Power warm up is at least 15 min and power applied should perform before recording frequency error.
- b. EUT is connected the external power supply to control the DC input power. The test voltage range is from minimum to maximum working voltage. Each step shall be record the frequency error rate.
- c. The temperature range step is 10 degrees in this test items. All temperature levels shall be hold the  $\pm 0.5$  °C during the measurement testing. The each temperature step shall be at least 0.5 hours, consider the EUT could be test under the stability condition.

**Note:** The frequency error was recorded frequency error from the communication simulator.

#### 4.3.3 Test Setup

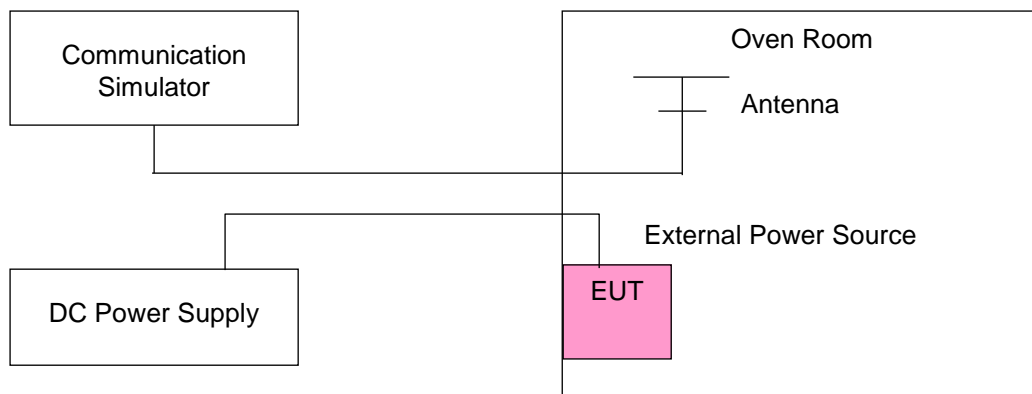

#### 4.3.4 Test Results

##### Frequency Error vs. Voltage

Voltage (Volts)	LTE Band 4			
	Channel Bandwidth: 5 MHz			
	Low Channel		High Channel	
	Frequency (MHz)	Frequency Error (ppm)	Frequency (MHz)	Frequency Error (ppm)
3.8	1710.700002	0.001	1754.300001	0.001
3.6	1710.700004	0.002	1754.300002	0.001
4.35	1710.700003	0.002	1754.300002	0.001

**Note:** The applicant defined the normal working voltage of the DC power supply is from 3.6 Vdc to 4.35 Vdc.

##### Frequency Error vs. Temperature

Temp. (°C)	LTE Band 4			
	Channel Bandwidth: 5 MHz			
	Low Channel		High Channel	
	Frequency (MHz)	Frequency Error (ppm)	Frequency (MHz)	Frequency Error (ppm)
-30	1710.700002	0.001	1754.300002	0.001
-20	1710.700004	0.002	1754.300002	0.001
-10	1710.700003	0.002	1754.300002	0.001
0	1710.700001	0.001	1754.300002	0.001
10	1710.700003	0.002	1754.300004	0.002
20	1710.699999	-0.001	1754.299999	-0.001
30	1710.699998	-0.001	1754.299997	-0.002
40	1710.699996	-0.002	1754.299996	-0.002
50	1710.699999	-0.001	1754.299997	-0.002
60	1710.699996	-0.002	1754.299998	-0.001
70	1710.699997	-0.002	1754.299998	-0.001
80	1710.699997	-0.002	1754.299997	-0.001
85	1710.699998	-0.001	1754.299998	-0.001

Frequency Error vs. Voltage

Voltage (Volts)	LTE Band 4			
	Channel Bandwidth: 10 MHz			
	Low Channel		High Channel	
	Frequency (MHz)	Frequency Error (ppm)	Frequency (MHz)	Frequency Error (ppm)
3.8	1710.700001	0.001	1754.300003	0.002
3.6	1710.700001	0.001	1754.300003	0.001
4.35	1710.700002	0.001	1754.300003	0.002

**Note:** The applicant defined the normal working voltage of the DC power supply is from 3.6 Vdc to 4.35 Vdc.

Frequency Error vs. Temperature

Temp. (°C)	LTE Band 4			
	Channel Bandwidth: 10 MHz			
	Low Channel		High Channel	
	Frequency (MHz)	Frequency Error (ppm)	Frequency (MHz)	Frequency Error (ppm)
-30	1710.700004	0.002	1754.300004	0.002
-20	1710.700002	0.001	1754.300002	0.001
-10	1710.700003	0.002	1754.300003	0.002
0	1710.700003	0.002	1754.300002	0.001
10	1710.700004	0.002	1754.300001	0.001
20	1710.699997	-0.002	1754.299997	-0.002
30	1710.699998	-0.001	1754.299998	-0.001
40	1710.699996	-0.002	1754.299997	-0.002
50	1710.699997	-0.002	1754.299997	-0.002
60	1710.699997	-0.002	1754.299998	-0.001
70	1710.699997	-0.002	1754.299996	-0.002
80	1710.699999	-0.001	1754.299996	-0.002
85	1710.699998	-0.001	1754.299996	-0.002

Frequency Error vs. Voltage

Voltage (Volts)	LTE Band 4			
	Channel Bandwidth: 15 MHz			
	Low Channel		High Channel	
	Frequency (MHz)	Frequency Error (ppm)	Frequency (MHz)	Frequency Error (ppm)
3.8	1710.700004	0.002	1754.300004	0.002
3.6	1710.700002	0.001	1754.300003	0.002
4.35	1710.700003	0.002	1754.300003	0.002

**Note:** The applicant defined the normal working voltage of the DC power supply is from 3.6 Vdc to 4.35 Vdc.

Frequency Error vs. Temperature

Temp. (°C)	LTE Band 4			
	Channel Bandwidth: 15 MHz			
	Low Channel		High Channel	
	Frequency (MHz)	Frequency Error (ppm)	Frequency (MHz)	Frequency Error (ppm)
-30	1710.700001	0.001	1754.300003	0.002
-20	1710.700004	0.002	1754.300002	0.001
-10	1710.700004	0.002	1754.300002	0.001
0	1710.700002	0.001	1754.300002	0.001
10	1710.700002	0.001	1754.300002	0.001
20	1710.699997	-0.002	1754.299998	-0.001
30	1710.699996	-0.002	1754.299999	-0.001
40	1710.699998	-0.001	1754.299996	-0.002
50	1710.699999	-0.001	1754.299999	-0.001
60	1710.699998	-0.001	1754.299999	-0.001
70	1710.699996	-0.002	1754.299998	-0.001
80	1710.699996	-0.002	1754.299997	-0.002
85	1710.699999	-0.001	1754.299997	-0.002

## Frequency Error vs. Voltage

Voltage (Volts)	LTE Band 4			
	Channel Bandwidth: 20 MHz			
	Low Channel		High Channel	
	Frequency (MHz)	Frequency Error (ppm)	Frequency (MHz)	Frequency Error (ppm)
3.8	1710.700003	0.002	1754.300001	0.001
3.6	1710.700001	0.001	1754.300004	0.002
4.35	1710.700003	0.002	1754.300002	0.001

**Note:** The applicant defined the normal working voltage of the DC power supply is from 3.6 Vdc to 4.35 Vdc.

## Frequency Error vs. Temperature

Temp. (°C)	LTE Band 4			
	Channel Bandwidth: 20 MHz			
	Low Channel		High Channel	
	Frequency (MHz)	Frequency Error (ppm)	Frequency (MHz)	Frequency Error (ppm)
-30	1710.700003	0.002	1754.300003	0.002
-20	1710.700003	0.002	1754.300004	0.002
-10	1710.700004	0.002	1754.300004	0.002
0	1710.700002	0.001	1754.300001	0.001
10	1710.700002	0.001	1754.300004	0.002
20	1710.699999	-0.001	1754.299998	-0.001
30	1710.699997	-0.002	1754.299996	-0.002
40	1710.699996	-0.002	1754.299997	-0.002
50	1710.699998	-0.001	1754.299998	-0.001
60	1710.699999	-0.001	1754.299999	-0.001
70	1710.699997	-0.002	1754.299998	-0.001
80	1710.699998	-0.001	1754.299999	-0.001
85	1710.699997	-0.002	1754.299997	-0.002

Frequency Error vs. Voltage

Voltage (Volts)	LTE Band 12			
	Channel Bandwidth: 5 MHz			
	Low Channel		High Channel	
	Frequency (MHz)	Frequency Error (ppm)	Frequency (MHz)	Frequency Error (ppm)
3.8	699.700003	0.004	715.300003	0.004
3.6	699.700003	0.004	715.300003	0.004
4.35	699.700002	0.002	715.300001	0.001

**Note:** The applicant defined the normal working voltage of the DC power supply is from 3.6 Vdc to 4.35 Vdc.

Frequency Error vs. Temperature

Temp. (°C)	LTE Band 12			
	Channel Bandwidth: 5 MHz			
	Low Channel		High Channel	
	Frequency (MHz)	Frequency Error (ppm)	Frequency (MHz)	Frequency Error (ppm)
-30	699.700002	0.003	715.300003	0.004
-20	699.700001	0.002	715.300002	0.002
-10	699.700002	0.003	715.300004	0.005
0	699.700003	0.004	715.300001	0.002
10	699.700002	0.003	715.300004	0.006
20	699.699999	-0.002	715.299997	-0.004
30	699.699997	-0.005	715.299996	-0.006
40	699.699997	-0.004	715.299997	-0.005
50	699.699998	-0.003	715.299996	-0.005
60	699.699996	-0.006	715.299998	-0.004
70	699.699999	-0.002	715.299998	-0.004
80	699.699999	-0.002	715.299999	-0.002
85	699.699998	-0.003	715.299999	-0.002

## Frequency Error vs. Voltage

Voltage (Volts)	LTE Band 12			
	Channel Bandwidth: 10 MHz			
	Low Channel		High Channel	
	Frequency (MHz)	Frequency Error (ppm)	Frequency (MHz)	Frequency Error (ppm)
3.8	699.700002	0.003	715.300003	0.005
3.6	699.700003	0.004	715.300001	0.001
4.35	699.700002	0.003	715.300004	0.005

**Note:** The applicant defined the normal working voltage of the DC power supply is from 3.6 Vdc to 4.35 Vdc.

## Frequency Error vs. Temperature

Temp. (°C)	LTE Band 12			
	Channel Bandwidth: 10 MHz			
	Low Channel		High Channel	
	Frequency (MHz)	Frequency Error (ppm)	Frequency (MHz)	Frequency Error (ppm)
-30	699.700004	0.006	715.300002	0.002
-20	699.700003	0.004	715.300003	0.005
-10	699.700002	0.003	715.300001	0.002
0	699.700001	0.002	715.300003	0.004
10	699.700004	0.006	715.300002	0.002
20	699.699998	-0.002	715.299997	-0.004
30	699.699998	-0.003	715.299998	-0.003
40	699.699998	-0.003	715.299998	-0.004
50	699.699998	-0.003	715.299997	-0.005
60	699.699997	-0.005	715.299998	-0.003
70	699.699998	-0.003	715.299997	-0.004
80	699.699998	-0.003	715.299997	-0.004
85	699.699998	-0.003	715.299997	-0.004

Frequency Error vs. Voltage

Voltage (Volts)	LTE Band 13			
	Channel Bandwidth: 5 MHz			
	Low Channel		High Channel	
	Frequency (MHz)	Frequency Error (ppm)	Frequency (MHz)	Frequency Error (ppm)
3.8	779.500002	0.002	784.500003	0.004
3.6	779.500002	0.002	784.500003	0.004
4.35	779.500003	0.004	784.500001	0.002

**Note:** The applicant defined the normal working voltage of the DC power supply is from 3.6 Vdc to 4.35 Vdc.

Frequency Error vs. Temperature

Temp. (°C)	LTE Band 13			
	Channel Bandwidth: 5 MHz			
	Low Channel		High Channel	
	Frequency (MHz)	Frequency Error (ppm)	Frequency (MHz)	Frequency Error (ppm)
-30	779.500002	0.002	784.500001	0.002
-20	779.500002	0.003	784.500004	0.005
-10	779.500003	0.003	784.500003	0.004
0	779.500002	0.003	784.500003	0.003
10	779.500001	0.002	784.500003	0.003
20	779.499996	-0.005	784.499999	-0.002
30	779.499996	-0.005	784.499996	-0.005
40	779.499996	-0.005	784.499997	-0.003
50	779.499998	-0.003	784.499997	-0.004
60	779.499998	-0.002	784.499998	-0.003
70	779.500002	0.003	784.500002	0.002
80	779.500003	0.003	784.500004	0.005
85	779.500004	0.005	784.500003	0.003



Frequency Error vs. Voltage

Voltage (Volts)	LTE Band 13	
	Channel Bandwidth: 10 MHz	
	Frequency (MHz)	Frequency Error (ppm)
3.8	779.500003	0.003
3.6	779.500002	0.003
4.35	779.500003	0.003

**Note:** The applicant defined the normal working voltage of the DC power supply is from 3.6 Vdc to 4.35 Vdc.

Frequency Error vs. Temperature

Temp. (°C)	LTE Band 13	
	Channel Bandwidth: 10 MHz	
	Frequency (MHz)	Frequency Error (ppm)
-30	779.500003	0.004
-20	779.500002	0.003
-10	779.500003	0.003
0	779.500002	0.002
10	779.500001	0.001
20	779.499998	-0.002
30	779.499998	-0.003
40	779.499999	-0.001
50	779.499999	-0.002
60	779.499999	-0.002
70	779.500003	0.003
80	779.500003	0.004
85	779.500003	0.004

#### 4.4 Occupied Bandwidth Measurement

##### 4.4.1 Limits of Occupied Bandwidth Measurement

The width of a frequency band such that, below the lower and above the upper frequency limits, the mean powers emitted are each equal to a specified percentage 0.5 % of the total mean power of a given emission.

##### 4.4.2 Test Procedure

- The conducted occupied bandwidth used the power splitter via EUT RF power connector between simulation base station and spectrum analyzer.
- Use OBW measurement function of Spectrum analyzer to measure 99 % occupied bandwidth.

##### 4.4.3 Test Setup

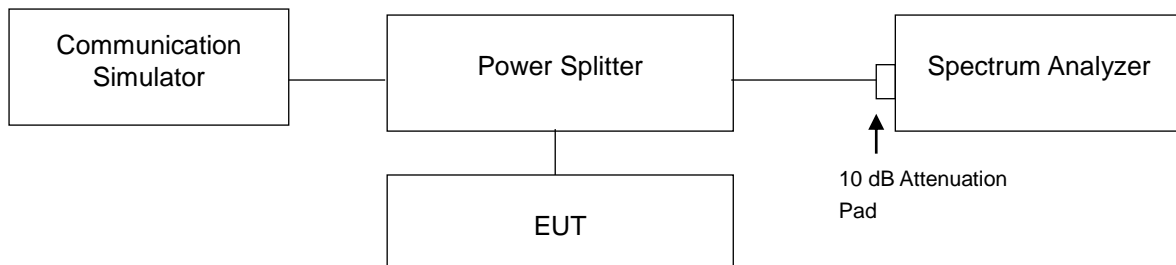

4.4.4 Test Result

LTE Band 4					
Channel Bandwidth: 5 MHz					
Channel	Frequency (MHz)	99 % Occupied Bandwidth (MHz)		26 dB Bandwidth (MHz)	
		QPSK	16QAM	QPSK	16QAM
19975	1712.5	1.1037	0.9204	1.378	1.264
20175	1732.5	1.0917	0.9215	1.391	1.286
20375	1752.5	1.0918	0.9207	1.423	1.239
Channel Bandwidth: 10 MHz					
Channel	Frequency (MHz)	99 % Occupied Bandwidth (MHz)		26 dB Bandwidth (MHz)	
		QPSK	16QAM	QPSK	16QAM
20000	1715.0	1.0907	0.9149	1.398	1.286
20175	1732.5	1.0893	0.9148	1.405	1.420
20350	1750.0	1.0890	0.9158	1.455	1.338

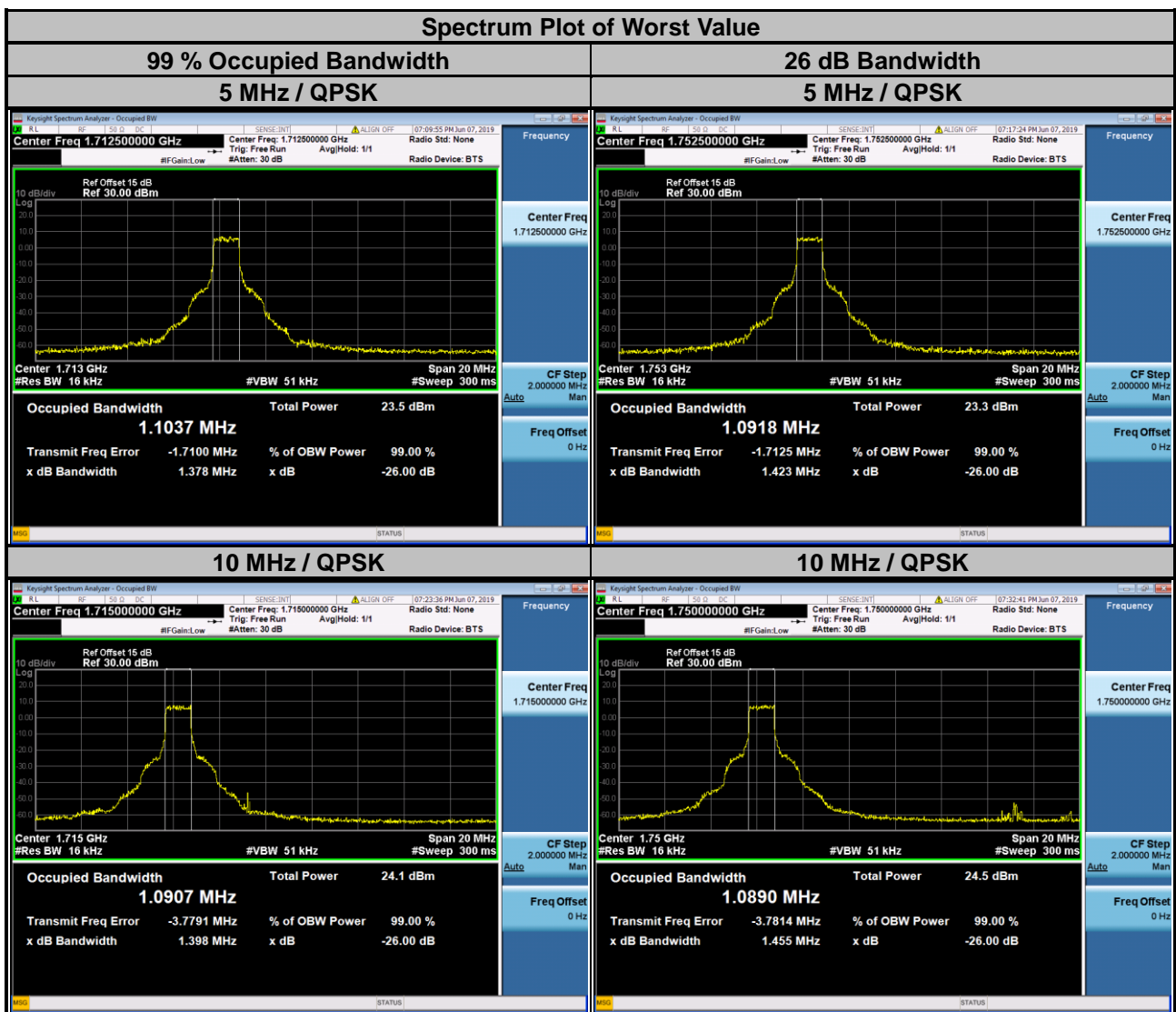

LTE Band 4					
Channel Bandwidth: 15 MHz					
Channel	Frequency (MHz)	99 % Occupied Bandwidth (MHz)		26 dB Bandwidth (MHz)	
		QPSK	16QAM	QPSK	16QAM
20025	1717.5	1.0934	0.9245	1.408	1.435
20175	1732.5	1.0962	0.9259	1.423	1.448
20325	1747.5	1.0934	0.9290	1.454	1.471

Channel Bandwidth: 20 MHz					
Channel	Frequency (MHz)	99 % Occupied Bandwidth (MHz)		26 dB Bandwidth (MHz)	
		QPSK	16QAM	QPSK	16QAM
20050	1720.0	1.0918	0.9174	1.429	1.332
20175	1732.5	1.0940	0.9182	1.432	1.436
20300	1745.0	1.0953	0.9187	1.492	1.458

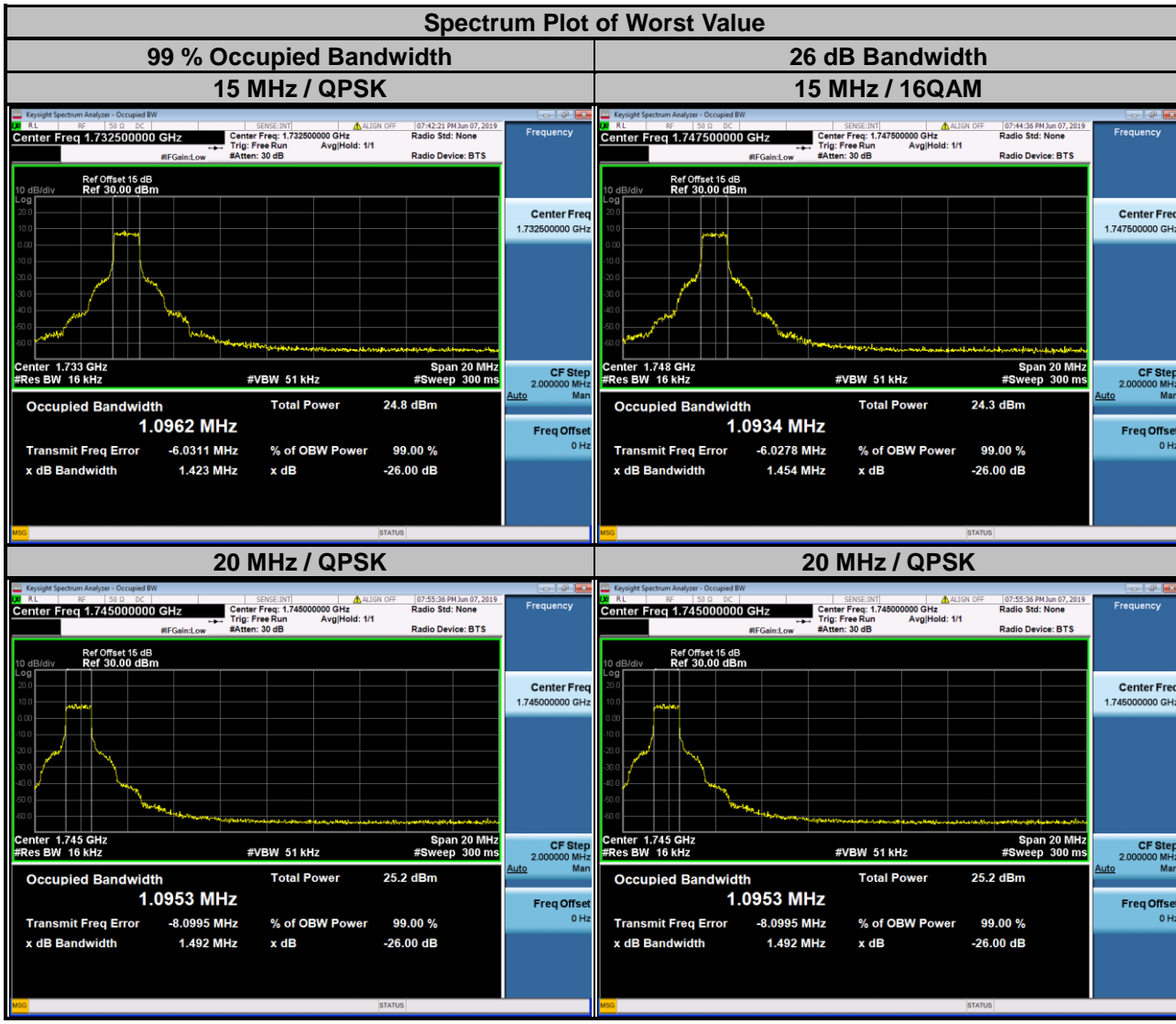

LTE Band 12					
Channel Bandwidth: 5 MHz					
Channel	Frequency (MHz)	99 % Occupied Bandwidth (MHz)		26 dB Bandwidth (MHz)	
		QPSK	16QAM	QPSK	16QAM
23035	701.5	1.0856	0.9087	1.369	1.280
23095	707.5	1.0835	0.9224	1.323	1.204
23155	713.5	1.0858	0.9184	1.374	1.254

Channel Bandwidth: 10 MHz					
Channel	Frequency (MHz)	99 % Occupied Bandwidth (MHz)		26 dB Bandwidth (MHz)	
		QPSK	16QAM	QPSK	16QAM
23060	704.0	1.0887	0.9137	1.351	1.248
23095	707.5	1.0888	0.9138	1.350	1.198
23130	711.0	1.0920	0.9120	1.361	1.249

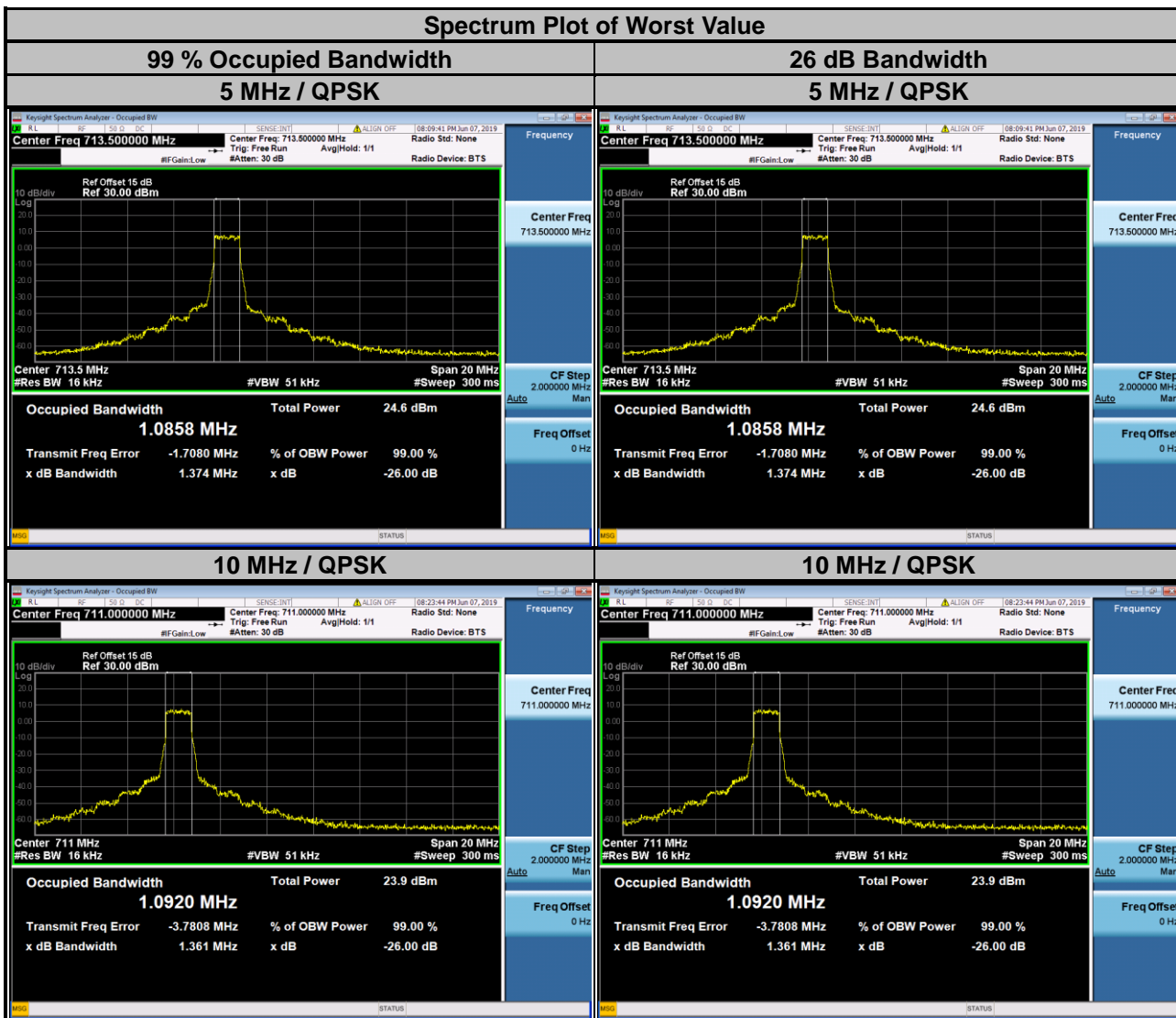

LTE Band 13					
Channel Bandwidth: 5 MHz					
Channel	Frequency (MHz)	99 % Occupied Bandwidth (MHz)		26 dB Bandwidth (MHz)	
		QPSK	16QAM	QPSK	16QAM
23205	779.5	1.0919	0.9241	1.371	1.319
23230	782.0	1.0866	0.9181	1.377	1.288
23255	784.5	1.0947	0.9233	1.367	1.240

Channel Bandwidth: 10 MHz					
Channel	Frequency (MHz)	99 % Occupied Bandwidth (MHz)		26 dB Bandwidth (MHz)	
		QPSK	16QAM	QPSK	16QAM
23230	782.0	1.0903	0.9145	1.375	1.288

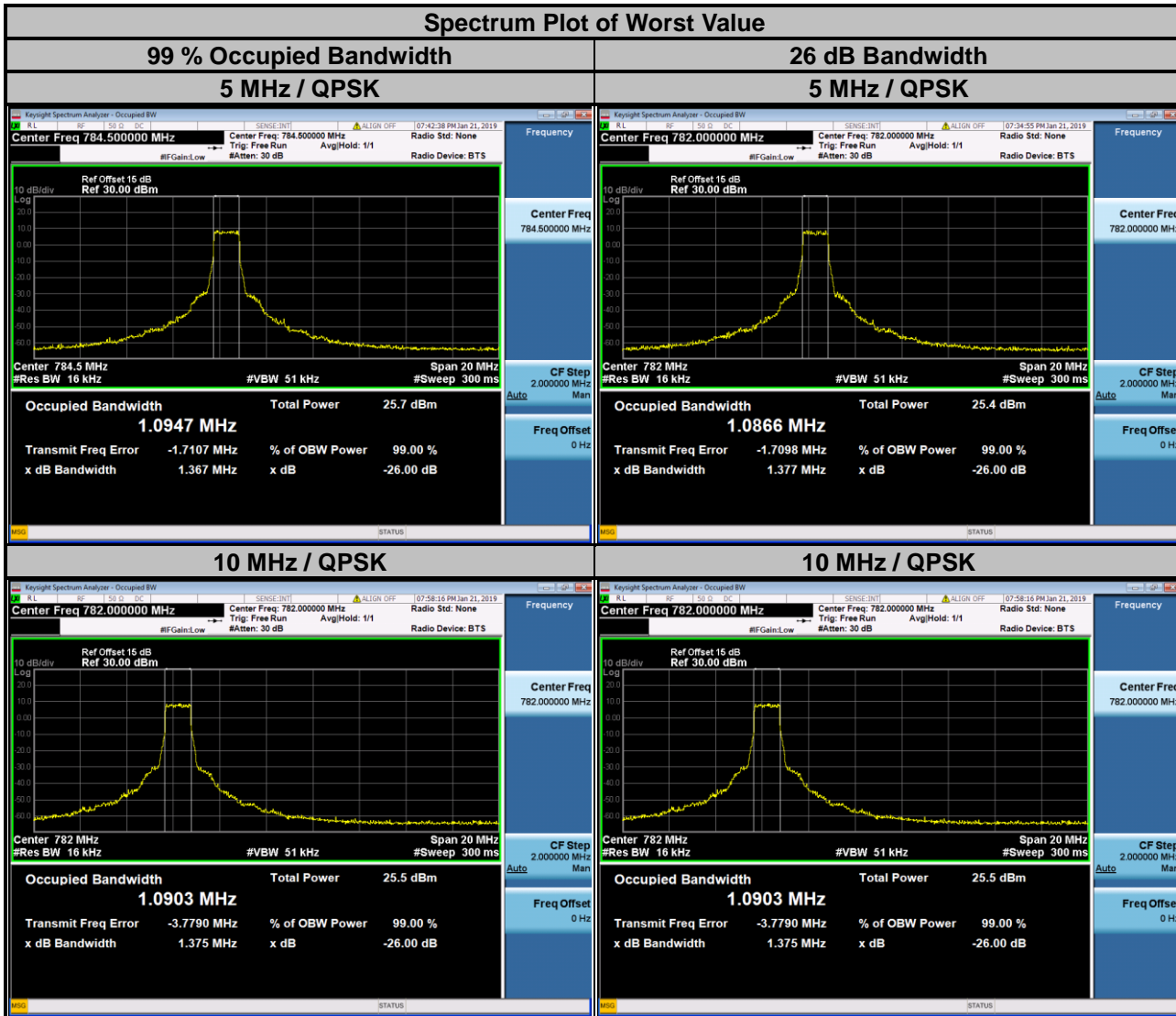

## 4.5 Band Edge Measurement

### 4.5.1 Limits of Band Edge Measurement

For operations in the 698-787 MHz band, the power of any emission outside a licensee's frequency band(s) of operation shall be attenuated below the transmitter power (P) within the licensed band(s) of operation, measured in watts, by at least  $43 + 10 \log (P)$  dB. Compliance with this provision is based on the use of measurement instrumentation employing a resolution bandwidth of 100 kilohertz or greater.

However, in the 100 kilohertz bands immediately outside and adjacent to a licensee's frequency block, a resolution bandwidth of at least 30 kHz may be employed.

For operations in the 746-758 MHz band and the 776-788 MHz band, the power of any emission outside a licensee's frequency band(s) of operation shall be attenuated below the transmitter power (P) within the licensed band(s) of operation, measured in watts, by at least  $43 + 10 \log (P)$  dB.

On all frequencies between 763-775 MHz and 793-805 MHz, by a factor no less than  $65 + 10 \log (P)$  dB in a 6.25 kHz band segment, for mobile and portable stations.

For operations in the 1710–1755 MHz bands, the power of any emission outside a licensee's frequency block shall be attenuated below the transmitter power (P) by at least  $43 + 10 \log (P)$  dB.

### 4.5.2 Test Setup

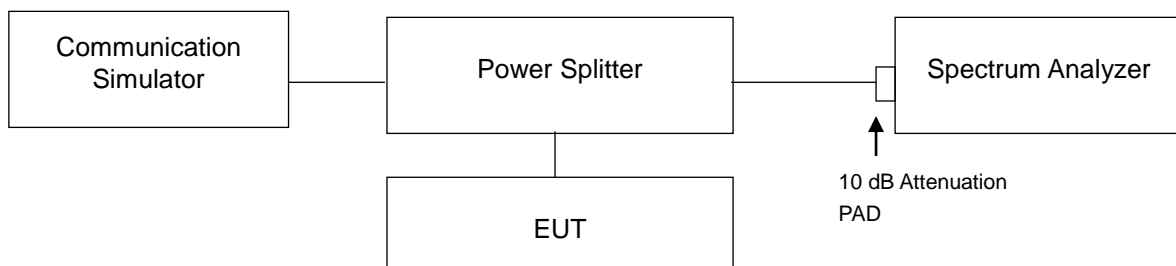

### 4.5.3 Test Procedures

- All measurements were done at low and high operational frequency range.
- The center frequency of spectrum is the band edge frequency and span is 5 MHz. RB of the spectrum is 16 kHz and VB of the spectrum is 51 kHz.
- Record the max. trace plot into the test report.

### 4.5.4 Test Results

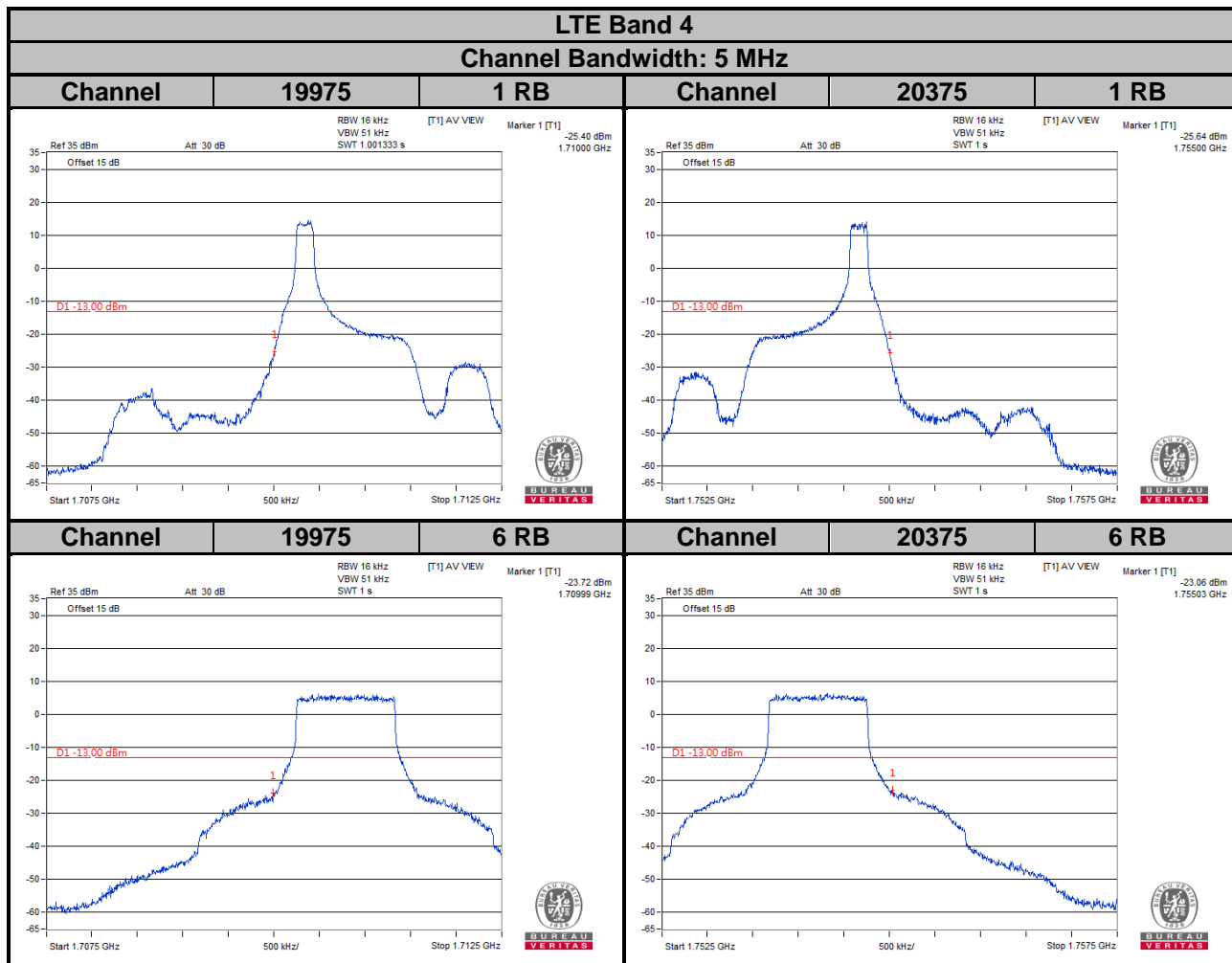



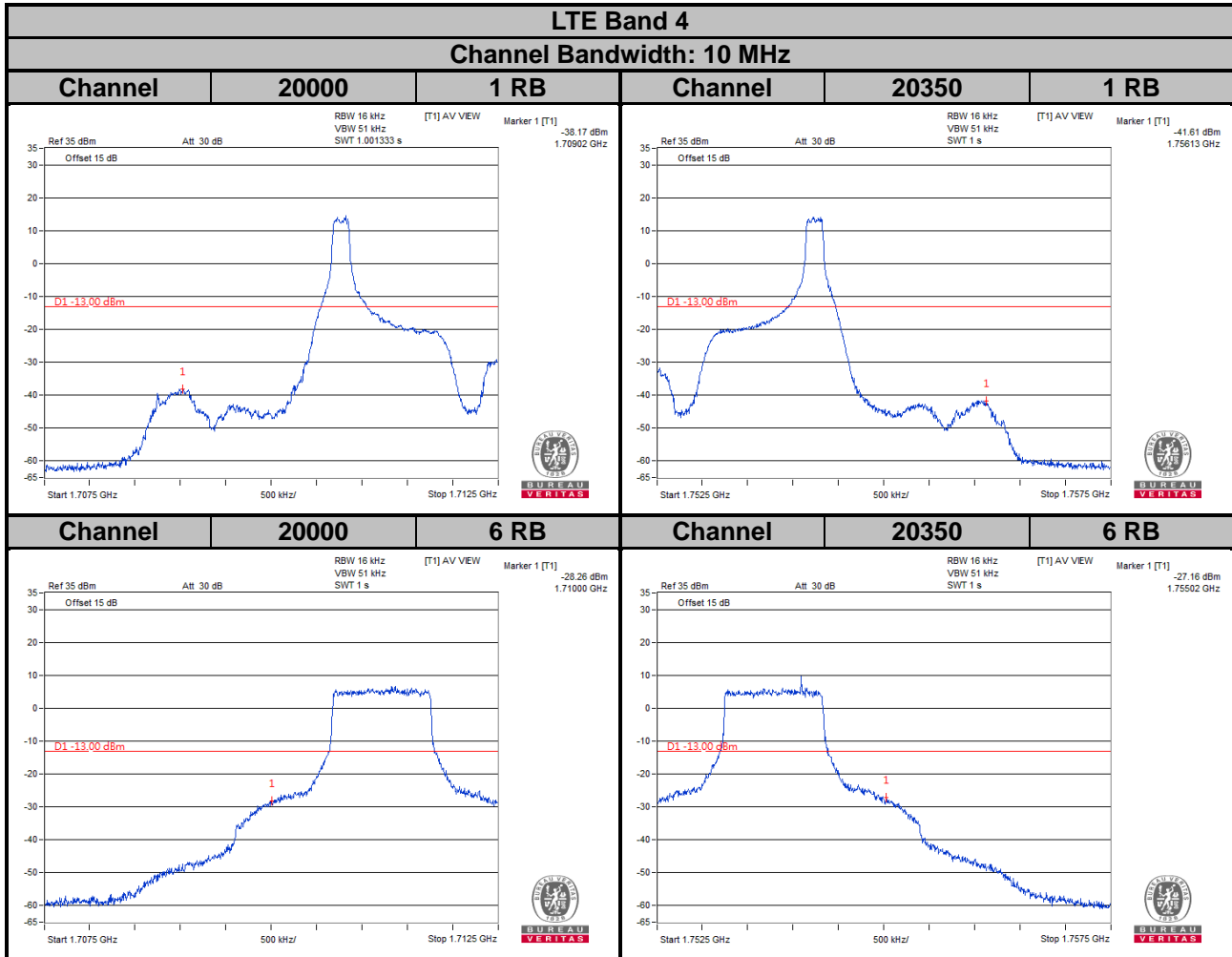

**LTE Band 4**  
**Channel Bandwidth: 15 MHz**

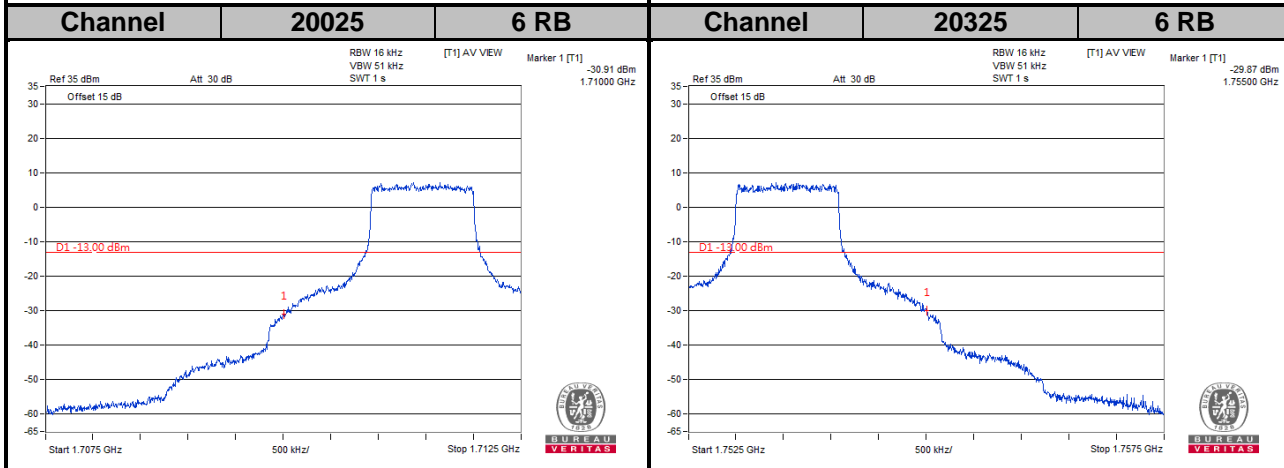
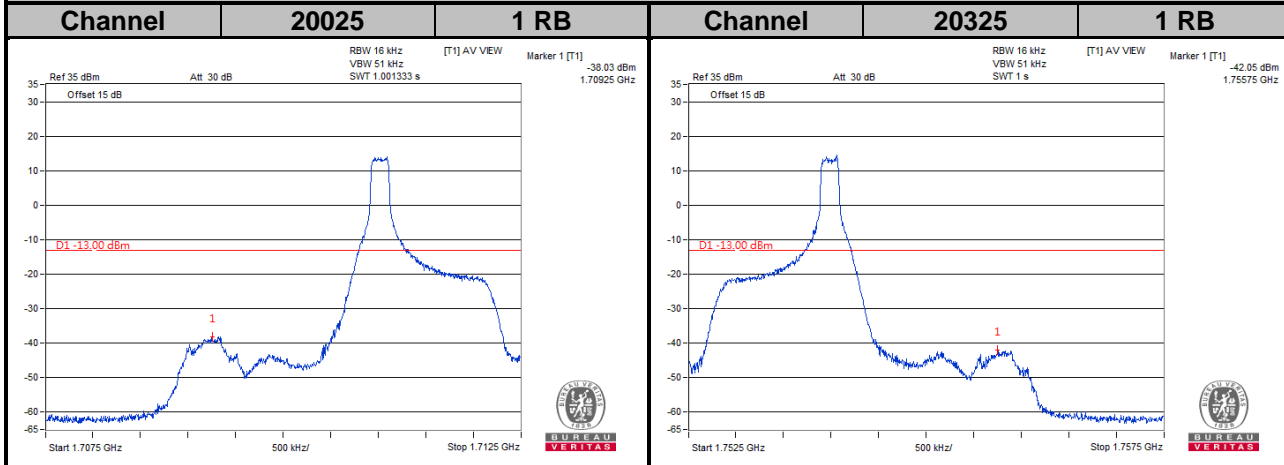

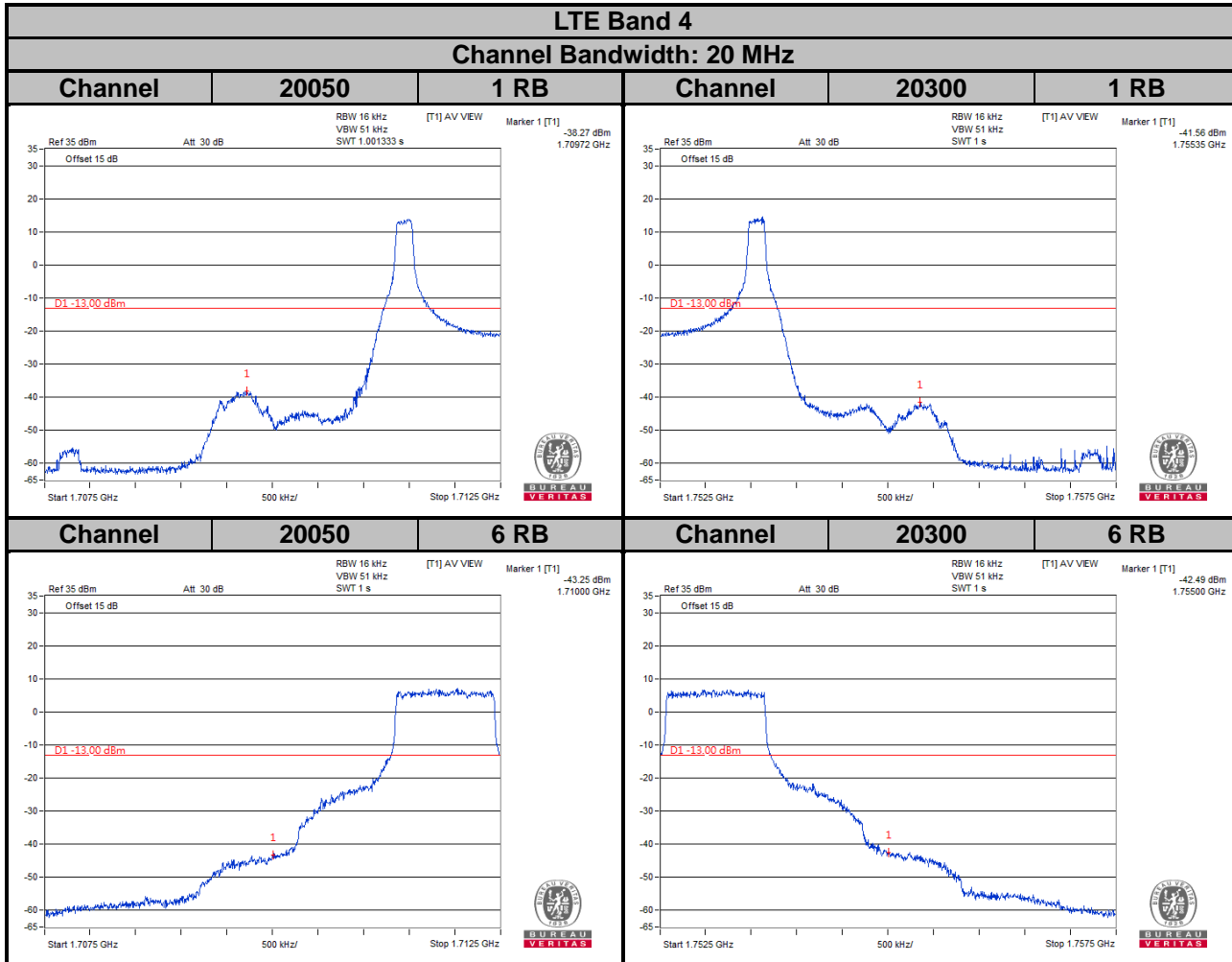

**LTE Band 12**  
**Channel Bandwidth: 5 MHz**

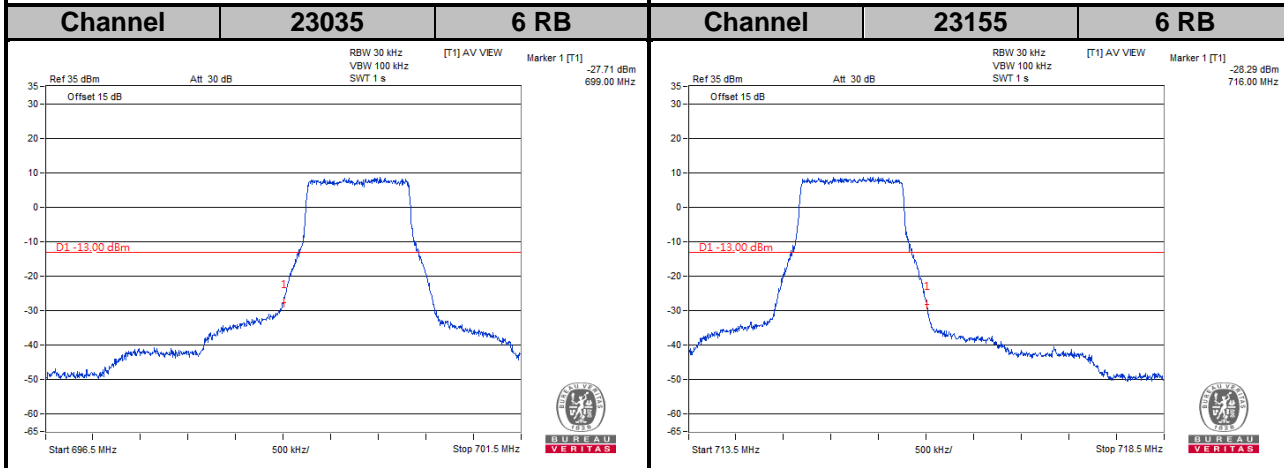
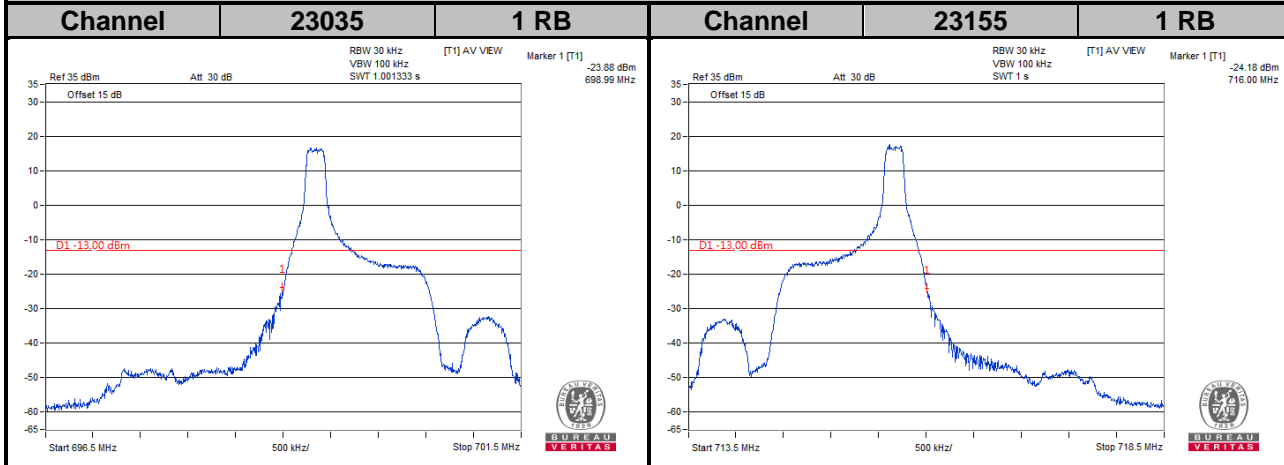

**LTE Band 12**  
**Channel Bandwidth: 10 MHz**

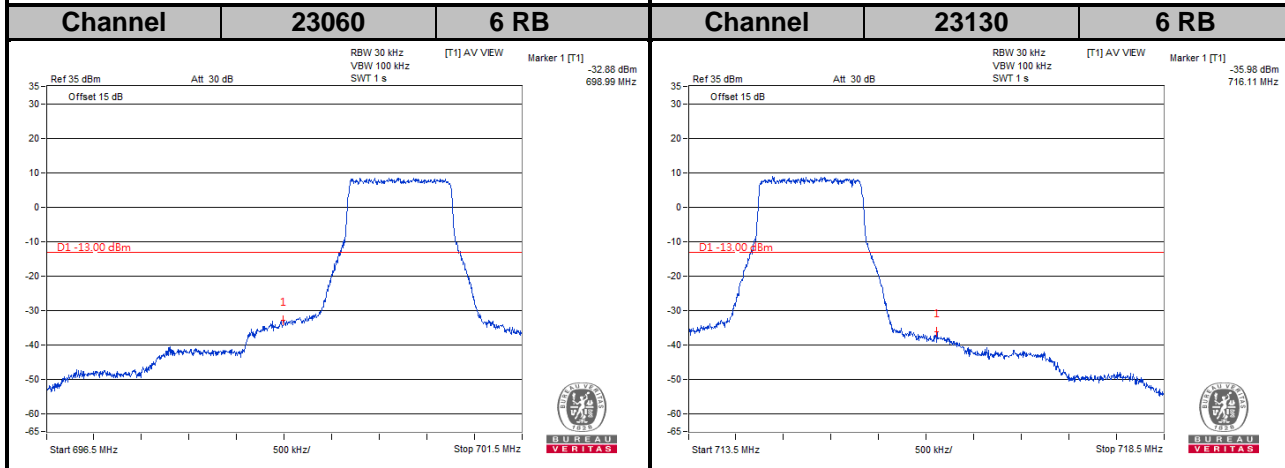
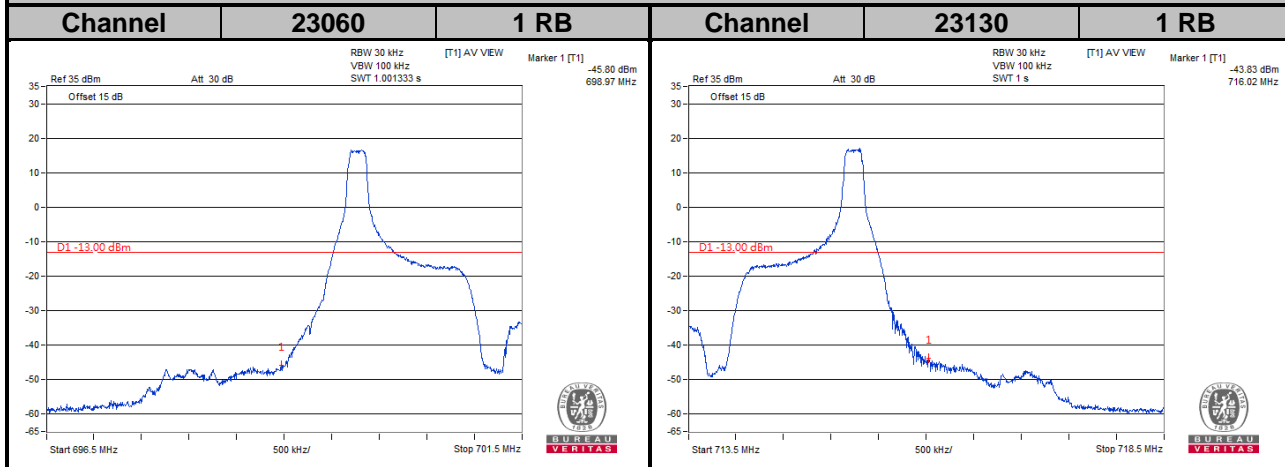

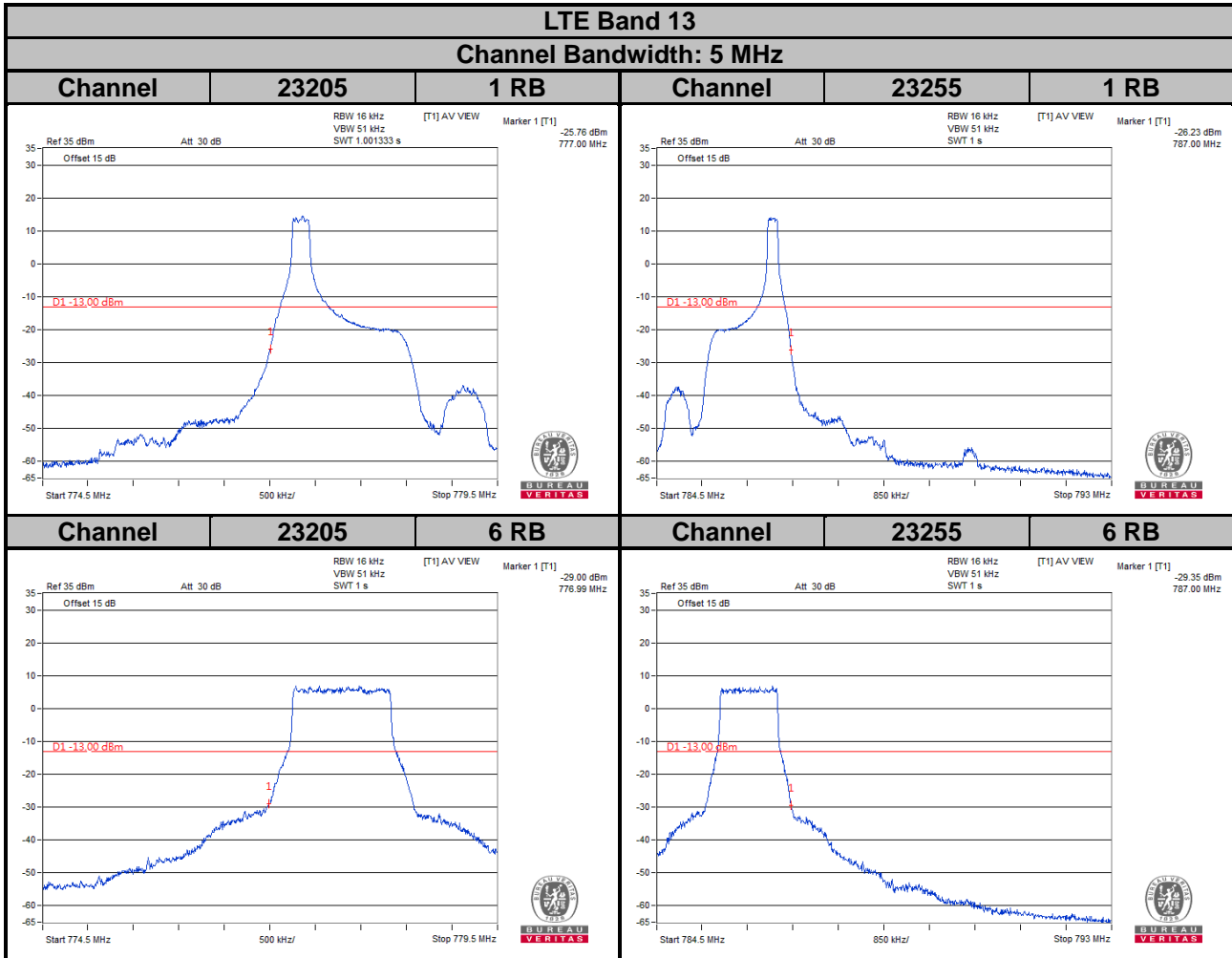

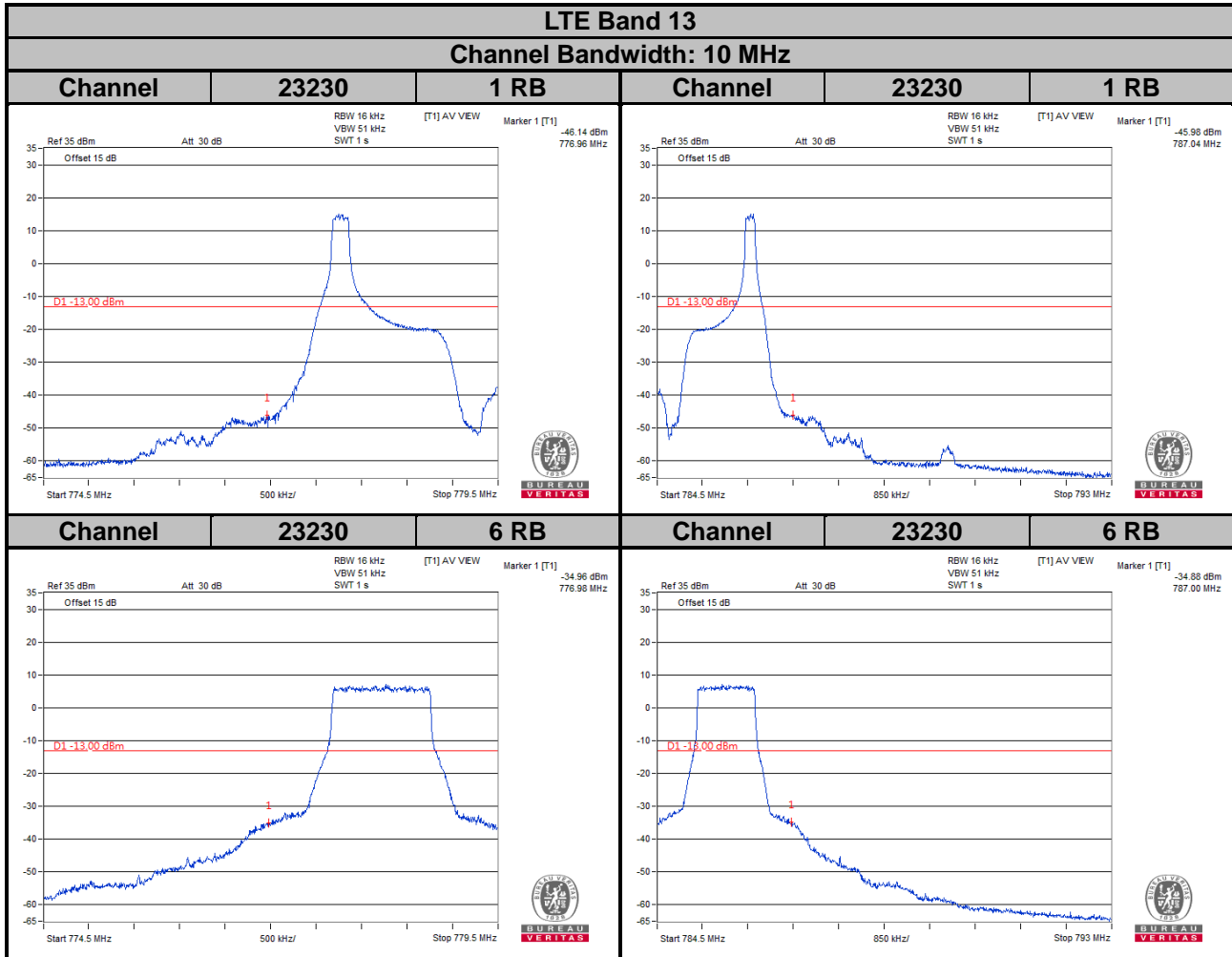

### Emission Mask

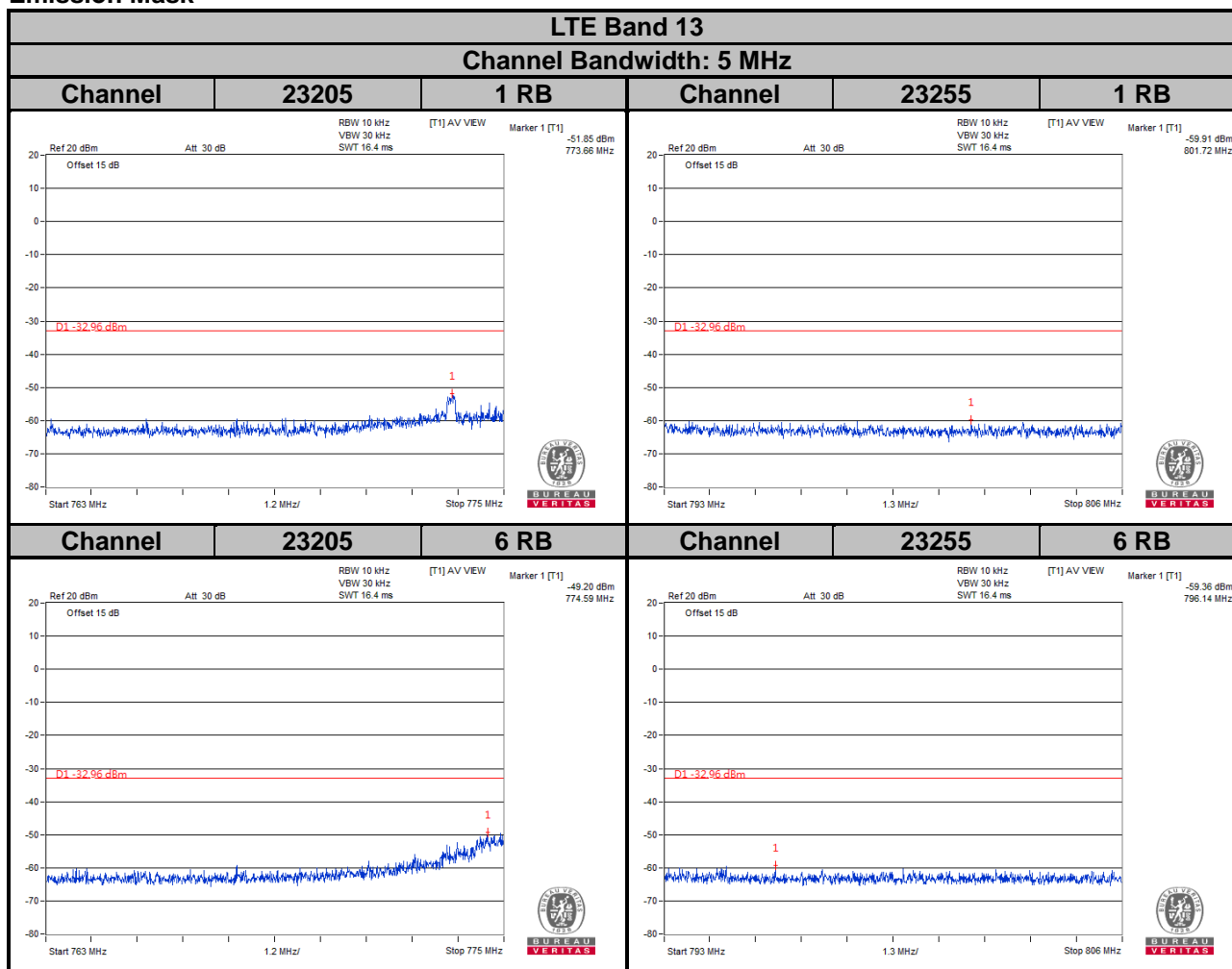

For the 763 - 775 MHz and 793 - 805 MHz band, the FCC limit is  $65 + 10\log(P[\text{watt}])$  in a 6.25 kHz bandwidth. Since it was not possible to set the resolution bandwidth to 6.25 kHz with the available equipment, a bandwidth of 10 kHz was used instead to show compliance. By using a 10 kHz bandwidth on the spectrum analyzer.

$$10\log(10\text{kHz}/6.25\text{kHz}) = 2.04 \text{ dB}$$

$$\text{Limit line} = -35 \text{ dBm} + 2.04 \text{ dB} = -32.96 \text{ dBm}$$



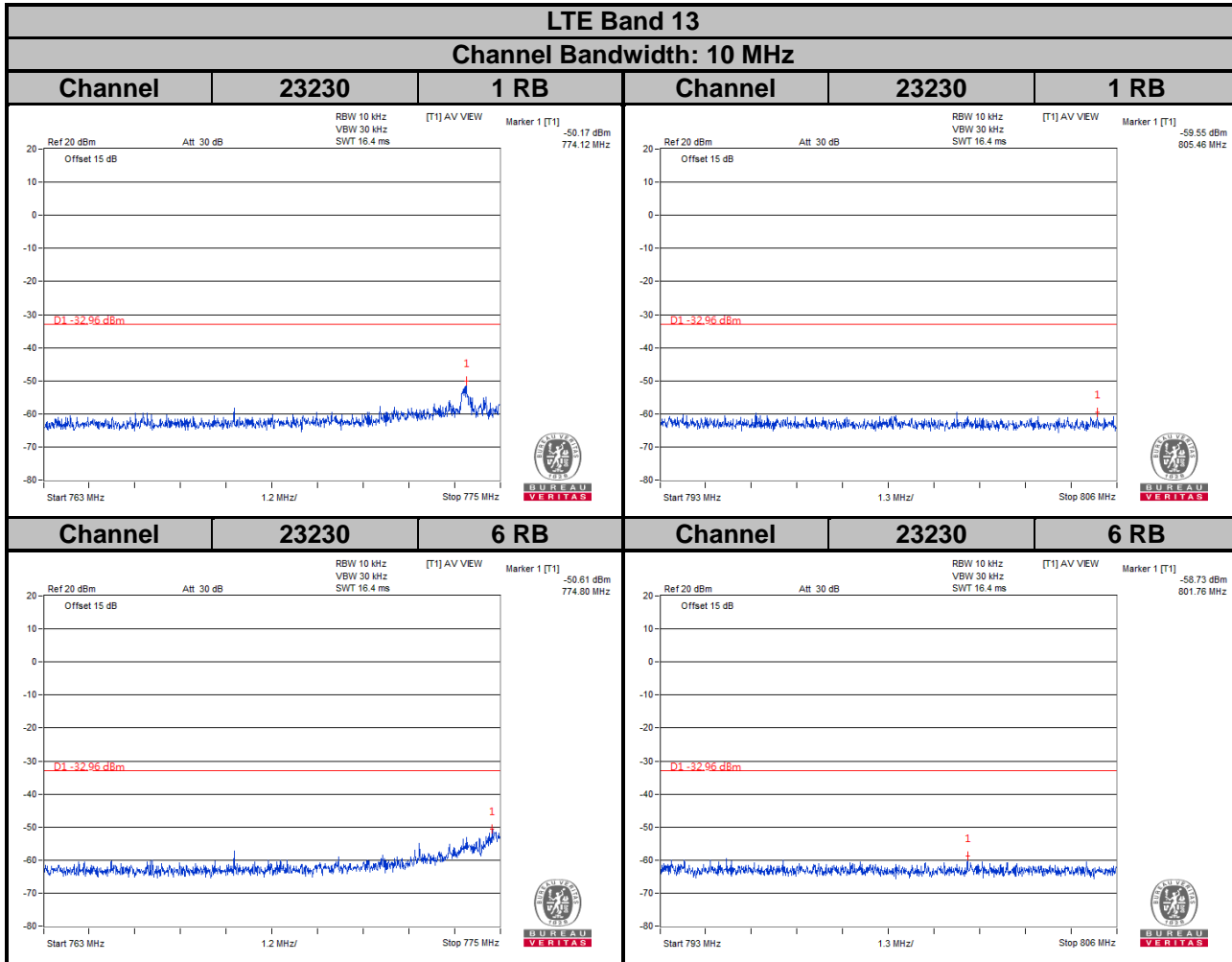

For the 763 - 775 MHz and 793 - 805 MHz band, the FCC limit is  $65 + 10\log(P[\text{watt}])$  in a 6.25 kHz bandwidth. Since it was not possible to set the resolution bandwidth to 6.25 kHz with the available equipment, a bandwidth of 10 kHz was used instead to show compliance. By using a 10 kHz bandwidth on the spectrum analyzer.

$$10\log(10\text{kHz}/6.25\text{kHz}) = 2.04 \text{ dB}$$

$$\text{Limit line} = -35 \text{ dBm} + 2.04 \text{ dB} = -32.96 \text{ dBm}$$

## 4.6 Peak to Average Ratio

### 4.6.1 Limits of Peak to Average Ratio Measurement

In measuring transmissions in this band using an average power technique, the peak to-average ratio (PAR) of the transmission may not exceed 13 dB.

### 4.6.2 Test Setup

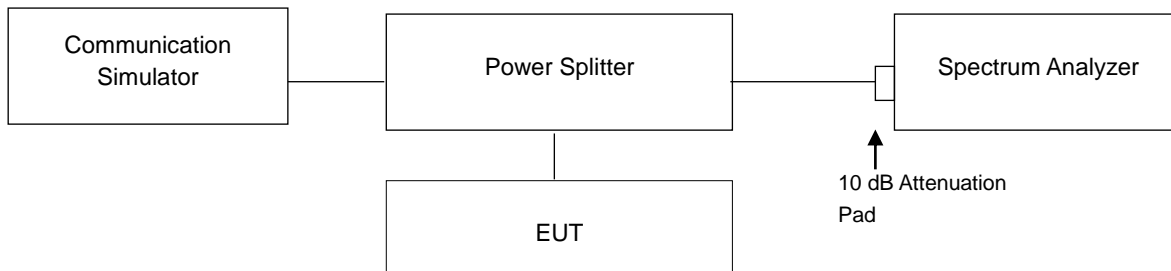

### 4.6.3 Test Procedures

1. Set resolution/measurement bandwidth  $\geq$  signal's occupied bandwidth;
2. Set the number of counts to a value that stabilizes the measured CCDF curve;
3. Record the maximum PAPR level associated with a probability of 0.1 %.

#### 4.6.4 Test Results

LTE Band 4							
Channel Bandwidth: 5 MHz				Channel Bandwidth: 10 MHz			
Channel	Frequency (MHz)	Peak to Average Ratio (dB)		Channel	Frequency (MHz)	Peak to Average Ratio (dB)	
		QPSK	16QAM			QPSK	16QAM
19975	1712.5	3.86	4.25	20000	1715.0	3.82	4.43
20175	1732.5	3.62	4.06	20175	1732.5	3.56	4.03
20375	1752.5	3.60	4.10	20350	1750.0	3.56	4.03

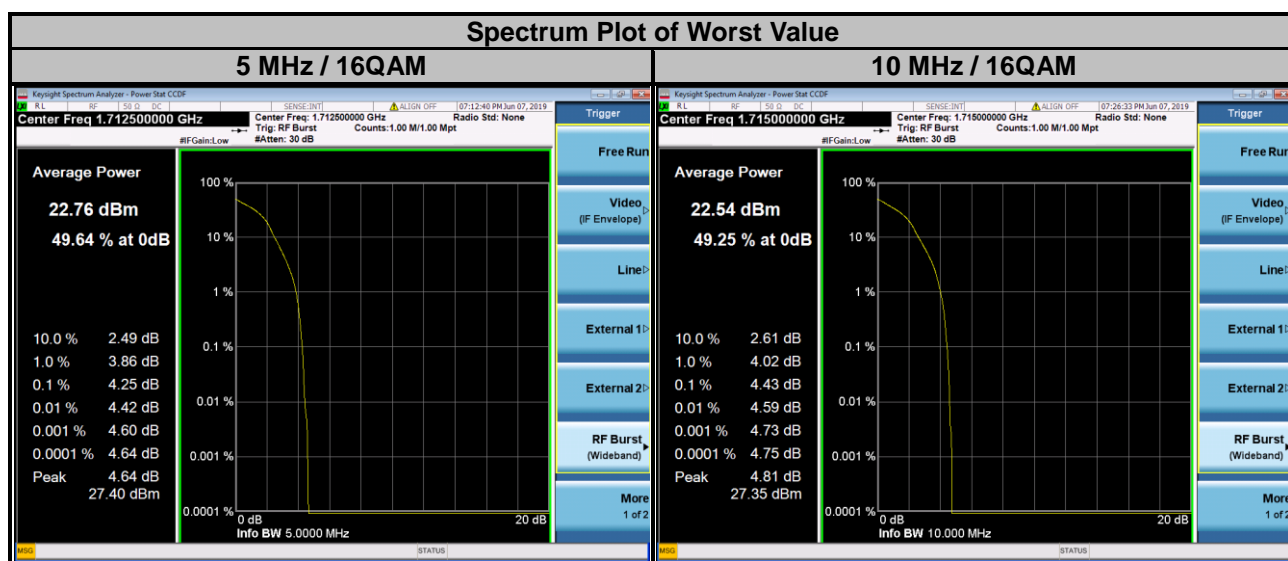

LTE Band 4							
Channel Bandwidth: 15 MHz				Channel Bandwidth: 20 MHz			
Channel	Frequency (MHz)	Peak to Average Ratio (dB)		Channel	Frequency (MHz)	Peak to Average Ratio (dB)	
		QPSK	16QAM			QPSK	16QAM
20025	1717.5	3.80	4.29	20050	1720.0	3.81	4.29
20175	1732.5	3.58	4.22	20175	1732.5	3.59	4.14
20325	1747.5	3.49	4.18	20300	1745.0	3.50	4.03

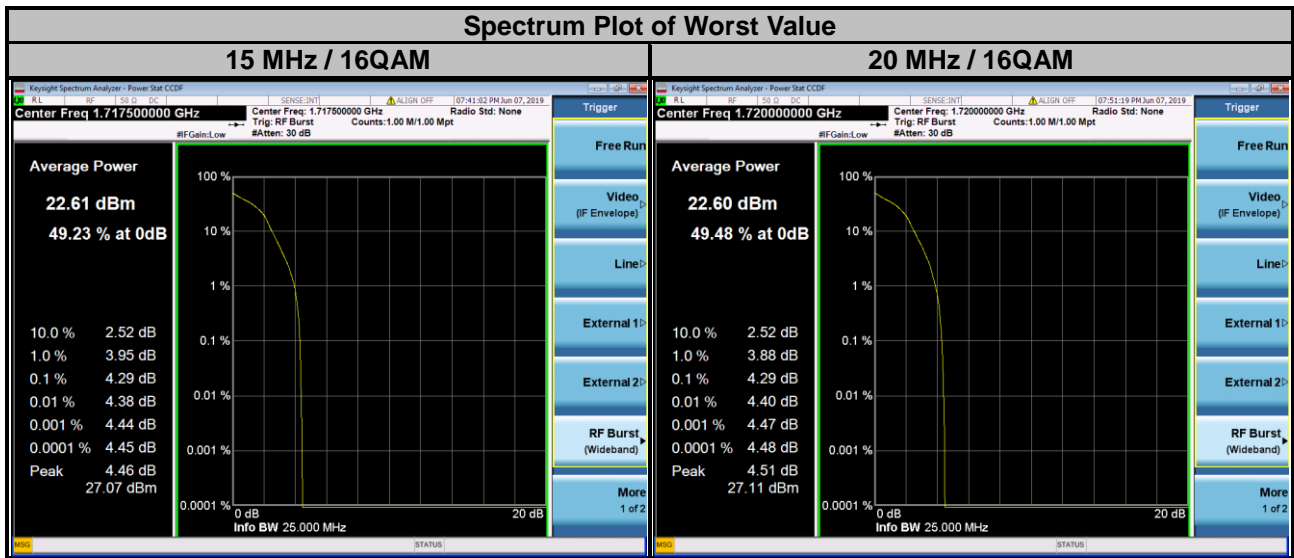

### LTE Band 12

Channel Bandwidth: 5 MHz				Channel Bandwidth: 10 MHz			
Channel	Frequency (MHz)	Peak to Average Ratio (dB)		Channel	Frequency (MHz)	Peak to Average Ratio (dB)	
		QPSK	16QAM			QPSK	16QAM
23035	701.5	5.48	6.28	23060	704.0	5.38	6.39
23095	707.5	5.58	6.43	23095	707.5	5.46	6.22
23155	713.5	5.38	5.87	23130	711.0	5.39	6.10

### Spectrum Plot of Worst Value

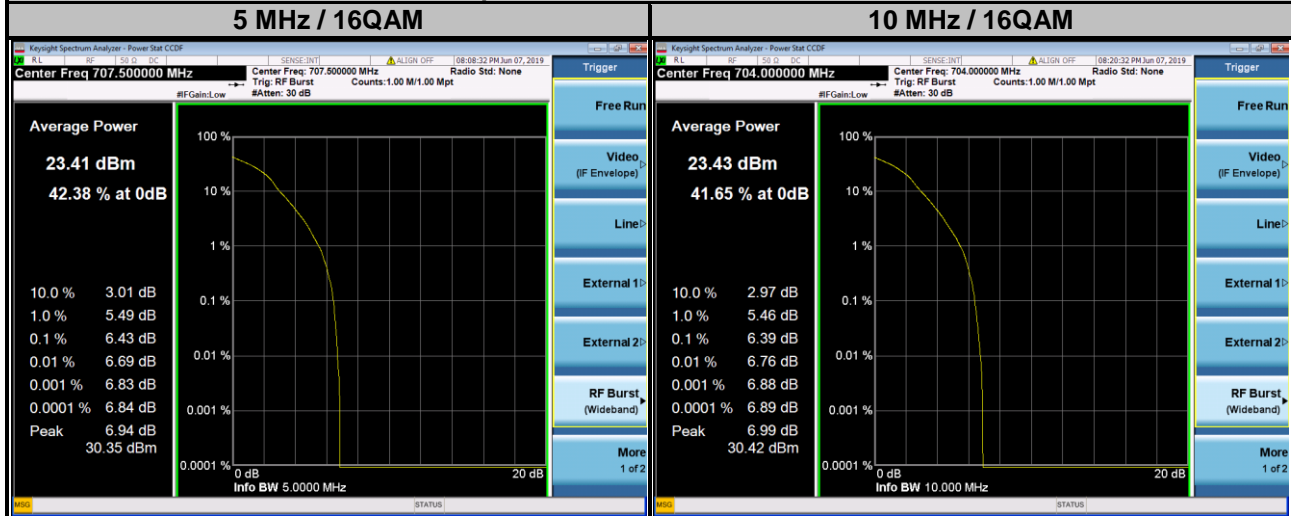

### LTE Band 13

Channel Bandwidth: 5 MHz				Channel Bandwidth: 10 MHz			
Channel	Frequency (MHz)	Peak to Average Ratio (dB)		Channel	Frequency (MHz)	Peak to Average Ratio (dB)	
		QPSK	16QAM			QPSK	16QAM
23205	779.5	4.36	4.38	23230	782.0	5.30	5.02
23230	782.0	4.35	4.36				
23255	784.5	4.46	4.32				

### Spectrum Plot of Worst Value

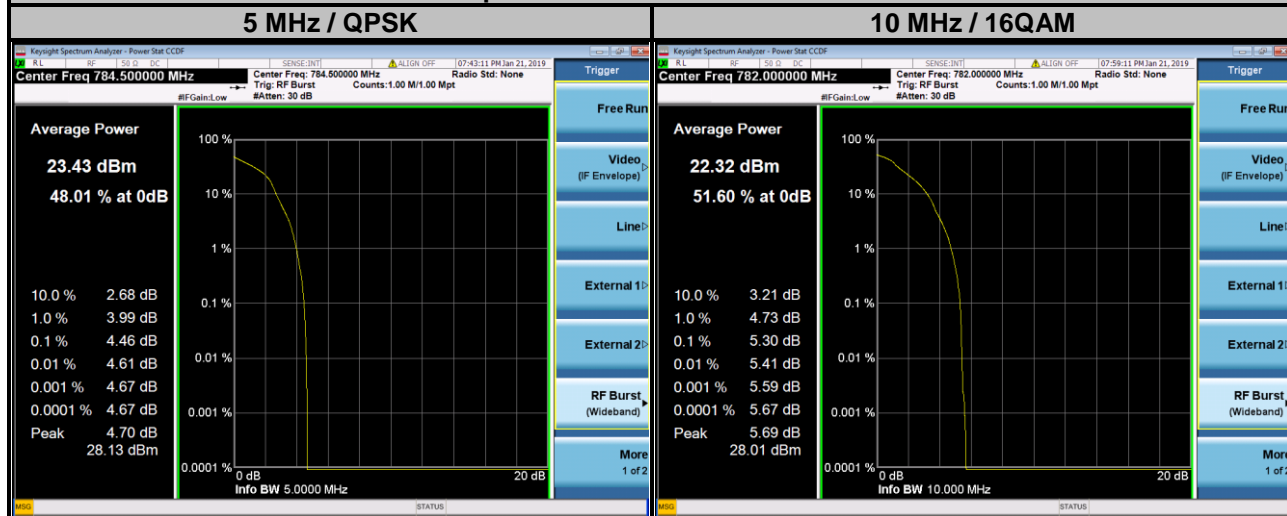

## 4.7 Conducted Spurious Emissions

### 4.7.1 Limits of Conducted Spurious Emissions Measurement

The power of any emission outside a licensee's frequency block shall be attenuated below the transmitter power (P) by at least  $43 + 10 \log (P)$  dB. The limit of emission is equal to -13 dBm.

### 4.7.2 Test Setup

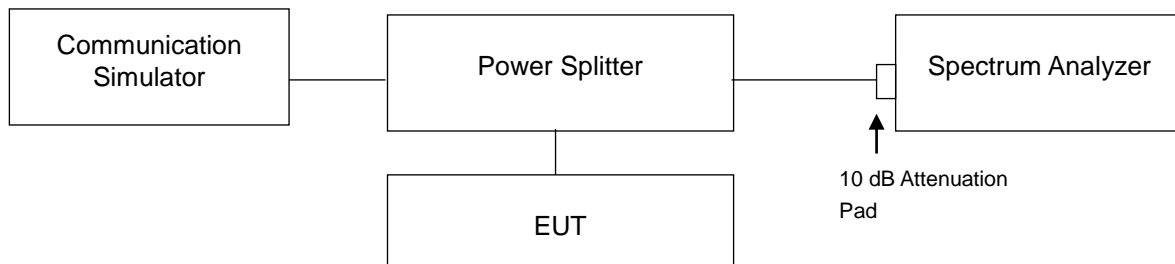

### 4.7.3 Test Procedure

- The EUT makes a phone call to the communication simulator. All measurements were done at low, middle and high operational frequency range.
- Measuring frequency range is from 9 kHz to 1 GHz. 10 dB attenuation pad is connected with spectrum. RBW = 100 kHz and VBW = 300 kHz is used for conducted emission measurement.
- Measuring frequency range is from 1 GHz to 8 GHz / 18 GHz. 10 dB attenuation pad is connected with spectrum. RBW = 1 MHz and VBW = 3 MHz is used for conducted emission measurement.

#### 4.7.4 Test Results

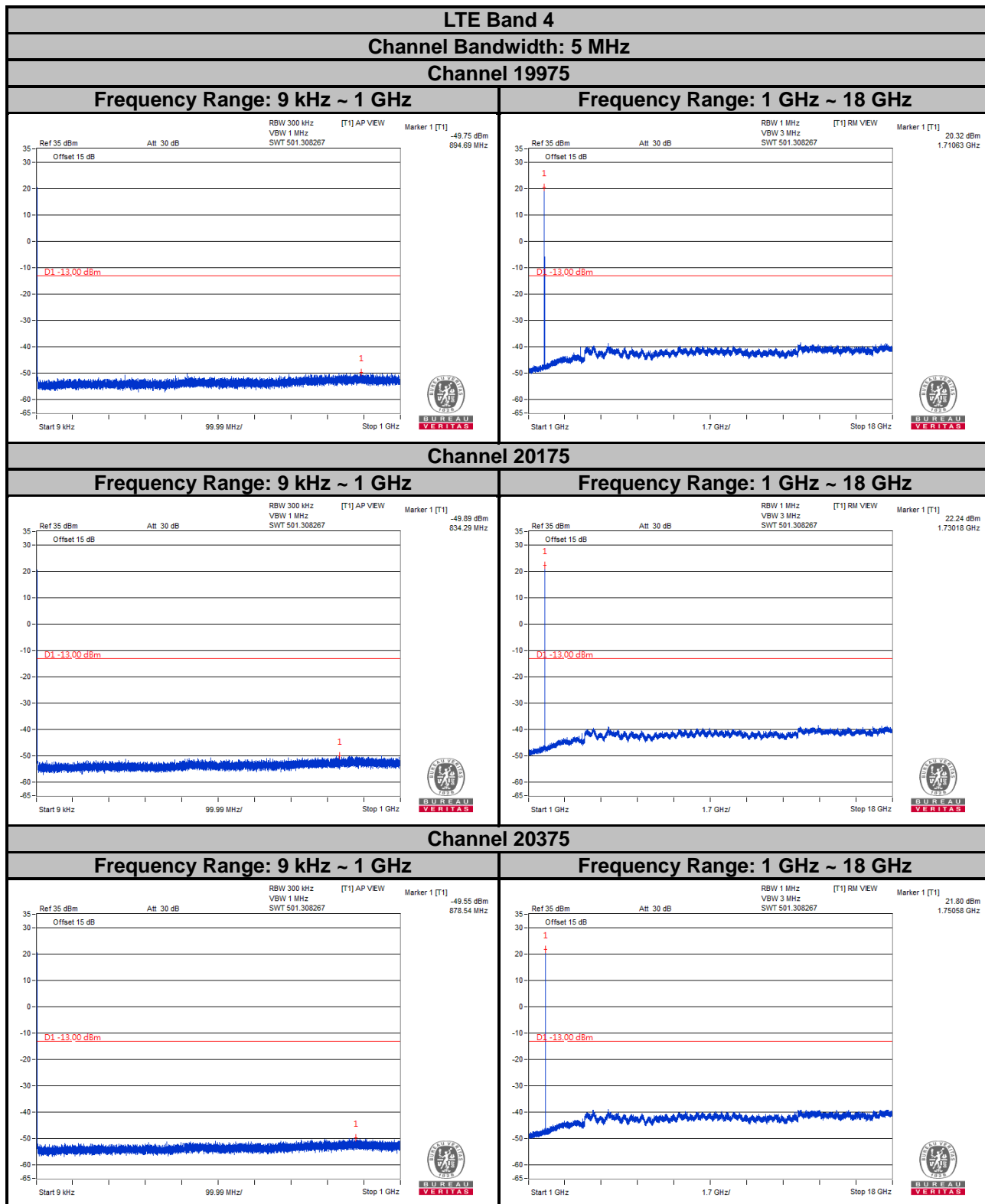

Note: The signal over the limit in 9 kHz is from spectrum analyzer.



**LTE Band 4**  
**Channel Bandwidth: 10 MHz**  
**Channel 20000**

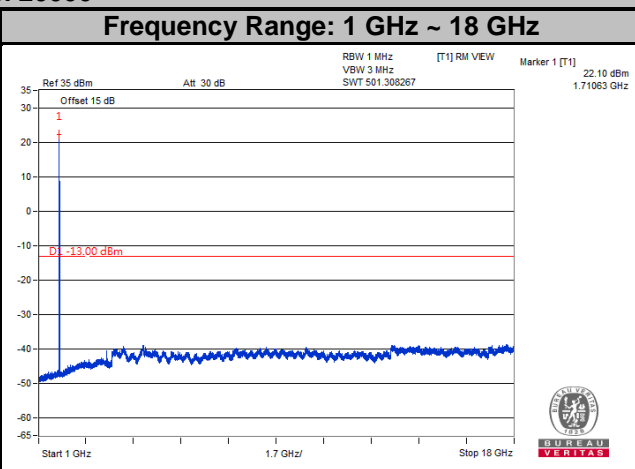
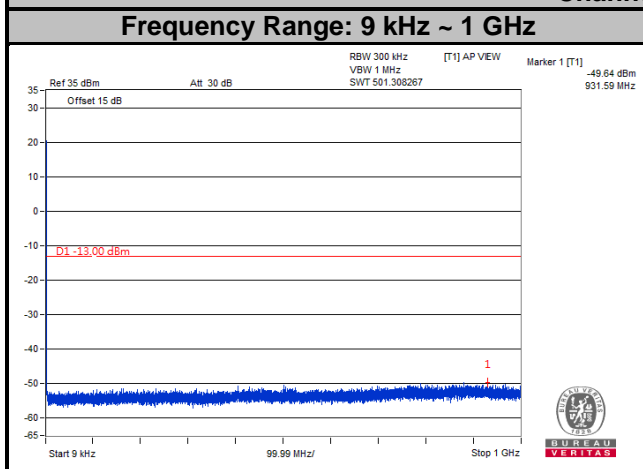

**Channel 17175**

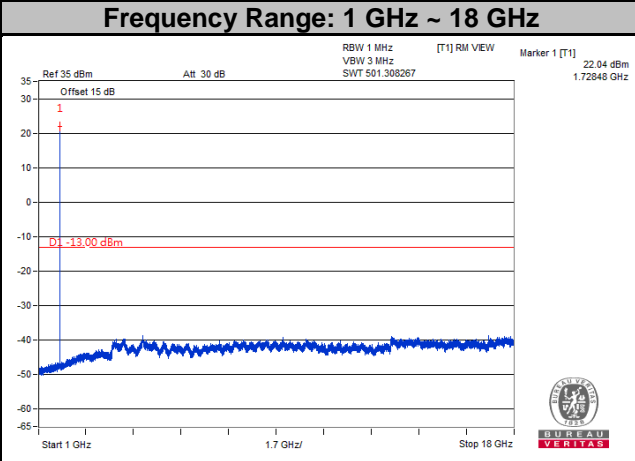
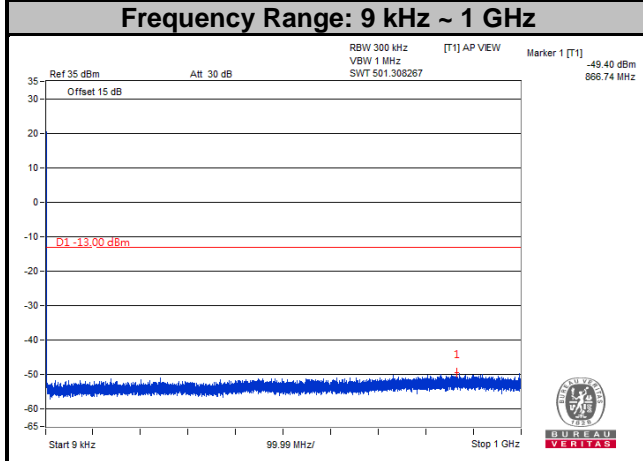

**Channel 20350**

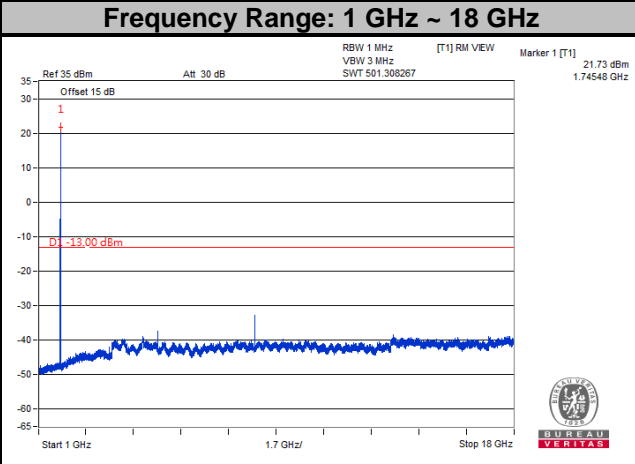
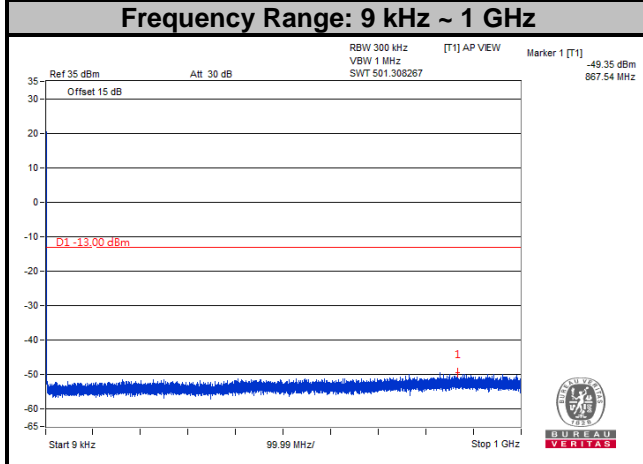

Note: The signal over the limit in 9 kHz is from spectrum analyzer.

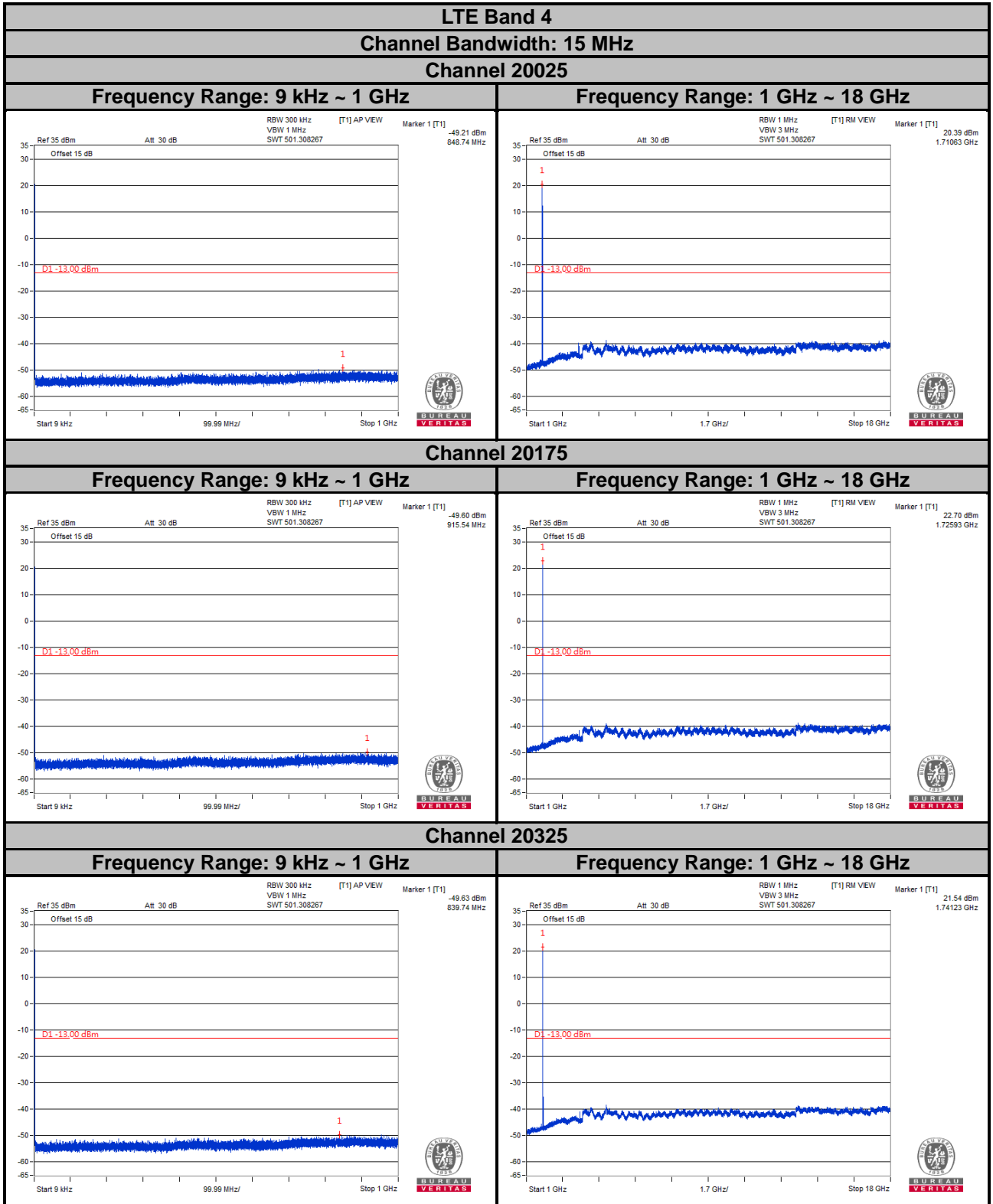

Note: The signal over the limit in 9 kHz is from spectrum analyzer.

**LTE Band 4**  
**Channel Bandwidth: 20 MHz**  
**Channel 20050**

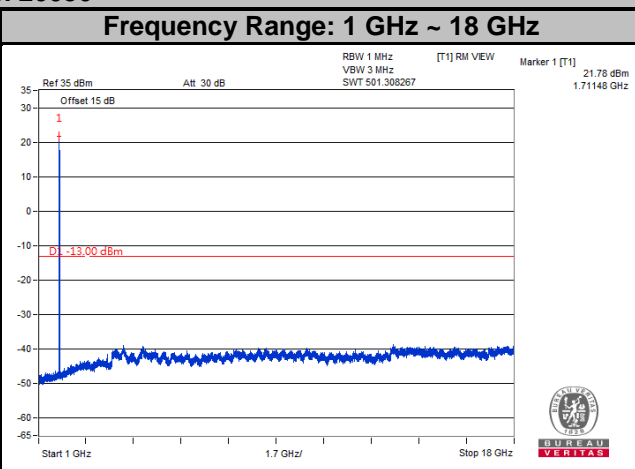
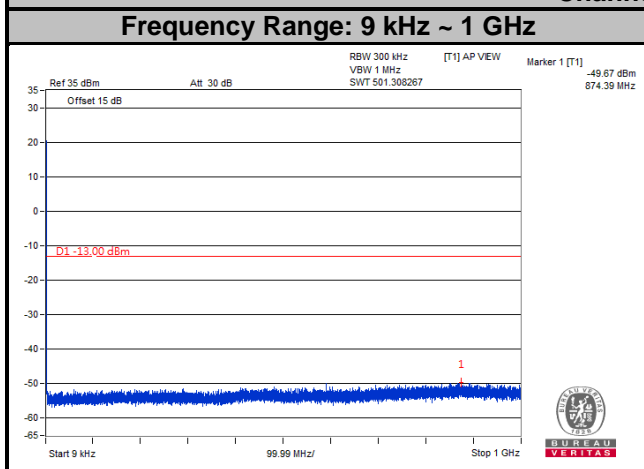

**Channel 20175**

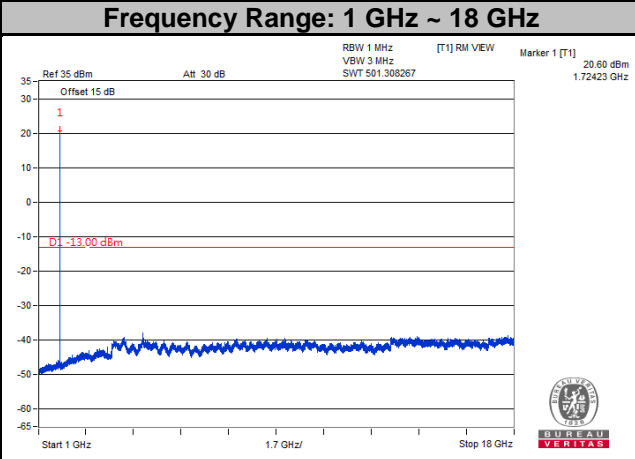
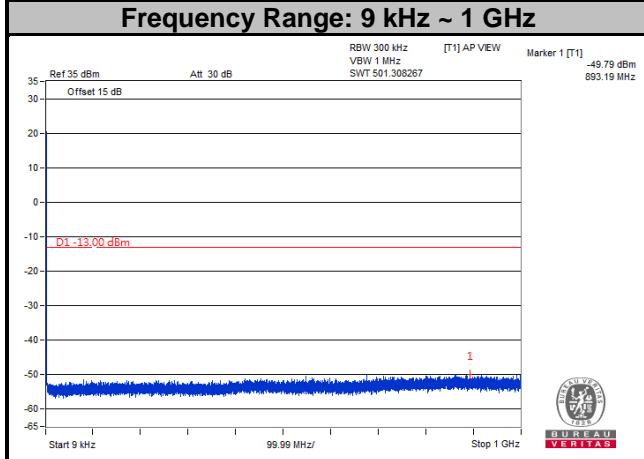

**Channel 20300**

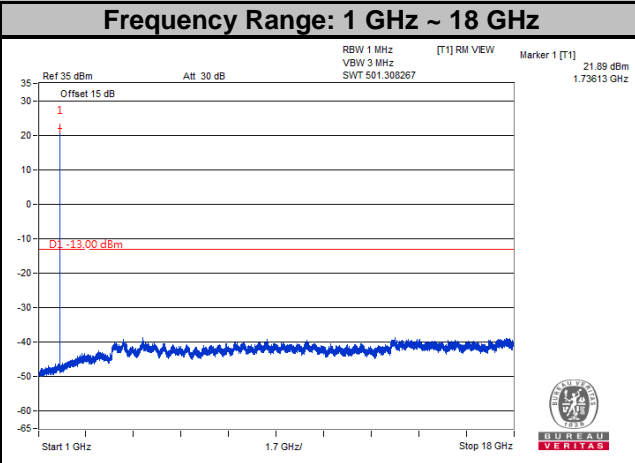
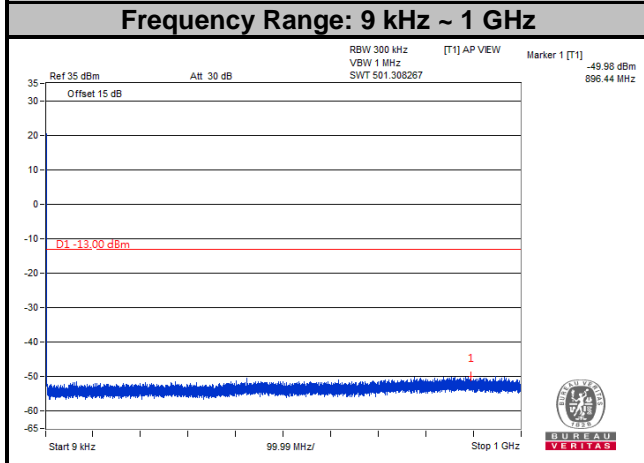

Note: The signal over the limit in 9 kHz is from spectrum analyzer.

**LTE Band 12**  
**Channel Bandwidth: 5 MHz**  
**Channel 23035**

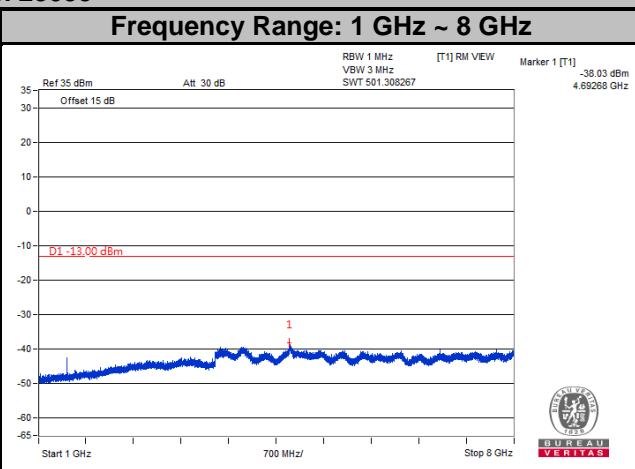
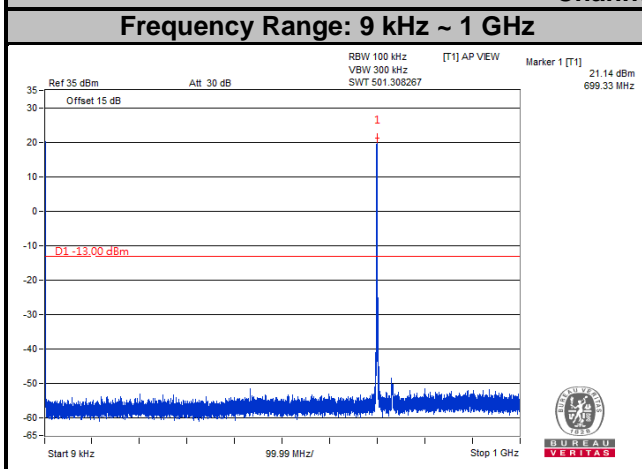

**Channel 23095**

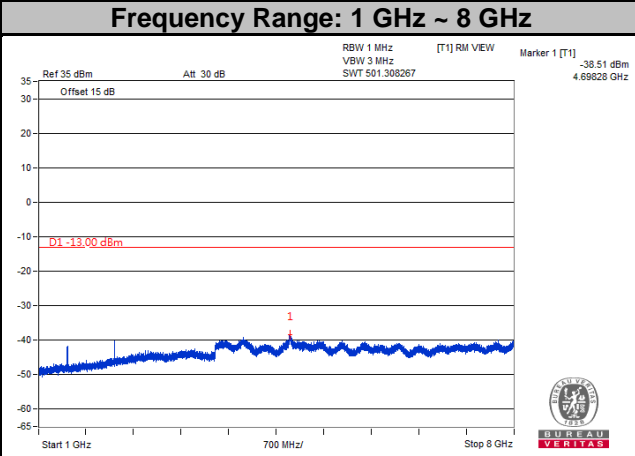
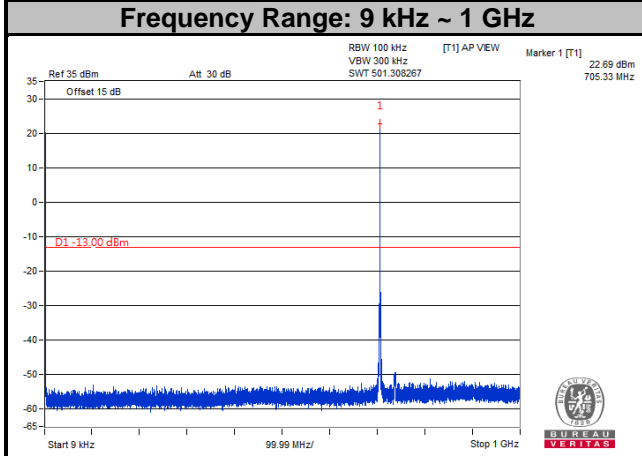

**Channel 23155**

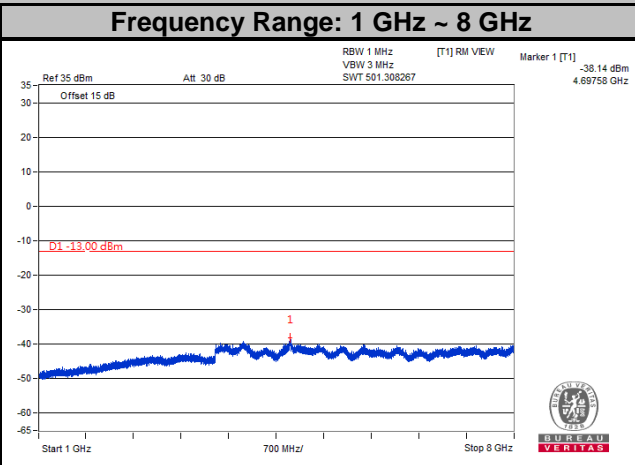
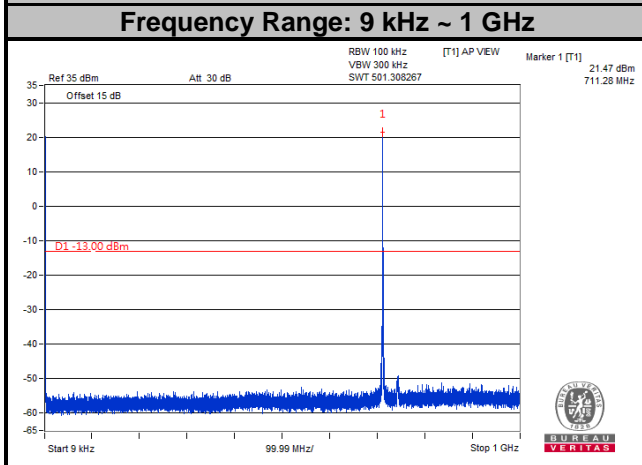

Note: The signal over the limit in 9 kHz is from spectrum analyzer.

**LTE Band 12**  
**Channel Bandwidth: 10 MHz**  
**Channel 23060**

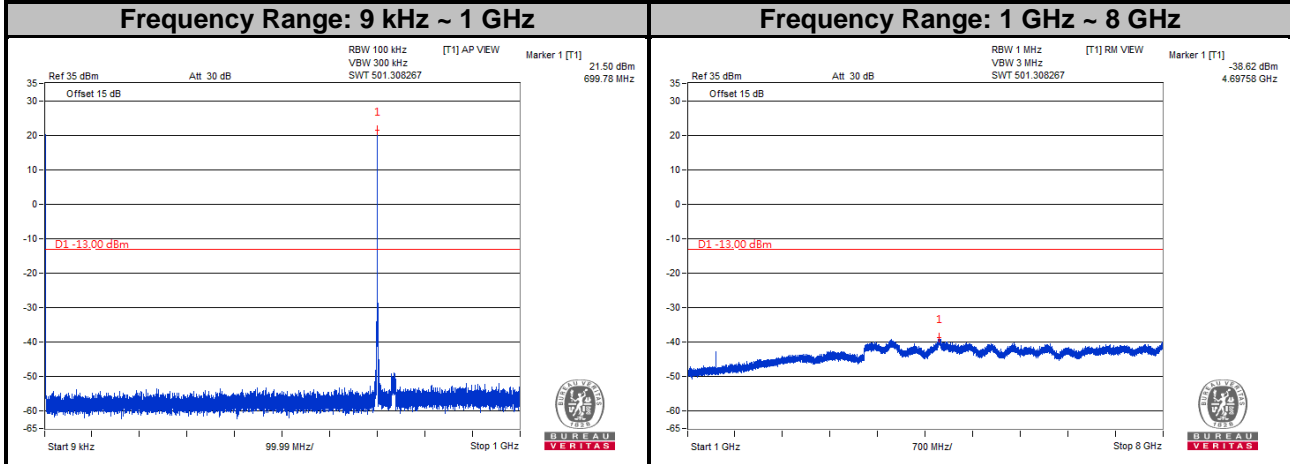

**Channel 23095**

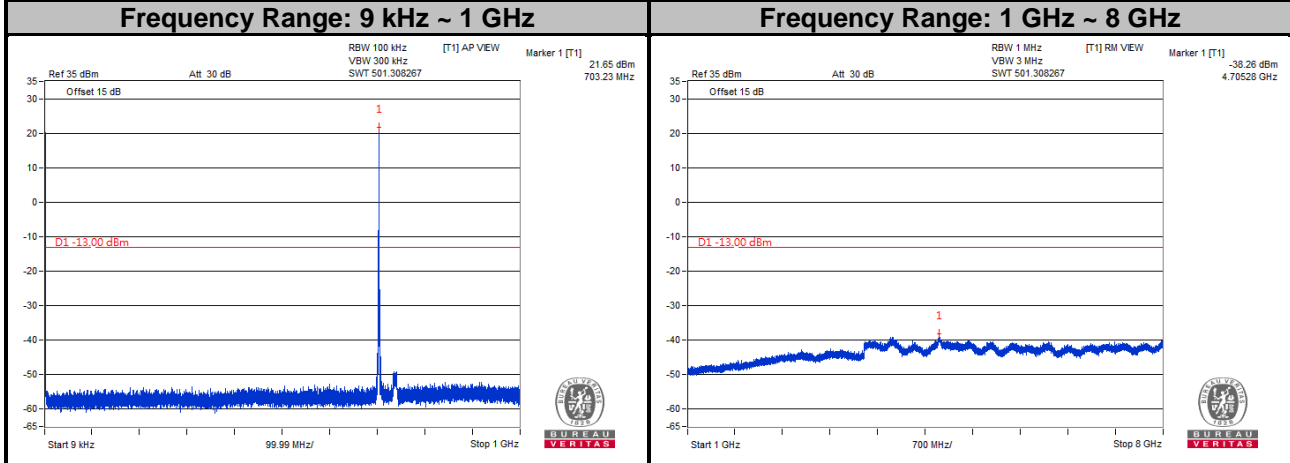

**Channel 23130**

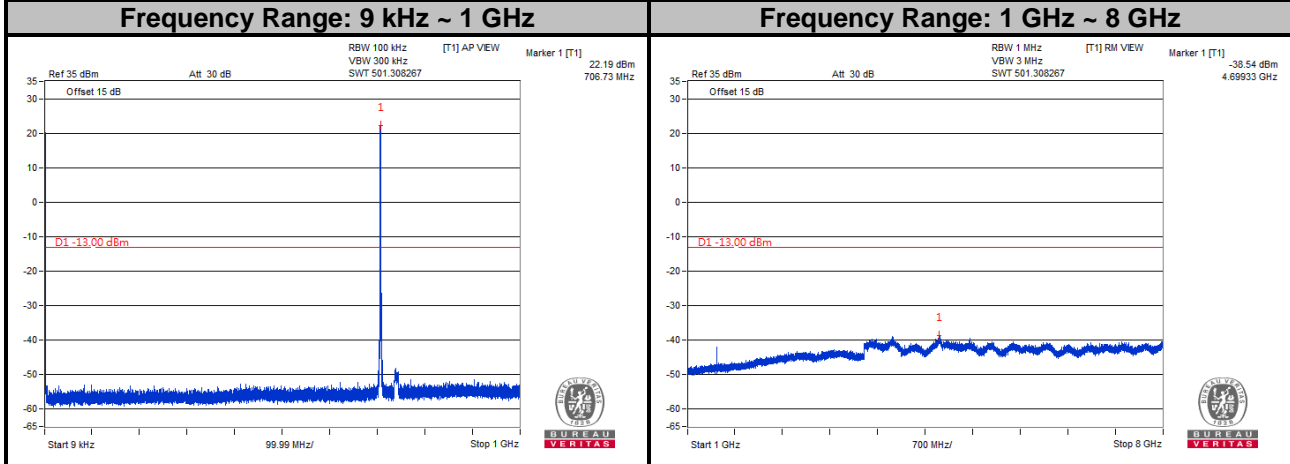

Note: The signal over the limit in 9 kHz is from spectrum analyzer.

**LTE Band 13**

**Channel Bandwidth: 5 MHz**

**Channel 23205**

**Frequency Range: 9 kHz ~ 1 GHz**

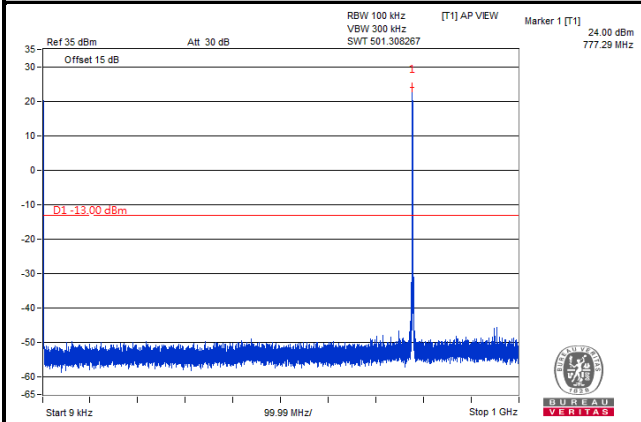

**Frequency Range: 1 GHz ~ 1.559 GHz**

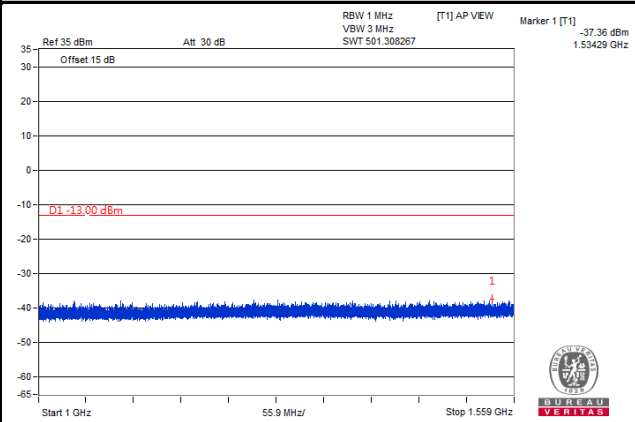

**Frequency Range: 1.559 GHz ~ 1.61 GHz**

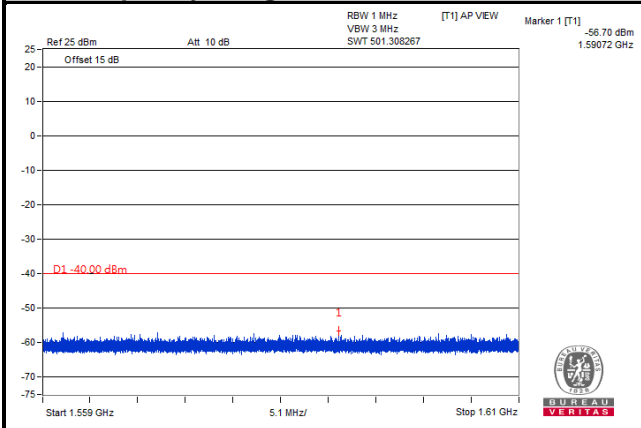

**Frequency Range: 1.61 GHz ~ 8 GHz**

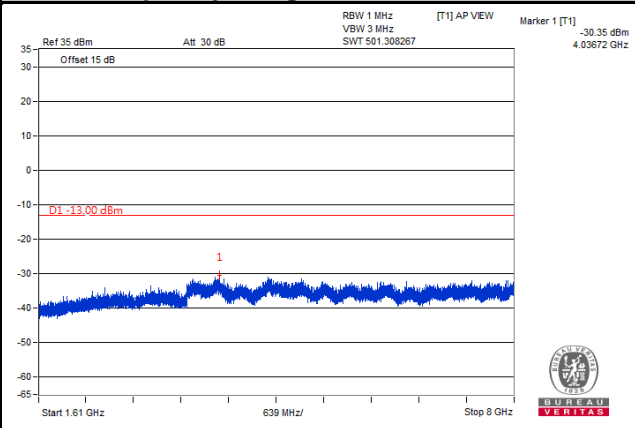

Note: The signal over the limit in 9 kHz is from spectrum analyzer.

LTE Band 13

Channel Bandwidth: 5 MHz

Channel 23230

Frequency Range: 9 kHz ~ 1 GHz

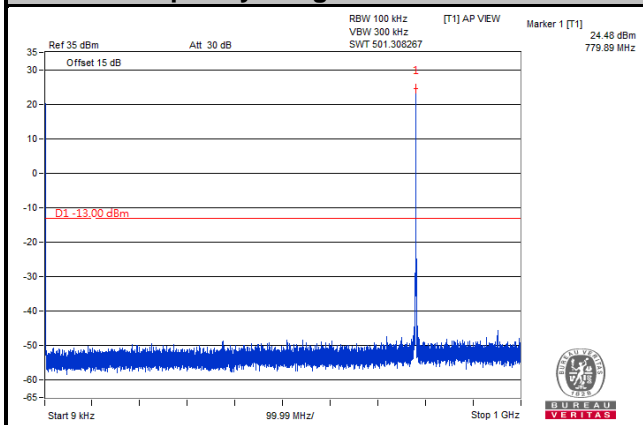

Frequency Range: 1 GHz ~ 1.559 GHz

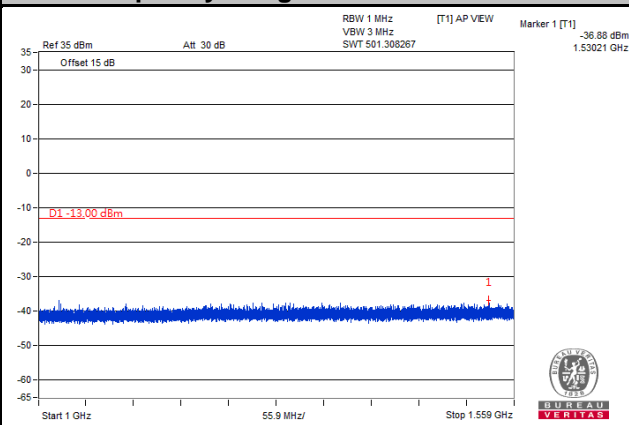

Frequency Range: 1.559 GHz ~ 1.61 GHz

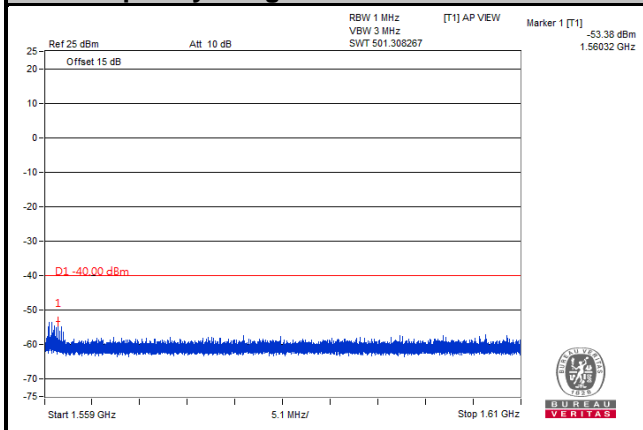

Frequency Range: 1.61 GHz ~ 8 GHz

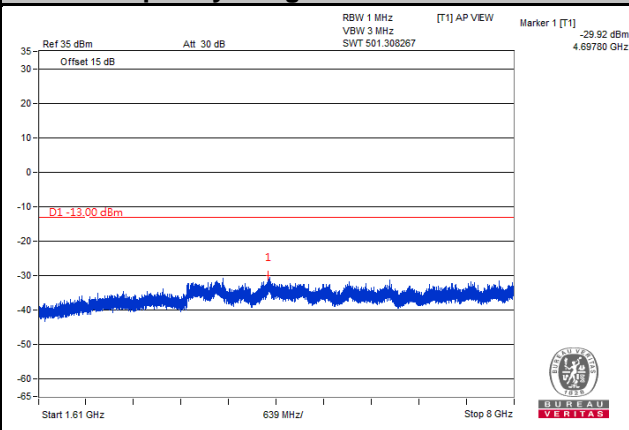

Note: The signal over the limit in 9 kHz is from spectrum analyzer.

LTE Band 13

Channel Bandwidth: 5 MHz

Channel 23255

Frequency Range: 9 kHz ~ 1 GHz

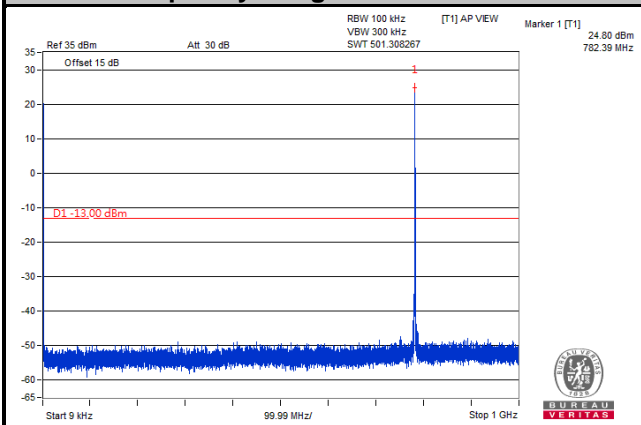

Frequency Range: 1 GHz ~ 1.559 GHz

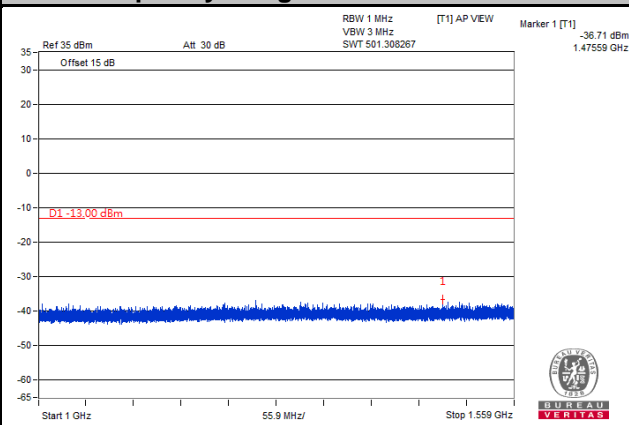

Frequency Range: 1.559 GHz ~ 1.61 GHz

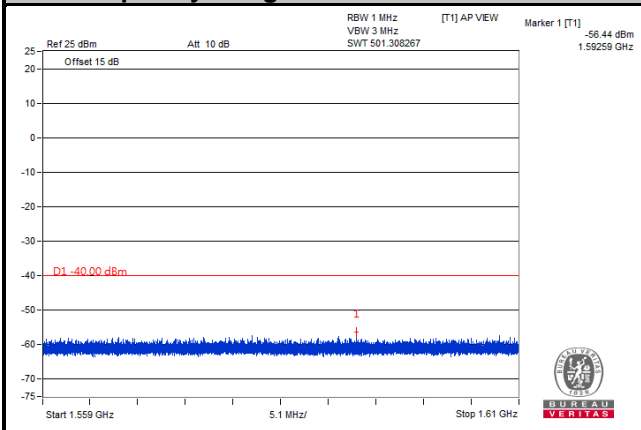

Frequency Range: 1.61 GHz ~ 8 GHz

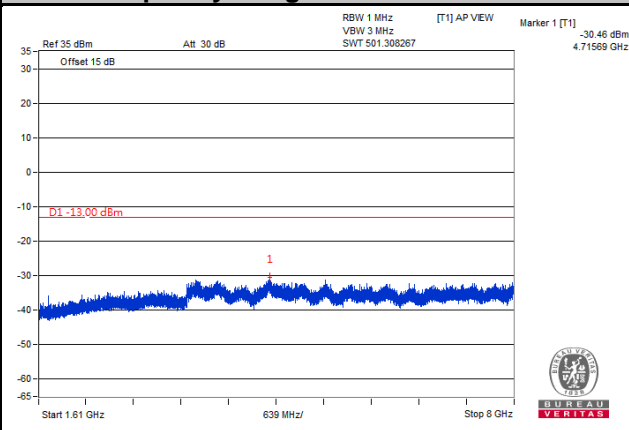

Note: The signal over the limit in 9 kHz is from spectrum analyzer.



LTE Band 13

Channel Bandwidth: 10 MHz

Channel 23230

Frequency Range: 9 kHz ~ 1 GHz

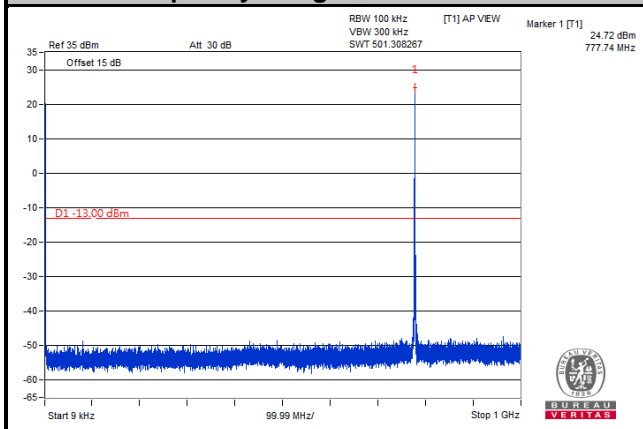

Frequency Range: 1 GHz ~ 1.559 GHz

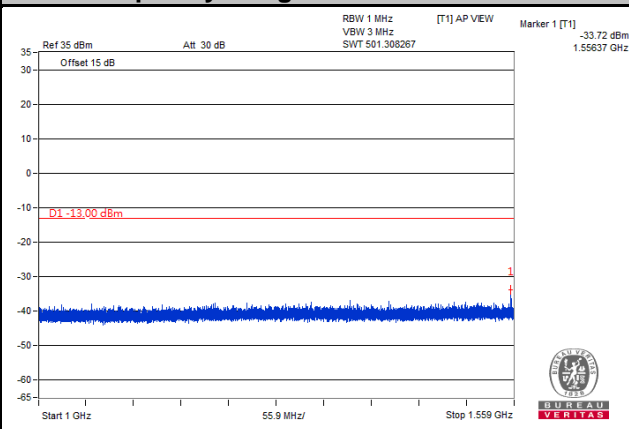

Frequency Range: 1.559 GHz ~ 1.61 GHz

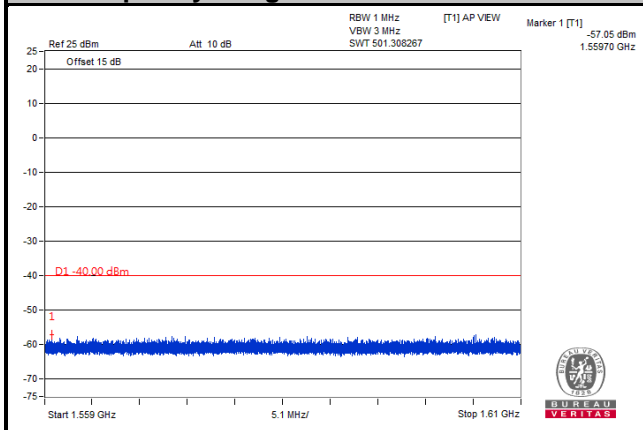

Frequency Range: 1.61 GHz ~ 8 GHz

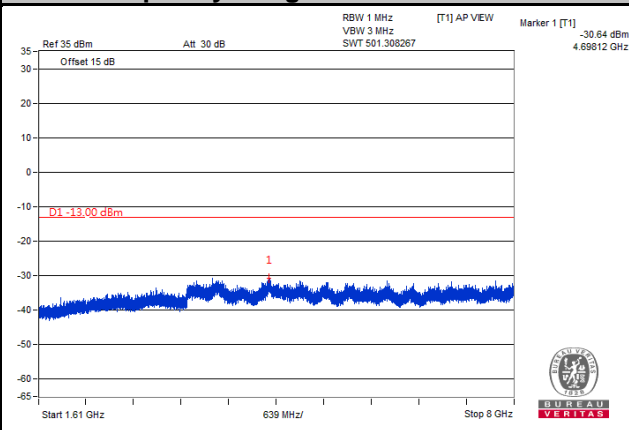

Note: The signal over the limit in 9 kHz is from spectrum analyzer.

## 4.8 Radiated Emission Measurement

### 4.8.1 Limits of Radiated Emission Measurement

- a. The power of any emission outside a licensee's frequency block shall be attenuated below the transmitter power (P) by at least  $43 + 10 \log (P)$  dB. The limit of emission is equal to -13 dBm.
- b. For operations in the 775-788 MHz, emissions in the band 1559-1610 MHz shall be limited to -70 dBW/MHz. The limit of emissions is equal to -40 dBm.

### 4.8.2 Test Procedure

- a. Substitution method is used for E.I.R.P measurement. In the semi-anechoic chamber, EUT placed on the 0.8 m (below or equal 1 GHz) and/or 1.5 m (above 1 GHz) height of Turn Table, rotated the table around 360 degrees to search the maximum radiation power and receiver antenna shall be rotated vertical and horizontal polarization and moved height from 1 m to 4 m to find the maximum polar radiated power. The "Read Value" is the spectrum reading the maximum power value.
- b. The substitution horn antenna is substituted for EUT at the same position and signals generator export the CW signal to the substitution antenna via a TX cable. Rotated the Turn Table and moved receiving antenna to find the maximum radiation power. Adjust output power level of S.G to get a Value of spectrum reading equal to "Read Value" of step a. Record the power level of S.G.
- c.  $EIRP = \text{Output power level of S.G} - \text{TX cable loss} + \text{Antenna gain of substitution horn}$ .
- d. E.R.P power can be calculated form E.I.R.P power by subtracting the gain of dipole,  $E.R.P \text{ power} = E.I.R.P \text{ power} - 2.15 \text{ dB}$ .

**Note:** The resolution bandwidth of spectrum analyzer is 1 MHz and the video bandwidth is 3 MHz.

### 4.8.3 Deviation from Test Standard

No deviation.

#### 4.8.4 Test Setup

##### <Radiated Emission below or equal 1 GHz>

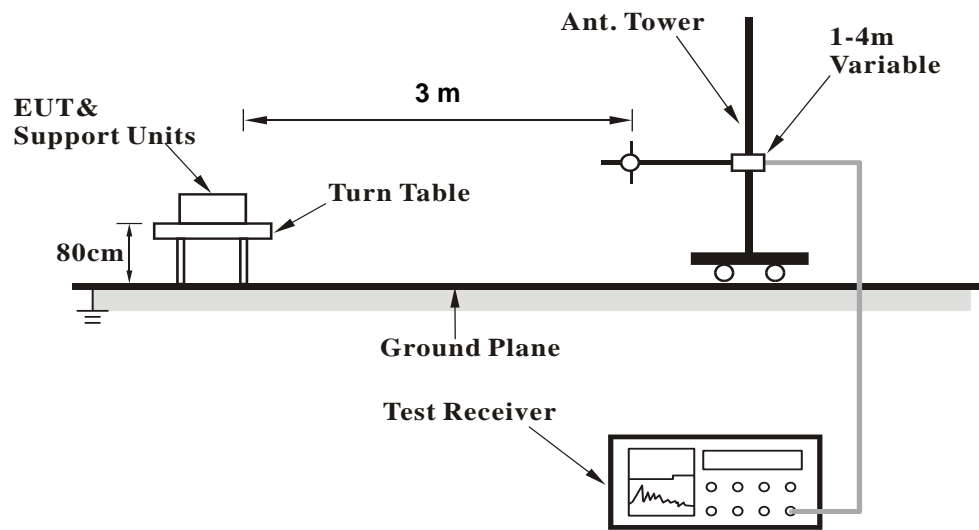

##### <Radiated Emission above 1 GHz>

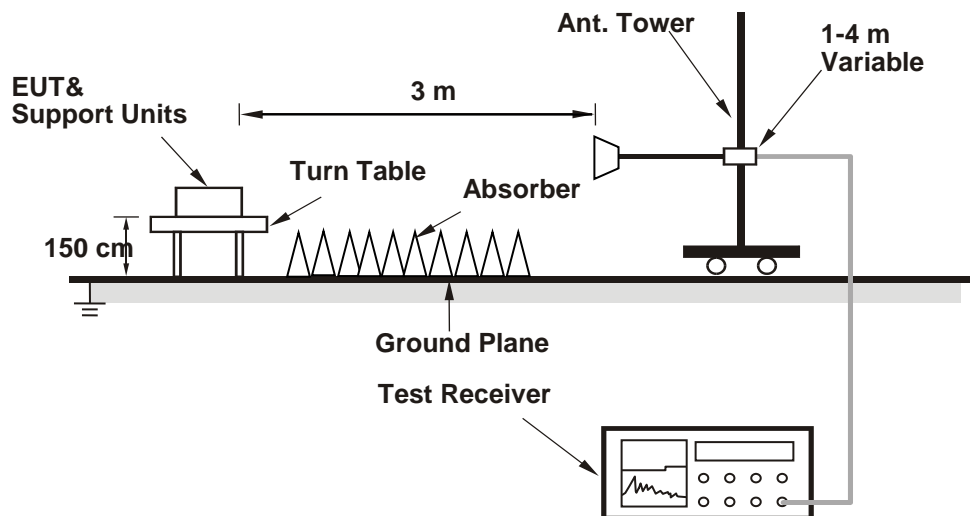

For the actual test configuration, please refer to the attached file (Test Setup Photo).

4.8.5 Test Results

LTE Band 4

Channel Bandwidth: 5 MHz / QPSK

Low Channel

Bureau Veritas Consumer Products Services Ltd., Taoyuan



A D T

Data: 3

Date: 03-23-2019

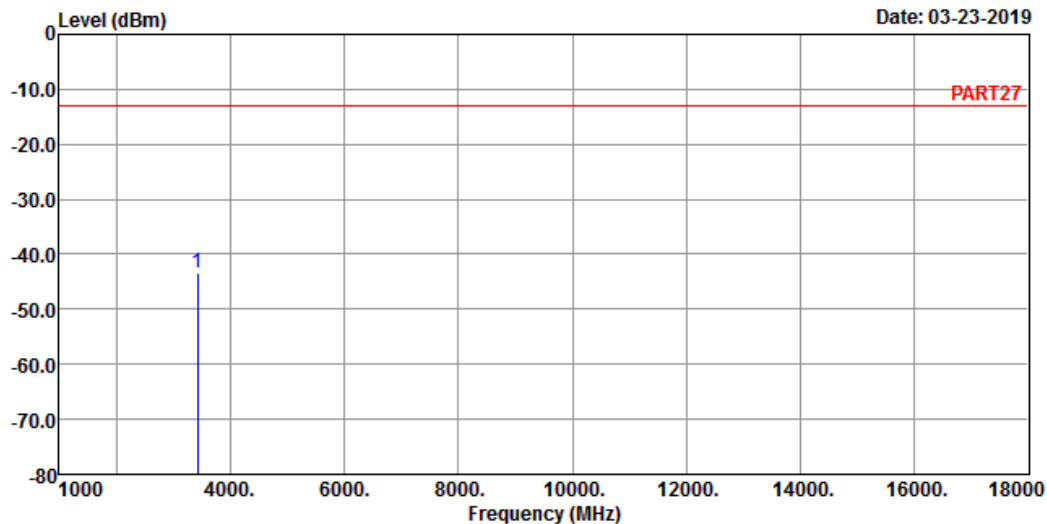

Site : 966 Chamber 5  
 Condition: PART27 HORIZONTAL  
 Remak : Cat-M1 Band 4 QPSK\_5M Link\_L-CH  
 Tested by: Thomas Wei

Freq	Level	Read Level	Limit	Line Factor	Over Limit	Remark
MHz	dBm	dBm	dBm	dB	dB	

1 pp 3425.00 -43.52 -35.18 -13.00 -8.34 -30.52 Peak

Bureau Veritas Consumer Products Services Ltd., Taoyuan



A D T

Data: 4

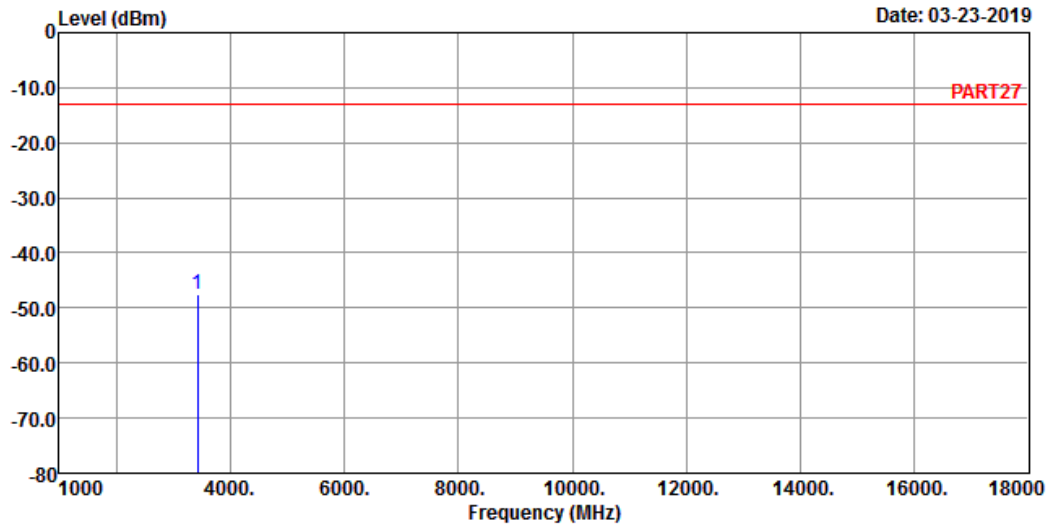

Site : 966 Chamber 5  
 Condition: PART27 VERTICAL  
 Remak : Cat-M1 Band 4 QPSK\_5M Link\_L-CH  
 Tested by: Thomas Wei

Freq	Level	Read Level	Limit	Line Factor	Over Limit	Remark
MHz	dBm	dBm	dBm	dB	dB	
1 pp 3425.00	-47.48	-39.14	-13.00	-8.34	-34.48	Peak

Middle Channel

Bureau Veritas Consumer Products Services Ltd., Taoyuan



A D T

Data: 3

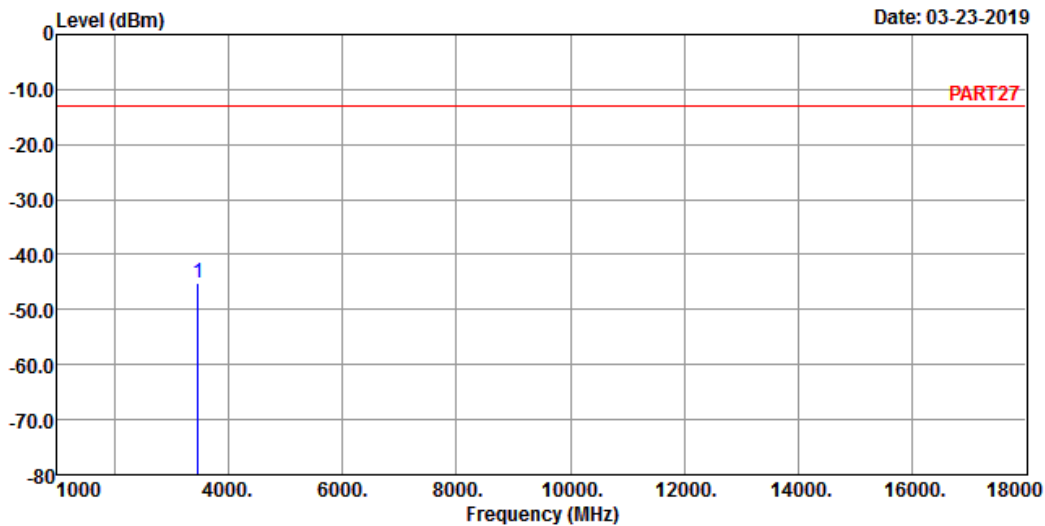

Site : 966 Chamber 5  
 Condition: PART27 HORIZONTAL  
 Remak : Cat-M1 Band 4 QPSK\_5M Link\_M-CH  
 Tested by: Thomas Wei

Freq	Level	Read Level	Limit	Line Factor	Over Limit	Remark
MHz	dBm	dBm	dBm	dB	dB	

1 pp 3465.00 -45.11 -37.23 -13.00 -7.88 -32.11 Peak

Bureau Veritas Consumer Products Services Ltd., Taoyuan



A D T

Data: 4

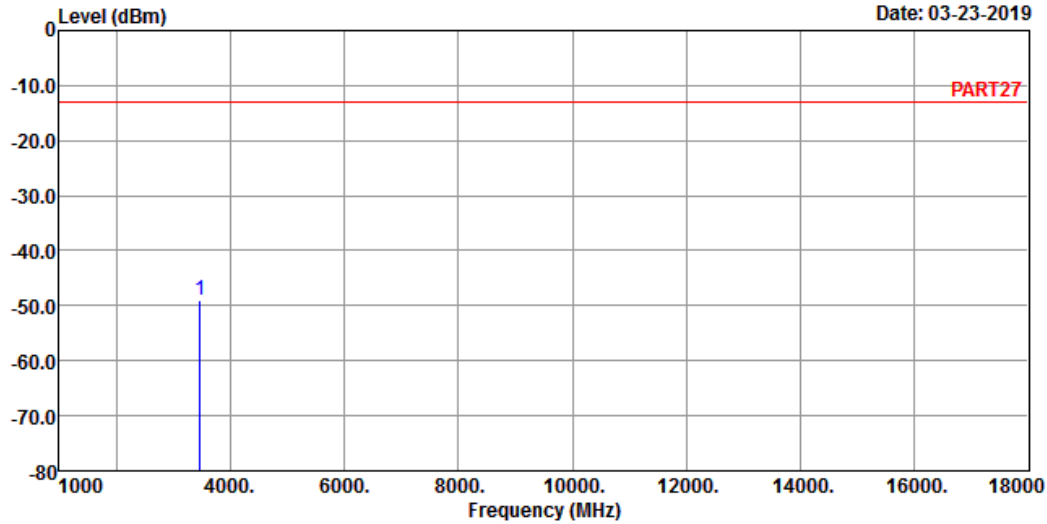

Site : 966 Chamber 5  
 Condition: PART27 VERTICAL  
 Remak : Cat-M1 Band 4 QPSK\_5M Link\_M-CH  
 Tested by: Thomas Wei

Freq	Level	Read Level	Limit	Line Factor	Over Limit	Remark
MHz	dBm	dBm	dBm	dB	dB	
1 pp 3465.00	-48.89	-41.01	-13.00	-7.88	-35.89	Peak

High Channel

Bureau Veritas Consumer Products Services Ltd., Taoyuan



A D T

Data: 3

Date: 03-23-2019

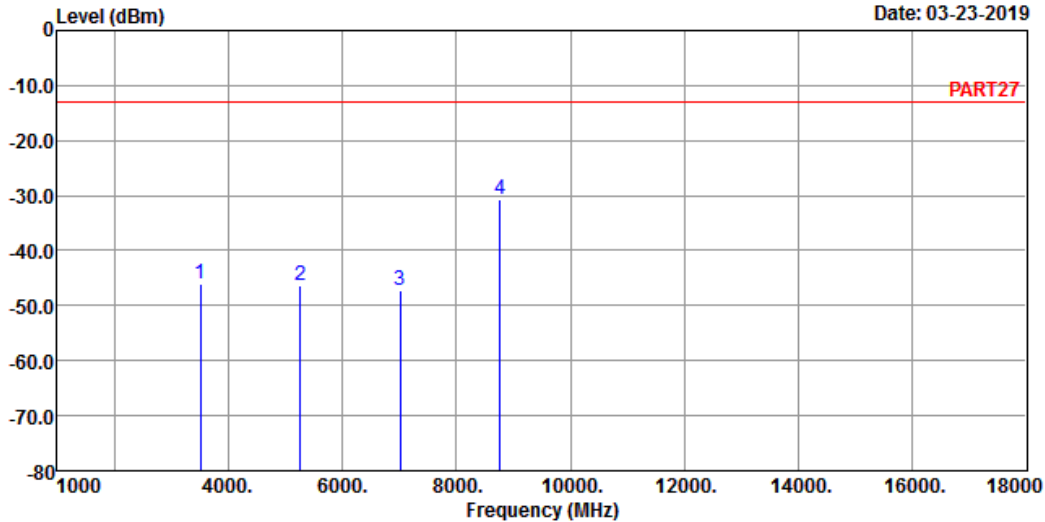

Site : 966 Chamber 5  
 Condition: PART27 HORIZONTAL  
 Remak : Cat-M1 Band 4 QPSK\_5M Link\_H-CH  
 Tested by: Thomas Wei

	Freq	Level	Read Level	Limit	Line Factor	Over Limit	Remark
	MHz	dBm	dBm	dBm	dB	dB	
1	3505.00	-46.12	-38.67	-13.00	-7.45	-33.12	Peak
2	5257.50	-46.22	-43.70	-13.00	-2.52	-33.22	Peak
3	7010.00	-47.33	-50.52	-13.00	3.19	-34.33	Peak
4 pp	8762.50	-30.70	-35.43	-13.00	4.73	-17.70	Peak



Bureau Veritas Consumer Products Services Ltd., Taoyuan



A D T

Data: 4

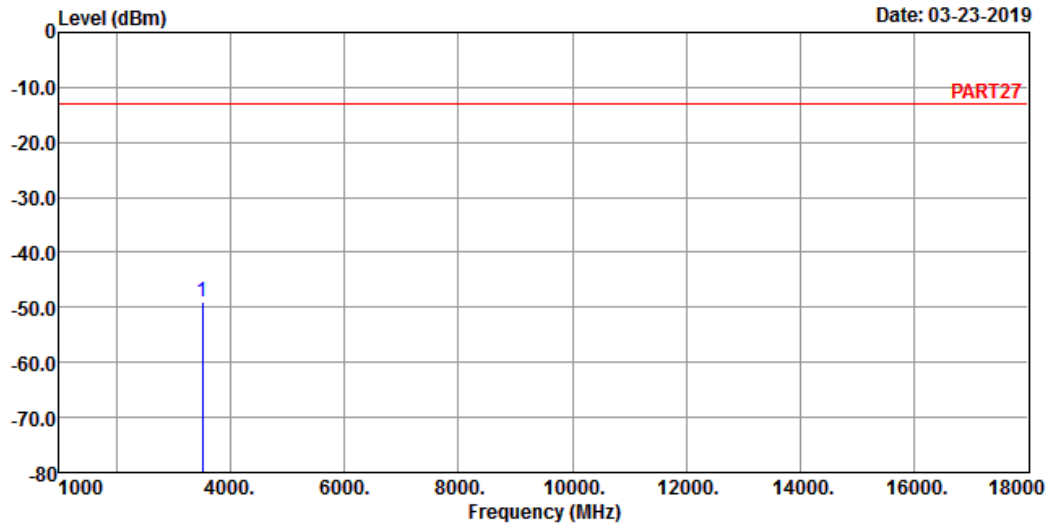

Site : 966 Chamber 5  
 Condition: PART27 VERTICAL  
 Remak : Cat-M1 Band 4 QPSK\_5M Link\_H-CH  
 Tested by: Thomas Wei

Freq	Level	Read Level	Limit	Line Factor	Over Limit	Remark
MHz	dBm	dBm	dBm	dB	dB	
1 pp 3505.00	-49.01	-41.56	-13.00	-7.45	-36.01	Peak

Channel Bandwidth: 20 MHz / QPSK  
Low Channel

Bureau Veritas Consumer Products Services Ltd., Taoyuan



A D T

Data: 3

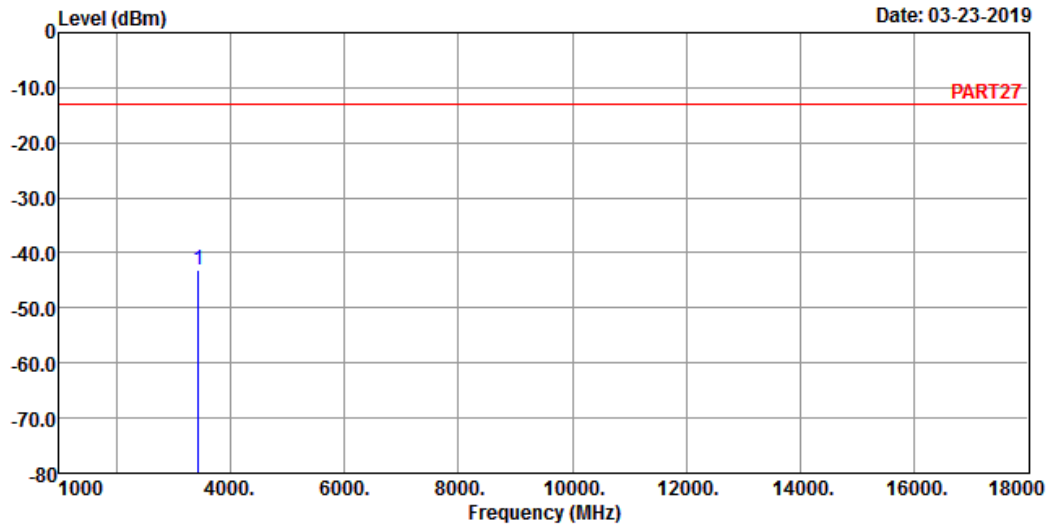

Site : 966 Chamber 5  
Condition: PART27 HORIZONTAL  
Remak : Cat-M1 Band 4 QPSK\_20M Link\_L-CH  
Tested by: Thomas Wei

Freq	Level	Read Level	Limit	Line Factor	Over Limit	Remark
MHz	dBm	dBm	dBm	dB	dB	
1 pp 3440.00	-43.00	-34.78	-13.00	-8.22	-30.00	Peak

Bureau Veritas Consumer Products Services Ltd., Taoyuan



A D T

Data: 4

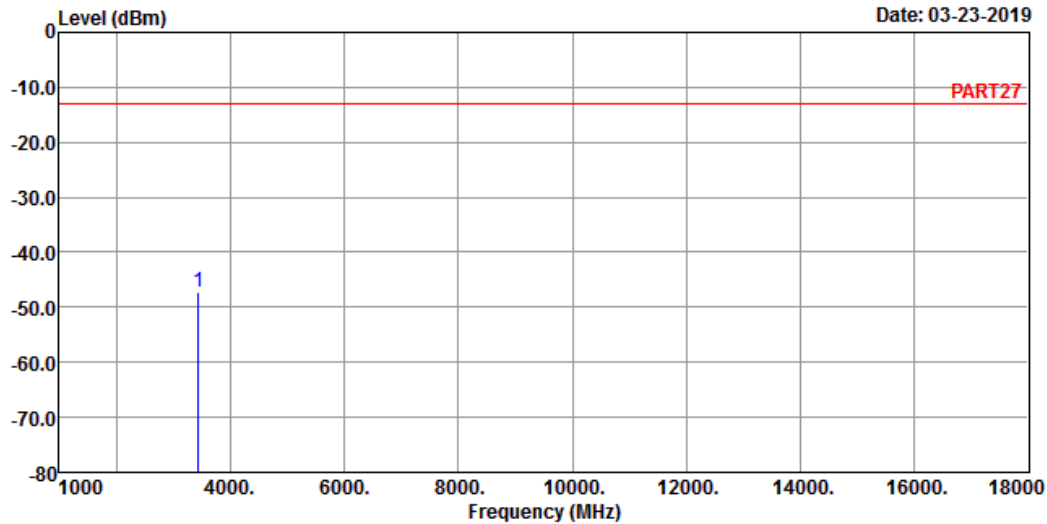

Site : 966 Chamber 5  
 Condition: PART27 VERTICAL  
 Remak : Cat-M1 Band 4 QPSK\_20M Link\_L-CH  
 Tested by: Thomas Wei

Freq	Level	Read Level	Limit	Line Factor	Over Limit	Remark
MHz	dBm	dBm	dBm	dB	dB	
1 pp 3440.00	-47.09	-38.87	-13.00	-8.22	-34.09	Peak

Middle Channel

Bureau Veritas Consumer Products Services Ltd., Taoyuan



A D T

Data: 3

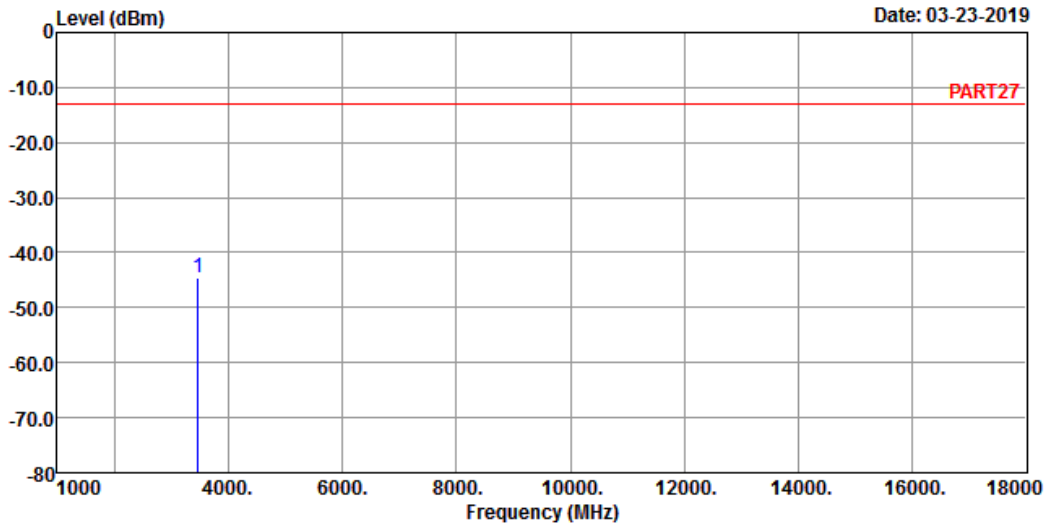

Site : 966 Chamber 5  
 Condition: PART27 HORIZONTAL  
 Remak : Cat-M1 Band 4 QPSK\_20M Link\_M-CH  
 Tested by: Thomas Wei

Freq	Level	Read Level	Limit	Line Factor	Over Limit	Remark
MHz	dBm	dBm	dBm	dB	dB	

1 pp 3465.00 -44.64 -36.76 -13.00 -7.88 -31.64 Peak

Bureau Veritas Consumer Products Services Ltd., Taoyuan



A D T

Data: 4

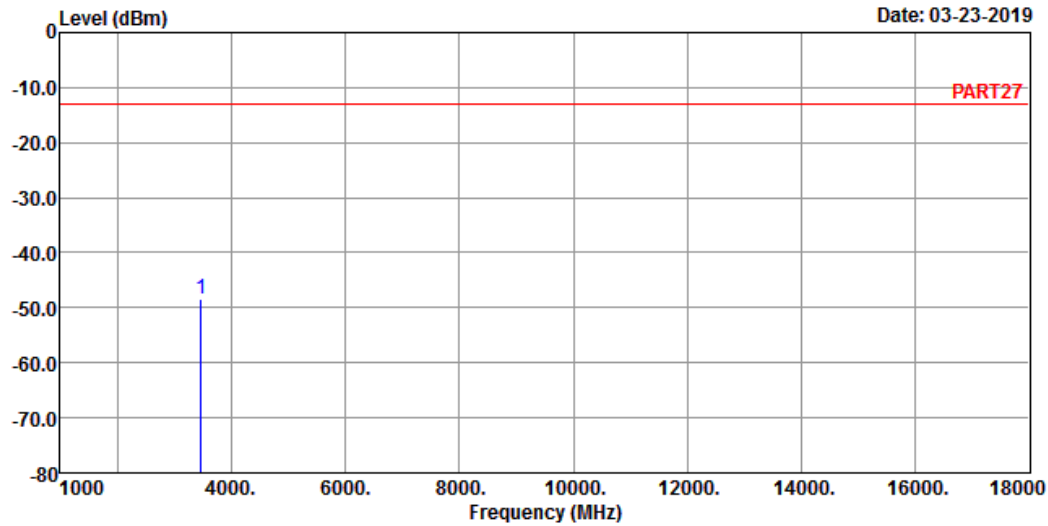

Site : 966 Chamber 5  
 Condition: PART27 VERTICAL  
 Remak : Cat-M1 Band 4 QPSK\_20M Link\_M-CH  
 Tested by: Thomas Wei

Freq	Level	Read Level	Limit	Line Factor	Over Limit	Remark
MHz	dBm	dBm	dBm	dB	dB	
1 pp 3465.00	-48.43	-40.55	-13.00	-7.88	-35.43	Peak

High Channel

Bureau Veritas Consumer Products Services Ltd., Taoyuan



A D T

Data: 5

Date: 03-23-2019

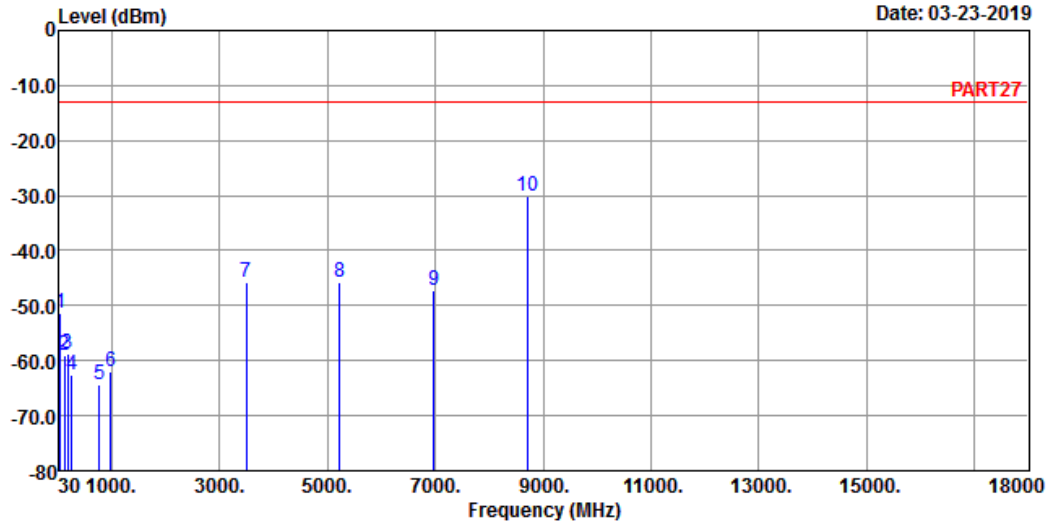

Site : 966 Chamber 5  
 Condition: PART27 HORIZONTAL  
 Remak : Cat-M1 Band 4 QPSK\_20M Link\_H-CH  
 Tested by: Thomas Wei

	Freq	Level	Read Level	Limit	Line Factor	Over Limit	Remark
	MHz	dBm	dBm	dBm	dB	dB	
1	43.58	-51.46	-49.99	-13.00	-1.47	-38.46	Peak
2	127.00	-59.02	-49.98	-13.00	-9.04	-46.02	Peak
3	191.02	-58.81	-51.63	-13.00	-7.18	-45.81	Peak
4	253.10	-62.52	-56.47	-13.00	-6.05	-49.52	Peak
5	776.90	-64.30	-65.10	-13.00	0.80	-51.30	Peak
6	987.39	-61.89	-65.02	-13.00	3.13	-48.89	Peak
7	3490.00	-45.62	-37.97	-13.00	-7.65	-32.62	Peak
8	5235.00	-45.82	-43.41	-13.00	-2.41	-32.82	Peak
9	6980.00	-47.16	-50.22	-13.00	3.06	-34.16	Peak
10 pp	8725.00	-30.25	-35.01	-13.00	4.76	-17.25	Peak

Bureau Veritas Consumer Products Services Ltd., Taoyuan



A D T

Data: 6

Date: 03-23-2019

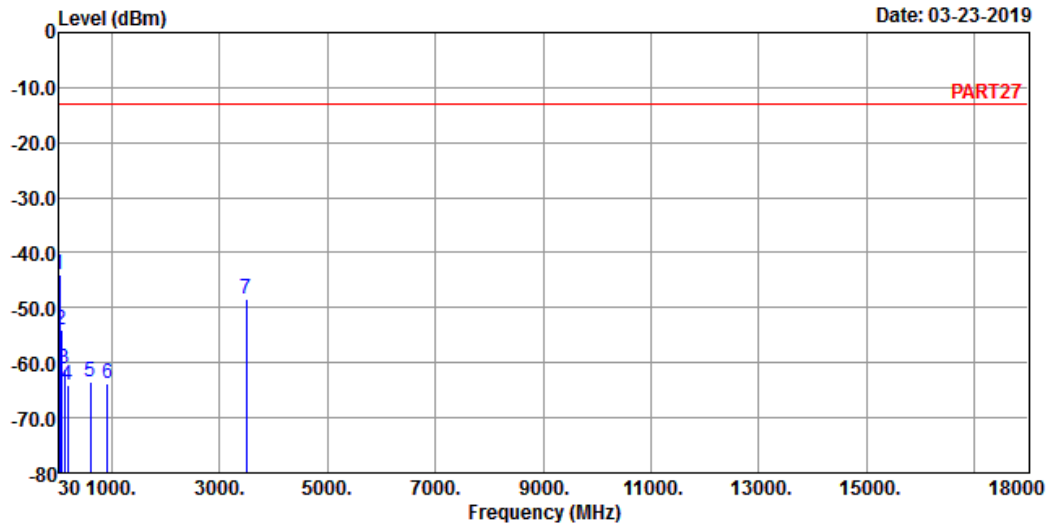

Site : 966 Chamber 5  
 Condition: PART27 VERTICAL  
 Remak : Cat-M1 Band 4 QPSK\_20M Link\_H-CH  
 Tested by: Thomas Wei

	Freq	Level	Read Level	Limit	Line	Factor	Over	Remark
	MHz	dBm	dBm	dBm		dB	dB	
1 pp	39.70	-43.99	-44.63	-13.00		0.64	-30.99	Peak
2	68.80	-53.99	-45.67	-13.00		-8.32	-40.99	Peak
3	127.97	-61.07	-52.15	-13.00		-8.92	-48.07	Peak
4	190.05	-64.09	-57.00	-13.00		-7.09	-51.09	Peak
5	603.27	-63.48	-62.72	-13.00		-0.76	-50.48	Peak
6	919.49	-63.76	-64.81	-13.00		1.05	-50.76	Peak
7	3490.00	-48.50	-40.85	-13.00		-7.65	-35.50	Peak

LTE Band 12  
Channel Bandwidth: 5 MHz / QPSK  
Low Channel

Bureau Veritas Consumer Products Services Ltd., Taoyuan



A D T

Data: 3

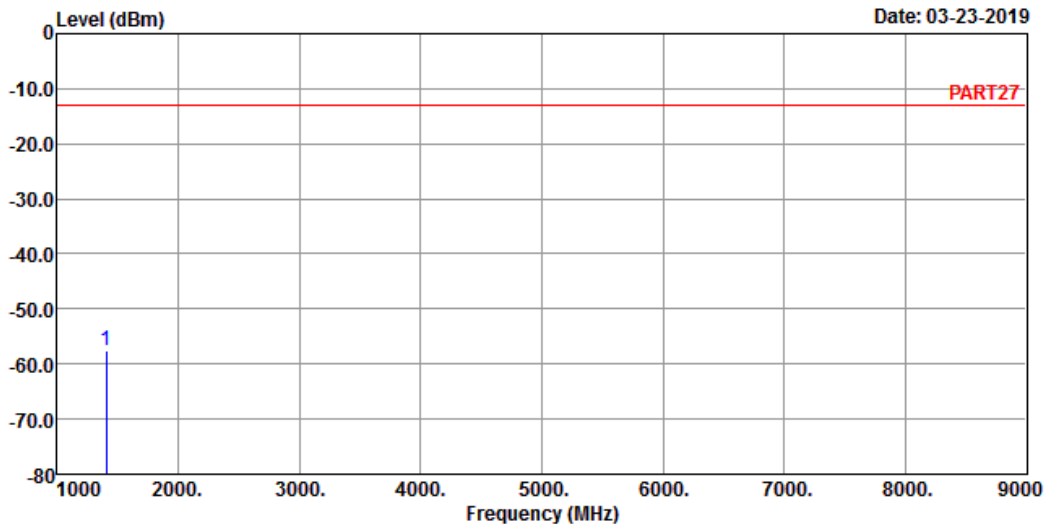

Site : 966 Chamber 5  
Condition: PART27 HORIZONTAL  
Remak : Cat-M1 Band 12 QPSK\_5M Link\_L-CH  
Tested by: Thomas Wei

Freq	Level	Read Level	Limit	Over	Remark
MHz	dBm	dBm	dBm	dB	dB
1403.00	-57.46	-45.55	-13.00	-11.91	-44.46 Peak



Bureau Veritas Consumer Products Services Ltd., Taoyuan



A D T

Data: 4

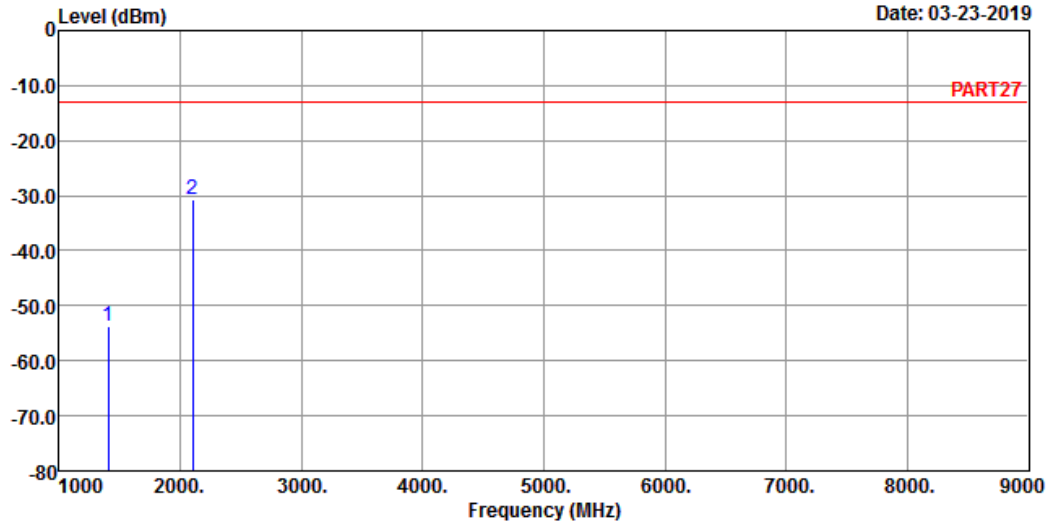

Site : 966 Chamber 5  
 Condition: PART27 VERTICAL  
 Remak : Cat-M1 Band 12 QPSK\_5M Link\_L-CH  
 Tested by: Thomas Wei

	Freq	Level	Read Level	Limit	Line Factor	Over Limit	Remark
	MHz	dBm	dBm	dBm	dB	dB	
1	1403.00	-53.83	-41.92	-13.00	-11.91	-40.83	Peak
2 pp	2104.50	-30.66	-20.50	-13.00	-10.16	-17.66	Peak

Middle Channel

Bureau Veritas Consumer Products Services Ltd., Taoyuan



A D T

Data: 3

Date: 03-23-2019

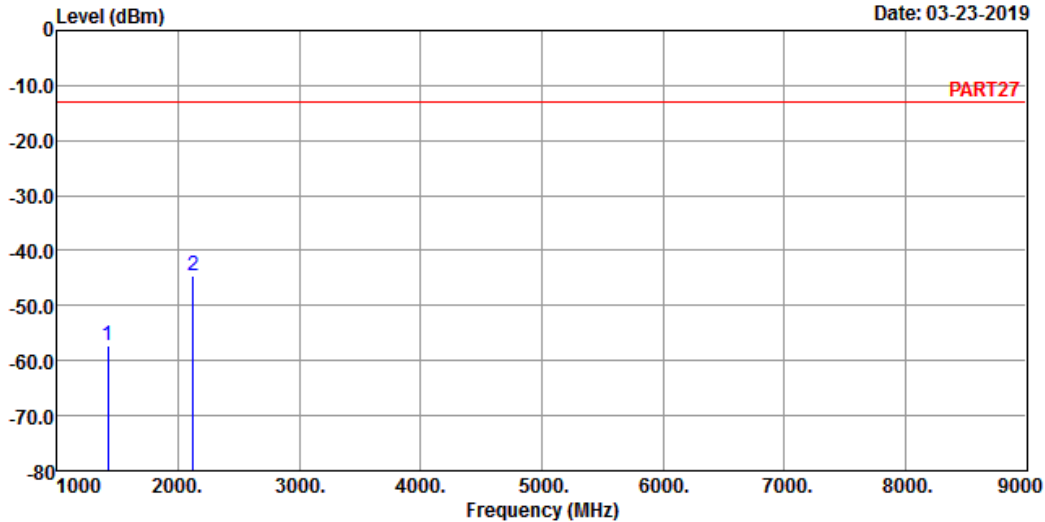

Site : 966 Chamber 5  
 Condition: PART27 HORIZONTAL  
 Remak : Cat-M1 Band 12 QPSK\_5M Link\_M-CH  
 Tested by: Thomas Wei

	Freq	Level	Read Level	Limit	Line Factor	Over Limit	Remark
	MHz	dBm	dBm	dBm	dB	dB	
1	1415.00	-57.33	-45.25	-13.00	-12.08	-44.33	Peak
2 pp	2122.50	-44.58	-34.71	-13.00	-9.87	-31.58	Peak

Bureau Veritas Consumer Products Services Ltd., Taoyuan



A D T

Data: 4

Date: 03-23-2019

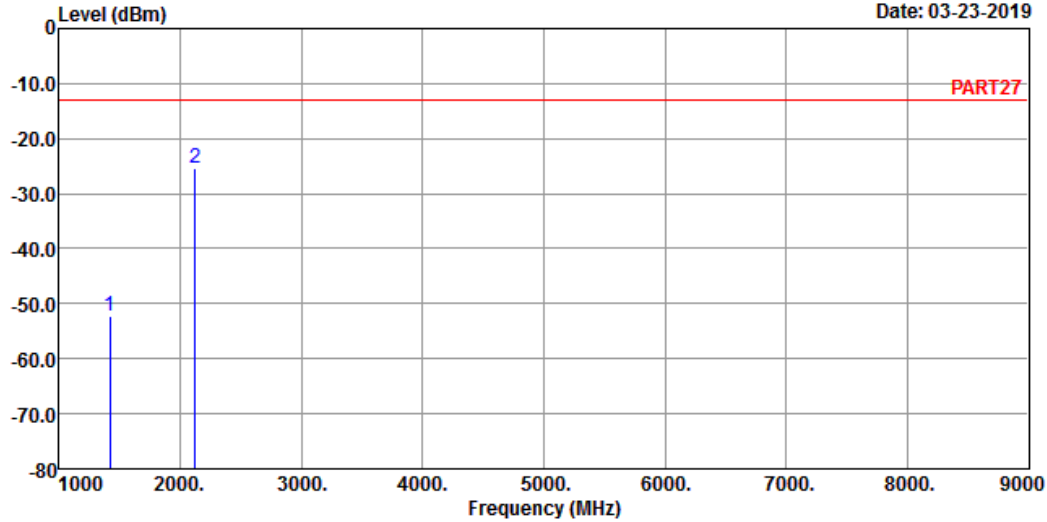

Site : 966 Chamber 5  
 Condition: PART27 VERTICAL  
 Remak : Cat-M1 Band 12 QPSK\_5M Link\_M-CH  
 Tested by: Thomas Wei

	Freq	Level	Read Level	Limit	Line Factor	Over Limit	Remark
	MHz	dBm	dBm	dBm	dB	dB	
1	1415.00	-52.22	-40.14	-13.00	-12.08	-39.22	Peak
2	2122.50	-25.43	-15.56	-13.00	-9.87	-12.43	Peak

High Channel

Bureau Veritas Consumer Products Services Ltd., Taoyuan



A D T

Data: 3

Date: 03-23-2019

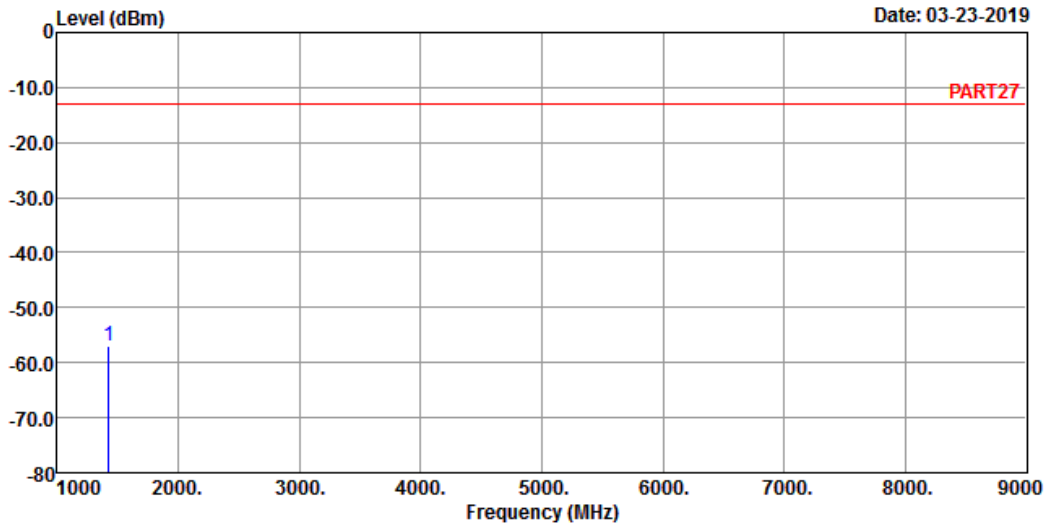

Site : 966 Chamber 5  
 Condition: PART27 HORIZONTAL  
 Remak : Cat-M1 Band 12 QPSK\_5M Link\_H-CH  
 Tested by: Thomas Wei

Freq	Level	Read Level	Limit	Line Factor	Over Limit	Remark
MHz	dBm	dBm	dBm	dB	dB	

1 pp 1427.00 -57.03 -44.78 -13.00 -12.25 -44.03 Peak

Bureau Veritas Consumer Products Services Ltd., Taoyuan



A D T

Data: 4

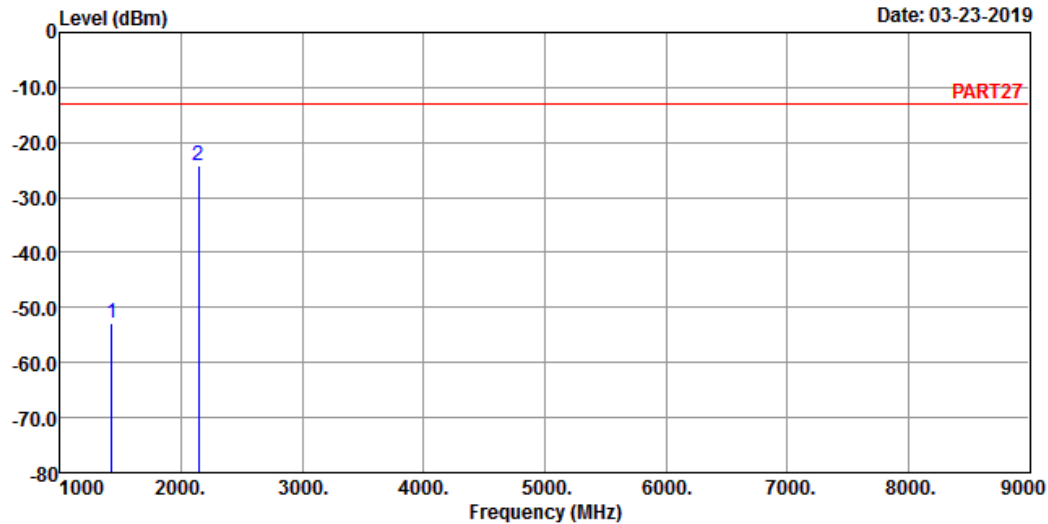

Site : 966 Chamber 5  
 Condition: PART27 VERTICAL  
 Remak : Cat-M1 Band 12 QPSK\_5M Link\_H-CH  
 Tested by: Thomas Wei

	Freq	Level	Read Level	Limit	Line Factor	Over Limit	Remark
	MHz	dBm	dBm	dBm	dB	dB	
1	1427.00	-52.77	-40.52	-13.00	-12.25	-39.77	Peak
2	pp 2140.50	-24.11	-14.54	-13.00	-9.57	-11.11	Peak

Channel Bandwidth: 10 MHz / QPSK  
Low Channel

Bureau Veritas Consumer Products Services Ltd., Taoyuan



A D T

Data: 3

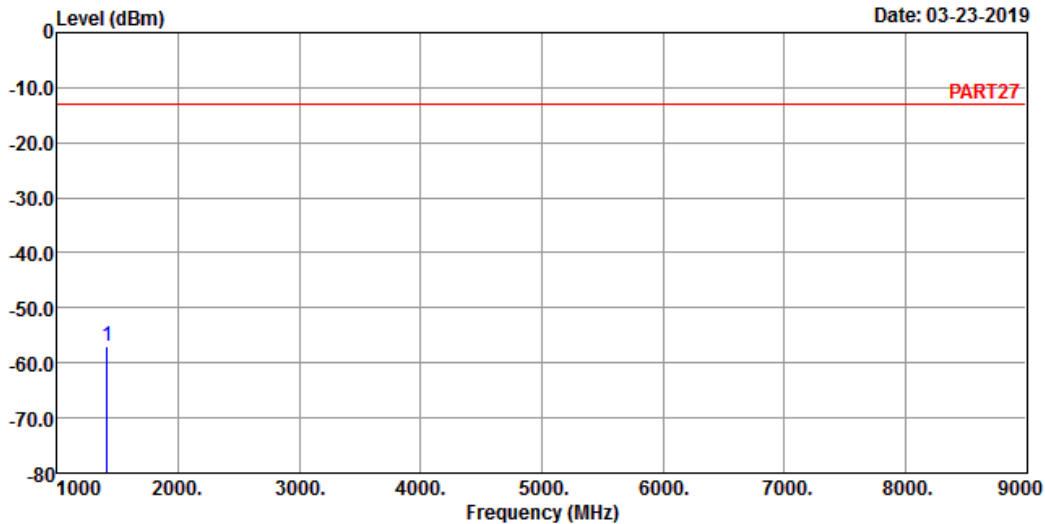

Site : 966 Chamber 5  
Condition: PART27 HORIZONTAL  
Remak : Cat-M1 Band 12 QPSK\_10M Link\_L-CH  
Tested by: Thomas Wei

Freq	Level	Read Level	Limit	Line Factor	Over Limit	Remark
MHz	dBm	dBm	dBm	dB	dB	

1 pp 1408.00 -57.01 -45.05 -13.00 -11.96 -44.01 Peak

Bureau Veritas Consumer Products Services Ltd., Taoyuan



A D T

Data: 4

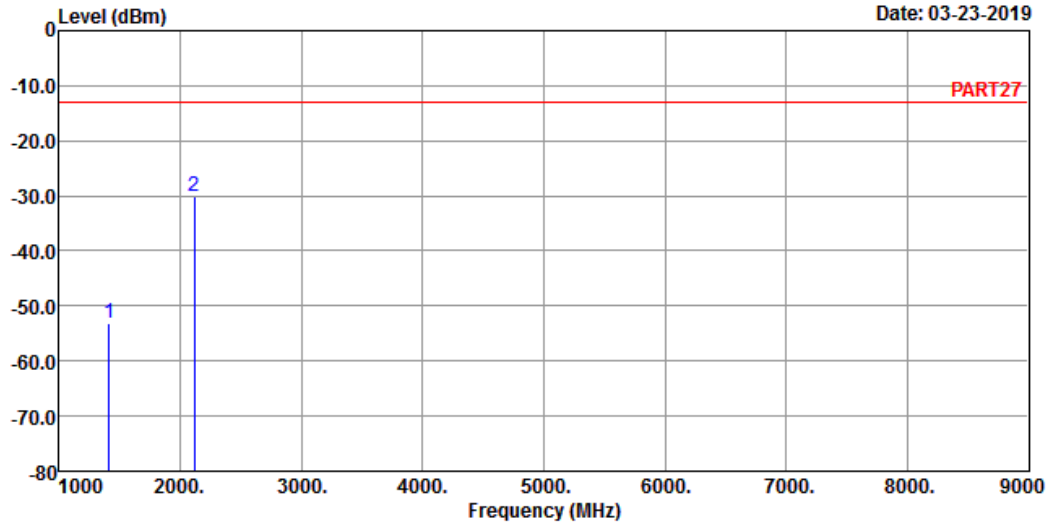

Site : 966 Chamber 5  
 Condition: PART27 VERTICAL  
 Remak : Cat-M1 Band 12 QPSK\_10M Link\_L-CH  
 Tested by: Thomas Wei

	Freq	Level	Read Level	Limit	Line Factor	Over Limit	Remark
	MHz	dBm	dBm	dBm	dB	dB	
1	1408.00	-53.25	-41.29	-13.00	-11.96	-40.25	Peak
2 pp	2112.00	-30.11	-20.15	-13.00	-9.96	-17.11	Peak

Middle Channel

Bureau Veritas Consumer Products Services Ltd., Taoyuan



A D T

Data: 3

Date: 03-23-2019

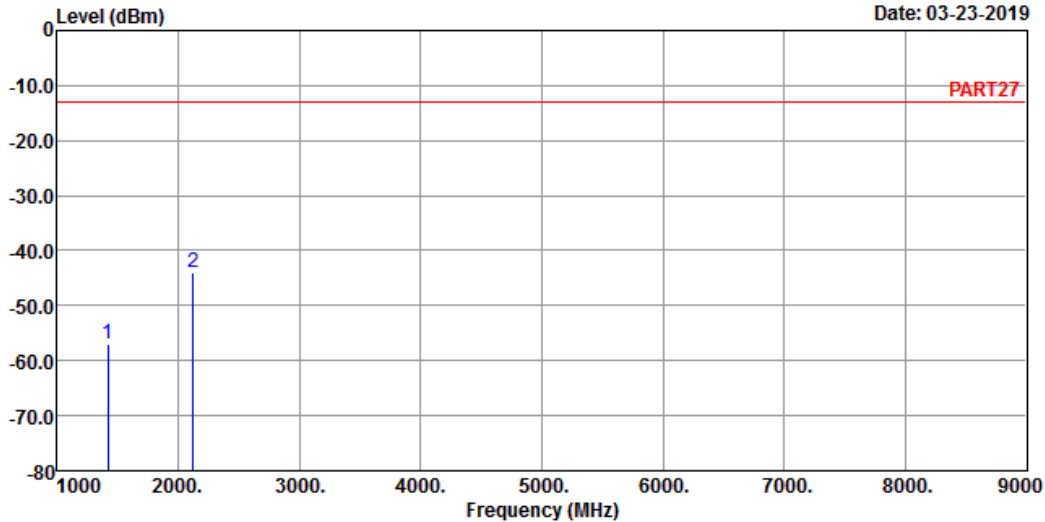

Site : 966 Chamber 5  
 Condition: PART27 HORIZONTAL  
 Remak : Cat-M1 Band 12 QPSK\_10M Link\_M-CH  
 Tested by: Thomas Wei

	Freq	Level	Read Level	Limit	Line Factor	Over Limit	Remark
	MHz	dBm	dBm	dBm	dB	dB	
1	1415.00	-56.95	-44.87	-13.00	-12.08	-43.95	Peak
2 pp	2122.50	-44.10	-34.23	-13.00	-9.87	-31.10	Peak



Bureau Veritas Consumer Products Services Ltd., Taoyuan



A D T

Data: 4

Date: 03-23-2019

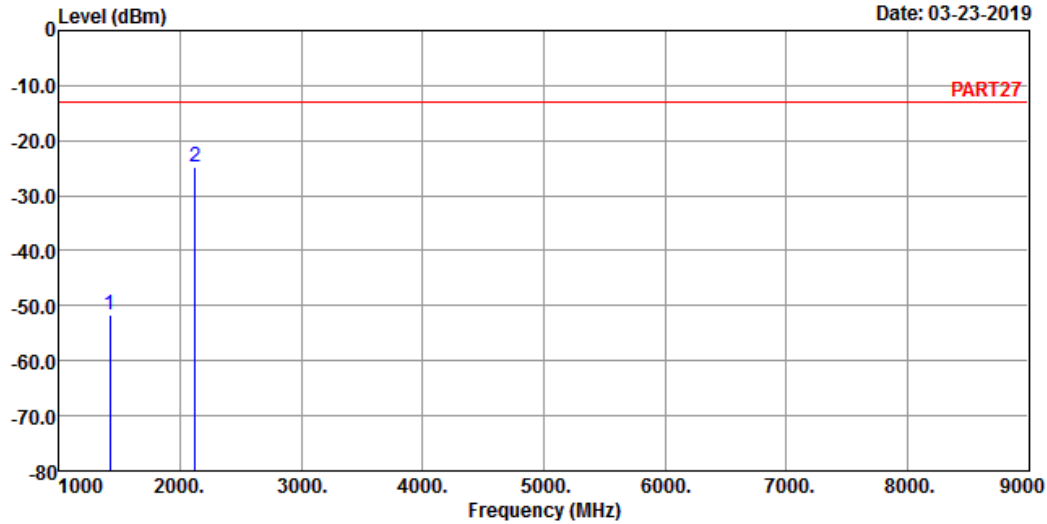

Site : 966 Chamber 5  
 Condition: PART27 VERTICAL  
 Remak : Cat-M1 Band 12 QPSK\_10M Link\_M-CH  
 Tested by: Thomas Wei

	Freq	Level	Read Level	Limit	Line Factor	Over Limit	Remark
	MHz	dBm	dBm	dBm	dB	dB	
1	1415.00	-51.70	-39.62	-13.00	-12.08	-38.70	Peak
2	2122.50	-24.89	-15.02	-13.00	-9.87	-11.89	Peak

High Channel

Bureau Veritas Consumer Products Services Ltd., Taoyuan



A D T

Data: 5

Date: 03-23-2019

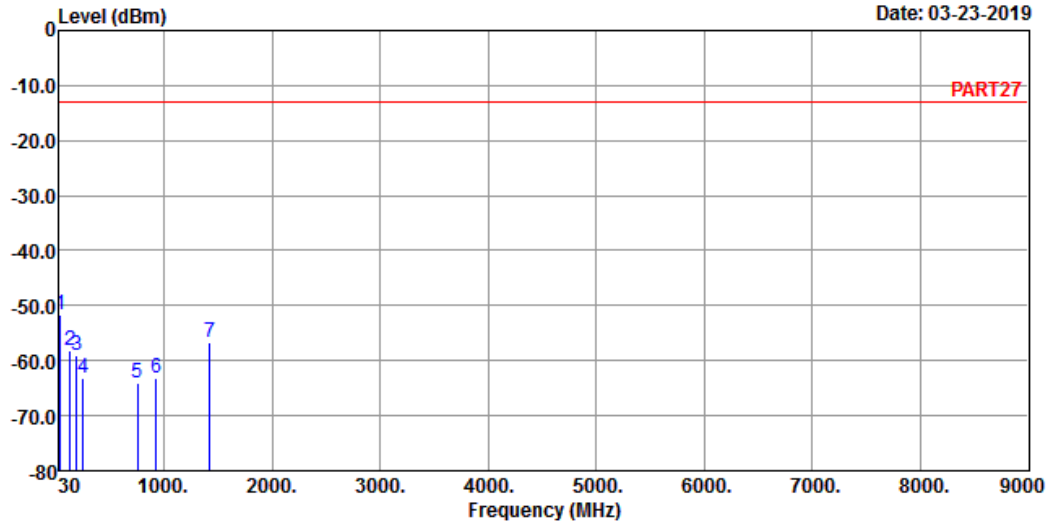

Site : 966 Chamber 5  
 Condition: PART27 HORIZONTAL  
 Remak : Cat-M1 Band 12 QPSK\_10M Link\_H-CH  
 Tested by: Thomas Wei

	Read	Limit	Over			
Freq	Level	Level	Line	Factor	Limit	Remark
MHz	dBm	dBm	dBm	dB	dB	
1 pp	42.61	-51.68	-50.74	-13.00	-0.94	-38.68 Peak
2	128.94	-58.18	-49.37	-13.00	-8.81	-45.18 Peak
3	192.96	-58.90	-51.53	-13.00	-7.37	-45.90 Peak
4	248.25	-63.23	-57.16	-13.00	-6.07	-50.23 Peak
5	751.68	-63.97	-64.84	-13.00	0.87	-50.97 Peak
6	924.34	-63.16	-64.33	-13.00	1.17	-50.16 Peak
7	1422.00	-56.71	-44.52	-13.00	-12.19	-43.71 Peak

Bureau Veritas Consumer Products Services Ltd., Taoyuan



A D T

Data: 6

Date: 03-23-2019

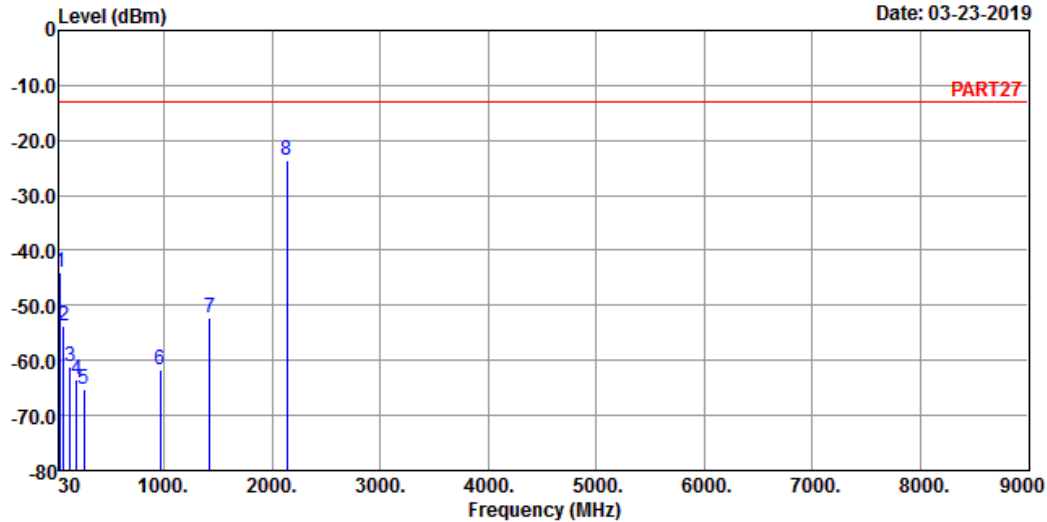

Site : 966 Chamber 5  
 Condition: PART27 VERTICAL  
 Remak : Cat-M1 Band 12 QPSK\_10M Link\_H-CH  
 Tested by: Thomas Wei

	Freq	Level	Read Level	Limit	Line Factor	Over Limit	Remark
	MHz	dBm	dBm	dBm	dB	dB	
1	39.70	-43.88	-44.52	-13.00	0.64	-30.88	Peak
2	68.80	-53.74	-45.42	-13.00	-8.32	-40.74	Peak
3	128.94	-60.98	-52.17	-13.00	-8.81	-47.98	Peak
4	190.05	-63.59	-56.50	-13.00	-7.09	-50.59	Peak
5	256.98	-65.35	-59.22	-13.00	-6.13	-52.35	Peak
6	965.08	-61.56	-63.91	-13.00	2.35	-48.56	Peak
7	1422.00	-52.30	-40.11	-13.00	-12.19	-39.30	Peak
8 pp	2133.00	-23.56	-13.89	-13.00	-9.67	-10.56	Peak

LTE Band 13  
Channel Bandwidth: 5 MHz / QPSK  
Low Channel

Bureau Veritas Consumer Products Services Ltd., Taoyuan



A D T

Data: 3

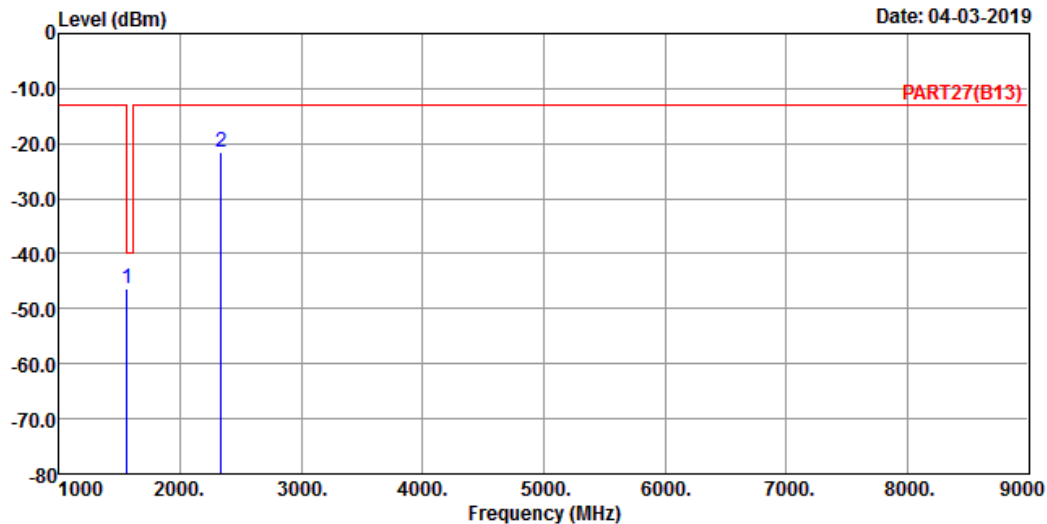

Site : 966 Chamber 5  
Condition: PART27(B13) HORIZONTAL  
Remak : Cat-M1 Band 13 QPSK\_5M Link\_L-CH  
Tested by: Thomas Wei

	Freq	Level	Read Level	Limit	Line Factor	Over Limit	Remark
	MHz	dBm	dBm	dBm	dB	dB	
1	pp 1559.00	-46.29	-32.97	-40.00	-13.32	-6.29	RMS
2	pk 2338.50	-21.62	-12.24	-13.00	-9.38	-8.62	Peak

Bureau Veritas Consumer Products Services Ltd., Taoyuan



A D T

Data: 4

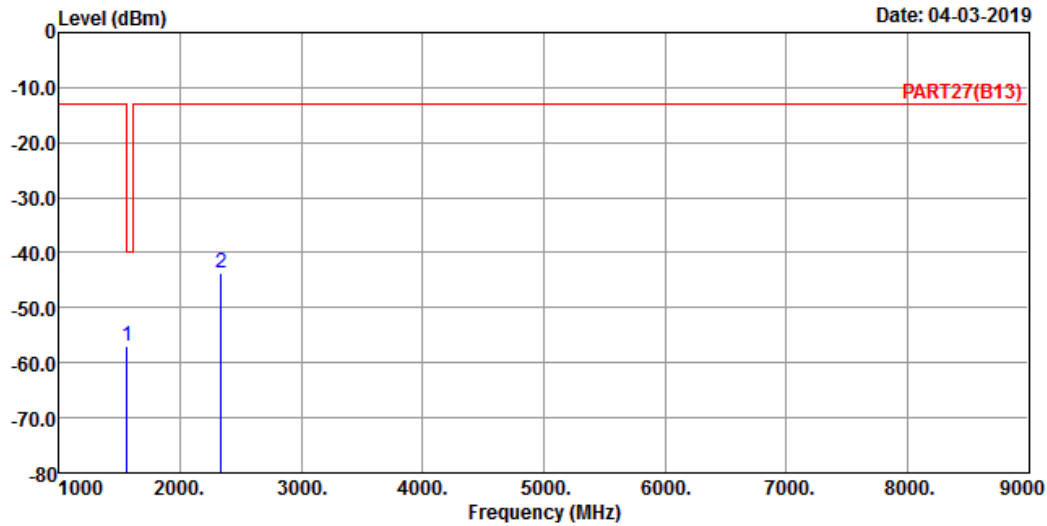

Site : 966 Chamber 5  
 Condition: PART27(B13) VERTICAL  
 Remak : Cat-M1 Band 13 QPSK\_5M Link\_L-CH  
 Tested by: Thomas Wei

	Freq	Level	Read Level	Limit	Line Factor	Over Limit	Remark
	MHz	dBm	dBm	dBm	dB	dB	
1	pp 1559.00	-56.86	-43.54	-40.00	-13.32	-16.86	RMS
2	pk 2338.50	-43.60	-34.22	-13.00	-9.38	-30.60	Peak

Middle Channel

Bureau Veritas Consumer Products Services Ltd., Taoyuan



A D T

Data: 3

Date: 04-03-2019

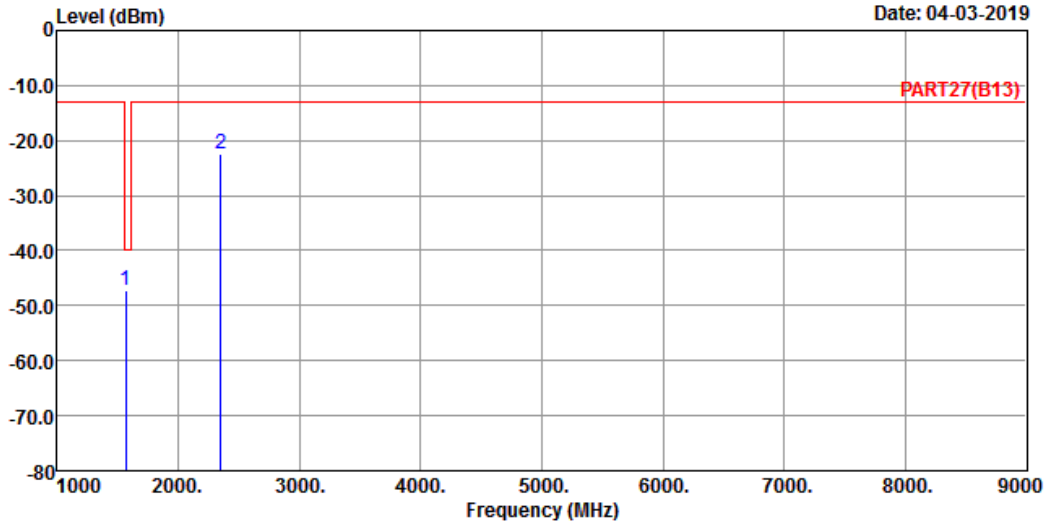

Site : 966 Chamber 5  
 Condition: PART27(B13) HORIZONTAL  
 Remak : Cat-M1 Band 13 QPSK\_5M Link\_M-CH  
 Tested by: Thomas Wei

	Freq	Level	Read Level	Limit	Line Factor	Over Limit	Remark
	MHz	dBm	dBm	dBm	dB	dB	
1	pp	1564.00	-47.15	-33.81	-40.00	-13.34	-7.15 RMS
2	pk	2346.00	-22.29	-12.85	-13.00	-9.44	-9.29 Peak

Bureau Veritas Consumer Products Services Ltd., Taoyuan



A D T

Data: 4

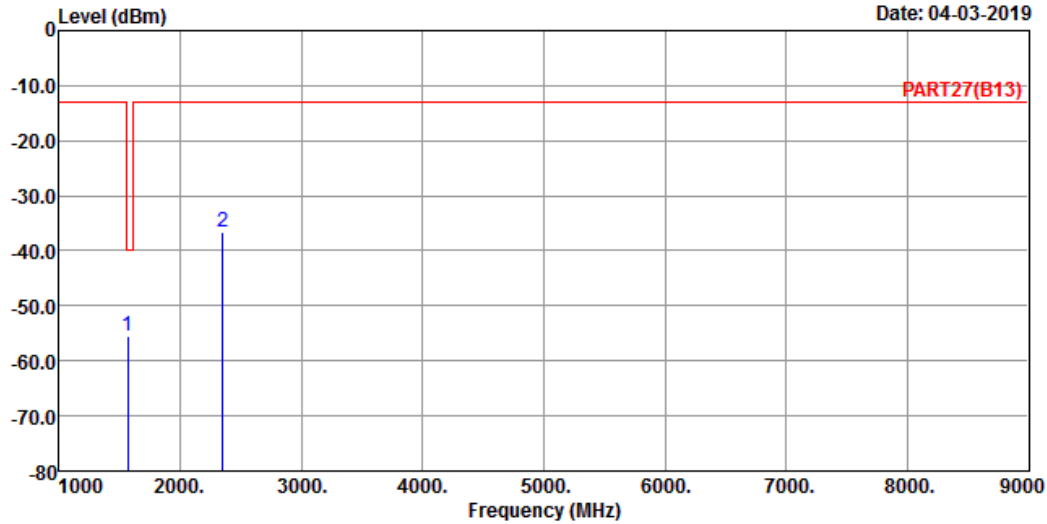

Site : 966 Chamber 5  
 Condition: PART27(B13) VERTICAL  
 Remak : Cat-M1 Band 13 QPSK\_5M Link\_M-CH  
 Tested by: Thomas Wei

	Freq	Level	Read Level	Limit	Line Factor	Over Limit	Remark
	MHz	dBm	dBm	dBm	dB	dB	
1 pp	1564.00	-55.52	-42.18	-40.00	-13.34	-15.52	RMS
2 pk	2346.00	-36.73	-27.29	-13.00	-9.44	-23.73	Peak

High Channel

Bureau Veritas Consumer Products Services Ltd., Taoyuan



A D T

Data: 3

Date: 04-03-2019

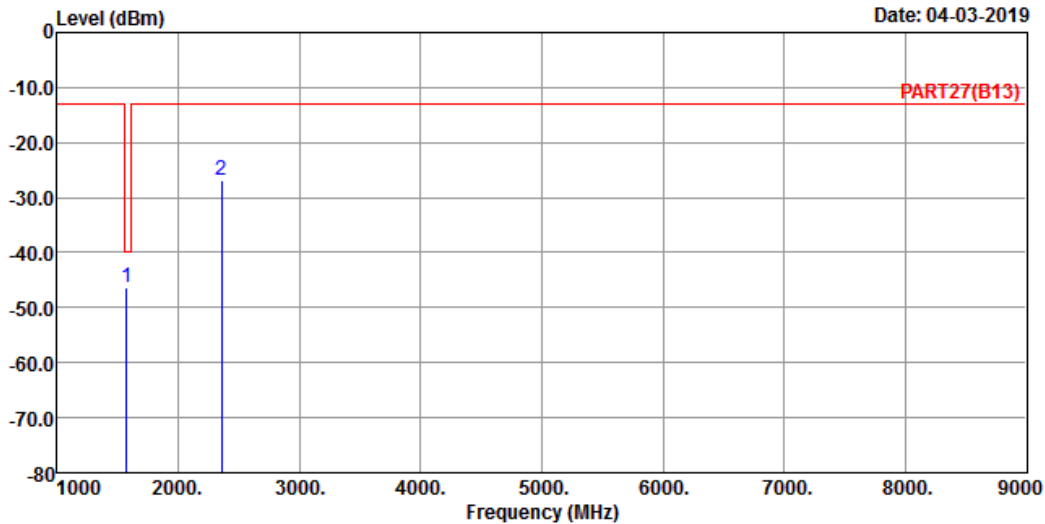

Site : 966 Chamber 5  
 Condition: PART27(B13) HORIZONTAL  
 Remak : Cat-M1 Band 13 QPSK\_5M Link\_H-CH  
 Tested by: Thomas Wei

	Freq	Level	Read Level	Limit	Line Factor	Over Limit	Remark
	MHz	dBm	dBm	dBm	dB	dB	
1	pp 1569.00	-46.28	-32.93	-40.00	-13.35	-6.28	RMS
2	pk 2353.50	-26.97	-17.46	-13.00	-9.51	-13.97	Peak



Bureau Veritas Consumer Products Services Ltd., Taoyuan



A D T

Data: 4

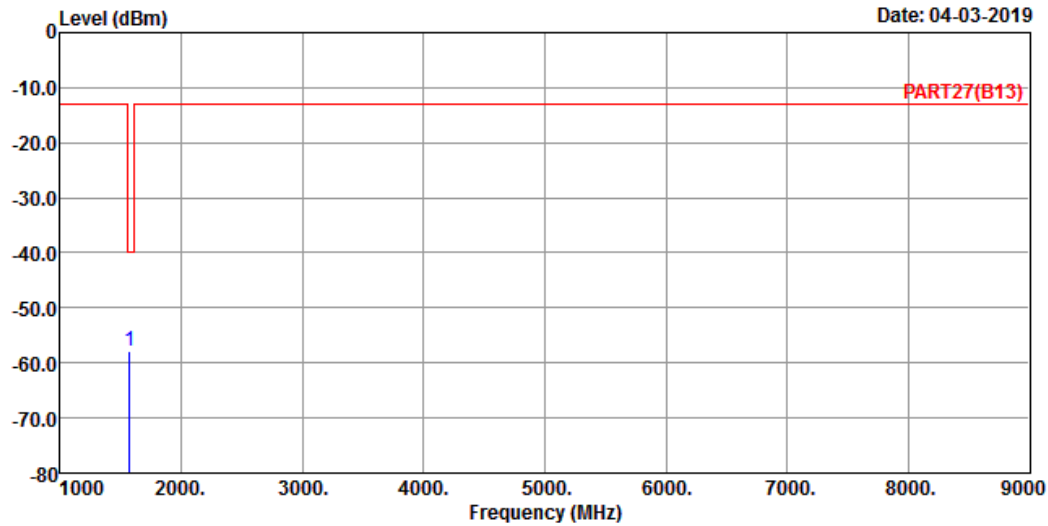

Site : 966 Chamber 5  
 Condition: PART27(B13) VERTICAL  
 Remak : Cat-M1 Band 13 QPSK\_5M Link\_H-CH  
 Tested by: Thomas Wei

Freq	Level	Read Level	Limit	Line Factor	Over Limit	Remark
MHz	dBm	dBm	dBm	dB	dB	
1 pp 1569.00	-57.81	-44.46	-40.00	-13.35	-17.81	RMS

Channel Bandwidth: 10 MHz / QPSK

Bureau Veritas Consumer Products Services Ltd., Taoyuan



A D T

Data: 5

Date: 04-03-2019

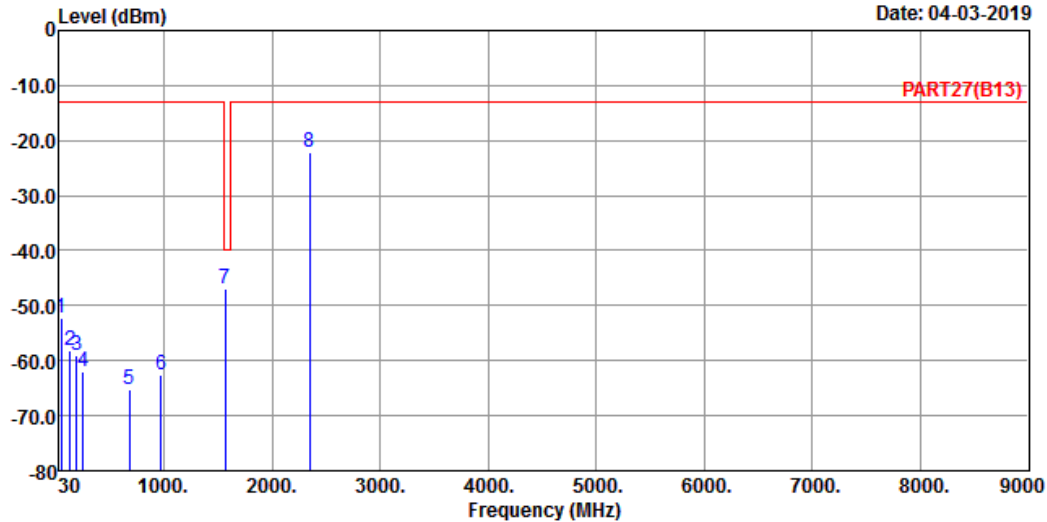

Site : 966 Chamber 5  
 Condition: PART27(B13) HORIZONTAL  
 Remak : Cat-M1 Band 13 QPSK\_10M Link\_M-CH  
 Tested by: Thomas Wei

	Freq	Level	Read Level	Limit	Line Factor	Over Limit	Remark
	MHz	dBm	dBm	dBm	dB	dB	
1	44.55	-52.25	-50.26	-13.00	-1.99	-39.25	Peak
2	127.97	-58.07	-49.15	-13.00	-8.92	-45.07	Peak
3	189.08	-59.06	-51.94	-13.00	-7.12	-46.06	Peak
4	253.10	-62.09	-56.04	-13.00	-6.05	-49.09	Peak
5	680.87	-65.19	-64.79	-13.00	-0.40	-52.19	Peak
6	972.84	-62.46	-65.08	-13.00	2.62	-49.46	Peak
7 pp	1564.00	-47.06	-33.72	-40.00	-13.34	-7.06	RMS
8 pk	2346.00	-22.02	-12.58	-13.00	-9.44	-9.02	Peak

Bureau Veritas Consumer Products Services Ltd., Taoyuan



A D T

Data: 6

Date: 04-03-2019

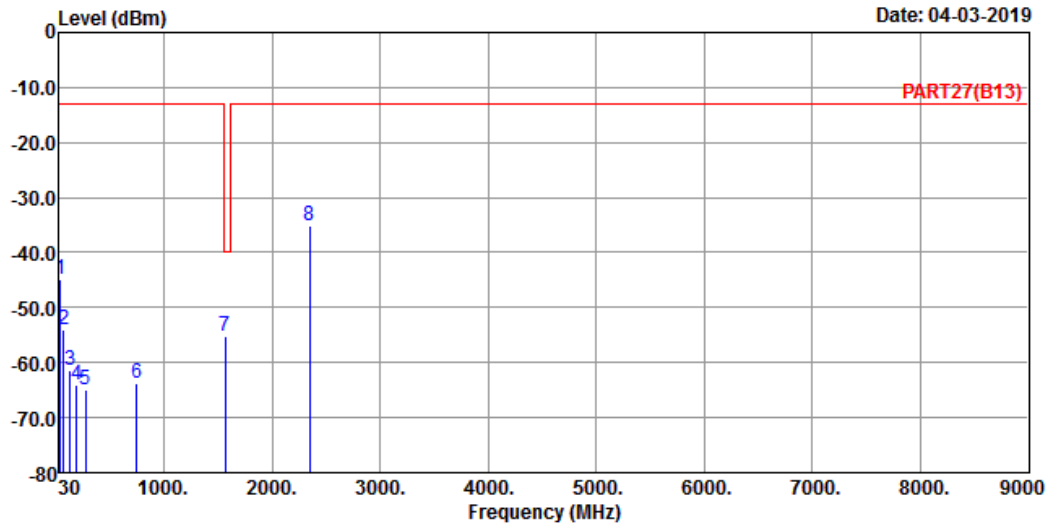

Site : 966 Chamber 5  
 Condition: PART27(B13) VERTICAL  
 Remak : Cat-M1 Band 13 QPSK\_10M Link\_M-CH  
 Tested by: Thomas Wei

	Freq	Level	Read Level	Limit	Line Factor	Over Limit	Remark
	MHz	dBm	dBm	dBm	dB	dB	
1	39.70	-44.82	-45.46	-13.00	0.64	-31.82	Peak
2	68.80	-54.07	-45.75	-13.00	-8.32	-41.07	Peak
3	128.94	-61.32	-52.51	-13.00	-8.81	-48.32	Peak
4	188.11	-64.10	-56.95	-13.00	-7.15	-51.10	Peak
5	269.59	-64.96	-58.57	-13.00	-6.39	-51.96	Peak
6	749.74	-63.84	-64.72	-13.00	0.88	-50.84	Peak
7 pp	1564.00	-55.21	-41.87	-40.00	-13.34	-15.21	RMS
8 pk	2346.00	-35.17	-25.73	-13.00	-9.44	-22.17	Peak

## 5 Pictures of Test Arrangements

Please refer to the attached file (Test Setup Photo).

## Appendix – Information of the Testing Laboratories

We, Bureau Veritas Consumer Products Services (H.K.) Ltd., Taoyuan Branch, were founded in 1988 to provide our best service in EMC, Radio, Telecom and Safety consultation. Our laboratories are FCC recognized accredited test firms and accredited according to ISO/IEC 17025.

If you have any comments, please feel free to contact us at the following:

**Lin Kou EMC/RF Lab**

Tel: 886-2-26052180

Fax: 886-2-26051924

**Hsin Chu EMC/RF/Telecom Lab**

Tel: 886-3-6668565

Fax: 886-3-6668323

**Hwa Ya EMC/RF/Safety**

Tel: 886-3-3183232

Fax: 886-3-3270892

**Email:** [service.adt@tw.bureauveritas.com](mailto:service.adt@tw.bureauveritas.com)

**Web Site:** [www.bureauveritas-adt.com](http://www.bureauveritas-adt.com)

The address and road map of all our labs can be found in our web site also.

--- END ---