

FCC Test Report

(PART 27)

Report No.: RF180521C04B-1

FCC ID: 2AAGMGM01QA

Test Model: GM01Q

Received Date: Aug. 01, 2018

Test Date: Aug. 02, 2018, Jan. 21, 2019 ~ Apr. 03, 2019

Issued Date: Apr. 16, 2019

Applicant: Sequans Communications

Address: 15-55 Boulevard Charles de Gaulle, 92700 Colombes France

Issued By: Bureau Veritas Consumer Products Services (H.K.) Ltd., Taoyuan Branch

Lab Address: No. 47-2, 14th Ling, Chia Pau Vil., Lin Kou Dist., New Taipei City, Taiwan
(R.O.C)

Test Location: No. 19, Hwa Ya 2nd Rd, Wen Hwa Vil, Kwei Shan Dist., Taoyuan City
33383, Taiwan (R.O.C)

**FCC Registration /
Designation Number:** 788550 / TW0003



This report is for your exclusive use. Any copying or replication of this report to or for any other person or entity, or use of our name or trademark, is permitted only with our prior written permission. This report sets forth our findings solely with respect to the test samples identified herein. The results set forth in this report are not indicative or representative of the quality or characteristics of the lot from which a test sample was taken or any similar or identical product unless specifically and expressly noted. Our report includes all of the tests requested by you and the results thereof based upon the information that you provided to us. You have 60 days from date of issuance of this report to notify us of any material error or omission caused by our negligence, provided, however, that such notice shall be in writing and shall specifically address the issue you wish to raise. A failure to raise such issue within the prescribed time shall constitute your unqualified acceptance of the completeness of this report, the tests conducted and the correctness of the report contents. Unless specific mention, the uncertainty of measurement has been explicitly taken into account to declare the compliance or non-compliance to the specification. The report must not be used by the client to claim product certification, approval, or endorsement by TAF or any government agencies

Table of Contents

Release Control Record	4
1 Certificate of Conformity	5
2 Summary of Test Results	6
2.1 Measurement Uncertainty	7
2.2 Test Site and Instruments	8
3 General Information	11
3.1 General Description of EUT	11
3.2 Configuration of System under Test	13
3.2.1 Description of Support Units	13
3.3 Test Mode Applicability and Tested Channel Detail	13
3.4 EUT Operating Conditions	17
3.5 General Description of Applied Standards	17
4 Test Types and Results	18
4.1 Output Power Measurement	18
4.1.1 Limits of Output Power Measurement	18
4.1.2 Test Procedures	18
4.1.3 Test Setup	19
4.1.4 Test Results	20
4.2 Modulation Characteristics Measurement	34
4.2.1 Limits of Modulation Characteristics	34
4.2.2 Test Setup	34
4.2.3 Test Procedure	34
4.2.4 Test Results	35
4.3 Frequency Stability Measurement	36
4.3.1 Limits of Frequency Stability Measurement	36
4.3.2 Test Procedure	36
4.3.3 Test Setup	36
4.3.4 Test Results	37
4.4 Occupied Bandwidth Measurement	45
4.4.1 Limits of Occupied Bandwidth Measurement	45
4.4.2 Test Procedure	45
4.4.3 Test Setup	45
4.4.4 Test Result	46
4.5 Band Edge Measurement	50
4.5.1 Limits of Band Edge Measurement	50
4.5.2 Test Setup	50
4.5.3 Test Procedures	50
4.5.4 Test Results	51
4.6 Peak to Average Ratio	61
4.6.1 Limits of Peak to Average Ratio Measurement	61
4.6.2 Test Setup	61
4.6.3 Test Procedures	61
4.6.4 Test Results	62
4.7 Conducted Spurious Emissions	66
4.7.1 Limits of Conducted Spurious Emissions Measurement	66
4.7.2 Test Setup	66
4.7.3 Test Procedure	66
4.7.4 Test Results	67
4.8 Radiated Emission Measurement	85
4.8.1 Limits of Radiated Emission Measurement	85
4.8.2 Test Procedure	85
4.8.3 Deviation from Test Standard	85
4.8.4 Test Setup	86

4.8.5 Test Results	87
5 Pictures of Test Arrangements.....	119
Appendix – Information of the Testing Laboratories	120

Release Control Record

Issue No.	Description	Date Issued
RF180521C04B-1	Original Release	Apr. 16, 2019

1 Certificate of Conformity

Product: GM01Q EZlinkLTE modules

Brand: SEQUANS COMMUNICATIONS

Test Model: GM01Q

Sample Status: Mass Production

Applicant: Sequans Communications

Test Date: Aug. 02, 2018, Jan. 21, 2019 ~ Apr. 03, 2019

Standards: FCC Part 27, Subpart C, H, F, L

The above equipment has been tested by **Bureau Veritas Consumer Products Services (H.K.) Ltd., Taoyuan Branch**, and found compliance with the requirement of the above standards. The test record, data evaluation & Equipment Under Test (EUT) configurations represented herein are true and accurate accounts of the measurements of the sample's RF characteristics under the conditions specified in this report.

Prepared by : , **Date:** Apr. 16, 2019
Ivonne Wu / Supervisor

Approved by : , **Date:** Apr. 16, 2019
Dylan Chiou / Project Engineer

2 Summary of Test Results

Applied Standard: FCC Part 27 & Part 2 (LTE 4)			
FCC Clause	Test Item	Result	Remarks
2.1046 27.50(d)(4)	Maximum Peak Output Power	Pass	Meet the requirement of limit.
2.1047	Modulation Characteristics	Pass	Meet the requirement.
2.1055 27.54	Frequency Stability	Pass	Meet the requirement of limit.
2.1049	Occupied Bandwidth	Pass	Meet the requirement of limit.
27.50(d)(5)	Peak to Average Ratio	Pass	Meet the requirement of limit.
27.53(h)	Band Edge Measurements	Pass	Meet the requirement of limit.
2.1051 27.53(h)	Conducted Spurious Emissions	Pass	Meet the requirement of limit.
2.1053 27.53(h)	Radiated Spurious Emissions	Pass	Meet the requirement of limit. Minimum passing margin is -17.25 dB at 8725.00 MHz.

Applied Standard: FCC Part 27 & Part 2 (LTE 12)			
FCC Clause	Test Item	Result	Remarks
2.1046 27.50(c)(10)	Maximum Peak Output Power	Pass	Meet the requirement of limit.
2.1047	Modulation Characteristics	Pass	Meet the requirement.
2.1055 27.54	Frequency Stability	Pass	Meet the requirement of limit.
2.1049	Occupied Bandwidth	Pass	Meet the requirement of limit.
---	Peak to Average Ratio	Pass	Meet the requirement of limit.
27.53(g)	Band Edge Measurements	Pass	Meet the requirement of limit.
2.1051 27.53(g)	Conducted Spurious Emissions	Pass	Meet the requirement of limit.
2.1053 27.53(g)	Radiated Spurious Emissions	Pass	Meet the requirement of limit. Minimum passing margin is -10.56 dB at 2133.00 MHz.

Applied Standard: FCC Part 27 & Part 2 (LTE 13)			
FCC Clause	Test Item	Result	Remarks
2.1046 27.50(b)(10)	Maximum Peak Output Power	Pass	Meet the requirement of limit.
2.1047	Modulation Characteristics	Pass	Meet the requirement.
2.1055 27.54	Frequency Stability	Pass	Meet the requirement of limit.
2.1049	Occupied Bandwidth	Pass	Meet the requirement of limit.
---	Peak to Average Ratio	Pass	Meet the requirement of limit.
27.53(c)(2)(4)	Band Edge Measurements	Pass	Meet the requirement of limit.
2.1051 27.53(c)(2)&(f)	Conducted Spurious Emissions	Pass	Meet the requirement of limit.
2.1053 27.53(c)(2)&(f)	Radiated Spurious Emissions	Pass	Meet the requirement of limit. Minimum passing margin is -6.28 dB at 1569.00 MHz.

Note: Determining compliance based on the results of the compliance measurement, not taking into account measurement instrumentation uncertainty.

2.1 Measurement Uncertainty

Where relevant, the following measurement uncertainty levels have been estimated for tests performed on the EUT as specified in CISPR 16-4-2:

Measurement	Frequency	Expanded Uncertainty (k=2) (±)
Radiated Emissions up to 1 GHz	9 kHz ~ 30 MHz	3.04 dB
	30 MHz ~ 200 MHz	2.93 dB
	200 MHz ~ 1000 MHz	2.95 dB
Radiated Emissions above 1 GHz	1 GHz ~ 18 GHz	2.26 dB
	18 GHz ~ 40 GHz	1.94 dB

2.2 Test Site and Instruments

Test Date: Aug. 02, 2018

Description & Manufacturer	Model No.	Serial No.	Date of Calibration	Due Date of Calibration
Test Receiver Agilent	N9038A	MY51210203	Mar. 16, 2018	Mar. 15, 2019
Spectrum Analyzer Agilent	N9010A	MY52220314	Nov. 24, 2017	Nov. 23, 2018
Spectrum Analyzer ROHDE & SCHWARZ	FSU43	100115	Nov. 23, 2017	Nov. 22, 2018
BILOG Antenna SCHWARZBECK	VULB 9168	9168-472	Dec. 06, 2017	Dec. 05, 2018
Double Ridge Guide Horn Antenna EMCO	3115	5619	Nov. 30, 2017	Nov. 29, 2018
HORN Antenna SCHWARZBECK	BBHA 9120D	9120D-969	Dec. 12, 2017	Dec. 11, 2018
MXG Vector signal generator Agilent	N5182B	MY53050430	Oct. 24, 2017	Oct. 23, 2018
Preamplifier EMCI	EMC 012645	980115	Oct. 20, 2017	Oct. 19, 2018
Preamplifier EMCI	EMC 184045	980116	Oct. 20, 2017	Oct. 19, 2018
Preamplifier EMCI	EMC 330H	980112	Oct. 13, 2017	Oct. 12, 2018
Power Meter Anritsu	ML2495A	1012010	Aug. 15, 2017	Aug. 14, 2018
Power Sensor Anritsu	MA2411B	1315050	Aug. 15, 2017	Aug. 14, 2018
RF Coaxial Cable HUBER+SUHNNER	EMC104-SM-SM-800 0&3000	140811+170717	Oct. 20, 2017	Oct. 19, 2018
RF Coaxial Cable HUBER+SUHNNER	SUCOFLEX 104	EMC104-SM-SM- 1000(140807)	Oct. 20, 2017	Oct. 19, 2018
RF Coaxial Cable WOKEN	8D-FB	Cable-Ch10-01	Oct. 20, 2017	Oct. 19, 2018
Boresight Antenna Fixture	FBA-01	FBA-SIP01	NA	NA
Software BV ADT	E3 6.120103	NA	NA	NA
Antenna Tower MF	MFA-440H	NA	NA	NA
Turn Table MF	MFT-201SS	NA	NA	NA
Antenna Tower & Turn Table Controller MF	MF-7802	NA	NA	NA
LTE Wireless Communication Test Set Keysight	E7515A	MY56030229	Mar. 14, 2018	Mar. 13, 2019
Temperature & Humidity Chamber	GTH-120-40-CP-AR	MAA1306-019	Sep. 08, 2017	Sep. 07, 2018
DC Power Supply Topward	33010D	807748	NA	NA
Digital Multimeter Fluke	87-III	70360742	Jun. 29, 2018	Jun. 28, 2019

- Note:
1. The calibration interval of the above test instruments is 12 / 24 months and the calibrations are traceable to NML/ROC and NIST/USA.
 2. The test was performed in HwaYa Chamber 10.
 3. The horn antenna and preamplifier (model: EMC 184045) are used only for the measurement of emission frequency above 1 GHz if tested.
 4. The IC Site Registration No. is 7450F-10.

Test Date: Jan. 21, 2019 ~ Apr. 03, 2019

Description & Manufacturer	Model No.	Serial No.	Date of Calibration	Due Date of Calibration
Test Receiver Agilent	N9038A	MY51210203	Mar. 18, 2019	Mar. 17, 2020
Spectrum Analyzer Agilent	N9010A	MY56070348	Sep. 06, 2018	Sep. 05, 2019
Spectrum Analyzer ROHDE & SCHWARZ	FSU43	100115	Jan. 21, 2019	Jan. 20, 2020
Spectrum Analyzer ROHDE & SCHWARZ	FSW26	102023	Oct. 11, 2018	Oct. 10, 2019
HORN Antenna SCHWARZBECK	3115	5619	Nov. 25, 2018	Nov. 24, 2019
HORN Antenna SCHWARZBECK	BBHA 9120 D	9120D-969	Nov. 25, 2018	Nov. 24, 2019
BILOG Antenna SCHWARZBECK	VULB9168	9168-472	Nov. 23, 2018	Nov. 22, 2019
Fixed Attenuator Mini-Circuits	MDCS18N-10	MDCS18N-10-01	Apr. 16, 2018	Apr. 15, 2019
MXG Vector signal generator Agilent	N5182B	MY53052658	May 24, 2018	May 23, 2019
Preamplifier EMCI	EMC 012645	980115	Oct. 12, 2018	Oct. 11, 2019
Preamplifier EMCI	EMC 330H	980112	Oct. 12, 2018	Oct. 11, 2019
RF Coaxial Cable HUBER+SUHNNER	EMC104-SM-SM-800 0&3000	140811+170717	Oct. 12, 2018	Oct. 11, 2019
RF Coaxial Cable HUBER+SUHNNER	SUCOFLEX 104	EMC104-SM-SM- 1000(140807)	Oct. 12, 2018	Oct. 11, 2019
RF Coaxial Cable WOKEN	8D-FB	Cable-Ch10-01	Oct. 12, 2018	Oct. 11, 2019
Boresight Antenna Fixture	FBA-01	FBA-SIP01	NA	NA
Software BV ADT	E3 6.120103	NA	NA	NA
Antenna Tower MF	MFA-440H	NA	NA	NA
Turn Table MF	MFT-201SS	NA	NA	NA
Antenna Tower & Turn Table Controller MF	MF-7802	NA	NA	NA
LTE Wireless Communication Test Set Keysight	E7515A	MY56030229	Mar. 14, 2018	Mar. 13, 2019
		MY57270629	Feb. 22, 2019	Feb. 21, 2020
Temperature & Humidity Chamber	GTH-120-40-CP-AR	MAA1306-019	Sep. 05, 2018	Sep. 04, 2019
DC Power Supply Topward	33010D	807748	NA	NA

- Note: 1. The calibration interval of the above test instruments is 12 / 24 months and the calibrations are traceable to NML/ROC and NIST/USA.
2. The test was performed in HwaYa Chamber 10.
3. The horn antenna and preamplifier (model: EMC 184045) are used only for the measurement of emission frequency above 1 GHz if tested.
4. The IC Site Registration No. is 7450F-10.

3 General Information

3.1 General Description of EUT

Product	GM01Q EZlinkLTE modules	
Brand	SEQUANS COMMUNICATIONS	
Test Model	GM01Q	
Status of EUT	Mass Production	
Power Supply Rating	5.0 Vdc (adapter) or 3.8 Vdc (form DC power supply)	
Modulation Type	LTE	QPSK, 16QAM
Frequency Range	LTE Band 4 (Channel Bandwidth: 5 MHz)	1712.5 ~ 1752.5 MHz
	LTE Band 4 (Channel Bandwidth: 10 MHz)	1715.0 ~ 1750.0 MHz
	LTE Band 4 (Channel Bandwidth: 15 MHz)	1717.5 ~ 1747.5 MHz
	LTE Band 4 (Channel Bandwidth: 20 MHz)	1720.0 ~ 1745.0 MHz
	LTE Band 12 (Channel Bandwidth: 5 MHz)	701.5 ~ 713.5 MHz
	LTE Band 12 (Channel Bandwidth: 10 MHz)	704.0 ~ 711.0 MHz
	LTE Band 13 (Channel Bandwidth: 5 MHz)	779.5 ~ 784.5 MHz
	LTE Band 13 (Channel Bandwidth: 10 MHz)	782.0 MHz
Emission Designator	LTE Band 4 (Channel Bandwidth: 5 MHz)	1M10G7D
	LTE Band 4 (Channel Bandwidth: 10 MHz)	1M09G7D
	LTE Band 4 (Channel Bandwidth: 15 MHz)	1M10G7D
	LTE Band 4 (Channel Bandwidth: 20 MHz)	1M10G7D
	LTE Band 12 (Channel Bandwidth: 5 MHz)	1M09G7D
	LTE Band 12 (Channel Bandwidth: 10 MHz)	1M09G7D
	LTE Band 13 (Channel Bandwidth: 5 MHz)	1M09G7D
	LTE Band 13 (Channel Bandwidth: 10 MHz)	1M09G7D
Max. ERP Power	LTE Band 12 (Channel Bandwidth: 5 MHz)	121.06 mW
	LTE Band 12 (Channel Bandwidth: 10 MHz)	128.53 mW
	LTE Band 13 (Channel Bandwidth: 5 MHz)	98.17 mW
	LTE Band 13 (Channel Bandwidth: 10 MHz)	104.71 mW
Max. EIRP Power	LTE Band 4 (Channel Bandwidth: 5 MHz)	220.29 mW
	LTE Band 4 (Channel Bandwidth: 10 MHz)	234.42 mW
	LTE Band 4 (Channel Bandwidth: 15 MHz)	250.03 mW
	LTE Band 4 (Channel Bandwidth: 20 MHz)	263.63 mW
Antenna Type	Broadband Omni-Directional	
Antenna Gain	LTE Band 4	2 dBi gain
	LTE Band 12	-2 dBi gain
	LTE Band 13	-2.4 dBi gain
Accessory Device	Refer to Note as below	
Data Cable Supplied	Refer to Note as below	

Note:

1. This report is issued as a supplementary report to BV CPS report no.: RF180521C04. The difference compared with original report is supported band changed by software (as listed below). All the test items for LTE B13 are tested. For other band, only ERP/EIRP and RSE tests were re-tested; the test data for other test items from the original report are kept in this report.

Report No.	FCC ID	Difference
RF180521C04-1	2AAGMGM01Q	Support LTE B2, 4, 12, 66
RF180521C04B-1	2AAGMGM01QA	Support LTE B2, 4, 12, 13

2. The above EUT information is declared by manufacturer and for more detailed features description, please refers to the manufacturer's specifications or user's manual.

3.2 Configuration of System under Test

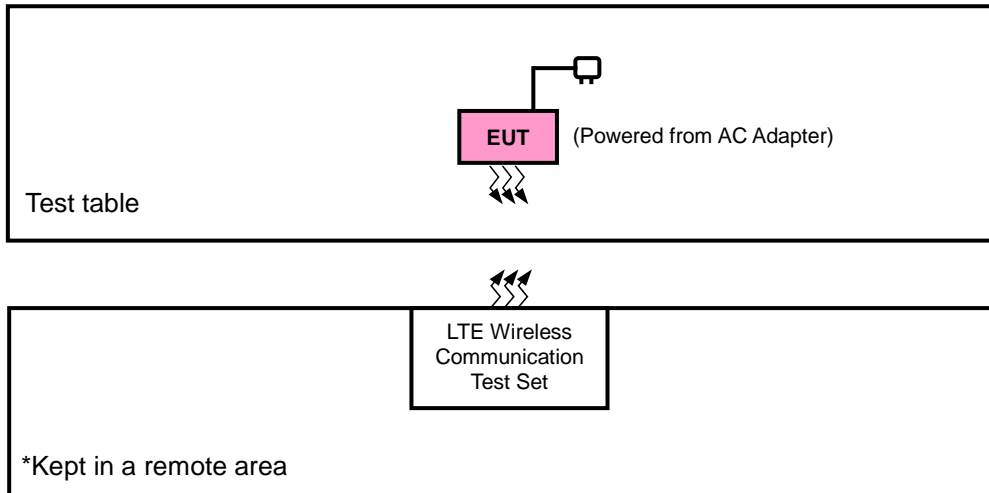

3.2.1 Description of Support Units

The EUT has been tested as an independent unit together with other necessary accessories or support units.

3.3 Test Mode Applicability and Tested Channel Detail

Pre-Scan has been conducted to determine the worst-case mode from all possible combinations between available modulations, data rates, XYZ axis, and antenna ports

The worst case was found when positioned as the table below. Following channel(s) was (were) selected for the final test as listed below:

Band	ERP / EIRP	Radiated Emission
LTE Band 4	X-plane	X-axis
LTE Band 12	X-plane	Z-axis
LTE Band 13	X-plane	X-axis

LTE Band 4

EUT Configure Mode	Test Item	Available Channel	Tested Channel	Channel Bandwidth	Modulation	Mode		
-	EIRP	19975 to 20375	19975, 20175, 20375	5 MHz	QPSK, 16QAM	5 RB / 0 RB Offset		
		20000 to 20350	20000, 20175, 20350	10 MHz	QPSK, 16QAM	1 RB / 5 RB Offset		
		20025 to 20325	20025, 20175, 20325	15 MHz	QPSK, 16QAM	1 RB / 0 RB Offset		
		20050 to 20300	20050, 20175, 20300	20 MHz	QPSK, 16QAM	1 RB / 0 RB Offset		
-	Modulation Characteristics	20000 to 20350	20175	10 MHz	QPSK, 16QAM	1 RB / 0 RB Offset		
-	Frequency Stability	19975 to 20375	19975, 20375	5 MHz	QPSK	6 RB / 0 RB Offset		
		20000 to 20350	20000, 20350	10 MHz	QPSK	6 RB / 0 RB Offset		
		20025 to 20325	20025, 20325	15 MHz	QPSK	6 RB / 0 RB Offset		
		20050 to 20300	20050, 20300	20 MHz	QPSK	6 RB / 0 RB Offset		
-	Occupied Bandwidth	19975 to 20375	19975, 20175, 20375	5 MHz	QPSK, 16QAM	6 RB / 0 RB Offset		
		20000 to 20350	20000, 20175, 20350	10 MHz	QPSK, 16QAM	6 RB / 0 RB Offset		
		20025 to 20325	20025, 20175, 20325	15 MHz	QPSK, 16QAM	6 RB / 0 RB Offset		
		20050 to 20300	20050, 20175, 20300	20 MHz	QPSK, 16QAM	6 RB / 0 RB Offset		
-	Peak to Average Ratio	19975 to 20375	19975, 20175, 20375	5 MHz	QPSK, 16QAM	5 RB / 0 RB Offset		
		20000 to 20350	20000, 20175, 20350	10 MHz	QPSK, 16QAM	1 RB / 5 RB Offset		
		20025 to 20325	20025, 20175, 20325	15 MHz	QPSK, 16QAM	1 RB / 0 RB Offset		
		20050 to 20300	20050, 20175, 20300	20 MHz	QPSK, 16QAM	1 RB / 0 RB Offset		
-	Band Edge	19975 to 20375	19975	5 MHz	QPSK	1 RB / 0 RB Offset		
			20375	5 MHz	QPSK	6 RB / 0 RB Offset		
		20000 to 20350	20000	10 MHz	QPSK	1 RB / 5 RB Offset		
			20350	10 MHz	QPSK	6 RB / 0 RB Offset		
		20025 to 20325	20025	15 MHz	QPSK	1 RB / 0 RB Offset		
			20325	15 MHz	QPSK	6 RB / 0 RB Offset		
		20050 to 20300	20050	20 MHz	QPSK	1 RB / 5 RB Offset		
			20300	20 MHz	QPSK	6 RB / 0 RB Offset		
		-	Conducted Emission	19975 to 20375	19975, 20175, 20375	5 MHz	QPSK	5 RB / 0 RB Offset
				20000 to 20350	20000, 20175, 20350	10 MHz	QPSK	1 RB / 5 RB Offset
				20025 to 20325	20025, 20175, 20325	15 MHz	QPSK	1 RB / 0 RB Offset
				20050 to 20300	20050, 20175, 20300	20 MHz	QPSK	1 RB / 0 RB Offset
-	Radiated Emission	19975 to 20375	19975, 20175, 20375	5 MHz	QPSK	5 RB / 0 RB Offset		
		20050 to 20300	20050, 20175, 20300	20 MHz	QPSK	1 RB / 0 RB Offset		

Note:

1. This device was tested under all bandwidths, RB configurations and modulations. The worst case was found in QPSK modulation.
2. For radiated emission above 1 GHz, according to 3GPP 36.521 Section 6.6.3.1.4, choose the lowest, 5 MHz & highest channel bandwidth for final test.

LTE Band 12

EUT Configure Mode	Test Item	Available Channel	Tested Channel	Channel Bandwidth	Modulation	Mode
-	ERP	23035 to 23155	23035, 23095, 23155	5 MHz	QPSK, 16QAM	1 RB / 0 RB Offset
		23060 to 23130	23060, 23095, 23130	10 MHz	QPSK, 16QAM	1 RB / 5 RB Offset
-	Modulation Characteristics	23060 to 23130	23095	10 MHz	QPSK, 16QAM	1 RB / 0 RB Offset
-	Frequency Stability	23035 to 23155	23035, 23155	5 MHz	QPSK	6 RB / 0 RB Offset
		23060 to 23130	23060, 23130	10 MHz	QPSK	6 RB / 0 RB Offset
-	Occupied Bandwidth	23035 to 23155	23035, 23095, 23155	5 MHz	QPSK, 16QAM	6 RB / 0 RB Offset
		23060 to 23130	23060, 23095, 23130	10 MHz	QPSK, 16QAM	6 RB / 0 RB Offset
-	Peak to Average Ratio	23035 to 23155	23035, 23095, 23155	5 MHz	QPSK, 16QAM	1 RB / 0 RB Offset
		23060 to 23130	23060, 23095, 23130	10 MHz	QPSK, 16QAM	1 RB / 0 RB Offset
-	Band Edge	23035 to 23155	23035	5 MHz	QPSK	1 RB / 0 RB Offset
			23155	5 MHz	QPSK	6 RB / 0 RB Offset
		23060 to 23130	23060	10 MHz	QPSK	1 RB / 0 RB Offset
			23130	10 MHz	QPSK	6 RB / 0 RB Offset
						1 RB / 5 RB Offset
						6 RB / 0 RB Offset
-	Conducted Emission	23035 to 23155	23035, 23095, 23155	5 MHz	QPSK	1 RB / 0 RB Offset
		23060 to 23130	23060, 23095, 23130	10 MHz	QPSK	1 RB / 5 RB Offset
-	Radiated Emission	23035 to 23155	23035, 23095, 23155	5 MHz	QPSK	1 RB / 0 RB Offset
		23060 to 23130	23060, 23095, 23130	10 MHz	QPSK	1 RB / 5 RB Offset

Note:

1. This device was tested under all bandwidths, RB configurations and modulations. The worst case was found in QPSK modulation.
2. For radiated emission above 1 GHz, according to 3GPP 36.521 Section 6.6.3.1.4, choose the lowest, 5 MHz & highest channel bandwidth for final test.

LTE Band 13

EUT Configure Mode	Test Item	Available Channel	Tested Channel	Channel Bandwidth	Modulation	Mode
-	ERP	23205 to 23255	23205, 23230, 23255	5 MHz	QPSK, 16QAM	1 RB / 5 RB Offset
		23230	23230	10 MHz	QPSK, 16QAM	1 RB / 0 RB Offset
-	Modulation Characteristics	23230	23230	10 MHz	QPSK, 16QAM	1 RB / 0 RB Offset
-	Frequency Stability	23205 to 23255	23205, 23255	5 MHz	QPSK	6 RB / 0 RB Offset
		23230	23230	10 MHz	QPSK	6 RB / 0 RB Offset
-	Occupied Bandwidth	23205 to 23255	23205, 23230, 23255	5 MHz	QPSK, 16QAM	6 RB / 0 RB Offset
		23230	23230	10 MHz	QPSK, 16QAM	6 RB / 0 RB Offset
-	Peak to Average Ratio	23205 to 23255	23205, 23230, 23255	5 MHz	QPSK, 16QAM	1 RB / 5 RB Offset
		23230	23230	10 MHz	QPSK, 16QAM	1 RB / 0 RB Offset
-	Band Edge	23205 to 23255	23205	5 MHz	QPSK	1 RB / 0 RB Offset
			23255	5 MHz	QPSK	6 RB / 0 RB Offset
		23230	23230	10 MHz	QPSK	1 RB / 5 RB Offset
			23230	10 MHz	QPSK	6 RB / 0 RB Offset
		23205 to 23255	23205, 23230, 23255	5 MHz	QPSK	1 RB / 5 RB Offset
			23230	23230	10 MHz	QPSK
-	Conducted Emission	23205 to 23255	23205, 23230, 23255	5 MHz	QPSK	1 RB / 5 RB Offset
		23230	23230	10 MHz	QPSK	1 RB / 0 RB Offset
-	Radiated Emission	23205 to 23255	23205, 23230, 23255	5 MHz	QPSK	1 RB / 5 RB Offset
		23230	23230	10 MHz	QPSK	1 RB / 0 RB Offset

Note:

1. This device was tested under all bandwidths, RB configurations and modulations. The worst case was found in QPSK modulation.
2. For radiated emission above 1 GHz, according to 3GPP 36.521 Section 6.6.3.1.4, choose the lowest, 5 MHz & highest channel bandwidth for final test.

Test Condition:

Test Item	Environmental Conditions	Input Power	Tested By
ERP / EIRP	25 deg. C, 65 % RH	3.8 Vdc	Thomas Wei
Modulation Characteristics	25 deg. C, 65 % RH	3.8 Vdc	Getaz Yang
Frequency Stability	25 deg. C, 65 % RH	3.8 Vdc	Getaz Yang
Occupied Bandwidth	25 deg. C, 65 % RH	3.8 Vdc	Getaz Yang
Band Edge	25 deg. C, 65 % RH	3.8 Vdc	Getaz Yang
Peak to Average Ratio	25 deg. C, 65 % RH	3.8 Vdc	Getaz Yang
Conducted Emission	25 deg. C, 65 % RH	3.8 Vdc	Getaz Yang
Radiated Emission	25 deg. C, 65 % RH	120 Vac, 60 Hz	Thomas Wei

3.4 EUT Operating Conditions

The EUT makes a call to the communication simulator. The communication simulator station system controlled a EUT to export maximum output power under transmission mode and specific channel frequency

3.5 General Description of Applied Standards

The EUT is a RF Product. According to the specifications of the manufacturer, it must comply with the requirements of the following standards:

FCC 47 CFR Part 2

FCC 47 CFR Part 27

KDB 971168 D01 Power Meas License Digital Systems v03r01

ANSI/TIA/EIA-603-E 2016

ANSI 63.26-2015

Note: All test items have been performed and recorded as per the above standards.

4 Test Types and Results

4.1 Output Power Measurement

4.1.1 Limits of Output Power Measurement

Fixed, mobile, and portable (hand-held) stations operating in the 1710–1755 MHz band and mobile and portable stations operating in the 1695-1710 MHz and 1755-1780 MHz bands are limited to 1 watt EIRP.

Portable stations (hand-held devices) operating in the 746-757 MHz, 776-788 MHz and 805-806 MHz band are limited to 3 watts ERP

Portable stations (hand-held device) operating in the 600 MHz uplink band and the 698-746 MHz band, and fixed and mobile stations in the 600 MHz uplink band are limited to 3 watts ERP.

4.1.2 Test Procedures

EIRP / ERP Measurement:

- a. All measurements were done at low, middle and high operational frequency range. RBW and VBW is 10 MHz for LTE mode.
- b. Substitution method is used for E.I.R.P measurement. In the semi-anechoic chamber, EUT placed on the 0.8 m (below or equal 1 GHz) and/or 1.5 m (above 1 GHz) height of Turn Table, rotated the table around 360 degrees to search the maximum radiation power and receiver antenna shall be rotated vertical and horizontal polarization and moved height from 1 m to 4 m to find the maximum polar radiated power. The “Read Value” is the spectrum reading the maximum power value.
- c. The substitution horn antenna is substituted for EUT at the same position and signals generator export the CW signal to the substitution antenna via a tx cable. Rotated the Turn Table and moved receiving antenna to find the maximum radiation power. Adjust output power level of S.G to get a Value of spectrum reading equal to “Read Value” of step b. Record the power level of S.G.
- d. $EIRP = \text{Output power level of S.G} - \text{TX cable loss} + \text{Antenna gain of substitution horn}$. E.R.P power can be calculated form E.I.R.P power by subtracting the gain of dipole, $E.R.P \text{ power} = E.I.R.P \text{ power} - 2.15 \text{ dB}$.

Conducted Power Measurement:

- a. The EUT was set up for the maximum power with WCDMA and LTE link data modulation and link up with simulator.
- b. Set the EUT to transmit under low, middle and high channel and record the power level shown on simulator.

4.1.3 Test Setup

EIRP / ERP Measurement:

<Radiated Emission below or equal 1 GHz>

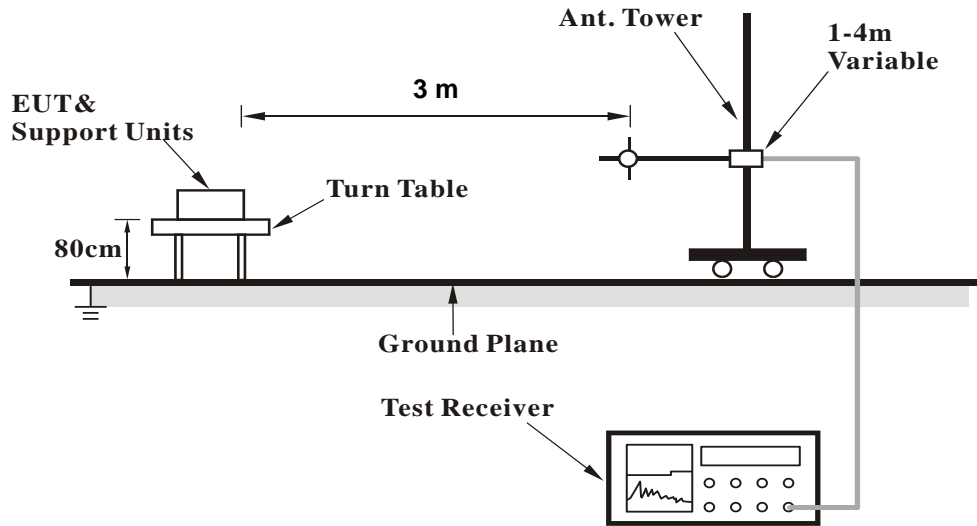

<Radiated Emission above 1 GHz>

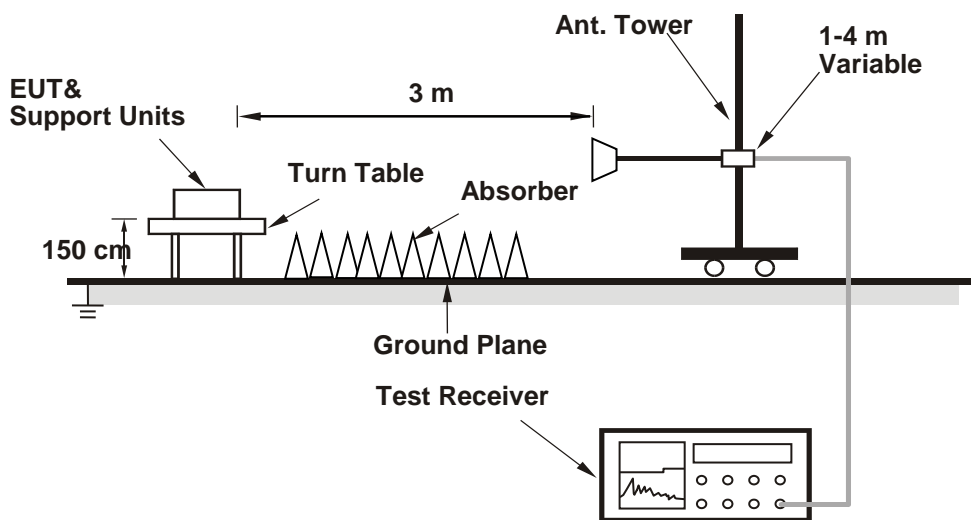

For the actual test configuration, please refer to the attached file (Test Setup Photo).

Conducted Power Measurement:

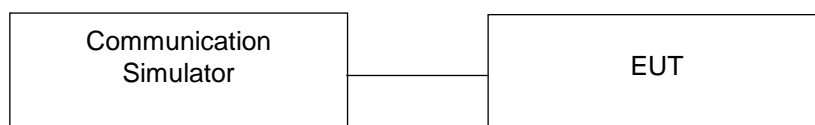

4.1.4 Test Results

Conducted Output Power (dBm)

LTE Band 4

BW (MHz): 5										
Test Frequency ID	N _{UL}	Frequency of Uplink [MHz]	N _{DL}	Frequency of Downlink [MHz]	Test Configuration Initial of Power				EUT	
					Modulation	RB Size	RB Offset	Narrowband Index	Cell power (dBm/15kHz)	power (dBm)
Low Range	19975	1712.5	1975	2112.5	QPSK	1	0	0	-85	22.39
					QPSK	1	5	0	-85	22.27
					QPSK	1	0	1	-85	22.35
					QPSK	1	5	1	-85	22.29
					QPSK	1	0	3	-85	22.34
					QPSK	1	5	3	-85	22.32
					QPSK	3	0	0	-85	21.46
					QPSK	3	3	3	-85	21.65
					QPSK	6	0	0	-85	21.53
					QPSK	6	0	1	-85	21.58
					QPSK	6	0	3	-85	21.61
					16QAM	1	0	0	-85	22.36
					16QAM	1	5	0	-85	22.41
					16QAM	1	0	1	-85	22.72
					16QAM	1	5	1	-85	22.66
					16QAM	1	0	3	-85	22.78
					16QAM	1	5	3	-85	22.81
					16QAM	3	0	0	-85	21.47
					16QAM	3	3	3	-85	21.96
					16QAM	5	0	0	-85	21.49
16QAM	5	0	1	-85	20.67					
16QAM	5	0	3	-85	20.81					
Mid Range	20175	1732.5	2175	2132.5	QPSK	1	0	0	-85	22.42
					QPSK	1	5	0	-85	22.53
					QPSK	1	0	1	-85	22.54
					QPSK	1	5	1	-85	22.67
					QPSK	1	0	3	-85	22.57
					QPSK	1	5	3	-85	22.67
					QPSK	3	0	0	-85	21.74
					QPSK	3	3	3	-85	21.78
					QPSK	6	0	0	-85	21.75
					QPSK	6	0	1	-85	22.72
					QPSK	6	0	3	-85	21.72
					16QAM	1	0	0	-85	22.78
					16QAM	1	5	0	-85	22.87
					16QAM	1	0	1	-85	22.89
					16QAM	1	5	1	-85	22.88
					16QAM	1	0	3	-85	22.67
					16QAM	1	5	3	-85	22.52
					16QAM	3	0	0	-85	22.61
					16QAM	3	3	3	-85	21.76
					16QAM	5	0	0	-85	22.97
16QAM	5	0	1	-85	20.97					
16QAM	5	0	3	-85	21.71					

Test Frequency ID	N _{UL}	Frequency of Uplink [MHz]	N _{DL}	Frequency of Downlink [MHz]	Test Configuration Initial of Power				EUT	
					Modulation	RB Size	RB Offset	Narrowband Index	Cell power (dBm/15kHz)	power (dBm)
High Range	20375	1752.5	2375	2152.5	QPSK	1	0	0	-85	22.39
					QPSK	1	5	0	-85	22.38
					QPSK	1	0	1	-85	22.39
					QPSK	1	5	1	-85	22.34
					QPSK	1	0	3	-85	22.39
					QPSK	1	5	3	-85	22.37
					QPSK	3	0	0	-85	21.57
					QPSK	3	3	3	-85	21.61
					QPSK	6	0	0	-85	21.59
					QPSK	6	0	1	-85	21.58
					QPSK	6	0	3	-85	21.58
					16QAM	1	0	0	-85	22.74
					16QAM	1	5	0	-85	22.77
					16QAM	1	0	1	-85	22.74
					16QAM	1	5	1	-85	22.88
					16QAM	1	0	3	-85	22.94
					16QAM	1	5	3	-85	22.88
					16QAM	3	0	0	-85	21.87
					16QAM	3	3	3	-85	21.84
					16QAM	5	0	0	-85	20.82
16QAM	5	0	1	-85	20.89					
16QAM	5	0	3	-85	20.87					

BW (MHz): 10										
Test Frequency ID	N _{UL}	Frequency of Uplink [MHz]	N _{DL}	Frequency of Downlink [MHz]	Test Configuration Initial of Power				EUT	
					Modulation	RB Size	RB Offset	Narrowband Index	Cell power (dBm/15kHz)	power (dBm)
Low Range	20000	1715	2000	2115	QPSK	1	0	0	-85	22.34
					QPSK	1	5	0	-85	22.35
					QPSK	1	0	3	-85	22.41
					QPSK	1	5	3	-85	22.38
					QPSK	1	0	7	-85	22.47
					QPSK	1	5	7	-85	22.35
					QPSK	4	0	0	-85	22.25
					QPSK	4	2	7	-85	22.39
					QPSK	6	0	0	-85	21.37
					QPSK	6	0	7	-85	21.54
					16QAM	1	0	0	-85	22.86
					16QAM	1	5	0	-85	21.86
					16QAM	1	0	3	-85	21.97
					16QAM	1	5	3	-85	21.96
					16QAM	1	0	7	-85	22.11
					16QAM	1	5	7	-85	22.8
					16QAM	4	2	0	-85	21.21
					16QAM	4	2	7	-85	21.8
16QAM	5	0	0	-85	21.98					
16QAM	5	0	7	-85	21.49					
Mid Range	20175	1732.5	2175	2132.5	QPSK	1	0	0	-85	22.58
					QPSK	1	5	0	-85	22.44
					QPSK	1	0	3	-85	22.71
					QPSK	1	5	3	-85	22.71
					QPSK	1	0	7	-85	22.7
					QPSK	1	5	7	-85	22.68
					QPSK	4	0	0	-85	22.38
					QPSK	4	2	7	-85	22.72
					QPSK	6	0	0	-85	21.99
					QPSK	6	0	7	-85	21.81
					16QAM	1	0	0	-85	22.9
					16QAM	1	5	0	-85	22.87
					16QAM	1	0	3	-85	22.81
					16QAM	1	5	3	-85	22.56
					16QAM	1	0	7	-85	22.8
					16QAM	1	5	7	-85	22.73
					16QAM	4	2	0	-85	21.81
					16QAM	4	2	7	-85	21.81
16QAM	5	0	0	-85	22.01					
16QAM	5	0	7	-85	21.89					
High Range	20350	1750	2350	2150	QPSK	1	0	0	-85	22.43
					QPSK	1	5	0	-85	22.53
					QPSK	1	5	7	-85	22.42
					QPSK	1	0	3	-85	22.45
					QPSK	1	5	3	-85	22.42
					QPSK	1	0	7	-85	22.43
					QPSK	4	0	0	-85	22.55
					QPSK	4	2	7	-85	22.47
					QPSK	6	0	0	-85	21.67
					QPSK	6	0	7	-85	21.57
					16QAM	1	0	0	-85	22.62
					16QAM	1	5	0	-85	22.59
					16QAM	1	0	3	-85	22.55
					16QAM	1	5	3	-85	22.54
					16QAM	1	0	7	-85	22.53
					16QAM	1	5	7	-85	22.52
					16QAM	4	2	0	-85	21.69
					16QAM	4	2	7	-85	21.62
16QAM	5	0	0	-85	21.66					
16QAM	5	0	7	-85	21.61					

BW (MHz): 15										
Test Frequency ID	N _{UL}	Frequency of Uplink [MHz]	N _{DL}	Frequency of Downlink [MHz]	Test Configuration Initial of Power				EUT	
					Modulation	RB Size	RB Offset	Narrowband Index	Cell power (dBm/15kHz)	power (dBm)
Low Range	20025	1717.5	2025	2117.5	QPSK	1	0	0	-85	22.62
					QPSK	1	5	0	-85	22.61
					QPSK	1	0	5	-85	22.71
					QPSK	1	5	5	-85	22.69
					QPSK	1	0	11	-85	22.79
					QPSK	1	5	11	-85	22.81
					QPSK	3	0	0	-85	22.61
					QPSK	3	3	11	-85	22.8
					QPSK	6	0	0	-85	22.64
					QPSK	6	0	11	-85	22.81
					16QAM	1	0	0	-85	22.92
					16QAM	1	5	0	-85	22.91
					16QAM	1	0	5	-85	22.96
					16QAM	1	5	5	-85	22.98
					16QAM	1	0	11	-85	23.01
					16QAM	1	5	11	-85	22.84
16QAM	3	0	0	-85	22.84					
16QAM	3	3	11	-85	22.98					
16QAM	5	0	0	-85	22.65					
16QAM	5	0	11	-85	22.84					
Mid Range	20175	1732.5	2175	2132.5	QPSK	1	0	0	-85	22.81
					QPSK	1	5	0	-85	22.73
					QPSK	1	0	5	-85	22.79
					QPSK	1	5	5	-85	22.72
					QPSK	1	0	11	-85	22.62
					QPSK	1	5	11	-85	22.67
					QPSK	3	0	0	-85	22.79
					QPSK	3	3	11	-85	22.63
					QPSK	6	0	0	-85	22.8
					QPSK	6	0	11	-85	22.65
					16QAM	1	0	0	-85	23.06
					16QAM	1	5	0	-85	23.01
					16QAM	1	0	5	-85	22.97
					16QAM	1	5	5	-85	22.99
					16QAM	1	0	11	-85	22.72
					16QAM	1	5	11	-85	22.71
16QAM	3	0	0	-85	22.94					
16QAM	3	3	11	-85	22.79					
16QAM	5	0	0	-85	22.86					
16QAM	5	0	11	-85	22.64					
High Range	20325	1747.5	2325	2147.5	QPSK	1	0	0	-85	22.67
					QPSK	1	5	11	-85	22.56
					QPSK	1	0	5	-85	22.52
					QPSK	1	5	5	-85	22.45
					QPSK	1	0	11	-85	22.44
					QPSK	1	5	11	-85	22.56
					QPSK	3	0	0	-85	22.59
					QPSK	3	3	11	-85	22.43
					QPSK	6	0	0	-85	22.59
					QPSK	6	0	11	-85	22.43
					16QAM	1	0	0	-85	22.73
					16QAM	1	5	0	-85	22.63
					16QAM	1	0	5	-85	22.56
					16QAM	1	5	5	-85	22.63
					16QAM	1	0	11	-85	22.56
					16QAM	1	5	11	-85	22.42
16QAM	3	0	0	-85	22.61					
16QAM	3	3	11	-85	22.58					
16QAM	5	0	0	-85	22.67					
16QAM	5	0	11	-85	22.41					

BW (MHz): 20

Test Frequency ID	N _{UL}	Frequency of Uplink [MHz]	N _{DL}	Frequency of Downlink [MHz]	Test Configuration Initial of Power				EUT	
					Modulation	RB Size	RB Offset	Narrowband Index	Cell power (dBm/15kHz)	power (dBm)
Low Range	20050	1720	2050	2120	QPSK	1	0	0	-85	22.62
					QPSK	1	5	0	-85	22.62
					QPSK	1	0	7	-85	22.81
					QPSK	1	5	7	-85	22.7
					QPSK	1	0	15	-85	22.8
					QPSK	1	5	15	-85	22.73
					QPSK	3	0	0	-85	22.63
					QPSK	3	3	15	-85	22.76
					QPSK	6	0	0	-85	22.65
					QPSK	6	0	15	-85	22.78
					16QAM	1	0	0	-85	22.72
					16QAM	1	5	0	-85	22.92
					16QAM	1	0	7	-85	23.03
					16QAM	1	5	7	-85	22.83
					16QAM	1	0	15	-85	22.83
					16QAM	1	5	15	-85	22.86
					16QAM	3	0	0	-85	22.79
					16QAM	3	3	15	-85	22.89
16QAM	5	0	0	-85	22.71					
16QAM	5	0	15	-85	22.81					
Mid Range	20175	1732.5	2175	2132.5	QPSK	1	0	0	-85	22.77
					QPSK	1	5	0	-85	22.77
					QPSK	1	0	7	-85	22.77
					QPSK	1	5	7	-85	22.72
					QPSK	1	0	15	-85	22.62
					QPSK	1	5	15	-85	22.6
					QPSK	3	0	0	-85	22.81
					QPSK	3	3	15	-85	22.64
					QPSK	6	0	0	-85	22.82
					QPSK	6	0	15	-85	22.66
					16QAM	1	0	0	-85	23.07
					16QAM	1	5	0	-85	22.91
					16QAM	1	0	7	-85	22.9
					16QAM	1	5	7	-85	22.99
					16QAM	1	0	15	-85	22.78
					16QAM	1	5	15	-85	22.85
					16QAM	3	0	0	-85	22.8
					16QAM	3	3	15	-85	22.73
16QAM	5	0	0	-85	22.74					
16QAM	5	0	15	-85	22.69					
High Range	20300	1745	2300	2145	QPSK	1	0	0	-85	22.65
					QPSK	1	5	0	-85	22.64
					QPSK	1	0	7	-85	22.55
					QPSK	1	5	7	-85	22.52
					QPSK	1	0	15	-85	22.43
					QPSK	1	5	15	-85	22.41
					QPSK	3	0	0	-85	22.67
					QPSK	3	3	15	-85	22.44
					QPSK	6	0	0	-85	22.73
					QPSK	6	0	15	-85	22.45
					16QAM	1	0	0	-85	22.85
					16QAM	1	5	0	-85	22.84
					16QAM	1	0	7	-85	22.72
					16QAM	1	5	7	-85	22.74
					16QAM	1	0	15	-85	22.62
					16QAM	1	5	15	-85	22.55
					16QAM	3	0	0	-85	22.94
					16QAM	3	3	15	-85	22.71
16QAM	5	0	0	-85	22.75					
16QAM	5	0	15	-85	22.48					

LTE Band 12

BW (MHz): 5										
Test Frequency ID	N _{UL}	Frequency of Uplink [MHz]	N _{DL}	Frequency of Downlink [MHz]	Test Configuration Initial of Power				EUT	
					Modulation	RB Size	RB Offset	Narrowband Index	Cell power (dBm/15kHz)	power (dBm)
Low Range	23035	701.5	5035	731.5	QPSK	1	0	0	-85	23.31
					QPSK	1	5	0	-85	23.34
					QPSK	1	0	1	-85	23.31
					QPSK	1	5	1	-85	23.32
					QPSK	1	0	3	-85	23.36
					QPSK	1	5	3	-85	23.33
					QPSK	3	0	0	-85	22.22
					QPSK	3	3	3	-85	22.31
					QPSK	6	0	0	-85	22.23
					QPSK	6	0	1	-85	22.29
					QPSK	6	0	3	-85	22.31
					16QAM	1	0	0	-85	23.76
					16QAM	1	5	0	-85	23.78
					16QAM	1	0	1	-85	23.71
					16QAM	1	5	1	-85	23.72
					16QAM	1	0	3	-85	23.74
					16QAM	1	5	3	-85	23.79
					16QAM	3	0	0	-85	22.64
					16QAM	3	3	3	-85	22.66
					16QAM	5	0	0	-85	21.38
16QAM	5	0	1	-85	21.46					
16QAM	5	0	3	-85	21.43					
Mid Range	23095	707.5	5095	737.5	QPSK	1	0	0	-85	23.39
					QPSK	1	5	0	-85	23.46
					QPSK	1	0	1	-85	23.4
					QPSK	1	5	1	-85	23.4
					QPSK	1	0	3	-85	23.46
					QPSK	1	5	3	-85	23.41
					QPSK	3	0	0	-85	22.37
					QPSK	3	3	3	-85	22.39
					QPSK	6	0	0	-85	22.44
					QPSK	6	0	1	-85	22.39
					QPSK	6	0	3	-85	22.38
					16QAM	1	0	0	-85	23.77
					16QAM	1	5	0	-85	23.85
					16QAM	1	0	1	-85	23.9
					16QAM	1	5	1	-85	23.74
					16QAM	1	0	3	-85	23.91
					16QAM	1	5	3	-85	23.86
					16QAM	3	0	0	-85	22.73
					16QAM	3	3	3	-85	22.69
					16QAM	5	0	0	-85	21.49
16QAM	5	0	1	-85	21.53					
16QAM	5	0	3	-85	21.56					

Test Frequency ID	N _{UL}	Frequency of Uplink [MHz]	N _{DL}	Frequency of Downlink [MHz]	Test Configuration Initial of Power				EUT	
					Modulation	RB Size	RB Offset	Narrowband Index	Cell power (dBm/15kHz)	power (dBm)
High Range	23155	713.5	5155	743.5	QPSK	1	0	0	-85	23.49
					QPSK	1	5	0	-85	23.48
					QPSK	1	0	1	-85	23.52
					QPSK	1	5	1	-85	23.52
					QPSK	1	0	3	-85	23.53
					QPSK	1	5	3	-85	23.52
					QPSK	3	0	0	-85	22.48
					QPSK	3	3	3	-85	22.53
					QPSK	6	0	0	-85	22.45
					QPSK	6	0	1	-85	22.49
					QPSK	6	0	3	-85	22.51
					16QAM	1	0	0	-85	23.75
					16QAM	1	5	0	-85	23.89
					16QAM	1	0	1	-85	23.72
					16QAM	1	5	1	-85	23.89
					16QAM	1	0	3	-85	23.88
					16QAM	1	5	3	-85	23.91
					16QAM	3	0	0	-85	22.83
					16QAM	3	3	3	-85	22.86
					16QAM	5	0	0	-85	21.69
16QAM	5	0	1	-85	21.65					
16QAM	5	0	3	-85	21.65					

BW (MHz): 10										
Test Frequency ID	N _{UL}	Frequency of Uplink [MHz]	N _{DL}	Frequency of Downlink [MHz]	Test Configuration Initial of Power				EUT	
					Modulation	RB Size	RB Offset	Narrowband Index	Cell power (dBm/15kHz)	power (dBm)
Low Range	23060	704	5060	734	QPSK	1	0	0	-85	23.31
					QPSK	1	5	0	-85	23.33
					QPSK	1	0	3	-85	23.41
					QPSK	1	5	3	-85	23.42
					QPSK	1	0	7	-85	23.45
					QPSK	1	5	7	-85	23.47
					QPSK	4	0	0	-85	23.32
					QPSK	4	2	7	-85	23.5
					QPSK	6	0	0	-85	22.32
					QPSK	6	0	7	-85	22.42
					16QAM	1	0	0	-85	23.8
					16QAM	1	5	0	-85	23.81
					16QAM	1	0	3	-85	23.85
					16QAM	1	5	3	-85	23.85
					16QAM	1	0	7	-85	23.84
					16QAM	1	5	7	-85	23.84
					16QAM	4	2	0	-85	22.45
					16QAM	4	2	7	-85	22.69
16QAM	5	0	0	-85	22.49					
16QAM	5	0	7	-85	22.59					
Mid Range	23095	707.5	5095	737.5	QPSK	1	0	0	-85	23.43
					QPSK	1	5	0	-85	23.44
					QPSK	1	0	3	-85	23.45
					QPSK	1	5	3	-85	23.45
					QPSK	1	0	7	-85	23.51
					QPSK	1	5	7	-85	23.45
					QPSK	4	0	0	-85	23.45
					QPSK	4	2	7	-85	23.48
					QPSK	6	0	0	-85	22.44
					QPSK	6	0	7	-85	22.46
					16QAM	1	0	0	-85	23.76
					16QAM	1	5	0	-85	23.95
					16QAM	1	0	3	-85	23.78
					16QAM	1	5	3	-85	23.97
					16QAM	1	0	7	-85	23.77
					16QAM	1	5	7	-85	23.85
					16QAM	4	2	0	-85	22.55
					16QAM	4	2	7	-85	22.53
16QAM	5	0	0	-85	22.61					
16QAM	5	0	7	-85	22.71					
High Range	23130	711	5130	741	QPSK	1	0	0	-85	23.48
					QPSK	1	5	0	-85	23.49
					QPSK	1	5	7	-85	23.52
					QPSK	1	0	3	-85	23.47
					QPSK	1	5	3	-85	23.53
					QPSK	1	0	7	-85	23.51
					QPSK	4	0	0	-85	23.56
					QPSK	4	2	7	-85	23.56
					QPSK	6	0	0	-85	22.51
					QPSK	6	0	7	-85	22.51
					16QAM	1	0	0	-85	23.82
					16QAM	1	5	0	-85	23.92
					16QAM	1	0	3	-85	23.83
					16QAM	1	5	3	-85	23.77
					16QAM	1	0	7	-85	23.81
					16QAM	1	5	7	-85	23.81
					16QAM	4	2	0	-85	22.66
					16QAM	4	2	7	-85	22.63
16QAM	5	0	0	-85	22.71					
16QAM	5	0	7	-85	22.72					

LTE Band 13

BW (MHz): 5										
Test Frequency ID	N _{UL}	Frequency of Uplink [MHz]	N _{DL}	Frequency of Downlink [MHz]	Test Configuration Initial of Power				EUT	
					Modulation	RB Size	RB Offset	Narrowband Index	Cell power (dBm/15kHz)	power (dBm)
Low Range	23205	779.5	5205	748.5	QPSK	1	0	0	-85	23.38
					QPSK	1	5	0	-85	23.42
					QPSK	1	0	1	-85	23.38
					QPSK	1	5	1	-85	23.35
					QPSK	1	0	3	-85	23.31
					QPSK	1	5	3	-85	23.33
					QPSK	3	0	0	-85	22.49
					QPSK	3	3	3	-85	22.43
					QPSK	6	0	0	-85	22.51
					QPSK	6	0	1	-85	22.49
					QPSK	6	0	3	-85	22.49
					16QAM	1	0	0	-85	23.11
					16QAM	1	5	0	-85	23.21
					16QAM	1	0	1	-85	23.27
					16QAM	1	5	1	-85	23.24
					16QAM	1	0	3	-85	22.88
					16QAM	1	5	3	-85	22.96
					16QAM	3	0	0	-85	22.48
					16QAM	3	3	3	-85	22.51
					16QAM	5	0	0	-85	21.76
16QAM	5	0	1	-85	21.72					
16QAM	5	0	3	-85	21.67					
Mid Range	23230	782	5230	751	QPSK	1	0	0	-85	23.39
					QPSK	1	5	0	-85	23.34
					QPSK	1	0	1	-85	23.33
					QPSK	1	5	1	-85	23.35
					QPSK	1	0	3	-85	23.32
					QPSK	1	5	3	-85	23.29
					QPSK	3	0	0	-85	22.51
					QPSK	3	3	3	-85	22.48
					QPSK	6	0	0	-85	22.51
					QPSK	6	0	1	-85	22.48
					QPSK	6	0	3	-85	22.46
					16QAM	1	0	0	-85	23.12
					16QAM	1	5	0	-85	23.19
					16QAM	1	0	1	-85	23.16
					16QAM	1	5	1	-85	23.18
					16QAM	1	0	3	-85	23.12
					16QAM	1	5	3	-85	23.17
					16QAM	3	0	0	-85	22.51
					16QAM	3	3	3	-85	22.71
					16QAM	5	0	0	-85	21.64
16QAM	5	0	1	-85	21.55					
16QAM	5	0	3	-85	21.48					

Test Frequency ID	N _{UL}	Frequency of Uplink [MHz]	N _{DL}	Frequency of Downlink [MHz]	Test Configuration Initial of Power				EUT	
					Modulation	RB Size	RB Offset	Narrowband Index	Cell power (dBm/15kHz)	power (dBm)
High Range	23255	784.5	5255	753.5	QPSK	1	0	0	-85	23.36
					QPSK	1	5	0	-85	23.35
					QPSK	1	0	1	-85	23.39
					QPSK	1	5	1	-85	23.24
					QPSK	1	0	3	-85	23.24
					QPSK	1	5	3	-85	23.22
					QPSK	3	0	0	-85	22.46
					QPSK	3	3	3	-85	22.26
					QPSK	6	0	0	-85	22.53
					QPSK	6	0	1	-85	22.45
					QPSK	6	0	3	-85	22.38
					16QAM	1	0	0	-85	23.23
					16QAM	1	5	0	-85	23.13
					16QAM	1	0	1	-85	23.17
					16QAM	1	5	1	-85	23.08
					16QAM	1	0	3	-85	23.07
					16QAM	1	5	3	-85	23.06
					16QAM	3	0	0	-85	22.72
16QAM	3	3	3	-85	22.77					
16QAM	5	0	0	-85	21.49					
16QAM	5	0	1	-85	21.55					
16QAM	5	0	3	-85	21.67					

BW (MHz): 10										
Test Frequency ID	N _{UL}	Frequency of Uplink [MHz]	N _{DL}	Frequency of Downlink [MHz]	Test Configuration Initial of Power				EUT	
					Modulation	RB Size	RB Offset	Narrowband Index	Cell power (dBm/15kHz)	power (dBm)
Mid Range	23230	782	5230	751	QPSK	1	0	0	-85	23.44
					QPSK	1	5	0	-85	23.29
					QPSK	1	0	3	-85	23.34
					QPSK	1	5	3	-85	23.31
					QPSK	1	0	7	-85	23.33
					QPSK	1	5	7	-85	23.27
					QPSK	4	0	0	-85	23.28
					QPSK	4	2	7	-85	23.25
					QPSK	6	0	0	-85	22.32
					QPSK	6	0	7	-85	22.23
					16QAM	1	0	0	-85	23.06
					16QAM	1	5	0	-85	23.01
					16QAM	1	0	3	-85	22.95
					16QAM	1	5	3	-85	22.98
					16QAM	1	0	7	-85	23.08
					16QAM	1	5	7	-85	22.95
					16QAM	4	2	0	-85	22.51
					16QAM	4	2	7	-85	22.56
16QAM	5	0	0	-85	22.72					
16QAM	5	0	7	-85	22.45					

ERP Power (dBm)

LTE Band 12							
Channel Bandwidth: 5 MHz / QPSK							
Plane	Channel	Frequency (MHz)	Reading (dBm)	Correction Factor (dB)	ERP (dBm)	ERP (mW)	Polarization (H/V)
X	23035	701.5	-7.33	30.17	20.69	117.22	H
	23095	707.5	-7.19	30.17	20.83	121.06	
	23155	713.5	-7.25	30.18	20.78	119.67	
	23035	701.5	-15.83	31.96	13.98	25.00	V
	23095	707.5	-15.76	31.98	14.07	25.53	
	23155	713.5	-15.87	32.03	14.01	25.18	
Channel Bandwidth: 5 MHz / 16QAM							
X	23035	701.5	-8.35	30.17	19.67	92.68	H
	23095	707.5	-8.23	30.17	19.79	95.28	
	23155	713.5	-8.29	30.18	19.74	94.19	
	23035	701.5	-16.73	31.96	13.08	20.32	V
	23095	707.5	-16.67	31.98	13.16	20.70	
	23155	713.5	-16.76	32.03	13.12	20.51	

Note: ERP (dBm) = Reading (dBm) + Correction Factor (dB) – 2.15

LTE Band 12							
Channel Bandwidth: 10 MHz / QPSK							
Plane	Channel	Frequency (MHz)	Reading (dBm)	Correction Factor (dB)	ERP (dBm)	ERP (mW)	Polarization (H/V)
X	23060	704.0	-7.10	30.17	20.92	123.59	H
	23095	707.5	-6.93	30.17	21.09	128.53	
	23130	711.0	-7.02	30.18	21.01	126.18	
	23060	704.0	-15.52	31.96	14.29	26.85	V
	23095	707.5	-15.42	31.98	14.41	27.61	
	23130	711.0	-15.55	32.03	14.33	27.10	
Channel Bandwidth: 10 MHz / 16QAM							
X	23060	704.0	-8.11	30.17	19.91	97.95	H
	23095	707.5	-7.92	30.17	20.10	102.33	
	23130	711.0	-8.04	30.18	19.99	99.77	
	23060	704.0	-16.48	31.96	13.33	21.53	V
	23095	707.5	-16.38	31.98	13.45	22.13	
	23130	711.0	-16.53	32.03	13.35	21.63	

Note: ERP (dBm) = Reading (dBm) + Correction Factor (dB) – 2.15

LTE Band 13							
Channel Bandwidth: 5 MHz / QPSK							
Plane	Channel	Frequency (MHz)	Reading (dBm)	Correction Factor (dB)	ERP (dBm)	ERP (mW)	Polarization (H/V)
X	23205	779.5	-10.33	32.24	19.76	94.62	H
	23230	782.0	-10.10	32.17	19.92	98.17	
	23255	784.5	-10.27	32.11	19.69	93.11	
	23205	779.5	-17.66	32.43	12.62	18.28	V
	23230	782.0	-17.45	32.42	12.82	19.14	
	23255	784.5	-17.72	32.46	12.59	18.16	
Channel Bandwidth: 5 MHz / 16QAM							
X	23205	779.5	-11.48	32.24	18.61	72.61	H
	23230	782.0	-11.30	32.17	18.72	74.47	
	23255	784.5	-11.38	32.11	18.58	72.11	
	23205	779.5	-18.84	32.43	11.44	13.93	V
	23230	782.0	-18.51	32.42	11.76	15.00	
	23255	784.5	-19.00	32.46	11.31	13.52	

Note: ERP (dBm) = Reading (dBm) + Correction Factor (dB) – 2.15

LTE Band 13							
Channel Bandwidth: 10 MHz / QPSK							
Plane	Channel	Frequency (MHz)	Reading (dBm)	Correction Factor (dB)	ERP (dBm)	ERP (mW)	Polarization (H/V)
X	23230	782.0	-9.82	32.17	20.20	104.71	H
	23230	782.0	-17.12	32.42	13.15	20.65	V
Channel Bandwidth: 10 MHz / 16QAM							
X	23230	782.0	-11.05	32.17	18.97	78.89	H
	23230	782.0	-18.26	32.42	12.01	15.89	V

Note: ERP (dBm) = Reading (dBm) + Correction Factor (dB) – 2.15

EIRP Power (dBm)

LTE Band 4							
Channel Bandwidth: 5 MHz / QPSK							
Plane	Channel	Frequency (MHz)	Reading (dBm)	Correction Factor (dB)	EIRP (dBm)	EIRP (mW)	Polarization (H/V)
X	19975	1712.5	-13.02	36.45	23.43	220.29	H
	20175	1732.5	-13.40	36.80	23.40	218.78	
	20375	1752.5	-13.76	36.94	23.18	207.97	
	19975	1712.5	-20.09	37.28	17.19	52.36	V
	20175	1732.5	-20.71	37.63	16.92	49.20	
	20375	1752.5	-21.02	37.64	16.62	45.92	
Channel Bandwidth: 5 MHz / 16QAM							
X	19975	1712.5	-14.18	36.45	22.27	168.66	H
	20175	1732.5	-14.57	36.80	22.23	167.11	
	20375	1752.5	-14.86	36.94	22.08	161.44	
	19975	1712.5	-21.15	37.28	16.13	41.02	V
	20175	1732.5	-21.75	37.63	15.88	38.73	
	20375	1752.5	-22.23	37.64	15.41	34.75	

Note: EIRP (dBm) = Reading (dBm) + Correction Factor (dB)

LTE Band 4							
Channel Bandwidth: 10 MHz / QPSK							
Plane	Channel	Frequency (MHz)	Reading (dBm)	Correction Factor (dB)	EIRP (dBm)	EIRP (mW)	Polarization (H/V)
X	20000	1715.0	-12.99	36.64	23.65	231.74	H
	20175	1732.5	-13.10	36.80	23.70	234.42	
	20350	1750.0	-13.32	36.80	23.48	222.84	
	20000	1715.0	-20.01	37.44	17.43	55.34	V
	20175	1732.5	-20.45	37.63	17.18	52.24	
	20350	1750.0	-20.76	37.64	16.88	48.75	
Channel Bandwidth: 10 MHz / 16QAM							
X	20000	1715.0	-14.14	36.64	22.50	177.83	H
	20175	1732.5	-14.33	36.80	22.47	176.60	
	20350	1750.0	-14.48	36.80	22.32	170.61	
	20000	1715.0	-21.03	37.44	16.41	43.75	V
	20175	1732.5	-21.50	37.63	16.13	41.02	
	20350	1750.0	-21.91	37.64	15.73	37.41	

Note: EIRP (dBm) = Reading (dBm) + Correction Factor (dB)

LTE Band 4							
Channel Bandwidth: 15 MHz / QPSK							
Plane	Channel	Frequency (MHz)	Reading (dBm)	Correction Factor (dB)	EIRP (dBm)	EIRP (mW)	Polarization (H/V)
X	20025	1717.5	-12.47	36.45	23.98	250.03	H
	20175	1732.5	-12.88	36.80	23.92	246.60	
	20325	1747.5	-13.12	36.94	23.82	240.99	
	20025	1717.5	-19.54	37.28	17.74	59.43	V
	20175	1732.5	-20.12	37.63	17.51	56.36	
	20325	1747.5	-20.56	37.64	17.08	51.05	
Channel Bandwidth: 15 MHz / 16QAM							
X	20025	1717.5	-13.70	36.45	22.75	188.36	H
	20175	1732.5	-14.12	36.80	22.68	185.35	
	20325	1747.5	-14.40	36.94	22.54	179.47	
	20025	1717.5	-20.56	37.28	16.72	46.99	V
	20175	1732.5	-21.25	37.63	16.38	43.45	
	20325	1747.5	-21.61	37.64	16.03	40.09	

Note: EIRP (dBm) = Reading (dBm) + Correction Factor (dB)

LTE Band 4							
Channel Bandwidth: 20 MHz / QPSK							
Plane	Channel	Frequency (MHz)	Reading (dBm)	Correction Factor (dB)	EIRP (dBm)	EIRP (mW)	Polarization (H/V)
X	20050	1720.0	-12.24	36.45	24.21	263.63	H
	20175	1732.5	-12.64	36.80	24.16	260.62	
	20300	1745.0	-12.84	36.94	24.10	257.04	
	20050	1720.0	-19.27	37.28	18.01	63.24	V
	20175	1732.5	-19.84	37.63	17.79	60.12	
	20300	1745.0	-20.26	37.64	17.38	54.70	
Channel Bandwidth: 20 MHz / 16QAM							
X	20050	1720.0	-13.39	36.45	23.06	202.30	H
	20175	1732.5	-13.78	36.80	23.02	200.45	
	20300	1745.0	-14.10	36.94	22.84	192.31	
	20050	1720.0	-20.26	37.28	17.02	50.35	V
	20175	1732.5	-20.97	37.63	16.66	46.34	
	20300	1745.0	-21.35	37.64	16.29	42.56	

Note: EIRP (dBm) = Reading (dBm) + Correction Factor (dB)

4.2 Modulation Characteristics Measurement

4.2.1 Limits of Modulation Characteristics

N/A

4.2.2 Test Setup



4.2.3 Test Procedure

Connect the EUT to Communication Simulator via the antenna connector. The frequency band is set as EUT supported Modulation and Channels, the EUT output is matched with 50 ohm load, the waveform quality and constellation of the EUT was tested.

4.2.4 Test Results

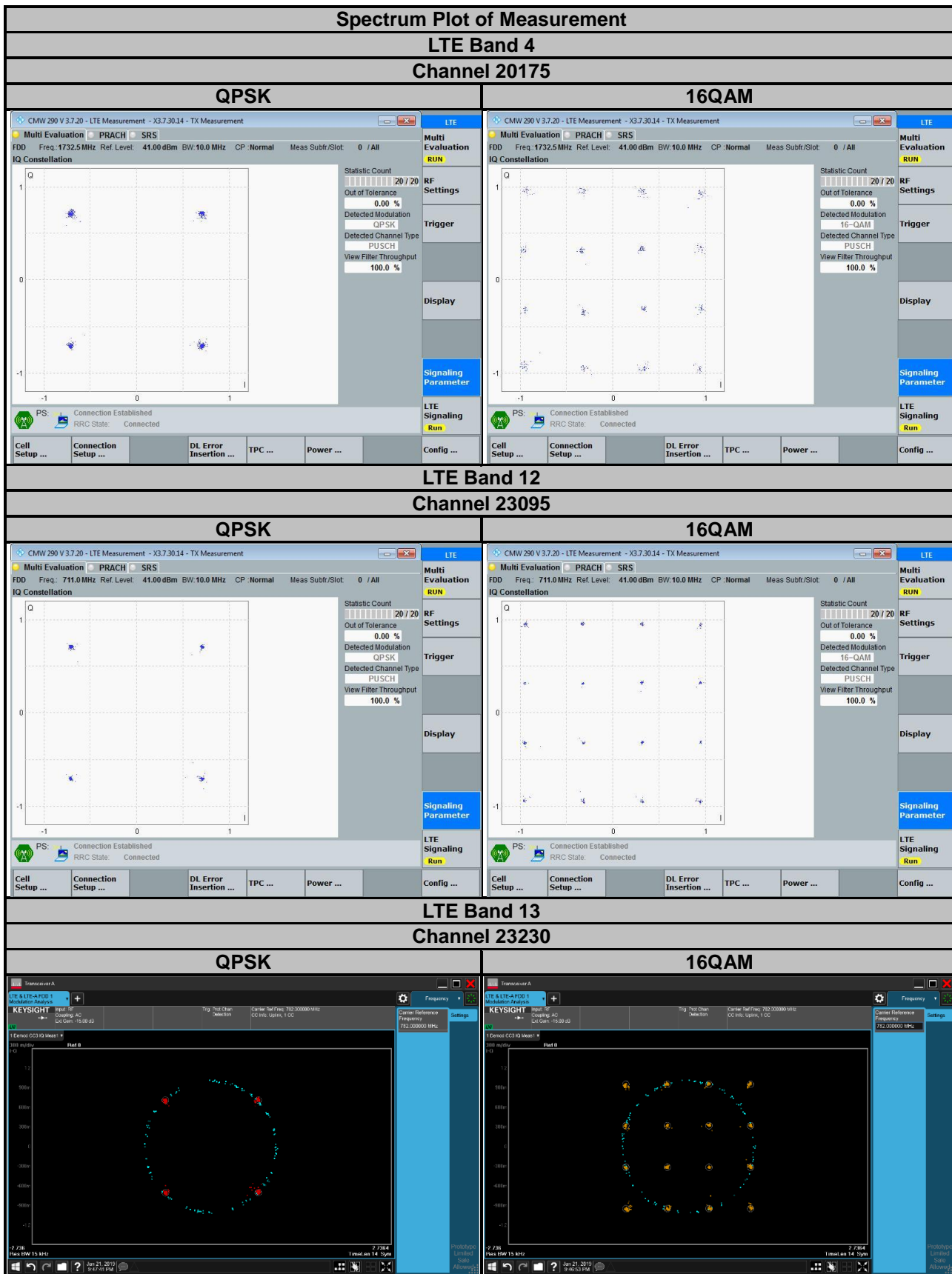

4.3 Frequency Stability Measurement

4.3.1 Limits of Frequency Stability Measurement

The frequency stability shall be sufficient to ensure that the fundamental emissions stay within the authorized bands of operation.

4.3.2 Test Procedure

- Device is placed at the oven room. The oven room could control the temperatures and humidity. Power warm up is at least 15 min and power applied should perform before recording frequency error.
- EUT is connected the external power supply to control the DC input power. The test voltage range is from minimum to maximum working voltage. Each step shall be record the frequency error rate.
- The temperature range step is 10 degrees in this test items. All temperature levels shall be hold the ± 0.5 °C during the measurement testing. The each temperature step shall be at least 0.5 hours, consider the EUT could be test under the stability condition.

Note: The frequency error was recorded frequency error from the communication simulator.

4.3.3 Test Setup

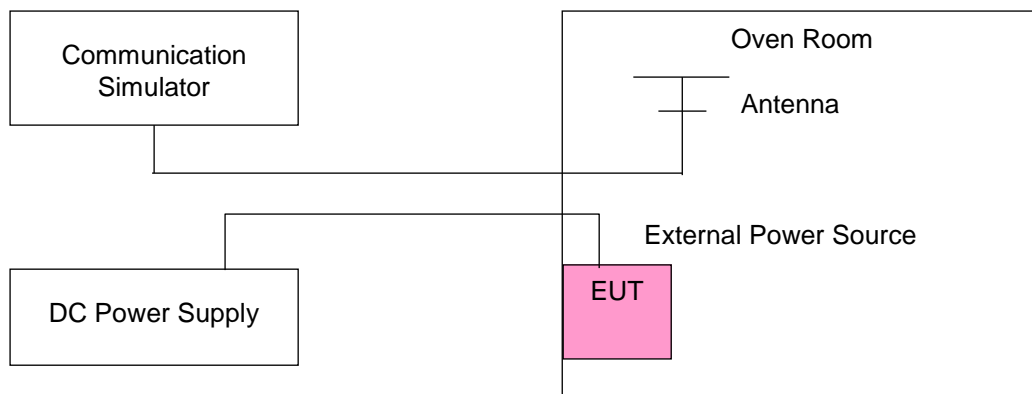

4.3.4 Test Results

Frequency Error vs. Voltage

Voltage (Volts)	LTE Band 4			
	Channel Bandwidth: 5 MHz			
	Low Channel		High Channel	
	Frequency (MHz)	Frequency Error (ppm)	Frequency (MHz)	Frequency Error (ppm)
3.8	1712.500004	0.002	1752.500004	0.002
3.23	1712.500004	0.002	1752.500004	0.002
4.37	1712.500003	0.002	1752.500003	0.002

Note: The applicant defined the normal working voltage of the DC power supply is from 3.23 Vdc to 4.37 Vdc.

Frequency Error vs. Temperature

Temp. (°C)	LTE Band 4			
	Channel Bandwidth: 5 MHz			
	Low Channel		High Channel	
	Frequency (MHz)	Frequency Error (ppm)	Frequency (MHz)	Frequency Error (ppm)
-30	1712.500004	0.002	1752.500002	0.001
-20	1712.500003	0.002	1752.500002	0.001
-10	1712.500004	0.002	1752.500004	0.002
0	1712.500001	0.001	1752.500001	0.001
10	1712.500002	0.001	1752.500003	0.002
20	1712.499998	-0.001	1752.499998	-0.001
30	1712.499997	-0.002	1752.499997	-0.002
40	1712.499997	-0.002	1752.499997	-0.002
50	1712.499997	-0.002	1752.499996	-0.002
60	1712.499998	-0.001	1752.499998	-0.001
70	1712.499998	-0.001	1752.499996	-0.002
80	1712.499998	-0.001	1752.499996	-0.002
85	1712.499997	-0.002	1752.499997	-0.002

Frequency Error vs. Voltage

Voltage (Volts)	LTE Band 4			
	Channel Bandwidth: 10 MHz			
	Low Channel		High Channel	
	Frequency (MHz)	Frequency Error (ppm)	Frequency (MHz)	Frequency Error (ppm)
3.8	1715.000001	0.001	1750.000001	0.001
3.23	1715.000003	0.002	1750.000003	0.002
4.37	1715.000002	0.001	1750.000004	0.002

Note: The applicant defined the normal working voltage of the DC power supply is from 3.23 Vdc to 4.37 Vdc.

Frequency Error vs. Temperature

Temp. (°C)	LTE Band 4			
	Channel Bandwidth: 10 MHz			
	Low Channel		High Channel	
	Frequency (MHz)	Frequency Error (ppm)	Frequency (MHz)	Frequency Error (ppm)
-30	1715.000003	0.002	1750.000003	0.002
-20	1715.000003	0.002	1750.000001	0.001
-10	1715.000002	0.001	1750.000002	0.001
0	1715.000001	0.001	1750.000004	0.002
10	1715.000003	0.002	1750.000003	0.001
20	1714.999997	-0.002	1749.999997	-0.002
30	1714.999997	-0.002	1749.999997	-0.002
40	1714.999999	-0.001	1749.999998	-0.001
50	1714.999999	-0.001	1749.999999	-0.001
60	1714.999999	-0.001	1749.999998	-0.001
70	1714.999997	-0.002	1749.999997	-0.002
80	1714.999997	-0.002	1749.999999	-0.001
85	1714.999998	-0.001	1749.999996	-0.002

Frequency Error vs. Voltage

Voltage (Volts)	LTE Band 4			
	Channel Bandwidth: 15 MHz			
	Low Channel		High Channel	
	Frequency (MHz)	Frequency Error (ppm)	Frequency (MHz)	Frequency Error (ppm)
3.8	1717.500004	0.002	1747.500003	0.002
3.23	1717.500001	0.001	1747.500003	0.002
4.37	1717.500004	0.002	1747.500002	0.001

Note: The applicant defined the normal working voltage of the DC power supply is from 3.23 Vdc to 4.37 Vdc.

Frequency Error vs. Temperature

Temp. (°C)	LTE Band 4			
	Channel Bandwidth: 15 MHz			
	Low Channel		High Channel	
	Frequency (MHz)	Frequency Error (ppm)	Frequency (MHz)	Frequency Error (ppm)
-30	1717.500002	0.001	1747.500003	0.001
-20	1717.500001	0.001	1747.500001	0.001
-10	1717.500003	0.002	1747.500001	0.001
0	1717.500003	0.002	1747.500002	0.001
10	1717.500003	0.002	1747.500004	0.002
20	1717.499998	-0.001	1747.499999	-0.001
30	1717.499998	-0.001	1747.499997	-0.002
40	1717.499998	-0.001	1747.499999	-0.001
50	1717.499997	-0.002	1747.499998	-0.001
60	1717.499997	-0.002	1747.499997	-0.002
70	1717.499998	-0.001	1747.499998	-0.001
80	1717.499998	-0.001	1747.499998	-0.001
85	1717.499997	-0.002	1747.499998	-0.001

Frequency Error vs. Voltage

Voltage (Volts)	LTE Band 4			
	Channel Bandwidth: 20 MHz			
	Low Channel		High Channel	
	Frequency (MHz)	Frequency Error (ppm)	Frequency (MHz)	Frequency Error (ppm)
3.8	1720.000001	0.001	1745.000002	0.001
3.23	1720.000002	0.001	1745.000003	0.002
4.37	1720.000004	0.002	1745.000004	0.002

Note: The applicant defined the normal working voltage of the DC power supply is from 3.23 Vdc to 4.37 Vdc.

Frequency Error vs. Temperature

Temp. (°C)	LTE Band 4			
	Channel Bandwidth: 20 MHz			
	Low Channel		High Channel	
	Frequency (MHz)	Frequency Error (ppm)	Frequency (MHz)	Frequency Error (ppm)
-30	1720.000003	0.002	1745.000003	0.001
-20	1720.000003	0.002	1745.000002	0.001
-10	1720.000001	0.001	1745.000003	0.002
0	1720.000004	0.002	1745.000003	0.001
10	1720.000002	0.001	1745.000004	0.002
20	1719.999998	-0.001	1744.999997	-0.002
30	1719.999996	-0.002	1744.999999	-0.001
40	1719.999998	-0.001	1744.999998	-0.001
50	1719.999998	-0.001	1744.999997	-0.002
60	1719.999998	-0.001	1744.999997	-0.002
70	1719.999997	-0.002	1744.999998	-0.001
80	1719.999997	-0.002	1744.999999	-0.001
85	1719.999999	-0.001	1744.999998	-0.001

Frequency Error vs. Voltage

Voltage (Volts)	LTE Band 12			
	Channel Bandwidth: 5 MHz			
	Low Channel		High Channel	
	Frequency (MHz)	Frequency Error (ppm)	Frequency (MHz)	Frequency Error (ppm)
3.8	701.500003	0.004	713.500002	0.003
3.23	701.500004	0.005	713.500002	0.003
4.37	701.500003	0.004	713.500003	0.004

Note: The applicant defined the normal working voltage of the DC power supply is from 3.23 Vdc to 4.37 Vdc.

Frequency Error vs. Temperature

Temp. (°C)	LTE Band 12			
	Channel Bandwidth: 5 MHz			
	Low Channel		High Channel	
	Frequency (MHz)	Frequency Error (ppm)	Frequency (MHz)	Frequency Error (ppm)
-30	701.500003	0.004	713.500001	0.002
-20	701.500001	0.002	713.500002	0.003
-10	701.500002	0.002	713.500004	0.005
0	701.500003	0.004	713.500004	0.005
10	701.500003	0.004	713.500002	0.003
20	701.499998	-0.002	713.499997	-0.004
30	701.499996	-0.005	713.499998	-0.003
40	701.499997	-0.004	713.499999	-0.002
50	701.499998	-0.003	713.499998	-0.003
60	701.499998	-0.003	713.499998	-0.003
70	701.499999	-0.002	713.499997	-0.004
80	701.499998	-0.003	713.499997	-0.005
85	701.499999	-0.002	713.499997	-0.005

Frequency Error vs. Voltage

Voltage (Volts)	LTE Band 12			
	Channel Bandwidth: 10 MHz			
	Low Channel		High Channel	
	Frequency (MHz)	Frequency Error (ppm)	Frequency (MHz)	Frequency Error (ppm)
3.8	704.000003	0.004	711.000001	0.002
3.23	704.000004	0.005	711.000002	0.003
4.37	704.000002	0.002	711.000003	0.004

Note: The applicant defined the normal working voltage of the DC power supply is from 3.23 Vdc to 4.37 Vdc.

Frequency Error vs. Temperature

Temp. (°C)	LTE Band 12			
	Channel Bandwidth: 10 MHz			
	Low Channel		High Channel	
	Frequency (MHz)	Frequency Error (ppm)	Frequency (MHz)	Frequency Error (ppm)
-30	704.000003	0.004	711.000003	0.004
-20	704.000003	0.004	711.000001	0.002
-10	704.000003	0.004	711.000003	0.004
0	704.000002	0.003	711.000004	0.005
10	704.000002	0.003	711.000003	0.004
20	703.999997	-0.004	710.999996	-0.005
30	703.999998	-0.003	710.999997	-0.005
40	703.999996	-0.006	710.999997	-0.004
50	703.999999	-0.002	710.999999	-0.002
60	703.999998	-0.004	710.999997	-0.005
70	703.999999	-0.002	710.999998	-0.003
80	703.999997	-0.004	710.999996	-0.006
85	703.999998	-0.003	710.999998	-0.003

Frequency Error vs. Voltage

Voltage (Volts)	LTE Band 13			
	Channel Bandwidth: 5 MHz			
	Low Channel		High Channel	
	Frequency (MHz)	Frequency Error (ppm)	Frequency (MHz)	Frequency Error (ppm)
3.8	779.500002	0.002	784.500003	0.004
3.23	779.500002	0.002	784.500003	0.004
4.37	779.500003	0.004	784.500001	0.002

Note: The applicant defined the normal working voltage of the DC power supply is from 3.23 Vdc to 4.37 Vdc.

Frequency Error vs. Temperature

Temp. (°C)	LTE Band 13			
	Channel Bandwidth: 5 MHz			
	Low Channel		High Channel	
	Frequency (MHz)	Frequency Error (ppm)	Frequency (MHz)	Frequency Error (ppm)
-30	779.500002	0.002	784.500001	0.002
-20	779.500002	0.003	784.500004	0.005
-10	779.500003	0.003	784.500003	0.004
0	779.500002	0.003	784.500003	0.003
10	779.500001	0.002	784.500003	0.003
20	779.499996	-0.005	784.499999	-0.002
30	779.499996	-0.005	784.499996	-0.005
40	779.499996	-0.005	784.499997	-0.003
50	779.499998	-0.003	784.499997	-0.004
60	779.499998	-0.002	784.499998	-0.003
70	779.500002	0.003	784.500002	0.002
80	779.500003	0.003	784.500004	0.005
85	779.500004	0.005	784.500003	0.003

Frequency Error vs. Voltage

Voltage (Volts)	LTE Band 13	
	Channel Bandwidth: 10 MHz	
	Frequency (MHz)	Frequency Error (ppm)
3.8	779.500003	0.003
3.23	779.500002	0.003
4.37	779.500003	0.003

Note: The applicant defined the normal working voltage of the DC power supply is from 3.23 Vdc to 4.37 Vdc.

Frequency Error vs. Temperature

Temp. (°C)	LTE Band 13	
	Channel Bandwidth: 10 MHz	
	Frequency (MHz)	Frequency Error (ppm)
-30	779.500003	0.004
-20	779.500002	0.003
-10	779.500003	0.003
0	779.500002	0.002
10	779.500001	0.001
20	779.499998	-0.002
30	779.499998	-0.003
40	779.499999	-0.001
50	779.499999	-0.002
60	779.499999	-0.002
70	779.500003	0.003
80	779.500003	0.004
85	779.500003	0.004

4.4 Occupied Bandwidth Measurement

4.4.1 Limits of Occupied Bandwidth Measurement

The width of a frequency band such that, below the lower and above the upper frequency limits, the mean powers emitted are each equal to a specified percentage 0.5 % of the total mean power of a given emission.

4.4.2 Test Procedure

- The conducted occupied bandwidth used the power splitter via EUT RF power connector between simulation base station and spectrum analyzer.
- Use OBW measurement function of Spectrum analyzer to measure 99 % occupied bandwidth.

4.4.3 Test Setup

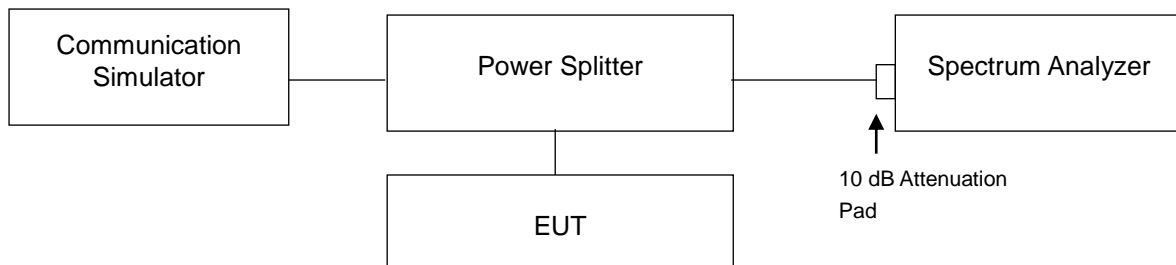

4.4.4 Test Result

LTE Band 4					
Channel Bandwidth: 5 MHz					
Channel	Frequency (MHz)	99 % Occupied Bandwidth (MHz)		26 dB Bandwidth (MHz)	
		QPSK	16QAM	QPSK	16QAM
19975	1712.5	1.1016	0.9255	1.399	1.314
20175	1732.5	1.0888	0.9245	1.405	1.190
20375	1752.5	1.0844	0.9153	1.383	1.312
Channel Bandwidth: 10 MHz					
Channel	Frequency (MHz)	99 % Occupied Bandwidth (MHz)		26 dB Bandwidth (MHz)	
		QPSK	16QAM	QPSK	16QAM
20000	1715.0	1.0902	0.9190	1.378	1.329
20175	1732.5	1.0924	0.9171	1.411	1.299
20350	1750.0	1.0921	0.9179	1.404	1.323

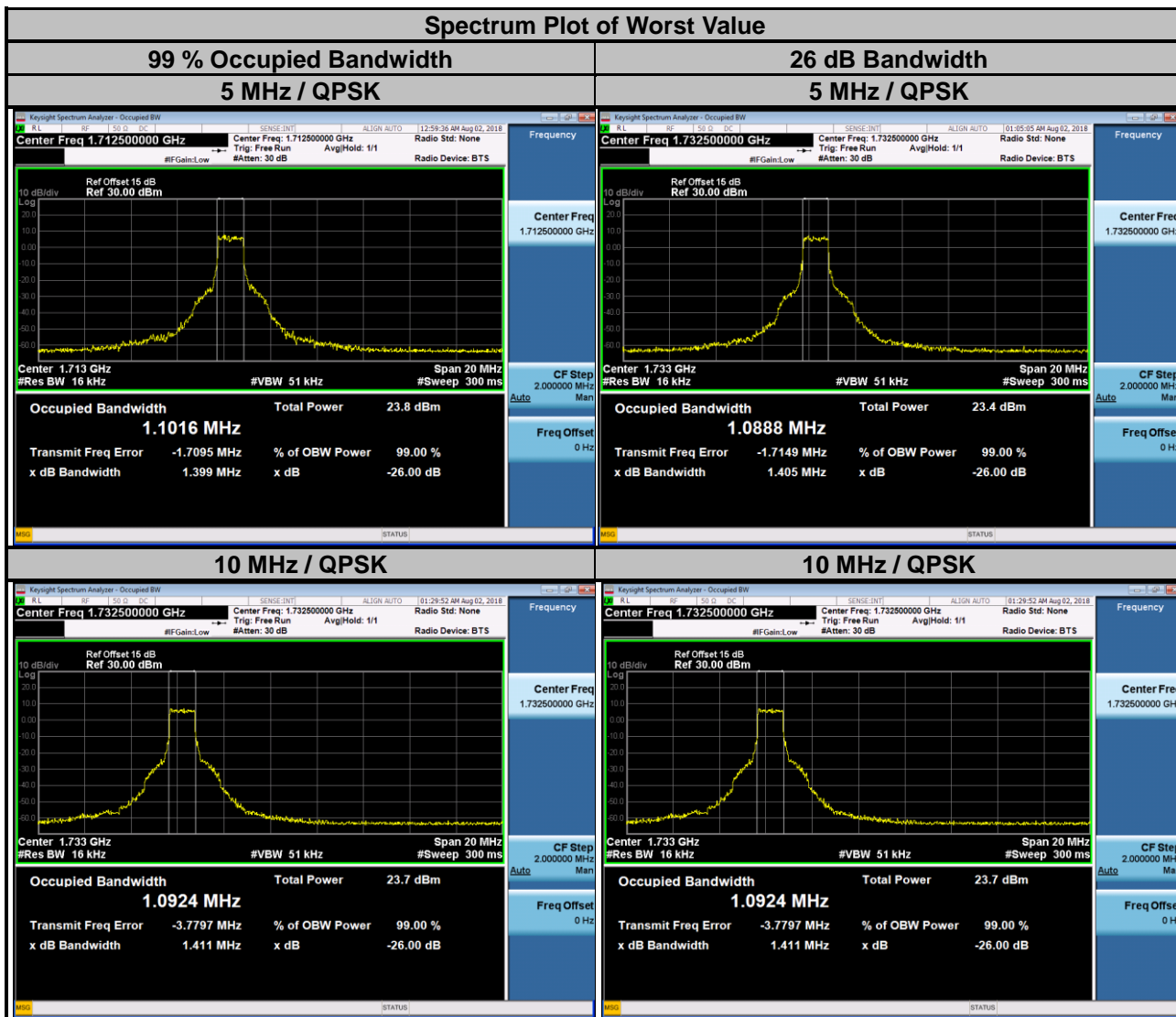

LTE Band 4					
Channel Bandwidth: 15 MHz					
Channel	Frequency (MHz)	99 % Occupied Bandwidth (MHz)		26 dB Bandwidth (MHz)	
		QPSK	16QAM	QPSK	16QAM
20025	1717.5	1.0802	0.9284	1.394	1.368
20175	1732.5	1.0972	0.9237	1.409	1.419
20325	1747.5	1.0850	0.9234	1.346	1.367

Channel Bandwidth: 20 MHz					
Channel	Frequency (MHz)	99 % Occupied Bandwidth (MHz)		26 dB Bandwidth (MHz)	
		QPSK	16QAM	QPSK	16QAM
20050	1720.0	1.0912	0.9219	1.365	1.318
20175	1732.5	1.0966	0.9170	1.418	1.338
20300	1745.0	1.0937	0.9208	1.382	1.326

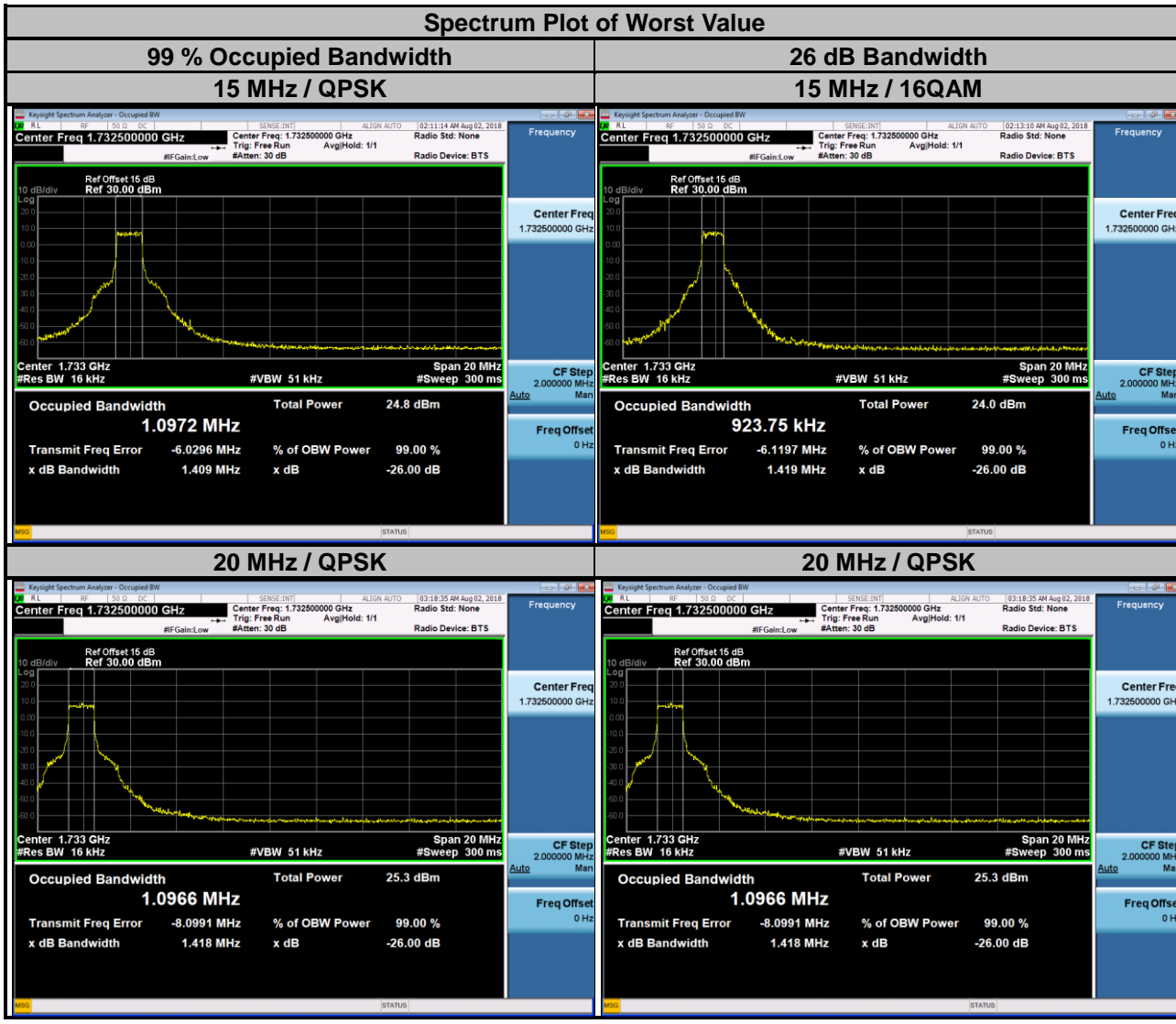

LTE Band 12					
Channel Bandwidth: 5 MHz					
Channel	Frequency (MHz)	99 % Occupied Bandwidth (MHz)		26 dB Bandwidth (MHz)	
		QPSK	16QAM	QPSK	16QAM
23035	701.5	1.0784	0.9190	1.341	1.298
23095	707.5	1.0942	0.9186	1.360	1.255
23155	713.5	1.0882	0.9186	1.347	1.273

Channel Bandwidth: 10 MHz					
Channel	Frequency (MHz)	99 % Occupied Bandwidth (MHz)		26 dB Bandwidth (MHz)	
		QPSK	16QAM	QPSK	16QAM
23060	704.0	1.0922	0.9169	1.381	1.338
23095	707.5	1.0897	0.9198	1.355	1.321
23130	711.0	1.0924	0.9163	1.403	1.265

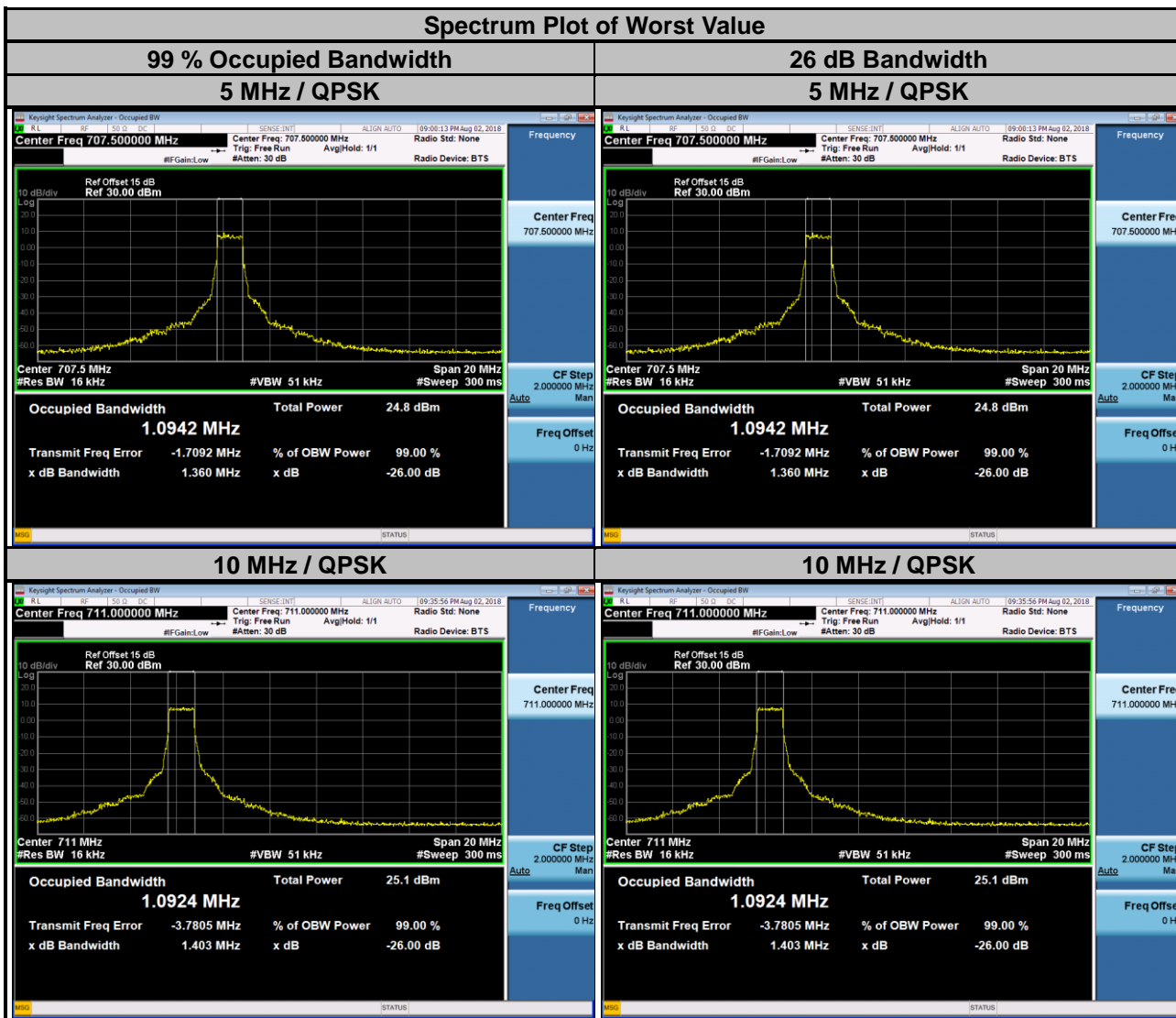

LTE Band 13					
Channel Bandwidth: 5 MHz					
Channel	Frequency (MHz)	99 % Occupied Bandwidth (MHz)		26 dB Bandwidth (MHz)	
		QPSK	16QAM	QPSK	16QAM
23205	779.5	1.0919	0.9241	1.371	1.319
23230	782.0	1.0866	0.9181	1.377	1.288
23255	784.5	1.0947	0.9233	1.367	1.240

Channel Bandwidth: 10 MHz					
Channel	Frequency (MHz)	99 % Occupied Bandwidth (MHz)		26 dB Bandwidth (MHz)	
		QPSK	16QAM	QPSK	16QAM
23230	782.0	1.0903	0.9145	1.375	1.288

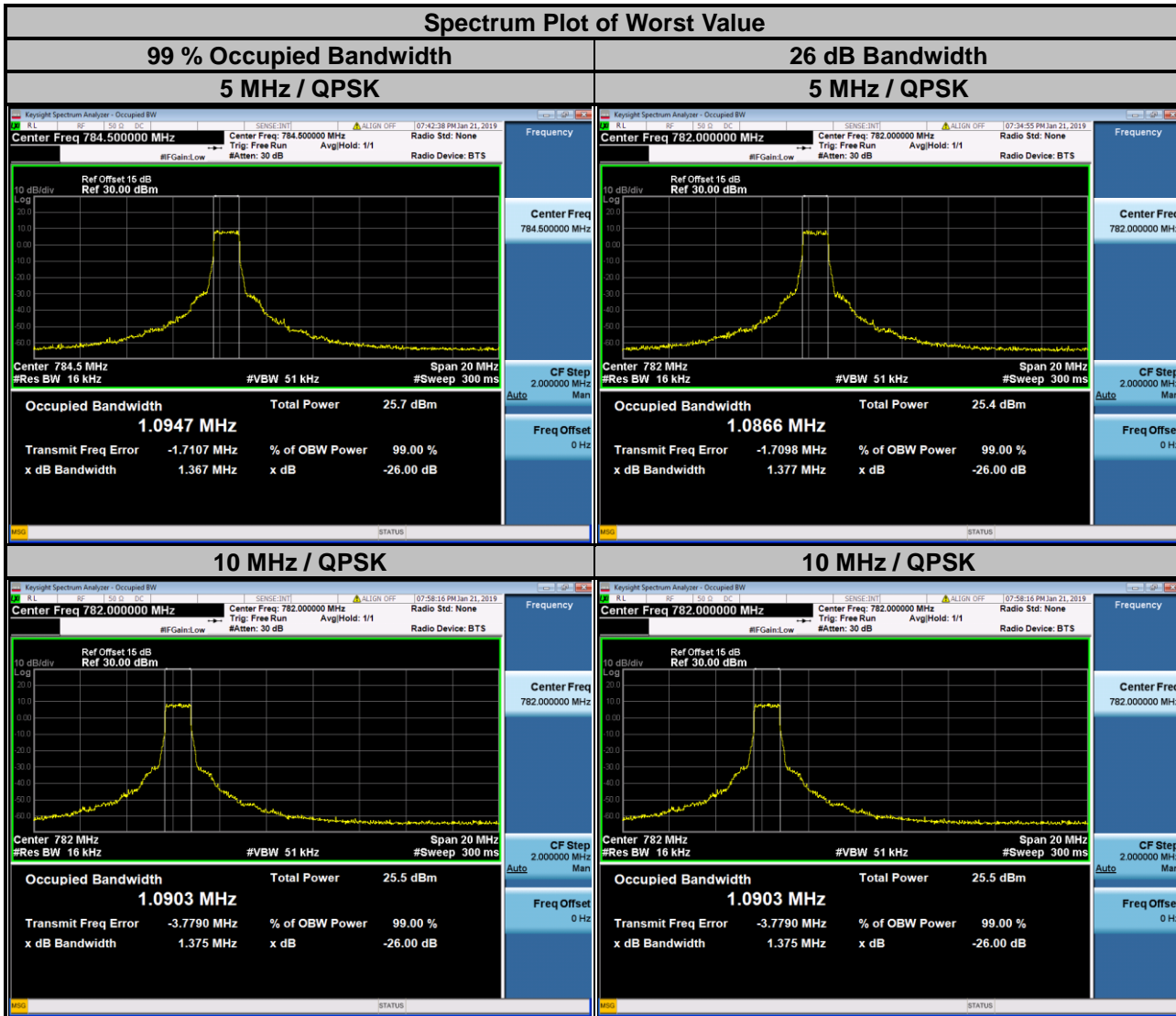

4.5 Band Edge Measurement

4.5.1 Limits of Band Edge Measurement

For operations in the 698-787 MHz band, the power of any emission outside a licensee's frequency band(s) of operation shall be attenuated below the transmitter power (P) within the licensed band(s) of operation, measured in watts, by at least $43 + 10 \log (P)$ dB. Compliance with this provision is based on the use of measurement instrumentation employing a resolution bandwidth of 100 kilohertz or greater.

However, in the 100 kilohertz bands immediately outside and adjacent to a licensee's frequency block, a resolution bandwidth of at least 30 kHz may be employed.

For operations in the 746-758 MHz band and the 776-788 MHz band, the power of any emission outside a licensee's frequency band(s) of operation shall be attenuated below the transmitter power (P) within the licensed band(s) of operation, measured in watts, by at least $43 + 10 \log (P)$ dB.

On all frequencies between 763-775 MHz and 793-805 MHz, by a factor no less than $65 + 10 \log (P)$ dB in a 6.25 kHz band segment, for mobile and portable stations.

For operations in the 1710–1755 MHz bands, the power of any emission outside a licensee's frequency block shall be attenuated below the transmitter power (P) by at least $43 + 10 \log (P)$ dB.

4.5.2 Test Setup

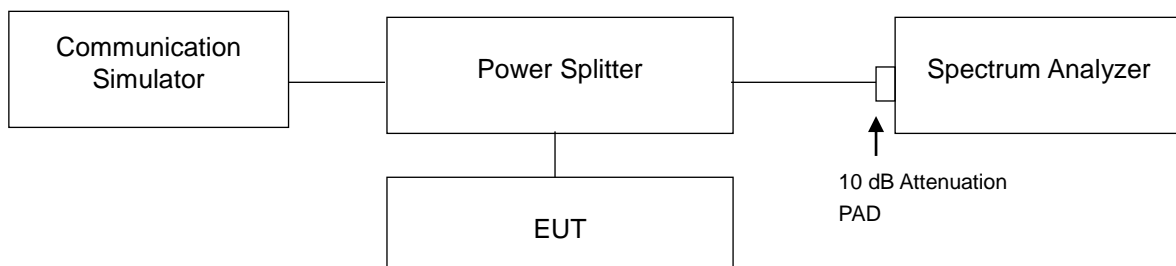

4.5.3 Test Procedures

- All measurements were done at low and high operational frequency range.
- The center frequency of spectrum is the band edge frequency and span is 5 MHz. RB of the spectrum is 16 kHz and VB of the spectrum is 51 kHz.
- Record the max. trace plot into the test report.

4.5.4 Test Results

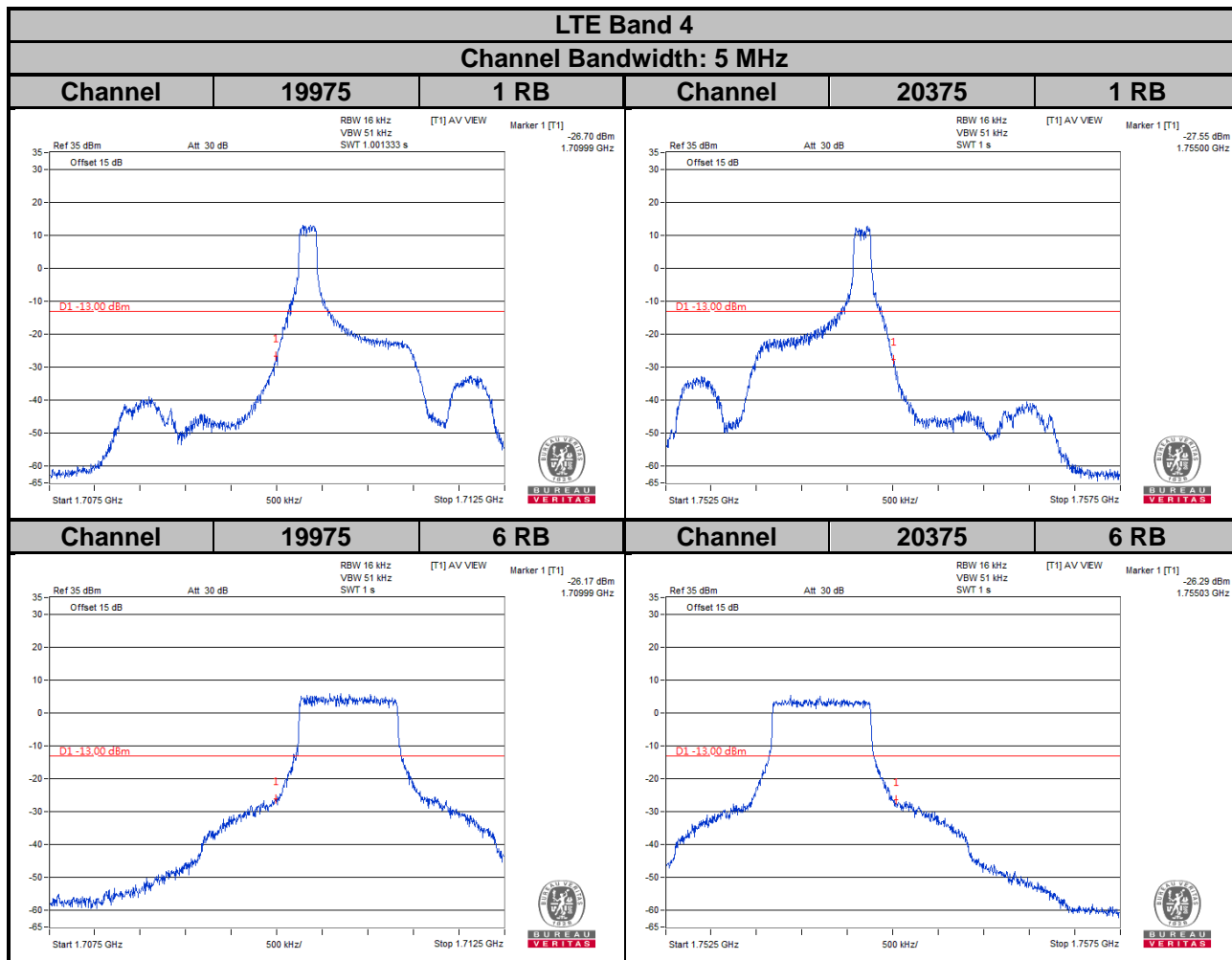

LTE Band 4

Channel Bandwidth: 10 MHz

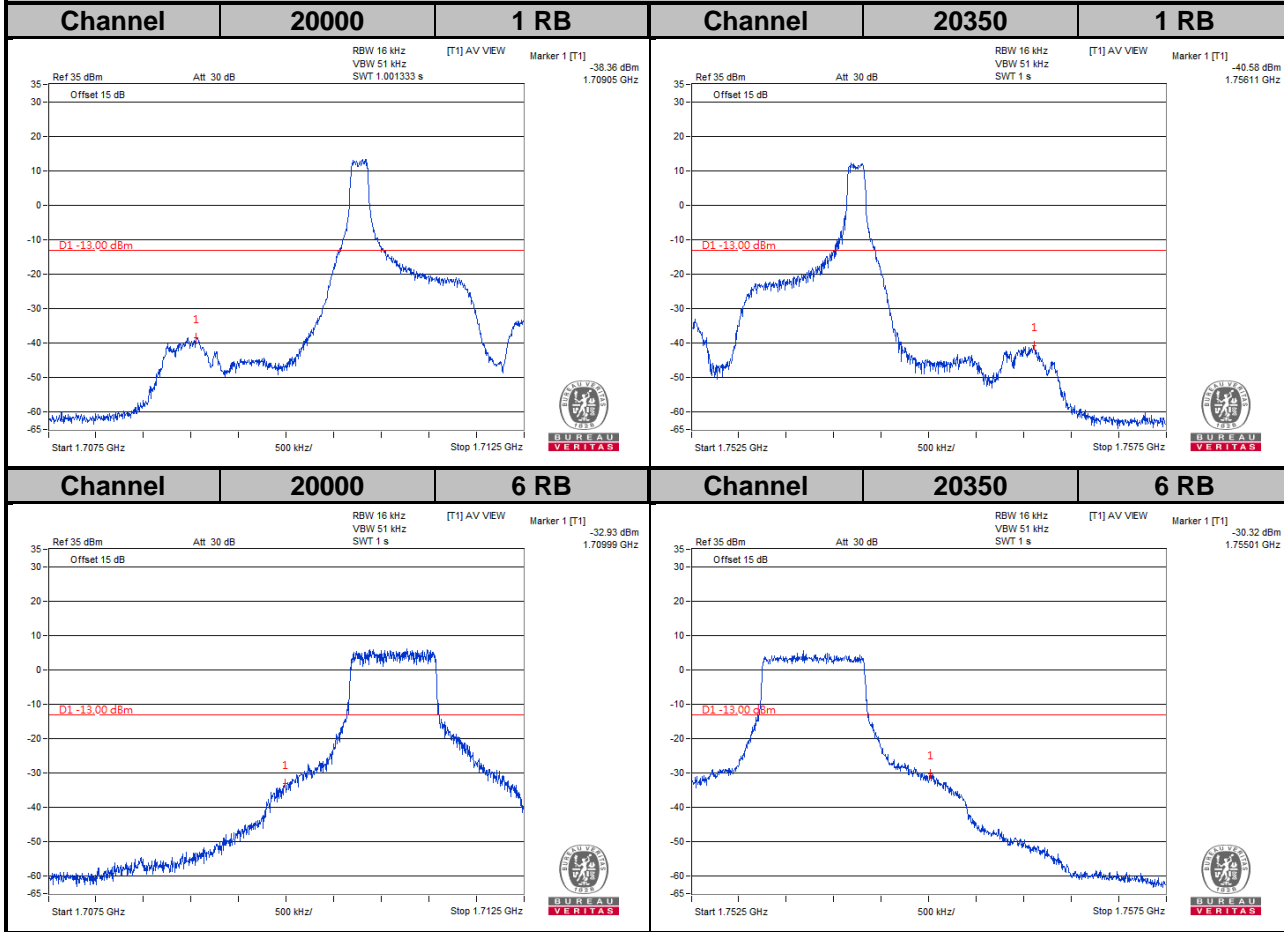

LTE Band 4

Channel Bandwidth: 15 MHz

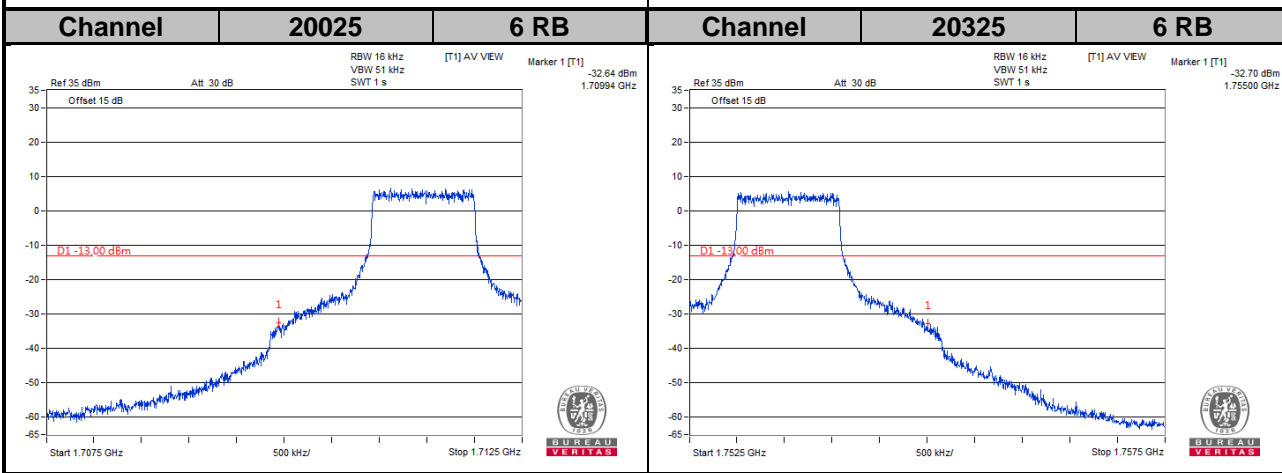
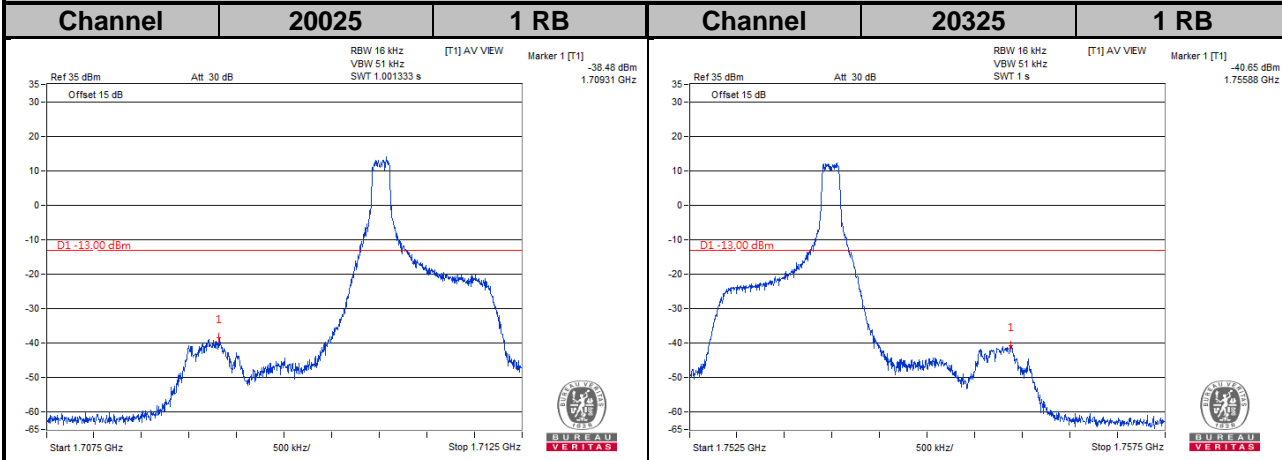

LTE Band 4

Channel Bandwidth: 20 MHz

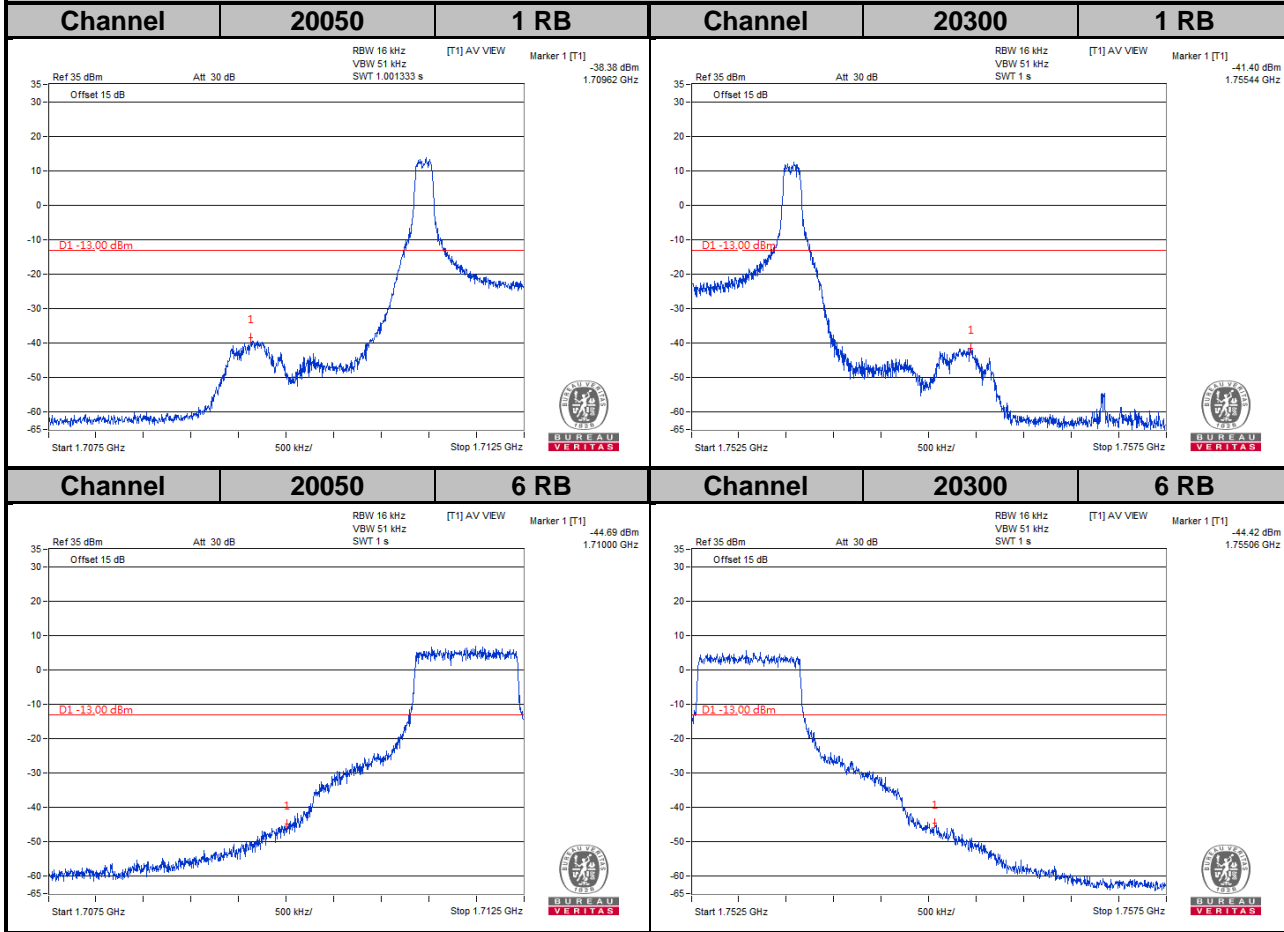

LTE Band 12
Channel Bandwidth: 5 MHz

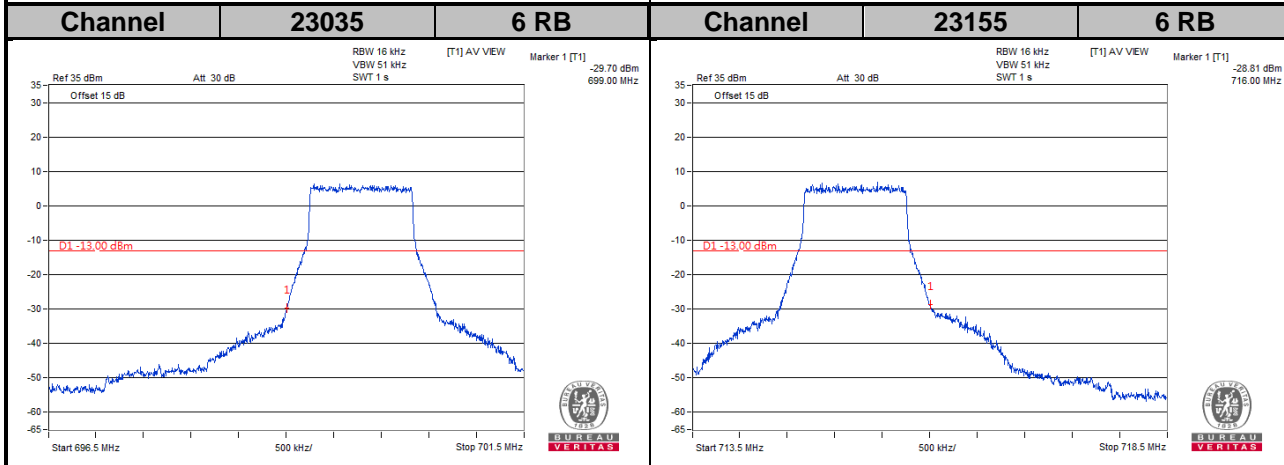
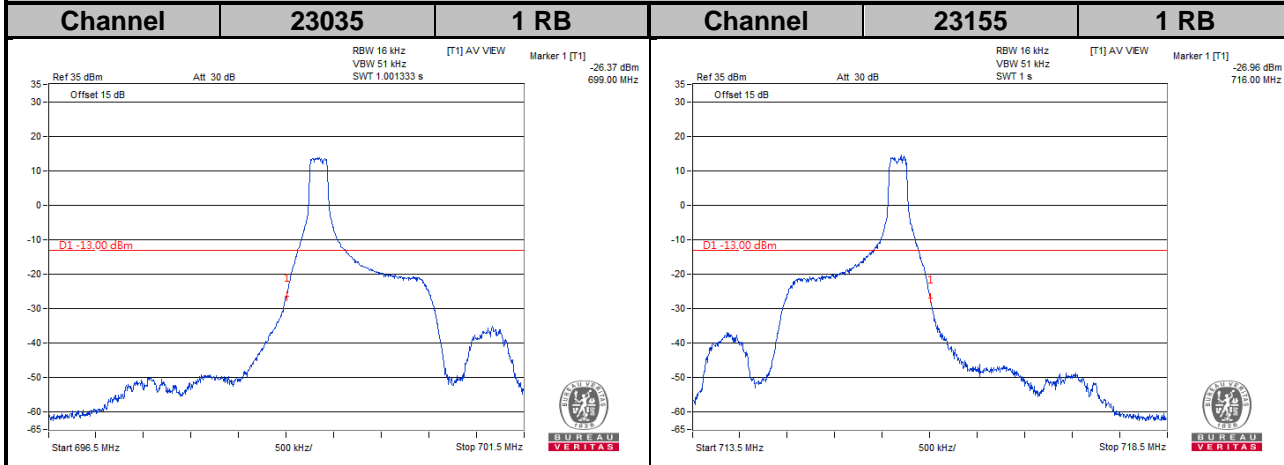

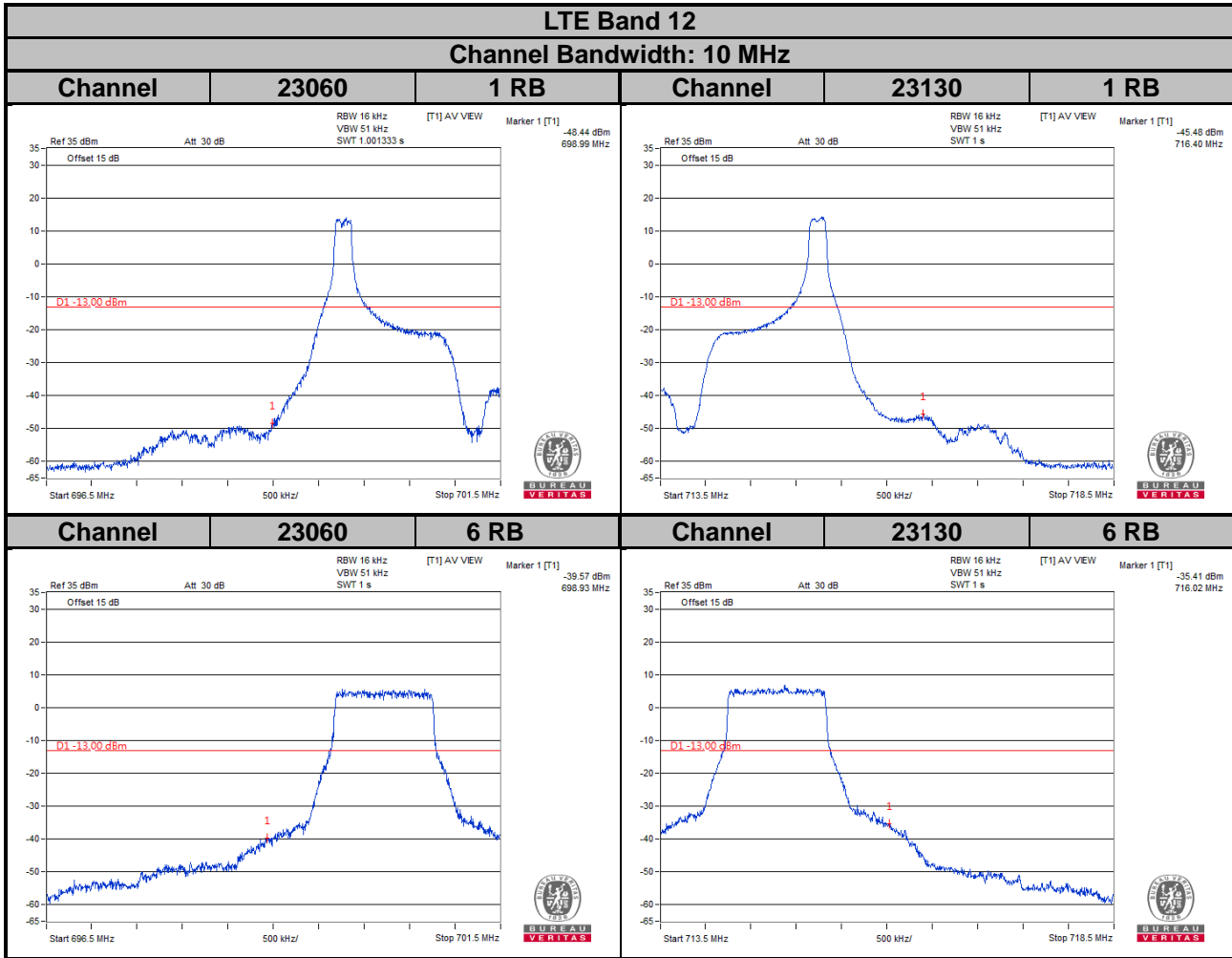

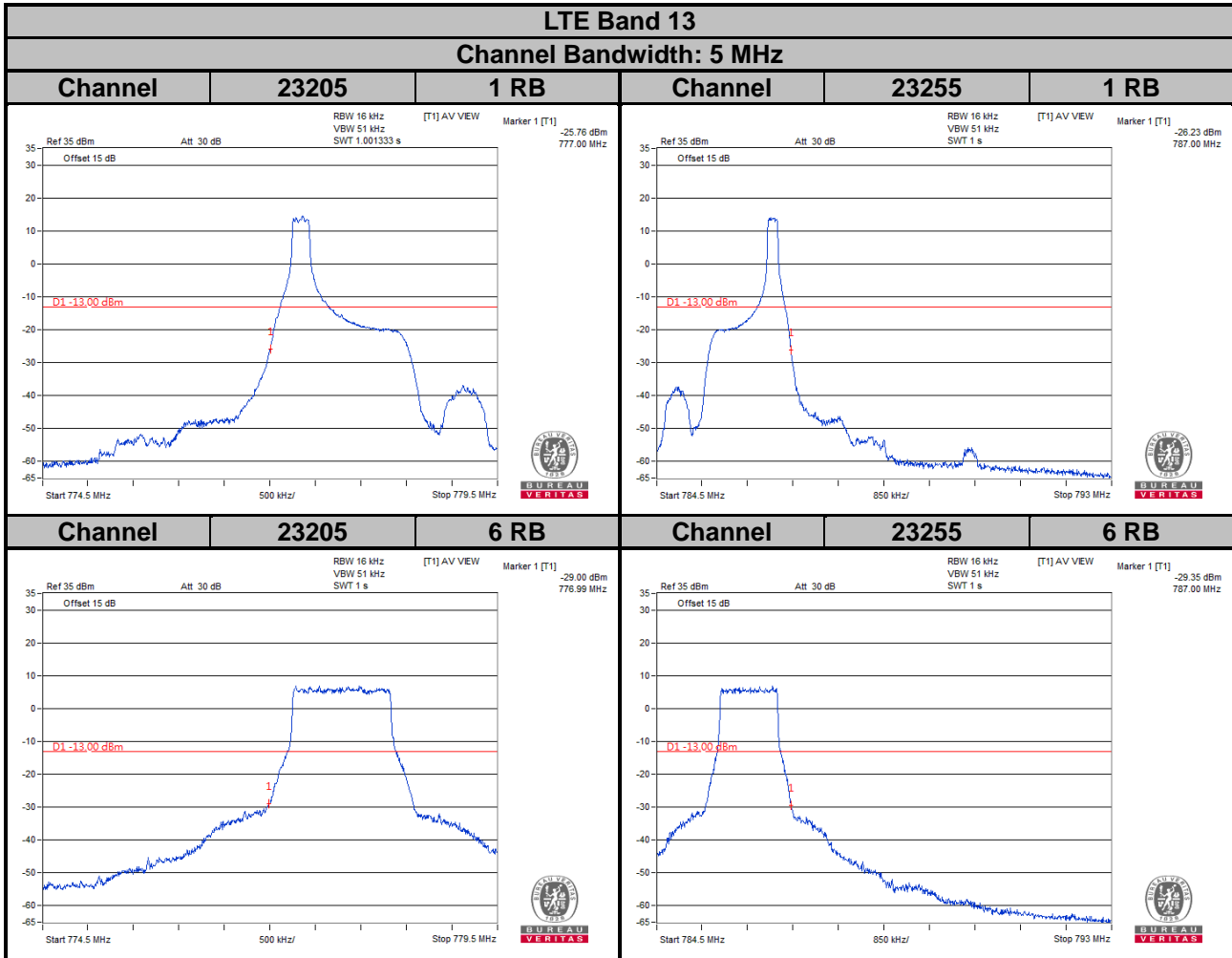

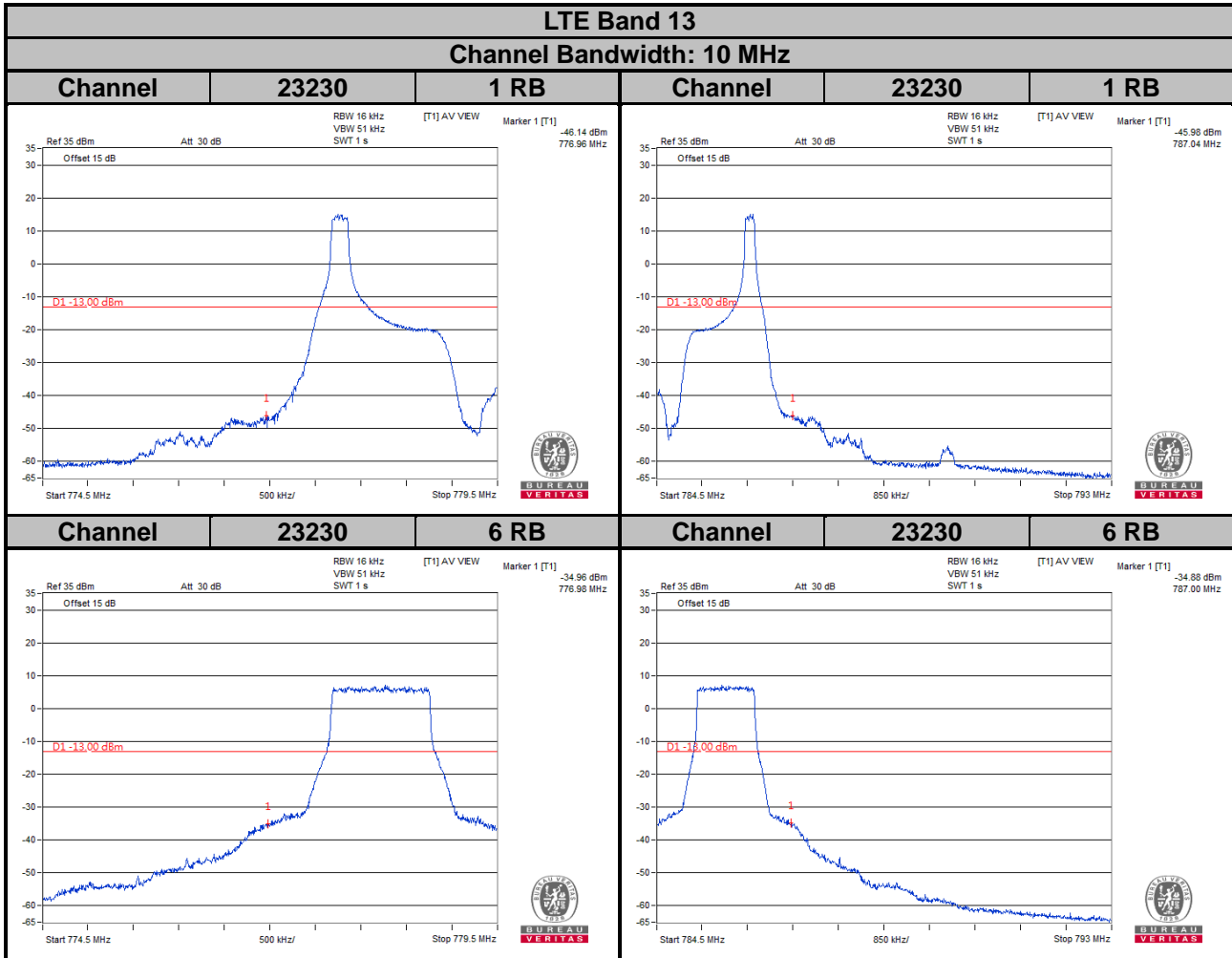

Emission Mask

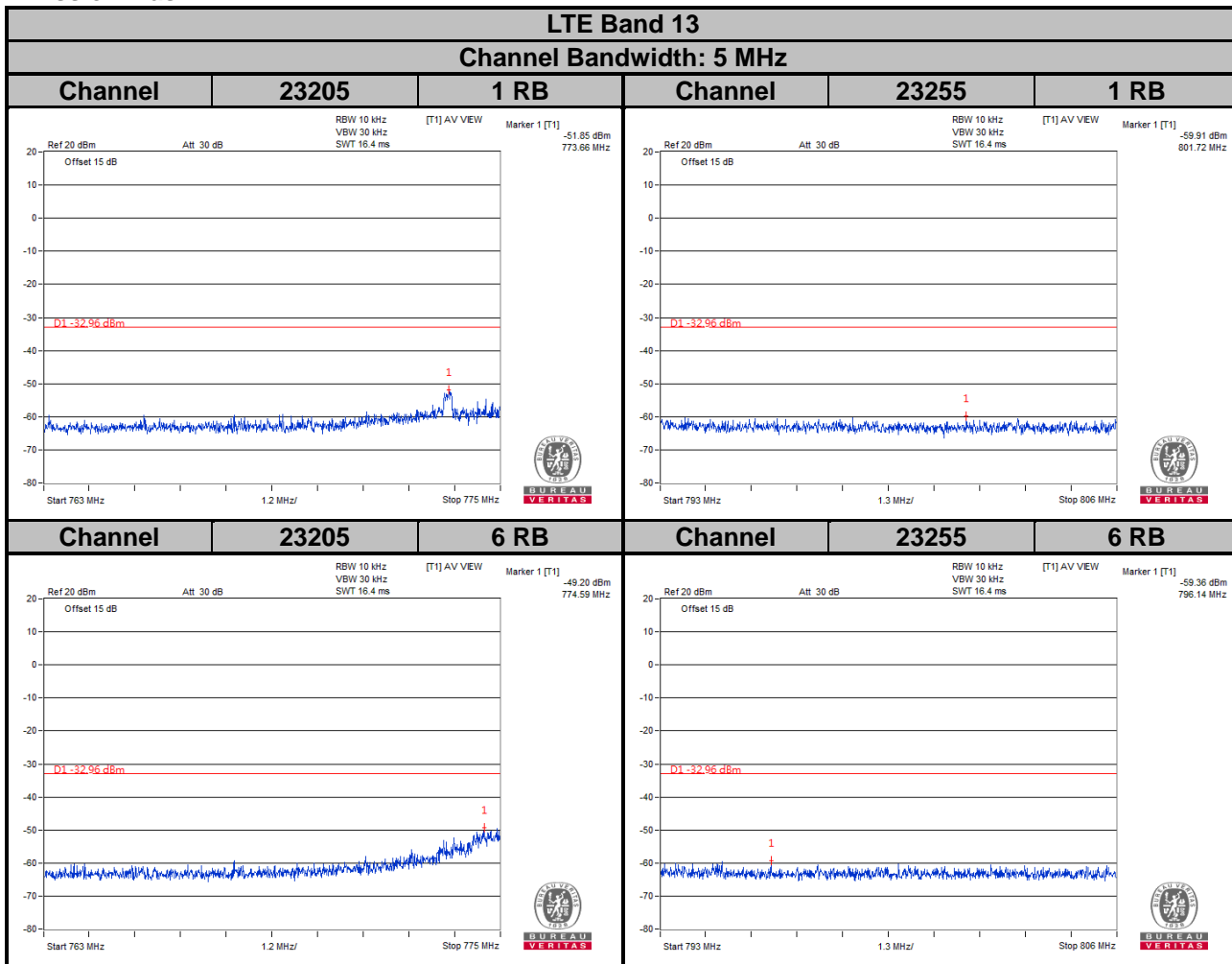

For the 763 - 775 MHz and 793 - 805 MHz band, the FCC limit is $65 + 10\log(P[\text{watt}])$ in a 6.25 kHz bandwidth. Since it was not possible to set the resolution bandwidth to 6.25 kHz with the available equipment, a bandwidth of 10 kHz was used instead to show compliance. By using a 10 kHz bandwidth on the spectrum analyzer.

$$10\log(10\text{kHz}/6.25\text{kHz}) = 2.04 \text{ dB}$$

$$\text{Limit line} = -35 \text{ dBm} + 2.04 \text{ dB} = -32.96 \text{ dBm}$$

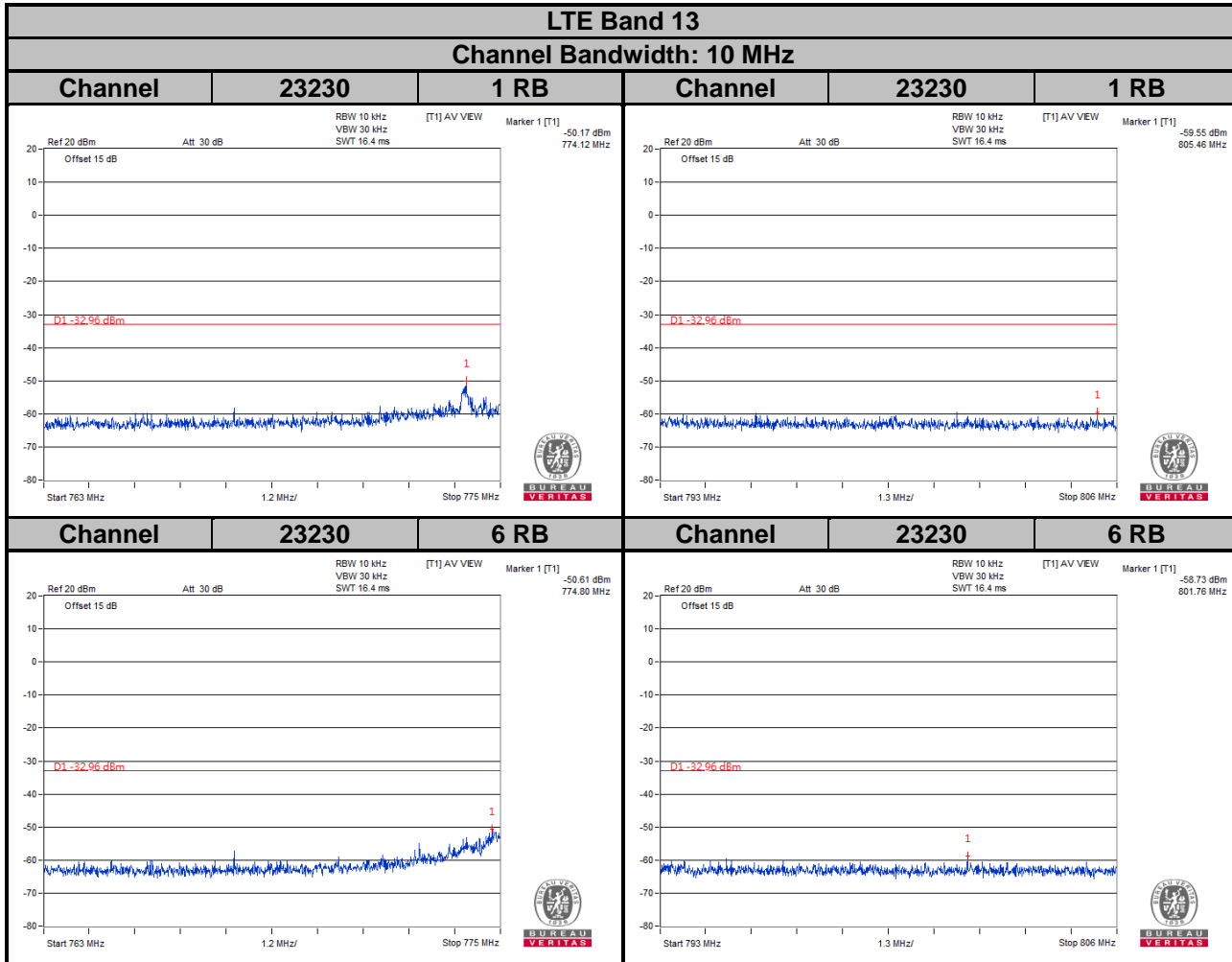

For the 763 - 775 MHz and 793 - 805 MHz band, the FCC limit is $65 + 10\log(P[\text{watt}])$ in a 6.25 kHz bandwidth. Since it was not possible to set the resolution bandwidth to 6.25 kHz with the available equipment, a bandwidth of 10 kHz was used instead to show compliance. By using a 10 kHz bandwidth on the spectrum analyzer.

$$10\log(10\text{kHz}/6.25\text{kHz}) = 2.04 \text{ dB}$$

$$\text{Limit line} = -35 \text{ dBm} + 2.04 \text{ dB} = -32.96 \text{ dBm}$$

4.6 Peak to Average Ratio

4.6.1 Limits of Peak to Average Ratio Measurement

In measuring transmissions in this band using an average power technique, the peak to-average ratio (PAR) of the transmission may not exceed 13 dB.

4.6.2 Test Setup

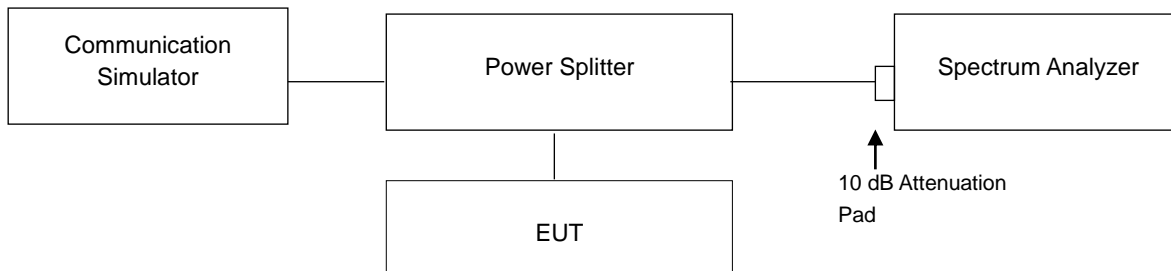

4.6.3 Test Procedures

1. Set resolution/measurement bandwidth \geq signal's occupied bandwidth;
2. Set the number of counts to a value that stabilizes the measured CCDF curve;
3. Record the maximum PAPR level associated with a probability of 0.1 %.

4.6.4 Test Results

LTE Band 4							
Channel Bandwidth: 5 MHz				Channel Bandwidth: 10 MHz			
Channel	Frequency (MHz)	Peak to Average Ratio (dB)		Channel	Frequency (MHz)	Peak to Average Ratio (dB)	
		QPSK	16QAM			QPSK	16QAM
19975	1712.5	4.33	4.75	20000	1715.0	4.36	5.07
20175	1732.5	4.52	4.71	20175	1732.5	4.37	4.75
20375	1752.5	4.51	4.70	20350	1750.0	4.36	5.34

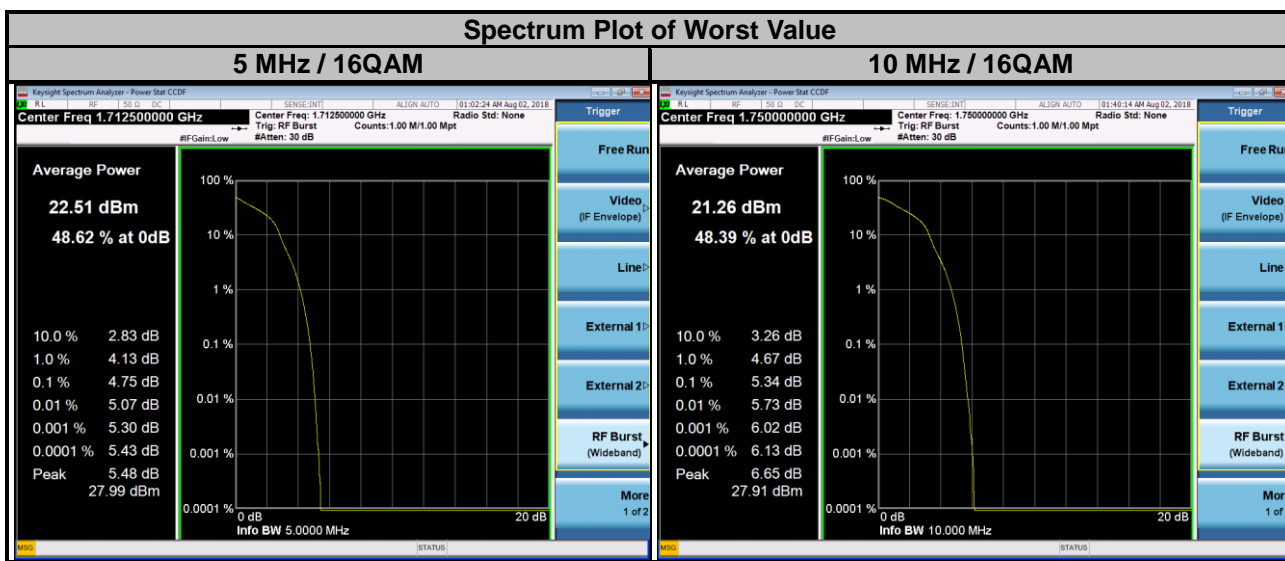

LTE Band 4

Channel Bandwidth: 15 MHz				Channel Bandwidth: 20 MHz			
Channel	Frequency (MHz)	Peak to Average Ratio (dB)		Channel	Frequency (MHz)	Peak to Average Ratio (dB)	
		QPSK	16QAM			QPSK	16QAM
20025	1717.5	4.28	4.81	20050	1720.0	4.29	4.84
20175	1732.5	4.47	4.80	20175	1732.5	4.62	4.71
20325	1747.5	4.56	4.78	20300	1745.0	4.42	4.94

Spectrum Plot of Worst Value

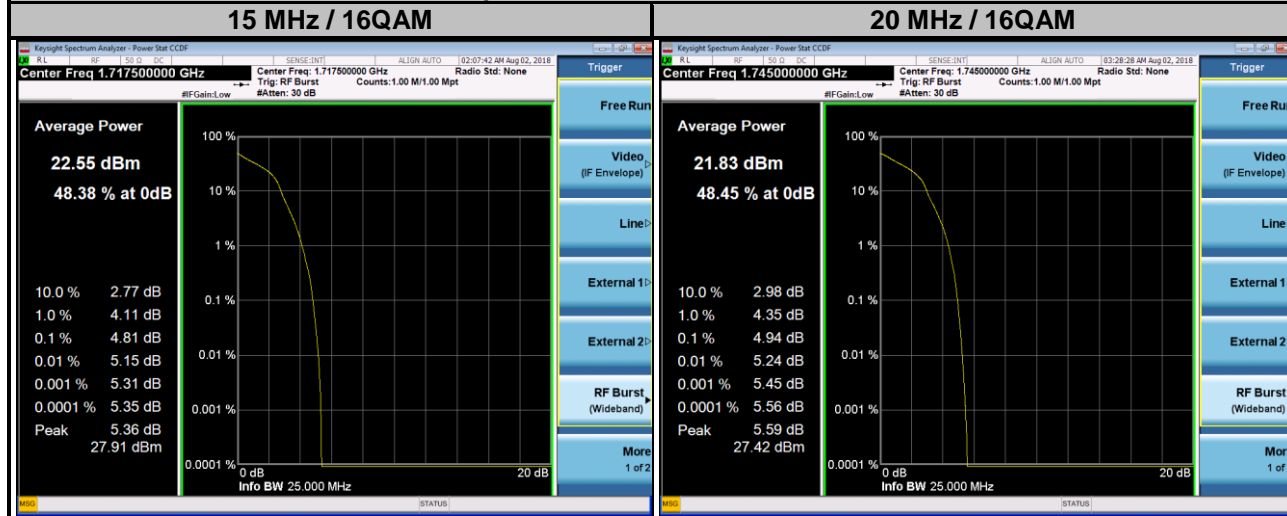

LTE Band 12

Channel Bandwidth: 5 MHz				Channel Bandwidth: 10 MHz			
Channel	Frequency (MHz)	Peak to Average Ratio (dB)		Channel	Frequency (MHz)	Peak to Average Ratio (dB)	
		QPSK	16QAM			QPSK	16QAM
23035	701.5	4.96	5.12	23060	704.0	4.79	5.77
23095	707.5	4.68	5.18	23095	707.5	4.75	5.51
23155	713.5	4.63	5.04	23130	711.0	4.68	5.09

Spectrum Plot of Worst Value

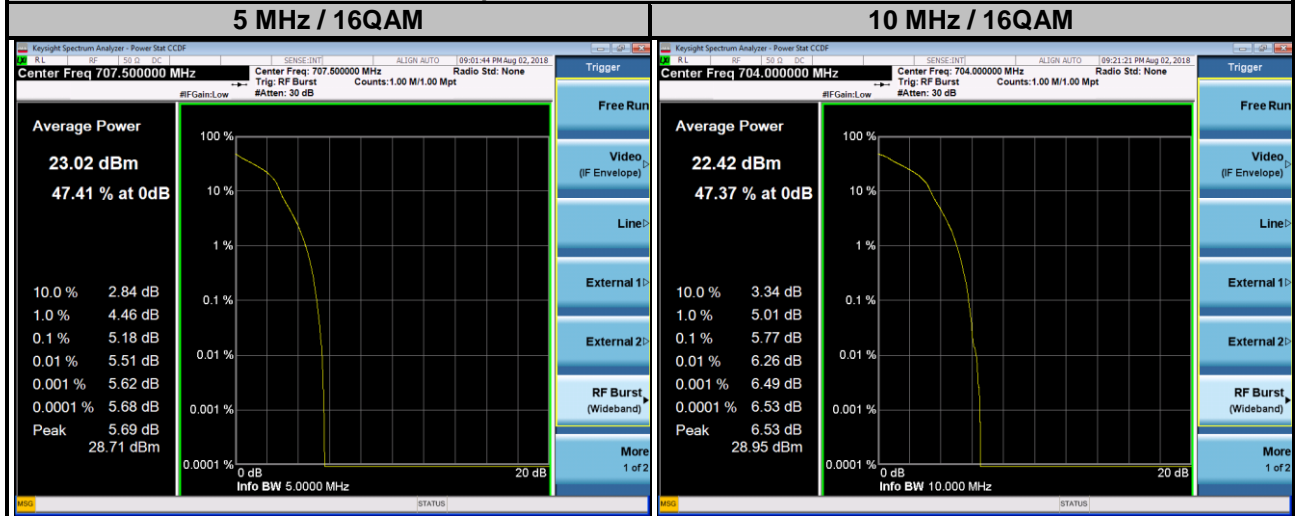

LTE Band 13

Channel Bandwidth: 5 MHz				Channel Bandwidth: 10 MHz			
Channel	Frequency (MHz)	Peak to Average Ratio (dB)		Channel	Frequency (MHz)	Peak to Average Ratio (dB)	
		QPSK	16QAM			QPSK	16QAM
23205	779.5	4.36	4.38	23230	782.0	5.30	5.02
23230	782.0	4.35	4.36				
23255	784.5	4.46	4.32				

Spectrum Plot of Worst Value

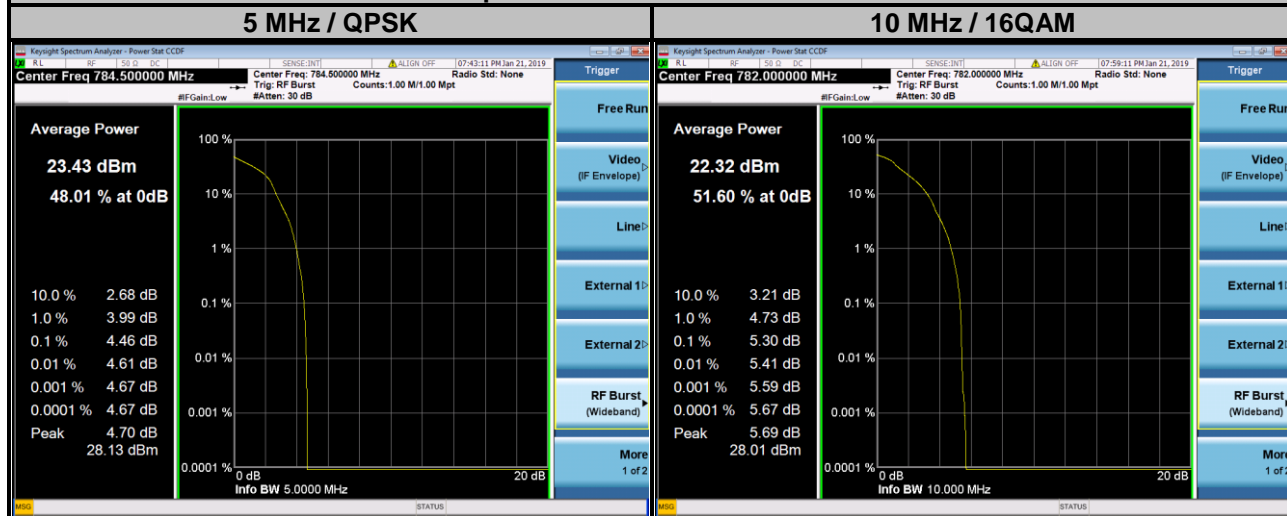

4.7 Conducted Spurious Emissions

4.7.1 Limits of Conducted Spurious Emissions Measurement

The power of any emission outside a licensee's frequency block shall be attenuated below the transmitter power (P) by at least $43 + 10 \log (P)$ dB. The limit of emission is equal to -13 dBm.

4.7.2 Test Setup

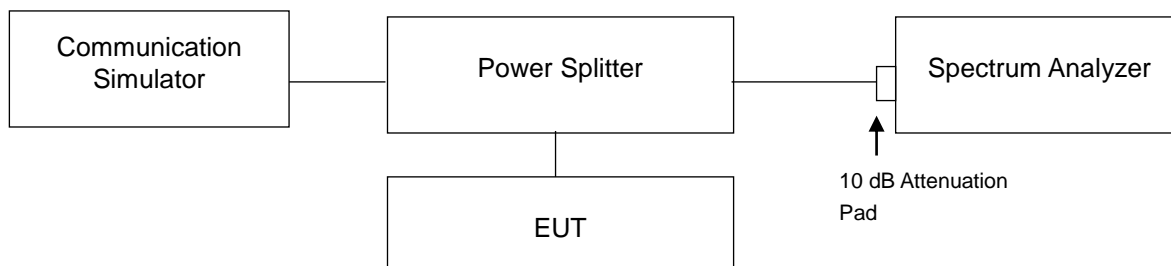

4.7.3 Test Procedure

- The EUT makes a phone call to the communication simulator. All measurements were done at low, middle and high operational frequency range.
- Measuring frequency range is from 9 kHz to 1 GHz. 10 dB attenuation pad is connected with spectrum. RBW = 100 kHz and VBW = 300 kHz is used for conducted emission measurement.
- Measuring frequency range is from 1 GHz to 8 GHz / 10 GHz / 27 GHz. 10 dB attenuation pad is connected with spectrum. RBW = 1 MHz and VBW = 3 MHz is used for conducted emission measurement.

4.7.4 Test Results

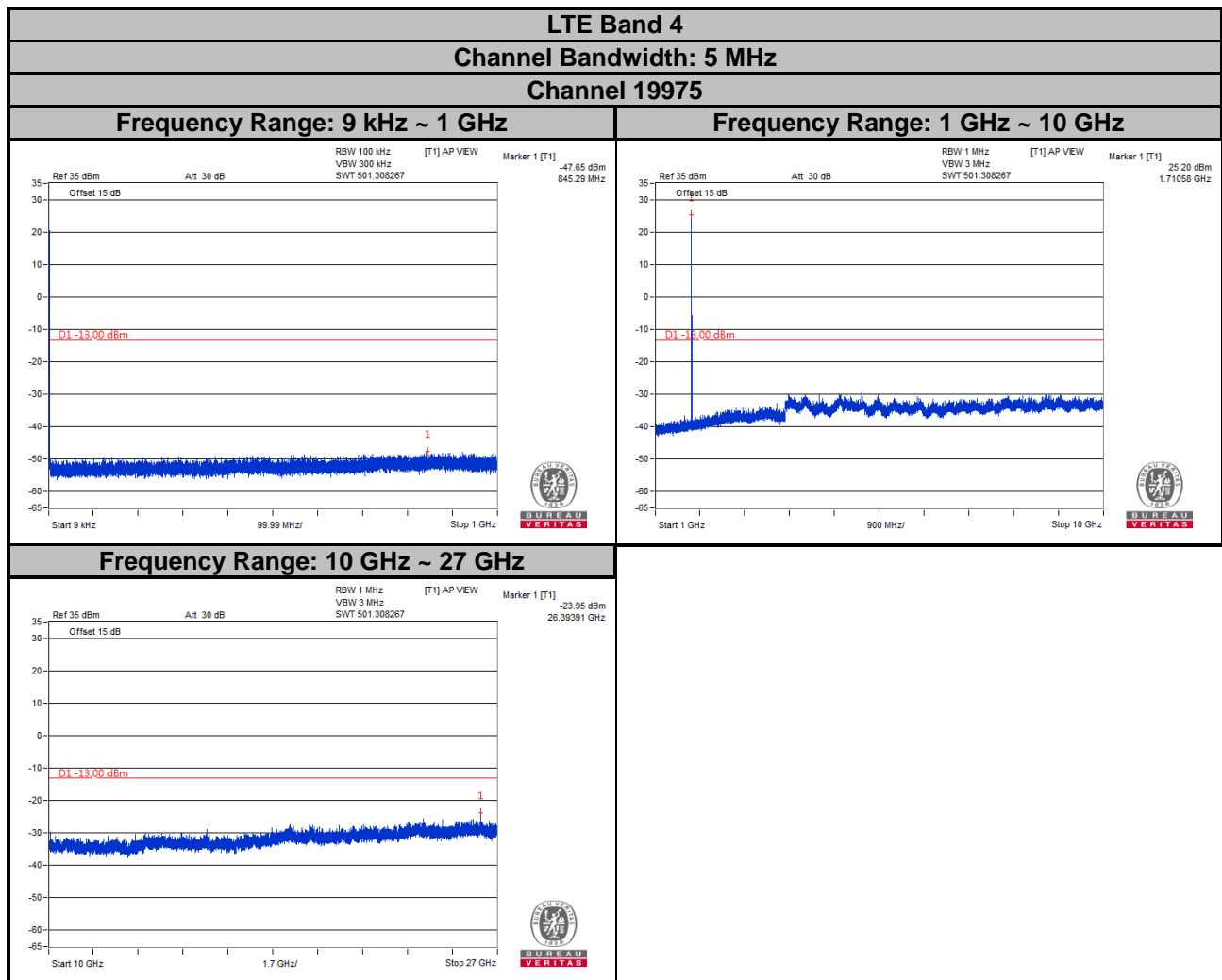

Note: The signal over the limit in 9 kHz is from spectrum analyzer.

LTE Band 4

Channel Bandwidth: 5 MHz

Channel 20175

Frequency Range: 9 kHz ~ 1 GHz

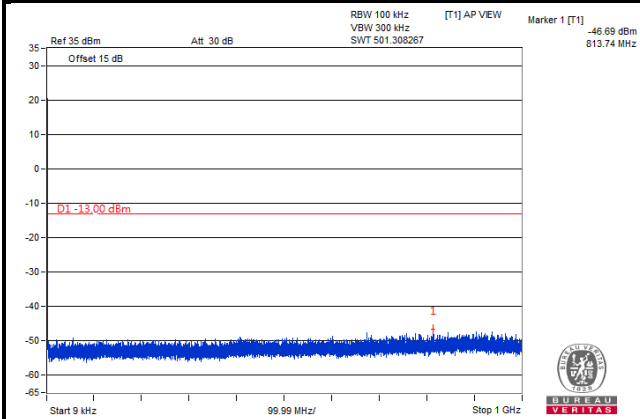

Frequency Range: 1 GHz ~ 10 GHz

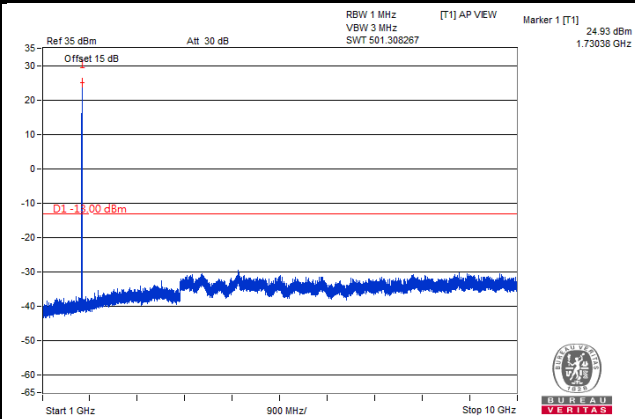

Frequency Range: 10 GHz ~ 27 GHz

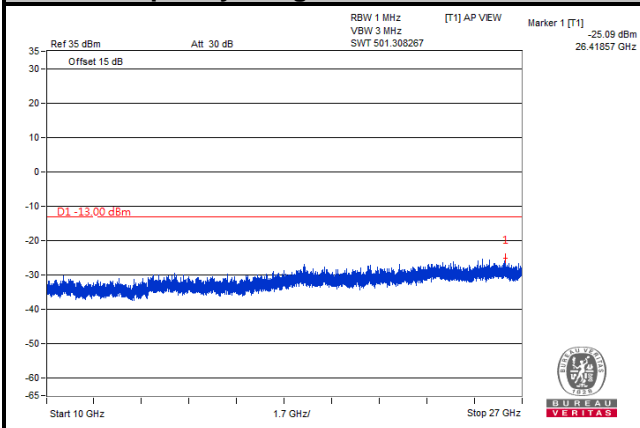

Note: The signal over the limit in 9 kHz is from spectrum analyzer.

LTE Band 4

Channel Bandwidth: 5 MHz

Channel 20375

Frequency Range: 9 kHz ~ 1 GHz

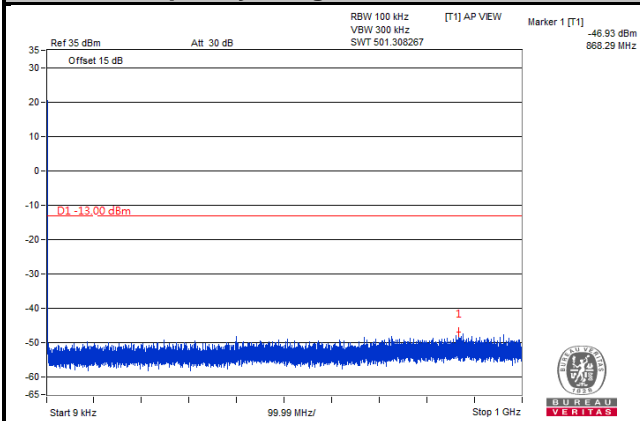

Frequency Range: 1 GHz ~ 10 GHz

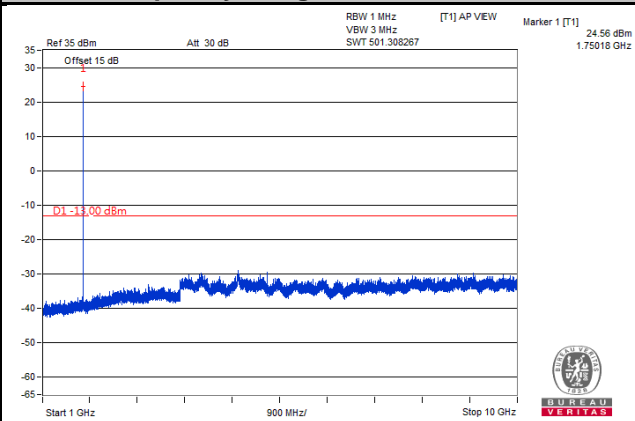

Frequency Range: 10 GHz ~ 27 GHz

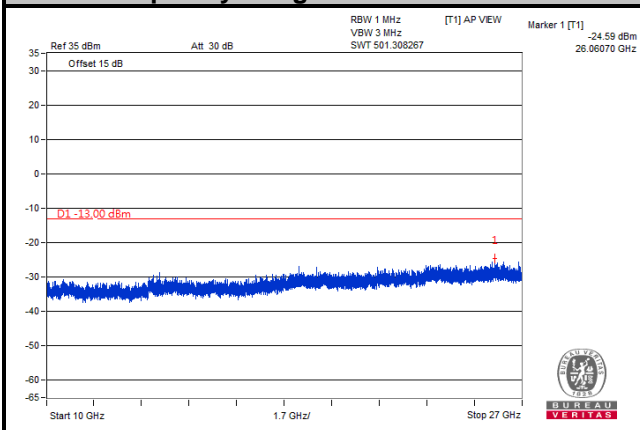

Note: The signal over the limit in 9 kHz is from spectrum analyzer.

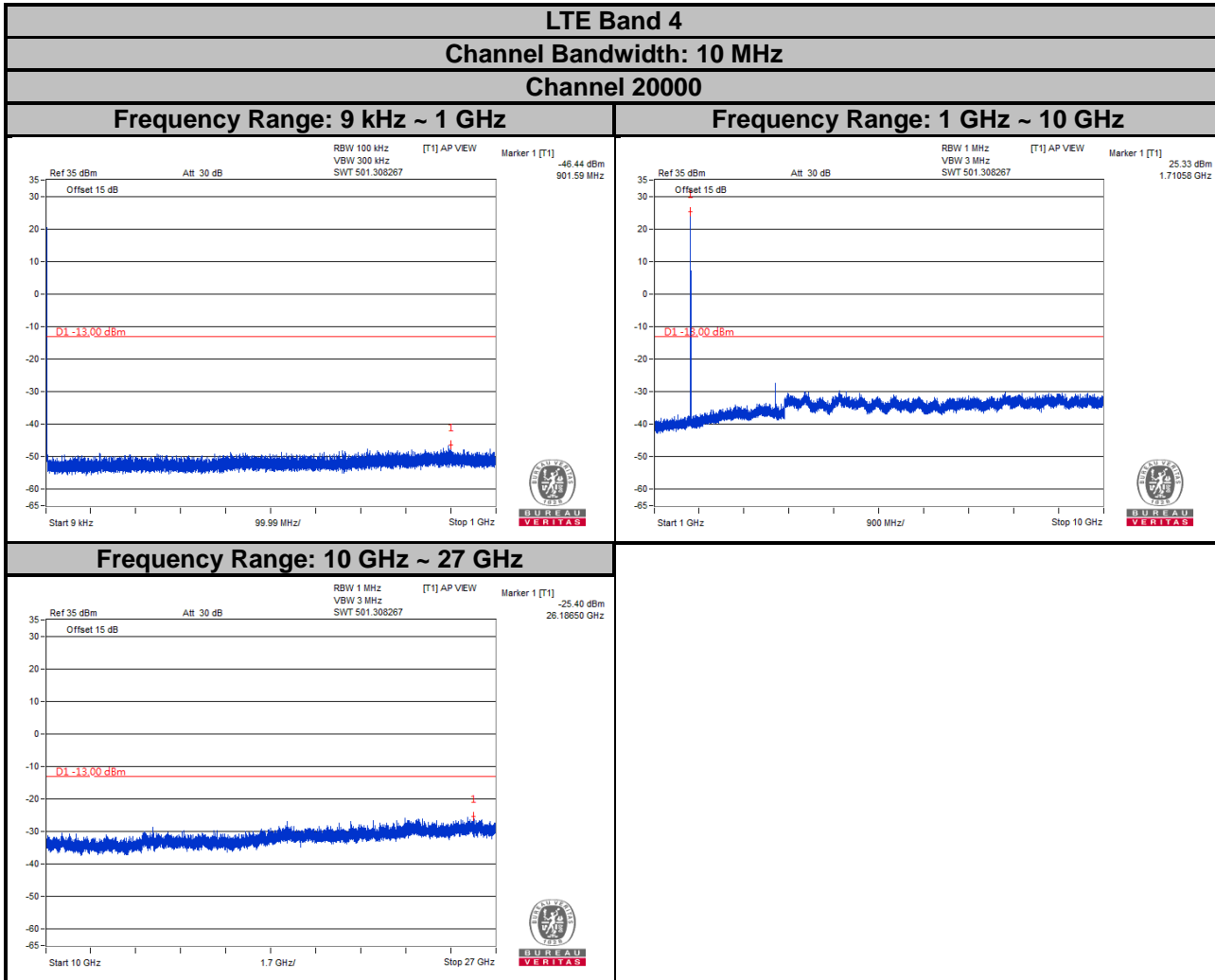

Note: The signal over the limit in 9 kHz is from spectrum analyzer.

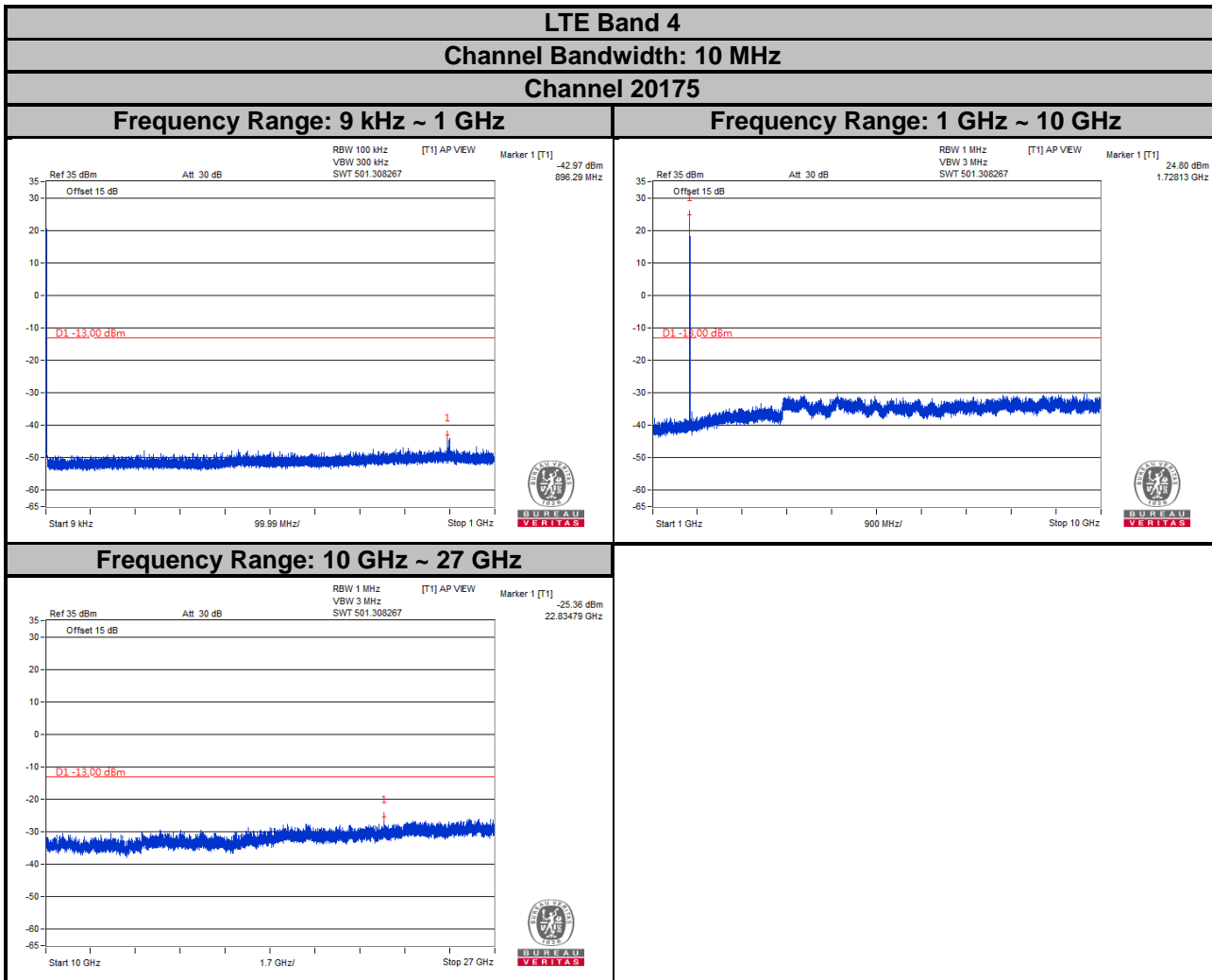

Note: The signal over the limit in 9 kHz is from spectrum analyzer.

LTE Band 4

Channel Bandwidth: 10 MHz

Channel 20350

Frequency Range: 9 kHz ~ 1 GHz

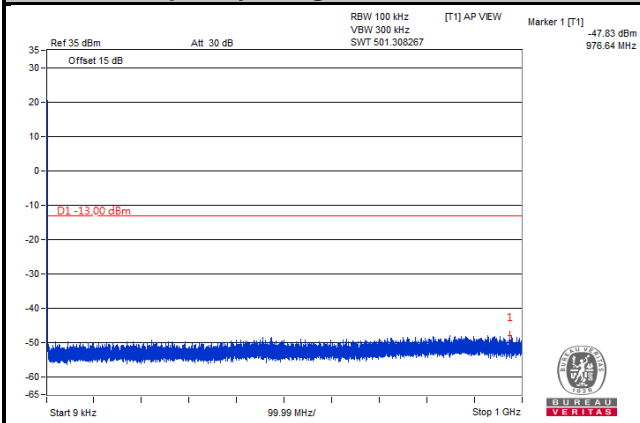

Frequency Range: 1 GHz ~ 10 GHz

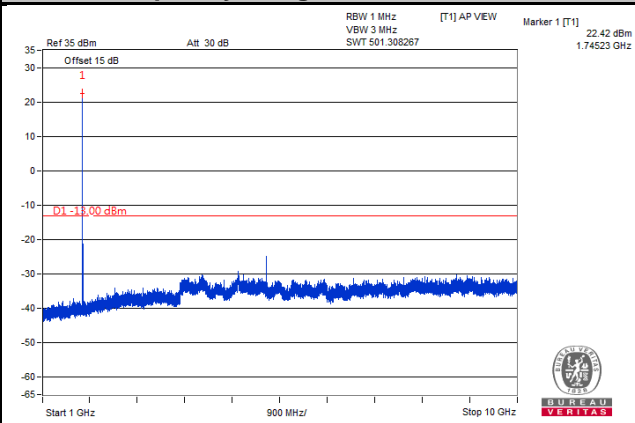

Frequency Range: 10 GHz ~ 27 GHz

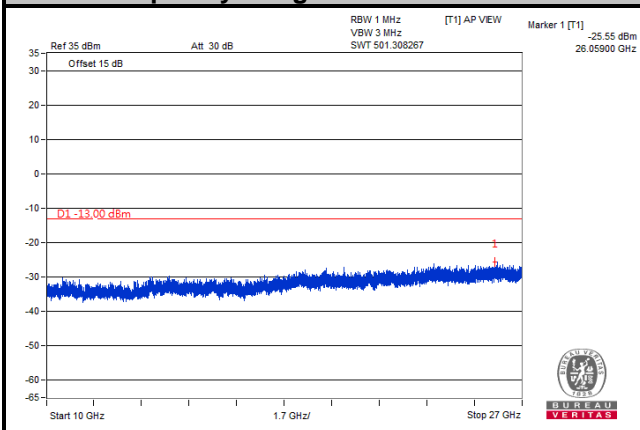

Note: The signal over the limit in 9 kHz is from spectrum analyzer.

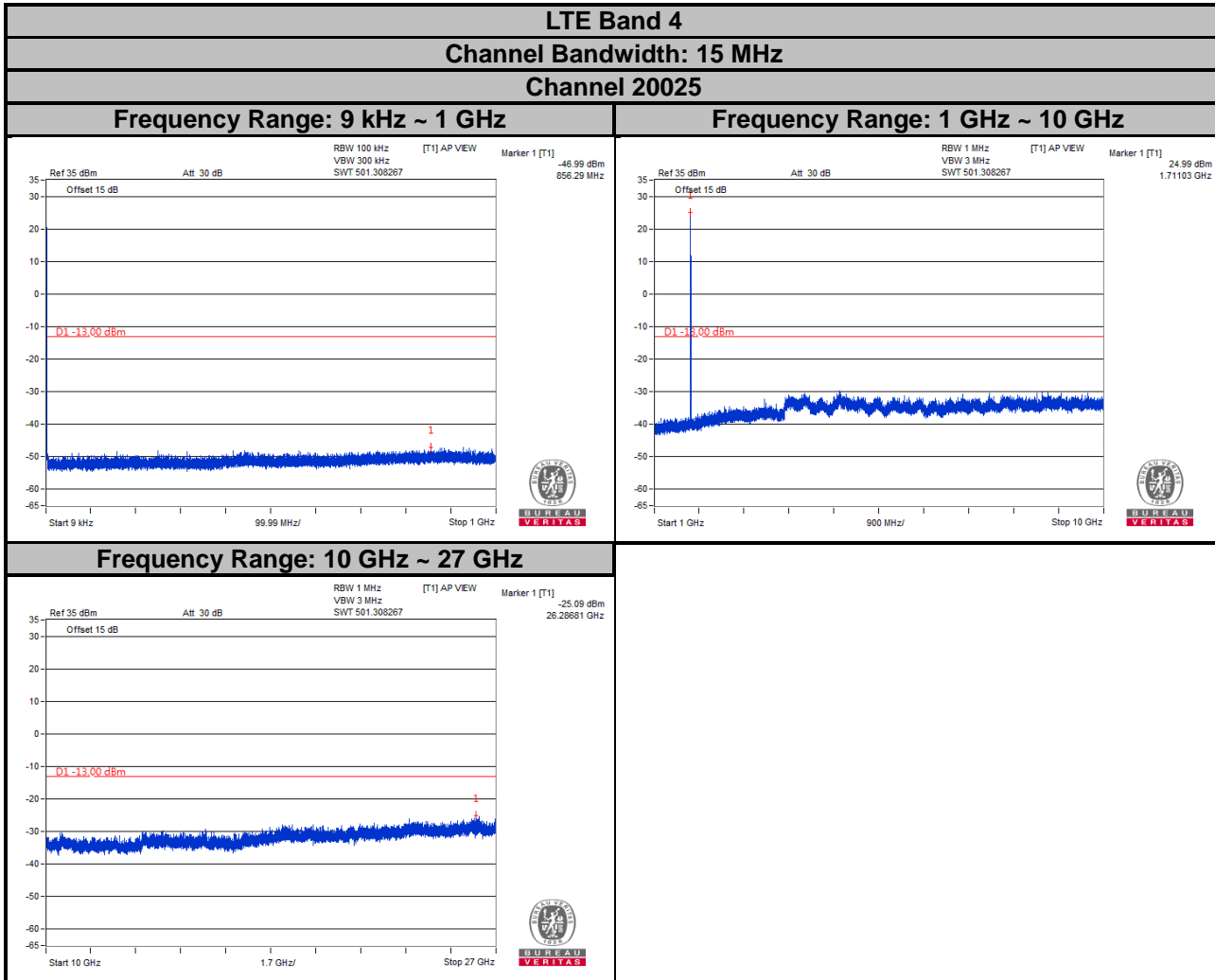

Note: The signal over the limit in 9 kHz is from spectrum analyzer.

LTE Band 4

Channel Bandwidth: 15 MHz

Channel 20175

Frequency Range: 9 kHz ~ 1 GHz

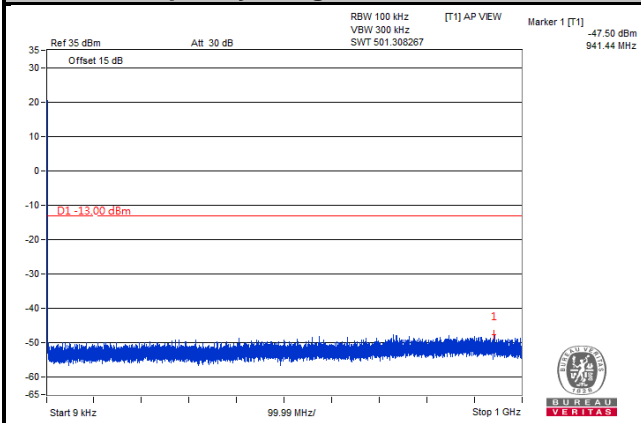

Frequency Range: 1 GHz ~ 10 GHz

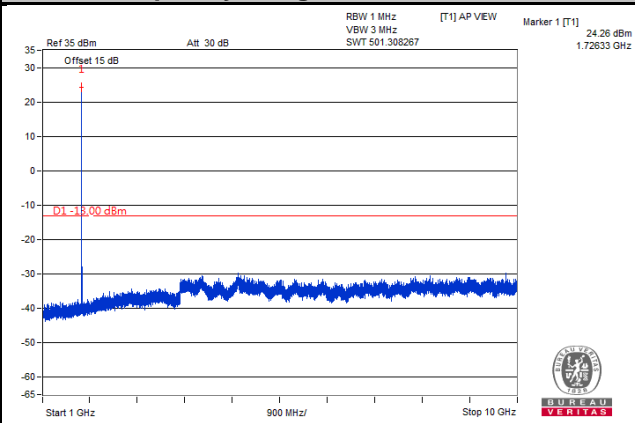

Frequency Range: 10 GHz ~ 27 GHz

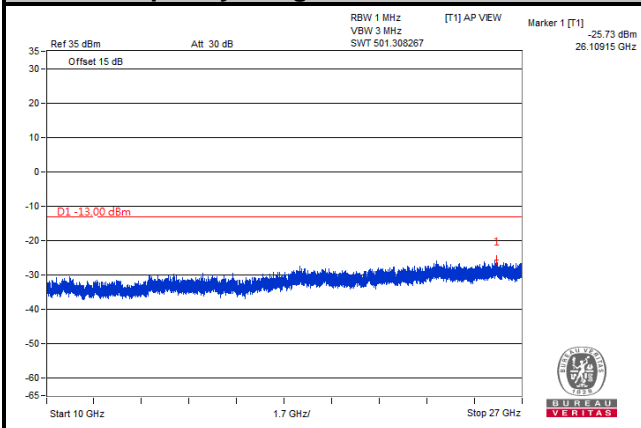

Note: The signal over the limit in 9 kHz is from spectrum analyzer.

LTE Band 4

Channel Bandwidth: 15 MHz

Channel 20325

Frequency Range: 9 kHz ~ 1 GHz

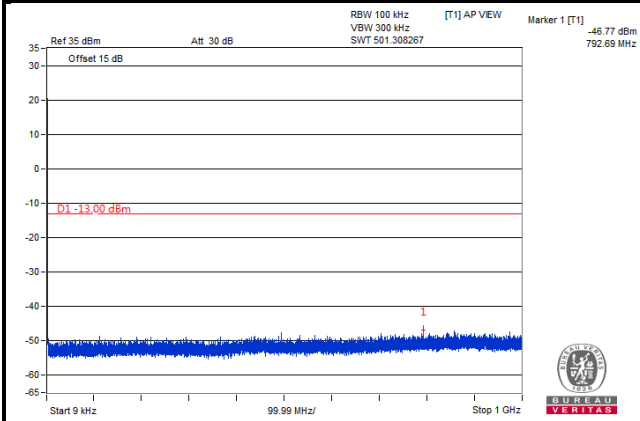

Frequency Range: 1 GHz ~ 10 GHz

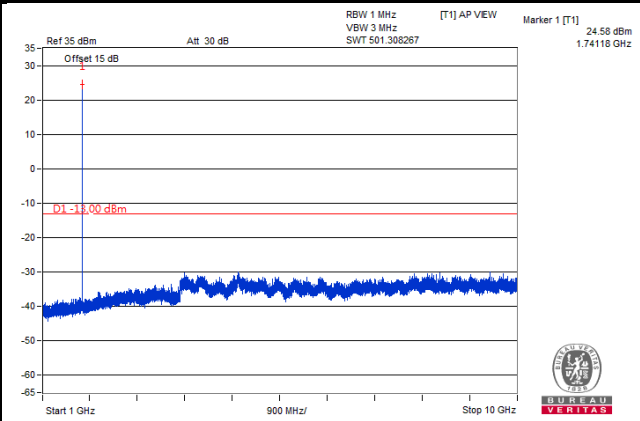

Frequency Range: 10 GHz ~ 27 GHz

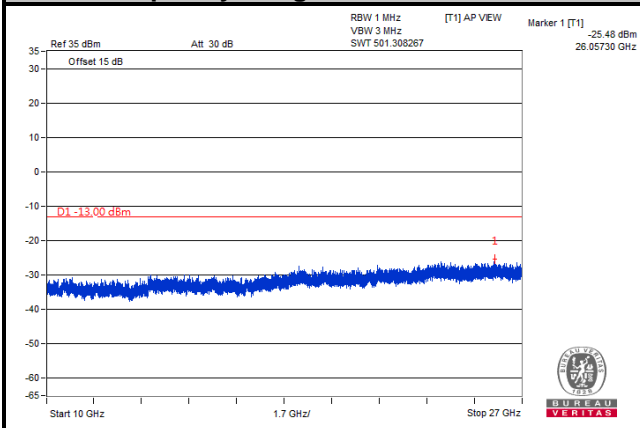

Note: The signal over the limit in 9 kHz is from spectrum analyzer.

LTE Band 4

Channel Bandwidth: 20 MHz

Channel 20175

Frequency Range: 9 kHz ~ 1 GHz

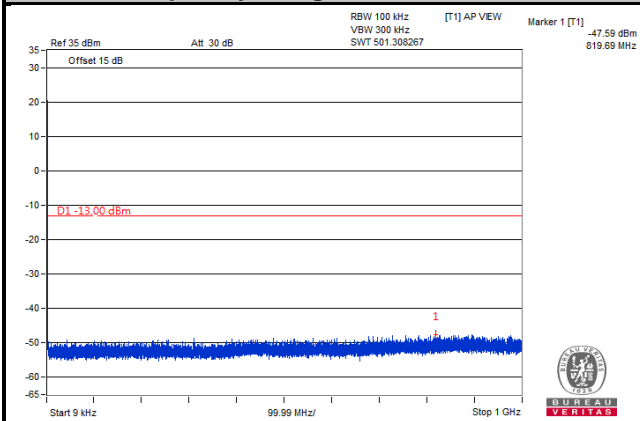

Frequency Range: 1 GHz ~ 10 GHz

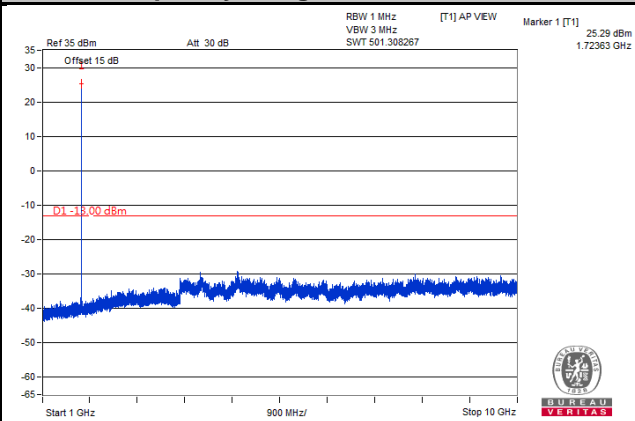

Frequency Range: 10 GHz ~ 27 GHz

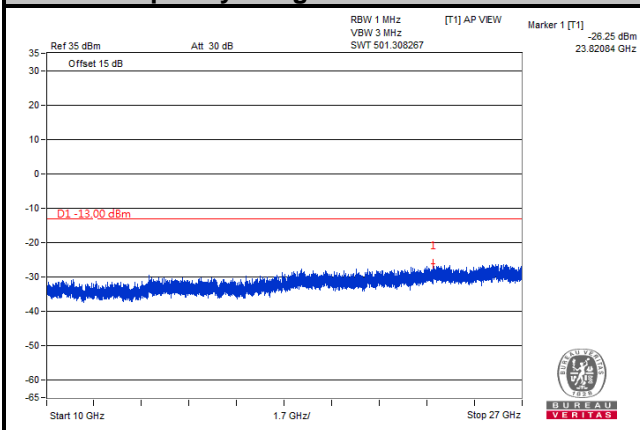

Note: The signal over the limit in 9 kHz is from spectrum analyzer.

LTE Band 4

Channel Bandwidth: 20 MHz

Channel 20300

Frequency Range: 9 kHz ~ 1 GHz

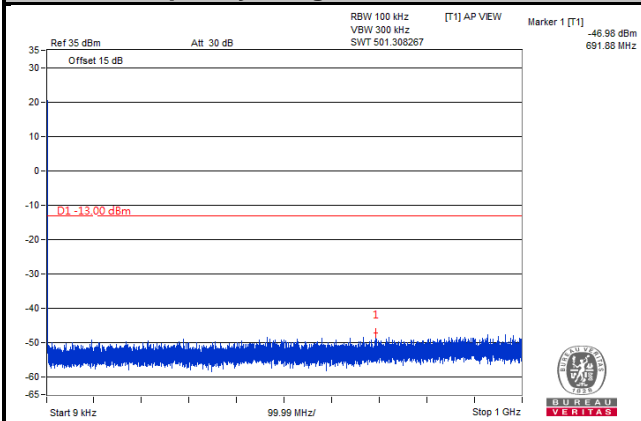

Frequency Range: 1 GHz ~ 10 GHz

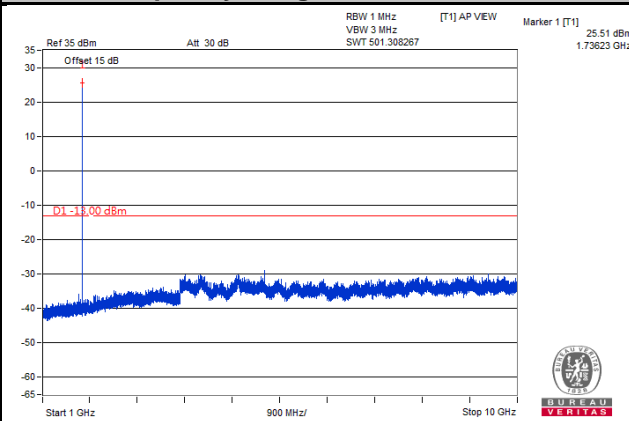

Frequency Range: 10 GHz ~ 27 GHz

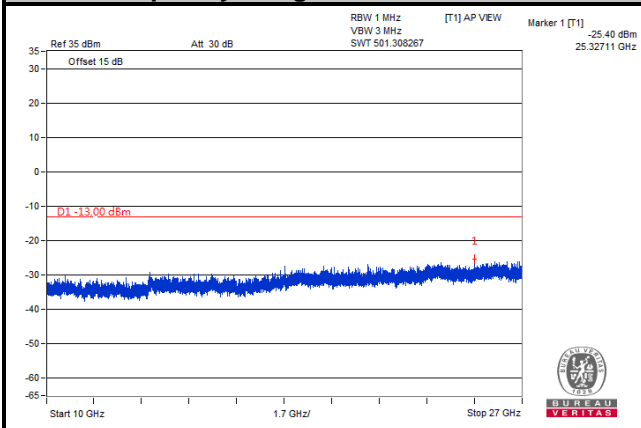

Note: The signal over the limit in 9 kHz is from spectrum analyzer.

LTE Band 12
Channel Bandwidth: 5 MHz

Channel 23035

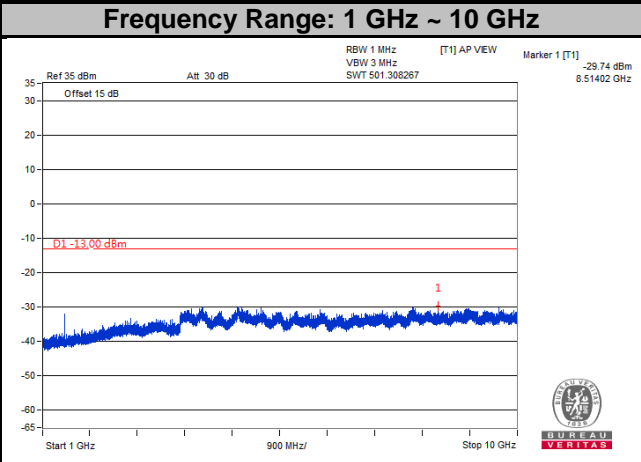
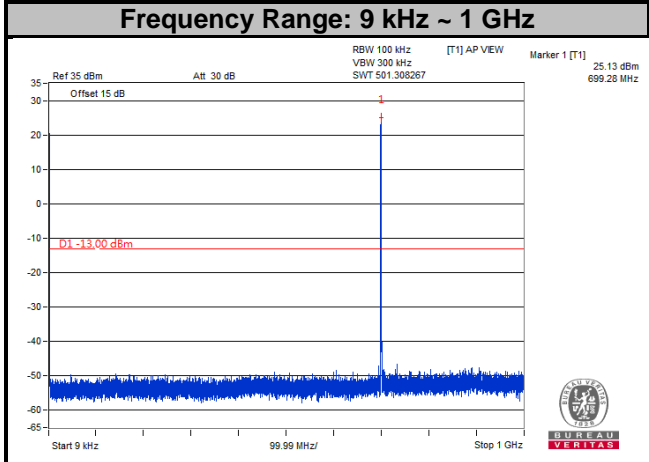

Channel 23095

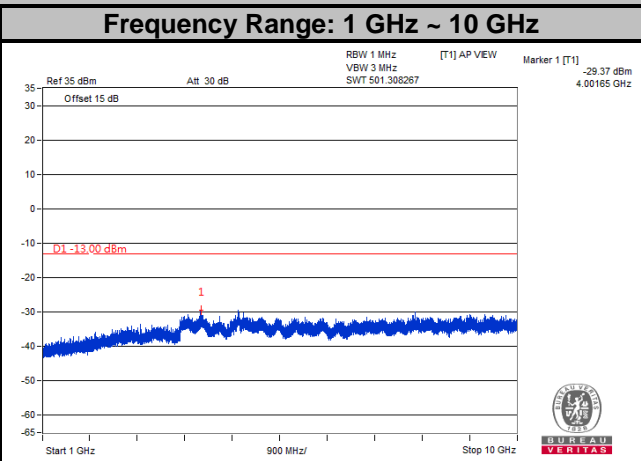
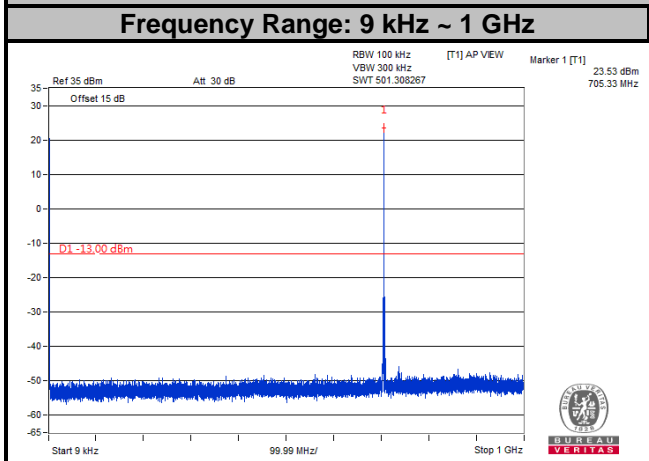

Channel 23155

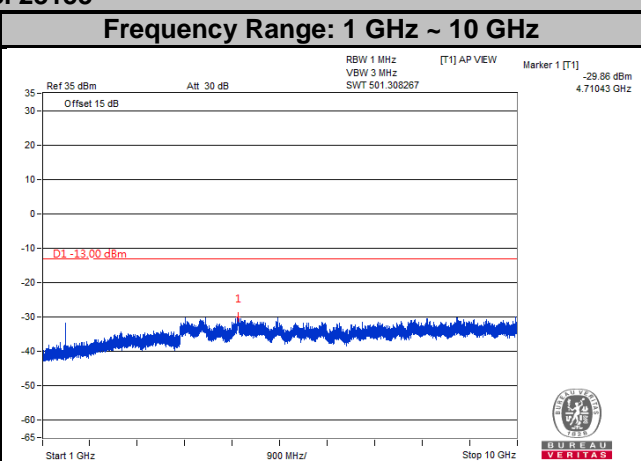
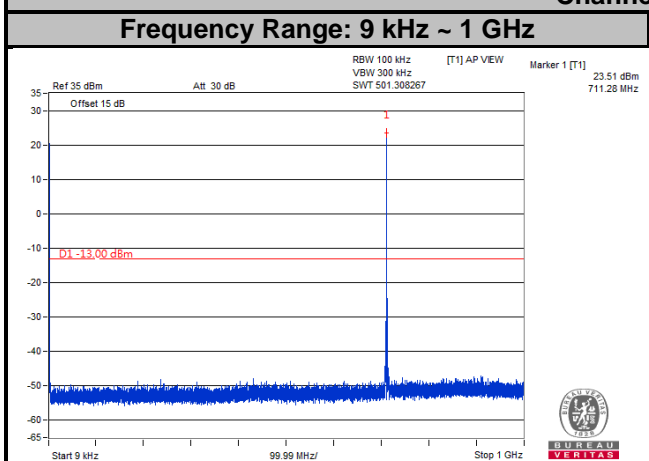

Note: The signal over the limit in 9 kHz is from spectrum analyzer.

LTE Band 12

Channel Bandwidth: 10 MHz

Channel 23060

Frequency Range: 9 kHz ~ 1 GHz

Frequency Range: 1 GHz ~ 10 GHz

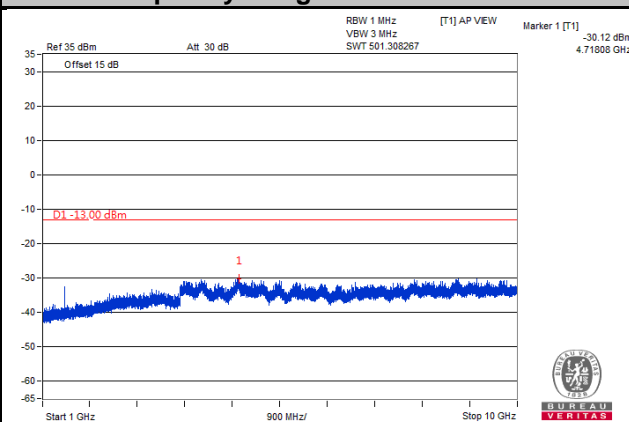
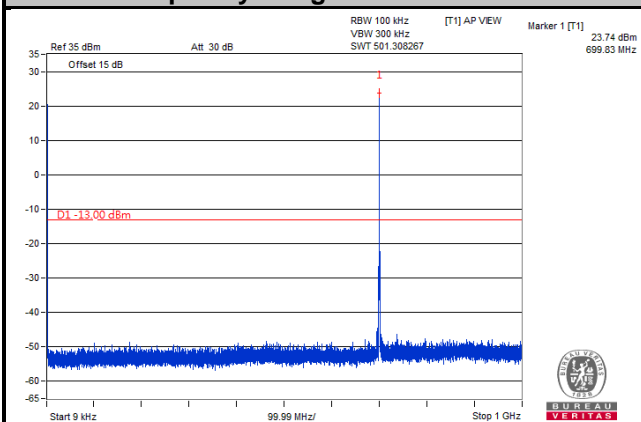

Channel 23095

Frequency Range: 9 kHz ~ 1 GHz

Frequency Range: 1 GHz ~ 10 GHz

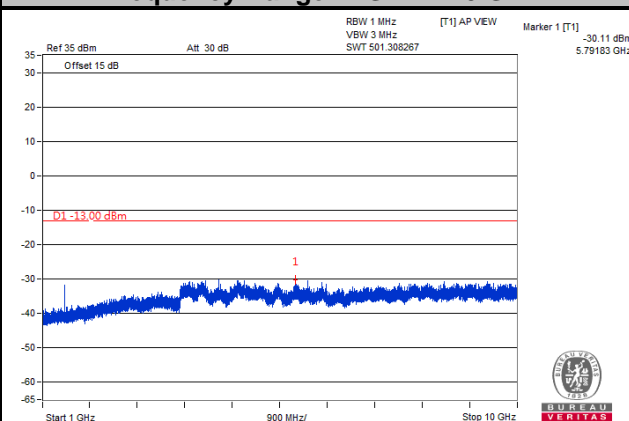
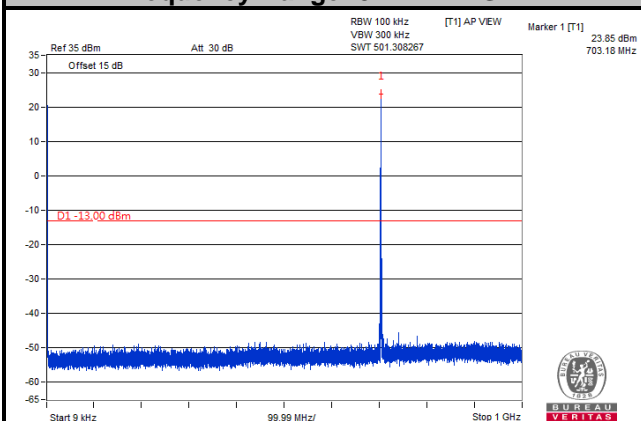

Channel 23130

Frequency Range: 9 kHz ~ 1 GHz

Frequency Range: 1 GHz ~ 10 GHz

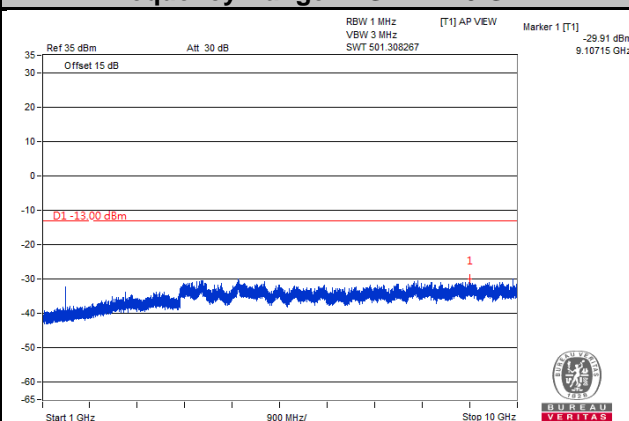
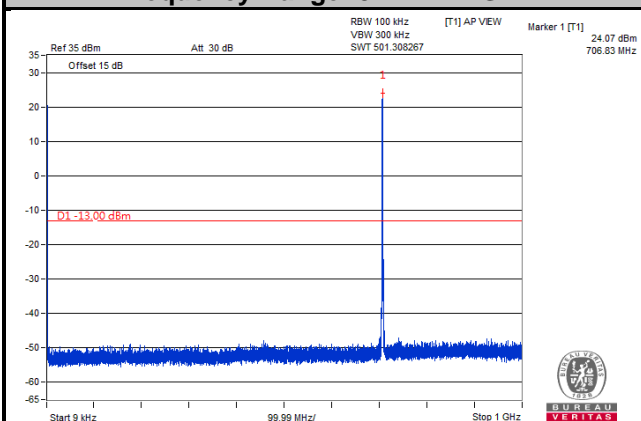

Note: The signal over the limit in 9 kHz is from spectrum analyzer.

LTE Band 13

Channel Bandwidth: 5 MHz

Channel 23205

Frequency Range: 9 kHz ~ 1 GHz

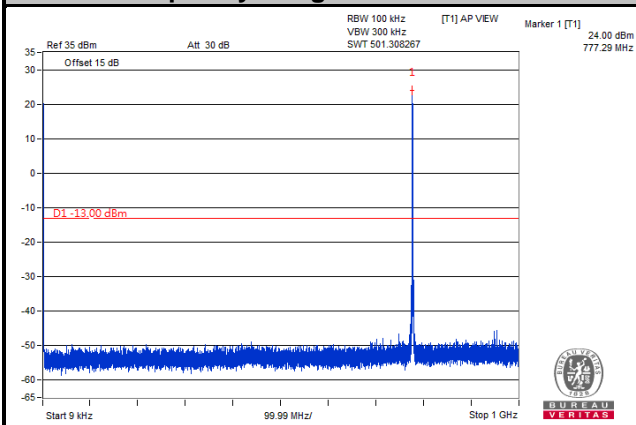

Frequency Range: 1 GHz ~ 1.559 GHz

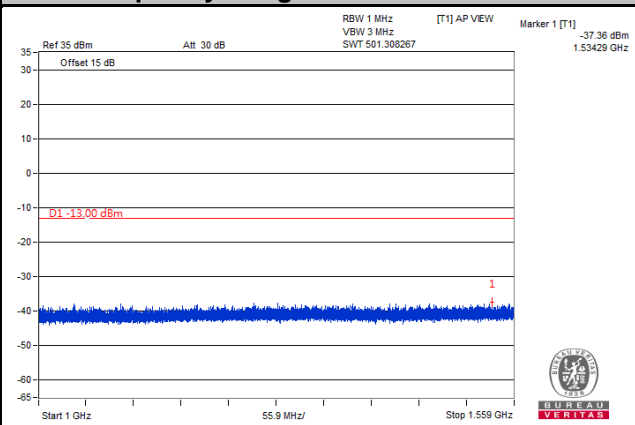

Frequency Range: 1.559 GHz ~ 1.61 GHz

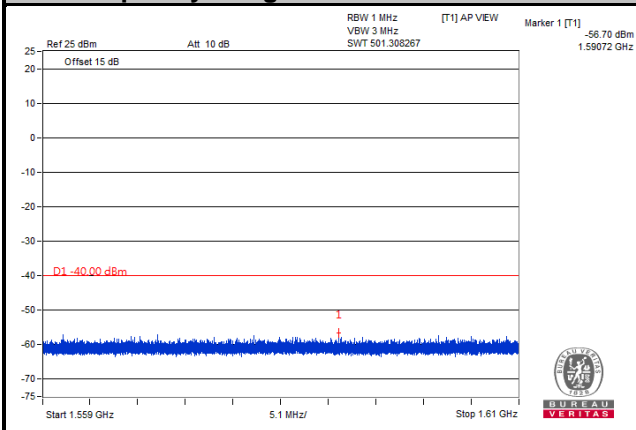

Frequency Range: 1.61 GHz ~ 8 GHz

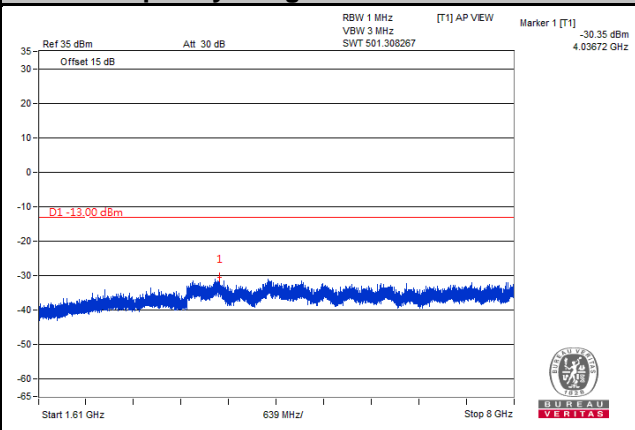

Note: The signal over the limit in 9 kHz is from spectrum analyzer.

LTE Band 13

Channel Bandwidth: 5 MHz

Channel 23230

Frequency Range: 9 kHz ~ 1 GHz

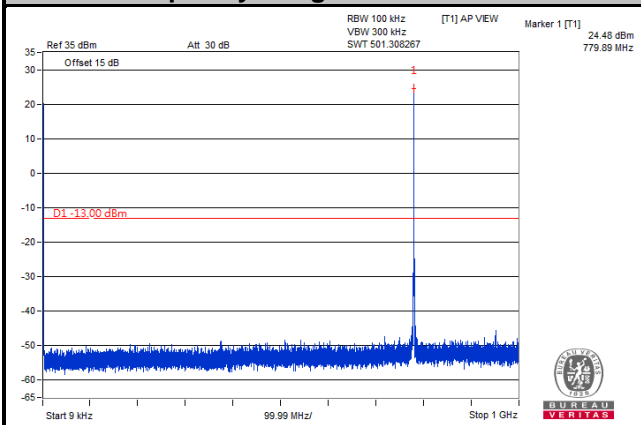

Frequency Range: 1 GHz ~ 1.559 GHz

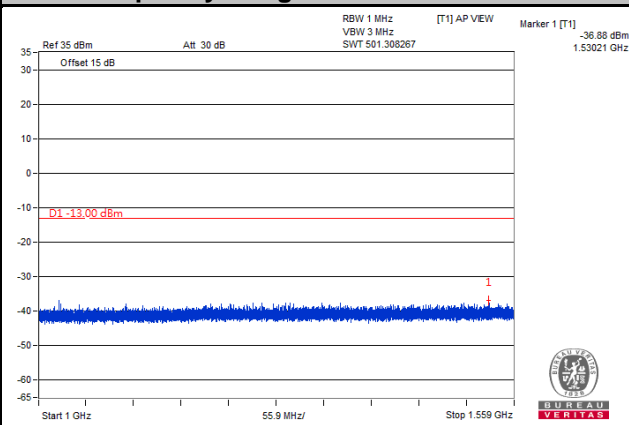

Frequency Range: 1.559 GHz ~ 1.61 GHz

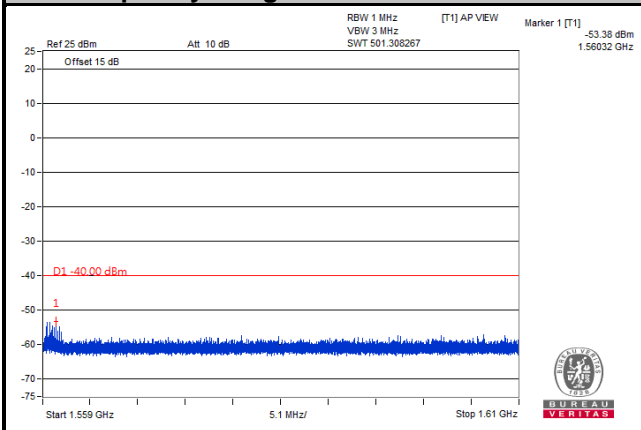

Frequency Range: 1.61 GHz ~ 8 GHz

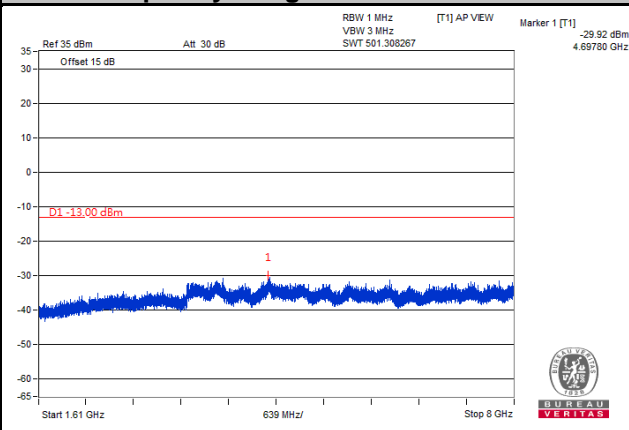

Note: The signal over the limit in 9 kHz is from spectrum analyzer.

LTE Band 13

Channel Bandwidth: 5 MHz

Channel 23255

Frequency Range: 9 kHz ~ 1 GHz

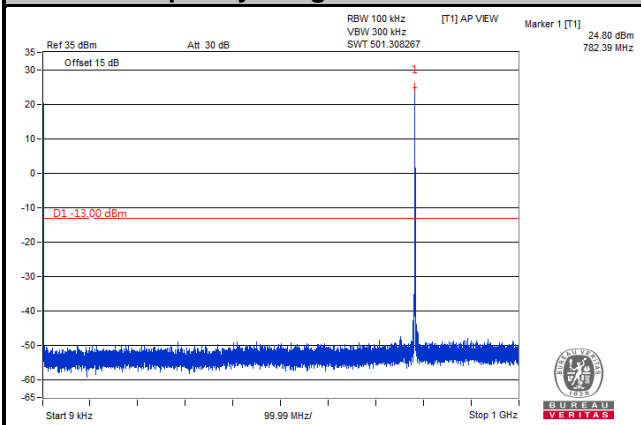

Frequency Range: 1 GHz ~ 1.559 GHz

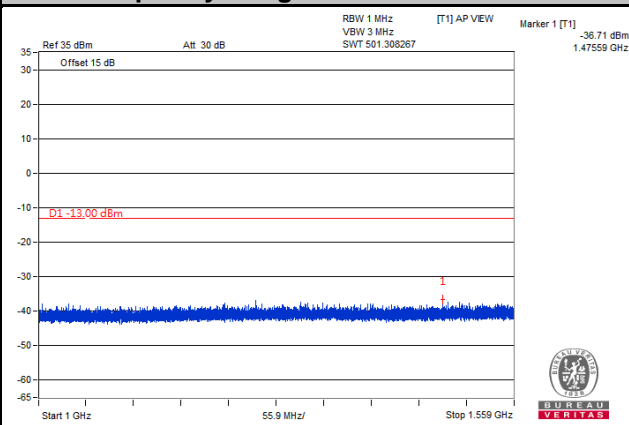

Frequency Range: 1.559 GHz ~ 1.61 GHz

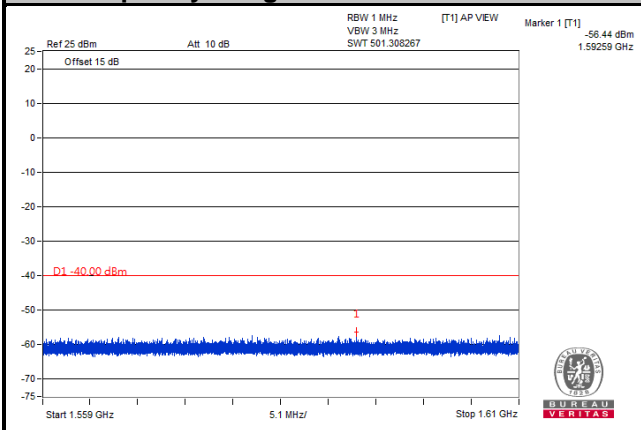

Frequency Range: 1.61 GHz ~ 8 GHz

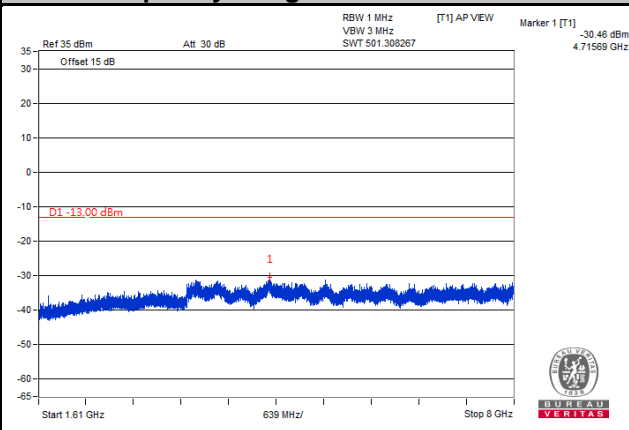

Note: The signal over the limit in 9 kHz is from spectrum analyzer.

LTE Band 13

Channel Bandwidth: 10 MHz

Channel 23230

Frequency Range: 9 kHz ~ 1 GHz

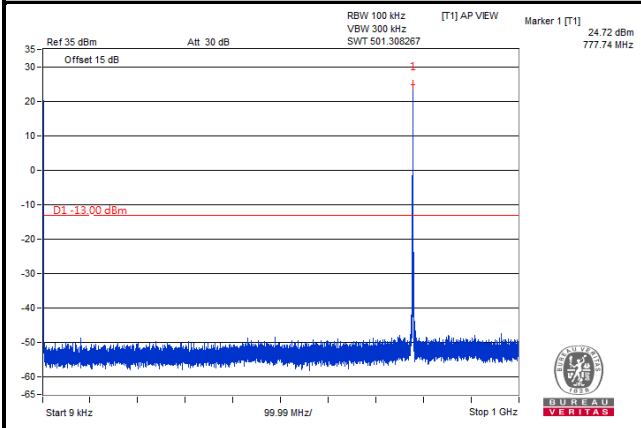

Frequency Range: 1 GHz ~ 1.559 GHz

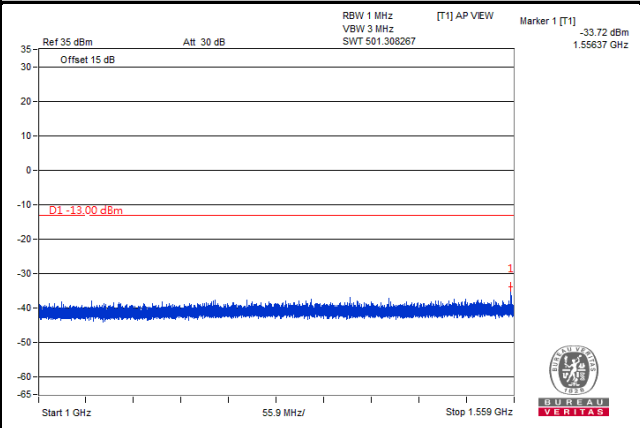

Frequency Range: 1.559 GHz ~ 1.61 GHz

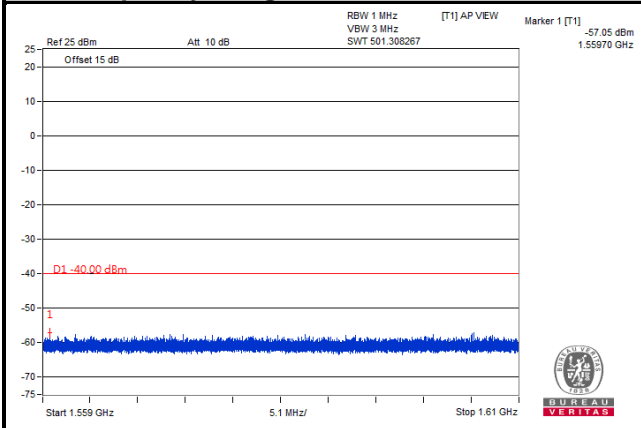

Frequency Range: 1.61 GHz ~ 8 GHz

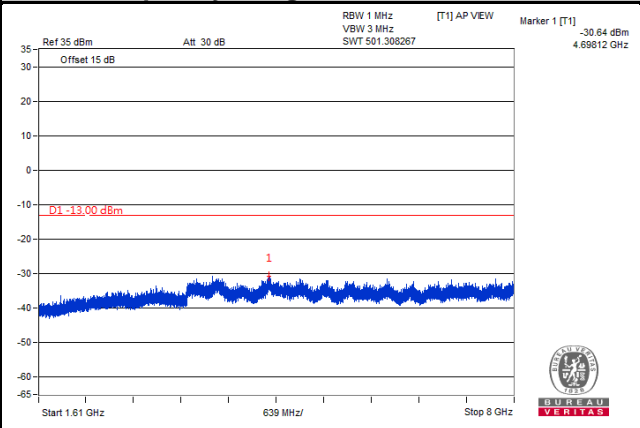

Note: The signal over the limit in 9 kHz is from spectrum analyzer.

4.8 Radiated Emission Measurement

4.8.1 Limits of Radiated Emission Measurement

- a. The power of any emission outside a licensee's frequency block shall be attenuated below the transmitter power (P) by at least $43 + 10 \log (P)$ dB. The limit of emission is equal to -13 dBm.
- b. For operations in the 775-788 MHz, emissions in the band 1559-1610 MHz shall be limited to -70 dBW/MHz. The limit of emissions is equal to -40 dBm.

4.8.2 Test Procedure

- a. Substitution method is used for E.I.R.P measurement. In the semi-anechoic chamber, EUT placed on the 0.8 m (below or equal 1 GHz) and/or 1.5 m (above 1 GHz) height of Turn Table, rotated the table around 360 degrees to search the maximum radiation power and receiver antenna shall be rotated vertical and horizontal polarization and moved height from 1 m to 4 m to find the maximum polar radiated power. The "Read Value" is the spectrum reading the maximum power value.
- b. The substitution horn antenna is substituted for EUT at the same position and signals generator export the CW signal to the substitution antenna via a TX cable. Rotated the Turn Table and moved receiving antenna to find the maximum radiation power. Adjust output power level of S.G to get a Value of spectrum reading equal to "Read Value" of step a. Record the power level of S.G.
- c. $EIRP = \text{Output power level of S.G} - \text{TX cable loss} + \text{Antenna gain of substitution horn}$.
- d. E.R.P power can be calculated form E.I.R.P power by subtracting the gain of dipole, $E.R.P \text{ power} = E.I.R.P \text{ power} - 2.15 \text{ dB}$.

Note: The resolution bandwidth of spectrum analyzer is 1 MHz and the video bandwidth is 3 MHz.

4.8.3 Deviation from Test Standard

No deviation.

4.8.4 Test Setup

<Radiated Emission below or equal 1 GHz>

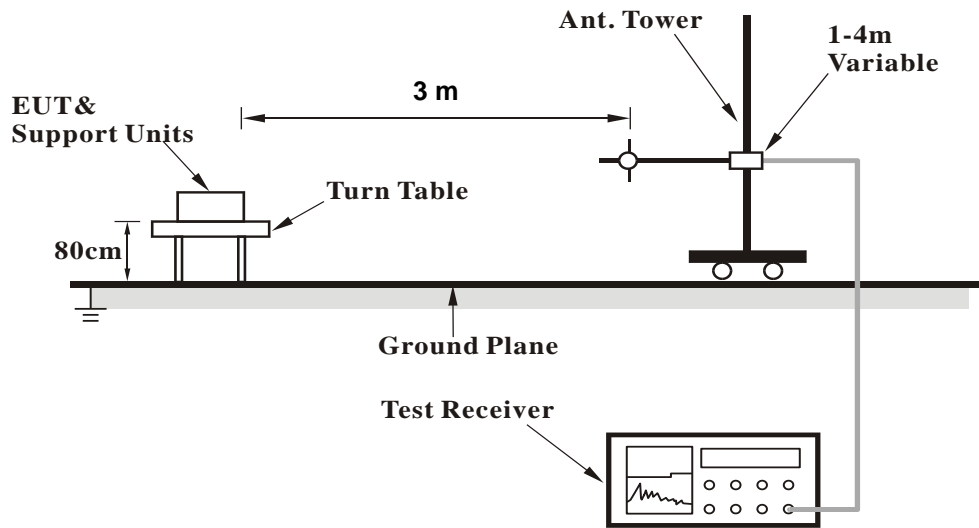

<Radiated Emission above 1 GHz>

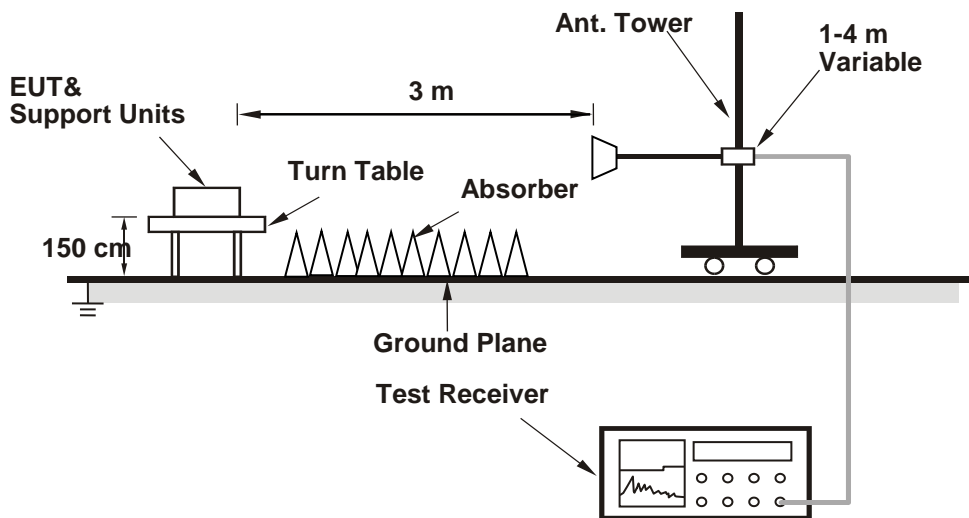

For the actual test configuration, please refer to the attached file (Test Setup Photo).

4.8.5 Test Results

LTE Band 4

Channel Bandwidth: 5 MHz / QPSK

Low Channel

Bureau Veritas Consumer Products Services Ltd., Taoyuan



A D T

Data: 3

Date: 03-23-2019

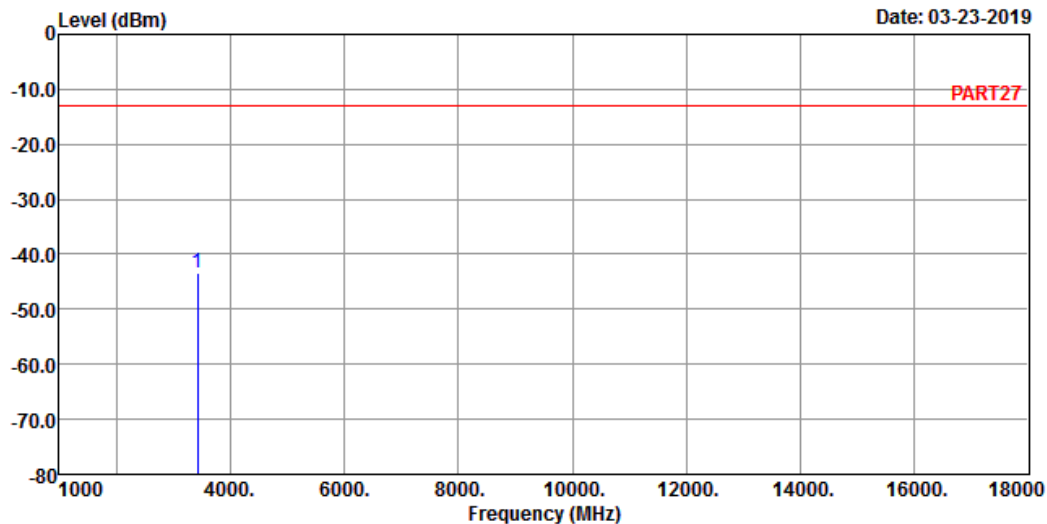

Site : 966 Chamber 5
 Condition: PART27 HORIZONTAL
 Remak : Cat-M1 Band 4 QPSK_5M Link_L-CH
 Tested by: Thomas Wei

Freq	Level	Read Level	Limit	Line Factor	Over Limit	Remark
MHz	dBm	dBm	dBm	dB	dB	

1 pp 3425.00 -43.52 -35.18 -13.00 -8.34 -30.52 Peak

Bureau Veritas Consumer Products Services Ltd., Taoyuan



A D T

Data: 4

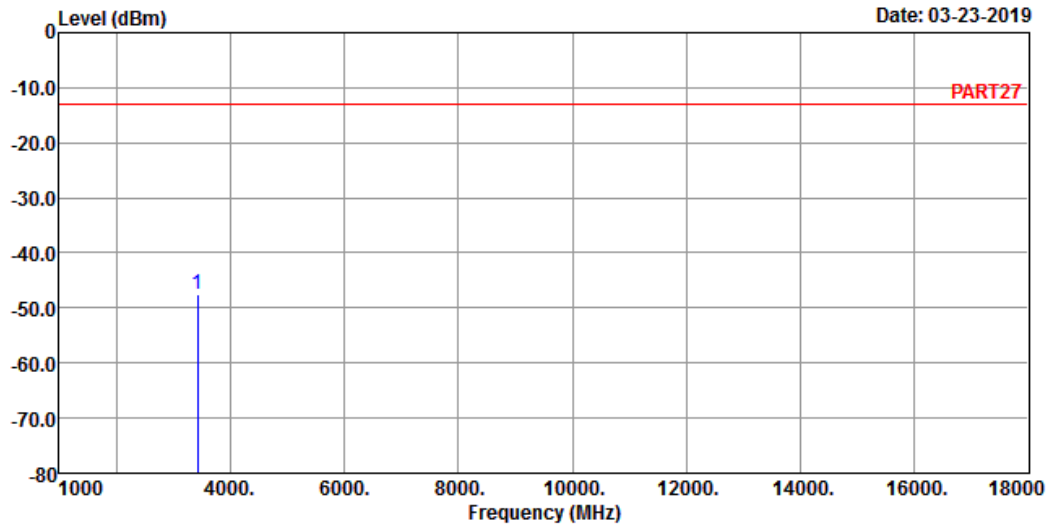

Site : 966 Chamber 5
 Condition: PART27 VERTICAL
 Remak : Cat-M1 Band 4 QPSK_5M Link_L-CH
 Tested by: Thomas Wei

Freq	Level	Read Level	Limit	Line Factor	Over Limit	Remark
MHz	dBm	dBm	dBm	dB	dB	
1 pp 3425.00	-47.48	-39.14	-13.00	-8.34	-34.48	Peak

Middle Channel

Bureau Veritas Consumer Products Services Ltd., Taoyuan



A D T

Data: 3

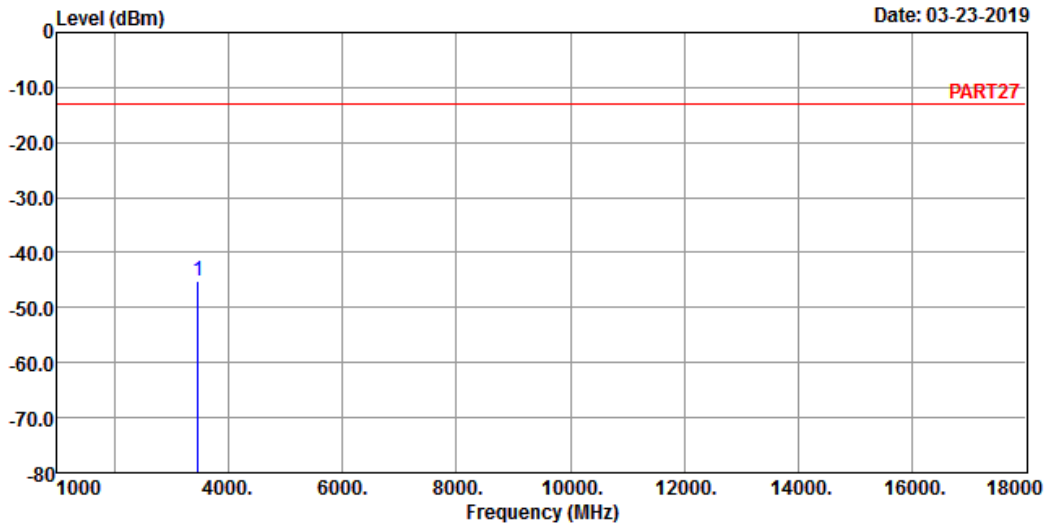

Site : 966 Chamber 5
 Condition: PART27 HORIZONTAL
 Remak : Cat-M1 Band 4 QPSK_5M Link_M-CH
 Tested by: Thomas Wei

Freq	Level	Read Level	Limit	Line Factor	Over Limit	Remark
MHz	dBm	dBm	dBm	dB	dB	

1 pp 3465.00 -45.11 -37.23 -13.00 -7.88 -32.11 Peak

Bureau Veritas Consumer Products Services Ltd., Taoyuan



A D T

Data: 4

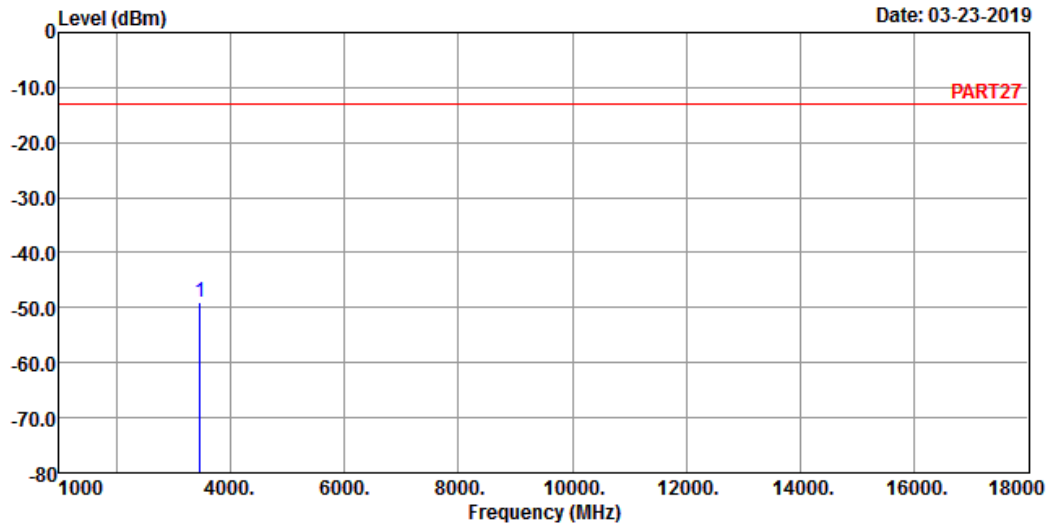

Site : 966 Chamber 5
 Condition: PART27 VERTICAL
 Remak : Cat-M1 Band 4 QPSK_5M Link_M-CH
 Tested by: Thomas Wei

Freq	Level	Read Level	Limit	Over	Remark
MHz	dBm	dBm	dBm	dB	
1 pp 3465.00	-48.89	-41.01	-13.00	-7.88 -35.89	Peak

High Channel

Bureau Veritas Consumer Products Services Ltd., Taoyuan



A D T

Data: 3

Date: 03-23-2019

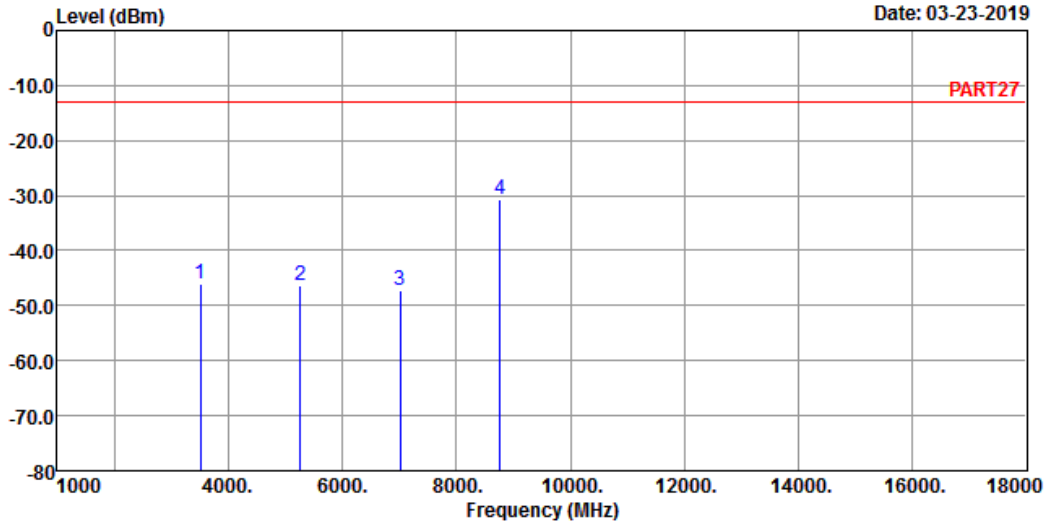

Site : 966 Chamber 5
 Condition: PART27 HORIZONTAL
 Remak : Cat-M1 Band 4 QPSK_5M Link_H-CH
 Tested by: Thomas Wei

	Freq	Level	Read Level	Limit	Line Factor	Over Limit	Remark
	MHz	dBm	dBm	dBm	dB	dB	
1	3505.00	-46.12	-38.67	-13.00	-7.45	-33.12	Peak
2	5257.50	-46.22	-43.70	-13.00	-2.52	-33.22	Peak
3	7010.00	-47.33	-50.52	-13.00	3.19	-34.33	Peak
4 pp	8762.50	-30.70	-35.43	-13.00	4.73	-17.70	Peak

Bureau Veritas Consumer Products Services Ltd., Taoyuan



A D T

Data: 4

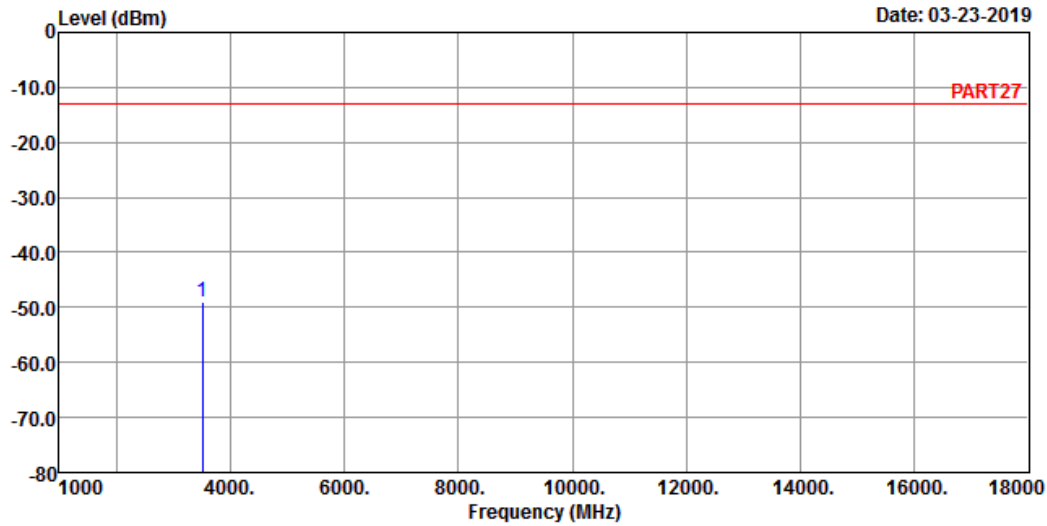

Site : 966 Chamber 5
 Condition: PART27 VERTICAL
 Remak : Cat-M1 Band 4 QPSK_5M Link_H-CH
 Tested by: Thomas Wei

Freq	Level	Read Level	Limit	Line Factor	Over Limit	Remark
MHz	dBm	dBm	dBm	dB	dB	
1 pp 3505.00	-49.01	-41.56	-13.00	-7.45	-36.01	Peak

Channel Bandwidth: 20 MHz / QPSK
Low Channel

Bureau Veritas Consumer Products Services Ltd., Taoyuan



A D T

Data: 3

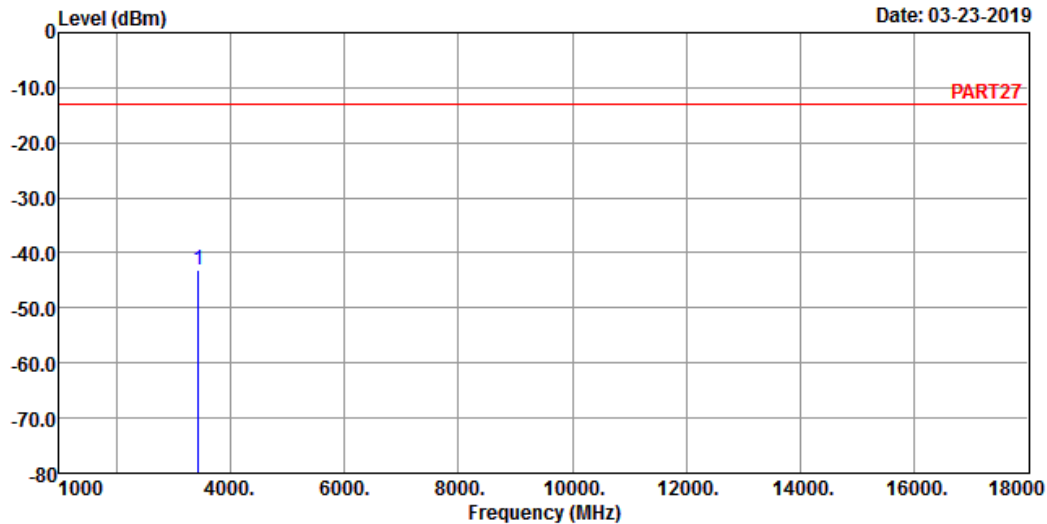

Site : 966 Chamber 5
Condition: PART27 HORIZONTAL
Remak : Cat-M1 Band 4 QPSK_20M Link_L-CH
Tested by: Thomas Wei

Freq	Level	Read Level	Limit	Line Factor	Over Limit	Remark
MHz	dBm	dBm	dBm	dB	dB	
1 pp 3440.00	-43.00	-34.78	-13.00	-8.22	-30.00	Peak

Bureau Veritas Consumer Products Services Ltd., Taoyuan



A D T

Data: 4

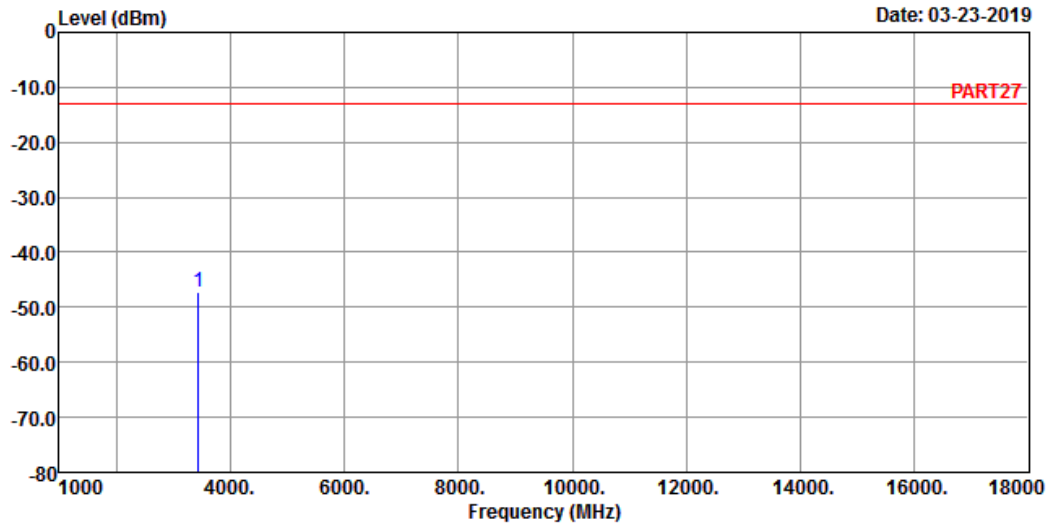

Site : 966 Chamber 5
 Condition: PART27 VERTICAL
 Remak : Cat-M1 Band 4 QPSK_20M Link_L-CH
 Tested by: Thomas Wei

Freq	Level	Read Level	Limit	Line Factor	Over Limit	Remark
MHz	dBm	dBm	dBm	dB	dB	
1 pp 3440.00	-47.09	-38.87	-13.00	-8.22	-34.09	Peak

Middle Channel

Bureau Veritas Consumer Products Services Ltd., Taoyuan



A D T

Data: 3

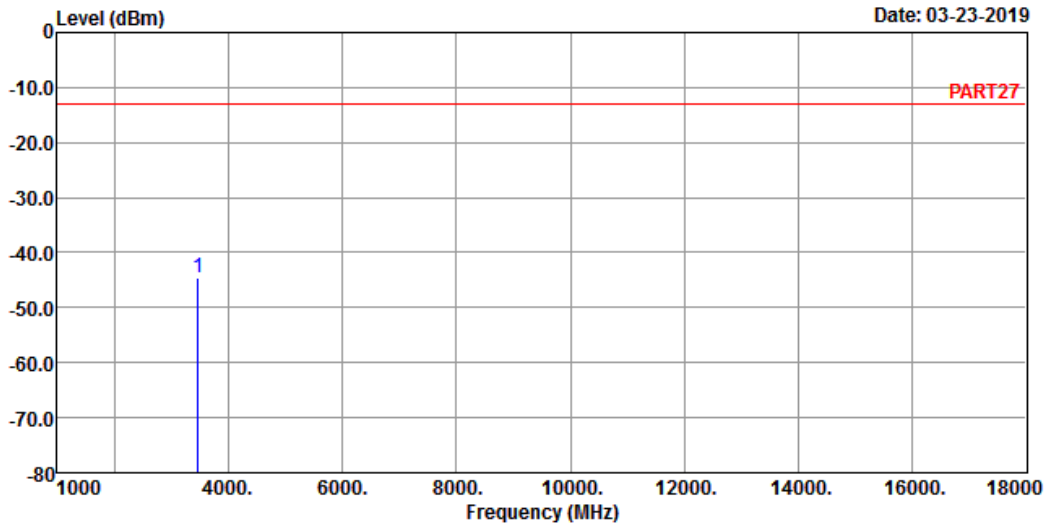

Site : 966 Chamber 5
 Condition: PART27 HORIZONTAL
 Remak : Cat-M1 Band 4 QPSK_20M Link_M-CH
 Tested by: Thomas Wei

Freq	Level	Read Level	Limit	Line Factor	Over Limit	Remark
MHz	dBm	dBm	dBm	dB	dB	

1 pp 3465.00 -44.64 -36.76 -13.00 -7.88 -31.64 Peak

Bureau Veritas Consumer Products Services Ltd., Taoyuan



A D T

Data: 4

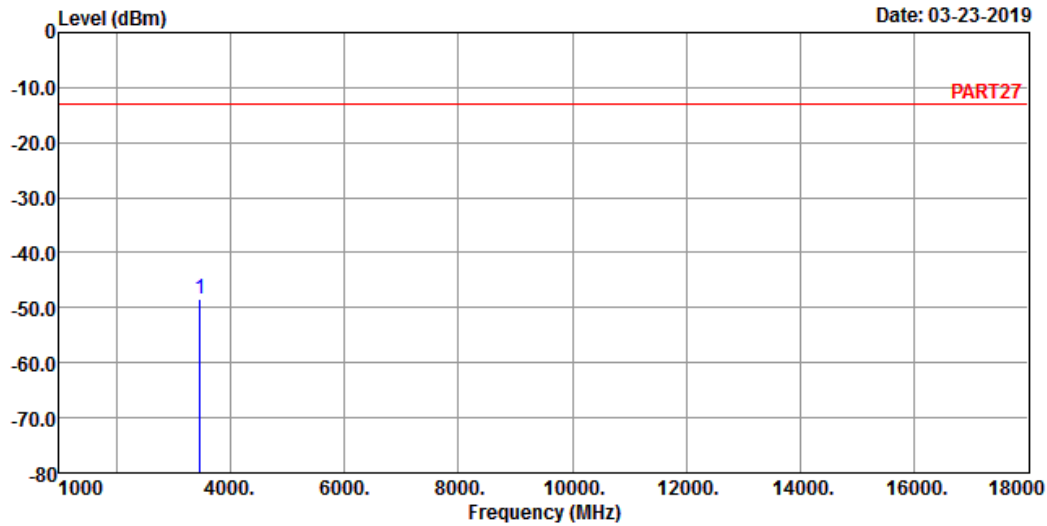

Site : 966 Chamber 5
 Condition: PART27 VERTICAL
 Remak : Cat-M1 Band 4 QPSK_20M Link_M-CH
 Tested by: Thomas Wei

Freq	Level	Read Level	Limit	Line Factor	Over Limit	Remark
MHz	dBm	dBm	dBm	dB	dB	
1 pp 3465.00	-48.43	-40.55	-13.00	-7.88	-35.43	Peak

High Channel

Bureau Veritas Consumer Products Services Ltd., Taoyuan



A D T

Data: 5

Date: 03-23-2019

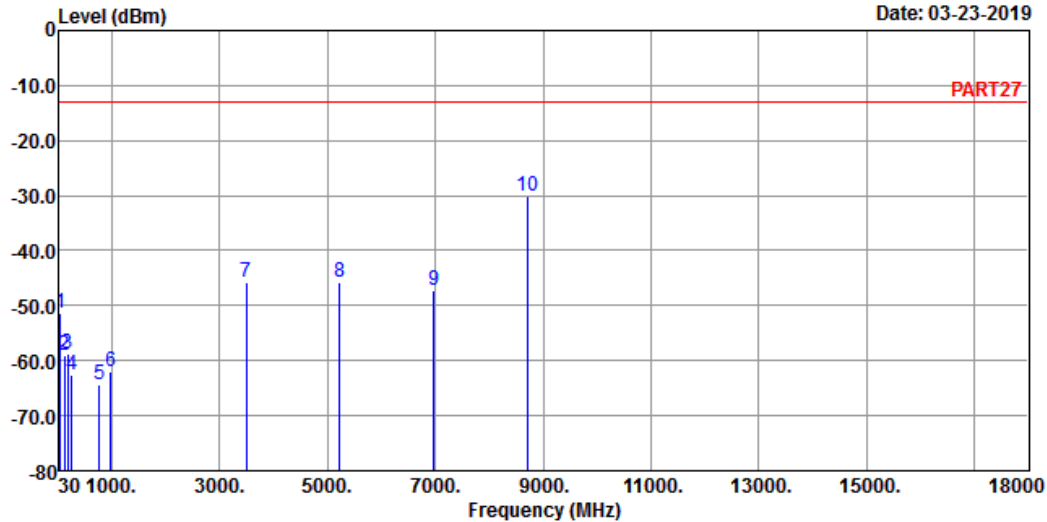

Site : 966 Chamber 5
 Condition: PART27 HORIZONTAL
 Remak : Cat-M1 Band 4 QPSK_20M Link_H-CH
 Tested by: Thomas Wei

	Freq	Level	Read Level	Limit	Line Factor	Over Limit	Remark
	MHz	dBm	dBm	dBm	dB	dB	
1	43.58	-51.46	-49.99	-13.00	-1.47	-38.46	Peak
2	127.00	-59.02	-49.98	-13.00	-9.04	-46.02	Peak
3	191.02	-58.81	-51.63	-13.00	-7.18	-45.81	Peak
4	253.10	-62.52	-56.47	-13.00	-6.05	-49.52	Peak
5	776.90	-64.30	-65.10	-13.00	0.80	-51.30	Peak
6	987.39	-61.89	-65.02	-13.00	3.13	-48.89	Peak
7	3490.00	-45.62	-37.97	-13.00	-7.65	-32.62	Peak
8	5235.00	-45.82	-43.41	-13.00	-2.41	-32.82	Peak
9	6980.00	-47.16	-50.22	-13.00	3.06	-34.16	Peak
10 pp	8725.00	-30.25	-35.01	-13.00	4.76	-17.25	Peak

Bureau Veritas Consumer Products Services Ltd., Taoyuan



A D T

Data: 6

Date: 03-23-2019

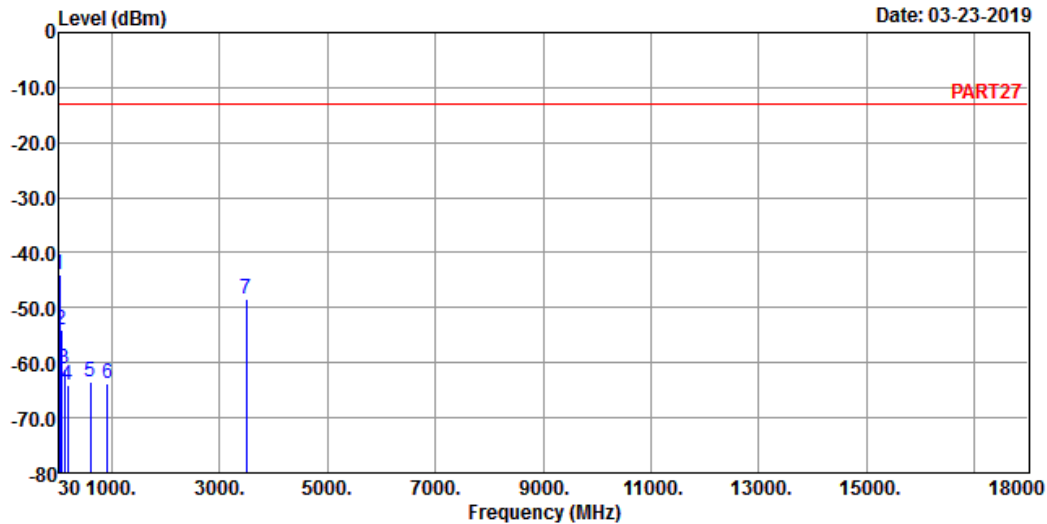

Site : 966 Chamber 5
 Condition: PART27 VERTICAL
 Remak : Cat-M1 Band 4 QPSK_20M Link_H-CH
 Tested by: Thomas Wei

	Freq	Level	Read Level	Limit	Line	Factor	Over	Remark
	MHz	dBm	dBm	dBm		dB	dB	
1 pp	39.70	-43.99	-44.63	-13.00		0.64	-30.99	Peak
2	68.80	-53.99	-45.67	-13.00		-8.32	-40.99	Peak
3	127.97	-61.07	-52.15	-13.00		-8.92	-48.07	Peak
4	190.05	-64.09	-57.00	-13.00		-7.09	-51.09	Peak
5	603.27	-63.48	-62.72	-13.00		-0.76	-50.48	Peak
6	919.49	-63.76	-64.81	-13.00		1.05	-50.76	Peak
7	3490.00	-48.50	-40.85	-13.00		-7.65	-35.50	Peak

LTE Band 12
Channel Bandwidth: 5 MHz / QPSK
Low Channel

Bureau Veritas Consumer Products Services Ltd., Taoyuan



A D T

Data: 3

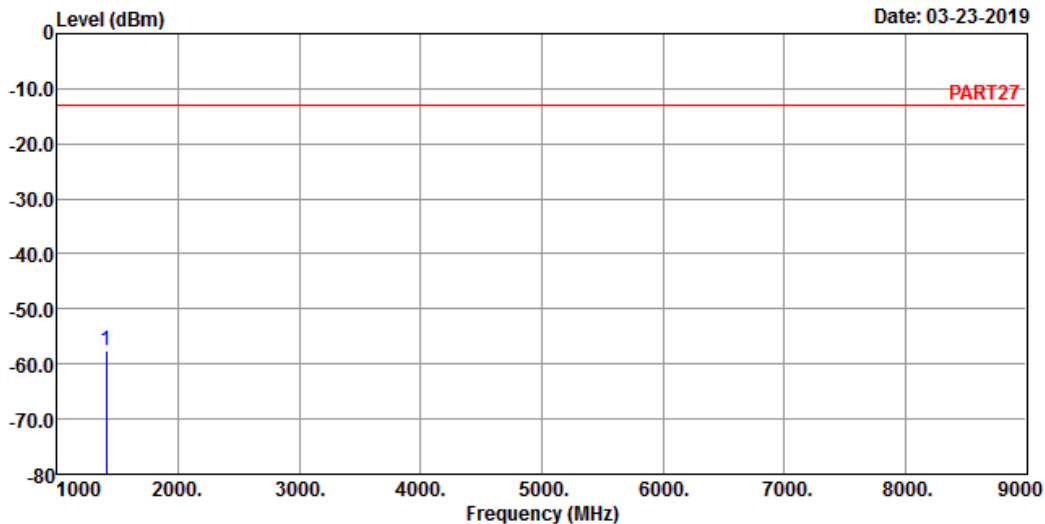

Site : 966 Chamber 5
Condition: PART27 HORIZONTAL
Remak : Cat-M1 Band 12 QPSK_5M Link_L-CH
Tested by: Thomas Wei

Freq	Level	Read Level	Limit	Over	Remark
MHz	dBm	dBm	dBm	dB	dB
1403.00	-57.46	-45.55	-13.00	-11.91	-44.46 Peak

Bureau Veritas Consumer Products Services Ltd., Taoyuan



A D T

Data: 4

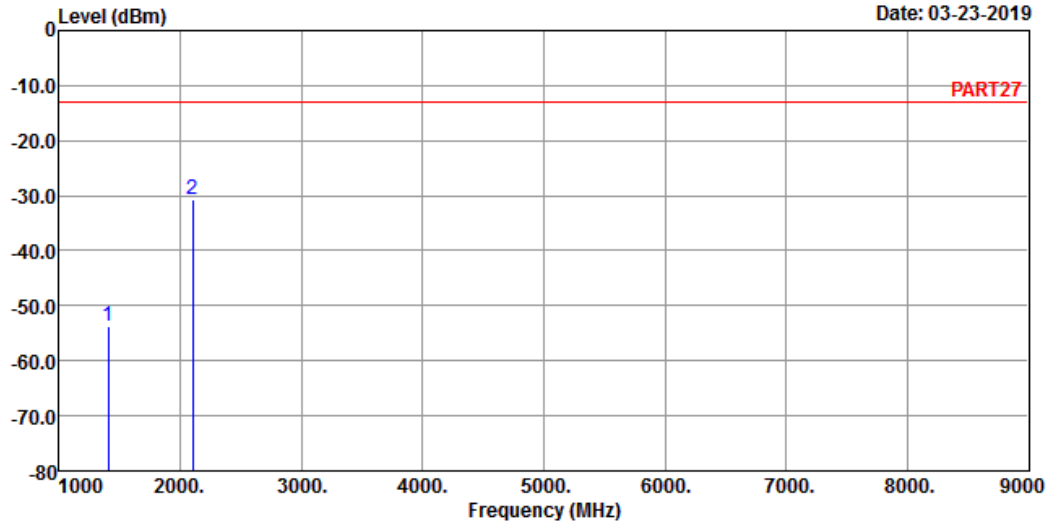

Site : 966 Chamber 5
 Condition: PART27 VERTICAL
 Remak : Cat-M1 Band 12 QPSK_5M Link_L-CH
 Tested by: Thomas Wei

	Freq	Level	Read Level	Limit	Line Factor	Over Limit	Remark
	MHz	dBm	dBm	dBm	dB	dB	
1	1403.00	-53.83	-41.92	-13.00	-11.91	-40.83	Peak
2	2104.50	-30.66	-20.50	-13.00	-10.16	-17.66	Peak

Middle Channel

Bureau Veritas Consumer Products Services Ltd., Taoyuan



A D T

Data: 3

Date: 03-23-2019

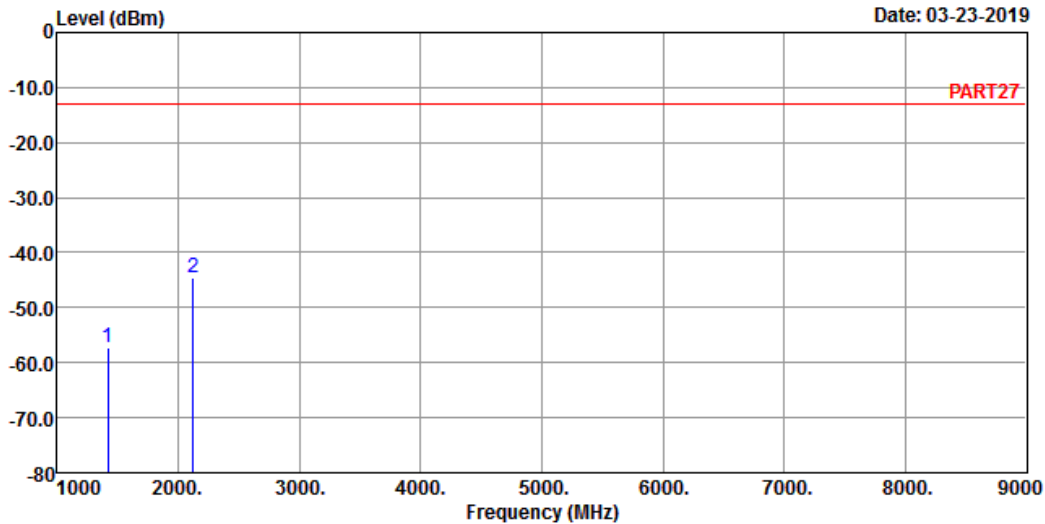

Site : 966 Chamber 5
 Condition: PART27 HORIZONTAL
 Remak : Cat-M1 Band 12 QPSK_5M Link_M-CH
 Tested by: Thomas Wei

	Freq	Level	Read Level	Limit	Line Factor	Over Limit	Remark
	MHz	dBm	dBm	dBm	dB	dB	
1	1415.00	-57.33	-45.25	-13.00	-12.08	-44.33	Peak
2 pp	2122.50	-44.58	-34.71	-13.00	-9.87	-31.58	Peak

Bureau Veritas Consumer Products Services Ltd., Taoyuan



A D T

Data: 4

Date: 03-23-2019

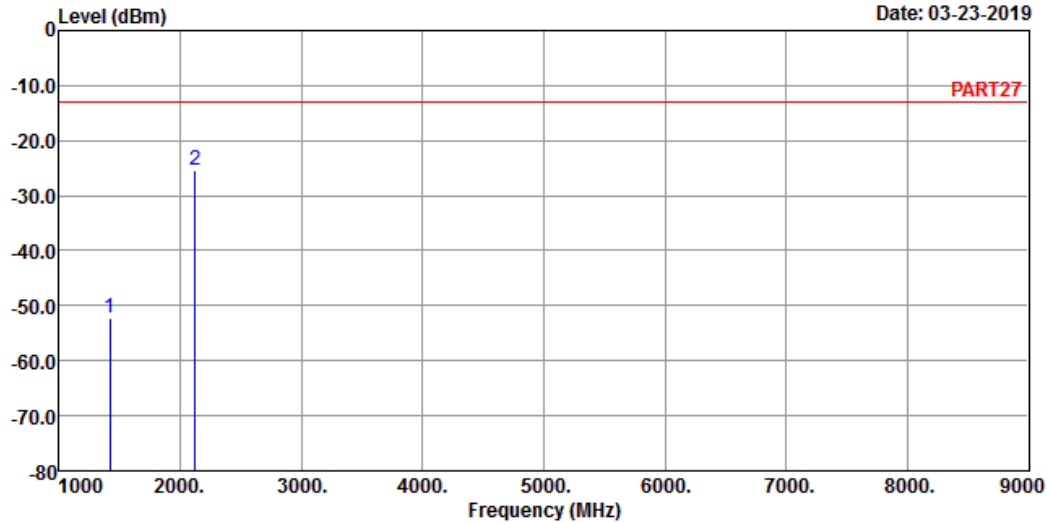

Site : 966 Chamber 5
 Condition: PART27 VERTICAL
 Remak : Cat-M1 Band 12 QPSK_5M Link_M-CH
 Tested by: Thomas Wei

	Freq	Level	Read Level	Limit	Line Factor	Over Limit	Remark
	MHz	dBm	dBm	dBm	dB	dB	
1	1415.00	-52.22	-40.14	-13.00	-12.08	-39.22	Peak
2	2122.50	-25.43	-15.56	-13.00	-9.87	-12.43	Peak

High Channel

Bureau Veritas Consumer Products Services Ltd., Taoyuan



A D T

Data: 3

Date: 03-23-2019

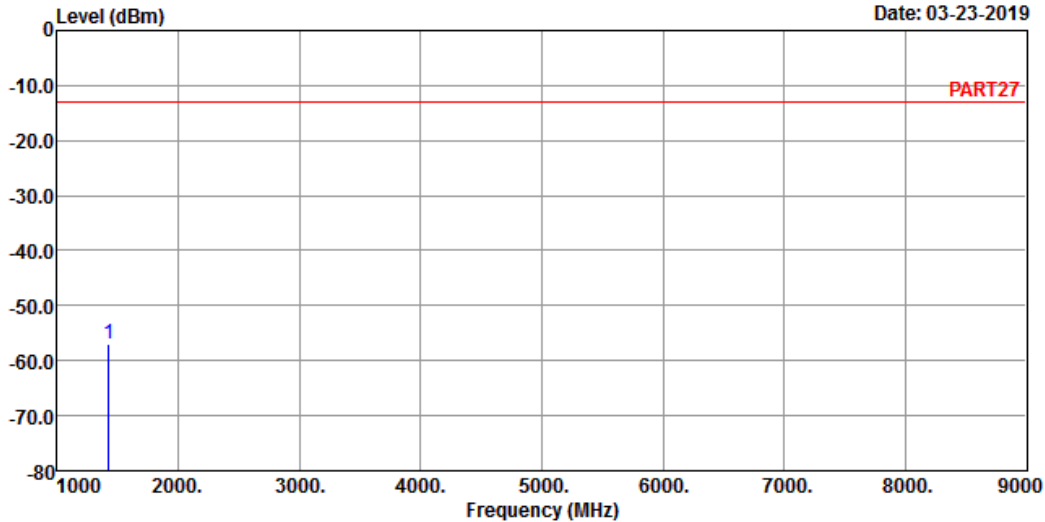

Site : 966 Chamber 5
 Condition: PART27 HORIZONTAL
 Remak : Cat-M1 Band 12 QPSK_5M Link_H-CH
 Tested by: Thomas Wei

Freq	Level	Read Level	Limit	Line Factor	Over Limit	Remark
MHz	dBm	dBm	dBm	dB	dB	

1 pp 1427.00 -57.03 -44.78 -13.00 -12.25 -44.03 Peak

Bureau Veritas Consumer Products Services Ltd., Taoyuan



A D T

Data: 4

Date: 03-23-2019

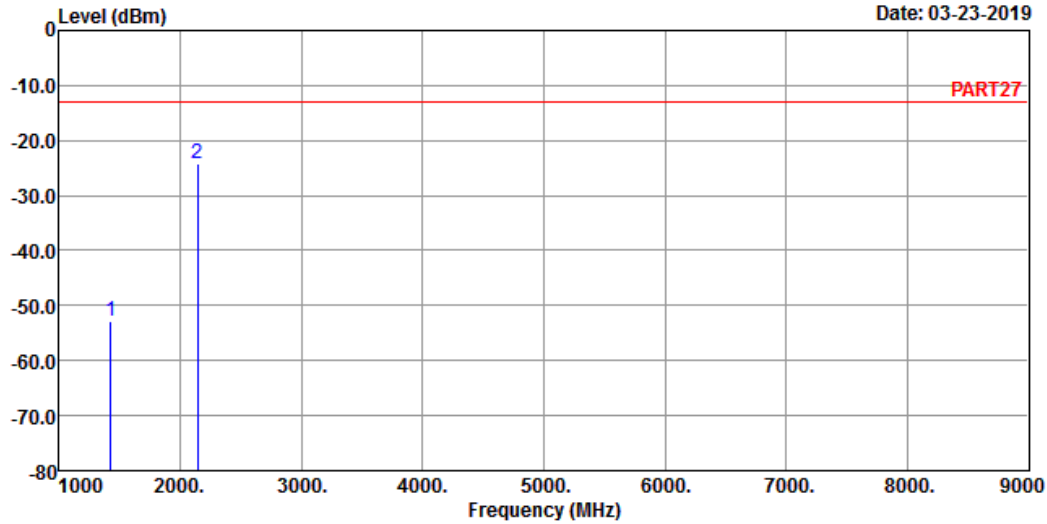

Site : 966 Chamber 5
 Condition: PART27 VERTICAL
 Remak : Cat-M1 Band 12 QPSK_5M Link_H-CH
 Tested by: Thomas Wei

	Freq	Level	Read Level	Limit	Line Factor	Over Limit	Remark
	MHz	dBm	dBm	dBm	dB	dB	
1	1427.00	-52.77	-40.52	-13.00	-12.25	-39.77	Peak
2	pp 2140.50	-24.11	-14.54	-13.00	-9.57	-11.11	Peak

Channel Bandwidth: 10 MHz / QPSK
Low Channel

Bureau Veritas Consumer Products Services Ltd., Taoyuan



A D T

Data: 3

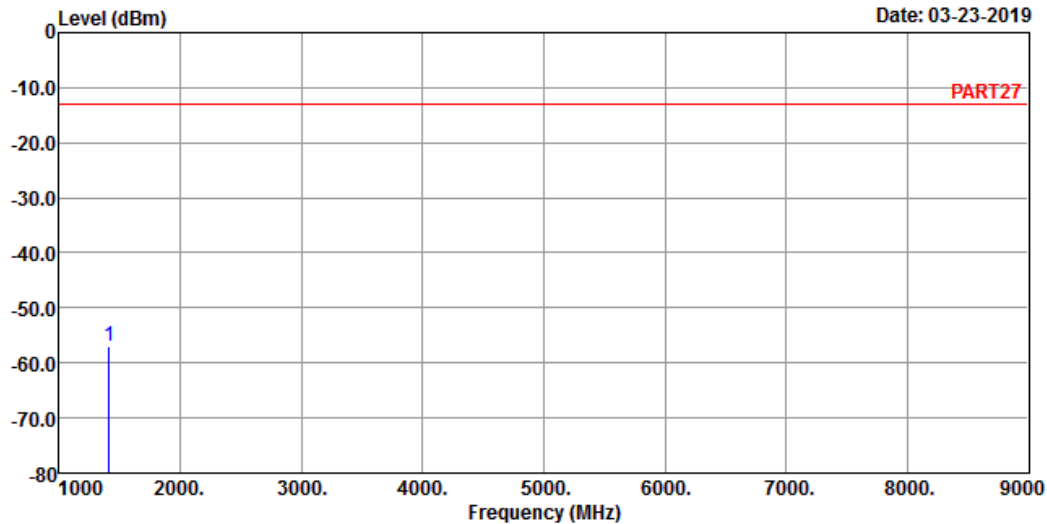

Site : 966 Chamber 5
Condition: PART27 HORIZONTAL
Remak : Cat-M1 Band 12 QPSK_10M Link_L-CH
Tested by: Thomas Wei

Freq	Level	Read Level	Limit	Line Factor	Over Limit	Remark
MHz	dBm	dBm	dBm	dB	dB	

1 pp 1408.00 -57.01 -45.05 -13.00 -11.96 -44.01 Peak

Bureau Veritas Consumer Products Services Ltd., Taoyuan



A D T

Data: 4

Date: 03-23-2019

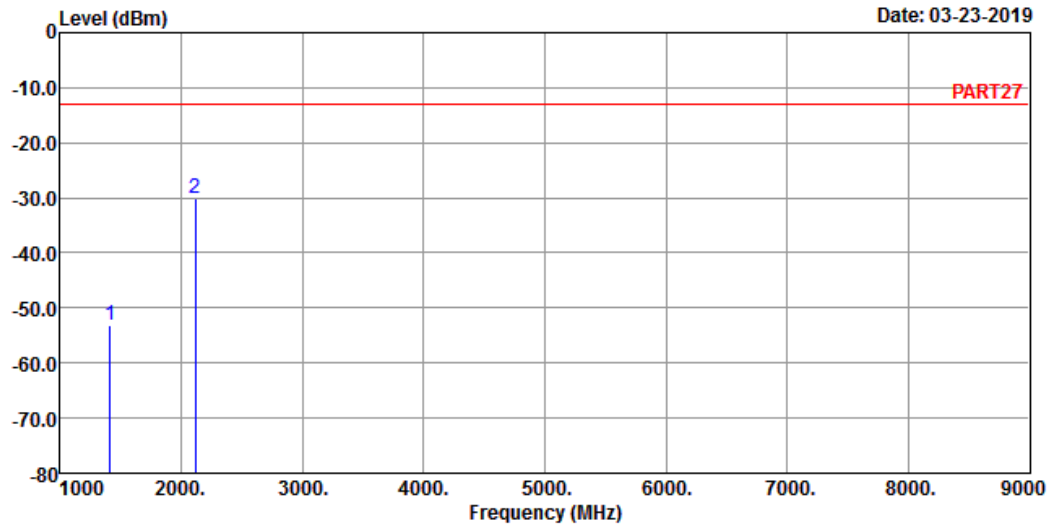

Site : 966 Chamber 5
 Condition: PART27 VERTICAL
 Remak : Cat-M1 Band 12 QPSK_10M Link_L-CH
 Tested by: Thomas Wei

	Freq	Level	Read Level	Limit	Line Factor	Over Limit	Remark
	MHz	dBm	dBm	dBm	dB	dB	
1	1408.00	-53.25	-41.29	-13.00	-11.96	-40.25	Peak
2	2112.00	-30.11	-20.15	-13.00	-9.96	-17.11	Peak

Middle Channel

Bureau Veritas Consumer Products Services Ltd., Taoyuan



A D T

Data: 3

Date: 03-23-2019

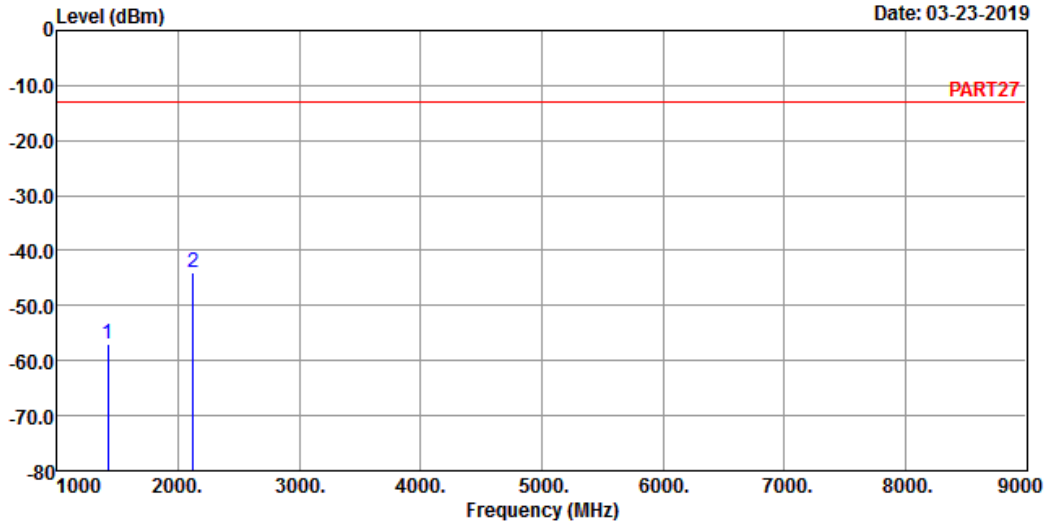

Site : 966 Chamber 5
 Condition: PART27 HORIZONTAL
 Remak : Cat-M1 Band 12 QPSK_10M Link_M-CH
 Tested by: Thomas Wei

	Freq	Level	Read Level	Limit	Line Factor	Over Limit	Remark
	MHz	dBm	dBm	dBm	dB	dB	
1	1415.00	-56.95	-44.87	-13.00	-12.08	-43.95	Peak
2 pp	2122.50	-44.10	-34.23	-13.00	-9.87	-31.10	Peak

Bureau Veritas Consumer Products Services Ltd., Taoyuan



A D T

Data: 4

Date: 03-23-2019

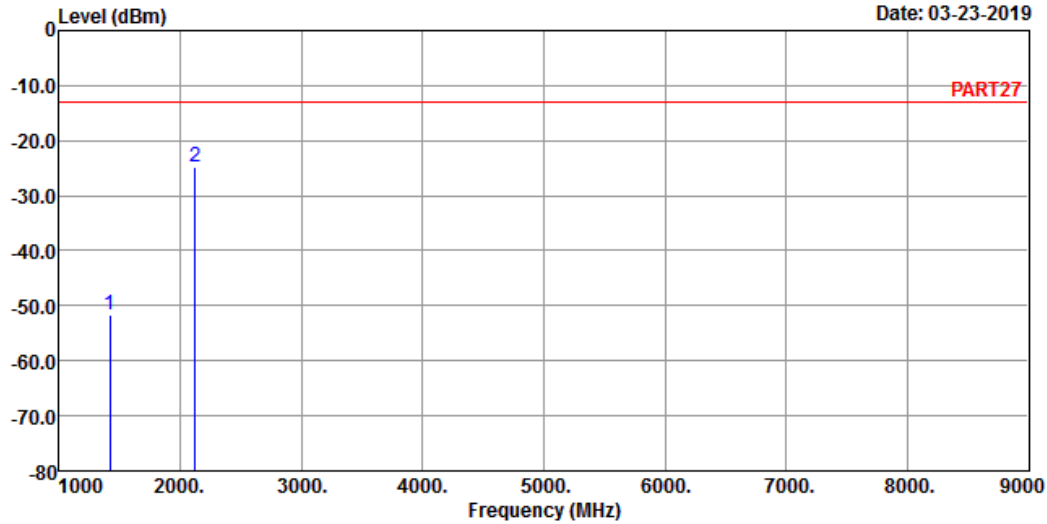

Site : 966 Chamber 5
 Condition: PART27 VERTICAL
 Remak : Cat-M1 Band 12 QPSK_10M Link_M-CH
 Tested by: Thomas Wei

	Freq	Level	Read Level	Limit	Line Factor	Over Limit	Remark
	MHz	dBm	dBm	dBm	dB	dB	
1	1415.00	-51.70	-39.62	-13.00	-12.08	-38.70	Peak
2	2122.50	-24.89	-15.02	-13.00	-9.87	-11.89	Peak

High Channel

Bureau Veritas Consumer Products Services Ltd., Taoyuan



A D T

Data: 5

Date: 03-23-2019

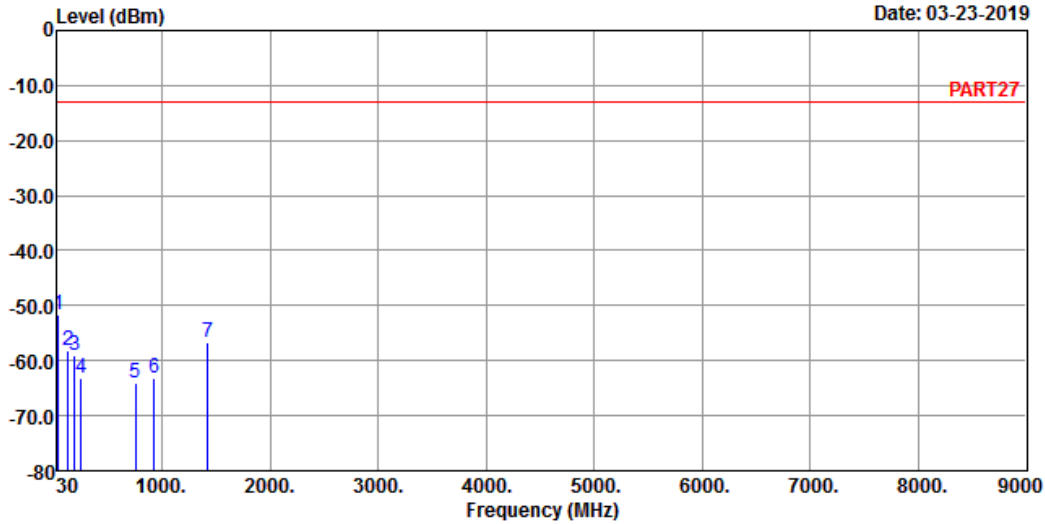

Site : 966 Chamber 5
 Condition: PART27 HORIZONTAL
 Remak : Cat-M1 Band 12 QPSK_10M Link_H-CH
 Tested by: Thomas Wei

	Read	Limit	Over			
Freq	Level	Level	Line	Factor	Limit	Remark
MHz	dBm	dBm	dBm	dB	dB	
1 pp	42.61	-51.68	-50.74	-13.00	-0.94	-38.68 Peak
2	128.94	-58.18	-49.37	-13.00	-8.81	-45.18 Peak
3	192.96	-58.90	-51.53	-13.00	-7.37	-45.90 Peak
4	248.25	-63.23	-57.16	-13.00	-6.07	-50.23 Peak
5	751.68	-63.97	-64.84	-13.00	0.87	-50.97 Peak
6	924.34	-63.16	-64.33	-13.00	1.17	-50.16 Peak
7	1422.00	-56.71	-44.52	-13.00	-12.19	-43.71 Peak

Bureau Veritas Consumer Products Services Ltd., Taoyuan



A D T

Data: 6

Date: 03-23-2019

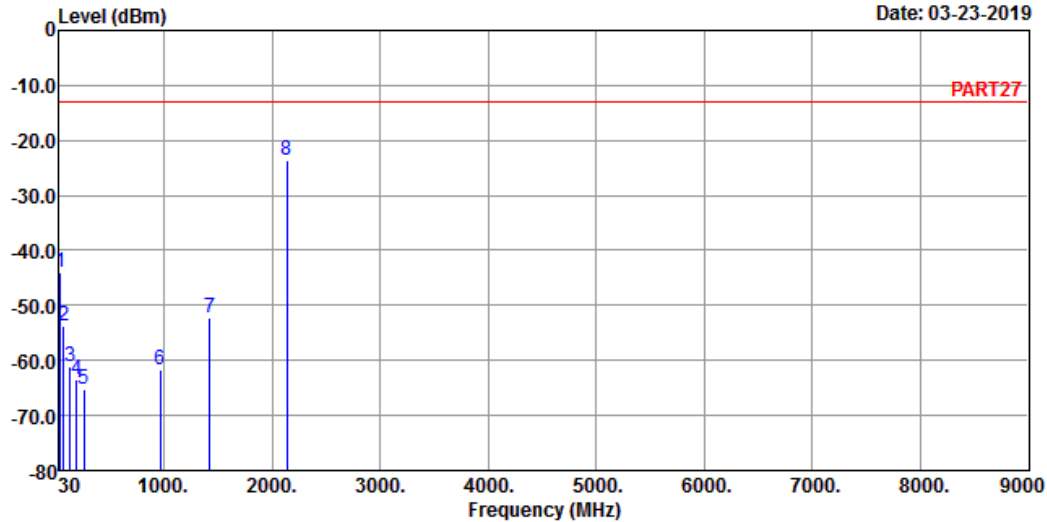

Site : 966 Chamber 5
 Condition: PART27 VERTICAL
 Remak : Cat-M1 Band 12 QPSK_10M Link_H-CH
 Tested by: Thomas Wei

	Freq	Level	Read Level	Limit	Line Factor	Over Limit	Remark
	MHz	dBm	dBm	dBm	dB	dB	
1	39.70	-43.88	-44.52	-13.00	0.64	-30.88	Peak
2	68.80	-53.74	-45.42	-13.00	-8.32	-40.74	Peak
3	128.94	-60.98	-52.17	-13.00	-8.81	-47.98	Peak
4	190.05	-63.59	-56.50	-13.00	-7.09	-50.59	Peak
5	256.98	-65.35	-59.22	-13.00	-6.13	-52.35	Peak
6	965.08	-61.56	-63.91	-13.00	2.35	-48.56	Peak
7	1422.00	-52.30	-40.11	-13.00	-12.19	-39.30	Peak
8 pp	2133.00	-23.56	-13.89	-13.00	-9.67	-10.56	Peak

LTE Band 13
Channel Bandwidth: 5 MHz / QPSK
Low Channel

Bureau Veritas Consumer Products Services Ltd., Taoyuan



A D T

Data: 3

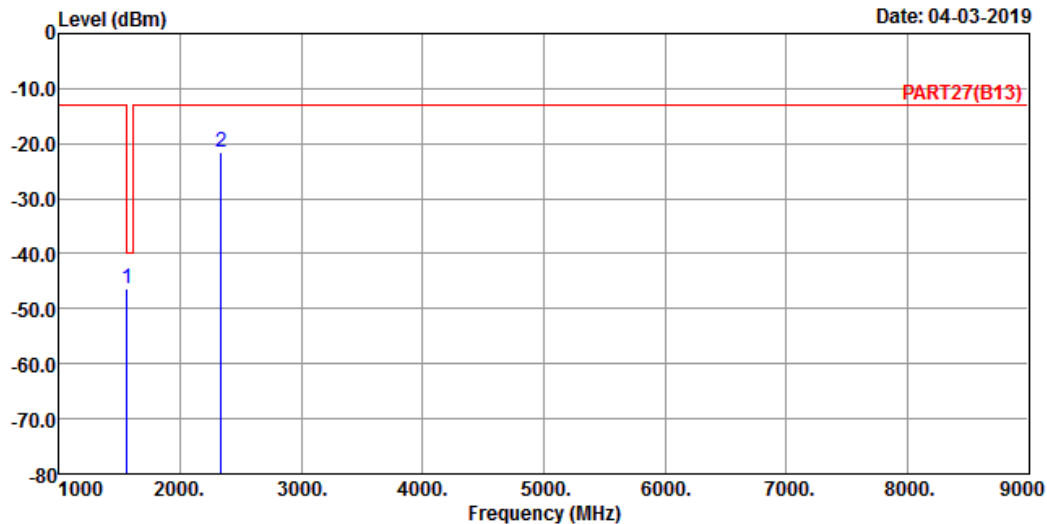

Site : 966 Chamber 5
Condition: PART27(B13) HORIZONTAL
Remak : Cat-M1 Band 13 QPSK_5M Link_L-CH
Tested by: Thomas Wei

	Freq	Level	Read Level	Limit	Line Factor	Over Limit	Remark
	MHz	dBm	dBm	dBm	dB	dB	
1	pp 1559.00	-46.29	-32.97	-40.00	-13.32	-6.29	RMS
2	pk 2338.50	-21.62	-12.24	-13.00	-9.38	-8.62	Peak



Data: 4

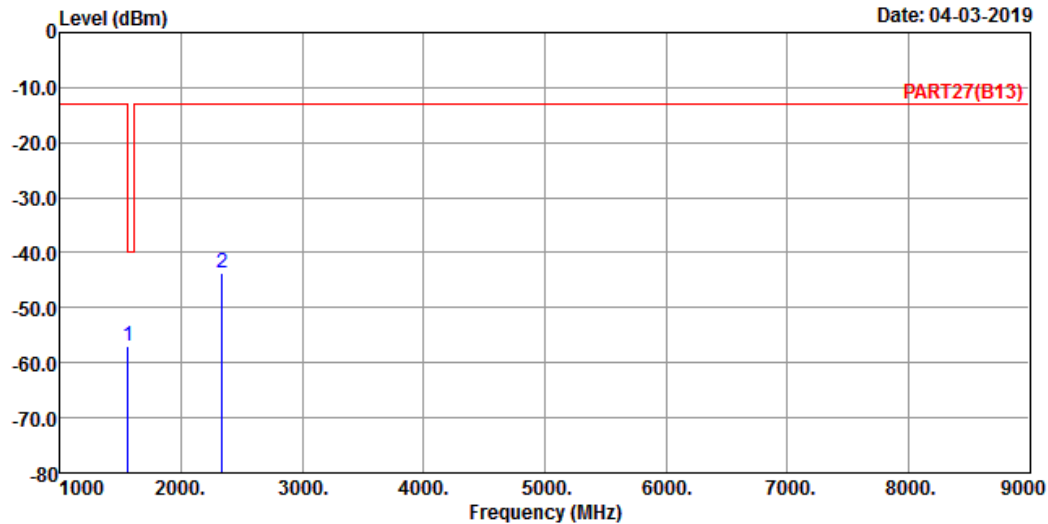

Site : 966 Chamber 5
 Condition: PART27(B13) VERTICAL
 Remak : Cat-M1 Band 13 QPSK_5M Link_L-CH
 Tested by: Thomas Wei

	Freq	Level	Read Level	Limit	Line Factor	Over Limit	Remark
	MHz	dBm	dBm	dBm	dB	dB	
1	pp 1559.00	-56.86	-43.54	-40.00	-13.32	-16.86	RMS
2	pk 2338.50	-43.60	-34.22	-13.00	-9.38	-30.60	Peak

Middle Channel

Bureau Veritas Consumer Products Services Ltd., Taoyuan



A D T

Data: 3

Date: 04-03-2019

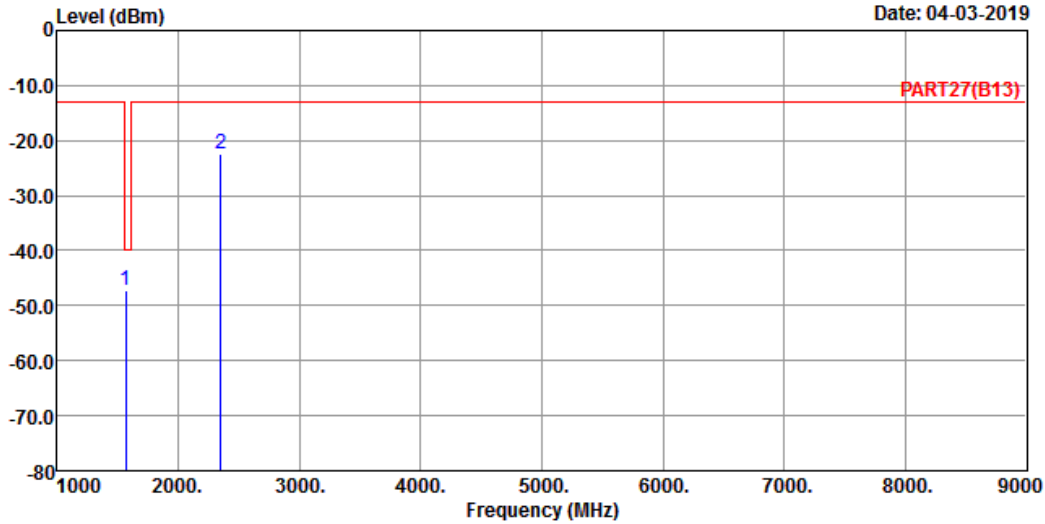

Site : 966 Chamber 5
 Condition: PART27(B13) HORIZONTAL
 Remak : Cat-M1 Band 13 QPSK_5M Link_M-CH
 Tested by: Thomas Wei

	Freq	Level	Read Level	Limit	Line Factor	Over Limit	Remark
	MHz	dBm	dBm	dBm	dB	dB	
1	pp 1564.00	-47.15	-33.81	-40.00	-13.34	-7.15	RMS
2	pk 2346.00	-22.29	-12.85	-13.00	-9.44	-9.29	Peak

Bureau Veritas Consumer Products Services Ltd., Taoyuan



A D T

Data: 4

Date: 04-03-2019

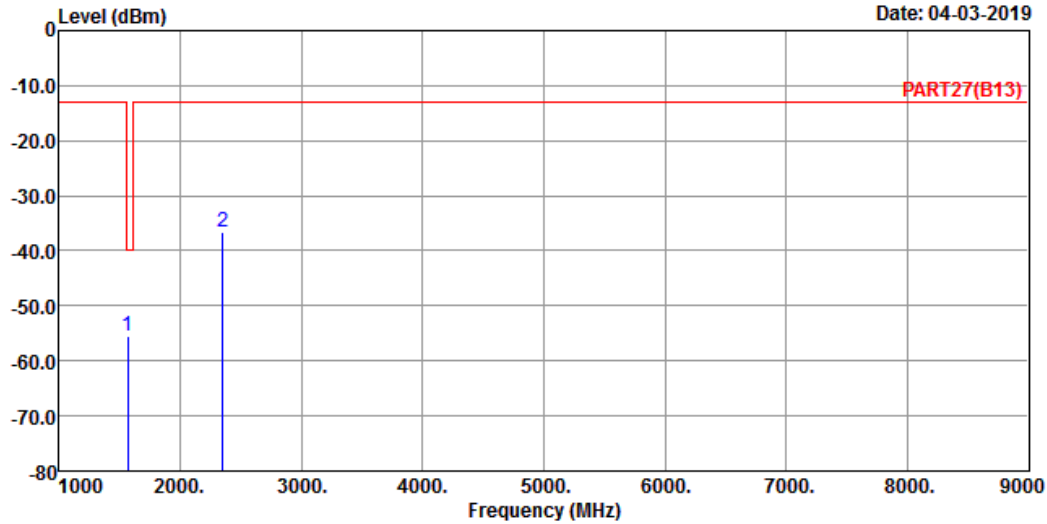

Site : 966 Chamber 5
 Condition: PART27(B13) VERTICAL
 Remak : Cat-M1 Band 13 QPSK_5M Link_M-CH
 Tested by: Thomas Wei

	Freq	Level	Read Level	Limit	Line Factor	Over Limit	Remark
	MHz	dBm	dBm	dBm	dB	dB	
1	pp 1564.00	-55.52	-42.18	-40.00	-13.34	-15.52	RMS
2	pk 2346.00	-36.73	-27.29	-13.00	-9.44	-23.73	Peak

High Channel

Bureau Veritas Consumer Products Services Ltd., Taoyuan



A D T

Data: 3

Date: 04-03-2019

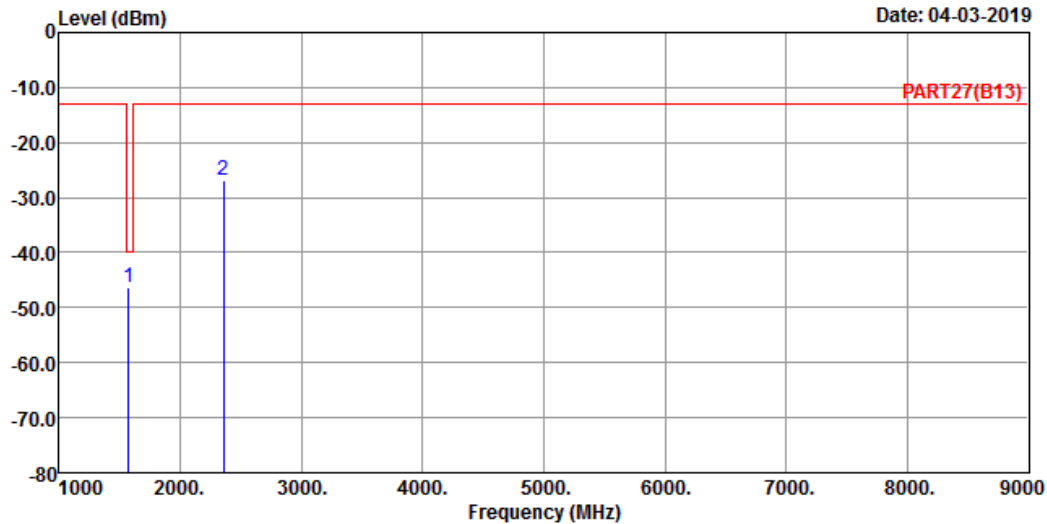

Site : 966 Chamber 5
 Condition: PART27(B13) HORIZONTAL
 Remak : Cat-M1 Band 13 QPSK_5M Link_H-CH
 Tested by: Thomas Wei

	Freq	Level	Read Level	Limit	Line Factor	Over Limit	Remark
	MHz	dBm	dBm	dBm	dB	dB	
1	pp 1569.00	-46.28	-32.93	-40.00	-13.35	-6.28	RMS
2	pk 2353.50	-26.97	-17.46	-13.00	-9.51	-13.97	Peak

Bureau Veritas Consumer Products Services Ltd., Taoyuan



A D T

Data: 4

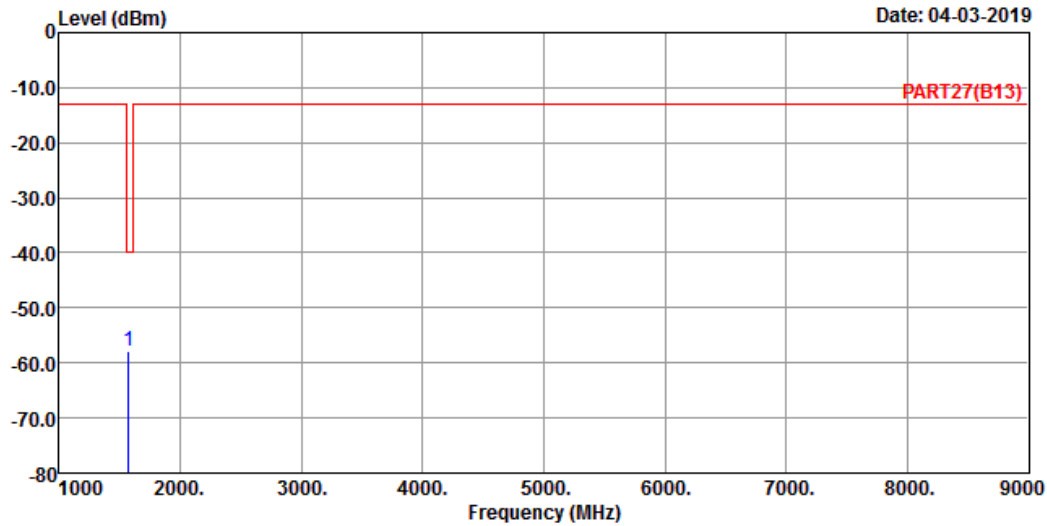

Site : 966 Chamber 5
 Condition: PART27(B13) VERTICAL
 Remak : Cat-M1 Band 13 QPSK_5M Link_H-CH
 Tested by: Thomas Wei

Freq	Level	Read Level	Limit	Line Factor	Over Limit	Remark
MHz	dBm	dBm	dBm	dB	dB	
1 pp 1569.00	-57.81	-44.46	-40.00	-13.35	-17.81	RMS

Channel Bandwidth: 10 MHz / QPSK

Bureau Veritas Consumer Products Services Ltd., Taoyuan



A D T

Data: 5

Date: 04-03-2019

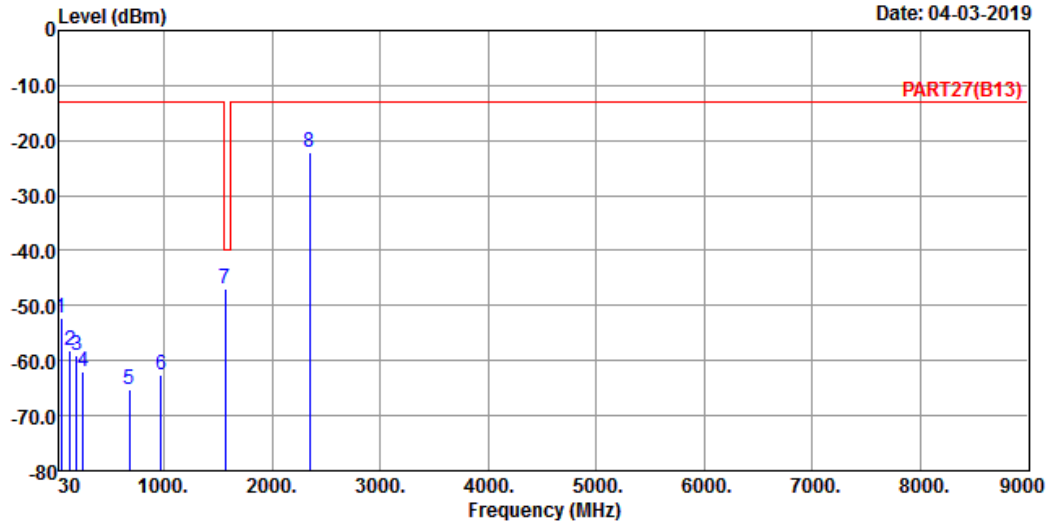

Site : 966 Chamber 5
 Condition: PART27(B13) HORIZONTAL
 Remak : Cat-M1 Band 13 QPSK_10M Link_M-CH
 Tested by: Thomas Wei

	Freq	Level	Read Level	Limit	Line Factor	Over Limit	Remark
	MHz	dBm	dBm	dBm	dB	dB	
1	44.55	-52.25	-50.26	-13.00	-1.99	-39.25	Peak
2	127.97	-58.07	-49.15	-13.00	-8.92	-45.07	Peak
3	189.08	-59.06	-51.94	-13.00	-7.12	-46.06	Peak
4	253.10	-62.09	-56.04	-13.00	-6.05	-49.09	Peak
5	680.87	-65.19	-64.79	-13.00	-0.40	-52.19	Peak
6	972.84	-62.46	-65.08	-13.00	2.62	-49.46	Peak
7 pp	1564.00	-47.06	-33.72	-40.00	-13.34	-7.06	RMS
8 pk	2346.00	-22.02	-12.58	-13.00	-9.44	-9.02	Peak

Bureau Veritas Consumer Products Services Ltd., Taoyuan



A D T

Data: 6

Date: 04-03-2019

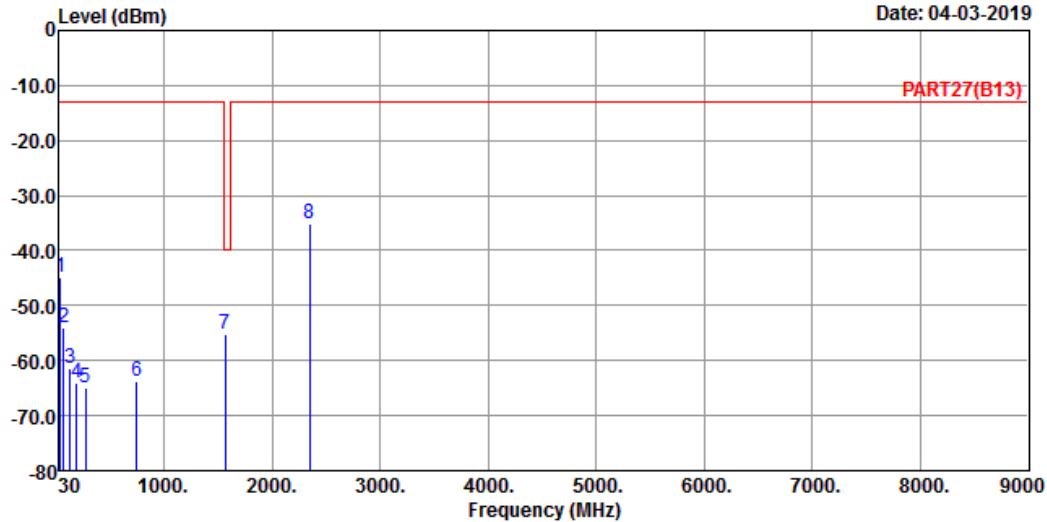

Site : 966 Chamber 5
 Condition: PART27(B13) VERTICAL
 Remak : Cat-M1 Band 13 QPSK_10M Link_M-CH
 Tested by: Thomas Wei

	Freq	Level	Read Level	Limit	Line Factor	Over Limit	Remark
	MHz	dBm	dBm	dBm	dB	dB	
1	39.70	-44.82	-45.46	-13.00	0.64	-31.82	Peak
2	68.80	-54.07	-45.75	-13.00	-8.32	-41.07	Peak
3	128.94	-61.32	-52.51	-13.00	-8.81	-48.32	Peak
4	188.11	-64.10	-56.95	-13.00	-7.15	-51.10	Peak
5	269.59	-64.96	-58.57	-13.00	-6.39	-51.96	Peak
6	749.74	-63.84	-64.72	-13.00	0.88	-50.84	Peak
7 pp	1564.00	-55.21	-41.87	-40.00	-13.34	-15.21	RMS
8 pk	2346.00	-35.17	-25.73	-13.00	-9.44	-22.17	Peak

5 Pictures of Test Arrangements

Please refer to the attached file (Test Setup Photo).

Appendix – Information of the Testing Laboratories

We, Bureau Veritas Consumer Products Services (H.K.) Ltd., Taoyuan Branch, were founded in 1988 to provide our best service in EMC, Radio, Telecom and Safety consultation. Our laboratories are FCC recognized accredited test firms and accredited according to ISO/IEC 17025.

If you have any comments, please feel free to contact us at the following:

Lin Kou EMC/RF Lab

Tel: 886-2-26052180

Fax: 886-2-26051924

Hsin Chu EMC/RF/Telecom Lab

Tel: 886-3-6668565

Fax: 886-3-6668323

Hwa Ya EMC/RF/Safety

Tel: 886-3-3183232

Fax: 886-3-3270892

Email: service.adt@tw.bureauveritas.com

Web Site: www.bureauveritas-adt.com

The address and road map of all our labs can be found in our web site also.

--- END ---