

ISED CABid: ES1909

Test report No:
 NIE: 71605RRF.002A2

Test Report

Reference Standard:
 USA FCC Part 24
 CANADA IC RSS-133

(*) Identification of item tested	LTE NB-IoT Cellular communication module
(*) Trademark	Sequans Communications
(*) Model and /or type reference	GM02S
Other identification of the product	FCC ID: 2AAGMGM02SA IC: 12732A-GM02SA IMEI TAC: 01577000
(*) Features	LTE-M, NB-IoT (NB1/NB2) Release 14 3GPP HW version: V2 SW version: LR8.1.0.0-55629
Manufacturer	Sequans Communications 55 Boulevard Charles de Gaulle, 92700 Colombes, France
Test method requested, standard	USA FCC Part 24 (10-1-20 Edition). Personal Communications Services. CANADA RSS-133 Issue 6, Amendment 1, Jan. 2018. ANSI C63.26: 2015. KDB 971168 D01 Power Meas License Digital Systems v03r01, April 2018.
Summary	IN COMPLIANCE
Approved by (name / position & signature)	Rafael López EMC Consumer & RF Lab. Manager  2022.08.11 13:03:49 +02'00'
Date of issue	2022-08-03
Report template No.	FDT08_24 (*) "Data provided by the client"

Index

Competences and guarantees	3
General conditions	3
Uncertainty	3
Data provided by the client.....	4
Usage of samples	4
Test sample description	5
Identification of the client.....	6
Testing period and place	6
Document history	6
Environmental conditions	6
Remarks and comments	7
Testing verdicts.....	8
Summary	8
Appendix A: Test results for FCC Part 24 / RSS-133	9

Competences and guarantees

DEKRA Testing and Certification is a testing laboratory accredited by the National Accreditation Body (ENAC - Entidad Nacional de Acreditación) to perform the tests indicated in the Certificate No. 51/LE 147.

DEKRA Testing and Certification S.A.U. is an FCC-recognized accredited testing laboratory with the appropriate scope of accreditation that covers the performed tests in this report.

DEKRA Testing and Certification S.A.U. is an ISED-recognized accredited testing laboratory, CABid: ES1909, with the appropriate scope of accreditation that covers the performed tests in this report.

In order to assure the traceability to other national and international laboratories, DEKRA Testing and Certification S.A.U. has a calibration and maintenance program for its measurement equipment.

DEKRA Testing and Certification S.A.U. guarantees the reliability of the data presented in this report, which is the result of the measurements and the tests performed to the item under test on the date and under the conditions stated on the report and it is based on the knowledge and technical facilities available at DEKRA Testing and Certification S.A.U. at the time of performance of the test.

DEKRA Testing and Certification S.A.U. is liable to the client for the maintenance of the confidentiality of all information related to the item under test and the results of the test.

The results presented in this Test Report apply only to the particular item under test established in this document.

IMPORTANT: No parts of this report may be reproduced or quoted out of context, in any form or by any means, except in full, without the previous written permission of DEKRA Testing and Certification S.A.U.

General conditions

1. This report is only referred to the item that has undergone the test.
2. This report does not constitute or imply on its own an approval of the product by the Certification Bodies or competent Authorities.
3. This document is only valid if complete; no partial reproduction can be made without previous written permission of DEKRA Testing and Certification S.A.U.
4. This test report cannot be used partially or in full for publicity and/or promotional purposes without previous written permission of DEKRA Testing and Certification S.A.U. and the Accreditation Bodies.

Uncertainty

Uncertainty (factor $k=2$) was calculated according to the DEKRA Testing and Certification S.A.U. internal document PODT000.

The total uncertainty of the measurement system for the radiated emissions of EUT from 30 MHz to 1 GHz is:
Measurement uncertainty $\leq \pm 5.35$ dB (with factor $k = 2$).

The total uncertainty of the measurement system for the radiated emissions of EUT from 1 GHz to 18 GHz is:
Measurement uncertainty $\leq \pm 4.32$ dB (with factor $k = 2$).

The total uncertainty of the measurement system for the radiated emissions of EUT from 18 GHz to 26 GHz is:
Measurement uncertainty $\leq \pm 5.51$ dB (with factor $k = 2$).

The total uncertainty of the measurement system for the conducted testing of EUT is:

RF Average Output Power: Measurement uncertainty $\leq \pm 0.941$ dB

Frequency Stability: Measurement uncertainty $\leq \pm 249.55$ Hz

Occupied Bandwidth: Measurement uncertainty $\leq \pm 0.81$ kHz

26dB Bandwidth: Measurement uncertainty $\leq \pm 0.81$ kHz

Spurious Emissions at Antenna Terminals: Measurement uncertainty $\leq \pm 2.76$

Spurious Emissions at Antenna Terminals at Block Edges: Measurement uncertainty $\leq \pm 2.76$ dB

Data provided by the client

The following data has been provided by the client:

1. Information relating to the description of the sample ("Identification of the item tested", "Trademark", "Model and/or type reference tested").
2. The sample of the model GM02S is a multi-band module supporting cellular LTE-M Release 14. It supports HD-FDD.

DEKRA Testing and Certification S.A.U. declines any responsibility with respect to the information provided by the client and that may affect the validity of results.

Usage of samples

Samples undergoing test have been selected by: the client.

Id	Control Number	Description	Model	Serial No.	Date of Reception	Application
S/01	71605_13.1	LTE Cat-M Cellular communication module	GM02S	G2Q2106160105039	2022-04-04	Element Under Test
S/01	71605_16.1	External Antenna	OmniLOG 90200	--	2022-04-04	Element Under Test
S/01	71605_13.1	NEKTAR-EVK Evaluation Kit	HWPT011B5	58K2131000152	2022-04-04	Auxiliary Element
S/01	71605_14.1	UFL to SMA Cable	--	--	2022-04-04	Auxiliary Element
S/01	71605_15.1	USB Cable	--	--	2022-04-04	Auxiliary Element
S/02	71605_13.1	LTE Cat-M Cellular communication module	GM02S	G2Q2106160105039	2022-04-04	Element Under Test
S/02	71605_13.1	NEKTAR-EVK Evaluation Kit	HWPT011B5	58K2131000152	2022-04-04	Auxiliary Element
S/02	71605_14.1	UFL to SMA Cable	--	--	2022-04-04	Auxiliary Element
S/02	71605_15.1	USB Cable	--	--	2022-04-04	Auxiliary Element

Samples were used for the following test(s):

Id	Type / Comments
S/01	Radiated. / RF output: pin J1.
S/02	Conducted. / RF output: pin J1.

Test sample description

Ports.....:	Port name and description	Cable					
		Specified max length [m]	Attached during test	Shielded	Coupled to patient ⁽³⁾		
	USB	2	<input checked="" type="checkbox"/>	<input type="checkbox"/>	<input type="checkbox"/>		
			<input type="checkbox"/>	<input type="checkbox"/>	<input type="checkbox"/>		
Supplementary information to the ports.....:	--						
Rated power supply	Voltage and Frequency		Reference poles				
			L1	L2	L3	N	PE
	<input type="checkbox"/>	AC:	<input type="checkbox"/>	<input type="checkbox"/>	<input type="checkbox"/>	<input type="checkbox"/>	<input type="checkbox"/>
<input checked="" type="checkbox"/>	DC: 3.3 Vdc						
Rated Power	--						
Clock frequencies.....:	--						
Other parameters	--						
Software version	LR8.1.0.0-55629						
Hardware version	V2						
Dimensions in cm (W x H x D)	Not provided data						
Mounting position	<input checked="" type="checkbox"/>	Table top equipment					
	<input type="checkbox"/>	Wall/Ceiling mounted equipment					
	<input type="checkbox"/>	Floor standing equipment					
	<input type="checkbox"/>	Hand-held equipment					
	<input type="checkbox"/>	Other:					
Modules/parts.....:	Module/parts of test item		Type		Manufacturer		
	NEKTAR-EVK HWPT011B5		Eval Kit		Sequans		
	USB Cable						
	External antenna				Aaronia AG		
Accessories (not part of the test item)	Description		Type		Manufacturer		
	--						
Documents as provided by the applicant	Description		File name		Issue date		
	--						

(3) Only for Medical Equipment

Identification of the client

SEQUANS COMMUNICATIONS
55 Boulevard Charles de Gaulle, 92700 Colombes, France

Testing period and place

Test Location	DEKRA Testing and Certification S.A.U.
Date (start)	2022-04-08
Date (finish)	2022-05-05

Document history

Report number	Date	Description
71605RRF.002	2022-05-16	First release.
71605RRF.002A1	2022-06-01	Second release. Modification due to typos. This modification of test report cancels and replaces the test report 71605RRF.002.
71605RRF.002A2	2022-08-03	Third release. Inclusion of spectrum analyzer settings in Radiated Emissions section. This modification of test report cancels and replaces the test report 71605RRF.002A1.

Environmental conditions

In the control chamber, the following limits were not exceeded during the test:

Temperature	Min. = 15 °C Max. = 35 °C
Relative humidity	Min. = 20 % Max. = 75 %

In the semi-anechoic chamber, the following limits were not exceeded during the test.

Temperature	Min. = 15 °C Max. = 35 °C
Relative humidity	Min. = 20 % Max. = 75 %

In the chamber for conducted measurements, the following limits were not exceeded during the test:

Temperature	Min. = 15 °C Max. = 35 °C
Relative humidity	Min. = 20 % Max. = 75 %

Remarks and comments

The tests have been performed by the technical personnel: Alfonso Gutiérrez and Miguel Manuel López.

Used instrumentation:

Equipment	Model	Manufacturer	Next Calibration
SEMIANECHOIC ABSORBER LINED CHAMBER IV	FACT 3 200 STP	ETS LINDGREN	2024-06-07
SHIELDED ROOM	S101	ETS LINDGREN	N.A.
EMI TEST RECEIVER 9kHz-7GHz	ESR7	ROHDE AND SCHWARZ	2023-11-08
SIGNAL AND SPECTRUM ANALYZER 10Hz-40GHz	FSV40	ROHDE AND SCHWARZ	2023-10-22
HYBRID BILOG ANTENNA 30MHz-6GHz	3142E	ETS LINDGREN	2023-10-29
HORN ANTENNA 1-18GHz	BBHA 9120 D	SCHWARZBECK	2023-08-24
HORN ANTENNA 18-40GHz	BBHA 9170	SCHWARZBECK	2023-05-05
PRE-AMPLIFIER G>30dB 1GHz-18GHz	BLMA 0118-3A	BONN ELEKTRONIK	2022-12-01
PRE-AMPLIFIER G>30dB 17-40GHz	BLMA 1840-4A	BLMA 1840-4A	2022-09-08
WIDEBAND RADIO COMMUNICATION TESTER	CMW500	ROHDE AND SCHWARZ	2022-06-04
EMC/RF MEASUREMENT SOFTWARE	EMC32	ROHDE AND SCHWARZ	N.A.
SIGNAL AND SPECTRUM ANALYZER 10Hz-40GHz	FSV40	ROHDE AND SCHWARZ	2023-02-26
SIGNAL ANALYZER 20Hz-8GHz	FSQ8	ROHDE AND SCHWARZ	2022-10-06
TEMPERATURE CHAMBER	MK 56	BINDER	2023-03-22
DC POWER SUPPLY 40 V / 40 A	NGPE 40/40	ROHDE AND SCHWARZ	N.A.
DIGITAL MULTIMETER	179	FLUKE	2022-10-19

Testing verdicts

Not applicable:	N/A
Pass:	P
Fail:	F
Not measured:	N/M

Summary

FCC PART 24 / RSS-133		
Requirement – Test case	Verdict	Remark
FCC 24.232 / RSS-133 6.4: RF Output Power	P	
FCC 2.1047 / RSS-133 6.2: Modulation Characteristics	P	
FCC 24.235 / RSS-133 6.3: Frequency Stability	P	
FCC 2.1049: Occupied Bandwidth	P	
FCC 24.238 / RSS-133 6.5: Spurious Emissions at Antenna Terminals	P	
FCC 24.238 / RSS-133 6.5: Radiated Emissions	P	
<u>Supplementary information and remarks:</u>		
None.		

Appendix A: Test results for FCC Part 24 / RSS-133

INDEX

TEST CONDITIONS	11
RF Output Power	12
Frequency Stability	16
Modulation Characteristics	21
Occupied Bandwidth	23
Spurious Emissions at Antenna Terminals	32
Spurious Emissions at Antenna Terminals at Block Edges	36
Radiated Emissions	41

TEST CONDITIONS

(*): Data provided by the client.

Power supply (V):

$$V_n = 3.3 \text{ Vdc (*)}$$

$$V_{\min} = 2.805 \text{ Vdc}$$

$$V_{\max} = 3.795 \text{ Vdc}$$

The subscripts n, min and max indicate voltage test conditions: nominal, minimum and maximum respectively.

Type of power supply: USB powered or DC Voltage from external power supply.

ANTENNA (*):

Device with external and internal antennas.

After a preliminary scan, the determined worst case for the Radiated tests is the external antenna.

For the Conducted tests, the gain of the internal antenna is used.

Declared Gain for antennas:

Middle bands	Gain (dBi)	Antenna type
LTE Bands 2 & 25	+2.4	Internal
	+2.1	External

TEST FREQUENCIES:

NB-IoT. $\pi/2$ - BPSK and $\pi/4$ - QPSK modulations (BAND 2)

Channel (Frequency, MHz)		
Low	Middle	High
18602 (1850.2)	18900 (1880)	19188 (1909.8)

NB-IoT. $\pi/2$ - BPSK and $\pi/4$ - QPSK modulations (BAND 25)

Channel (Frequency, MHz)		
Low	Middle	High
26042 (1850.2)	26365 (1882.5)	26688 (1914.8)

NOTE: Band 2 is completely included in band 25, so the channels of band 25 were tested to give conformity to the assigned block.

RF Output Power

Limits

FCC §2.1046 and §24.232:

Mobile and portable stations are limited to 2 watts (33 dBm) Effective Isotropic Radiated Power (E.I.R.P.).
The peak-to-average ratio (PAR) of the transmission shall not exceed 13 dB.

RSS-133. Clause 6.4:

The peak-to-average power ratio (PAPR) shall not exceed 13 dB for more than 0.1% of the time using a signal corresponding to the highest PAPR during periods of continuous transmission.

Method

The conducted RF output power measurements were made at the RF output terminals of the EUT using the power meter of the Universal Radio Communication tester R&S CMW500, selecting maximum transmission power of the EUT and different modes of modulation.

The maximum equivalent isotropically radiated power (e.i.r.p.) is calculated by adding the maximum declared antenna gain (dBi).

The maximum effective radiated power e.r.p. is calculated from the maximum equivalent isotropically radiated power (e.i.r.p.) by subtracting 2.15 dB:

$$E.R.P. = E.I.R.P. - 2.15 \text{ dB}$$

The peak-to-average power ratio (PAPR) is measured using an attenuator, power splitter and spectrum analyser with a Complementary Cumulative Distribution Function implemented.

The EUT was controlled via the Universal Radio Communication tester R&S CMW500 selecting maximum transmission power of the EUT and different modes of modulation.

Test setup

Conducted Average Power:



Peak-to-Average Power Ratio (PAPR):

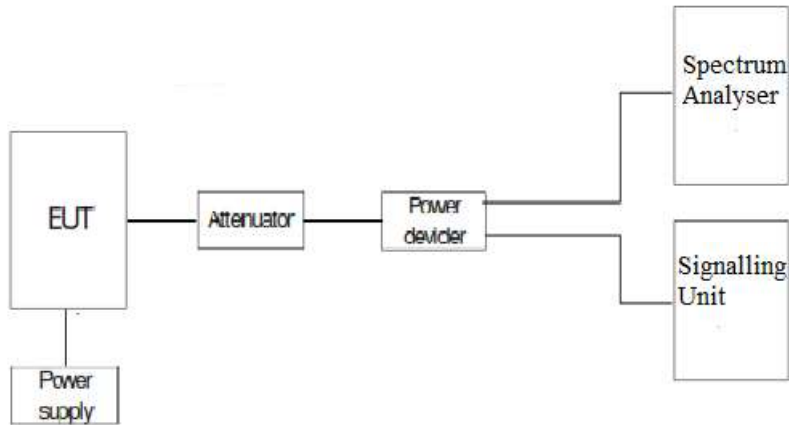

Results

NBLoT Band 25:

Channel	Freq. (MHz)	Modulation	BW (kHz)	No. of tones	Offset Tone	Average Power (dBm)	PAPR (dB)	
26042	1850.2	$\pi/2$ - BPSK	3.75	1	0	21.98	(*)	
				1	47	22.01	(*)	
			15	1	0	22.25	(*)	
				1	11	22.27	(*)	
			$\pi/4$ - QPSK	3.75	1	0	22.04	(*)
					1	47	22.05	(*)
		15		1	0	22.50	(*)	
				1	11	22.70	(*)	
				3	0	22.64	5.38	
				3	6	22.65	5.31	
				6	0	22.66	4.18	
				6	6	22.63	4.28	
		12	0	22.59	4.25			
		26365	1882.5	$\pi/2$ - BPSK	3.75	1	0	21.98
1	47					21.99	(*)	
15	1				0	22.25	(*)	
	1				11	22.22	(*)	
$\pi/4$ - QPSK	3.75			1	0	21.97	(*)	
				1	47	21.97	(*)	
	15			1	0	22.25	(*)	
				1	11	22.24	(*)	
				3	0	22.44	5.32	
				3	6	22.62	5.17	
				6	0	22.44	3.87	
				6	6	22.39	3.95	
12	0			22.48	4.25			
26688	1914.8			$\pi/2$ - BPSK	3.75	1	0	22.13
		1	47			22.12	(*)	
		15	1		0	22.41	(*)	
			1		11	22.39	(*)	
		$\pi/4$ - QPSK	3.75	1	0	22.15	(*)	
				1	47	22.16	(*)	
			15	1	0	22.38	(*)	
				1	11	22.40	(*)	
				3	0	22.53	5.08	
				3	6	22.75	5.03	
				6	0	22.52	3.88	
				6	6	22.51	3.90	
		12	0	22.59	3.92			

(*) Preliminary measurements determined QPSK modulation, 3, 6 or 12 tones with 15kHz BW as the worst cases.

Channel	Measured maximum average power at antenna port (dBm)	Maximum declared antenna gain (dBi)	Maximum equivalent isotropically radiated power E.I.R.P. (dBm)	Maximum effective radiated power E.R.P. (dBm)	Maximum PAPR (dB)
Low	22.70	2.40	25.10	22.95	5.38
Middle	22.62	2.40	25.02	22.87	5.32
High	22.75	2.40	25.15	23.00	5.08

Verdict

Pass

Attachments

Peak-to-Average Power Ratio (PAPR)

NBLoT Band 25.

Preliminary measurements determined QPSK modulation, 3 tones with 15kHz BW, Offset Tone = 0 as the worst case. Next plots show the results for this worst-case configuration.

- Low Channel:

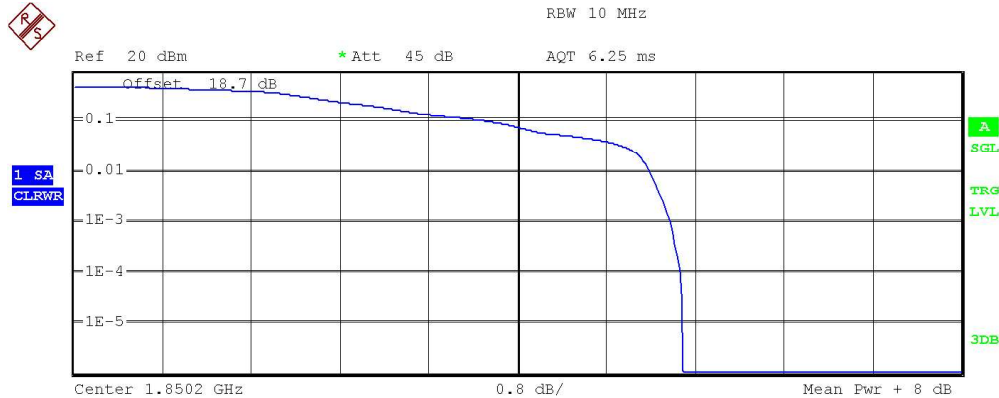

Complementary Cumulative Distribution Function
 NOF samples: 100000, Usable BW: 11.2MHz

Trace 1	
Mean	20.37 dBm
Peak	25.85 dBm
Crest	5.49 dB
10 %	3.74 dB
1 %	5.19 dB
.1 %	5.38 dB
.01 %	5.47 dB

- Middle Channel:

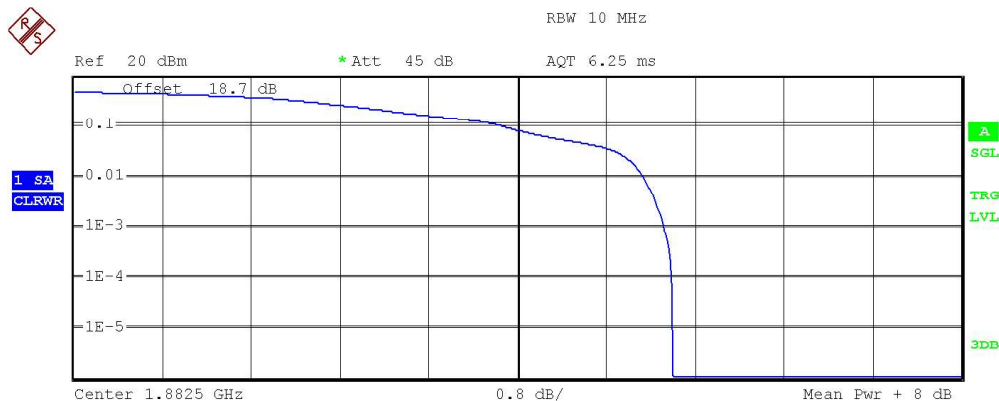

Complementary Cumulative Distribution Function
 NOF samples: 100000, Usable BW: 11.2MHz

Trace 1	
Mean	20.24 dBm
Peak	25.64 dBm
Crest	5.40 dB
10 %	3.87 dB
1 %	5.13 dB
.1 %	5.32 dB
.01 %	5.40 dB

- High Channel:

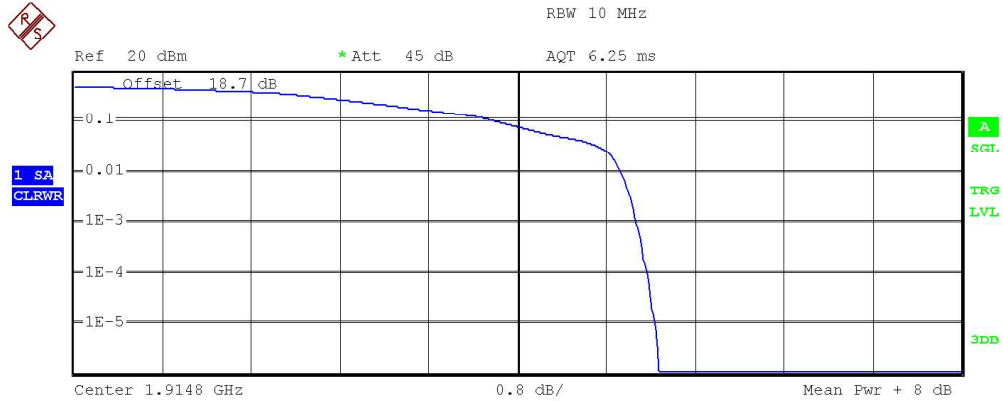

Complementary Cumulative Distribution Function
 NOF samples: 100000, Usable BW: 11.2MHz

Trace 1	
Mean	20.28 dBm
Peak	25.55 dBm
Crest	5.27 dB
10 %	3.82 dB
1 %	4.94 dB
.1 %	5.08 dB
.01 %	5.18 dB

Frequency Stability

Limits

FCC §2.1055 and §24.235. The frequency stability shall be sufficient to ensure that the fundamental emission stays within the authorized frequency block.

RSS-133, Clause 6.3. The carrier frequency shall not depart from the reference frequency in excess of ± 2.5 ppm for mobile stations.

Method

The frequency tolerance measurements over temperature variations were made over the temperature range of -30°C to $+50^{\circ}\text{C}$. The EUT was placed inside a climatic chamber and the temperature was raised hourly in 10°C steps from -30°C up to $+50^{\circ}\text{C}$.

The supply voltage was varied between 85% and 115% of nominal voltage.

The EUT was set on the middle channel using the Universal Radio Communication tester R&S CMW500 and the maximum frequency error was measured using the built-in calibrated frequency meter.

The worst-case NB-IoT mode for conducted power was used for the test.

In order to check that the frequency stability is sufficient such that the fundamental emissions stay within the authorized bands of operation, a reference point is established at the applicable unwanted emissions limit using a RBW equal to the RBW required by the unwanted emissions specification of the applicable regulatory standard. These reference points measured using the lowest and highest channels of operation are identified as fL and fH respectively. The worst-case frequency offset determined in the above methods is added or subtracted from the values of fL and fH to check that the resulting frequencies remain within the band.

The reference point measurements were made at the RF output terminals of the EUT using an attenuator, power splitter and spectrum analyser. The EUT was controlled via the Universal Radio Communication tester R&S CMW500 selecting maximum transmission power of the EUT and different modes of modulation.

Test setup

Frequency tolerance:

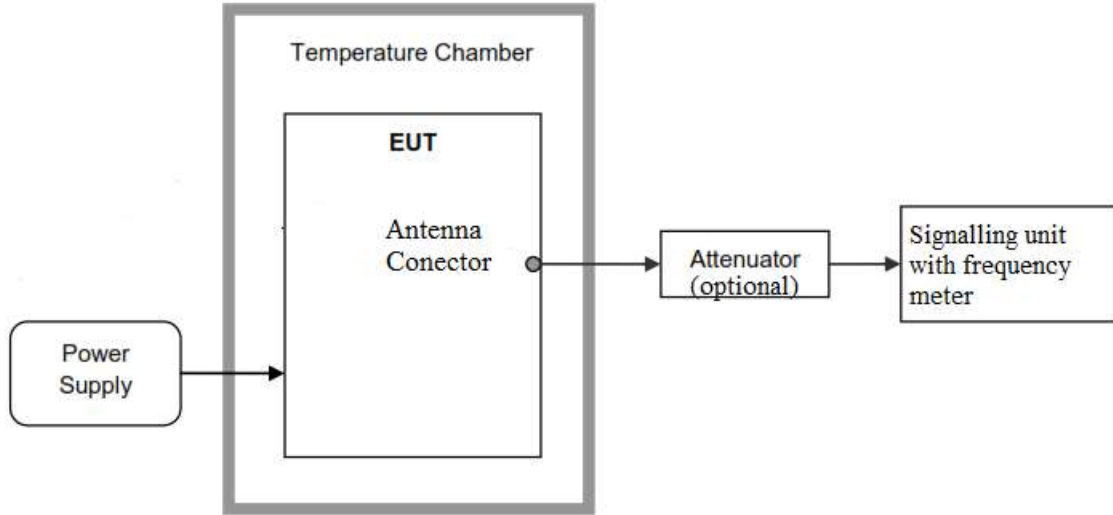

Reference points f_L and f_H :

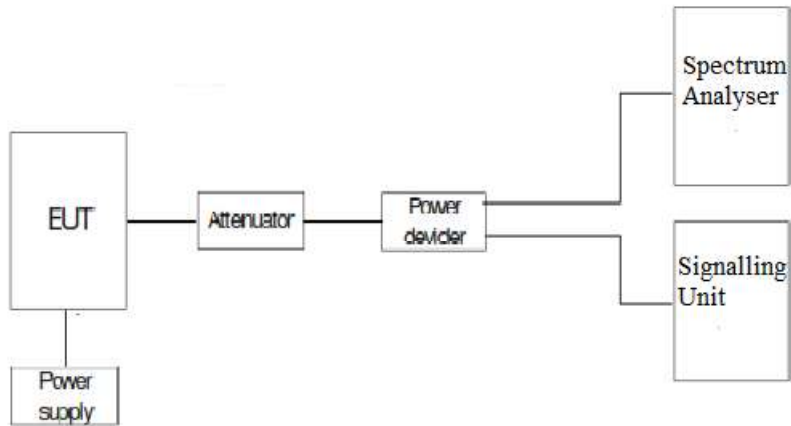

Results

NBLoT Band 25. $\pi/4$ - QPSK modulation. 3 tones 15 kHz, Offset Tone = 6. Channel: 1882.5 MHz.

1. FREQUENCY TOLERANCE

- Frequency stability over temperature variations.

Temperature (°C)	Frequency Error (Hz)	Frequency Error (ppm)
+50	-2.96	-0.001572377
+40	2.89	0.001535193
+30	0.97	0.000515272
+20	4.85	0.002576361
+10	1.57	0.000833997
0	-3.92	-0.002082337
-10	-6.19	-0.003288181
-20	-8.73	-0.00463745
-30	-6.87	-0.003649402

- Frequency stability over voltage variations.

Battery Supply voltage	Voltage (V)	Frequency Error (Hz)	Frequency Error (ppm)
Vmax	3.795	0.76	0.000403718
Vmin	2.805	3.44	0.001827357

2. REFERENCE FREQUENCY POINTS f_L AND f_H

Points established at the applicable unwanted emissions limit (worst case):

f_L (MHz)	1850.061090
f_H (MHz)	1914.979380

The reference frequency points f_L and f_H stay within the authorized blocks.

Verdict

Pass

Modulation Characteristics

Limits

FCC §2.1047.

RSS-133. Clause 6.2. Equipment certified under this standard shall use digital modulation.

Method

For NB-IoT the EUT operates with $\pi/2$ - BPSK and $\pi/4$ - QPSK modulation modes in which the information is digitised and coded into a bit stream. The RF transmission is multiplexed using *Orthogonal Frequency Division Multiplexing (OFDM)* with different possible arrangement of subcarriers.

The EUT was set on the middle channel of each band using the Universal Radio Communication tester R&S CMW500 and the modulation scheme is displayed on the spectrum analyser.

Test setup

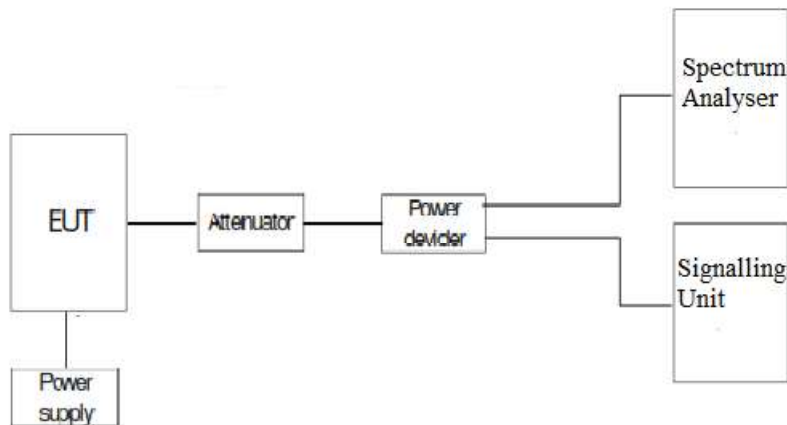

Results

The following plots show the modulation schemes in the EUT.

NB-IoT Band 25:

Modulation: $\pi/2$ – BPSK

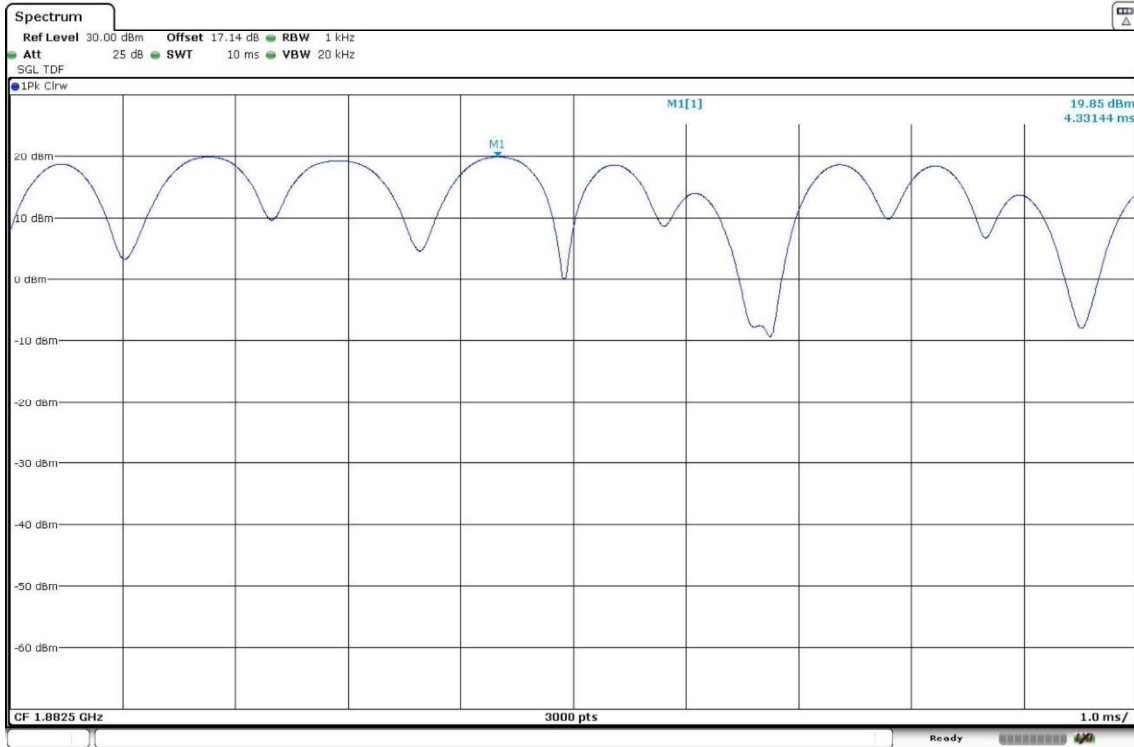

Modulation: $\pi/4$ - QPSK

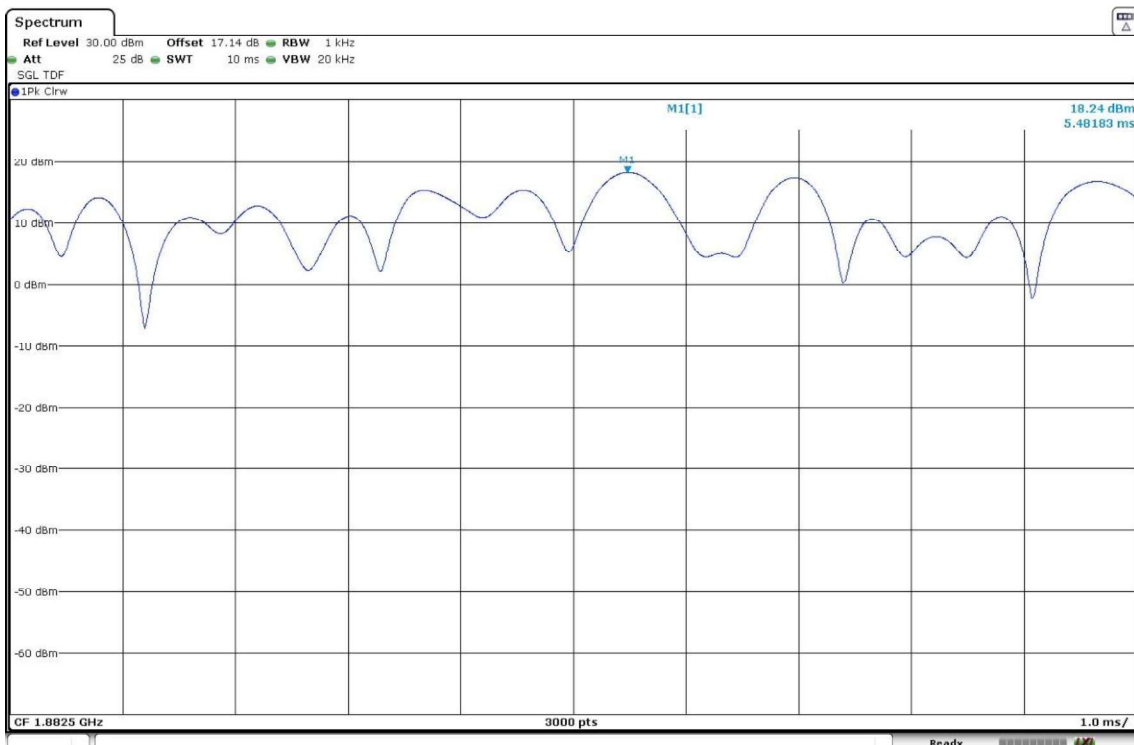

Occupied Bandwidth

Limits

FCC §2.1049. Measurements required: Occupied bandwidth.

Method

The occupied bandwidth measurement was performed at the output terminals of the EUT using an attenuator, power splitter and spectrum analyser. The EUT was controlled via the Universal Radio Communication tester R&S CMW500 selecting maximum transmission power of the EUT and different modes of modulation. The 99% occupied bandwidth was measured directly using the built-in bandwidth measuring option of the spectrum analyser. The -26 dBc bandwidth was measured by setting a level line at 26 dB below the maximum measured carrier level.

Test setup

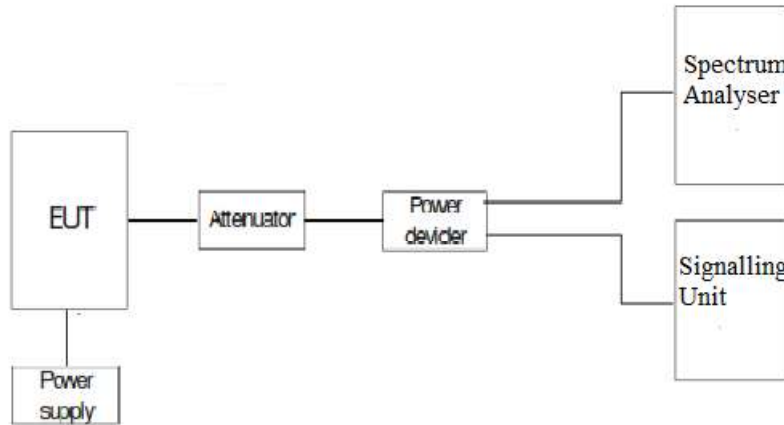

Results

NBIoT Band 25:

1 tone 3.75 kHz, $\pi/2$ - BPSK modulation.

Channel	99% Occupied Bandwidth (kHz)	-26 dBc Bandwidth (kHz)
Low	46.006667	38.078500
Middle	46.096667	36.869400
High	46.196667	35.053200

1 tone 3.75 kHz, $\pi/4$ - QPSK modulation.

Channel	99% Occupied Bandwidth (kHz)	-26 dBc Bandwidth (kHz)
Low	46.160000	41.368500
Middle	46.040000	41.298000
High	45.900000	41.163000

1 tone 15 kHz, $\pi/2$ - BPSK modulation.

Channel	99% Occupied Bandwidth (kHz)	-26 dBc Bandwidth (kHz)
Low	116.413333	131.538600
Middle	115.946667	133.779200
High	114.886667	131.442600

12 tones 15 kHz, $\pi/4$ - QPSK modulation.

Channel	99% Occupied Bandwidth (kHz)	-26 dBc Bandwidth (kHz)
Low	195.293333	308.798000
Middle	195.160000	292.161000
High	198.960000	311.438000

Attachments

NB IoT Band 25.

1 tone 3.75 kHz, $\pi/2$ - BPSK modulation.

- Low Channel:

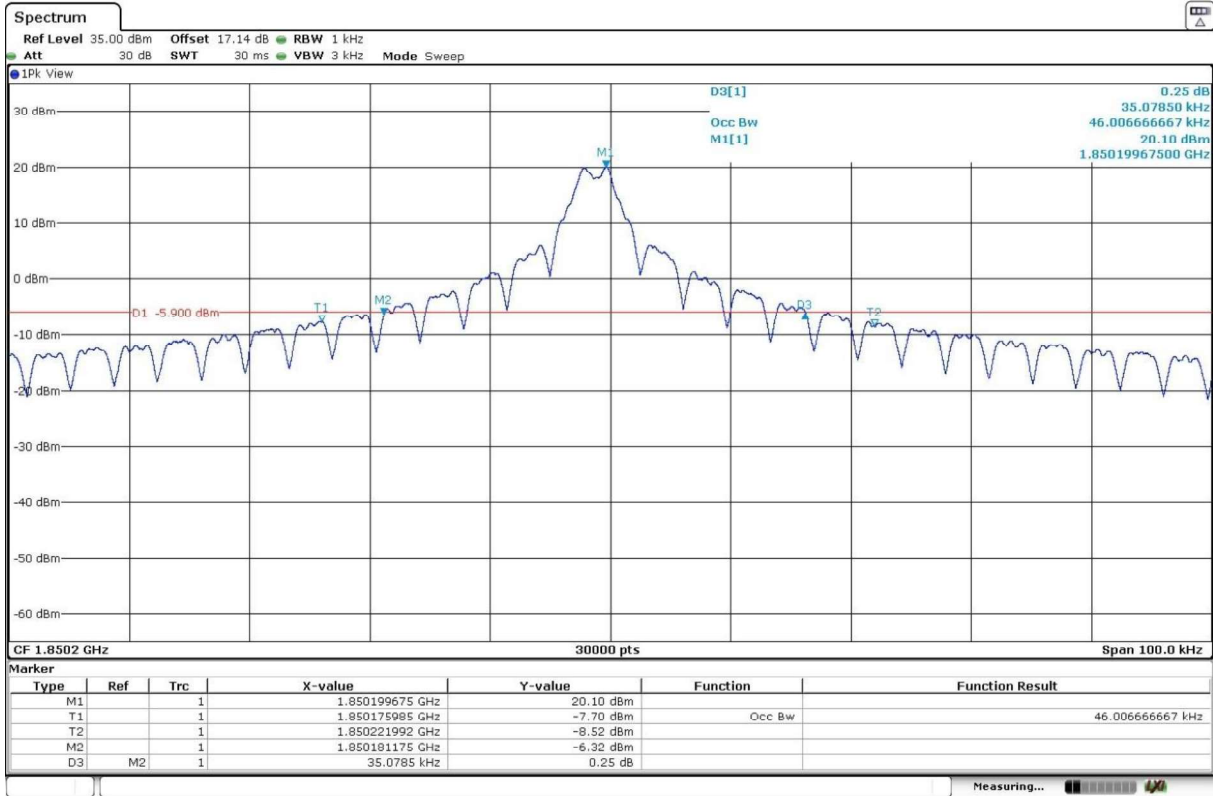

- Middle Channel:

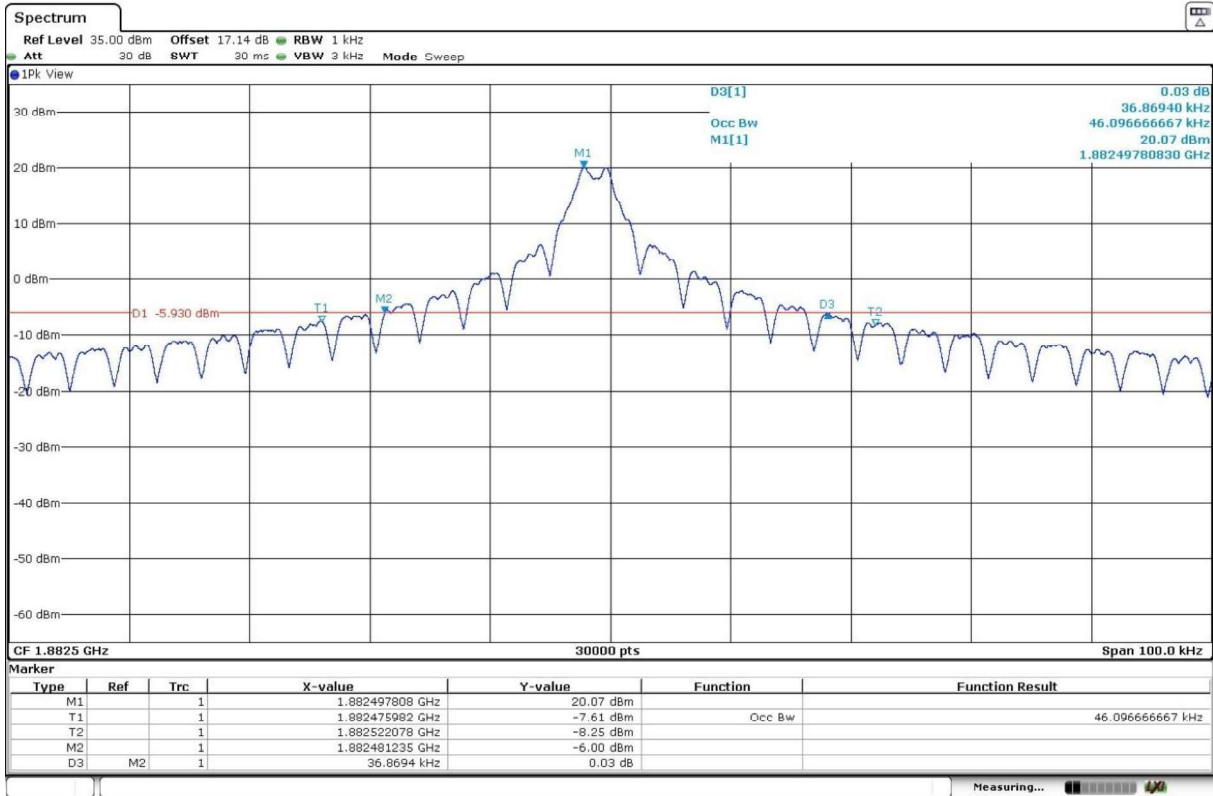

- High Channel:

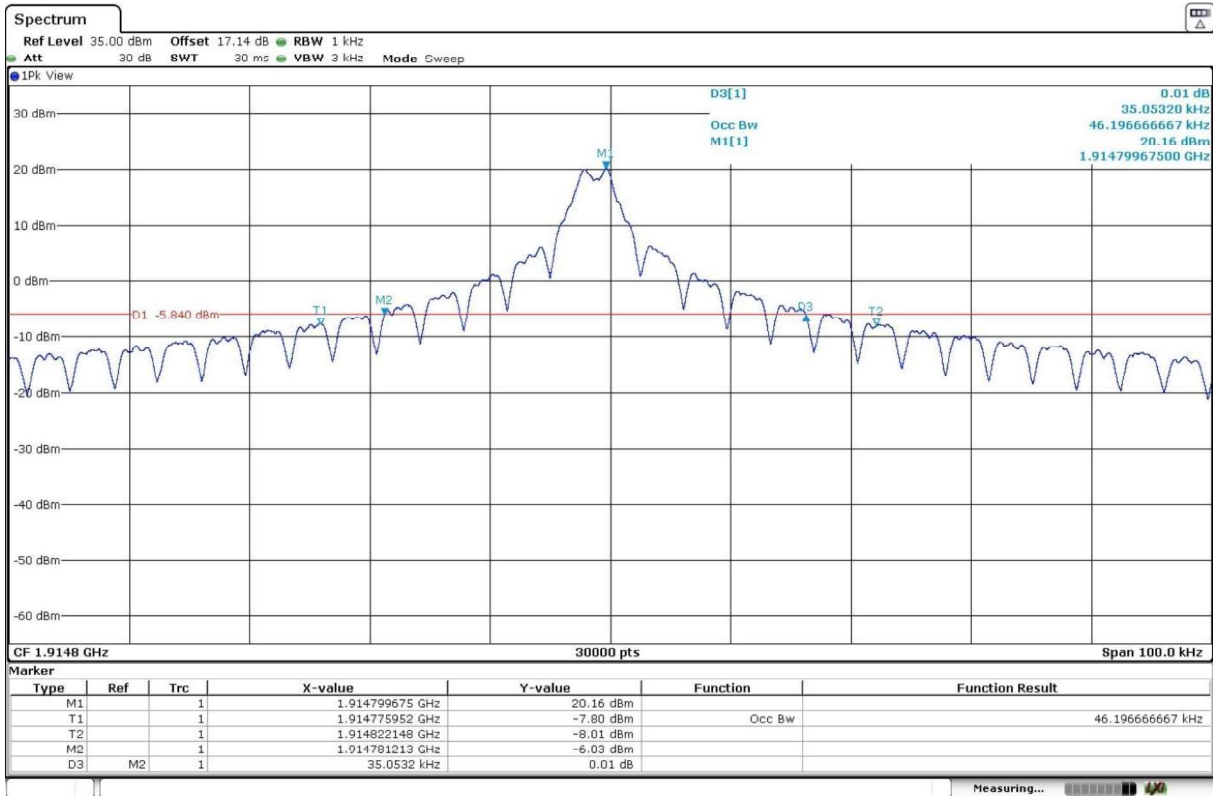

1 tone 3.75 kHz, $\pi/4$ - QPSK modulation.

- Low Channel:

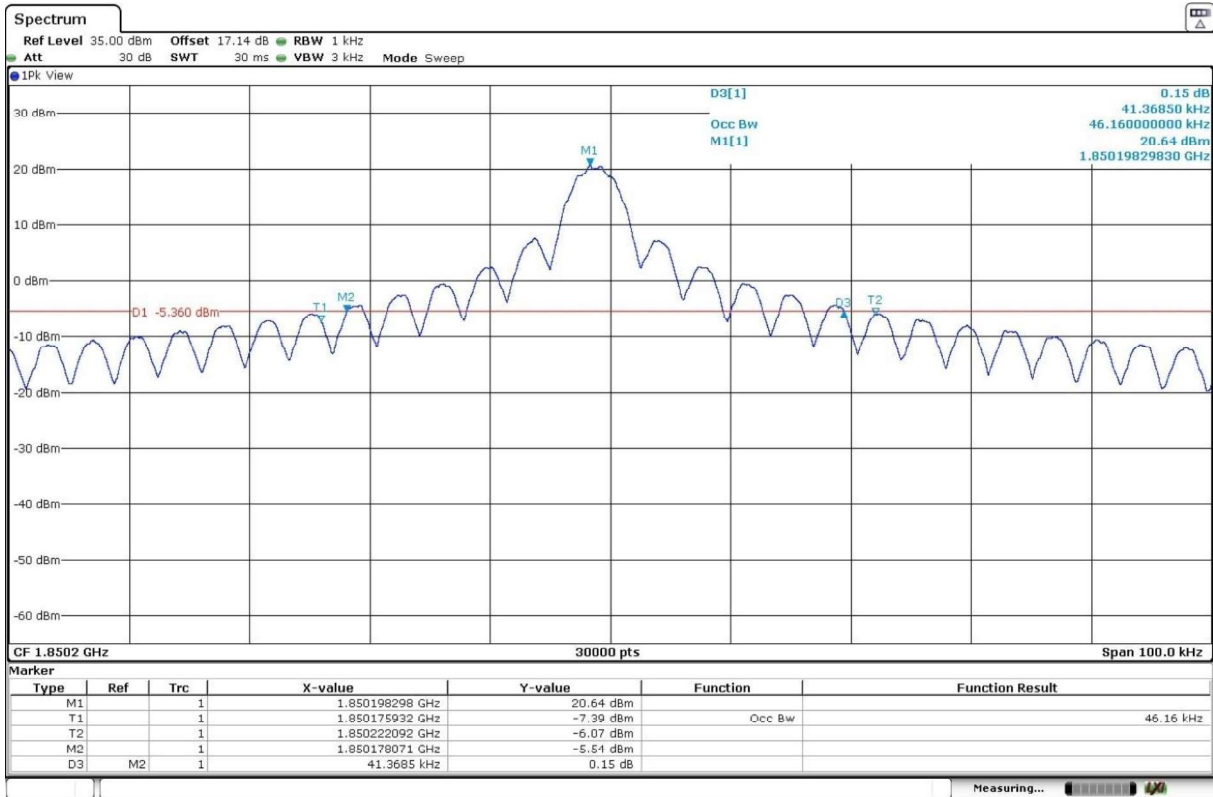

- Middle Channel:

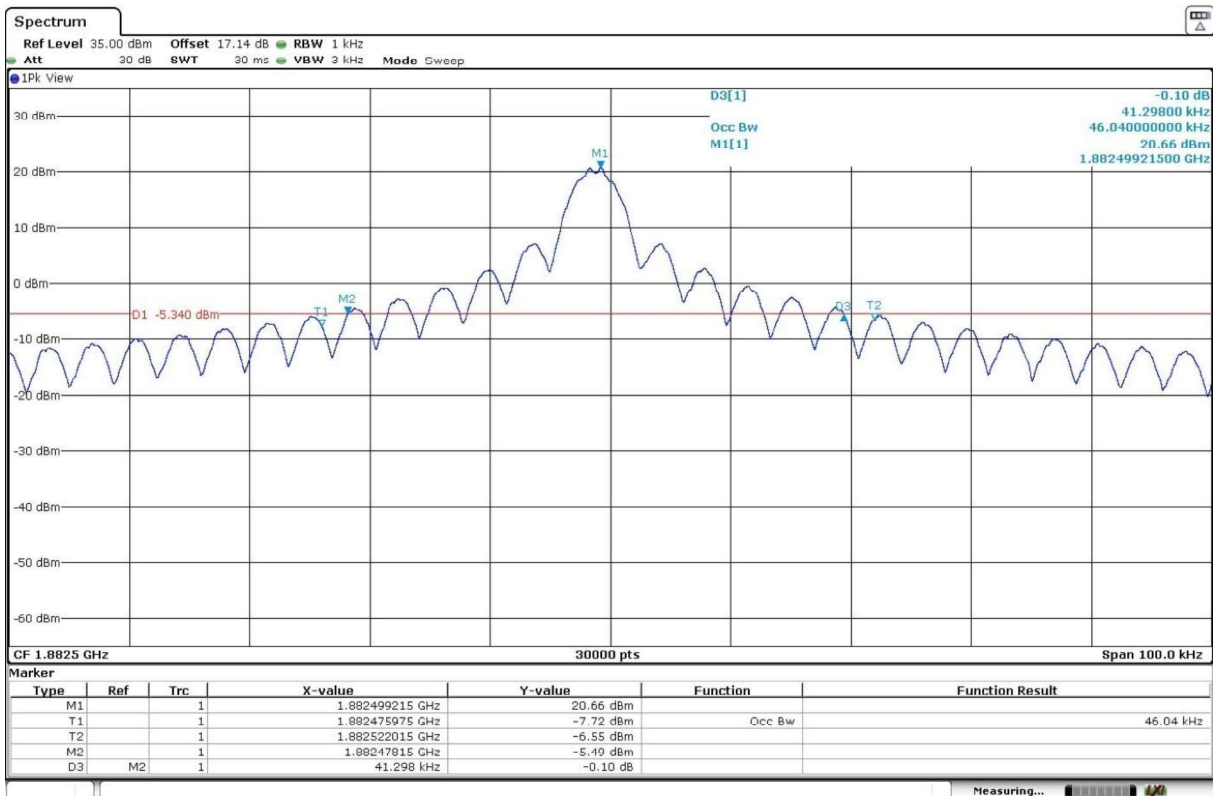

- High Channel:

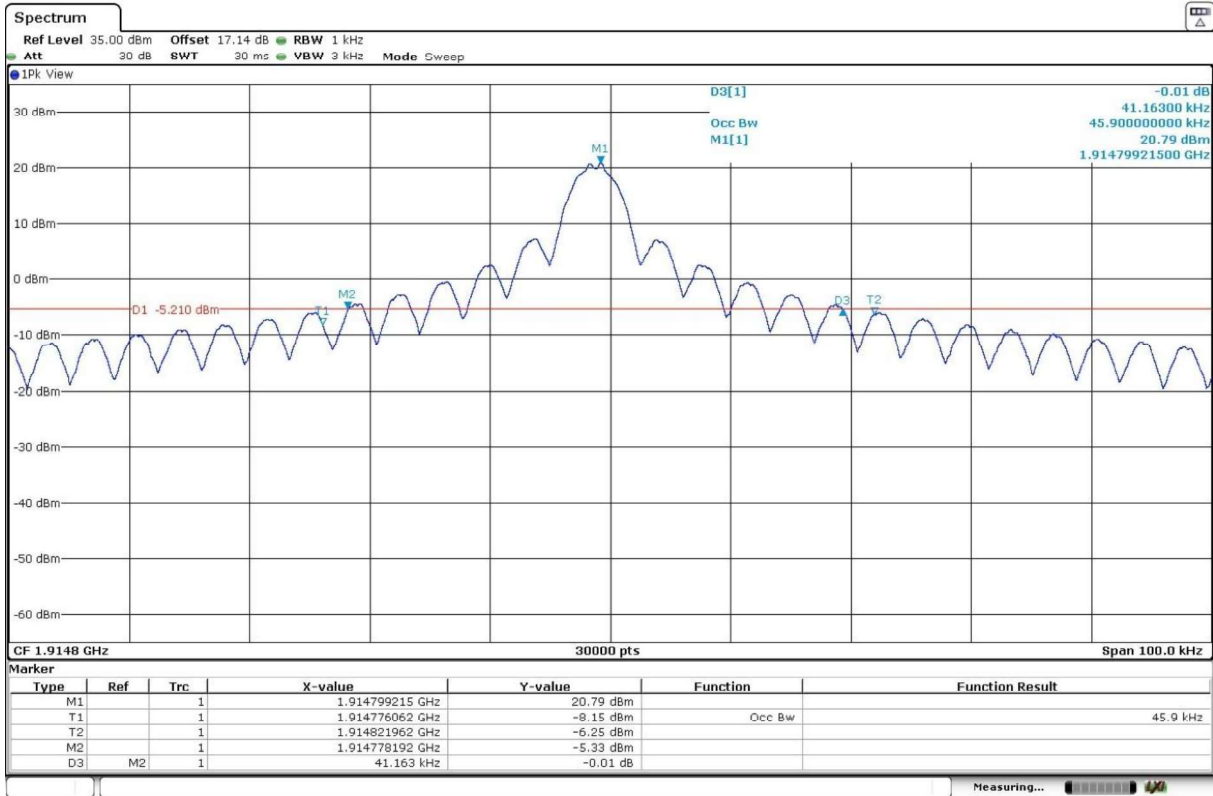

1 tone 15 kHz, $\pi/2$ - BPSK modulation.

- Low Channel:

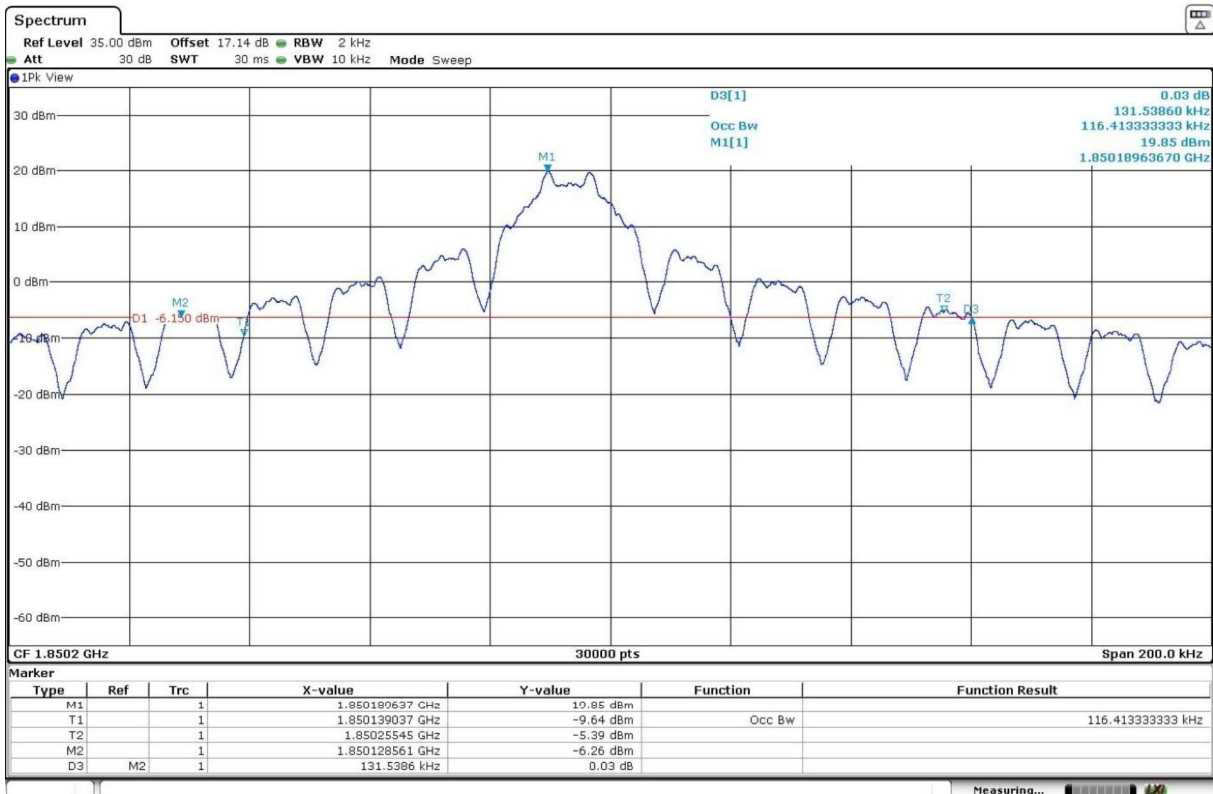

- Middle Channel:

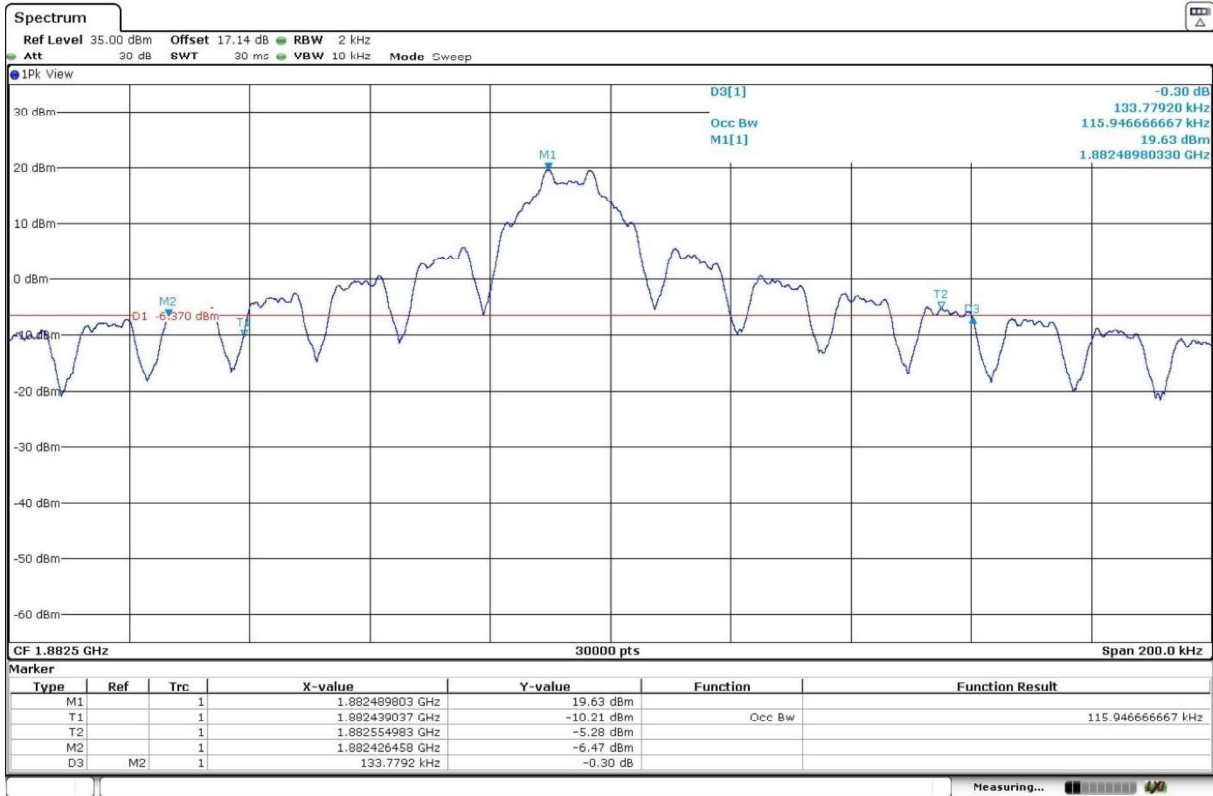

- High Channel:

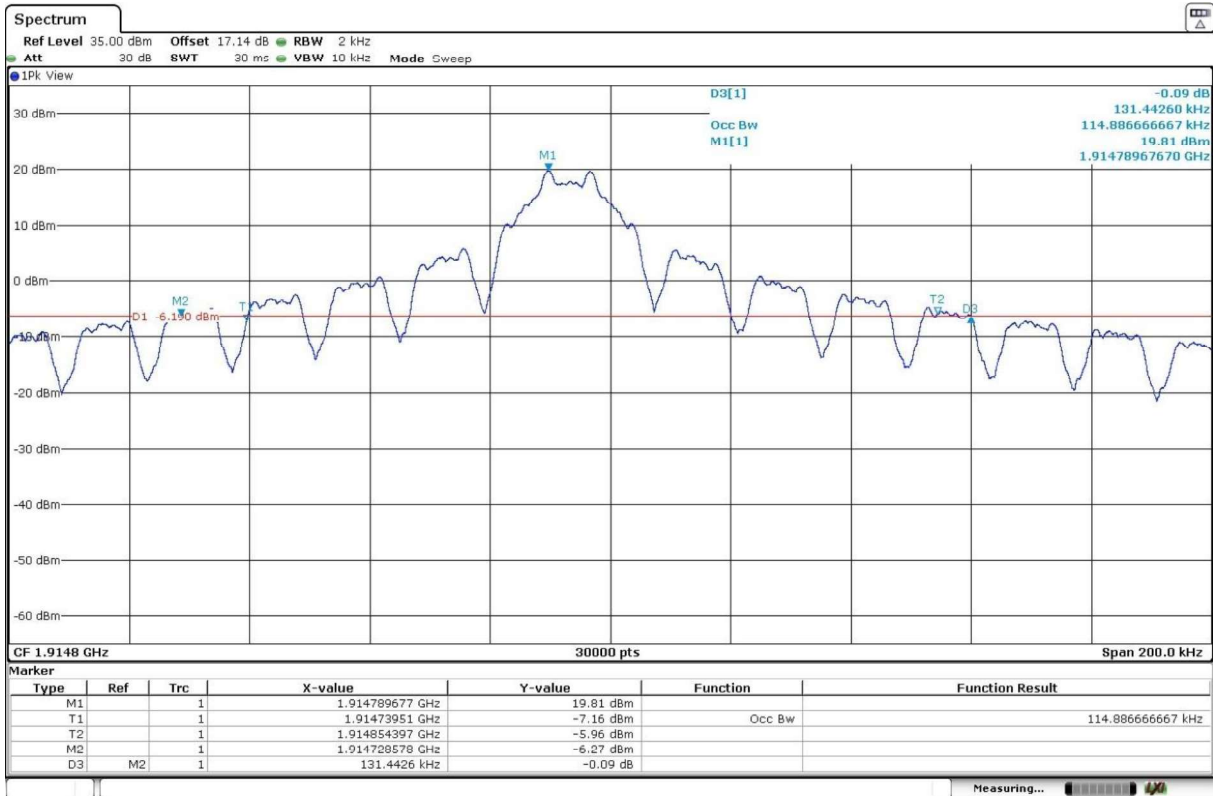

12 tones 15 kHz, $\pi/4$ - QPSK modulation.

- Low Channel:

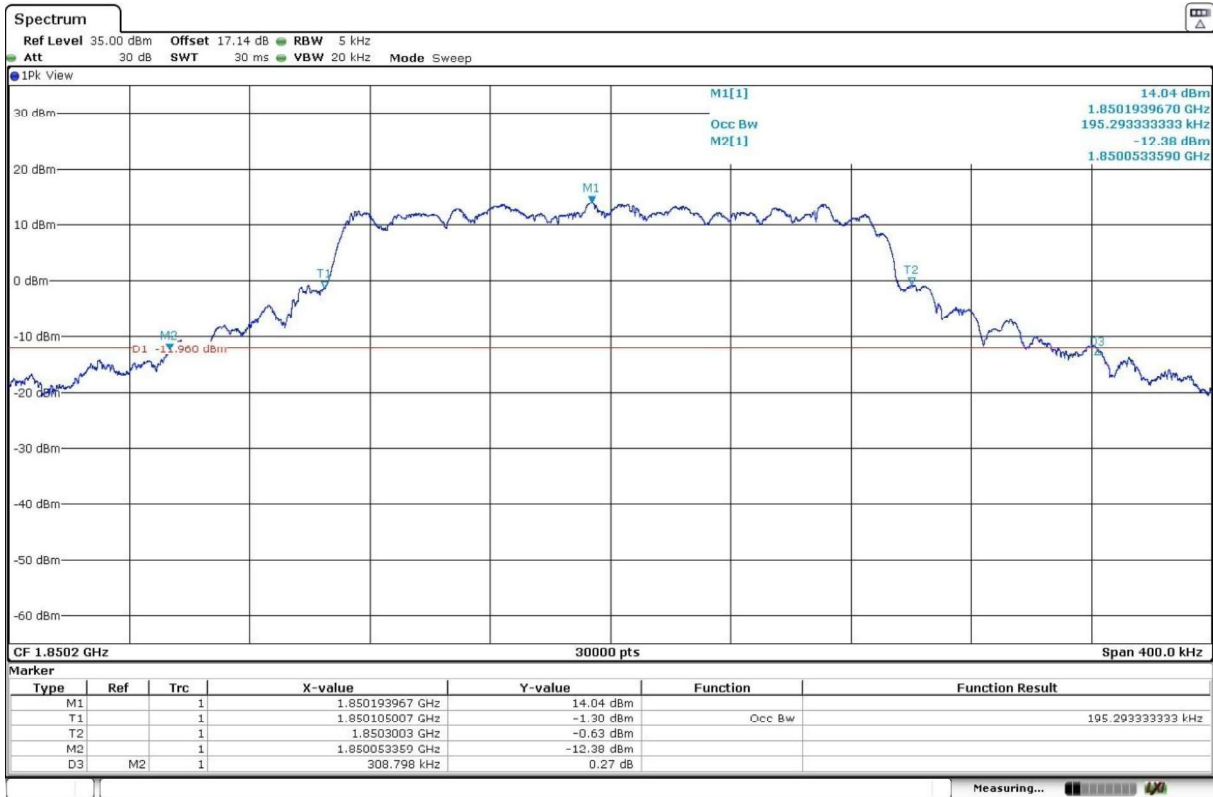

- Middle Channel:

