

Variant FCC Test Report (PART 24)

Report No.: RF180521C04E-1

FCC ID: 2AAGMGM01QA

Test Model: GM01Q

Received Date: Sep. 06, 2019

Test Date: Sep. 26, 2019 ~ Oct. 01, 2019

Issued Date: Oct. 14, 2019

Applicant: Sequans Communications

Address: 15-55 Boulevard Charles de Gaulle, 92700 Colombes France

Issued By: Bureau Veritas Consumer Products Services (H.K.) Ltd., Taoyuan Branch
Lin Kou Laboratories

Lab Address: No. 47-2, 14th Ling, Chia Pau Vil., Lin Kou Dist., New Taipei City, Taiwan

Test Location: No.19, Hwa Ya 2nd Rd., Wen Hwa Vil., Kwei Shan Dist., Taoyuan City
33383, Taiwan

**FCC Registration /
Designation Number:** 788550 / TW0003



This report is for your exclusive use. Any copying or replication of this report to or for any other person or entity, or use of our name or trademark, is permitted only with our prior written permission. This report sets forth our findings solely with respect to the test samples identified herein. The results set forth in this report are not indicative or representative of the quality or characteristics of the lot from which a test sample was taken or any similar or identical product unless specifically and expressly noted. Our report includes all of the tests requested by you and the results thereof based upon the information that you provided to us. You have 60 days from date of issuance of this report to notify us of any material error or omission caused by our negligence, provided, however, that such notice shall be in writing and shall specifically address the issue you wish to raise. A failure to raise such issue within the prescribed time shall constitute your unqualified acceptance of the completeness of this report, the tests conducted and the correctness of the report contents. Unless specific mention, the uncertainty of measurement has been explicitly taken into account to declare the compliance or non-compliance to the specification. The report must not be used by the client to claim product certification, approval, or endorsement by TAF or any government agencies.

Table of Contents

Release Control Record	4
1 Certificate of Conformity	5
2 Summary of Test Results	6
2.1 Measurement Uncertainty	6
2.2 Test Site and Instruments	7
3 General Information	8
3.1 General Description of EUT	8
3.2 Configuration of System under Test	9
3.2.1 Description of Support Units	9
3.3 Test Mode Applicability and Tested Channel Detail	10
3.4 EUT Operating Conditions	11
3.5 General Description of Applied Standards	11
4 Test Types and Results	12
4.1 Output Power Measurement	12
4.1.1 Limits of Output Power Measurement	12
4.1.2 Test Procedures	12
4.1.3 Test Setup	13
4.1.4 Test Results	14
4.2 Modulation Characteristics Measurement	21
4.2.1 Limits of Modulation Characteristics	21
4.2.2 Test Setup	21
4.2.3 Test Procedure	21
4.2.4 Test Results	22
4.3 Frequency Stability Measurement	23
4.3.1 Limits of Frequency Stability Measurement	23
4.3.2 Test Procedure	23
4.3.3 Test Setup	23
4.3.4 Test Results	24
4.4 Occupied Bandwidth Measurement	28
4.4.1 Test Procedure	28
4.4.2 Test Setup	28
4.4.3 Test Result	29
4.5 Band Edge Measurement	31
4.5.1 Limits of Band Edge Measurement	31
4.5.2 Test Setup	31
4.5.3 Test Procedures	31
4.5.4 Test Results	32
4.6 Peak to Average Ratio	36
4.6.1 Limits of Peak to Average Ratio Measurement	36
4.6.2 Test Setup	36
4.6.3 Test Procedures	36
4.6.4 Test Results	37
4.7 Conducted Spurious Emissions	39
4.7.1 Limits of Conducted Spurious Emissions Measurement	39
4.7.2 Test Setup	39
4.7.3 Test Procedure	39
4.7.4 Test Results	40
4.8 Radiated Emission Measurement	44
4.8.1 Limits of Radiated Emission Measurement	44
4.8.2 Test Procedure	44
4.8.3 Deviation from Test Standard	44
4.8.4 Test Setup	45
4.8.5 Test Results	46

5 Pictures of Test Arrangements.....	58
Appendix – Information of the Testing Laboratories	59



Release Control Record

Issue No.	Description	Date Issued
RF180521C04E-1	Original Release	Oct. 14, 2019

1 Certificate of Conformity

Product: GM01Q EZlinkLTE modules

Brand: SEQUANS COMMUNICATIONS

Test Model: GM01Q

Sample Status: Mass Production

Applicant: Sequans Communications

Test Date: Sep. 26, 2019 ~ Oct. 01, 2019

Standards: FCC Part 24, Subpart E

The above equipment has been tested by **Bureau Veritas Consumer Products Services (H.K.) Ltd., Taoyuan Branch**, and found compliance with the requirement of the above standards. The test record, data evaluation & Equipment Under Test (EUT) configurations represented herein are true and accurate accounts of the measurements of the sample's RF characteristics under the conditions specified in this report.

Prepared by : , **Date:** Oct. 14, 2019
Rona Chen / Specialist

Approved by : , **Date:** Oct. 14, 2019
Dylan Chiou / Project Engineer

2 Summary of Test Results

Applied Standard: FCC Part 24 & Part 2			
FCC Clause	Test Item	Result	Remarks
2.1046 24.232	Effective Isotropic Radiated Power	Pass	Meet the requirement of limit.
2.1047	Modulation Characteristics	Pass	Meet the requirement.
2.1046 24.232(d)	Peak to Average Ratio	Pass	Meet the requirement of limit.
2.1055 24.235	Frequency Stability	Pass	Meet the requirement of limit.
2.1049	Occupied Bandwidth	Pass	Meet the requirement of limit.
24.238	Band Edge Measurements	Pass	Meet the requirement of limit.
2.1051 24.238	Conducted Spurious Emissions	Pass	Meet the requirement of limit.
2.1053 24.238	Radiated Spurious Emissions	Pass	Meet the requirement of limit. Minimum passing margin is -17.23 dB at 7440.00 MHz.

Note: Determining compliance based on the results of the compliance measurement, not taking into account measurement instrumentation uncertainty.

2.1 Measurement Uncertainty

Where relevant, the following measurement uncertainty levels have been estimated for tests performed on the EUT as specified in CISPR 16-4-2:

Measurement	Frequency	Expanded Uncertainty (k=2) (±)
Radiated Emissions up to 1 GHz	9 kHz ~ 30 MHz	3.04 dB
	30 MHz ~ 200 MHz	2.93 dB
	200 MHz ~ 1000 MHz	2.95 dB
Radiated Emissions above 1 GHz	1 GHz ~ 18 GHz	2.26 dB
	18 GHz ~ 40 GHz	1.94 dB

2.2 Test Site and Instruments

Description & Manufacturer	Model No.	Serial No.	Date of Calibration	Due Date of Calibration
Test Receiver Agilent	N9038A	MY51210203	Mar. 18, 2019	Mar. 17, 2020
Spectrum Analyzer Agilent	N9010A	MY56070348	Sep. 09, 2019	Sep. 08, 2020
Spectrum Analyzer ROHDE & SCHWARZ	FSU43	100115	Jan. 21, 2019	Jan. 20, 2020
Spectrum Analyzer ROHDE & SCHWARZ	FSW26	102023	Oct. 11, 2018	Oct. 10, 2019
HORN Antenna SCHWARZBECK	3115	5619	Nov. 25, 2018	Nov. 24, 2019
HORN Antenna SCHWARZBECK	BBHA 9120 D	9120D-969	Nov. 25, 2018	Nov. 24, 2019
BILOG Antenna SCHWARZBECK	VULB9168	9168-472	Nov. 23, 2018	Nov. 22, 2019
Fixed Attenuator Mini-Circuits	MDCS18N-10	MDCS18N-10-01	Apr. 15, 2019	Apr. 14, 2020
MXG Vector signal generator Agilent	N5182B	MY53052658	May 20, 2019	May 19, 2020
Preamplifier EMCI	EMC 012645	980115	Oct. 12, 2018	Oct. 11, 2019
Preamplifier EMCI	EMC 330H	980112	Oct. 12, 2018	Oct. 11, 2019
RF Coaxial Cable HUBER+SUHNNER	EMC104-SM-SM-800 0&3000	140811+170717	Oct. 12, 2018	Oct. 11, 2019
RF Coaxial Cable HUBER+SUHNNER	SUCOFLEX 104	EMC104-SM-SM- 1000(140807)	Oct. 12, 2018	Oct. 11, 2019
RF Coaxial Cable WOKEN	8D-FB	Cable-Ch10-01	Oct. 12, 2018	Oct. 11, 2019
Boresight Antenna Fixture	FBA-01	FBA-SIP01	NA	NA
Software BV ADT	E3 6.120103	NA	NA	NA
Antenna Tower MF	MFA-440H	NA	NA	NA
Turn Table MF	MFT-201SS	NA	NA	NA
Antenna Tower & Turn Table Controller MF	MF-7802	NA	NA	NA
LTE Wireless Communication Test Set Keysight	E7515A	MY57270629	Feb. 22, 2019	Feb. 21, 2020
Temperature & Humidity Chamber	GTH-120-40-CP-AR	MAA1306-019	Sep. 06, 2019	Sep. 05, 2020
DC Power Supply Topward	33010D	807748	NA	NA

Note: 1. The calibration interval of the above test instruments is 12 / 24 months and the calibrations are traceable to NML/ROC and NIST/USA.

2. The test was performed in HwaYa Chamber 10.

3 General Information

3.1 General Description of EUT

Product	GM01Q EZlinkLTE modules	
Brand	SEQUANS COMMUNICATIONS	
Test Model	GM01Q	
Status of EUT	Mass Production	
Power Supply Rating	5.0 Vdc (adapter) or 3.8 Vdc (form DC power supply)	
Modulation Type	LTE	QPSK, 16QAM
Frequency Range	LTE Band 2 (Channel Bandwidth: 5 MHz)	1852.5 ~ 1907.5 MHz
	LTE Band 2 (Channel Bandwidth: 10 MHz)	1855.0 ~ 1905.0 MHz
	LTE Band 2 (Channel Bandwidth: 15 MHz)	1857.5 ~ 1902.5 MHz
	LTE Band 2 (Channel Bandwidth: 20 MHz)	1860.0 ~ 1900.0 MHz
	LTE Band 25 (Channel Bandwidth: 5 MHz)	1852.5 ~ 1912.5 MHz
	LTE Band 25 (Channel Bandwidth: 10 MHz)	1855.0 ~ 1910.0 MHz
	LTE Band 25 (Channel Bandwidth: 15 MHz)	1857.5 ~ 1907.5 MHz
	LTE Band 25 (Channel Bandwidth: 20 MHz)	1860.0 ~ 1905.0 MHz
Max. EIRP Power	LTE Band 25 (Channel Bandwidth: 5 MHz)	196.79 mW
	LTE Band 25 (Channel Bandwidth: 10 MHz)	206.54 mW
	LTE Band 25 (Channel Bandwidth: 15 MHz)	220.29 mW
	LTE Band 25 (Channel Bandwidth: 20 MHz)	233.88 mW
Emission Designator	LTE Band 25 (Channel Bandwidth: 5 MHz)	1M10G7D
	LTE Band 25 (Channel Bandwidth: 10 MHz)	1M09G7D
	LTE Band 25 (Channel Bandwidth: 15 MHz)	1M10G7D
	LTE Band 25 (Channel Bandwidth: 20 MHz)	1M09G7D
Antenna Type	Broadband Omni-Directional Antenna with 2.1 dBi gain	
Accessory Device	Refer to Note as below	
Data Cable Supplied	Refer to Note as below	

Note:

1. This report is issued as a supplementary report to BV CPS report no.: RF180521C04B R1. The difference compared with original report is enabling LTE Cat-M1 B5 and B25. Therefore, only LTE Band 25 was tested and recorded in this report.
2. The above EUT information is declared by manufacturer and for more detailed features description, please refers to the manufacturer's specifications or user's manual.

3.2 Configuration of System under Test

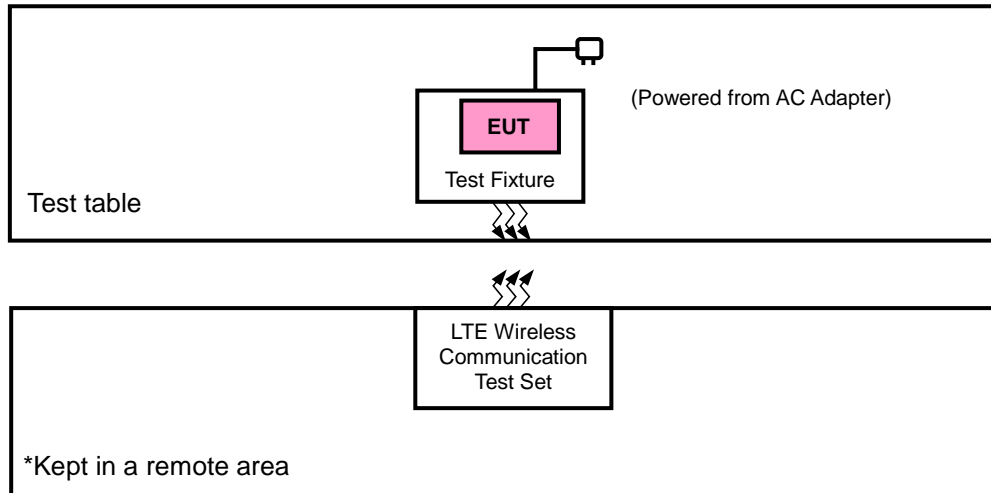

3.2.1 Description of Support Units

The EUT has been tested as an independent unit together with other necessary accessories or support units.

3.3 Test Mode Applicability and Tested Channel Detail

Pre-Scan has been conducted to determine the worst-case mode from all possible combinations between available modulations, data rates, XYZ axis, and antenna ports.

The worst case was found when positioned as the table below. Following channel(s) was (were) selected for the final test as listed below:

Band	EIRP	Radiated Emission
LTE Band 25	Z-plane	Z-plane

LTE Band 25

EUT Configure Mode	Test Item	Available Channel	Tested Channel	Channel Bandwidth	Modulation	Mode
-	EIRP	26065 to 26665	26065, 26365, 26665	5 MHz	QPSK, 16QAM	1 RB / 0 RB Offset
		26090 to 26640	26090, 26365, 26640	10 MHz	QPSK, 16QAM	1 RB / 0 RB Offset
		26115 to 26615	26115, 26365, 26615	15 MHz	QPSK, 16QAM	1 RB / 0 RB Offset
		26140 to 26590	26140, 26365, 26590	20 MHz	QPSK, 16QAM	1 RB / 0 RB Offset
-	Modulation Characteristics	26140 to 26590	26365	20 MHz	QPSK	6 RB / 0 RB Offset
					16QAM	5 RB / 0 RB Offset
-	Frequency Stability	26065 to 26665	26065, 26665	5 MHz	QPSK	1 RB / 0 RB Offset
		26090 to 26640	26090, 26640	10 MHz	QPSK	1 RB / 0 RB Offset
		26115 to 26615	26115, 26615	15 MHz	QPSK	1 RB / 0 RB Offset
		26140 to 26590	26140, 26590	20 MHz	QPSK	1 RB / 0 RB Offset
-	Occupied Bandwidth	26065 to 26665	26065, 26365, 26665	5 MHz	QPSK, 16QAM	25 RB / 0 RB Offset
		26090 to 26640	26090, 26365, 26640	10 MHz	QPSK, 16QAM	50 RB / 0 RB Offset
		26115 to 26615	26115, 26365, 26615	15 MHz	QPSK, 16QAM	75 RB / 0 RB Offset
		26140 to 26590	26140, 26365, 26590	20 MHz	QPSK, 16QAM	100 RB / 0 RB Offset
-	Peak to Average Ratio	26065 to 26665	26065, 26365, 26665	5 MHz	QPSK, 16QAM	1 RB / 0 RB Offset
		26090 to 26640	26090, 26365, 26640	10 MHz	QPSK, 16QAM	1 RB / 0 RB Offset
		26115 to 26615	26115, 26365, 26615	15 MHz	QPSK, 16QAM	1 RB / 0 RB Offset
		26140 to 26590	26140, 26365, 26590	20 MHz	QPSK, 16QAM	1 RB / 0 RB Offset
-	Band Edge	26065 to 26665	26065	5 MHz	QPSK	1 RB / 0 RB Offset 25 RB / 0 RB Offset
			26665	5 MHz	QPSK	1 RB / 24 RB Offset 25 RB / 0 RB Offset
		26090 to 26640	26090	10 MHz	QPSK	1 RB / 0 RB Offset 50 RB / 0 RB Offset
			26640	10 MHz	QPSK	1 RB / 49 RB Offset 50 RB / 0 RB Offset
		26115 to 26615	26115	15 MHz	QPSK	1 RB / 0 RB Offset 75 RB / 0 RB Offset
			26615	15 MHz	QPSK	1 RB / 74 RB Offset 75 RB / 0 RB Offset
		26140 to 26590	26140	20 MHz	QPSK	1 RB / 0 RB Offset 100 RB / 0 RB Offset
			26590	20 MHz	QPSK	1 RB / 99 RB Offset 100 RB / 0 RB Offset

EUT Configure Mode	Test Item	Available Channel	Tested Channel	Channel Bandwidth	Modulation	Mode
-	Conducted Emission	26065 to 26665	26065, 26365, 26665	5 MHz	QPSK	1 RB / 0 RB Offset
		26090 to 26640	26090, 26365, 26640	10 MHz	QPSK	1 RB / 0 RB Offset
		26115 to 26615	26115, 26365, 26615	15 MHz	QPSK	1 RB / 0 RB Offset
		26140 to 26590	26140, 26365, 26590	20 MHz	QPSK	1 RB / 0 RB Offset
-	Radiated Emission	18625 to 19175	18625, 18900, 19175	5 MHz	QPSK	1 RB / 0 RB Offset
		18700 to 19100	18700, 18900, 19100	20 MHz	QPSK	1 RB / 0 RB Offset

Note:

1. This device was tested under all bandwidths, RB configurations and modulations. The worst case was found in QPSK modulation.
2. For radiated emission above 1 GHz, according to 3GPP 36.521 Section 6.6.3.1.4, choose the lowest, 5 MHz & highest channel bandwidth for final test.

Test Condition:

Test Item	Environmental Conditions	Input Power	Tested By
EIRP	26 deg. C, 58 % RH	3.8 Vdc	Tim Chen Thomas Wei
Modulation Characteristics	26 deg. C, 58 % RH	3.8 Vdc	Getaz Yang
Frequency Stability	26 deg. C, 58 % RH	3.8 Vdc	Getaz Yang
Occupied Bandwidth	26 deg. C, 58 % RH	3.8 Vdc	Getaz Yang
Band Edge	26 deg. C, 58 % RH	3.8 Vdc	Getaz Yang
Peak to Average Ratio	26 deg. C, 58 % RH	3.8 Vdc	Getaz Yang
Conducted Emission	26 deg. C, 58 % RH	3.8 Vdc	Getaz Yang
Radiated Emission	25 deg. C, 65 % RH	120 Vac, 60 Hz	Tim Chen Thomas Wei

3.4 EUT Operating Conditions

The EUT makes a call to the communication simulator. The communication simulator station system controlled a EUT to export maximum output power under transmission mode and specific channel frequency

3.5 General Description of Applied Standards

The EUT is a RF Product. According to the specifications of the manufacturer, it must comply with the requirements of the following standards:

FCC 47 CFR Part 2

FCC 47 CFR Part 24

KDB 971168 D01 Power Meas License Digital Systems v03r01

ANSI/TIA/EIA-603-E 2016

ANSI 63.26-2015

NOTE: All test items have been performed and recorded as per the above standards.

4 Test Types and Results

4.1 Output Power Measurement

4.1.1 Limits of Output Power Measurement

Mobile / Portable station are limited to 2 watts e.i.r.p.

4.1.2 Test Procedures

EIRP / ERP Measurement:

- a. All measurements were done at low, middle and high operational frequency range. RBW and VBW is 10 MHz for LTE mode.
- b. Substitution method is used for E.I.R.P measurement. In the semi-anechoic chamber, EUT placed on the 0.8 m (below or equal 1 GHz) and/or 1.5 m (above 1 GHz) height of Turn Table, rotated the table around 360 degrees to search the maximum radiation power and receiver antenna shall be rotated vertical and horizontal polarization and moved height from 1 m to 4 m to find the maximum polar radiated power. The "Read Value" is the spectrum reading the maximum power value.
- c. The substitution horn antenna is substituted for EUT at the same position and signals generator export the CW signal to the substitution antenna via a tx cable. Rotated the Turn Table and moved receiving antenna to find the maximum radiation power. Adjust output power level of S.G to get a Value of spectrum reading equal to "Read Value" of step b. Record the power level of S.G.
- d. $EIRP = \text{Output power level of S.G} - \text{TX cable loss} + \text{Antenna gain of substitution horn}$. E.R.P power can be calculated form E.I.R.P power by subtracting the gain of dipole, $E.R.P \text{ power} = E.I.R.P \text{ power} - 2.15 \text{ dB}$.

Conducted Power Measurement:

The EUT was set up for the maximum power with LTE link data modulation and link up with simulator. Set the EUT to transmit under low, middle and high channel and record the power level shown on simulator.

4.1.3 Test Setup

EIRP / ERP Measurement:

<Radiated Emission below or equal 1 GHz>

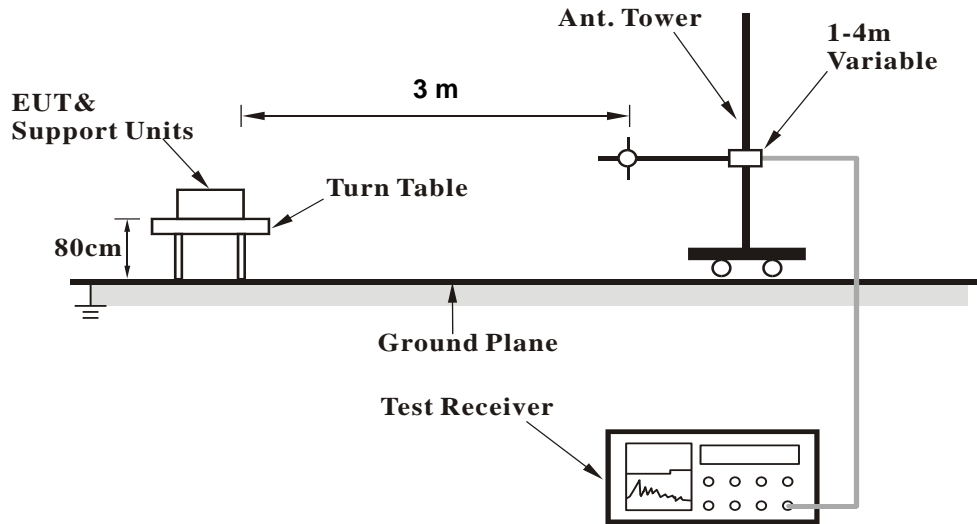

<Radiated Emission above 1 GHz>

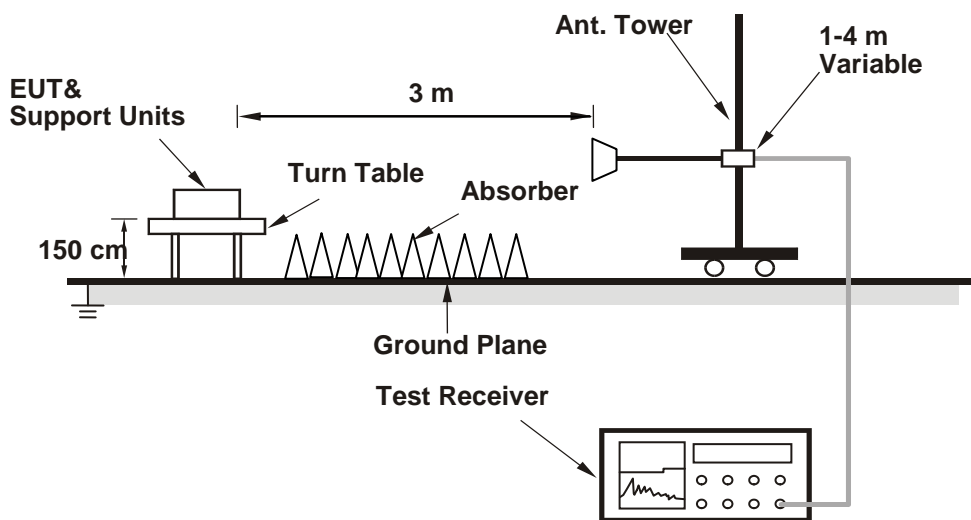

For the actual test configuration, please refer to the attached file (Test Setup Photo).

Conducted Power Measurement:

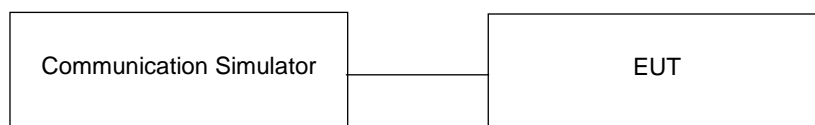

4.1.4 Test Results

Conducted Output Power (dBm)

LTE Band 25

BW (MHz): 5										
Test Frequency ID	N _{UL}	Frequency of Uplink [MHz]	N _{DL}	Frequency of Downlink [MHz]	Test Configuration Initial of Power				EUT	
					Modulation	RB Size	RB Offset	Narrowband Index	Cell power (dBm/15kHz)	Power (dBm)
Low Range	26065	1852.5	8065	1932.5	QPSK	1	0	0	-85	21.96
					QPSK	1	5	0	-85	20.73
					QPSK	1	0	1	-85	21.01
					QPSK	1	5	1	-85	20.59
					QPSK	1	0	3	-85	20.80
					QPSK	1	5	3	-85	20.68
					QPSK	3	0	0	-85	20.80
					QPSK	3	3	3	-85	20.51
					QPSK	6	0	0	-85	21.05
					QPSK	6	0	1	-85	20.87
					QPSK	6	0	3	-85	21.33
					16QAM	1	0	0	-85	20.48
					16QAM	1	5	0	-85	20.75
					16QAM	1	0	1	-85	20.35
					16QAM	1	5	1	-85	20.76
					16QAM	1	0	3	-85	20.58
					16QAM	1	5	3	-85	20.76
					16QAM	3	0	0	-85	20.79
16QAM	3	3	3	-85	20.50					
16QAM	5	0	0	-85	21.15					
16QAM	5	0	1	-85	21.59					
16QAM	5	0	3	-85	20.68					
Mid Range	26365	1882.5	8365	1962.5	QPSK	1	0	0	-85	20.10
					QPSK	1	5	0	-85	20.22
					QPSK	1	0	1	-85	20.21
					QPSK	1	5	1	-85	20.47
					QPSK	1	0	3	-85	20.43
					QPSK	1	5	3	-85	20.60
					QPSK	3	0	0	-85	20.51
					QPSK	3	3	3	-85	20.80
					QPSK	6	0	0	-85	21.03
					QPSK	6	0	1	-85	20.70
					QPSK	6	0	3	-85	20.53
					16QAM	1	0	0	-85	20.04
					16QAM	1	5	0	-85	20.64
					16QAM	1	0	1	-85	20.28
					16QAM	1	5	1	-85	20.27
					16QAM	1	0	3	-85	20.39
					16QAM	1	5	3	-85	20.76
					16QAM	3	0	0	-85	20.60
16QAM	3	3	3	-85	21.22					
16QAM	5	0	0	-85	21.63					
16QAM	5	0	1	-85	20.86					
16QAM	5	0	3	-85	20.45					

Test Frequency ID	N _{UL}	Frequency of Uplink [MHz]	N _{DL}	Frequency of Downlink [MHz]	Test Configuration Initial of Power				EUT	
					Modulation	RB Size	RB Offset	Narrowband Index	Cell power (dBm/15kHz)	Power (dBm)
High Range	26665	1912.5	8665	1992.5	QPSK	1	0	0	-85	21.20
					QPSK	1	5	0	-85	21.15
					QPSK	1	0	1	-85	20.71
					QPSK	1	5	1	-85	20.85
					QPSK	1	0	3	-85	20.80
					QPSK	1	5	3	-85	20.82
					QPSK	3	0	0	-85	21.19
					QPSK	3	3	3	-85	21.00
					QPSK	6	0	0	-85	20.87
					QPSK	6	0	1	-85	20.50
					QPSK	6	0	3	-85	20.88
					16QAM	1	0	0	-85	20.90
					16QAM	1	5	0	-85	20.59
					16QAM	1	0	1	-85	20.87
					16QAM	1	5	1	-85	20.68
					16QAM	1	0	3	-85	20.98
					16QAM	1	5	3	-85	20.78
					16QAM	3	0	0	-85	20.91
					16QAM	3	3	3	-85	21.02
					16QAM	5	0	0	-85	21.11
16QAM	5	0	1	-85	21.46					
16QAM	5	0	3	-85	20.81					

BW (MHz): 10										
Test Frequency ID	N _{UL}	Frequency of Uplink [MHz]	N _{DL}	Frequency of Downlink [MHz]	Test Configuration Initial of Power				EUT	
					Modulation	RB Size	RB Offset	Narrowband Index	Cell power (dBm/15kHz)	Power (dBm)
Low Range	26090	1855	8090	1935	QPSK	1	0	0	-85	21.99
					QPSK	1	5	0	-85	20.78
					QPSK	1	0	3	-85	21.03
					QPSK	1	5	3	-85	21.03
					QPSK	1	0	7	-85	20.99
					QPSK	1	5	7	-85	21.06
					QPSK	4	0	0	-85	20.33
					QPSK	4	2	7	-85	21.12
					QPSK	6	0	0	-85	20.37
					QPSK	6	0	7	-85	20.87
					16QAM	1	0	0	-85	21.18
					16QAM	1	5	0	-85	20.62
					16QAM	1	0	3	-85	20.29
					16QAM	1	5	3	-85	20.71
					16QAM	1	0	7	-85	20.71
					16QAM	1	5	7	-85	20.83
					16QAM	4	2	0	-85	21.01
					16QAM	4	2	7	-85	20.93
16QAM	5	0	0	-85	20.69					
16QAM	5	0	7	-85	21.00					
Mid Range	26365	1882.5	8365	1962.5	QPSK	1	0	0	-85	21.49
					QPSK	1	5	0	-85	20.59
					QPSK	1	0	3	-85	20.69
					QPSK	1	5	3	-85	20.26
					QPSK	1	0	7	-85	20.44
					QPSK	1	5	7	-85	20.80
					QPSK	4	0	0	-85	20.33
					QPSK	4	2	7	-85	20.14
					QPSK	6	0	0	-85	20.42
					QPSK	6	0	7	-85	20.66
					16QAM	1	0	0	-85	21.35
					16QAM	1	5	0	-85	20.97
					16QAM	1	0	3	-85	20.04
					16QAM	1	5	3	-85	20.47
					16QAM	1	0	7	-85	20.48
					16QAM	1	5	7	-85	20.81
					16QAM	4	2	0	-85	20.71
					16QAM	4	2	7	-85	20.43
16QAM	5	0	0	-85	20.62					
16QAM	5	0	7	-85	20.39					
High Range	26640	1910	8640	1990	QPSK	1	0	0	-85	21.36
					QPSK	1	5	0	-85	20.80
					QPSK	1	5	7	-85	20.48
					QPSK	1	0	3	-85	20.37
					QPSK	1	5	3	-85	20.89
					QPSK	1	0	7	-85	20.52
					QPSK	4	0	0	-85	20.73
					QPSK	4	2	7	-85	20.96
					QPSK	6	0	0	-85	20.78
					QPSK	6	0	7	-85	20.71
					16QAM	1	0	0	-85	21.62
					16QAM	1	5	0	-85	21.04
					16QAM	1	0	3	-85	20.79
					16QAM	1	5	3	-85	21.05
					16QAM	1	0	7	-85	21.00
					16QAM	1	5	7	-85	20.78
					16QAM	4	2	0	-85	20.82
					16QAM	4	2	7	-85	20.52
16QAM	5	0	0	-85	20.58					
16QAM	5	0	7	-85	20.83					

BW (MHz): 15										
Test Frequency ID	N _{UL}	Frequency of Uplink [MHz]	N _{DL}	Frequency of Downlink [MHz]	Test Configuration Initial of Power				EUT	
					Modulation	RB Size	RB Offset	Narrowband Index	Cell power (dBm/15kHz)	power (dBm)
Low Range	26115	1857.5	8115	1937.5	QPSK	1	0	0	-85	22.07
					QPSK	1	5	0	-85	21.18
					QPSK	1	0	5	-85	21.32
					QPSK	1	5	5	-85	21.47
					QPSK	1	0	11	-85	21.37
					QPSK	1	5	11	-85	21.49
					QPSK	3	0	0	-85	21.16
					QPSK	3	3	11	-85	21.32
					QPSK	6	0	0	-85	21.22
					QPSK	6	0	11	-85	21.45
					16QAM	1	0	0	-85	21.93
					16QAM	1	5	0	-85	21.43
					16QAM	1	0	5	-85	21.39
					16QAM	1	5	5	-85	21.24
					16QAM	1	0	11	-85	21.11
					16QAM	1	5	11	-85	21.09
					16QAM	3	0	0	-85	21.27
					16QAM	3	3	11	-85	21.39
16QAM	5	0	0	-85	21.12					
16QAM	5	0	11	-85	21.34					
Mid Range	26365	1882.5	8365	1962.5	QPSK	1	0	0	-85	21.87
					QPSK	1	5	0	-85	21.08
					QPSK	1	0	5	-85	21.10
					QPSK	1	5	5	-85	21.03
					QPSK	1	0	11	-85	20.95
					QPSK	1	5	11	-85	21.15
					QPSK	3	0	0	-85	21.23
					QPSK	3	3	11	-85	21.01
					QPSK	6	0	0	-85	21.00
					QPSK	6	0	11	-85	21.18
					16QAM	1	0	0	-85	21.73
					16QAM	1	5	0	-85	21.24
					16QAM	1	0	5	-85	20.92
					16QAM	1	5	5	-85	20.82
					16QAM	1	0	11	-85	21.18
					16QAM	1	5	11	-85	21.00
					16QAM	3	0	0	-85	20.95
					16QAM	3	3	11	-85	21.11
16QAM	5	0	0	-85	21.18					
16QAM	5	0	11	-85	21.17					
High Range	26615	1907.5	8615	1987.5	QPSK	1	0	0	-85	22.12
					QPSK	1	5	11	-85	21.64
					QPSK	1	0	5	-85	21.46
					QPSK	1	5	5	-85	21.55
					QPSK	1	0	11	-85	21.28
					QPSK	1	5	11	-85	21.33
					QPSK	3	0	0	-85	21.43
					QPSK	3	3	11	-85	21.24
					QPSK	6	0	0	-85	21.41
					QPSK	6	0	11	-85	21.31
					16QAM	1	0	0	-85	22.03
					16QAM	1	5	0	-85	21.36
					16QAM	1	0	5	-85	21.15
					16QAM	1	5	5	-85	21.23
					16QAM	1	0	11	-85	21.61
					16QAM	1	5	11	-85	21.59
					16QAM	3	0	0	-85	21.15
					16QAM	3	3	11	-85	21.45
16QAM	5	0	0	-85	21.21					
16QAM	5	0	11	-85	21.44					

BW (MHz): 20										
Test Frequency ID	N _{UL}	Frequency of Uplink [MHz]	N _{DL}	Frequency of Downlink [MHz]	Test Configuration Initial of Power				EUT	
					Modulation	RB Size	RB Offset	Narrowband Index	Cell power (dBm/15kHz)	power (dBm)
Low Range	26140	1860	8140	1940	QPSK	1	0	0	-85	22.23
					QPSK	1	5	0	-85	21.98
					QPSK	1	0	7	-85	22.05
					QPSK	1	5	7	-85	22.03
					QPSK	1	0	15	-85	22.16
					QPSK	1	5	15	-85	22.14
					QPSK	3	0	0	-85	22.00
					QPSK	3	3	15	-85	22.17
					QPSK	6	0	0	-85	21.95
					QPSK	6	0	15	-85	22.20
					16QAM	1	0	0	-85	22.08
					16QAM	1	5	0	-85	22.04
					16QAM	1	0	7	-85	21.89
					16QAM	1	5	7	-85	21.89
					16QAM	1	0	15	-85	21.92
					16QAM	1	5	15	-85	21.94
					16QAM	3	0	0	-85	22.01
					16QAM	3	3	15	-85	22.03
16QAM	5	0	0	-85	21.91					
16QAM	5	0	15	-85	22.12					
Mid Range	26365	1882.5	8365	1962.5	QPSK	1	0	0	-85	21.98
					QPSK	1	5	0	-85	21.78
					QPSK	1	0	7	-85	21.76
					QPSK	1	5	7	-85	21.79
					QPSK	1	0	15	-85	21.72
					QPSK	1	5	15	-85	21.67
					QPSK	3	0	0	-85	21.78
					QPSK	3	3	15	-85	21.77
					QPSK	6	0	0	-85	21.81
					QPSK	6	0	15	-85	21.86
					16QAM	1	0	0	-85	21.88
					16QAM	1	5	0	-85	21.82
					16QAM	1	0	7	-85	21.72
					16QAM	1	5	7	-85	21.71
					16QAM	1	0	15	-85	21.69
					16QAM	1	5	15	-85	21.81
					16QAM	3	0	0	-85	21.65
					16QAM	3	3	15	-85	21.67
16QAM	5	0	0	-85	21.88					
16QAM	5	0	15	-85	21.78					
High Range	26590	1905	8590	1985	QPSK	1	0	0	-85	22.25
					QPSK	1	5	0	-85	22.21
					QPSK	1	0	7	-85	22.06
					QPSK	1	5	7	-85	22.07
					QPSK	1	0	15	-85	22.17
					QPSK	1	5	15	-85	22.18
					QPSK	3	0	0	-85	22.03
					QPSK	3	3	15	-85	22.12
					QPSK	6	0	0	-85	21.99
					QPSK	6	0	15	-85	22.21
					16QAM	1	0	0	-85	22.15
					16QAM	1	5	0	-85	22.16
					16QAM	1	0	7	-85	21.91
					16QAM	1	5	7	-85	22.01
					16QAM	1	0	15	-85	22.12
					16QAM	1	5	15	-85	22.12
					16QAM	3	0	0	-85	21.98
					16QAM	3	3	15	-85	22.04
16QAM	5	0	0	-85	21.92					
16QAM	5	0	15	-85	22.12					

EIRP Power (dBm)

LTE Band 25							
Channel Bandwidth: 5 MHz / QPSK							
Plane	Channel	Frequency (MHz)	Reading (dBm)	Correction Factor (dB)	EIRP (dBm)	EIRP (mW)	Polarization (H/V)
Z	26065	1852.5	-19.79	36.57	16.78	47.64	H
	26365	1882.5	-20.28	37.22	16.94	49.43	
	26665	1912.5	-21.20	38.11	16.91	49.09	
	26065	1852.5	-15.07	37.65	22.58	181.13	V
	26365	1882.5	-14.64	37.58	22.94	196.79	
	26665	1912.5	-15.29	37.96	22.67	184.93	
Channel Bandwidth: 5 MHz / 16QAM							
Z	26065	1852.5	-20.88	36.57	15.69	37.07	H
	26365	1882.5	-21.35	37.22	15.87	38.64	
	26665	1912.5	-22.34	38.11	15.77	37.76	
	26065	1852.5	-16.22	37.65	21.43	139.00	V
	26365	1882.5	-15.54	37.58	22.04	159.96	
	26665	1912.5	-16.14	37.96	21.82	152.05	

Note: EIRP (dBm) = Reading (dBm) + Correction Factor (dB)

LTE Band 25							
Channel Bandwidth: 10 MHz / QPSK							
Plane	Channel	Frequency (MHz)	Reading (dBm)	Correction Factor (dB)	EIRP (dBm)	EIRP (mW)	Polarization (H/V)
Z	26090	1855.0	-19.56	36.57	17.01	50.23	H
	26365	1882.5	-19.97	37.22	17.25	53.09	
	26640	1910.0	-21.02	38.19	17.17	52.12	
	26090	1855.0	-14.84	37.65	22.81	190.99	V
	26365	1882.5	-14.43	37.58	23.15	206.54	
	26640	1910.0	-15.22	38.15	22.93	196.34	
Channel Bandwidth: 10 MHz / 16QAM							
Z	26090	1855.0	-20.60	36.57	15.97	39.54	H
	26365	1882.5	-21.06	37.22	16.16	41.30	
	26640	1910.0	-22.18	38.19	16.01	39.90	
	26090	1855.0	-15.94	37.65	21.71	148.25	V
	26365	1882.5	-15.26	37.58	22.32	170.61	
	26640	1910.0	-16.07	38.15	22.08	161.44	

Note: EIRP (dBm) = Reading (dBm) + Correction Factor (dB)

LTE Band 25							
Channel Bandwidth: 15 MHz / QPSK							
Plane	Channel	Frequency (MHz)	Reading (dBm)	Correction Factor (dB)	EIRP (dBm)	EIRP (mW)	Polarization (H/V)
Z	26115	1857.5	-19.22	36.57	17.35	54.33	H
	26365	1882.5	-19.63	37.22	17.59	57.41	
	26615	1907.5	-20.82	38.23	17.41	55.08	
	26115	1857.5	-14.48	37.65	23.17	207.49	V
	26365	1882.5	-14.15	37.58	23.43	220.29	
	26615	1907.5	-14.97	38.22	23.25	211.35	
Channel Bandwidth: 15 MHz / 16QAM							
Z	26115	1857.5	-20.30	36.57	16.27	42.36	H
	26365	1882.5	-20.85	37.22	16.37	43.35	
	26615	1907.5	-21.92	38.23	16.31	42.76	
	26115	1857.5	-15.70	37.65	21.95	156.68	V
	26365	1882.5	-15.06	37.58	22.52	178.65	
	26615	1907.5	-15.91	38.22	22.31	170.22	

Note: EIRP (dBm) = Reading (dBm) + Correction Factor (dB)

LTE Band 25							
Channel Bandwidth: 20 MHz / QPSK							
Plane	Channel	Frequency (MHz)	Reading (dBm)	Correction Factor (dB)	EIRP (dBm)	EIRP (mW)	Polarization (H/V)
Z	26140	1860.0	-18.95	36.57	17.62	57.81	H
	26365	1882.5	-19.38	37.22	17.84	60.81	
	26590	1905.0	-20.99	38.72	17.73	59.29	
	26140	1860.0	-14.24	37.65	23.41	219.28	V
	26365	1882.5	-13.89	37.58	23.69	233.88	
	26590	1905.0	-13.98	37.56	23.58	228.03	
Channel Bandwidth: 20 MHz / 16QAM							
Z	26140	1860.0	-20.10	36.57	16.47	44.36	H
	26365	1882.5	-20.52	37.22	16.70	46.77	
	26590	1905.0	-22.20	38.72	16.52	44.87	
	26140	1860.0	-15.48	37.65	22.17	164.82	V
	26365	1882.5	-14.83	37.58	22.75	188.36	
	26590	1905.0	-15.01	37.56	22.55	179.89	

Note: EIRP (dBm) = Reading (dBm) + Correction Factor (dB)

4.2 Modulation Characteristics Measurement

4.2.1 Limits of Modulation Characteristics

N/A

4.2.2 Test Setup



4.2.3 Test Procedure

Connect the EUT to Communication Simulator via the antenna connector. The frequency band is set as EUT supported Modulation and Channels, the EUT output is matched with 50 ohm load, the waveform quality and constellation of the EUT was tested.

4.2.4 Test Results

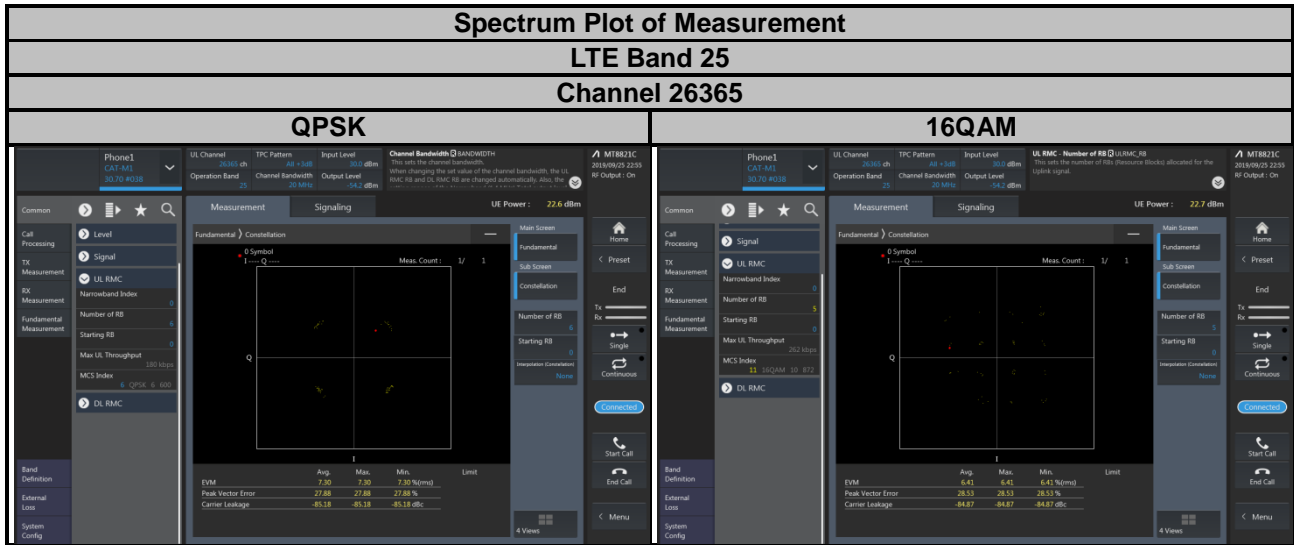

4.3 Frequency Stability Measurement

4.3.1 Limits of Frequency Stability Measurement

The frequency stability shall be sufficient to ensure that the fundamental emission stays within the authorized frequency block.

4.3.2 Test Procedure

- a. Device is placed at the oven room. The oven room could control the temperatures and humidity. Power warm up is at least 15 min and power applied should perform before recording frequency error.
- b. EUT is connected the external power supply to control the DC input power. The test voltage range is from minimum to maximum working voltage. Each step shall be record the frequency error rate.
- c. The temperature range step is 10 degrees in this test items. All temperature levels shall be hold the $\pm 0.5^{\circ}\text{C}$ during the measurement testing. The each temperature step shall be at least 0.5 hours, consider the EUT could be test under the stability condition.

NOTE: The frequency error was recorded frequency error from the communication simulator.

4.3.3 Test Setup

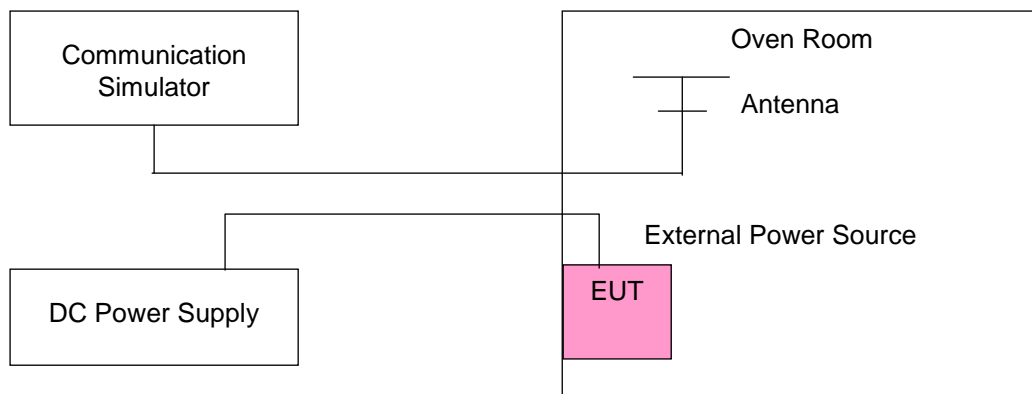

4.3.4 Test Results

Frequency Error vs. Voltage

Voltage (Volts)	LTE Band 25			
	Channel Bandwidth: 5 MHz			
	Low Channel		High Channel	
	Frequency (MHz)	Frequency Error (ppm)	Frequency (MHz)	Frequency Error (ppm)
3.8	1850.700004	0.002	1914.300003	0.001
3.6	1850.700002	0.001	1914.300004	0.002
4.35	1850.700003	0.002	1914.300001	0.001

Note: The applicant defined the normal working voltage of the battery is from 3.6 Vdc to 4.35 Vdc.

Frequency Error vs. Temperature

Temp. (°C)	LTE Band 25			
	Channel Bandwidth: 5 MHz			
	Low Channel		High Channel	
	Frequency (MHz)	Frequency Error (ppm)	Frequency (MHz)	Frequency Error (ppm)
-30	1850.700002	0.001	1914.300004	0.002
-20	1850.700004	0.002	1914.300002	0.001
-10	1850.700001	0.001	1914.300002	0.001
0	1850.700003	0.002	1914.300001	0.001
10	1850.700003	0.002	1914.300003	0.001
20	1850.699998	-0.001	1914.299997	-0.002
30	1850.699998	-0.001	1914.299997	-0.002
40	1850.699997	-0.002	1914.299998	-0.001
50	1850.699999	-0.001	1914.299998	-0.001
60	1850.699998	-0.001	1914.299996	-0.002
70	1850.699997	-0.002	1914.299999	-0.001
80	1850.699997	-0.002	1914.299999	-0.001
85	1850.699997	-0.002	1914.299998	-0.001

Frequency Error vs. Voltage

Voltage (Volts)	LTE Band 25			
	Channel Bandwidth: 10 MHz			
	Low Channel		High Channel	
	Frequency (MHz)	Frequency Error (ppm)	Frequency (MHz)	Frequency Error (ppm)
3.8	1850.700003	0.002	1914.300003	0.002
3.6	1850.700004	0.002	1914.300002	0.001
4.35	1850.700003	0.002	1914.300001	0.001

Note: The applicant defined the normal working voltage of the battery is from 3.6 Vdc to 4.35 Vdc.

Frequency Error vs. Temperature

Temp. (°C)	LTE Band 25			
	Channel Bandwidth: 10 MHz			
	Low Channel		High Channel	
	Frequency (MHz)	Frequency Error (ppm)	Frequency (MHz)	Frequency Error (ppm)
-30	1850.700002	0.001	1914.300004	0.002
-20	1850.700004	0.002	1914.300003	0.002
-10	1850.700003	0.002	1914.300004	0.002
0	1850.700001	0.001	1914.300001	0.001
10	1850.700003	0.002	1914.300003	0.001
20	1850.699997	-0.001	1914.299997	-0.002
30	1850.699998	-0.001	1914.299998	-0.001
40	1850.699998	-0.001	1914.299998	-0.001
50	1850.699996	-0.002	1914.299997	-0.002
60	1850.699996	-0.002	1914.299997	-0.001
70	1850.699998	-0.001	1914.299997	-0.002
80	1850.699996	-0.002	1914.299998	-0.001
85	1850.699998	-0.001	1914.299998	-0.001

Frequency Error vs. Voltage

Voltage (Volts)	LTE Band 25			
	Channel Bandwidth: 15 MHz			
	Low Channel		High Channel	
	Frequency (MHz)	Frequency Error (ppm)	Frequency (MHz)	Frequency Error (ppm)
3.8	1850.700004	0.002	1914.300003	0.002
3.6	1850.700001	0.001	1914.300003	0.001
4.35	1850.700001	0.001	1914.300003	0.001

Note: The applicant defined the normal working voltage of the battery is from 3.6 Vdc to 4.35 Vdc.

Frequency Error vs. Temperature

Temp. (°C)	LTE Band 25			
	Channel Bandwidth: 15 MHz			
	Low Channel		High Channel	
	Frequency (MHz)	Frequency Error (ppm)	Frequency (MHz)	Frequency Error (ppm)
-30	1850.700002	0.001	1914.300003	0.002
-20	1850.700001	0.001	1914.300002	0.001
-10	1850.700001	0.001	1914.300003	0.002
0	1850.700002	0.001	1914.300004	0.002
10	1850.700002	0.001	1914.300003	0.002
20	1850.699998	-0.001	1914.299999	-0.001
30	1850.699998	-0.001	1914.299998	-0.001
40	1850.699997	-0.001	1914.299998	-0.001
50	1850.699998	-0.001	1914.299998	-0.001
60	1850.699998	-0.001	1914.299997	-0.002
70	1850.699996	-0.002	1914.299998	-0.001
80	1850.699997	-0.002	1914.299997	-0.002
85	1850.699997	-0.002	1914.299999	-0.001

Frequency Error vs. Voltage

Voltage (Volts)	LTE Band 25			
	Channel Bandwidth: 20 MHz			
	Low Channel		High Channel	
	Frequency (MHz)	Frequency Error (ppm)	Frequency (MHz)	Frequency Error (ppm)
3.8	1850.700001	0.001	1914.300003	0.002
3.6	1850.700002	0.001	1914.300004	0.002
4.35	1850.700002	0.001	1914.300003	0.001

Note: The applicant defined the normal working voltage of the battery is from 3.6 Vdc to 4.35 Vdc.

Frequency Error vs. Temperature

Temp. (°C)	LTE Band 25			
	Channel Bandwidth: 20 MHz			
	Low Channel		High Channel	
	Frequency (MHz)	Frequency Error (ppm)	Frequency (MHz)	Frequency Error (ppm)
-30	1850.700002	0.001	1914.300003	0.002
-20	1850.700003	0.001	1914.300003	0.002
-10	1850.700002	0.001	1914.300003	0.001
0	1850.700003	0.001	1914.300003	0.002
10	1850.700003	0.002	1914.300002	0.001
20	1850.699997	-0.002	1914.299998	-0.001
30	1850.699998	-0.001	1914.299997	-0.002
40	1850.699998	-0.001	1914.299998	-0.001
50	1850.699999	-0.001	1914.299999	-0.001
60	1850.699997	-0.002	1914.299997	-0.002
70	1850.699999	-0.001	1914.299996	-0.002
80	1850.699997	-0.002	1914.299996	-0.002
85	1850.699998	-0.001	1914.299998	-0.001

4.4 Occupied Bandwidth Measurement

4.4.1 Test Procedure

The EUT makes a call to the communication simulator. All measurements were done at low, middle and high operational frequency range. The communication simulator station system controlled a EUT to export maximum output power under transmission mode and specific channel frequency. Use OBW measurement function of Spectrum analyzer to measure 99 % occupied bandwidth.

4.4.2 Test Setup

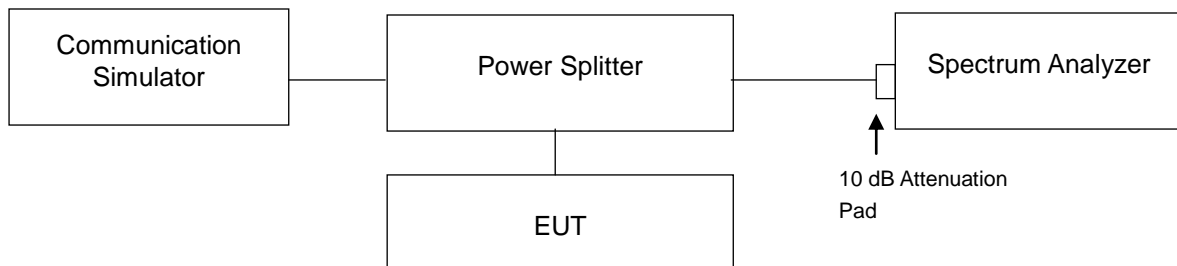

4.4.3 Test Result

LTE Band 25					
Channel Bandwidth: 5 MHz					
Channel	Frequency (MHz)	99 % Occupied Bandwidth (MHz)		26 dB Bandwidth (MHz)	
		QPSK	16QAM	QPSK	16QAM
26065	1852.5	1.0918	0.9165	1.402	1.307
26365	1882.5	1.0978	0.9259	1.377	1.299
26665	1912.5	1.0918	0.9095	1.386	1.267
Channel Bandwidth: 10 MHz					
Channel	Frequency (MHz)	99 % Occupied Bandwidth (MHz)		26 dB Bandwidth (MHz)	
		QPSK	16QAM	QPSK	16QAM
26090	1855.0	1.0854	0.9149	1.361	1.340
26365	1882.5	1.0889	0.9138	1.373	1.293
26640	1910.0	1.0895	0.9141	1.335	1.335

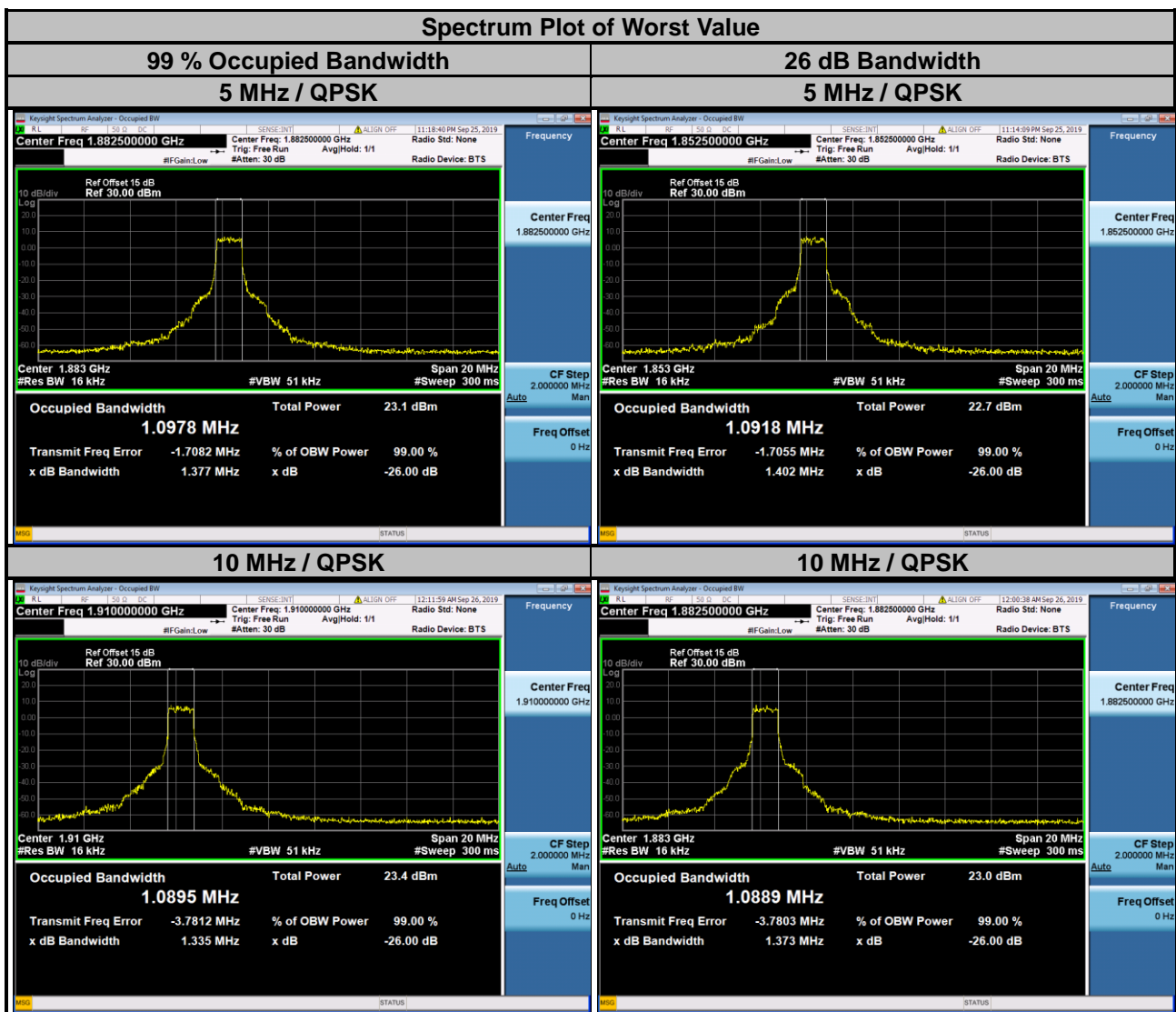

LTE Band 25					
Channel Bandwidth: 15 MHz					
Channel	Frequency (MHz)	99 % Occupied Bandwidth (MHz)		26 dB Bandwidth (MHz)	
		QPSK	16QAM	QPSK	16QAM
26115	1857.5	1.0920	0.9286	1.424	1.405
26365	1882.5	1.0951	0.9200	1.427	1.365
26615	1907.5	1.0970	0.9249	1.384	1.394

Channel Bandwidth: 20 MHz					
Channel	Frequency (MHz)	99 % Occupied Bandwidth (MHz)		26 dB Bandwidth (MHz)	
		QPSK	16QAM	QPSK	16QAM
26140	1860.0	1.0941	0.9168	1.412	1.398
26365	1882.5	1.0911	0.9153	1.392	1.366
26590	1905.0	1.0906	0.9157	1.365	1.356

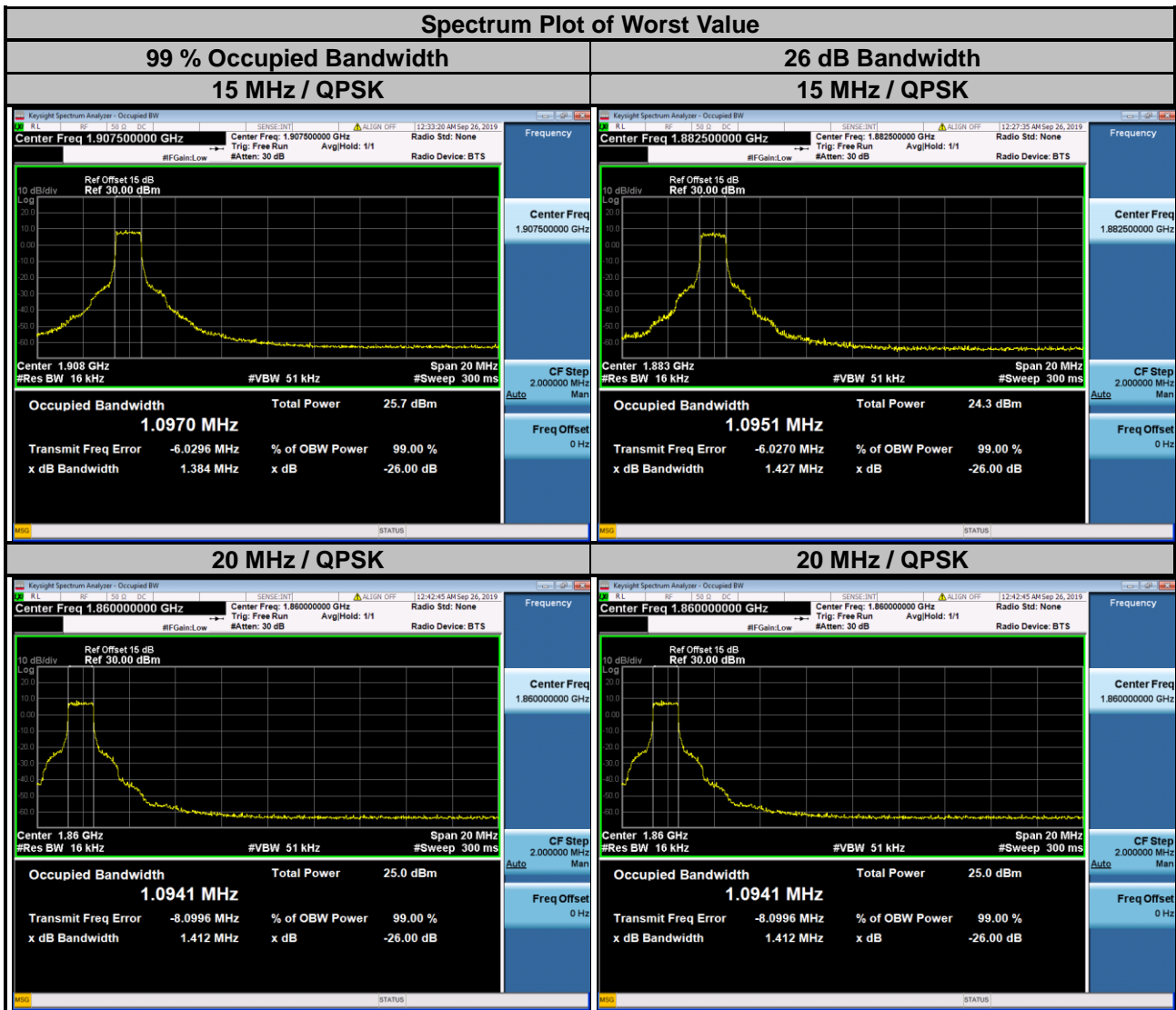

4.5 Band Edge Measurement

4.5.1 Limits of Band Edge Measurement

Power of any emission outside of the authorized operating frequency ranges must be attenuated below the transmitting power (P) by a factor of at least $43 + 10 \log(P)$ dB. In the 1 MHz bands immediately outside and adjacent to the frequency block a resolution bandwidth of at least one percent of the emission bandwidth of the fundamental emission of the transmitter may be employed.

4.5.2 Test Setup

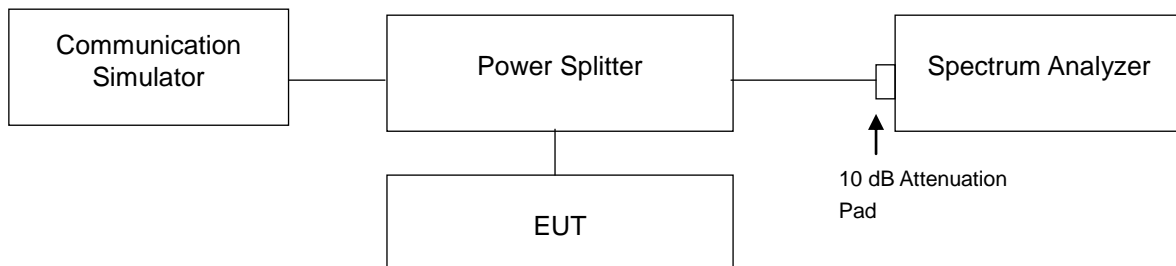

4.5.3 Test Procedures

- All measurements were done at low and high operational frequency range.
- The center frequency of spectrum is the band edge frequency and span is 1 MHz. RB of the spectrum is 62 kHz and VB of the spectrum is 200 kHz (LTE Bandwidth 5 MHz).
- The center frequency of spectrum is the band edge frequency and span is 1 MHz. RB of the spectrum is 100 kHz and VB of the spectrum is 300 kHz (LTE Bandwidth 10 MHz).
- The center frequency of spectrum is the band edge frequency and span is 1 MHz. RB of the spectrum is 150 kHz and VB of the spectrum is 470 kHz (LTE Bandwidth 15 MHz).
- The center frequency of spectrum is the band edge frequency and span is 1 MHz. RB of the spectrum is 200 kHz and VB of the spectrum is 1 MHz (LTE Bandwidth 20 MHz).
- Record the max trace plot into the test report.

4.5.4 Test Results

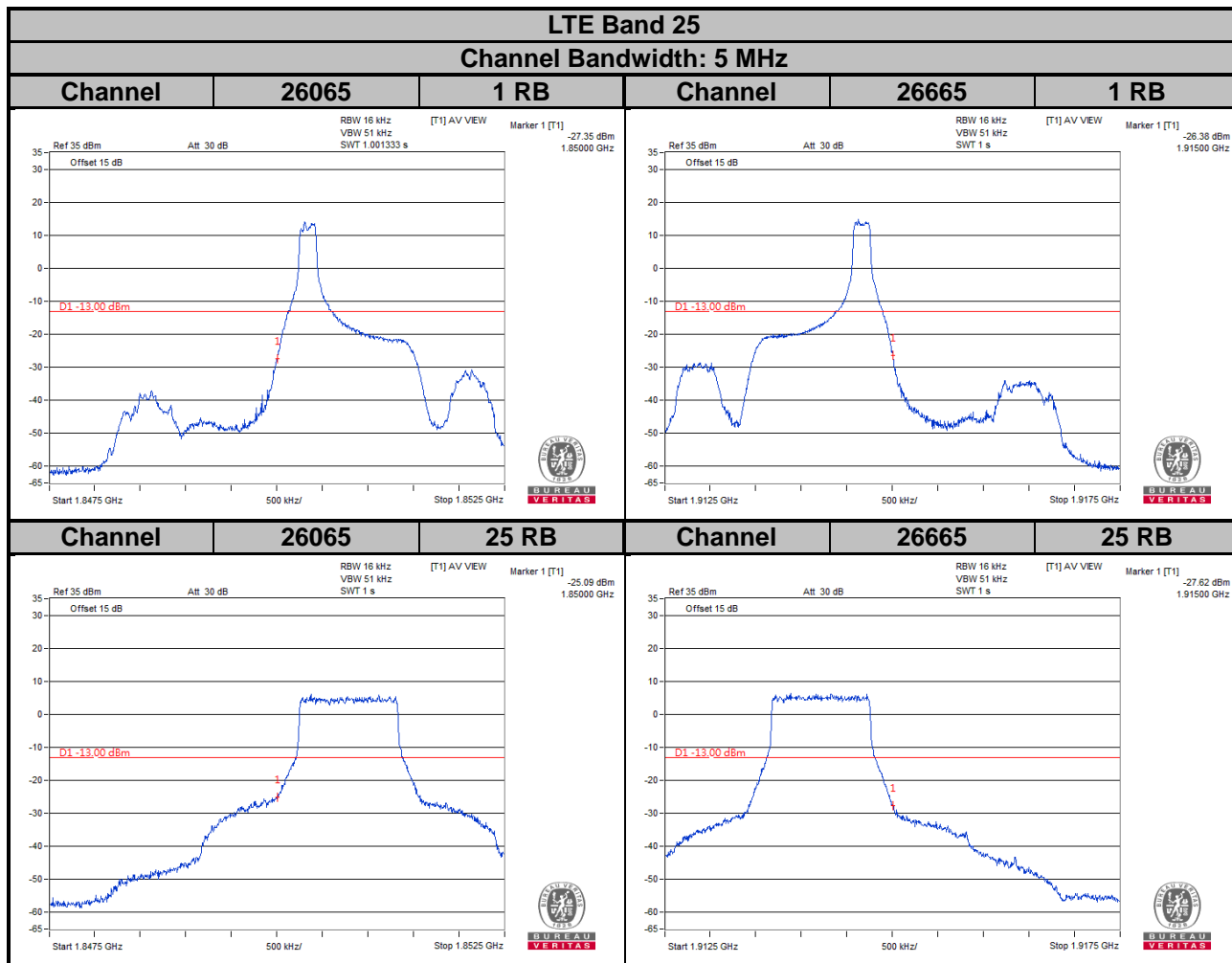

LTE Band 25
Channel Bandwidth: 10 MHz

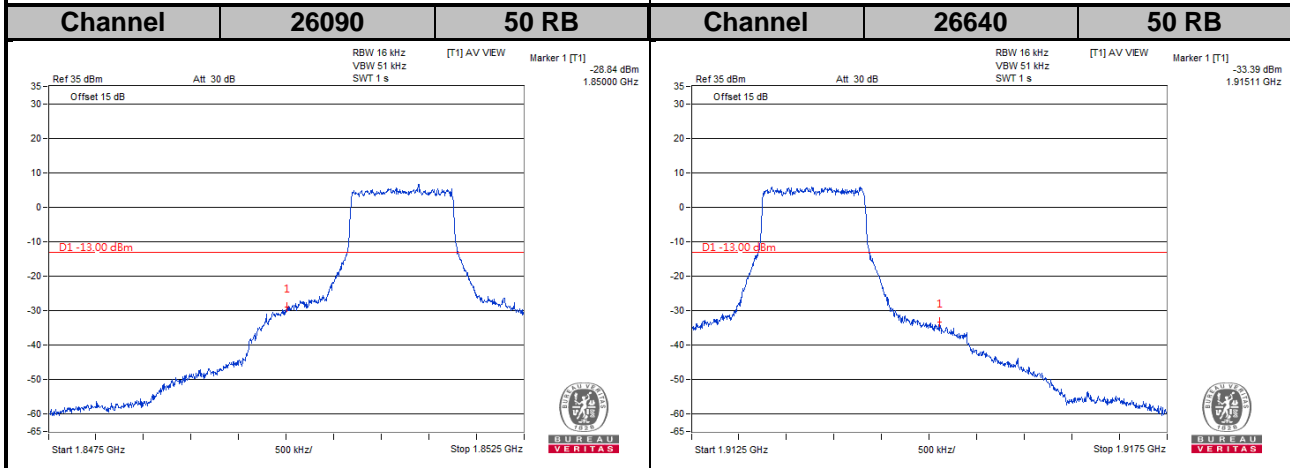
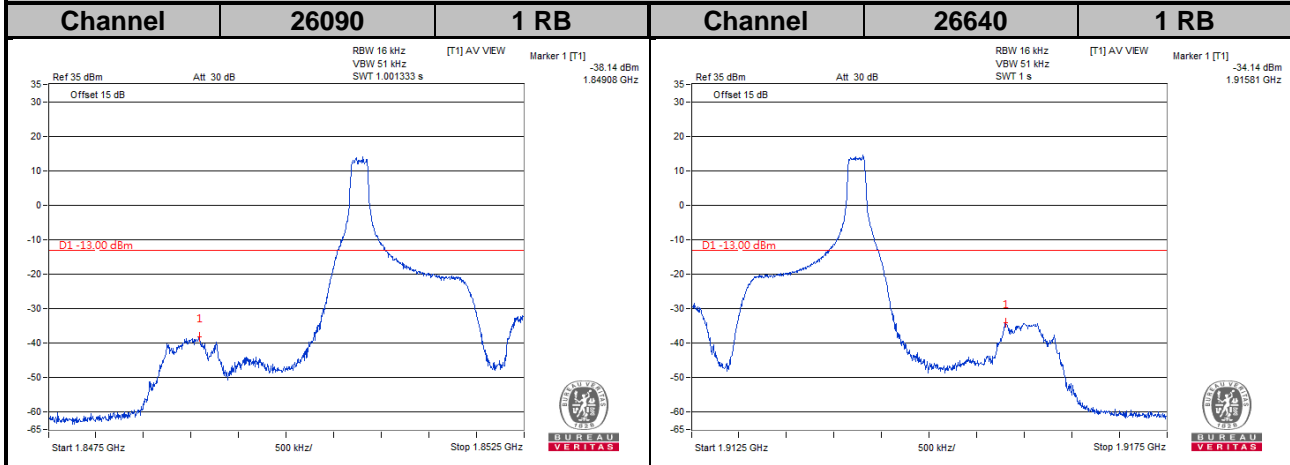

LTE Band 25
Channel Bandwidth: 15 MHz

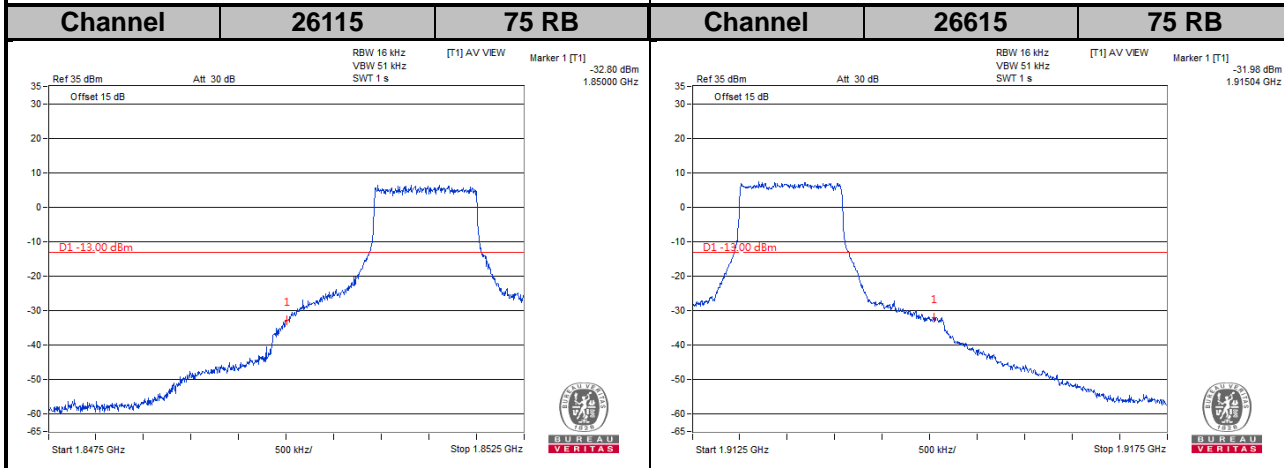
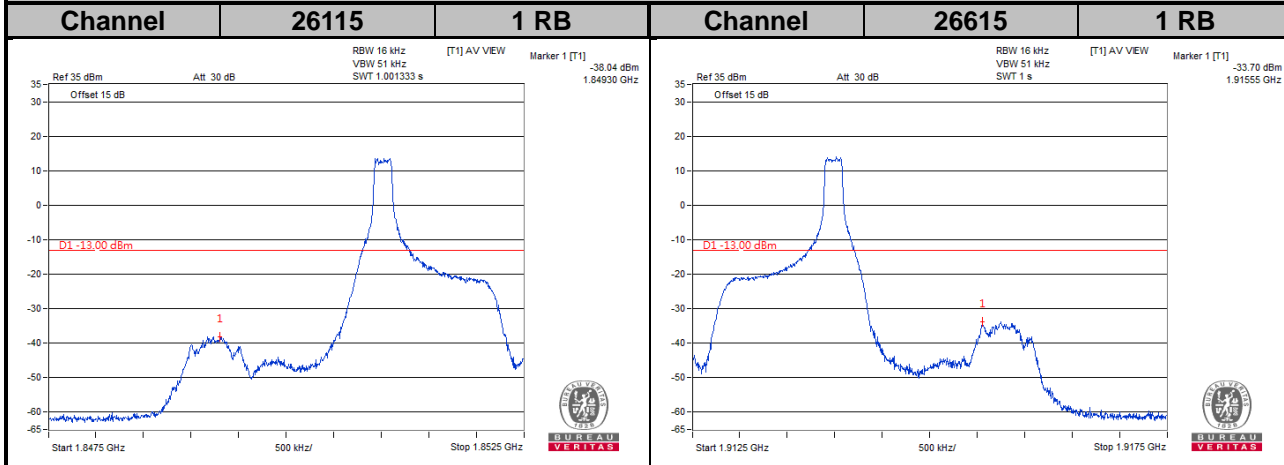

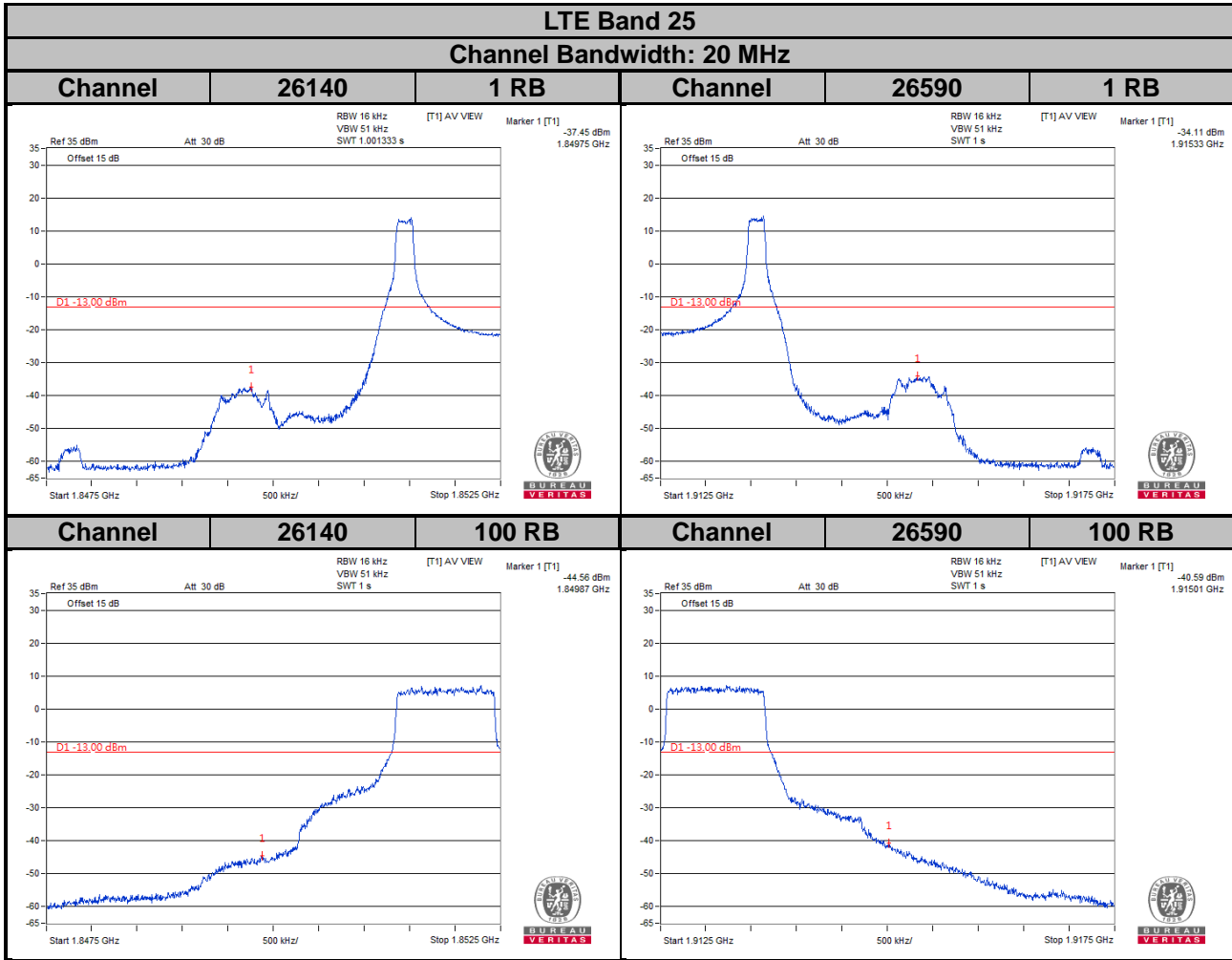

4.6 Peak to Average Ratio

4.6.1 Limits of Peak to Average Ratio Measurement

In measuring transmissions in this band using an average power technique, the peak to-average ratio (PAR) of the transmission may not exceed 13 dB.

4.6.2 Test Setup

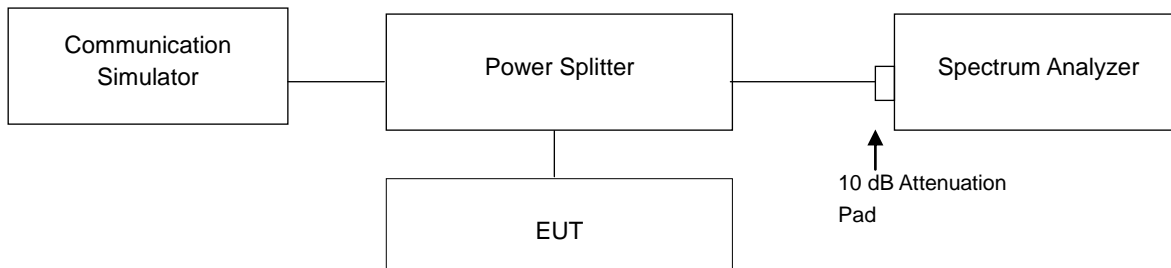

4.6.3 Test Procedures

1. Set resolution/measurement bandwidth \geq signal's occupied bandwidth;
2. Set the number of counts to a value that stabilizes the measured CCDF curve;
3. Record the maximum PAPR level associated with a probability of 0.1 %.

4.6.4 Test Results

LTE Band 25							
Channel Bandwidth: 5 MHz				Channel Bandwidth: 10 MHz			
Channel	Frequency (MHz)	Peak to Average Ratio (dB)		Channel	Frequency (MHz)	Peak to Average Ratio (dB)	
		QPSK	16QAM			QPSK	16QAM
26065	1852.5	4.17	4.62	26090	1855.0	3.94	4.54
26365	1882.5	4.09	4.60	26365	1882.5	4.12	4.65
26665	1912.5	4.21	4.75	26640	1910.0	4.28	4.66

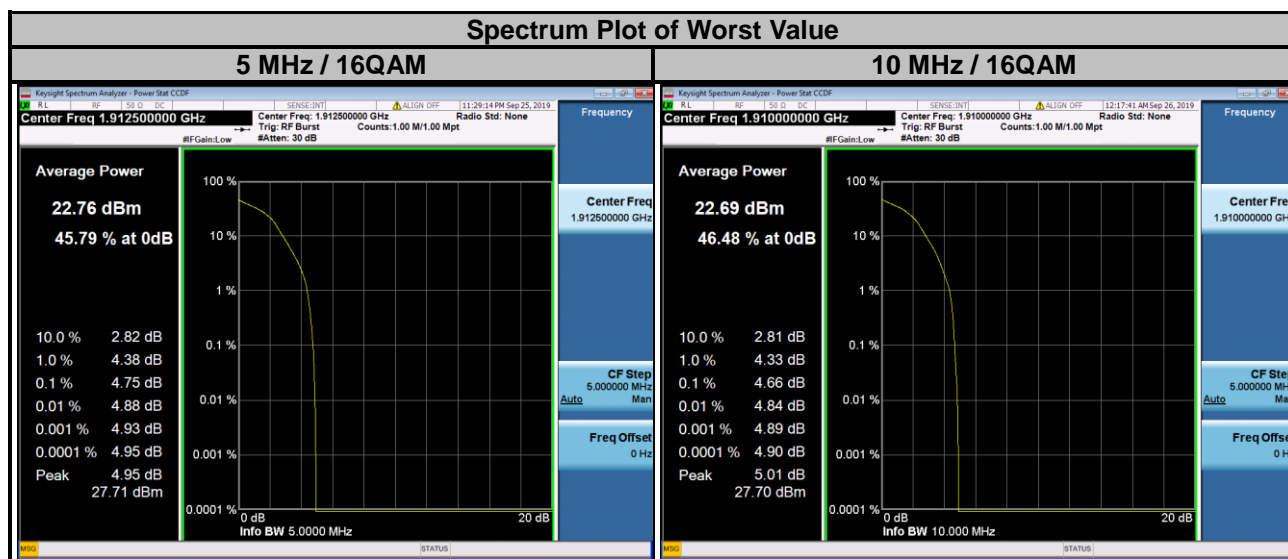

LTE Band 25							
Channel Bandwidth: 15 MHz				Channel Bandwidth: 20 MHz			
Channel	Frequency (MHz)	Peak to Average Ratio (dB)		Channel	Frequency (MHz)	Peak to Average Ratio (dB)	
		QPSK	16QAM			QPSK	16QAM
26115	1857.5	4.18	4.46	26140	1860.0	4.04	4.54
26365	1882.5	4.13	4.64	26365	1882.5	4.20	5.40
26615	1907.5	4.44	4.66	26590	1905.0	5.54	4.68

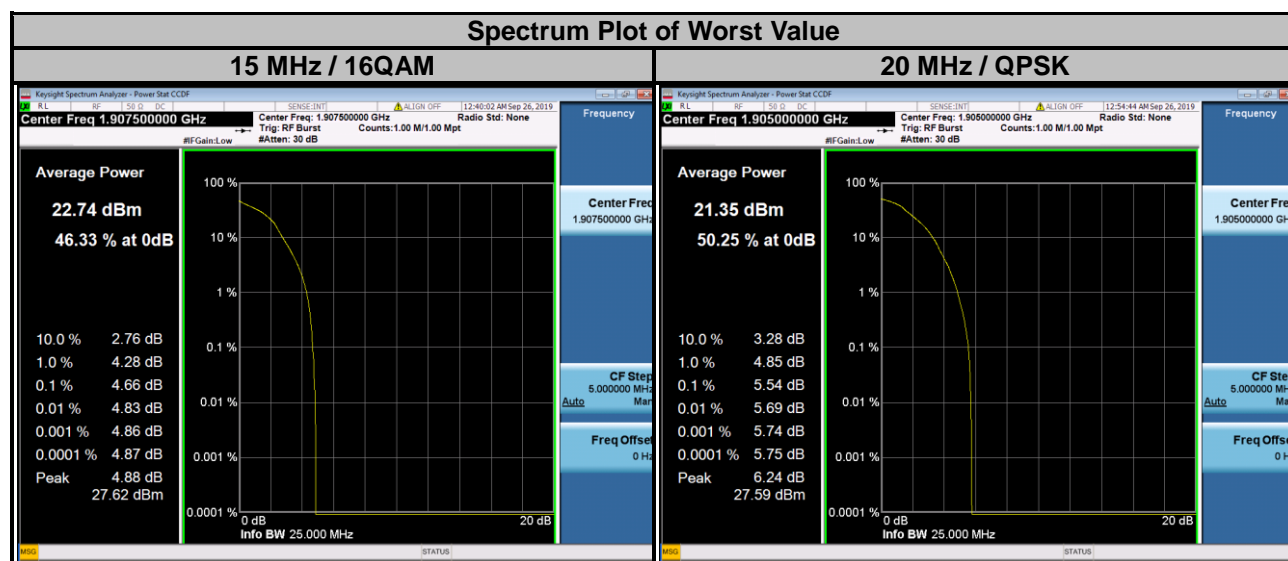

4.7 Conducted Spurious Emissions

4.7.1 Limits of Conducted Spurious Emissions Measurement

The power of any emission outside of the authorized operating frequency ranges must be attenuated below the transmitting power (P) by a factor of at least $43 + 10 \log(P)$ dB. The emission limit equal to -13 dBm.

4.7.2 Test Setup

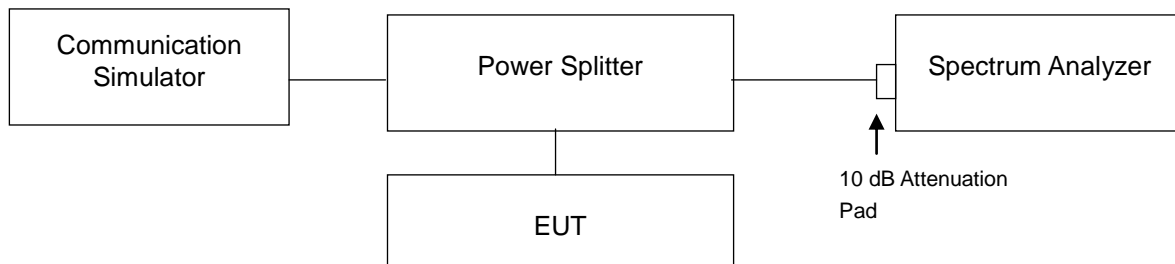

4.7.3 Test Procedure

- The EUT makes a phone call to the communication simulator. All measurements were done at low, middle and high operational frequency range.
- Measuring frequency range is from 9 kHz to 1 GHz. 10 dB attenuation pad is connected with spectrum. RBW = 1 MHz and VBW = 3 MHz is used for conducted emission measurement.
- Measuring frequency range is from 1 GHz to 20 GHz. 10 dB attenuation pad is connected with spectrum. RBW = 1 MHz and VBW = 3 MHz is used for conducted emission measurement.
- Spectrum RBW settings are referenced to ANSI 63.26 section 5.7.2.

4.7.4 Test Results

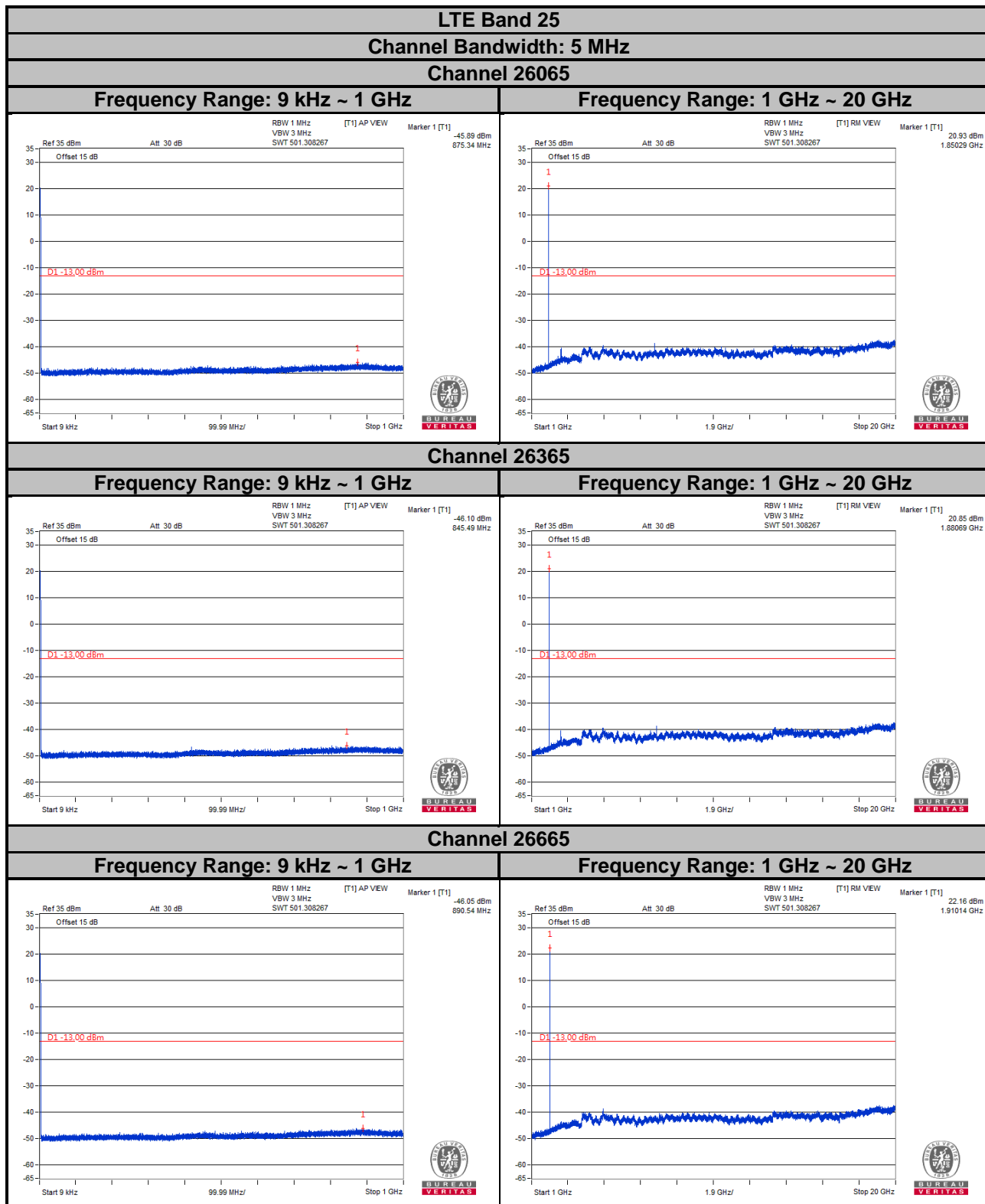

Note: The signal over the limit in 9 kHz is from spectrum analyzer.

LTE Band 25
Channel Bandwidth: 10 MHz

Channel 26090

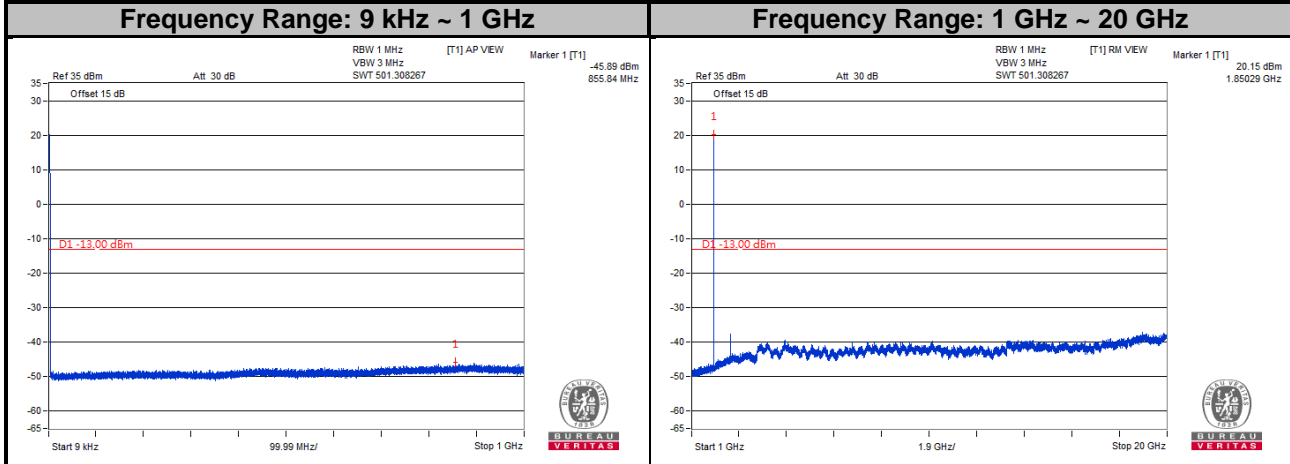

Channel 26365

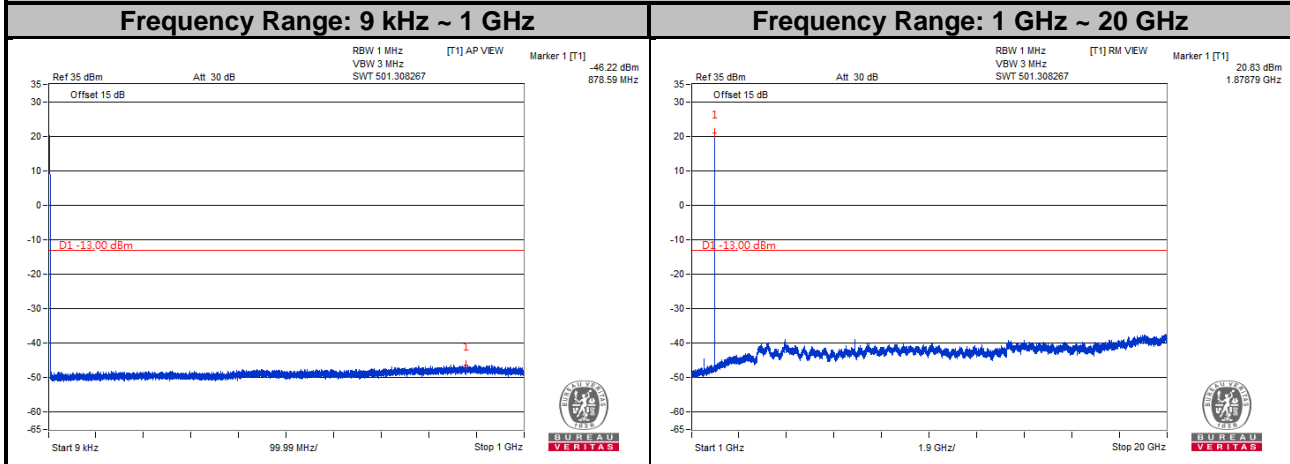

Channel 26640

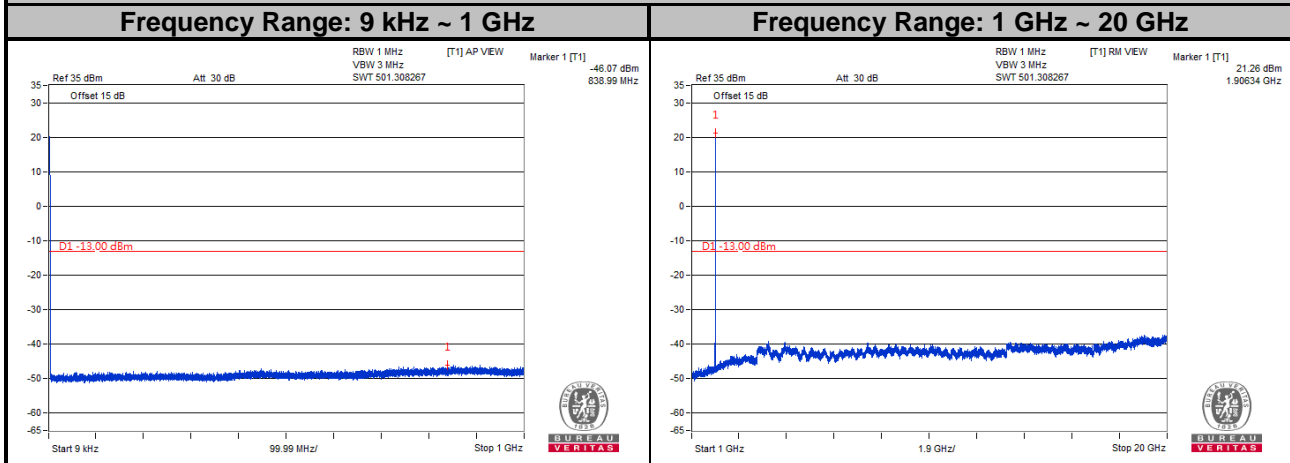

Note: The signal over the limit in 9 kHz is from spectrum analyzer.

LTE Band 25
Channel Bandwidth: 15 MHz

Channel 26115

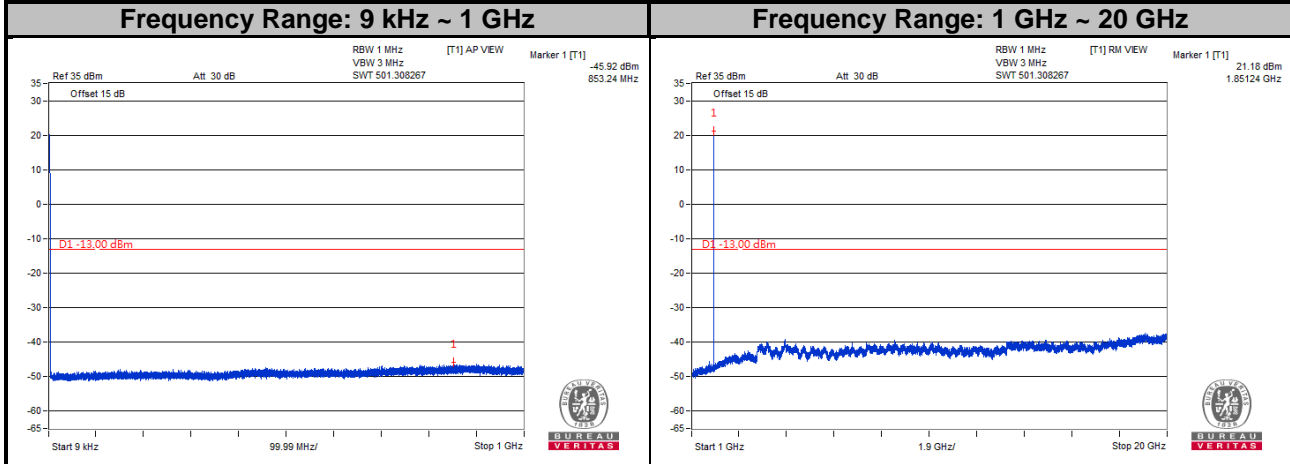

Channel 26365

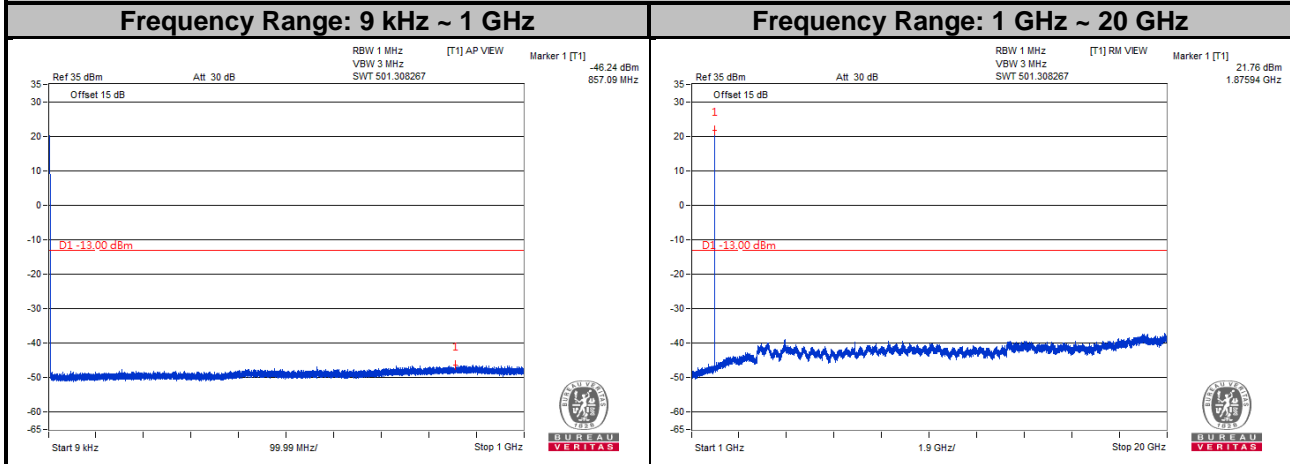

Channel 26615

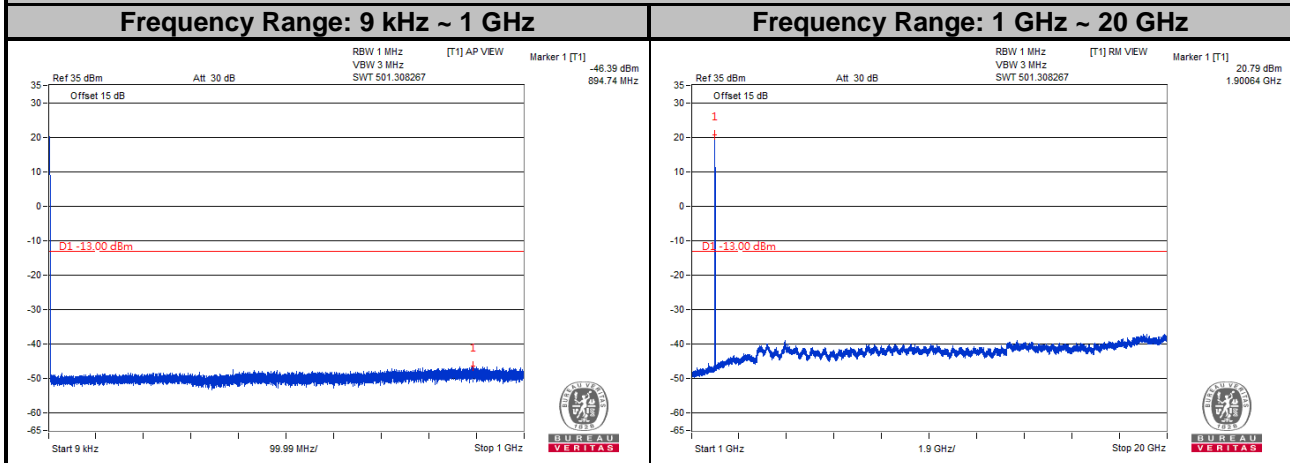

Note: The signal over the limit in 9 kHz is from spectrum analyzer.

LTE Band 25
Channel Bandwidth: 20 MHz

Channel 26140

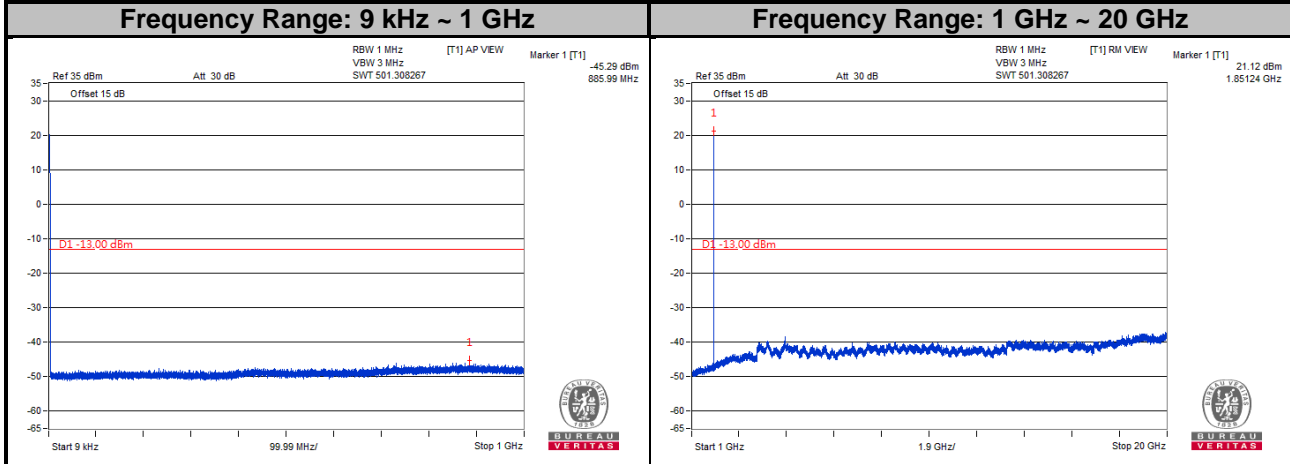

Channel 26365

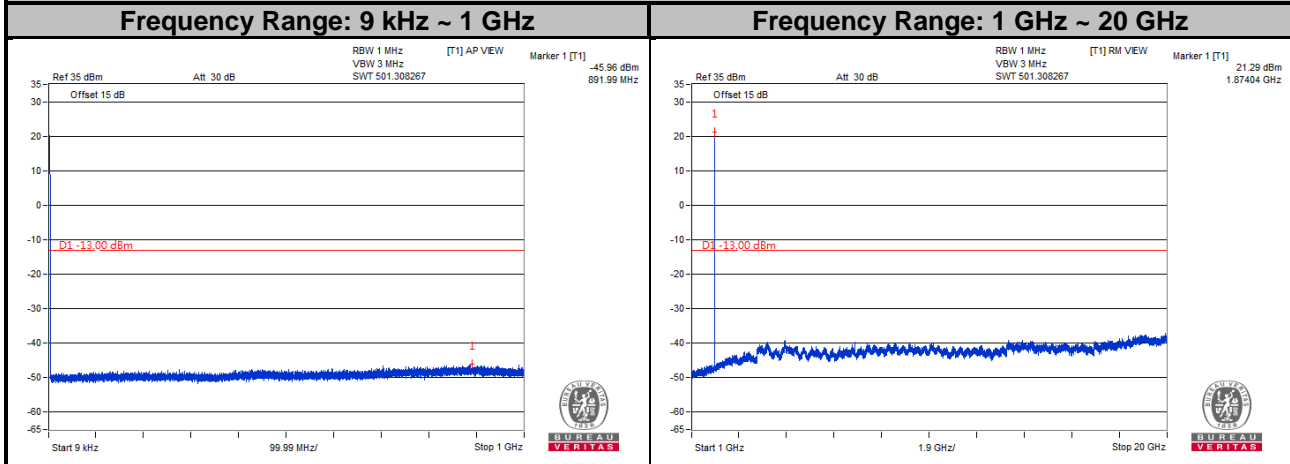

Channel 26590

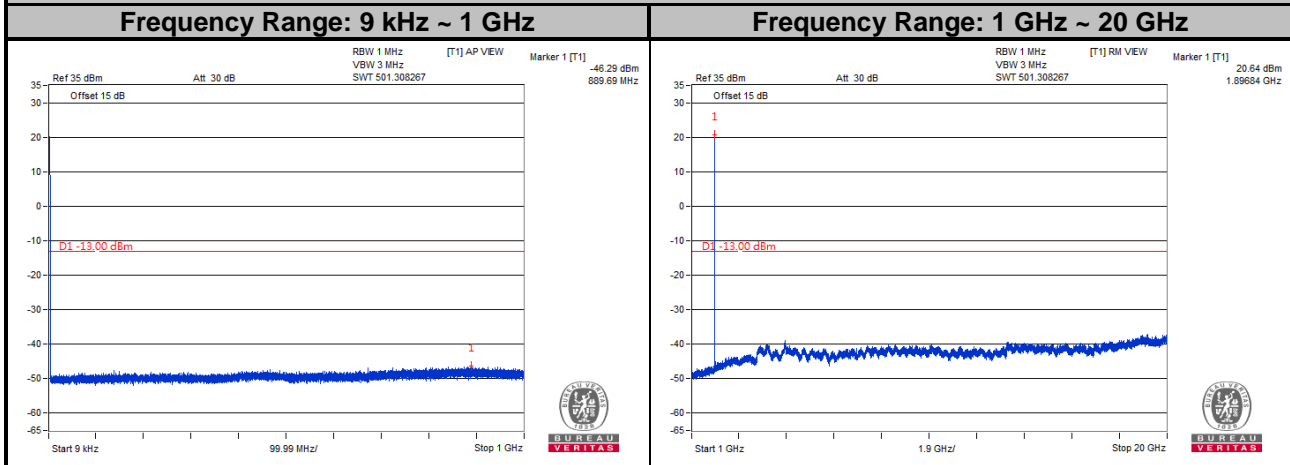

Note: The signal over the limit in 9 kHz is from spectrum analyzer.

4.8 Radiated Emission Measurement

4.8.1 Limits of Radiated Emission Measurement

The power of any emission outside of the authorized operating frequency ranges must be attenuated below the transmitting power (P) by a factor of at least $43 + 10 \log(P)$ dB. The emission limit is equal to -13 dBm.

4.8.2 Test Procedure

- a. Substitution method is used for E.I.R.P measurement. In the semi-anechoic chamber, EUT placed on the 0.8 m (below or equal 1 GHz) and/or 1.5 m (above 1 GHz) height of Turn Table, rotated the table around 360 degrees to search the maximum radiation power and receiver antenna shall be rotated vertical and horizontal polarization and moved height from 1 m to 4 m to find the maximum polar radiated power. The "Read Value" is the spectrum reading the maximum power value.
- b. The substitution horn antenna is substituted for EUT at the same position and signals generator export the CW signal to the substitution antenna via a TX cable. Rotated the Turn Table and moved receiving antenna to find the maximum radiation power. Adjust output power level of S.G to get a Value of spectrum reading equal to "Read Value" of step a. Record the power level of S.G.
- c. EIRP = Output power level of S.G – TX cable loss + Antenna gain of substitution horn.
- d. E.R.P power can be calculated form E.I.R.P power by subtracting the gain of dipole, E.R.P power = E.I.R.P power - 2.15 dB.

NOTE: The resolution bandwidth and video bandwidth of test receiver/spectrum analyzer is 1 MHz/3 MHz.

4.8.3 Deviation from Test Standard

No deviation.

4.8.4 Test Setup

<Radiated Emission below or equal 1 GHz>

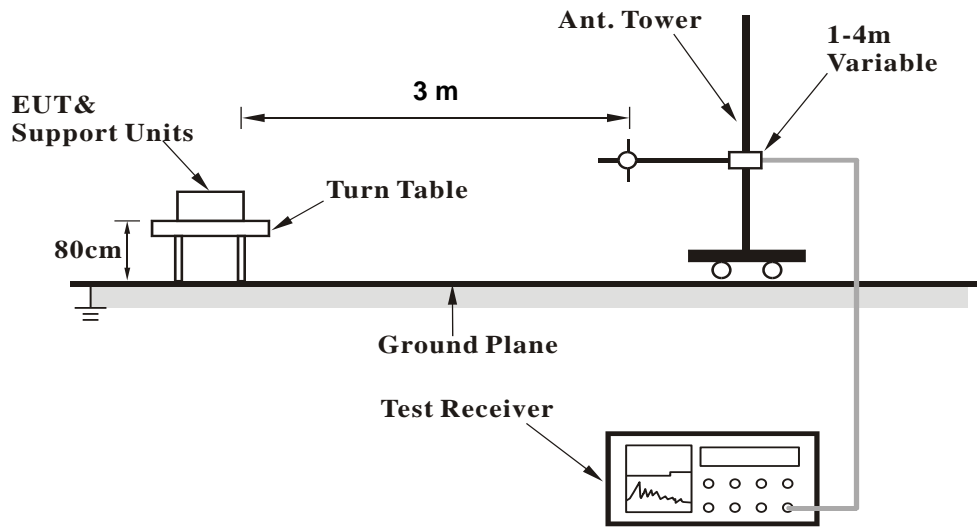

<Radiated Emission above 1 GHz>

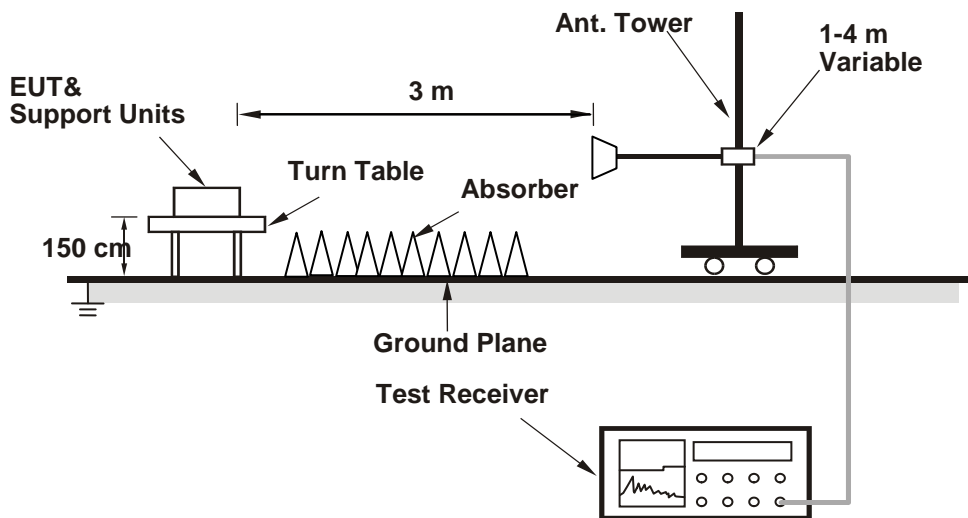

For the actual test configuration, please refer to the attached file (Test Setup Photo).

4.8.5 Test Results

LTE Band 25

Channel Bandwidth: 5 MHz / QPSK

Low Channel



Bureau Veritas Consumer Products Services Ltd., Taoyuan Branch

A D T

Data: 3

Date: 10-01-2019

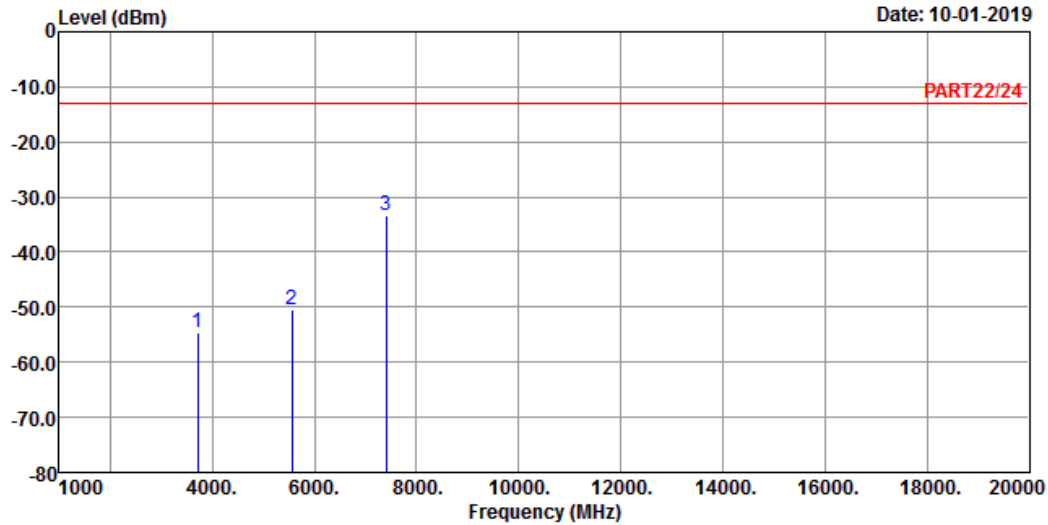

Site : 966 Chamber 5
 Condition: PART22/24 HORIZONTAL
 Remak : Cat-M1 Band 25 QPSK_5M Link_L-CH
 Tested by: Thomas Wei

	Freq	Level	Read Level	Limit	Line Factor	Over Limit	Remark
	MHz	dBm	dBm	dBm	dB	dB	
1	3705.00	-54.71	-47.78	-13.00	-6.93	-41.71	Peak
2	5557.50	-50.48	-48.57	-13.00	-1.91	-37.48	Peak
3 pp	7410.00	-33.26	-37.39	-13.00	4.13	-20.26	Peak



A D T

Data: 4

Date: 10-01-2019

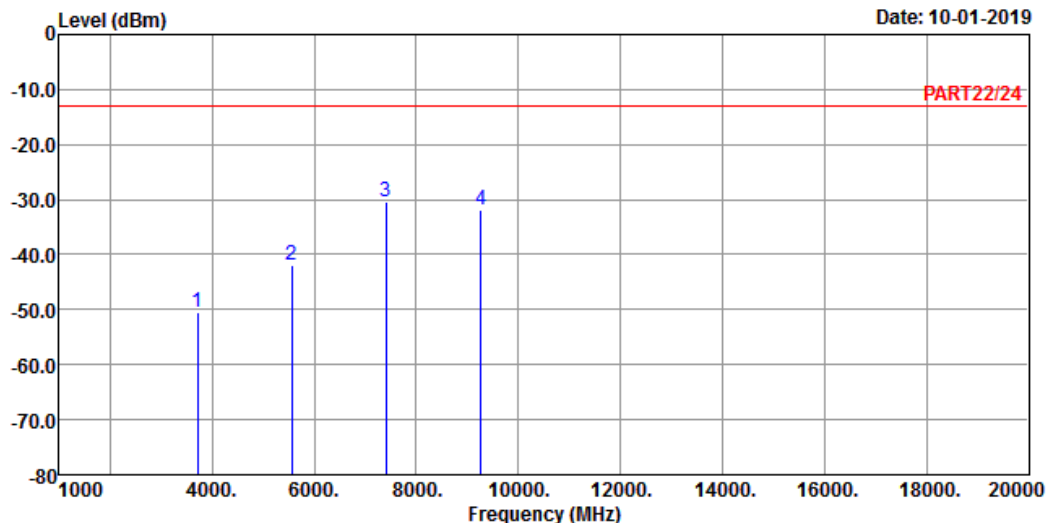

Site : 966 Chamber 5
 Condition: PART22/24 VERTICAL
 Remak : Cat-M1 Band 25 QPSK_5M Link_L-CH
 Tested by: Thomas Wei

	Freq	Level	Read Level	Limit Line	Factor	Over Limit	Remark
	MHz	dBm	dBm	dBm	dB	dB	
1	3705.00	-50.55	-43.62	-13.00	-6.93	-37.55	Peak
2	5557.50	-41.79	-39.88	-13.00	-1.91	-28.79	Peak
3 pp	7410.00	-30.47	-34.60	-13.00	4.13	-17.47	Peak
4	9262.50	-31.78	-36.68	-13.00	4.90	-18.78	Peak

Middle Channel



Bureau Veritas Consumer Products Services Ltd., Taoyuan Branch

A D T

Data: 3

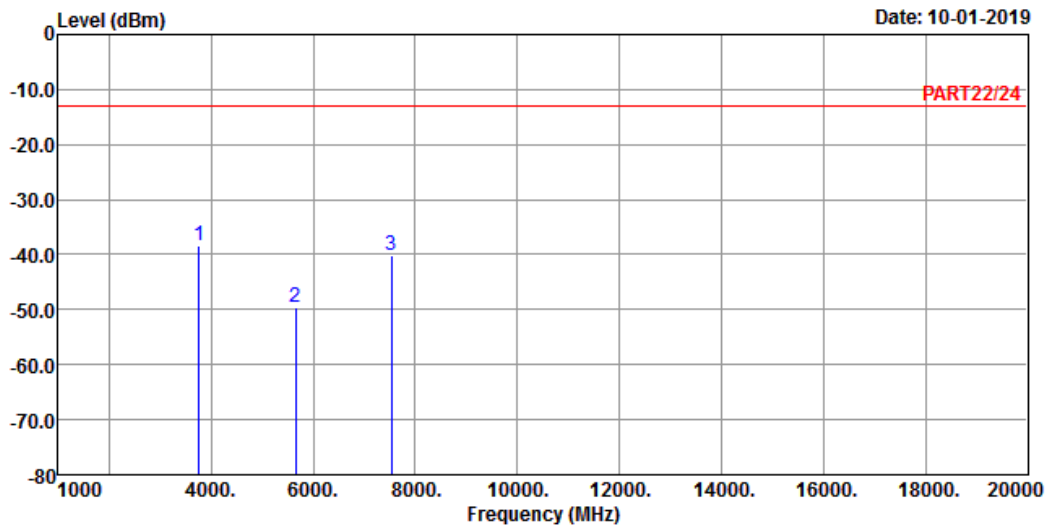

Site : 966 Chamber 5
 Condition: PART22/24 HORIZONTAL
 Remak : Cat-M1 Band 25 QPSK_5M Link_M-CH
 Tested by: Thomas Wei

	Freq	Level	Read Level	Limit	Line Factor	Over Limit	Remark
	MHz	dBm	dBm	dBm	dB	dB	
1 pp	3765.00	-38.25	-31.65	-13.00	-6.60	-25.25	Peak
2	5647.50	-49.68	-47.85	-13.00	-1.83	-36.68	Peak
3	7530.00	-40.03	-44.31	-13.00	4.28	-27.03	Peak



Bureau Veritas Consumer Products Services Ltd., Taoyuan Branch

A D T

Data: 4

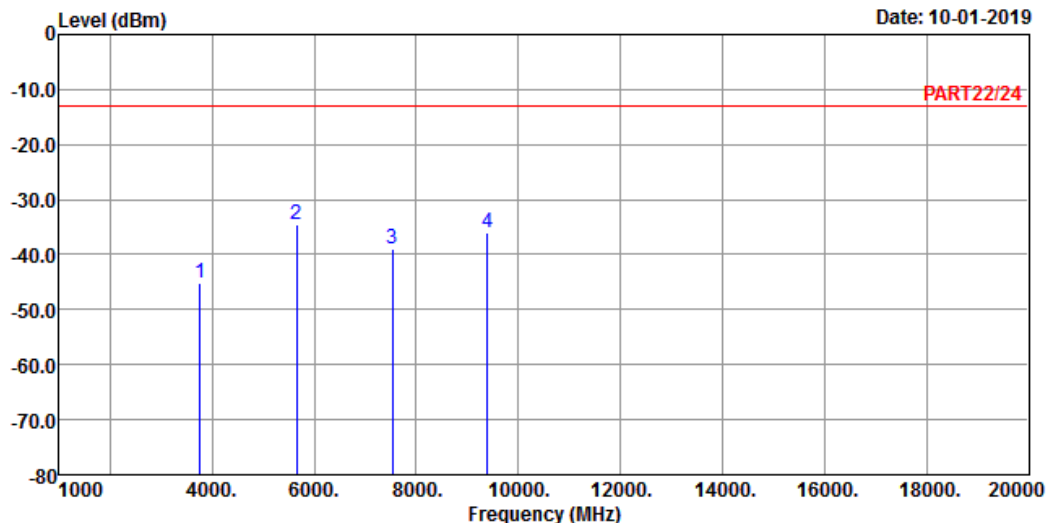

Site : 966 Chamber 5
 Condition: PART22/24 VERTICAL
 Remak : Cat-M1 Band 25 QPSK_5M Link_M-CH
 Tested by: Thomas Wei

	Freq	Level	Read Level	Limit Line	Factor	Over Limit	Remark
	MHz	dBm	dBm	dBm	dB	dB	
1	3765.00	-45.11	-38.51	-13.00	-6.60	-32.11	Peak
2 pp	5647.50	-34.57	-32.74	-13.00	-1.83	-21.57	Peak
3	7530.00	-38.82	-43.10	-13.00	4.28	-25.82	Peak
4	9400.00	-35.88	-40.95	-13.00	5.07	-22.88	Peak

High Channel



Bureau Veritas Consumer Products Services Ltd., Taoyuan Branch

A D T

Data: 3

Date: 2019-10-01

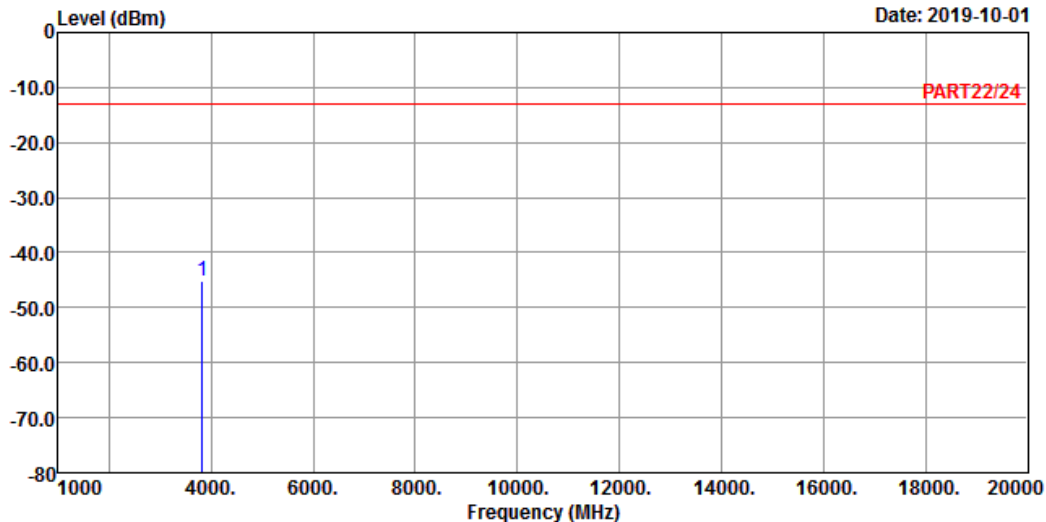

Site : 966 Chamber 5
 Condition: PART22/24 HORIZONTAL
 Remak : Cat-M1 Band 25 QPSK_5M Link_H-CH
 Tested by: tim-chen

	Read	Limit	Over		
Freq	Level	Level	Line	Factor	Limit Remark
MHz	dBm	dBm	dBm	dB	dB
1 pp 3825.00	-45.12	-38.75	-13.00	-6.37	-32.12 Peak



Bureau Veritas Consumer Products Services Ltd., Taoyuan Branch

A D T

Data: 4

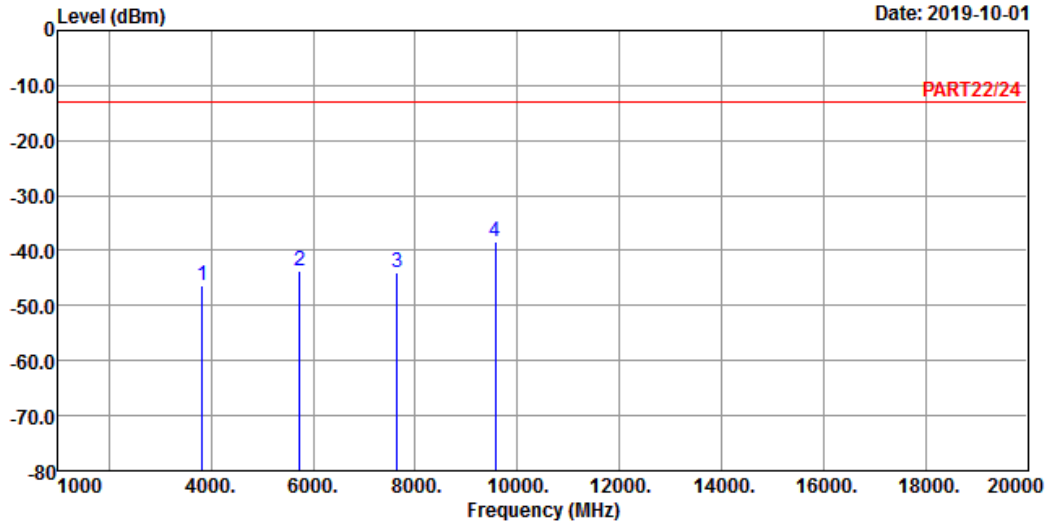

Site : 966 Chamber 5
 Condition: PART22/24 VERTICAL
 Remak : Cat-M1 Band 25 QPSK_5M Link_H-CH
 Tested by: tim-chen

	Freq	Level	Read Level	Limit Line	Factor	Over Limit	Remark
	MHz	dBm	dBm	dBm	dB	dB	
1	3825.00	-46.22	-39.85	-13.00	-6.37	-33.22	Peak
2	5737.50	-43.81	-42.16	-13.00	-1.65	-30.81	Peak
3	7650.00	-43.91	-48.46	-13.00	4.55	-30.91	Peak
4 pp	9562.50	-38.31	-43.73	-13.00	5.42	-25.31	Peak

Channel Bandwidth: 20 MHz / QPSK
Low Channel



Bureau Veritas Consumer Products Services Ltd., Taoyuan Branch

A D T

Data: 5

Date: 09-28-2019

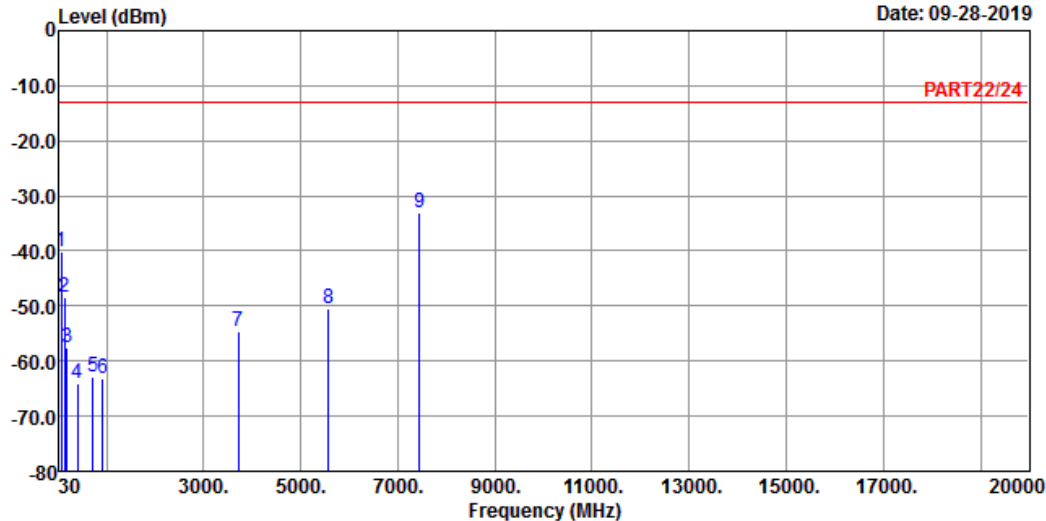

Site : 966 Chamber 5
Condition: PART22/24 HORIZONTAL
Remak : Cat-M1 Band 25 QPSK_20M Link_L-CH
Tested by: Thomas Wei

	Freq	Level	Read Level	Limit	Line Factor	Over Limit	Remark
	MHz	dBm	dBm	dBm	dB	dB	
1	76.56	-40.29	-30.31	-13.00	-9.98	-27.29	Peak
2	135.73	-48.43	-39.76	-13.00	-8.67	-35.43	Peak
3	193.93	-57.67	-50.21	-13.00	-7.46	-44.67	Peak
4	410.24	-64.19	-58.33	-13.00	-5.86	-51.19	Peak
5	722.58	-62.78	-63.12	-13.00	0.34	-49.78	Peak
6	922.40	-63.31	-64.43	-13.00	1.12	-50.31	Peak
7	3720.00	-54.65	-47.83	-13.00	-6.82	-41.65	Peak
8	5580.00	-50.44	-48.52	-13.00	-1.92	-37.44	Peak
9 pp	7440.00	-32.95	-37.10	-13.00	4.15	-19.95	Peak



Bureau Veritas Consumer Products Services Ltd., Taoyuan Branch

A D T

Data: 6

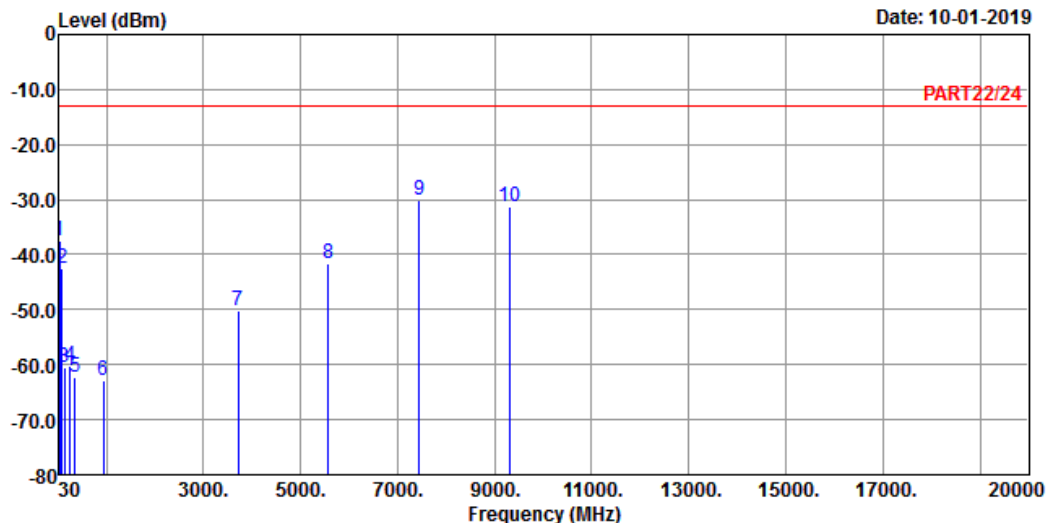

Site : 966 Chamber 5
 Condition: PART22/24 VERTICAL
 Remak : Cat-M1 Band 25 QPSK_20M Link_L-CH
 Tested by: Thomas Wei

	Freq	Level	Read Level	Limit Line	Factor	Over Limit	Remark
	MHz	dBm	dBm	dBm	dB	dB	
1	30.00	-37.46	-37.84	-13.00	0.38	-24.46	Peak
2	77.53	-42.50	-32.30	-13.00	-10.20	-29.50	Peak
3	137.67	-60.42	-51.76	-13.00	-8.66	-47.42	Peak
4	252.13	-60.17	-54.14	-13.00	-6.03	-47.17	Peak
5	349.13	-62.35	-56.10	-13.00	-6.25	-49.35	Peak
6	935.98	-62.93	-64.39	-13.00	1.46	-49.93	Peak
7	3720.00	-50.21	-43.39	-13.00	-6.82	-37.21	Peak
8	5580.00	-41.52	-39.60	-13.00	-1.92	-28.52	Peak
9 pp	7440.00	-30.23	-34.38	-13.00	4.15	-17.23	Peak
10	9300.00	-31.38	-36.32	-13.00	4.94	-18.38	Peak

Middle Channel



Bureau Veritas Consumer Products Services Ltd., Taoyuan Branch

A D T

Data: 3

Date: 09-28-2019

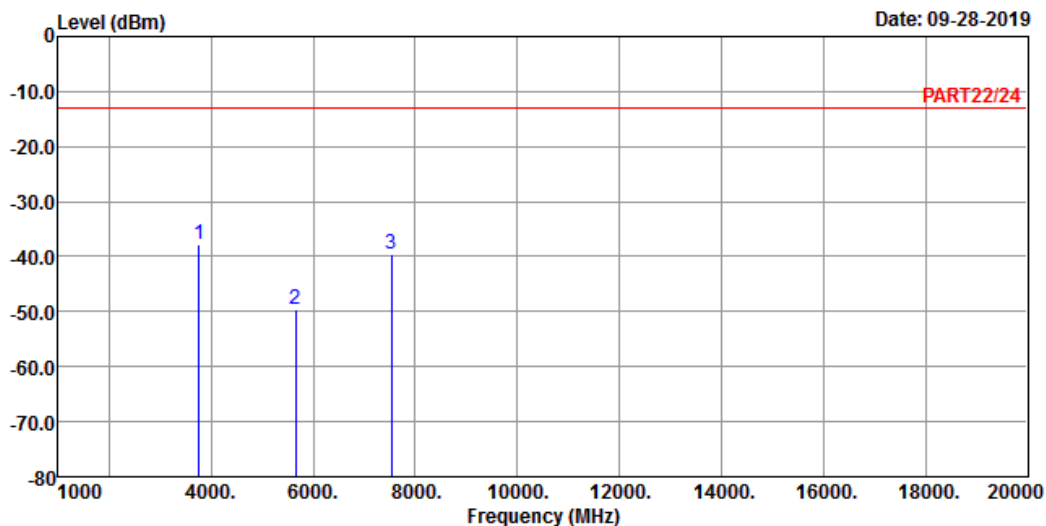

Site : 966 Chamber 5
 Condition: PART22/24 HORIZONTAL
 Remak : Cat-M1 Band 25 QPSK_20M Link_M-CH
 Tested by: Thomas Wei

	Freq	Level	Read Level	Limit	Line Factor	Over Limit	Remark
	MHz	dBm	dBm	dBm	dB	dB	
1 pp	3765.00	-37.81	-31.21	-13.00	-6.60	-24.81	Peak
2	5647.50	-49.51	-47.68	-13.00	-1.83	-36.51	Peak
3	7530.00	-39.69	-43.97	-13.00	4.28	-26.69	Peak



Bureau Veritas Consumer Products Services Ltd., Taoyuan Branch

A D T

Data: 4

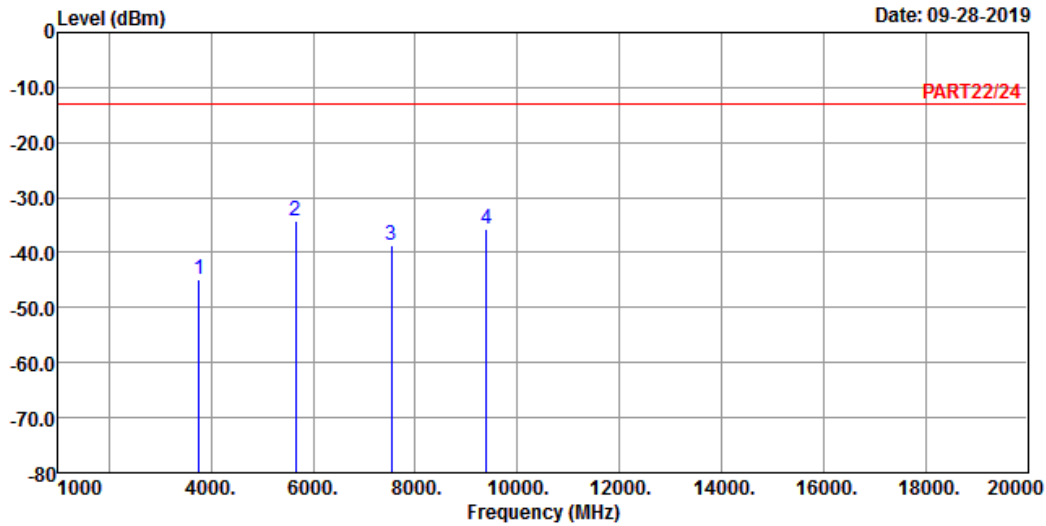

Site : 966 Chamber 5
 Condition: PART22/24 VERTICAL
 Remak : Cat-M1 Band 25 QPSK_20M Link_M-CH
 Tested by: Thomas Wei

	Freq	Level	Read Level	Limit Line	Factor	Over Limit	Remark
	MHz	dBm	dBm	dBm	dB	dB	
1	3765.00	-44.78	-38.18	-13.00	-6.60	-31.78	Peak
2 pp	5647.50	-34.11	-32.28	-13.00	-1.83	-21.11	Peak
3	7530.00	-38.55	-42.83	-13.00	4.28	-25.55	Peak
4	9400.00	-35.59	-40.66	-13.00	5.07	-22.59	Peak

High Channel



Bureau Veritas Consumer Products Services Ltd., Taoyuan Branch

A D T

Data: 3

Date: 09-28-2019

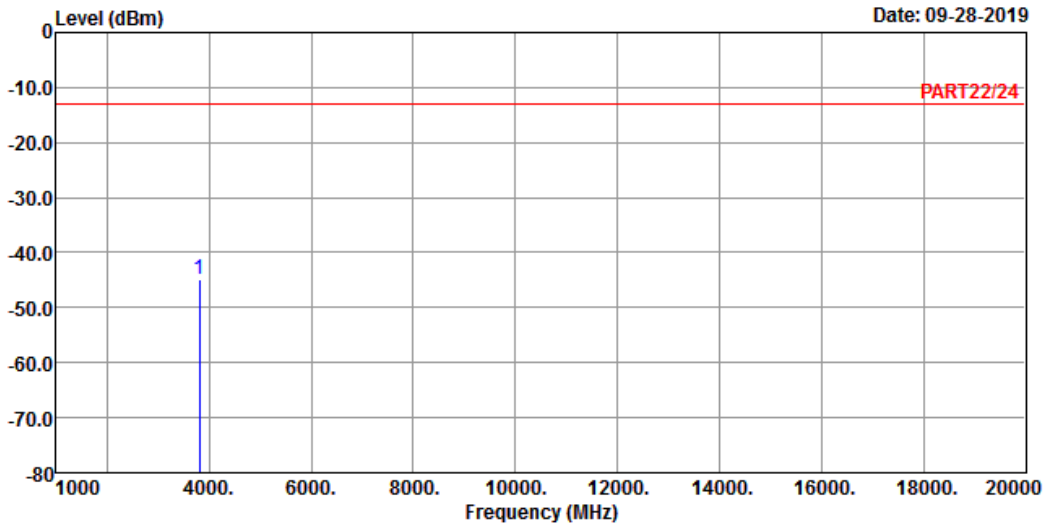

Site : 966 Chamber 5
 Condition: PART22/24 HORIZONTAL
 Remak : Cat-M1 Band 25 QPSK_20M Link_H-CH
 Tested by: Thomas Wei

Freq	Level	Read Level	Limit	Line Factor	Over Limit	Remark
MHz	dBm	dBm	dBm	dB	dB	
1 pp 3810.00	-44.73	-38.33	-13.00	-6.40	-31.73	Peak



Bureau Veritas Consumer Products Services Ltd., Taoyuan Branch

A D T

Data: 4

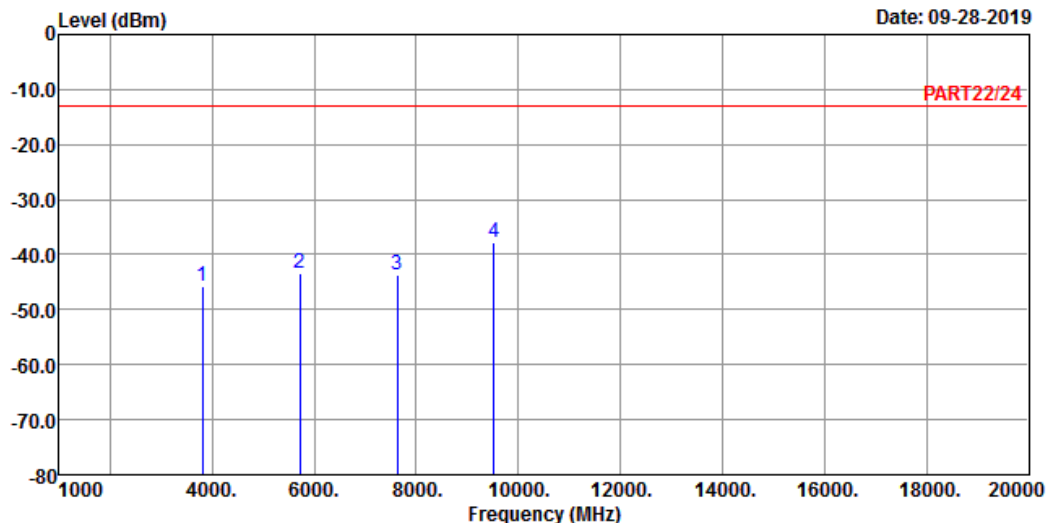

Site : 966 Chamber 5
 Condition: PART22/24 VERTICAL
 Remak : Cat-M1 Band 25 QPSK_20M Link_H-CH
 Tested by: Thomas Wei

	Freq	Level	Read Level	Limit Line	Factor	Over Limit	Remark
	MHz	dBm	dBm	dBm	dB	dB	
1	3810.00	-45.85	-39.45	-13.00	-6.40	-32.85	Peak
2	5715.00	-43.34	-41.65	-13.00	-1.69	-30.34	Peak
3	7620.00	-43.56	-48.07	-13.00	4.51	-30.56	Peak
4 pp	9525.00	-37.87	-43.22	-13.00	5.35	-24.87	Peak

5 Pictures of Test Arrangements

Please refer to the attached file (Test Setup Photo).

Appendix – Information of the Testing Laboratories

We, Bureau Veritas Consumer Products Services (H.K.) Ltd., Taoyuan Branch, were founded in 1988 to provide our best service in EMC, Radio, Telecom and Safety consultation. Our laboratories are FCC recognized accredited test firms and accredited according to ISO/IEC 17025.

If you have any comments, please feel free to contact us at the following:

Lin Kou EMC/RF Lab

Tel: 886-2-26052180

Fax: 886-2-26051924

Hsin Chu EMC/RF/Telecom Lab

Tel: 886-3-6668565

Fax: 886-3-6668323

Hwa Ya EMC/RF/Safety Lab

Tel: 886-3-3183232

Fax: 886-3-3270892

Email: service.adt@tw.bureauveritas.com

Web Site: www.bureauveritas-adt.com

The address and road map of all our labs can be found in our web site also.

--- END ---