

FCC Test Report

(PART 22)

Report No.: RF180521C04E

FCC ID: 2AAGMGM01QA

Test Model: GM01Q

Received Date: Sep. 06, 2019

Test Date: Sep. 26, 2019 ~ Oct. 01, 2019

Issued Date: Oct. 14, 2019

Applicant: Sequans Communications

Address: 15-55 Boulevard Charles de Gaulle, 92700 Colombes France

Issued By: Bureau Veritas Consumer Products Services (H.K.) Ltd., Taoyuan Branch
Lin Kou Laboratories

Lab Address: No. 47-2, 14th Ling, Chia Pau Vil., Lin Kou Dist., New Taipei City, Taiwan

Test Location: No.19, Hwa Ya 2nd Rd., Wen Hwa Vil., Kwei Shan Dist., Taoyuan City
33383, Taiwan

**FCC Registration /
Designation Number:** 788550 / TW0003



This report is for your exclusive use. Any copying or replication of this report to or for any other person or entity, or use of our name or trademark, is permitted only with our prior written permission. This report sets forth our findings solely with respect to the test samples identified herein. The results set forth in this report are not indicative or representative of the quality or characteristics of the lot from which a test sample was taken or any similar or identical product unless specifically and expressly noted. Our report includes all of the tests requested by you and the results thereof based upon the information that you provided to us. You have 60 days from date of issuance of this report to notify us of any material error or omission caused by our negligence, provided, however, that such notice shall be in writing and shall specifically address the issue you wish to raise. A failure to raise such issue within the prescribed time shall constitute your unqualified acceptance of the completeness of this report, the tests conducted and the correctness of the report contents. Unless specific mention, the uncertainty of measurement has been explicitly taken into account to declare the compliance or non-compliance to the specification. The report must not be used by the client to claim product certification, approval, or endorsement by TAF or any government agencies

Table of Contents

| | |
|--|-----------|
| Release Control Record | 4 |
| 1 Certificate of Conformity | 5 |
| 2 Summary of Test Results | 6 |
| 2.1 Measurement Uncertainty | 6 |
| 2.2 Test Site and Instruments | 7 |
| 3 General Information | 8 |
| 3.1 General Description of EUT | 8 |
| 3.2 Configuration of System under Test | 9 |
| 3.2.1 Description of Support Units | 9 |
| 3.3 Test Mode Applicability and Tested Channel Detail | 10 |
| 3.4 EUT Operating Conditions | 11 |
| 3.5 General Description of Applied Standards | 11 |
| 4 Test Types and Results | 12 |
| 4.1 Output Power Measurement | 12 |
| 4.1.1 Limits of Output Power Measurement | 12 |
| 4.1.2 Test Procedures | 12 |
| 4.1.3 Test Setup | 13 |
| 4.1.4 Test Results | 14 |
| 4.2 Modulation Characteristics Measurement | 18 |
| 4.2.1 Limits of Modulation Characteristics | 18 |
| 4.2.2 Test Setup | 18 |
| 4.2.3 Test Procedure | 18 |
| 4.2.4 Test Results | 19 |
| 4.3 Frequency Stability Measurement | 20 |
| 4.3.1 Limits of Frequency Stability Measurement | 20 |
| 4.3.2 Test Procedure | 20 |
| 4.3.3 Test Setup | 20 |
| 4.3.4 Test Results | 21 |
| 4.4 Occupied Bandwidth Measurement | 23 |
| 4.4.1 Test Procedure | 23 |
| 4.4.2 Test Setup | 23 |
| 4.4.3 Test Result | 24 |
| 4.5 Band Edge Measurement | 25 |
| 4.5.1 Limits of Band Edge Measurement | 25 |
| 4.5.2 Test Setup | 25 |
| 4.5.3 Test Procedures | 25 |
| 4.5.4 Test Results | 26 |
| 4.6 Peak to Average Ratio | 28 |
| 4.6.1 Limits of Peak to Average Ratio Measurement | 28 |
| 4.6.2 Test Setup | 28 |
| 4.6.3 Test Procedures | 28 |
| 4.6.4 Test Results | 29 |
| 4.7 Conducted Spurious Emissions | 30 |
| 4.7.1 Limits of Conducted Spurious Emissions Measurement | 30 |
| 4.7.2 Test Setup | 30 |
| 4.7.3 Test Procedure | 30 |
| 4.7.4 Test Results | 31 |
| 4.8 Radiated Emission Measurement | 33 |
| 4.8.1 Limits of Radiated Emission Measurement | 33 |
| 4.8.2 Test Procedure | 33 |
| 4.8.3 Deviation from Test Standard | 33 |
| 4.8.4 Test Setup | 34 |
| 4.8.5 Test Results | 35 |

| | |
|---|-----------|
| 5 Pictures of Test Arrangements..... | 47 |
| Appendix – Information of the Testing Laboratories | 48 |



Release Control Record

| Issue No. | Description | Date Issued |
|--------------|------------------|---------------|
| RF180521C04E | Original Release | Oct. 14, 2019 |

1 Certificate of Conformity

Product: GM01Q EZlinkLTE modules

Brand: SEQUANS COMMUNICATIONS

Test Model: GM01Q

Sample Status: Mass Production

Applicant: Sequans Communications

Test Date: Sep. 26, 2019 ~ Oct. 01, 2019

Standards: FCC Part 22, Subpart H

The above equipment has been tested by **Bureau Veritas Consumer Products Services (H.K.) Ltd., Taoyuan Branch**, and found compliance with the requirement of the above standards. The test record, data evaluation & Equipment Under Test (EUT) configurations represented herein are true and accurate accounts of the measurements of the sample's RF characteristics under the conditions specified in this report.

Prepared by : , **Date:** Oct. 14, 2019
Rona Chen / Specialist

Approved by : , **Date:** Oct. 14, 2019
Dylan Chiou / Project Engineer

2 Summary of Test Results

| Applied Standard: FCC Part 22 & Part 2 | | | |
|--|------------------------------|--------|---|
| FCC Clause | Test Item | Result | Remarks |
| 2.1046 22.913 (a) | Effective Radiated Power | Pass | Meet the requirement of limit. |
| 2.1047 | Modulation Characteristics | Pass | Meet the requirement. |
| 2.1046 22.913 (d) | Peak to Average Ratio | Pass | Meet the requirement of limit. |
| 2.1055 22.355 | Frequency Stability | Pass | Meet the requirement of limit. |
| 2.1049 | Occupied Bandwidth | Pass | Meet the requirement of limit. |
| 22.917 | Band Edge Measurements | Pass | Meet the requirement of limit. |
| 2.1051 22.917 | Conducted Spurious Emissions | Pass | Meet the requirement of limit. |
| 2.1053 22.917 | Radiated Spurious Emissions | Pass | Meet the requirement of limit. Minimum passing margin is -11.52 dB at 2487.00 MHz. |

Note: Determining compliance based on the results of the compliance measurement, not taking into account measurement instrumentation uncertainty.

2.1 Measurement Uncertainty

Where relevant, the following measurement uncertainty levels have been estimated for tests performed on the EUT as specified in CISPR 16-4-2:

| Measurement | Frequency | Expanded Uncertainty (k=2) (±) |
|--------------------------------|--------------------|--------------------------------|
| Radiated Emissions up to 1 GHz | 9 kHz ~ 30 MHz | 3.04 dB |
| | 30 MHz ~ 200 MHz | 2.93 dB |
| | 200 MHz ~ 1000 MHz | 2.95 dB |
| Radiated Emissions above 1 GHz | 1 GHz ~ 18 GHz | 2.26 dB |
| | 18 GHz ~ 40 GHz | 1.94 dB |

2.2 Test Site and Instruments

| Description & Manufacturer | Model No. | Serial No. | Date of Calibration | Due Date of Calibration |
|--|----------------------------|-------------------------------|---------------------|-------------------------|
| Test Receiver Agilent | N9038A | MY51210203 | Mar. 18, 2019 | Mar. 17, 2020 |
| Spectrum Analyzer Agilent | N9010A | MY56070348 | Sep. 09, 2019 | Sep. 08, 2020 |
| Spectrum Analyzer ROHDE & SCHWARZ | FSU43 | 100115 | Jan. 21, 2019 | Jan. 20, 2020 |
| Spectrum Analyzer ROHDE & SCHWARZ | FSW26 | 102023 | Oct. 11, 2018 | Oct. 10, 2019 |
| HORN Antenna SCHWARZBECK | 3115 | 5619 | Nov. 25, 2018 | Nov. 24, 2019 |
| HORN Antenna SCHWARZBECK | BBHA 9120 D | 9120D-969 | Nov. 25, 2018 | Nov. 24, 2019 |
| BILOG Antenna SCHWARZBECK | VULB9168 | 9168-472 | Nov. 23, 2018 | Nov. 22, 2019 |
| Fixed Attenuator Mini-Circuits | MDCS18N-10 | MDCS18N-10-01 | Apr. 15, 2019 | Apr. 14, 2020 |
| MXG Vector signal generator Agilent | N5182B | MY53052658 | May 20, 2019 | May 19, 2020 |
| Preamplifier EMCI | EMC 012645 | 980115 | Oct. 12, 2018 | Oct. 11, 2019 |
| Preamplifier EMCI | EMC 330H | 980112 | Oct. 12, 2018 | Oct. 11, 2019 |
| RF Coaxial Cable HUBER+SUHNNER | EMC104-SM-SM-800 0&3000 | 140811+170717 | Oct. 12, 2018 | Oct. 11, 2019 |
| RF Coaxial Cable HUBER+SUHNNER | SUCOFLEX 104 | EMC104-SM-SM- 1000(140807) | Oct. 12, 2018 | Oct. 11, 2019 |
| RF Coaxial Cable WOKEN | 8D-FB | Cable-Ch10-01 | Oct. 12, 2018 | Oct. 11, 2019 |
| Boresight Antenna Fixture | FBA-01 | FBA-SIP01 | NA | NA |
| Software BV ADT | E3 6.120103 | NA | NA | NA |
| Antenna Tower MF | MFA-440H | NA | NA | NA |
| Turn Table MF | MFT-201SS | NA | NA | NA |
| Antenna Tower & Turn Table Controller MF | MF-7802 | NA | NA | NA |
| LTE Wireless Communication Test Set Keysight | E7515A | MY57270629 | Feb. 22, 2019 | Feb. 21, 2020 |
| Temperature & Humidity Chamber | GTH-120-40-CP-AR | MAA1306-019 | Sep. 06, 2019 | Sep. 05, 2020 |
| DC Power Supply Topward | 33010D | 807748 | NA | NA |

Note: 1. The calibration interval of the above test instruments is 12 / 24 months and the calibrations are traceable to NML/ROC and NIST/USA.

2. The test was performed in HwaYa Chamber 10.

3 General Information

3.1 General Description of EUT

| | | |
|----------------------------|--|-------------------|
| Product | GM01Q EZlinkLTE modules | |
| Brand | SEQUANS COMMUNICATIONS | |
| Test Model | GM01Q | |
| Status of EUT | Mass Production | |
| Power Supply Rating | 5.0 Vdc (adapter) or 3.8 Vdc (form DC power supply) | |
| Modulation Type | LTE | QPSK, 16QAM |
| Frequency Range | LTE 5 (Channel Bandwidth: 5 MHz) | 826.5 ~ 846.5 MHz |
| | LTE 5 (Channel Bandwidth: 10 MHz) | 829 ~ 844 MHz |
| Max. ERP Power | LTE 5 (Channel Bandwidth: 5 MHz) | 132.74 mW |
| | LTE 5 (Channel Bandwidth: 10 MHz) | 139.00 mW |
| Emission Designator | LTE 5 (Channel Bandwidth: 5 MHz) | 1M10G7D |
| | LTE 5 (Channel Bandwidth: 10 MHz) | 1M09G7D |
| Antenna Type | Broadband Omni-Directional Antenna with 0.2 dBi gain | |
| Accessory Device | N/A | |
| Data Cable Supplied | N/A | |

Note:

1. The above EUT information is declared by manufacturer and for more detailed features description, please refers to the manufacturer's specifications or user's manual.

3.2 Configuration of System under Test

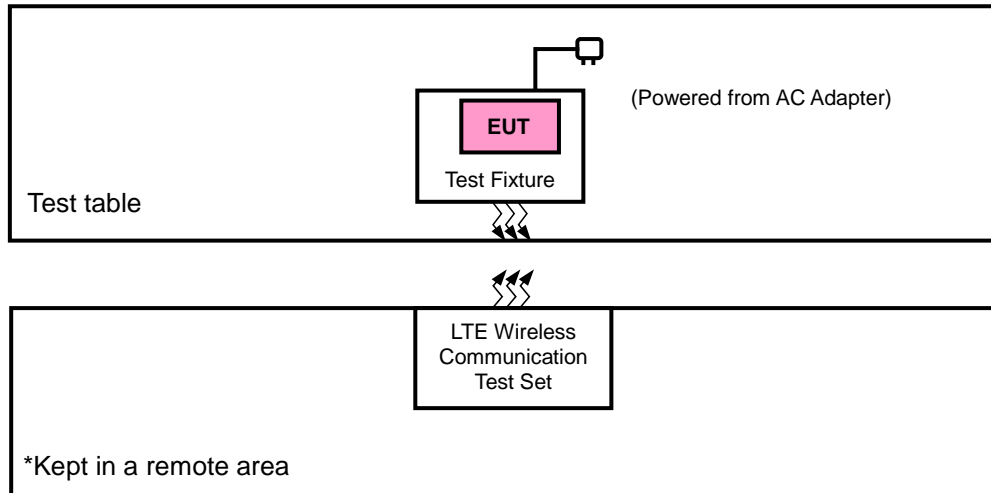

3.2.1 Description of Support Units

The EUT has been tested as an independent unit together with other necessary accessories or support units.

3.3 Test Mode Applicability and Tested Channel Detail

Pre-Scan has been conducted to determine the worst-case mode from all possible combinations between available modulations, data rates, XYZ axis, and antenna ports.

The worst case was found when positioned as the table below. Following channel(s) was (were) selected for the final test as listed below:

| Band | ERP | Radiated Emission |
|------------|---------|-------------------|
| LTE Band 5 | X-plane | X-plane |

LTE Band 5

| EUT Configure Mode | Test Item | Available Channel | Tested Channel | Channel Bandwidth | Modulation | Mode | | |
|--------------------|----------------------------|-------------------|-----------------------|-------------------|---------------------|--|-------------|--------------------|
| - | ERP | 20425 to 20625 | 20425, 20525, 20625 | 5 MHz | QPSK, 16QAM | 1 RB / 0 RB Offset | | |
| | | 20450 to 20600 | 20450, 20525, 20600 | 10 MHz | QPSK, 16QAM | 1 RB / 0 RB Offset | | |
| - | Modulation Characteristics | 20450 to 20600 | 20525 | 10 MHz | QPSK | 6 RB / 0 RB Offset | | |
| | | | | | 16QAM | 5 RB / 0 RB Offset | | |
| - | Frequency Stability | 20425 to 20625 | 20425, 20625 | 5 MHz | QPSK | 1 RB / 0 RB Offset | | |
| | | 20450 to 20600 | 20450, 20600 | 10 MHz | QPSK | 1 RB / 0 RB Offset | | |
| - | Occupied Bandwidth | 20425 to 20625 | 20425, 20525, 20625 | 5 MHz | QPSK, 16QAM | 25 RB / 0 RB Offset | | |
| | | 20450 to 20600 | 20450, 20525, 20600 | 10 MHz | QPSK, 16QAM | 50 RB / 0 RB Offset | | |
| - | Band Edge | 20425 to 20625 | 20425 | 5 MHz | QPSK | 1 RB / 0 RB Offset 25 RB / 0 RB Offset | | |
| | | | 20625 | 5 MHz | QPSK | 1 RB / 24 RB Offset 25 RB / 0 RB Offset | | |
| | | 20450 to 20600 | 20450 | 10 MHz | QPSK | 1 RB / 0 RB Offset 50 RB / 0 RB Offset | | |
| | | | 20600 | 10 MHz | QPSK | 1 RB / 49 RB Offset 50 RB / 0 RB Offset | | |
| | | - | Peak to Average Ratio | 20425 to 20625 | 20425, 20525, 20625 | 5 MHz | QPSK, 16QAM | 1 RB / 0 RB Offset |
| | | | | 20450 to 20600 | 20450, 20525, 20600 | 10 MHz | QPSK, 16QAM | 1 RB / 0 RB Offset |
| - | Conducted Emission | 20425 to 20625 | 20425, 20525, 20625 | 5 MHz | QPSK | 1 RB / 0 RB Offset | | |
| | | 20450 to 20600 | 20450, 20525, 20600 | 10 MHz | QPSK | 1 RB / 0 RB Offset | | |
| - | Radiated Emission | 20425 to 20625 | 20425, 20525, 20625 | 5 MHz | QPSK | 1 RB / 0 RB Offset | | |
| | | 20450 to 20600 | 20450, 20525, 20600 | 10 MHz | QPSK | 1 RB / 0 RB Offset | | |

Note:

1. This device was tested under all bandwidths, RB configurations and modulations. The worst case was found in QPSK modulation.
2. For radiated emission above 1 GHz, according to 3GPP 36.521 Section 6.6.3.1.4, choose the lowest, 5 MHz & highest channel bandwidth for final test.

Test Condition:

| Test Item | Environmental Conditions | Input Power | Tested By |
|----------------------------|--------------------------|----------------|------------------------|
| ERP | 25 deg. C, 65 % RH | 3.8 Vdc | Tim Chen Thomas Wei |
| Modulation Characteristics | 25 deg. C, 65 % RH | 3.8 Vdc | Getaz Yang |
| Frequency Stability | 25 deg. C, 65 % RH | 3.8 Vdc | Getaz Yang |
| Occupied Bandwidth | 25 deg. C, 65 % RH | 3.8 Vdc | Getaz Yang |
| Band Edge | 25 deg. C, 65 % RH | 3.8 Vdc | Getaz Yang |
| Peak to Average Ratio | 25 deg. C, 65 % RH | 3.8 Vdc | Getaz Yang |
| Conducted Emission | 25 deg. C, 65 % RH | 3.8 Vdc | Getaz Yang |
| Radiated Emission | 25 deg. C, 65 % RH | 120 Vac, 60 Hz | Tim Chen Thomas Wei |

3.4 EUT Operating Conditions

The EUT makes a call to the communication simulator. The communication simulator station system controlled a EUT to export maximum output power under transmission mode and specific channel frequency.

3.5 General Description of Applied Standards

The EUT is a RF Product. According to the specifications of the manufacturer, it must comply with the requirements of the following standards:

FCC 47 CFR Part 2

FCC 47 CFR Part 22

KDB 971168 D01 Power Meas License Digital Systems v03r01

ANSI/TIA/EIA-603-E 2016

ANSI 63.26-2015

Note: All test items have been performed and recorded as per the above standards.

4 Test Types and Results

4.1 Output Power Measurement

4.1.1 Limits of Output Power Measurement

Mobile / Portable station are limited to 7 watts e.r.p.

4.1.2 Test Procedures

EIRP / ERP Measurement:

- a. All measurements were done at low, middle and high operational frequency range. RBW and VBW is 10 MHz for LTE mode.
- b. Substitution method is used for E.I.R.P measurement. In the semi-anechoic chamber, EUT placed on the 0.8 m (below or equal 1 GHz) and/or 1.5 m (above 1 GHz) height of Turn Table, rotated the table around 360 degrees to search the maximum radiation power and receiver antenna shall be rotated vertical and horizontal polarization and moved height from 1 m to 4 m to find the maximum polar radiated power. The "Read Value" is the spectrum reading the maximum power value.
- c. The substitution horn antenna is substituted for EUT at the same position and signals generator export the CW signal to the substitution antenna via a tx cable. Rotated the Turn Table and moved receiving antenna to find the maximum radiation power. Adjust output power level of S.G to get a Value of spectrum reading equal to "Read Value" of step b. Record the power level of S.G.
- d. $EIRP = \text{Output power level of S.G} - \text{TX cable loss} + \text{Antenna gain of substitution horn}$. E.R.P power can be calculated form E.I.R.P power by subtracting the gain of dipole, $E.R.P \text{ power} = E.I.R.P \text{ power} - 2.15 \text{ dB}$.

Conducted Power Measurement:

The EUT was set up for the maximum power with LTE link data modulation and link up with simulator. Set the EUT to transmit under low, middle and high channel and record the power level shown on simulator.

4.1.3 Test Setup

EIRP / ERP Measurement:

<Radiated Emission below or equal 1 GHz>

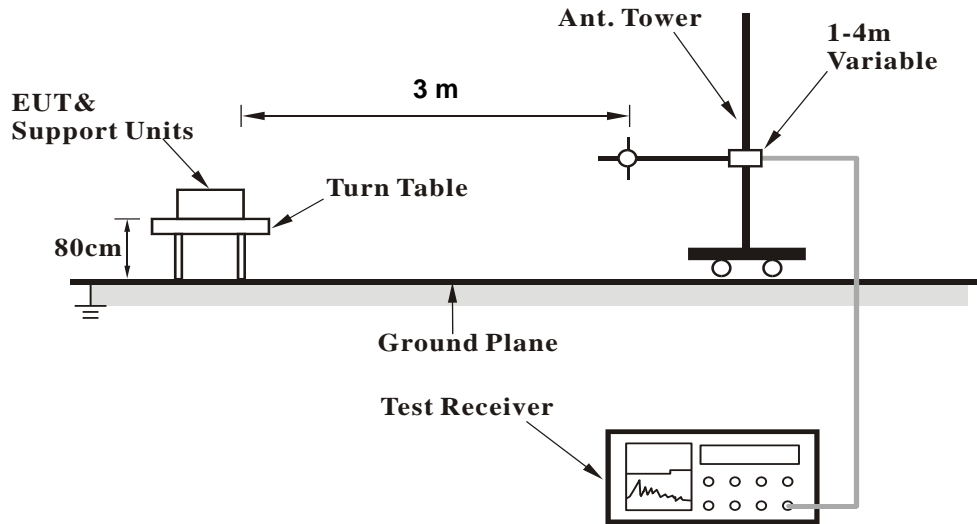

<Radiated Emission above 1 GHz>

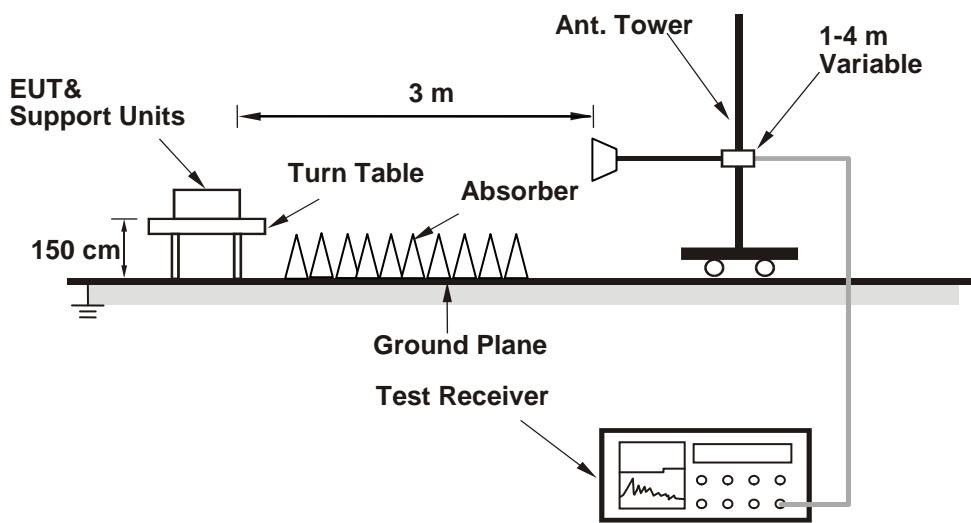

For the actual test configuration, please refer to the attached file (Test Setup Photo).

Conducted Power Measurement:



4.1.4 Test Results

Conducted Output Power (dBm)

LTE Band 5

BW (MHz): 5

| Test Frequency ID | N _{UL} | Frequency of Uplink [MHz] | N _{DL} | Frequency of Downlink [MHz] | Test Configuration Initial of Power | | | | EUT | |
|-------------------|-----------------|---------------------------|-----------------|-----------------------------|-------------------------------------|---------|-----------|------------------|------------------------|-------------|
| | | | | | Modulation | RB Size | RB Offset | Narrowband Index | Cell power (dBm/15kHz) | Power (dBm) |
| Low Range | 20425 | 826.5 | 2425 | 871.5 | QPSK | 1 | 0 | 0 | -85 | 23.78 |
| | | | | | QPSK | 1 | 5 | 0 | -85 | 23.77 |
| | | | | | QPSK | 1 | 0 | 1 | -85 | 23.70 |
| | | | | | QPSK | 1 | 5 | 1 | -85 | 23.75 |
| | | | | | QPSK | 1 | 0 | 3 | -85 | 23.75 |
| | | | | | QPSK | 1 | 5 | 3 | -85 | 23.72 |
| | | | | | QPSK | 3 | 0 | 0 | -85 | 22.97 |
| | | | | | QPSK | 3 | 3 | 3 | -85 | 22.94 |
| | | | | | QPSK | 6 | 0 | 0 | -85 | 22.99 |
| | | | | | QPSK | 6 | 0 | 1 | -85 | 22.97 |
| | | | | | QPSK | 6 | 0 | 3 | -85 | 22.94 |
| | | | | | 16QAM | 1 | 0 | 0 | -85 | 23.68 |
| | | | | | 16QAM | 1 | 5 | 0 | -85 | 23.67 |
| | | | | | 16QAM | 1 | 0 | 1 | -85 | 23.67 |
| | | | | | 16QAM | 1 | 5 | 1 | -85 | 23.66 |
| | | | | | 16QAM | 1 | 0 | 3 | -85 | 23.61 |
| | | | | | 16QAM | 1 | 5 | 3 | -85 | 23.56 |
| | | | | | 16QAM | 3 | 0 | 0 | -85 | 23.10 |
| | | | | | 16QAM | 3 | 3 | 3 | -85 | 23.08 |
| | | | | | 16QAM | 5 | 0 | 0 | -85 | 22.24 |
| 16QAM | 5 | 0 | 1 | -85 | 22.17 | | | | | |
| 16QAM | 5 | 0 | 3 | -85 | 22.20 | | | | | |
| Mid Range | 20525 | 836.5 | 2525 | 881.5 | QPSK | 1 | 0 | 0 | -85 | 23.49 |
| | | | | | QPSK | 1 | 5 | 0 | -85 | 23.46 |
| | | | | | QPSK | 1 | 0 | 1 | -85 | 23.42 |
| | | | | | QPSK | 1 | 5 | 1 | -85 | 23.43 |
| | | | | | QPSK | 1 | 0 | 3 | -85 | 23.44 |
| | | | | | QPSK | 1 | 5 | 3 | -85 | 23.45 |
| | | | | | QPSK | 3 | 0 | 0 | -85 | 22.88 |
| | | | | | QPSK | 3 | 3 | 3 | -85 | 22.81 |
| | | | | | QPSK | 6 | 0 | 0 | -85 | 22.83 |
| | | | | | QPSK | 6 | 0 | 1 | -85 | 22.81 |
| | | | | | QPSK | 6 | 0 | 3 | -85 | 22.83 |
| | | | | | 16QAM | 1 | 0 | 0 | -85 | 23.42 |
| | | | | | 16QAM | 1 | 5 | 0 | -85 | 23.40 |
| | | | | | 16QAM | 1 | 0 | 1 | -85 | 23.38 |
| | | | | | 16QAM | 1 | 5 | 1 | -85 | 23.39 |
| | | | | | 16QAM | 1 | 0 | 3 | -85 | 23.41 |
| | | | | | 16QAM | 1 | 5 | 3 | -85 | 23.38 |
| | | | | | 16QAM | 3 | 0 | 0 | -85 | 22.81 |
| | | | | | 16QAM | 3 | 3 | 3 | -85 | 22.97 |
| | | | | | 16QAM | 5 | 0 | 0 | -85 | 22.11 |
| 16QAM | 5 | 0 | 1 | -85 | 22.12 | | | | | |
| 16QAM | 5 | 0 | 3 | -85 | 22.03 | | | | | |

| Test Frequency ID | N _{UL} | Frequency of Uplink [MHz] | N _{DL} | Frequency of Downlink [MHz] | Test Configuration Initial of Power | | | | EUT | |
|-------------------|-----------------|---------------------------|-----------------|-----------------------------|-------------------------------------|---------|-----------|------------------|------------------------|-------------|
| | | | | | Modulation | RB Size | RB Offset | Narrowband Index | Cell power (dBm/15kHz) | Power (dBm) |
| High Range | 20625 | 846.5 | 2625 | 891.5 | QPSK | 1 | 0 | 0 | -85 | 23.34 |
| | | | | | QPSK | 1 | 5 | 0 | -85 | 23.31 |
| | | | | | QPSK | 1 | 0 | 1 | -85 | 23.32 |
| | | | | | QPSK | 1 | 5 | 1 | -85 | 23.31 |
| | | | | | QPSK | 1 | 0 | 3 | -85 | 23.33 |
| | | | | | QPSK | 1 | 5 | 3 | -85 | 23.32 |
| | | | | | QPSK | 3 | 0 | 0 | -85 | 22.78 |
| | | | | | QPSK | 3 | 3 | 3 | -85 | 22.77 |
| | | | | | QPSK | 6 | 0 | 0 | -85 | 22.71 |
| | | | | | QPSK | 6 | 0 | 1 | -85 | 22.72 |
| | | | | | QPSK | 6 | 0 | 3 | -85 | 22.74 |
| | | | | | 16QAM | 1 | 0 | 0 | -85 | 23.31 |
| | | | | | 16QAM | 1 | 5 | 0 | -85 | 23.29 |
| | | | | | 16QAM | 1 | 0 | 1 | -85 | 23.28 |
| | | | | | 16QAM | 1 | 5 | 1 | -85 | 23.29 |
| | | | | | 16QAM | 1 | 0 | 3 | -85 | 23.30 |
| | | | | | 16QAM | 1 | 5 | 3 | -85 | 23.27 |
| | | | | | 16QAM | 3 | 0 | 0 | -85 | 22.65 |
| | | | | | 16QAM | 3 | 3 | 3 | -85 | 22.61 |
| | | | | | 16QAM | 5 | 0 | 0 | -85 | 22.02 |
| 16QAM | 5 | 0 | 1 | -85 | 22.01 | | | | | |
| 16QAM | 5 | 0 | 3 | -85 | 21.98 | | | | | |

| BW (MHz): 10 | | | | | | | | | | |
|-------------------|-----------------|---------------------------|-----------------|-----------------------------|-------------------------------------|---------|-----------|------------------|------------------------|-------------|
| Test Frequency ID | N _{UL} | Frequency of Uplink [MHz] | N _{DL} | Frequency of Downlink [MHz] | Test Configuration Initial of Power | | | | EUT | |
| | | | | | Modulation | RB Size | RB Offset | Narrowband Index | Cell power (dBm/15kHz) | Power (dBm) |
| Low Range | 20450 | 829 | 2450 | 874 | QPSK | 1 | 0 | 0 | -85 | 23.81 |
| | | | | | QPSK | 1 | 5 | 0 | -85 | 23.75 |
| | | | | | QPSK | 1 | 0 | 3 | -85 | 23.77 |
| | | | | | QPSK | 1 | 5 | 3 | -85 | 23.78 |
| | | | | | QPSK | 1 | 0 | 7 | -85 | 23.71 |
| | | | | | QPSK | 1 | 5 | 7 | -85 | 23.70 |
| | | | | | QPSK | 4 | 0 | 0 | -85 | 23.74 |
| | | | | | QPSK | 4 | 2 | 7 | -85 | 23.70 |
| | | | | | QPSK | 6 | 0 | 0 | -85 | 22.91 |
| | | | | | QPSK | 6 | 0 | 7 | -85 | 22.82 |
| | | | | | 16QAM | 1 | 0 | 0 | -85 | 23.72 |
| | | | | | 16QAM | 1 | 5 | 0 | -85 | 23.73 |
| | | | | | 16QAM | 1 | 0 | 3 | -85 | 23.74 |
| | | | | | 16QAM | 1 | 5 | 3 | -85 | 23.74 |
| | | | | | 16QAM | 1 | 0 | 7 | -85 | 23.71 |
| | | | | | 16QAM | 1 | 5 | 7 | -85 | 23.69 |
| | | | | | 16QAM | 4 | 2 | 0 | -85 | 22.78 |
| | | | | | 16QAM | 4 | 2 | 7 | -85 | 22.74 |
| 16QAM | 5 | 0 | 0 | -85 | 22.80 | | | | | |
| 16QAM | 5 | 0 | 7 | -85 | 22.86 | | | | | |
| Mid Range | 20525 | 836.5 | 2525 | 881.5 | QPSK | 1 | 0 | 0 | -85 | 23.66 |
| | | | | | QPSK | 1 | 5 | 0 | -85 | 23.63 |
| | | | | | QPSK | 1 | 0 | 3 | -85 | 23.53 |
| | | | | | QPSK | 1 | 5 | 3 | -85 | 23.58 |
| | | | | | QPSK | 1 | 0 | 7 | -85 | 23.45 |
| | | | | | QPSK | 1 | 5 | 7 | -85 | 23.41 |
| | | | | | QPSK | 4 | 0 | 0 | -85 | 23.56 |
| | | | | | QPSK | 4 | 2 | 7 | -85 | 22.62 |
| | | | | | QPSK | 6 | 0 | 0 | -85 | 22.75 |
| | | | | | QPSK | 6 | 0 | 7 | -85 | 22.67 |
| | | | | | 16QAM | 1 | 0 | 0 | -85 | 23.60 |
| | | | | | 16QAM | 1 | 5 | 0 | -85 | 23.57 |
| | | | | | 16QAM | 1 | 0 | 3 | -85 | 23.55 |
| | | | | | 16QAM | 1 | 5 | 3 | -85 | 23.51 |
| | | | | | 16QAM | 1 | 0 | 7 | -85 | 23.59 |
| | | | | | 16QAM | 1 | 5 | 7 | -85 | 23.56 |
| | | | | | 16QAM | 4 | 2 | 0 | -85 | 22.79 |
| | | | | | 16QAM | 4 | 2 | 7 | -85 | 22.63 |
| 16QAM | 5 | 0 | 0 | -85 | 22.91 | | | | | |
| 16QAM | 5 | 0 | 7 | -85 | 22.63 | | | | | |
| High Range | 20600 | 844 | 2600 | 889 | QPSK | 1 | 0 | 0 | -85 | 23.65 |
| | | | | | QPSK | 1 | 5 | 0 | -85 | 23.56 |
| | | | | | QPSK | 1 | 5 | 7 | -85 | 23.31 |
| | | | | | QPSK | 1 | 0 | 3 | -85 | 23.47 |
| | | | | | QPSK | 1 | 5 | 3 | -85 | 23.43 |
| | | | | | QPSK | 1 | 0 | 7 | -85 | 23.39 |
| | | | | | QPSK | 4 | 0 | 0 | -85 | 23.60 |
| | | | | | QPSK | 4 | 2 | 7 | -85 | 23.38 |
| | | | | | QPSK | 6 | 0 | 0 | -85 | 22.71 |
| | | | | | QPSK | 6 | 0 | 7 | -85 | 22.53 |
| | | | | | 16QAM | 1 | 0 | 0 | -85 | 23.62 |
| | | | | | 16QAM | 1 | 5 | 0 | -85 | 23.53 |
| | | | | | 16QAM | 1 | 0 | 3 | -85 | 23.60 |
| | | | | | 16QAM | 1 | 5 | 3 | -85 | 23.50 |
| | | | | | 16QAM | 1 | 0 | 7 | -85 | 23.49 |
| | | | | | 16QAM | 1 | 5 | 7 | -85 | 23.46 |
| | | | | | 16QAM | 4 | 2 | 0 | -85 | 22.65 |
| | | | | | 16QAM | 4 | 2 | 7 | -85 | 22.53 |
| 16QAM | 5 | 0 | 0 | -85 | 22.73 | | | | | |
| 16QAM | 5 | 0 | 7 | -85 | 22.51 | | | | | |

ERP Power (dBm)

| LTE Band 5 | | | | | | | |
|----------------------------------|---------|-----------------|---------------|------------------------|-----------|----------|--------------------|
| Channel Bandwidth: 5 MHz / QPSK | | | | | | | |
| Plane | Channel | Frequency (MHz) | Reading (dBm) | Correction Factor (dB) | ERP (dBm) | ERP (mW) | Polarization (H/V) |
| X | 20425 | 826.5 | -9.24 | 32.62 | 21.23 | 132.74 | H |
| | 20525 | 836.5 | -9.21 | 32.52 | 21.16 | 130.62 | |
| | 20625 | 846.5 | -9.44 | 32.65 | 21.06 | 127.64 | |
| | 20425 | 826.5 | -15.84 | 32.76 | 14.77 | 29.99 | V |
| | 20525 | 836.5 | -15.63 | 32.39 | 14.61 | 28.91 | |
| | 20625 | 846.5 | -15.85 | 32.54 | 14.54 | 28.44 | |
| Channel Bandwidth: 5 MHz / 16QAM | | | | | | | |
| X | 20425 | 826.5 | -10.28 | 32.62 | 20.19 | 104.47 | H |
| | 20525 | 836.5 | -10.30 | 32.52 | 20.07 | 101.62 | |
| | 20625 | 846.5 | -10.69 | 32.65 | 19.81 | 95.72 | |
| | 20425 | 826.5 | -16.88 | 32.76 | 13.73 | 23.60 | V |
| | 20525 | 836.5 | -16.77 | 32.39 | 13.47 | 22.23 | |
| | 20625 | 846.5 | -17.00 | 32.54 | 13.39 | 21.83 | |

Note: ERP (dBm) = Reading (dBm) + Correction Factor (dB) – 2.15

| LTE Band 5 | | | | | | | |
|-----------------------------------|---------|-----------------|---------------|------------------------|-----------|----------|--------------------|
| Channel Bandwidth: 10 MHz / QPSK | | | | | | | |
| Plane | Channel | Frequency (MHz) | Reading (dBm) | Correction Factor (dB) | ERP (dBm) | ERP (mW) | Polarization (H/V) |
| X | 20450 | 829.0 | -9.04 | 32.62 | 21.43 | 139.00 | H |
| | 20525 | 836.5 | -9.01 | 32.52 | 21.36 | 136.77 | |
| | 20600 | 844.0 | -9.22 | 32.65 | 21.28 | 134.28 | |
| | 20450 | 829.0 | -15.51 | 32.76 | 15.10 | 32.36 | V |
| | 20525 | 836.5 | -15.32 | 32.39 | 14.92 | 31.05 | |
| | 20600 | 844.0 | -15.55 | 32.54 | 14.84 | 30.48 | |
| Channel Bandwidth: 10 MHz / 16QAM | | | | | | | |
| X | 20425 | 826.5 | -10.02 | 32.62 | 20.45 | 110.92 | H |
| | 20525 | 836.5 | -10.02 | 32.52 | 20.35 | 108.39 | |
| | 20625 | 846.5 | -10.46 | 32.65 | 20.04 | 100.93 | |
| | 20425 | 826.5 | -16.55 | 32.76 | 14.06 | 25.47 | V |
| | 20525 | 836.5 | -16.55 | 32.39 | 13.69 | 23.39 | |
| | 20625 | 846.5 | -16.74 | 32.54 | 13.65 | 23.17 | |

Note: ERP (dBm) = Reading (dBm) + Correction Factor (dB) – 2.15

4.2 Modulation Characteristics Measurement

4.2.1 Limits of Modulation Characteristics

N/A

4.2.2 Test Setup



4.2.3 Test Procedure

Connect the EUT to Communication Simulator via the antenna connector. The frequency band is set as EUT supported Modulation and Channels, the EUT output is matched with 50 ohm load, the waveform quality and constellation of the EUT was tested.

4.2.4 Test Results

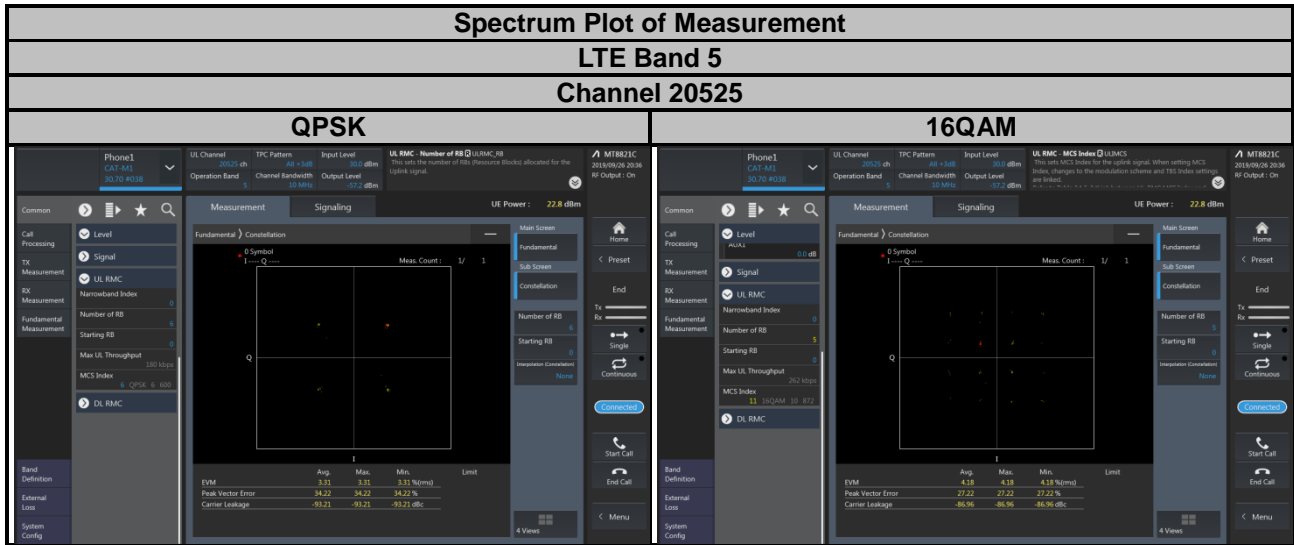

4.3 Frequency Stability Measurement

4.3.1 Limits of Frequency Stability Measurement

1.5 ppm is for base and fixed station. 2.5 ppm is for mobile station.

4.3.2 Test Procedure

- a. Device is placed at the oven room. The oven room could control the temperatures and humidity. Power warm up is at least 15 min and power applied should perform before recording frequency error.
- b. EUT is connected the external power supply to control the DC input power. The test voltage range is from minimum to maximum working voltage. Each step shall be record the frequency error rate.
- c. The temperature range step is 10 degrees in this test items. All temperature levels shall be hold the ± 0.5 °C during the measurement testing. The each temperature step shall be at least 0.5 hours, consider the EUT could be test under the stability condition.

NOTE: The frequency error was recorded frequency error from the communication simulator.

4.3.3 Test Setup

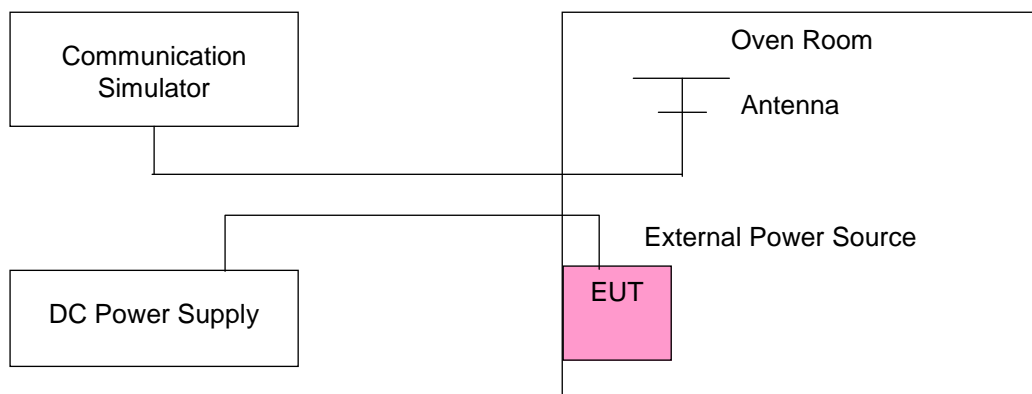

4.3.4 Test Results

Frequency Error vs. Voltage

| Voltage (Volts) | LTE Band 5 | | | | Limit (ppm) |
|-----------------|--------------------------|-----------------------|-----------------|-----------------------|-------------|
| | Channel Bandwidth: 5 MHz | | | | |
| | Low Channel | | High Channel | | |
| | Frequency (MHz) | Frequency Error (ppm) | Frequency (MHz) | Frequency Error (ppm) | |
| 3.8 | 826.500004 | 0.004 | 846.500002 | 0.002 | 2.5 |
| 3.6 | 826.500004 | 0.004 | 846.500001 | 0.001 | 2.5 |
| 4.35 | 826.500001 | 0.001 | 846.500003 | 0.004 | 2.5 |

Note: The applicant defined the normal working voltage of the battery is from 3.6 Vdc to 4.35 Vdc.

Frequency Error vs. Temperature

| Temp. (°C) | LTE Band 5 | | | | Limit (ppm) |
|------------|--------------------------|-----------------------|-----------------|-----------------------|-------------|
| | Channel Bandwidth: 5 MHz | | | | |
| | Low Channel | | High Channel | | |
| | Frequency (MHz) | Frequency Error (ppm) | Frequency (MHz) | Frequency Error (ppm) | |
| -30 | 826.500001 | 0.002 | 846.500001 | 0.001 | 2.5 |
| -20 | 826.500002 | 0.002 | 846.500004 | 0.004 | 2.5 |
| -10 | 826.500001 | 0.001 | 846.500002 | 0.002 | 2.5 |
| 0 | 826.500003 | 0.003 | 846.500002 | 0.002 | 2.5 |
| 10 | 826.500001 | 0.002 | 846.500003 | 0.003 | 2.5 |
| 20 | 826.499997 | -0.004 | 846.499998 | -0.003 | 2.5 |
| 30 | 826.499996 | -0.005 | 846.499998 | -0.003 | 2.5 |
| 40 | 826.499999 | -0.002 | 846.499996 | -0.005 | 2.5 |
| 50 | 826.499997 | -0.004 | 846.499996 | -0.004 | 2.5 |
| 60 | 824.699999 | -0.002 | 848.299997 | -0.003 | 2.5 |
| 70 | 824.699998 | -0.003 | 848.299998 | -0.002 | 2.5 |
| 80 | 824.699998 | -0.003 | 848.299999 | -0.001 | 2.5 |
| 85 | 826.499996 | -0.005 | 846.499997 | -0.003 | 2.5 |

Frequency Error vs. Voltage

| Voltage (Volts) | LTE Band 5 | | | | Limit (ppm) |
|--------------------|---------------------------|-----------------------|-----------------|-----------------------|-------------|
| | Channel Bandwidth: 10 MHz | | | | |
| | Low Channel | | High Channel | | |
| | Frequency (MHz) | Frequency Error (ppm) | Frequency (MHz) | Frequency Error (ppm) | |
| 3.8 | 829.000003 | 0.003 | 844.000001 | 0.001 | 2.5 |
| 3.6 | 829.000002 | 0.002 | 844.000003 | 0.003 | 2.5 |
| 4.35 | 829.000003 | 0.004 | 844.000004 | 0.005 | 2.5 |

Note: The applicant defined the normal working voltage of the battery is from 3.6 Vdc to 4.35 Vdc.

Frequency Error vs. Temperature

| Temp. (°C) | LTE Band 5 | | | | Limit (ppm) |
|------------|---------------------------|-----------------------|-----------------|-----------------------|-------------|
| | Channel Bandwidth: 10 MHz | | | | |
| | Low Channel | | High Channel | | |
| | Frequency (MHz) | Frequency Error (ppm) | Frequency (MHz) | Frequency Error (ppm) | |
| -30 | 829.000002 | 0.002 | 844.000003 | 0.003 | 2.5 |
| -20 | 829.000003 | 0.003 | 844.000002 | 0.002 | 2.5 |
| -10 | 829.000003 | 0.003 | 844.000003 | 0.004 | 2.5 |
| 0 | 829.000002 | 0.003 | 844.000004 | 0.005 | 2.5 |
| 10 | 829.000003 | 0.004 | 844.000003 | 0.003 | 2.5 |
| 20 | 828.999996 | -0.005 | 843.999999 | -0.002 | 2.5 |
| 30 | 828.999996 | -0.004 | 843.999997 | -0.003 | 2.5 |
| 40 | 828.999998 | -0.002 | 843.999997 | -0.004 | 2.5 |
| 50 | 828.999999 | -0.001 | 843.999997 | -0.004 | 2.5 |
| 60 | 824.699996 | -0.004 | 848.299999 | -0.002 | 2.5 |
| 70 | 824.699999 | -0.002 | 848.299996 | -0.005 | 2.5 |
| 80 | 824.699996 | -0.005 | 848.299998 | -0.002 | 2.5 |
| 85 | 828.999998 | -0.003 | 843.999999 | -0.001 | 2.5 |

4.4 Occupied Bandwidth Measurement

4.4.1 Test Procedure

The EUT makes a call to the communication simulator. All measurements were done at low, middle and high operational frequency range. The communication simulator station system controlled a EUT to export maximum output power under transmission mode and specific channel frequency. Use OBW measurement function of Spectrum analyzer to measure 99 % occupied bandwidth.

4.4.2 Test Setup

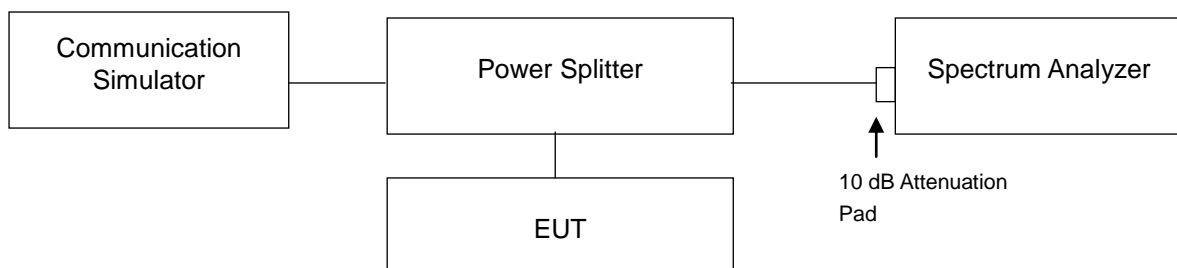

4.4.3 Test Result

| LTE Band 5 | | | | | |
|---------------------------|-----------------|-------------------------------|--------|-----------------------|-------|
| Channel Bandwidth: 5 MHz | | | | | |
| Channel | Frequency (MHz) | 99 % Occupied Bandwidth (MHz) | | 26 dB Bandwidth (MHz) | |
| | | QPSK | 16QAM | QPSK | 16QAM |
| 20425 | 826.5 | 1.0953 | 0.9248 | 1.414 | 1.302 |
| 20525 | 836.5 | 1.0855 | 0.9136 | 1.369 | 1.316 |
| 20625 | 846.5 | 1.0850 | 0.9170 | 1.362 | 1.248 |
| Channel Bandwidth: 10 MHz | | | | | |
| Channel | Frequency (MHz) | 99 % Occupied Bandwidth (MHz) | | 26 dB Bandwidth (MHz) | |
| | | QPSK | 16QAM | QPSK | 16QAM |
| 20450 | 829.0 | 1.0872 | 0.9141 | 1.372 | 1.294 |
| 20525 | 836.5 | 1.0878 | 0.9135 | 1.382 | 1.287 |
| 20600 | 844.0 | 1.0907 | 0.9161 | 1.385 | 1.367 |

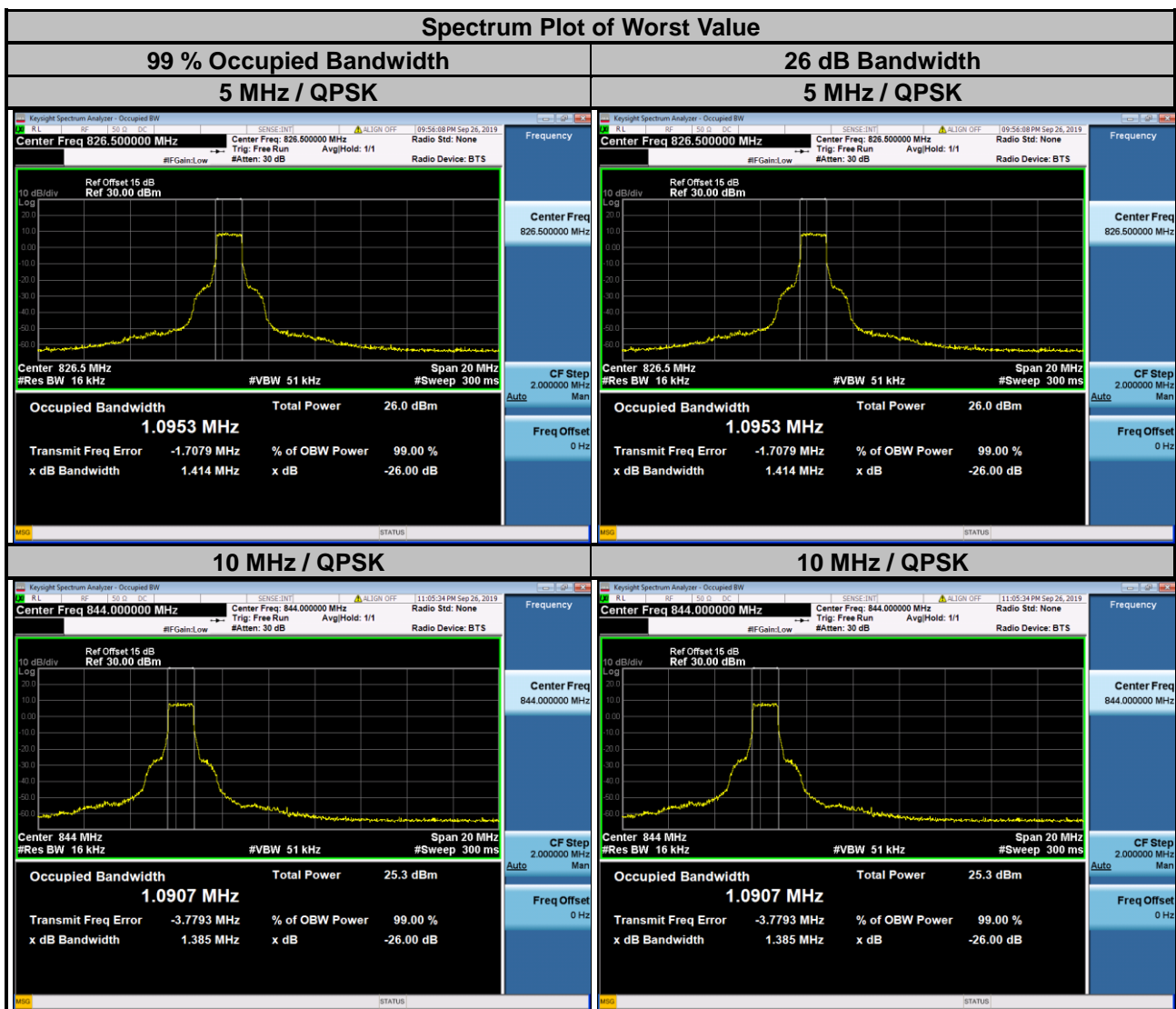

4.5 Band Edge Measurement

4.5.1 Limits of Band Edge Measurement

Power of any emission outside of the authorized operating frequency ranges must be attenuated below the transmitting power (P) by a factor of at least $43 + 10 \log(P)$ dB. In the 1 MHz bands immediately outside and adjacent to the frequency block a resolution bandwidth of at least one percent of the emission bandwidth of the fundamental emission of the transmitter may be employed.

4.5.2 Test Setup

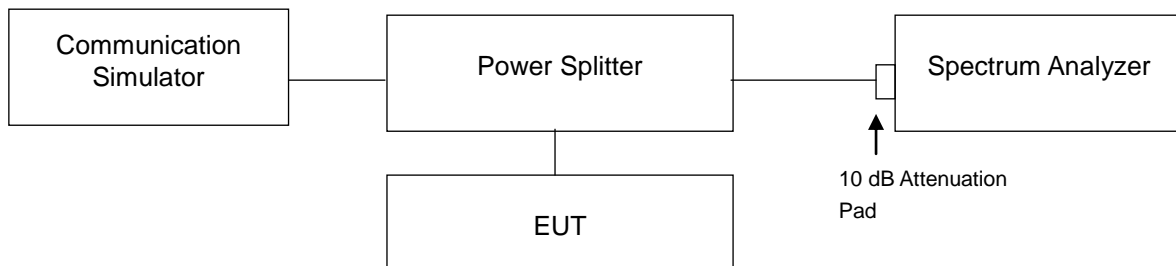

4.5.3 Test Procedures

- All measurements were done at low and high operational frequency range.
- The center frequency of spectrum is the band edge frequency and span is 1 MHz. RB of the spectrum is 62 kHz and VB of the spectrum is 200 kHz (LTE Bandwidth 5 MHz).
- The center frequency of spectrum is the band edge frequency and span is 1 MHz. RB of the spectrum is 100 kHz and VB of the spectrum is 300 kHz (LTE Bandwidth 10 MHz).
- Record the max trace plot into the test report.

4.5.4 Test Results

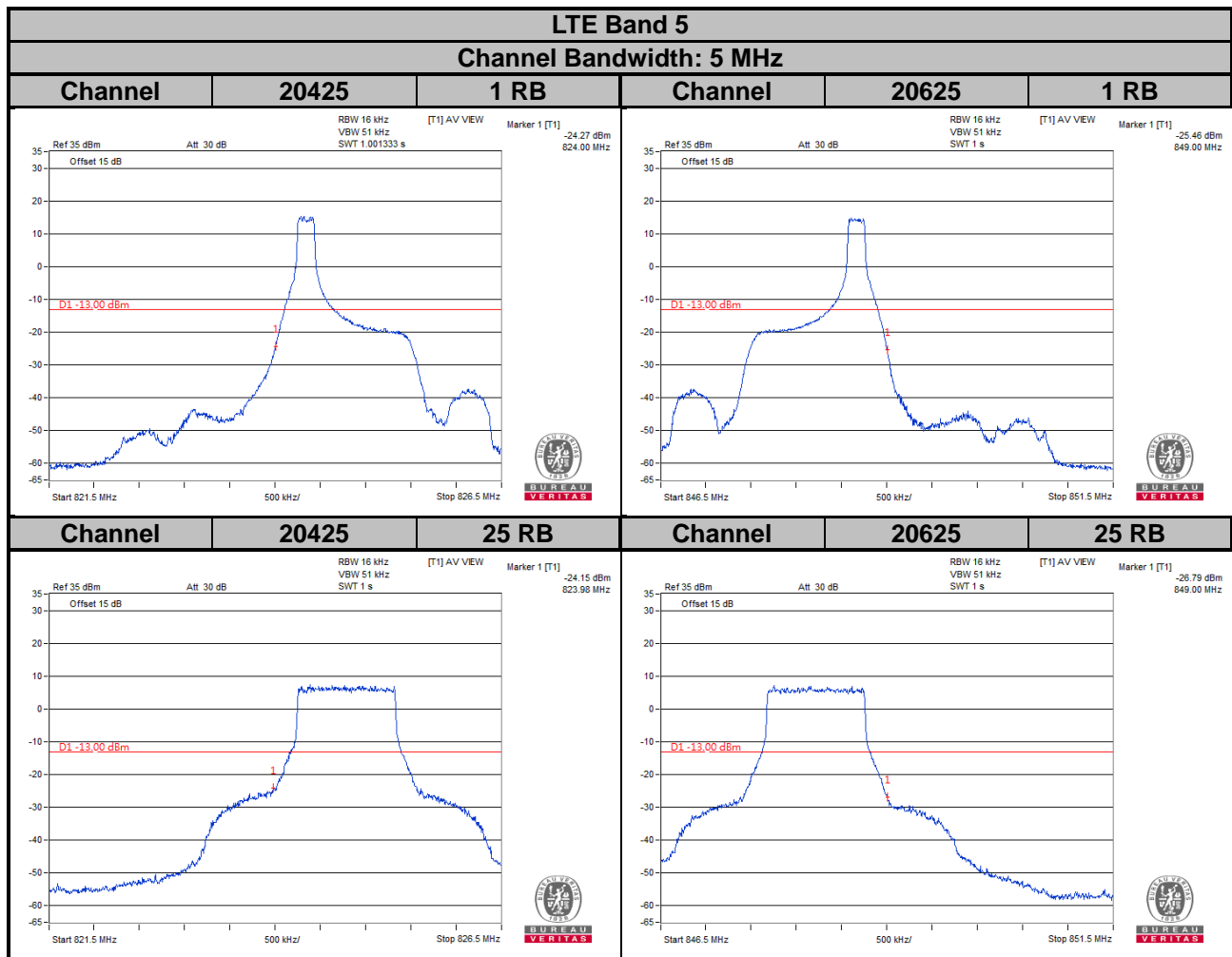

LTE Band 5
Channel Bandwidth: 10 MHz

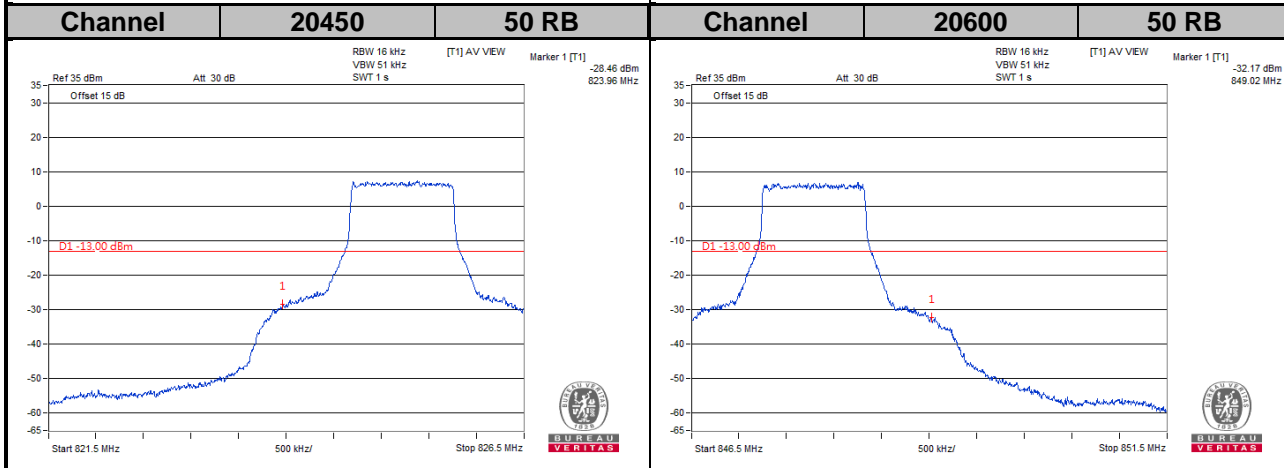
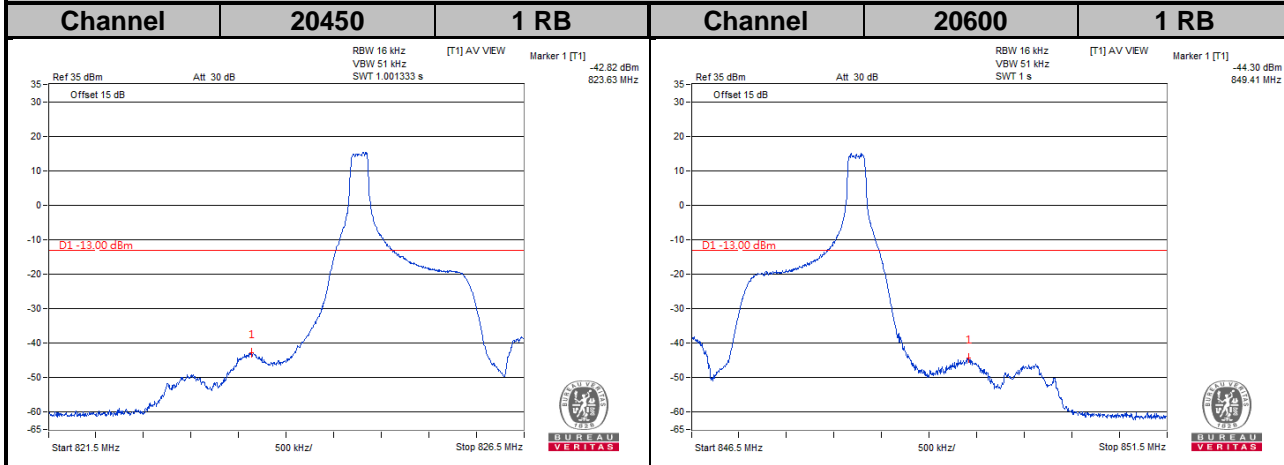

4.6 Peak to Average Ratio

4.6.1 Limits of Peak to Average Ratio Measurement

In measuring transmissions in this band using an average power technique, the peak to-average ratio (PAR) of the transmission may not exceed 13 dB.

4.6.2 Test Setup

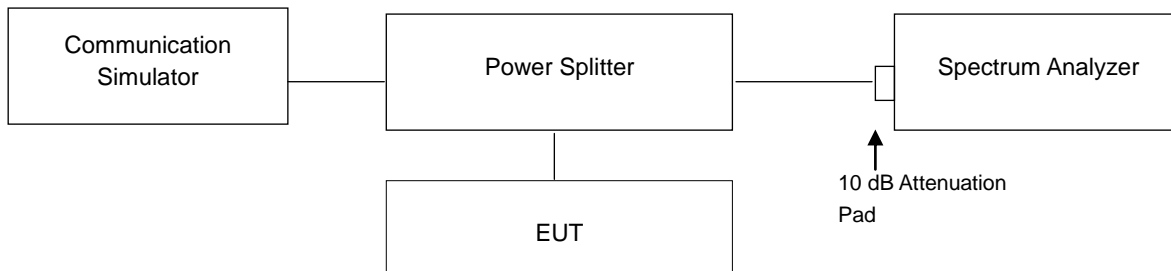

4.6.3 Test Procedures

1. Set resolution/measurement bandwidth \geq signal's occupied bandwidth;
2. Set the number of counts to a value that stabilizes the measured CCDF curve;
3. Record the maximum PAPR level associated with a probability of 0.1 %.

4.6.4 Test Results

| LTE Band 5 | | | | | | | |
|--------------------------|-----------------|----------------------------|-------|---------------------------|-----------------|----------------------------|-------|
| Channel Bandwidth: 5 MHz | | | | Channel Bandwidth: 10 MHz | | | |
| Channel | Frequency (MHz) | Peak to Average Ratio (dB) | | Channel | Frequency (MHz) | Peak to Average Ratio (dB) | |
| | | QPSK | 16QAM | | | QPSK | 16QAM |
| 20425 | 826.5 | 3.77 | 4.21 | 20450 | 829.0 | 3.71 | 4.20 |
| 20525 | 836.5 | 3.97 | 4.23 | 20525 | 836.5 | 3.93 | 4.20 |
| 20625 | 846.5 | 3.99 | 4.41 | 20600 | 844.0 | 3.95 | 4.33 |

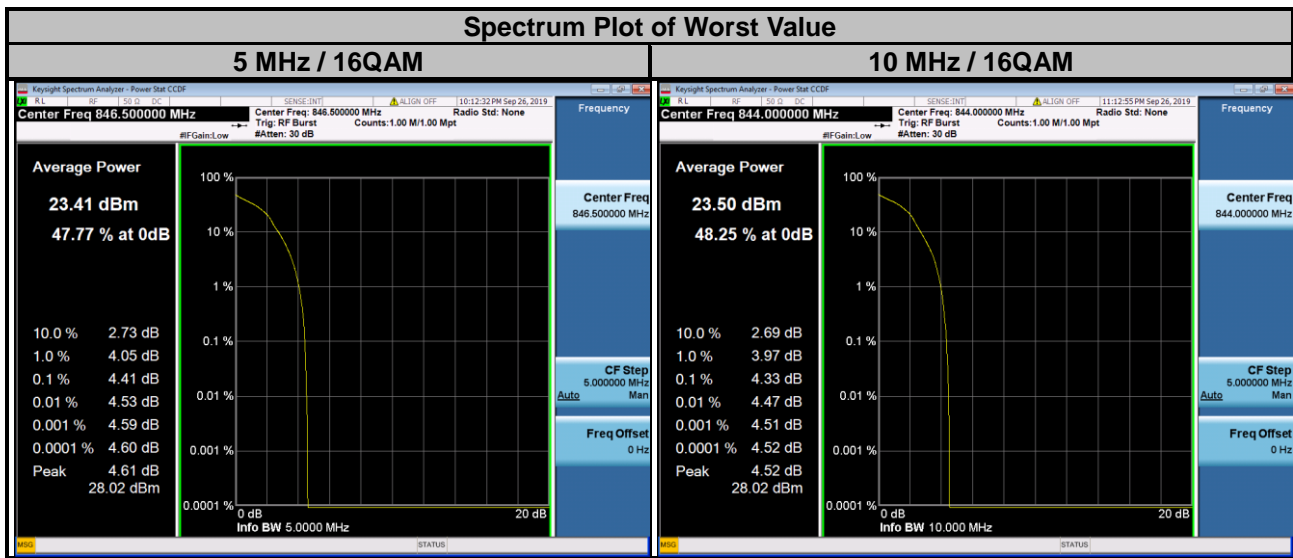

4.7 Conducted Spurious Emissions

4.7.1 Limits of Conducted Spurious Emissions Measurement

The power of any emission outside of the authorized operating frequency ranges must be attenuated below the transmitting power (P) by a factor of at least $43 + 10 \log(P)$ dB. The emission limit equal to -13 dBm.

4.7.2 Test Setup

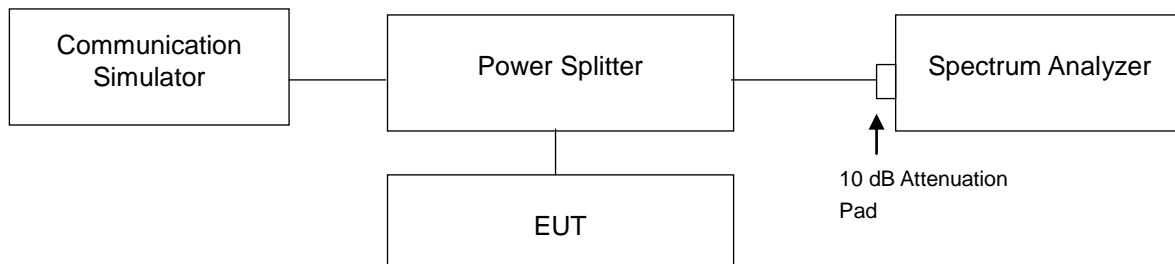

4.7.3 Test Procedure

- The EUT makes a phone call to the communication simulator. All measurements were done at low, middle and high operational frequency range.
- Measuring frequency range is from 9 kHz to 1 GHz. 10 dB attenuation pad is connected with spectrum. RBW = 100 kHz and VBW = 300 kHz is used for conducted emission measurement.
- Measuring frequency range is from 1 GHz to 9 GHz. 10 dB attenuation pad is connected with spectrum. RBW = 1 MHz and VBW = 3 MHz is used for conducted emission measurement.

4.7.4 Test Results

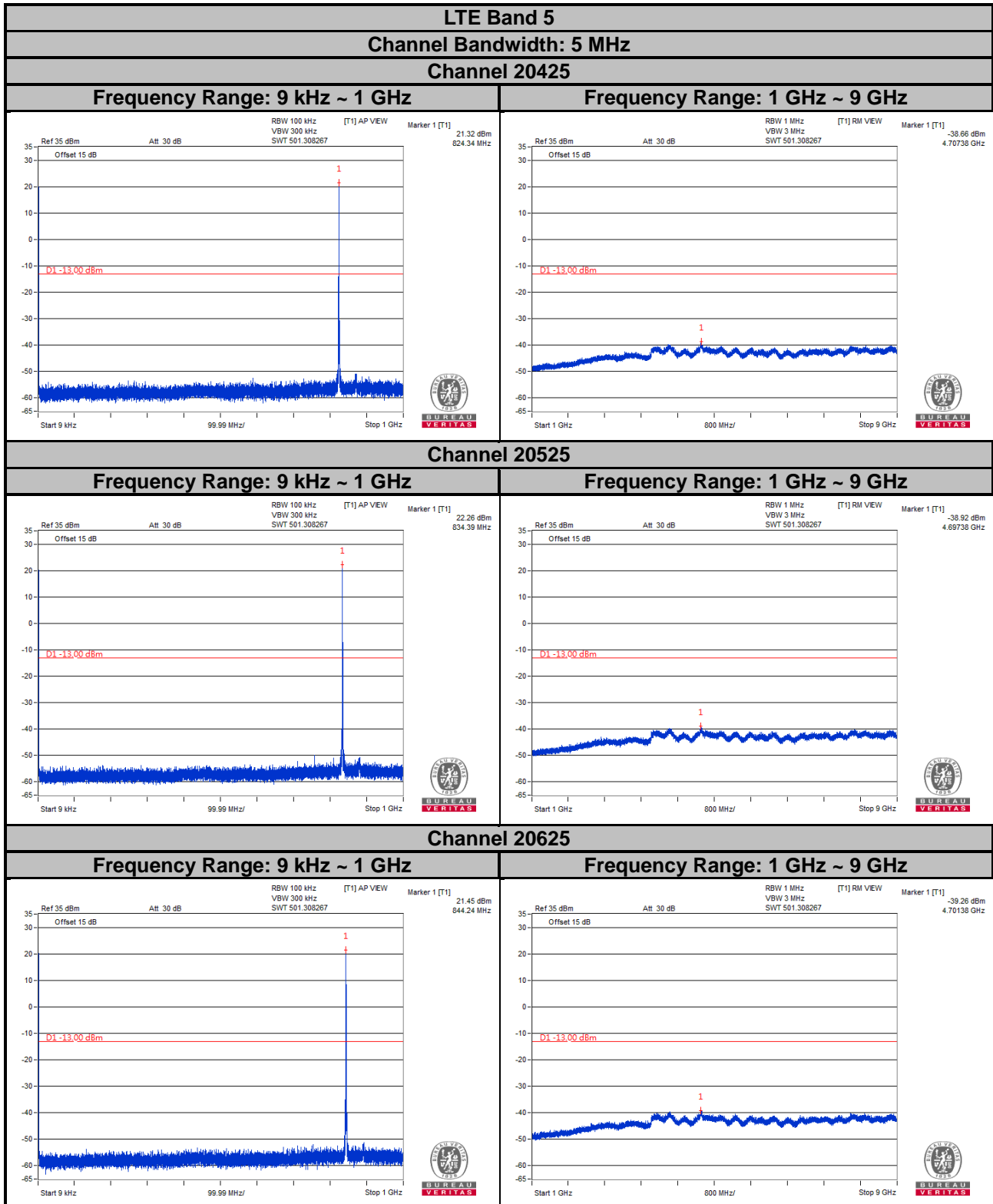

Note: The signal over the limit in 9 kHz is from spectrum analyzer.

LTE Band 5
Channel Bandwidth: 10 MHz
Channel 20450

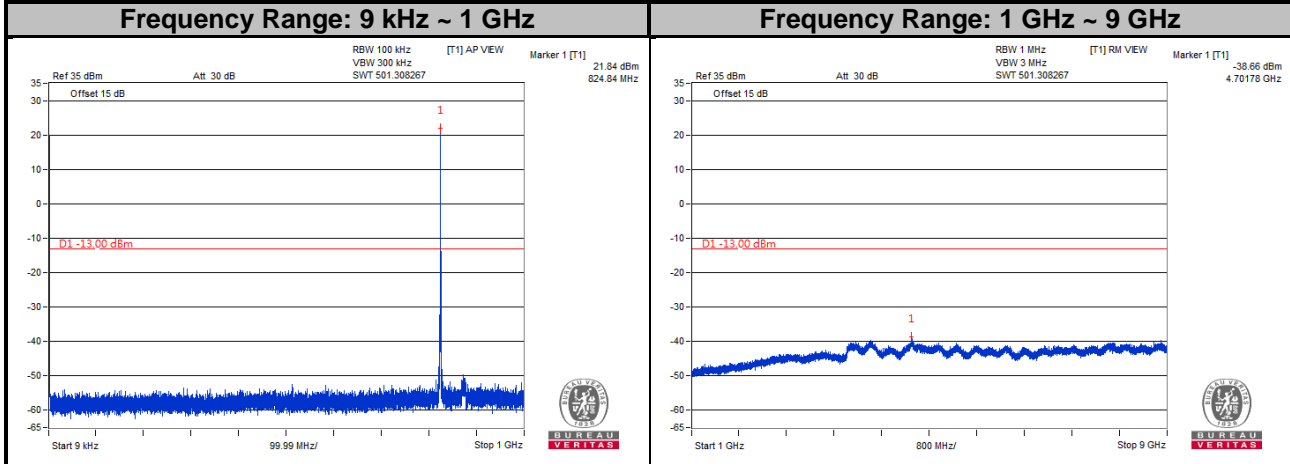

Channel 20525

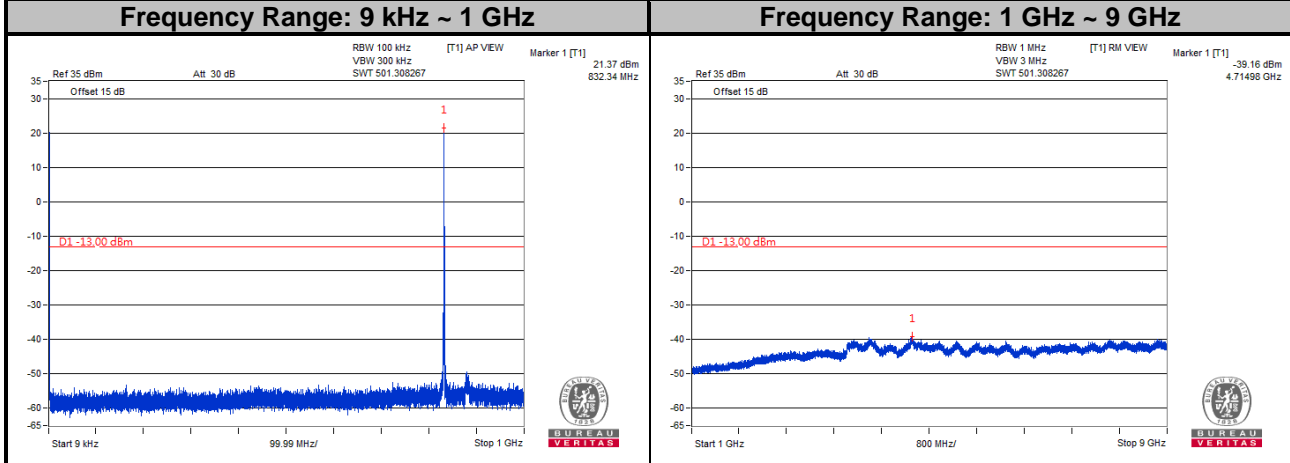

Channel 20600

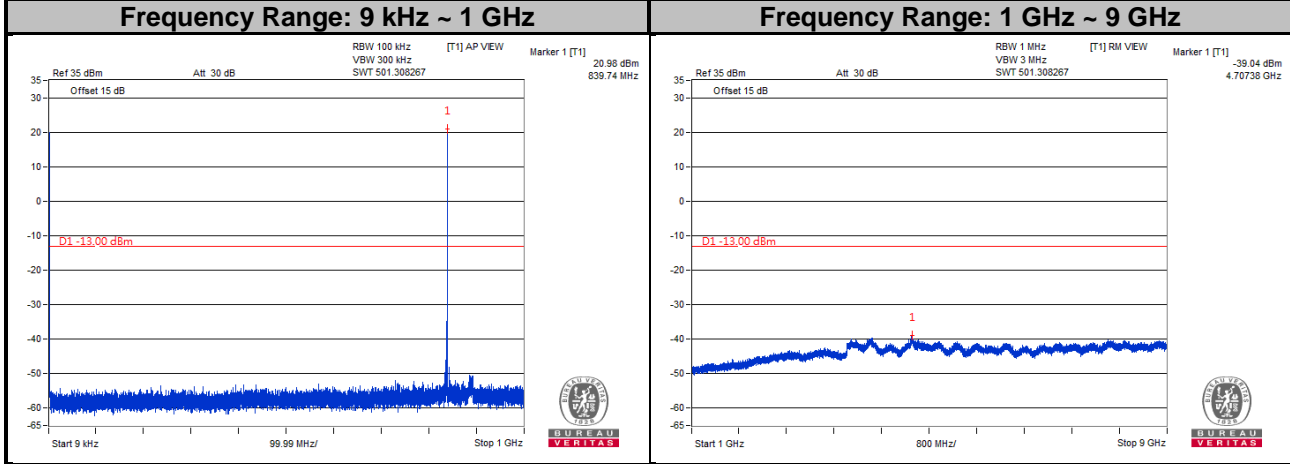

Note: The signal over the limit in 9 kHz is from spectrum analyzer.

4.8 Radiated Emission Measurement

4.8.1 Limits of Radiated Emission Measurement

The power of any emission outside of the authorized operating frequency ranges must be attenuated below the transmitting power (P) by a factor of at least $43 + 10 \log(P)$ dB. The emission limit is equal to -13 dBm.

4.8.2 Test Procedure

- a. Substitution method is used for E.I.R.P measurement. In the semi-anechoic chamber, EUT placed on the 0.8 m (below or equal 1 GHz) and/or 1.5 m (above 1 GHz) height of Turn Table, rotated the table around 360 degrees to search the maximum radiation power and receiver antenna shall be rotated vertical and horizontal polarization and moved height from 1 m to 4 m to find the maximum polar radiated power. The "Read Value" is the spectrum reading the maximum power value.
- b. The substitution horn antenna is substituted for EUT at the same position and signals generator export the CW signal to the substitution antenna via a TX cable. Rotated the Turn Table and moved receiving antenna to find the maximum radiation power. Adjust output power level of S.G to get a Value of spectrum reading equal to "Read Value" of step a. Record the power level of S.G
- c. EIRP = Output power level of S.G – TX cable loss + Antenna gain of substitution horn.
- d. E.R.P power can be calculated form E.I.R.P power by subtracting the gain of dipole, E.R.P power = E.I.R.P power - 2.15 dB.

NOTE: The resolution bandwidth and video bandwidth of test receiver/spectrum analyzer is 1 MHz/3 MHz.

4.8.3 Deviation from Test Standard

No deviation.

4.8.4 Test Setup

<Radiated Emission below or equal 1 GHz>

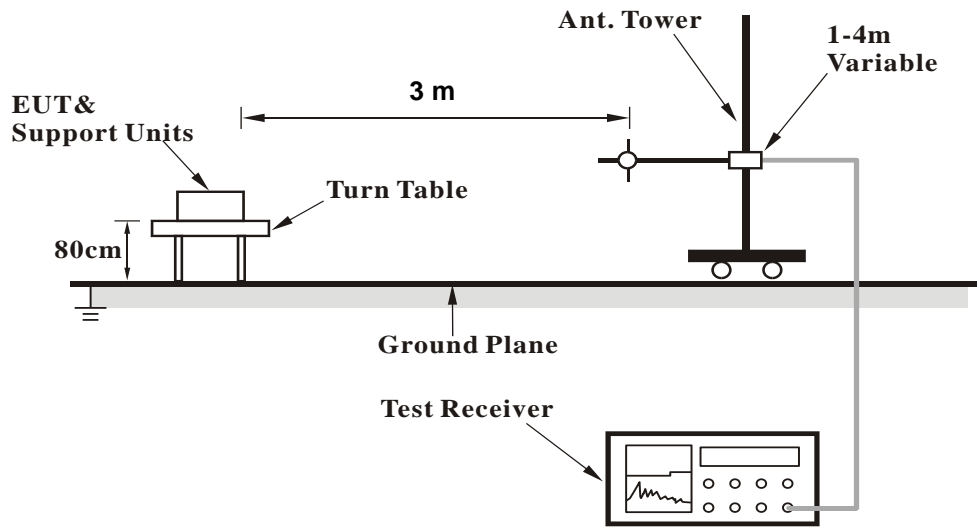

<Radiated Emission above 1 GHz>

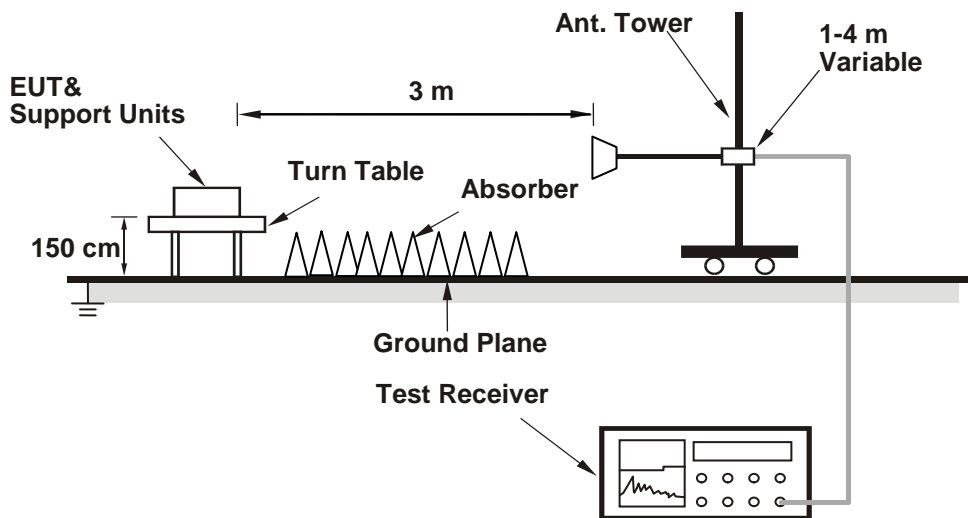

For the actual test configuration, please refer to the attached file (Test Setup Photo).

4.8.5 Test Results

LTE Band 5

Channel Bandwidth: 5 MHz / QPSK

Low Channel



Bureau Veritas Consumer Products Services Ltd., Taoyuan Branch

A D T

Data: 3

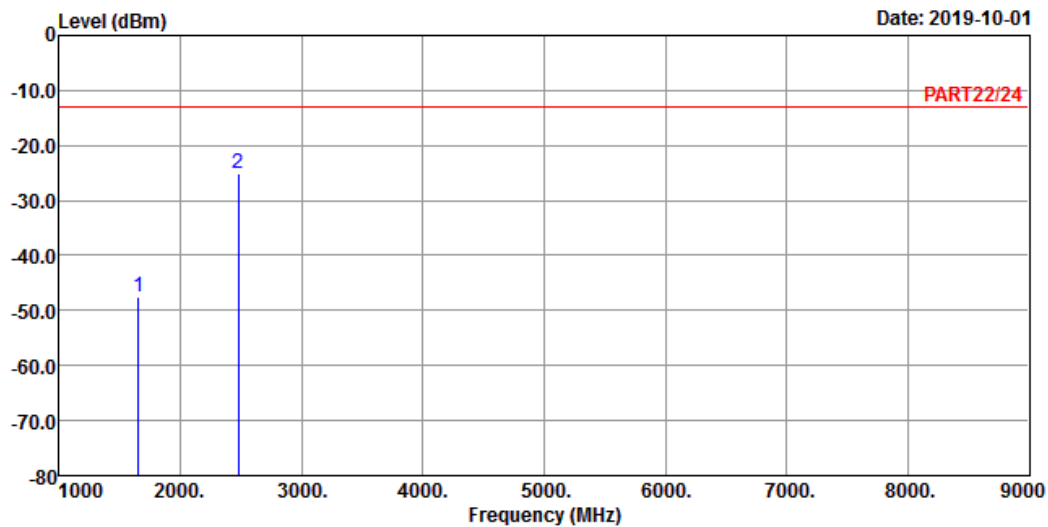

Site : 966 Chamber 5
 Condition: PART22/24 HORIZONTAL
 Remak : Cat-M1 Band 5 QPSK_5M Link_L-CH
 Tested by: tim-chen

| | Freq | Level | Read Level | Limit | Line Factor | Over Limit | Remark |
|------|---------|--------|------------|--------|-------------|------------|--------|
| | MHz | dBm | dBm | dBm | dB | dB | |
| 1 | 1653.00 | -47.46 | -33.69 | -13.00 | -13.77 | -34.46 | Peak |
| 2 pp | 2479.50 | -24.99 | -14.96 | -13.00 | -10.03 | -11.99 | Peak |



A D T

Data: 4

Date: 2019-10-01

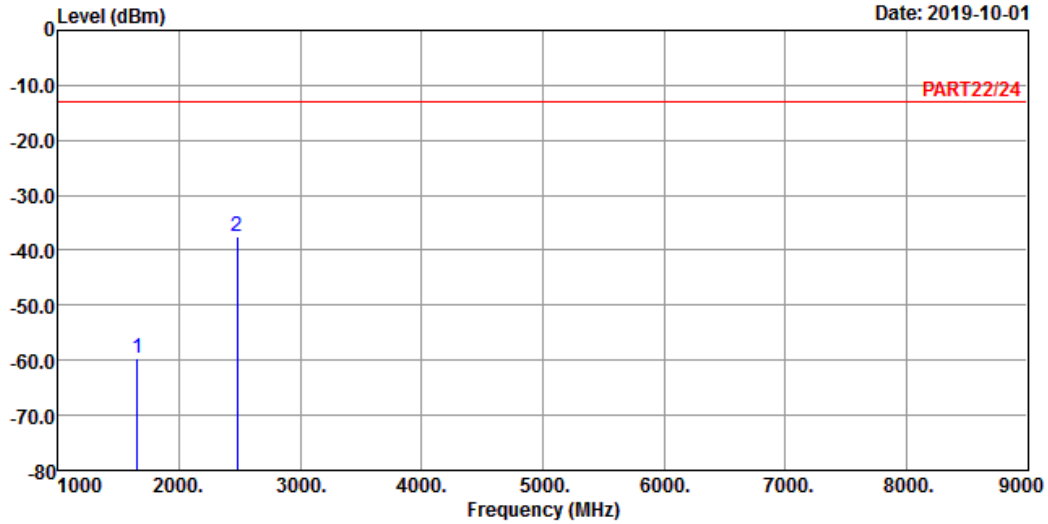

Site : 966 Chamber 5
 Condition: PART22/24 VERTICAL
 Remak : Cat-M1 Band 5 QPSK_5M Link_L-CH
 Tested by: tim-chen

| | Freq | Level | Read Level | Limit | Line Factor | Over Limit | Remark |
|------|---------|--------|------------|--------|-------------|------------|--------|
| | MHz | dBm | dBm | dBm | dB | dB | |
| 1 | 1653.00 | -59.57 | -45.80 | -13.00 | -13.77 | -46.57 | Peak |
| 2 pp | 2479.50 | -37.47 | -27.44 | -13.00 | -10.03 | -24.47 | Peak |

Middle Channel



Bureau Veritas Consumer Products Services Ltd., Taoyuan Branch

A D T

Data: 3

Date: 2019-10-01

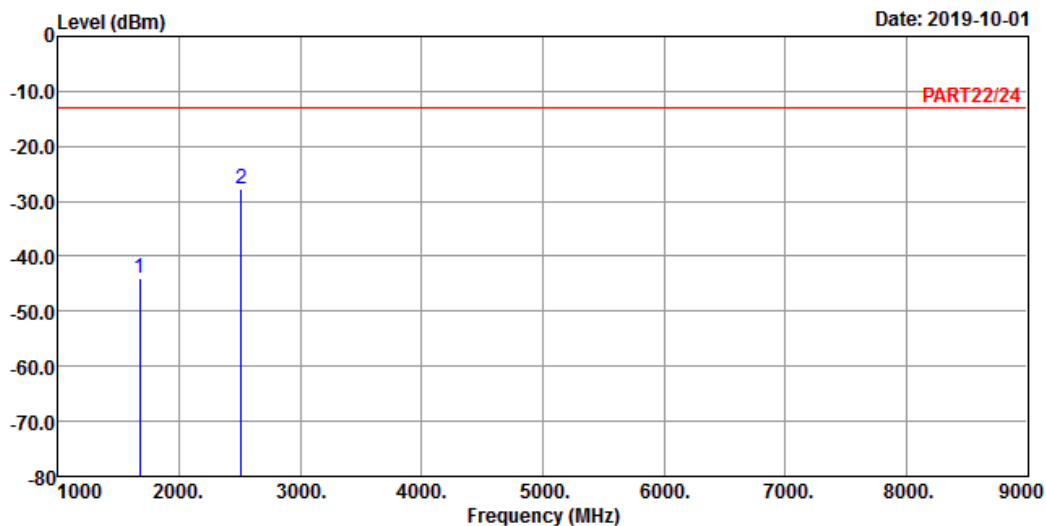

Site : 966 Chamber 5
 Condition: PART22/24 HORIZONTAL
 Remak : Cat-M1 Band 5 QPSK_5M Link_M-CH
 Tested by: tim-chen

| | Freq | Level | Read Level | Limit | Line Factor | Over Limit | Remark |
|---|---------|--------|------------|--------|-------------|------------|--------|
| | MHz | dBm | dBm | dBm | dB | dB | |
| 1 | 1673.00 | -43.91 | -30.01 | -13.00 | -13.90 | -30.91 | Peak |
| 2 | 2509.50 | -27.73 | -17.65 | -13.00 | -10.08 | -14.73 | Peak |



Bureau Veritas Consumer Products Services Ltd., Taoyuan Branch

A D T

Data: 4

Date: 2019-10-01

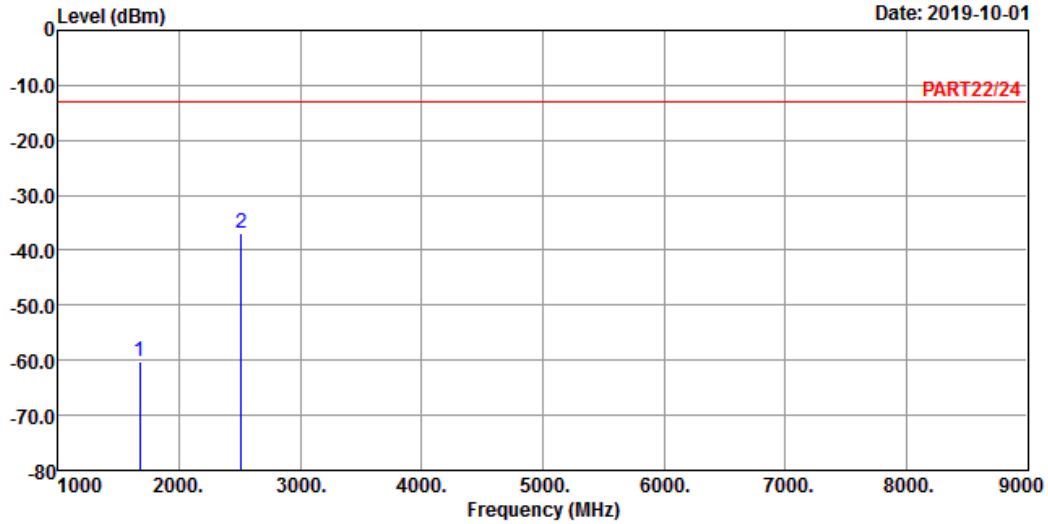

Site : 966 Chamber 5
 Condition: PART22/24 VERTICAL
 Remak : Cat-M1 Band 5 QPSK_5M Link_M-CH
 Tested by: tim-chen

| | Freq | Level | Read Level | Limit | Line Factor | Over Limit | Remark |
|------|---------|--------|------------|--------|-------------|------------|--------|
| | MHz | dBm | dBm | dBm | dB | dB | |
| 1 | 1673.00 | -60.13 | -46.23 | -13.00 | -13.90 | -47.13 | Peak |
| 2 pp | 2509.50 | -36.96 | -26.88 | -13.00 | -10.08 | -23.96 | Peak |

High Channel



Bureau Veritas Consumer Products Services Ltd., Taoyuan Branch

A D T

Data: 3

Date: 2019-10-01

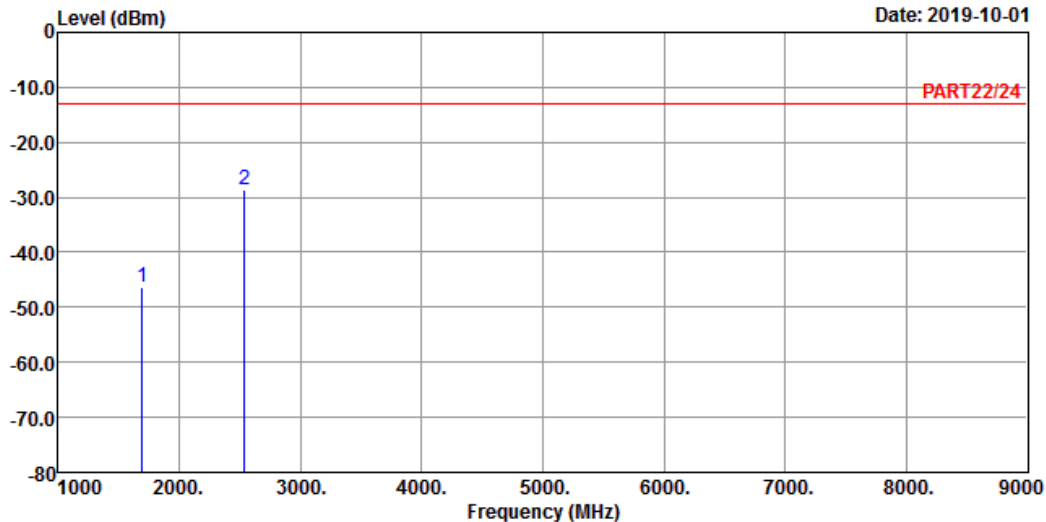

Site : 966 Chamber 5
 Condition: PART22/24 HORIZONTAL
 Remak : Cat-M1 Band 5 QPSK_5M Link_H-CH
 Tested by: tim-chen

| | Freq | Level | Read Level | Limit | Line Factor | Over Limit | Remark |
|------|---------|--------|------------|--------|-------------|------------|--------|
| | MHz | dBm | dBm | dBm | dB | dB | |
| 1 | 1693.00 | -46.40 | -32.38 | -13.00 | -14.02 | -33.40 | Peak |
| 2 pp | 2539.50 | -28.63 | -18.57 | -13.00 | -10.06 | -15.63 | Peak |



A D T

Data: 4

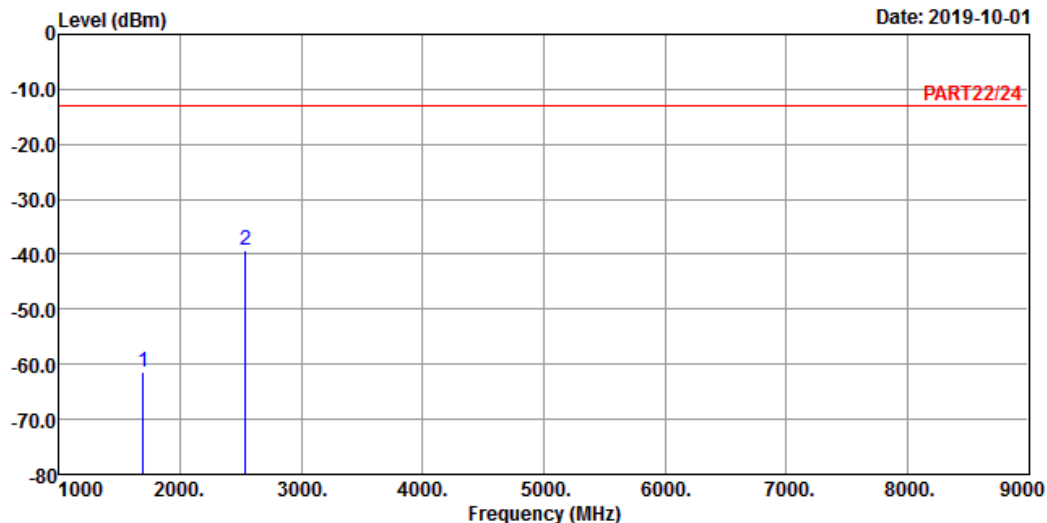

Site : 966 Chamber 5
 Condition: PART22/24 VERTICAL
 Remak : Cat-M1 Band 5 QPSK_5M Link_H-CH
 Tested by: tim-chen

| | Freq | Level | Read Level | Limit | Line Factor | Over Limit | Remark |
|------|---------|--------|------------|--------|-------------|------------|--------|
| | MHz | dBm | dBm | dBm | dB | dB | |
| 1 | 1693.00 | -61.33 | -47.31 | -13.00 | -14.02 | -48.33 | Peak |
| 2 pp | 2539.50 | -39.20 | -29.14 | -13.00 | -10.06 | -26.20 | Peak |

Channel Bandwidth: 10 MHz / QPSK
Low Channel



Bureau Veritas Consumer Products Services Ltd., Taoyuan Branch

A D T

Data: 5

Date: 09-28-2019

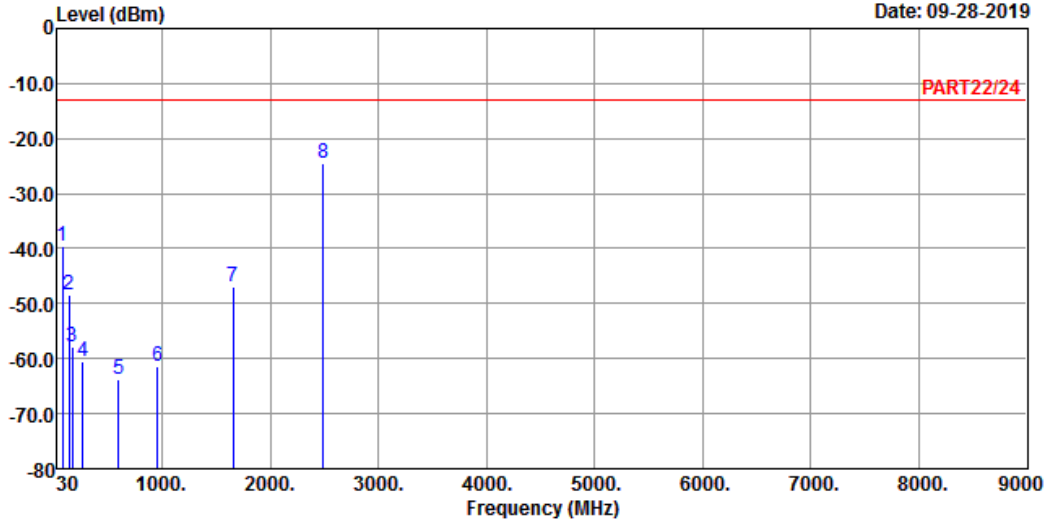

Site : 966 Chamber 5
Condition: PART22/24 HORIZONTAL
Remak : Cat-M1 Band 5 QPSK_10M Link_L-CH
Tested by: Thomas Wei

| | Freq | Level | Read Level | Limit | Line Factor | Over Limit | Remark |
|------|---------|--------|------------|--------|-------------|------------|--------|
| | MHz | dBm | dBm | dBm | dB | dB | |
| 1 | 76.56 | -39.69 | -29.71 | -13.00 | -9.98 | -26.69 | Peak |
| 2 | 136.70 | -48.35 | -39.69 | -13.00 | -8.66 | -35.35 | Peak |
| 3 | 170.65 | -57.88 | -52.18 | -13.00 | -5.70 | -44.88 | Peak |
| 4 | 266.68 | -60.41 | -54.08 | -13.00 | -6.33 | -47.41 | Peak |
| 5 | 595.51 | -63.62 | -62.67 | -13.00 | -0.95 | -50.62 | Peak |
| 6 | 959.26 | -61.48 | -63.62 | -13.00 | 2.14 | -48.48 | Peak |
| 7 | 1658.00 | -47.00 | -33.20 | -13.00 | -13.80 | -34.00 | Peak |
| 8 pp | 2487.00 | -24.52 | -14.47 | -13.00 | -10.05 | -11.52 | Peak |



Bureau Veritas Consumer Products Services Ltd., Taoyuan Branch

A D T

Data: 6

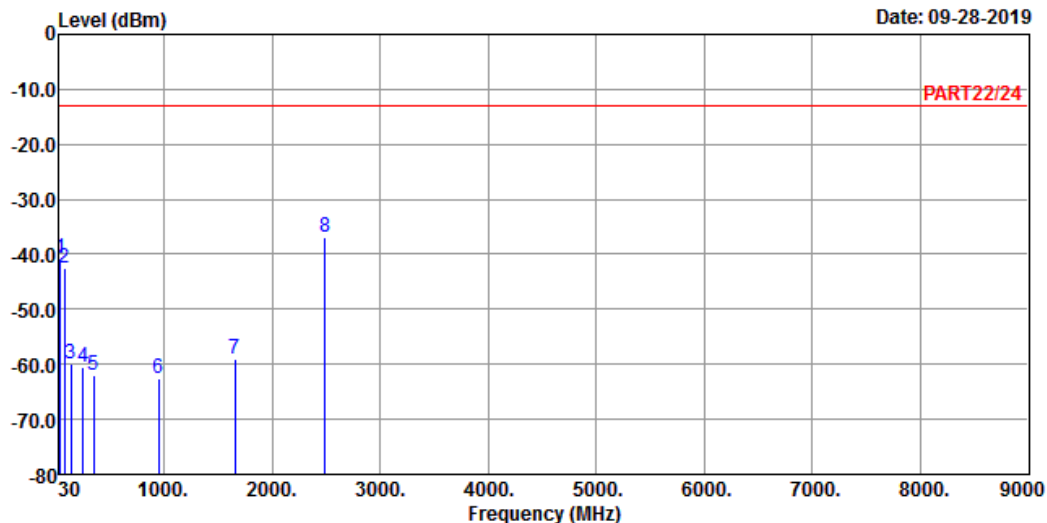

Site : 966 Chamber 5
 Condition: PART22/24 VERTICAL
 Remak : Cat-M1 Band 5 QPSK_10M Link_L-CH
 Tested by: Thomas Wei

| | Freq | Level | Read Level | Limit Line | Factor | Over Limit | Remark |
|------|---------|--------|------------|------------|--------|------------|--------|
| | MHz | dBm | dBm | dBm | dB | dB | |
| 1 | 40.67 | -40.82 | -40.94 | -13.00 | 0.12 | -27.82 | Peak |
| 2 | 75.59 | -42.47 | -32.72 | -13.00 | -9.75 | -29.47 | Peak |
| 3 | 136.70 | -59.82 | -51.16 | -13.00 | -8.66 | -46.82 | Peak |
| 4 | 251.16 | -60.38 | -54.37 | -13.00 | -6.01 | -47.38 | Peak |
| 5 | 346.22 | -62.10 | -55.80 | -13.00 | -6.30 | -49.10 | Peak |
| 6 | 952.47 | -62.68 | -64.58 | -13.00 | 1.90 | -49.68 | Peak |
| 7 | 1658.00 | -59.05 | -45.25 | -13.00 | -13.80 | -46.05 | Peak |
| 8 pp | 2487.00 | -36.97 | -26.92 | -13.00 | -10.05 | -23.97 | Peak |

Middle Channel



Bureau Veritas Consumer Products Services Ltd., Taoyuan Branch

A D T

Data: 3

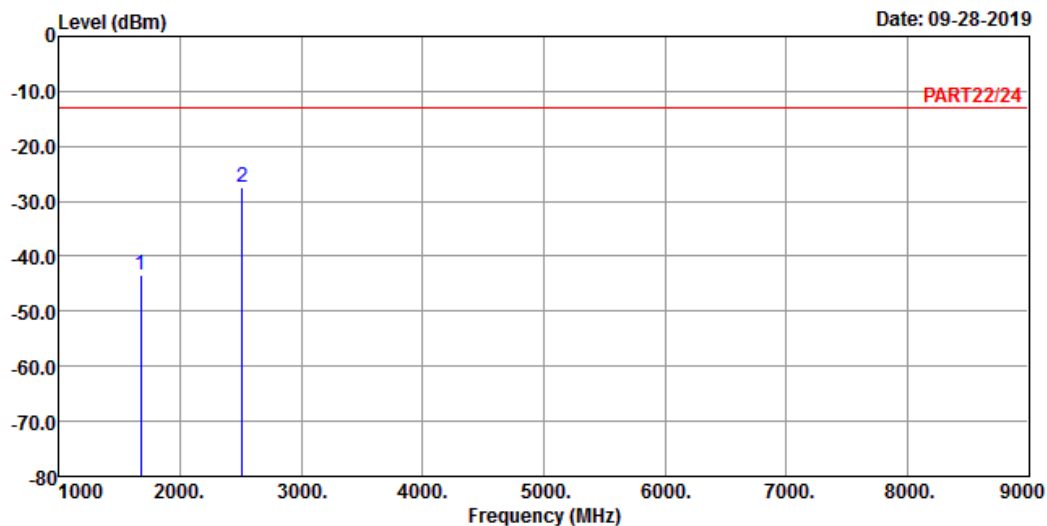

Site : 966 Chamber 5
 Condition: PART22/24 HORIZONTAL
 Remak : Cat-M1 Band 5 QPSK_10M Link_M-CH
 Tested by: Thomas Wei

| | Freq | Level | Read Level | Limit | Line Factor | Over Limit | Remark |
|------|---------|--------|------------|--------|-------------|------------|--------|
| | MHz | dBm | dBm | dBm | dB | dB | |
| 1 | 1673.00 | -43.45 | -29.55 | -13.00 | -13.90 | -30.45 | Peak |
| 2 pp | 2509.50 | -27.33 | -17.25 | -13.00 | -10.08 | -14.33 | Peak |



Bureau Veritas Consumer Products Services Ltd., Taoyuan Branch

A D T

Data: 4

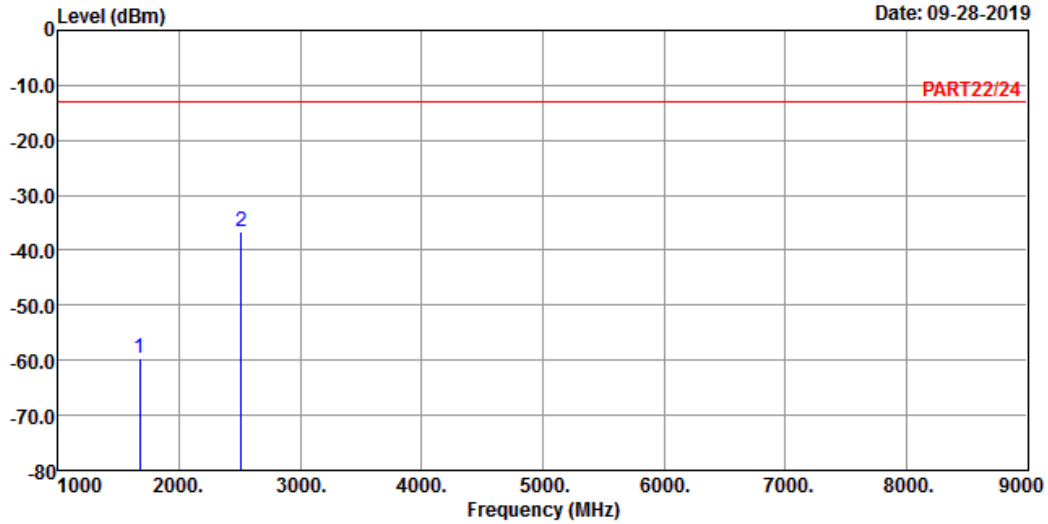

Site : 966 Chamber 5
 Condition: PART22/24 VERTICAL
 Remak : Cat-M1 Band 5 QPSK_10M Link_M-CH
 Tested by: Thomas Wei

| | Freq | Level | Read Level | Limit | Line Factor | Over Limit | Remark |
|------|---------|--------|------------|--------|-------------|------------|--------|
| | MHz | dBm | dBm | dBm | dB | dB | |
| 1 | 1673.00 | -59.77 | -45.87 | -13.00 | -13.90 | -46.77 | Peak |
| 2 pp | 2509.50 | -36.47 | -26.39 | -13.00 | -10.08 | -23.47 | Peak |

High Channel



Bureau Veritas Consumer Products Services Ltd., Taoyuan Branch

A D T

Data: 3

Date: 09-28-2019

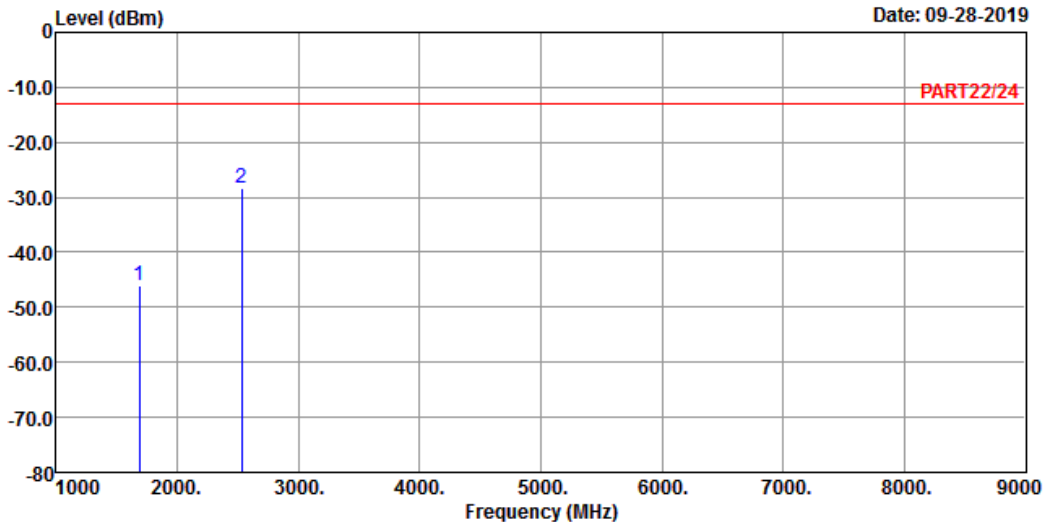

Site : 966 Chamber 5
 Condition: PART22/24 HORIZONTAL
 Remak : Cat-M1 Band 5 QPSK_10M Link_H-CH
 Tested by: Thomas Wei

| | Freq | Level | Read Level | Limit | Line Factor | Over Limit | Remark |
|------|---------|--------|------------|--------|-------------|------------|--------|
| | MHz | dBm | dBm | dBm | dB | dB | |
| 1 | 1688.00 | -46.15 | -32.16 | -13.00 | -13.99 | -33.15 | Peak |
| 2 pp | 2532.00 | -28.20 | -18.13 | -13.00 | -10.07 | -15.20 | Peak |



Bureau Veritas Consumer Products Services Ltd., Taoyuan Branch

A D T

Data: 4

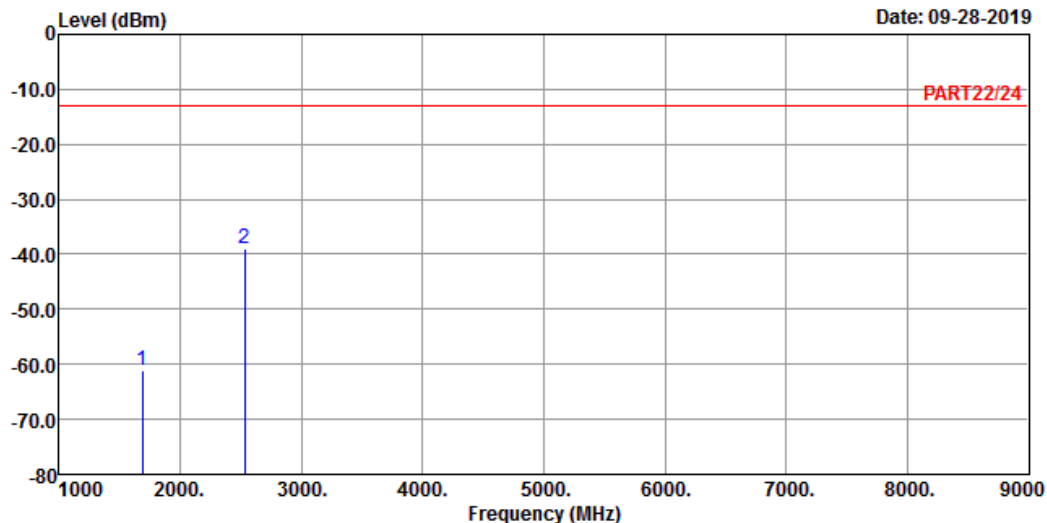

Site : 966 Chamber 5
 Condition: PART22/24 VERTICAL
 Remak : Cat-M1 Band 5 QPSK_10M Link_H-CH
 Tested by: Thomas Wei

| | Freq | Level | Read Level | Limit | Line Factor | Over Limit | Remark |
|------|---------|--------|------------|--------|-------------|------------|--------|
| | MHz | dBm | dBm | dBm | dB | dB | |
| 1 | 1688.00 | -61.01 | -47.02 | -13.00 | -13.99 | -48.01 | Peak |
| 2 pp | 2532.00 | -38.88 | -28.81 | -13.00 | -10.07 | -25.88 | Peak |

5 Pictures of Test Arrangements

Please refer to the attached file (Test Setup Photo).

Appendix – Information of the Testing Laboratories

We, Bureau Veritas Consumer Products Services (H.K.) Ltd., Taoyuan Branch, were founded in 1988 to provide our best service in EMC, Radio, Telecom and Safety consultation. Our laboratories are FCC recognized accredited test firms and accredited according to ISO/IEC 17025.

If you have any comments, please feel free to contact us at the following:

Lin Kou EMC/RF Lab

Tel: 886-2-26052180

Fax: 886-2-26051924

Hsin Chu EMC/RF/Telecom Lab

Tel: 886-3-6668565

Fax: 886-3-6668323

Hwa Ya EMC/RF/Safety Lab

Tel: 886-3-3183232

Fax: 886-3-3270892

Email: service.adt@tw.bureauveritas.com

Web Site: www.bureauveritas-adt.com

The address and road map of all our labs can be found in our web site also.

--- END ---