

Test Report No:
 75461RRF.004

Test Report

USA FCC Part 90

CANADA RSS-140

(*) Identification of item tested	LTE Cat 1bis module
(*) Trademark	Sequans Communications
(*) Model and /or type reference	GC02S1-NA2
Other identification of the product	FCC ID: 2AAGMGC02SA IC: 12732A-GC02SA
(*) Features	4G LTE module HW version: Rev1 SW version: LR9.0.1.1-59215
Applicant	SEQUANS COMMUNICATIONS 55 Boulevard Charles de Gaulle, 92700 Colombes, France
Test method requested, standard	USA FCC Part 90 (10-1-21 Edition). CANADA RSS-140 Issue 1, April 2018 ANSI C63.26-2015. KDB 971168 D01 Power Meas License Digital Systems v03r01, April. 2018.
Summary	IN COMPLIANCE
Approved by (name / position & signature)	José Manuel Gómez Galván EMC Consumer & RF Lab. Manager
Date of issue	2023-11-08
Report template No	FDT08_24 (* "Data provided by the client")

Index

Competences and guarantees	3
General conditions	3
Uncertainty	3
Data provided by the client.....	3
Usage of samples	4
Test sample description	4
Identification of the client.....	5
Testing period and place.....	5
Document history	5
Environmental conditions	5
Remarks and comments	6
Testing verdicts.....	7
Summary	7
Appendix A: Test results for FCC 90 / RSS-140: LTE Cat 1bis Band 14	8

Competences and guarantees

DEKRA Testing and Certification is a testing laboratory accredited by the National Accreditation Body (ENAC - Entidad Nacional de Acreditación) to perform the tests indicated in the Certificate No. 51/LE 147.

DEKRA Testing and Certification is an FCC-recognized accredited testing laboratory with appropriate scope of accreditation that covers the performed tests in this report.

In order to assure the traceability to other national and international laboratories, DEKRA Testing and Certification has a calibration and maintenance program for its measurement equipment.

DEKRA Testing and Certification guarantees the reliability of the data presented in this report, which is the result of the measurements and the tests performed to the item under test on the date and under the conditions stated on the report and it is based on the knowledge and technical facilities available at DEKRA Testing and Certification at the time of performance of the test.

DEKRA Testing and Certification is liable to the client for the maintenance of the confidentiality of all information related to the item under test and the results of the test.

The results presented in this Test Report apply only to the particular item under test established in this document.

IMPORTANT: No parts of this report may be reproduced or quoted out of context, in any form or by any means, except in full, without the previous written permission of DEKRA Testing and Certification.

General conditions

1. This report is only referred to the item that has undergone the test.
2. This report does not constitute or imply on its own an approval of the product by the Certification Bodies or competent Authorities.
3. This document is only valid if complete; no partial reproduction can be made without previous written permission of DEKRA Testing and Certification S.A.U.
4. This test report cannot be used partially or in full for publicity and/or promotional purposes without previous written permission of DEKRA Testing and Certification S.A.U. and the Accreditation Bodies.

Uncertainty

Uncertainty (factor $k=2$) was calculated according to the DEKRA Testing and Certification S.A.U. internal document PODT000.

Data provided by the client

The following data has been provided by the client:

1. Information relating to the description of the sample ("Identification of the item tested", "Trademark", "Model and/or type reference tested").
2. The sample model is GC02S1-NA2. The Calliope 2 GC02S1 modules are based on Sequans's second-generation Calliope 2 silicon and delivers optimized 4G LTE Cat 1 connectivity for IoT, M2M and consumer devices such as wearables and hearables that require voice support and speed higher than LTE-M.

DEKRA Testing and Certification S.A.U. declines any responsibility with respect to the information provided by the client and that may affect the validity of results.

Usage of samples

Samples undergoing test have been selected by: The client.

- Sample S/01 is composed of the following elements:

Control Nº	Description	Model	Serial Nº	Date of reception
75461B/005 *	LTE Cat 1bis module	GC02S1-NA2	C2E230509001024	21-07-2023
75461B/008	Antenna Cable	-	-	21-07-2023
75461B/004 **	LTE Cat 1bis module	GC02S1-NA2	C2E230509001008	21-07-2023

Sample S/01 has undergone the following test(s): The conducted tests indicated in Appendix A.

* : Used in the conducted tests, but the PAPR and Spurious Emissions at Antenna Terminals tests.

** : Used in the PAPR and Spurious Emissions at Antenna Terminals tests.

- Sample S/02 is composed of the following elements:

Control Nº	Description	Model	Serial Nº	Date of reception
75461B/004	LTE Cat 1bis module	GC02S1-NA2	C2E230509001008	21-07-2023
75461B/001	Antenna	OmniLOG 90200	20200100252	21-07-2023
75461B/012	Antenna Cable	-	-	21-07-2023

Sample S/02 has undergone the following test(s): The radiated tests indicated in Appendix A.

Test sample description

Ports.....:	Port name and description	Cable				
		Specified max length [m]	Attached during test	Shielded	Coupled to patient ⁽³⁾	
	USB		<input checked="" type="checkbox"/>	<input type="checkbox"/>	<input type="checkbox"/>	
Supplementary information to the ports.....:	-					
Rated power supply	Voltage and Frequency		Reference poles			
	<input type="checkbox"/>	AC:	<input type="checkbox"/>	<input type="checkbox"/>	<input type="checkbox"/>	<input type="checkbox"/>
	<input checked="" type="checkbox"/>	DC: 3.2 to 5.5 V				
Rated Power..... :	-					
Clock frequencies..... :	-					
Other parameters	-					
Software version..... :	LR9.0.1.1-59215					
Hardware version	Rev1					

Dimensions in cm (W x H x D) ... :	21 x 1.8 x 19.5 mm		
Mounting position	<input checked="" type="checkbox"/>	Table top equipment	
	<input type="checkbox"/>	Wall/Ceiling mounted equipment	
	<input type="checkbox"/>	Floor standing equipment	
	<input type="checkbox"/>	Hand-held equipment	
	<input type="checkbox"/>	Other:	
Modules/parts..... :	Module/parts of test item	Type	Manufacturer
	-	-	-
Accessories (not part of the test item)	Description	Type	Manufacturer
	USB Cables	USB	-
	Antennas	Antenna	-
Documents as provided by the applicant	Description	File name	Issue date
	-	-	-

⁽³⁾ Only for Medical Equipment

Identification of the client

SEQUANS COMMUNICATIONS
 55 Boulevard Charles de Gaulle, 92700, Colombes, France

Testing period and place

Test Location	DEKRA Testing and Certification S.A.U.
Date (start)	2023-08-16
Date (finish)	2023-09-13

Document history

Report number	Date	Description
75461RRF.004	2023-11-08	First release.

Environmental conditions

In the control chamber, the following limits were not exceeded during the test:

Temperature	Min. = 15 °C Max. = 35 °C
Relative humidity	Min. = 20 % Max. = 75 %

In the semi-anechoic chamber, the following limits were not exceeded during the test:

Temperature	Min. = 15 °C Max. = 35 °C
Relative humidity	Min. = 20 % Max. = 75 %

In the chamber for conducted measurements, the following limits were not exceeded during the test:

Temperature	Min. = 15 °C Max. = 35 °C
Relative humidity	Min. = 20 % Max. = 75 %

Remarks and comments

The tests have been performed by the technical personnel: Fernando Chito, Pablo Redondo, Carmen Vázquez, Ireneo Bibang, Antonio Maireles, Rafael Fernández.

Used instrumentation:

Control No.	Equipment	Model	Manufacturer	Next Calibration
6794	Shielded Room	S101	ETS LINDGREN	N/A
8002	TEMPERATURE CHAMBER MK56 BINDER	MK 56	BINDER	2024-04
6157	Signal and Spectrum Analyzer 10 Hz - 40 GHz	FSV40	ROHDE AND SCHWARZ	2023-10
9229	Wideband Radio Communication Tester	CMW500	ROHDE AND SCHWARZ	2024-06
6254	Attenuator 6 dB 2W DC-26.5 GHz	TWSMAG2	TECHNIWAVE	2024-03
2214	Power Divider DC-25 GHz	5333-104	PICOSECOND PULSE LABS	2023-12
7798	EMC/RF MEASUREMENT SOFTWARE	WMS32	ROHDE AND SCHWARZ	N/A
6791	SEMIANECHOIC ABSORBER LINED	FACT 3 200 STP	ETS LINDGREN	N/A
6792	SHIELDED ROOM	S101	ETS LINDGREN	N/A
6143	Biconical/Log Antenna 30 MHz - 6 GHz	3142E	ETS LINDGREN	2023-10
7763	HORN ANTENNA 1-18GHz	BBHA 9120 D	SCHWARZBECK	2026-01
7817	EMI TEST RECEIVER 2Hz-44GHz	ESW44	ROHDE AND SCHWARZ	2023-12
3783	PRE-AMPLIFIER G>30dB 1GHz-18GHz	BLMA 0118-3A	BONN ELEKTRONIK	2023-12
6144	RF Preamplifier 40 dB, 10 MHz - 6 GHz	BLNA 0160-01N	BONN ELEKTRONIK	2024-07
9227	Wideband Radio Communication Tester	CMW500	ROHDE AND SCHWARZ	2024-07
7760	Digital Multimeter	175	FLUKE	2023-11
4848	SOFTWARE FOR EMC/RF TESTING	EMC32	ROHDE AND SCHWARZ	N/A

Testing verdicts

Not applicable:	N/A
Pass:	P
Fail:	F
Not measured:	N/M

Summary

LTE Cat 1bis Band 14.

FCC PART 90 / RSS-140 PARAGRAPH		
Requirement – Test case	Verdict	Remark
FCC 90.542 (a) (7) / RSS-140 Clause 4.3: Transmitter output power: RF output power	P	
FCC 2.1047 / RSS-140 Clause 4.1: Modulation characteristics	P	
FCC 90.213 / RSS-140 Clause 4.2: Frequency stability	P	
FCC 2.1049 / RSS-Gen Clause 6.7: Occupied bandwidth (or 99% emission bandwidth)	P	
FCC 90.691 / RSS-140 Clause 4.4: Spurious emissions at antenna terminals	P	
FCC 90.691 / RSS-140 Clause 4.4: Spurious emissions at antenna terminals (Emission mask requirements for EA-based systems)	P	
FCC 90.691 / RSS-140 Clause 4.4: Radiated emissions	P	
<u>Supplementary information and remarks:</u> None.		

Appendix A: Test results for FCC 90 / RSS-140: LTE Cat 1bis Band 14

INDEX

TEST CONDITIONS	10
RF Output Power	11
Frequency Stability	15
Modulation Characteristics	20
Occupied Bandwidth	22
Spurious emissions at antenna terminals	27
Spurious Emissions at Antenna Terminals at Block Edges	31
Radiated Emissions	40

TEST CONDITIONS

(*): Declared by the Applicant.

POWER SUPPLY (*):

Vnominal: 3.2 Vdc
Vminimum: 3.8 Vdc
Vmaximum: 5.5 Vdc

Type of Power Supply: DC External.

ANTENNA (*):

Bands	Gain (dBi)	Type
LTE Cat 1bis Band 14	+2	External (OmniLOG 90200)
LTE Cat 1bis Band 14	+1.1 dBi	Internal (FR01-S4-210)

Note: Pre-scan determines that external antenna is the worst case in terms of radiated spurious emissions.

TEST FREQUENCIES:

LTE Cat 1bis Band 14. QPSK and 16QAM:

	Channel (Frequency, MHz)	
	BW=5 MHz	BW=10 MHz
Low	23305 (790.5)	N/A
Middle	N/A	23330 (793)
High	23355 (795.5)	N/A

RF Output Power

Limits

1. LTE Cat 1bis Band 14:

* FCC § 90.542 (a) (7):

(a) The following power limits apply to the 763-768 / 793-798 MHz band:

(7) Portable stations (hand-held devices) transmitting in the 763-768 MHz band and the 793-798 MHz band are limited to 3 watts ERP.

* RSS-140 Clause 4.3: The equivalent radiated power (e.r.p.) for control and mobile equipment shall not exceed 30 W. The e.r.p. for portable equipment including handheld devices shall not exceed 3 W.

Fixed and base station equipment shall comply with the e.r.p. limits in SRSP-540.

In addition, the peak to average power ratio (PAPR) of the equipment shall not exceed 13 dB for more than 0.1% of the time, using a signal that corresponds to the highest PAPR during periods of continuous transmission.

Method

The conducted RF output power measurements were made at the RF output terminals of the EUT using the power meter of the Universal Radio Communication tester R&S CMW500, selecting maximum transmission power of the EUT and different modes of modulation.

The maximum equivalent isotropically radiated power (e.i.r.p.) is calculated by adding the declared maximum antenna gain (dBi).

The maximum effective radiated power e.r.p. is calculated from the maximum equivalent isotropically radiated power (e.i.r.p.) by subtracting 2.15 dB:

$$E.R.P. = E.I.R.P. - 2.15 \text{ dB}$$

Test Setup

1. CONDUCTED AVERAGE POWER:



2. PEAK-TO-AVERAGE POWER RATIO (PAPR):

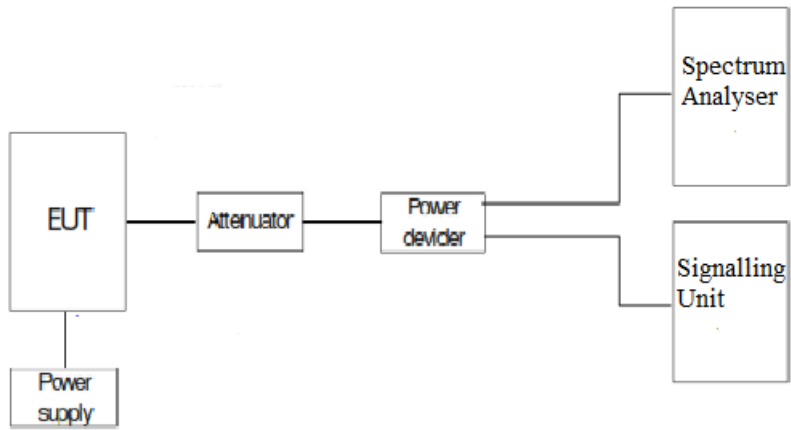

Results

1. CONDUCTED AVERAGE POWER:

Measurements required on one frequency near top channel and one frequency near bottom channel, according to FCC § 15.31 (m).

LTE Cat 1bis Band 14:

Worst-case of RF Power is BW=5 MHz, Low Channel, QPSK, RB Size=1, RB Offset=0.

BANDWIDTH (MHz)	CHANNEL	FREQUENCY (MHz)	MODULATION	RB SIZE	RB OFFSET	AVERAGE POWER (dBm)
	Low 23305	790.5	QPSK	1	0	23.07
				1	12	22.98
				1	24	22.52
				12	0	21.95
				12	6	21.9
				12	11	21.83
				25	0	21.87
			16-QAM	1	0	22.1
				1	12	22.03
				1	24	21.62
				12	0	20.89
				12	6	20.82
				12	11	20.74
				25	0	20.78
	High 23355	795.5	QPSK	1	0	22.66
				1	12	22.55
				1	24	22.56
				12	0	21.45
				12	6	21.33
				12	11	21.41
				25	0	21.34
			16-QAM	1	0	21.61
				1	12	21.5
				1	24	21.53
12				0	20.37	
12				6	20.27	
12				11	20.35	
25				0	20.36	

BW=5 MHz. QPSK:

MAX POWER	QPSK COND. POWER AVG (dBm)	ANTENNA GAIN (dBi)	RAD. POWER AVG EIRP(dBm)	RAD. POWER AVG ERP(dBm)
LOW	23.07	2	25.07	22.92
HIGH	22.66	2	24.66	22.51
MAX:	23.07		25.07	22.92

BW=5 MHz. 16QAM:

MAX POWER	16QAM COND. POWER AVG (dBm)	ANTENNA GAIN (dBi)	RAD. POWER AVG EIRP(dBm)	RAD. POWER AVG ERP(dBm)
LOW	22.1	2	24.1	21.95
HIGH	21.61	2	23.61	21.46
MAX:	22.1		24.1	21.95

2. PEAK-TO-AVERAGE POWER RATIO (PAPR):

LTE Cat 1bis Band 14:

Preliminary measurements determined the worst case of PAPR is BW=5 MHz, High Channel, 16QAM, RB Size=12, RB Offset=0.

Low Channel:

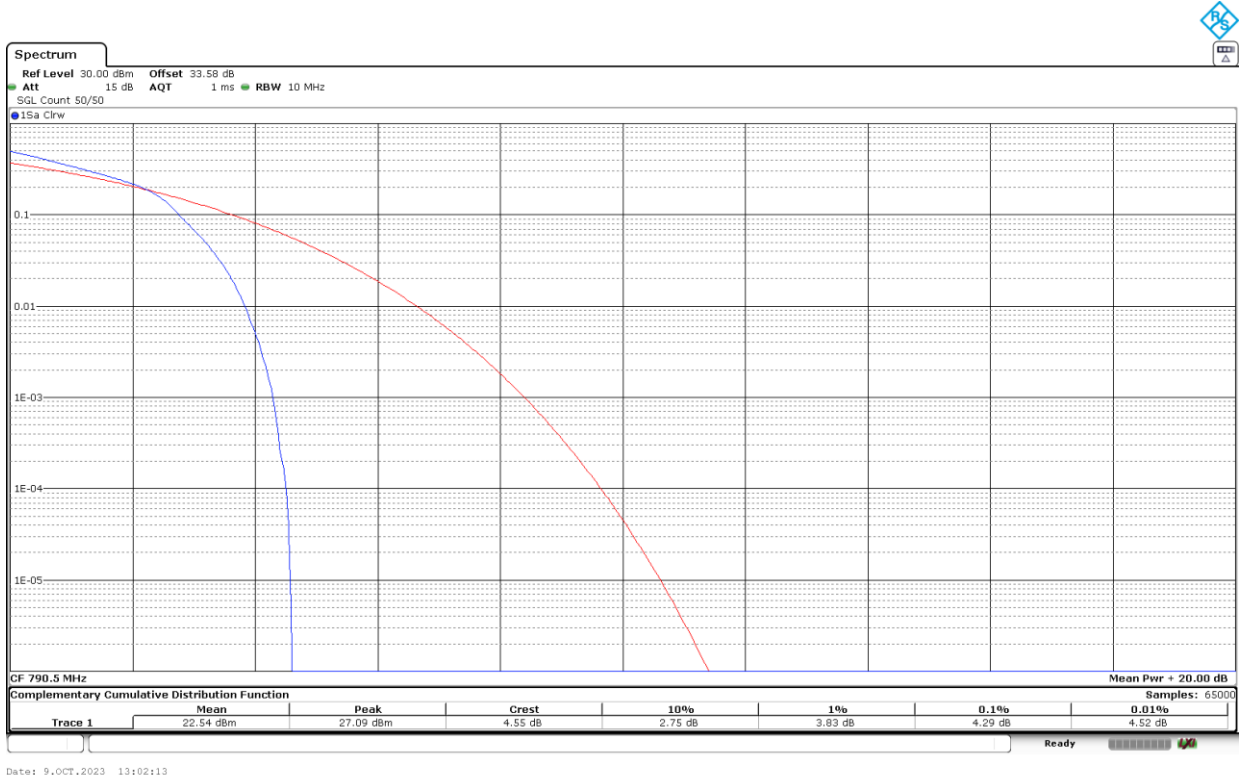

High Channel:

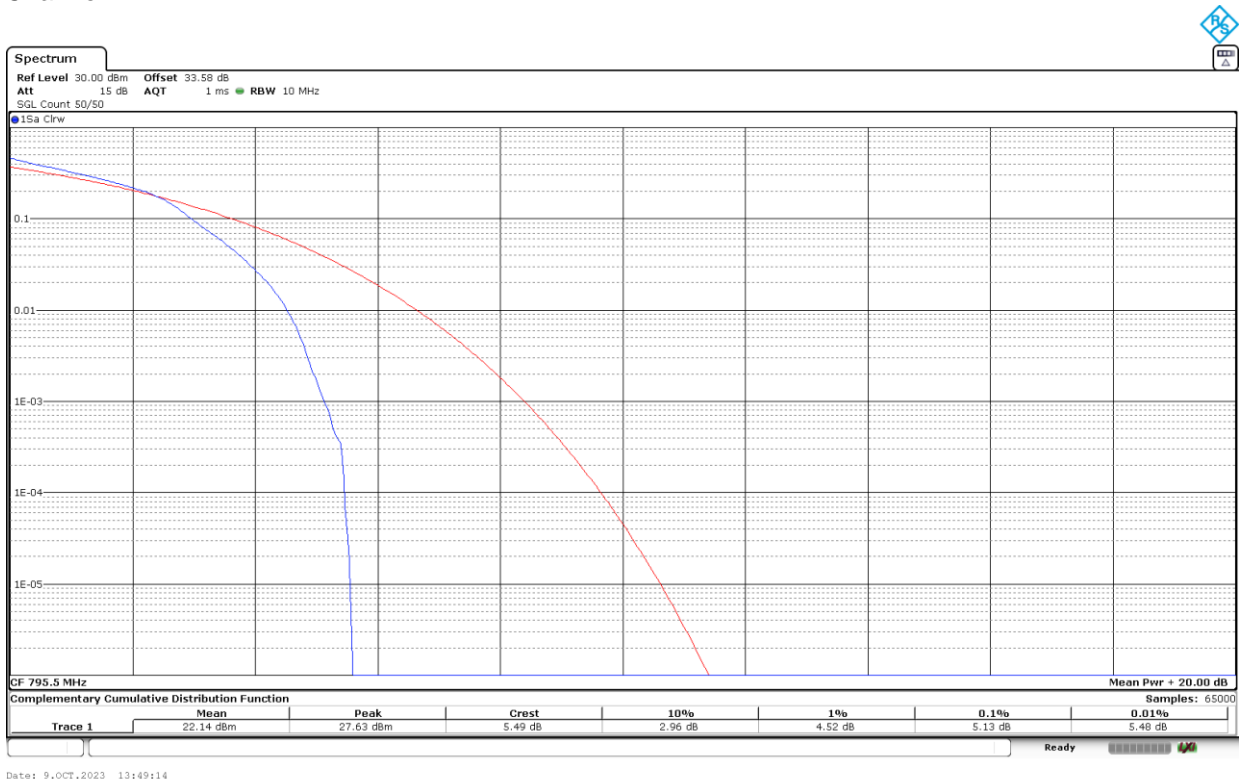

16QAM	Low	High
PAPR (dB)	4.29	5.13

Measurement uncertainty (dB) $<\pm 1.11$

Verdict

Pass

Frequency Stability

Limits

1. LTE Cat 1bis Band 14:

* FCC § 2.1055:

- (a) The frequency stability shall be measured with variation of ambient temperature as follows:
 - (1) From -30° to $+50^{\circ}$ centigrade for all equipment except that specified in paragraphs (a) (2) and (3) of this section.
- (b) Frequency measurements shall be made at the extremes of the specified temperature range and at intervals of not more than 10° centigrade through the range. A period of time sufficient to stabilize all of the components of the oscillator circuit at each temperature level shall be allowed prior to frequency measurement. The short term transient effects on the frequency of the transmitter due to keying (except for broadcast transmitters) and any heating element cycling normally occurring at each ambient temperature level also shall be shown. Only the portion or portions of the transmitter containing the frequency determining and stabilizing circuitry need be subjected to the temperature variation test.
- (c) The frequency stability shall be measured with variation of primary supply voltage as follows:
 - (1) Vary primary supply voltage from 85 to 115 percent of the nominal value for other than hand carried battery equipment.
 - (2) For hand carried, battery powered equipment, reduce primary supply voltage to the battery operating end point which shall be specified by the manufacturer.
 - (3) The supply voltage shall be measured at the input to the cable normally provided with the equipment, or at the power supply terminals if cables are not normally provided. Effects on frequency of transmitter keying (except for broadcast transmitters) and any heating element cycling at the nominal supply voltage and at each extreme also shall be shown.

* RSS-140 Clause 4.2:

The frequency stability shall be sufficient to ensure that the occupied bandwidth stays within the operating frequency block when tested at the temperature and supply voltage variations specified in RSS-Gen.

Method

The frequency tolerance measurements over temperature variations were made over the temperature range of -30°C to $+50^{\circ}\text{C}$. The EUT was placed inside a climatic chamber and the temperature was raised hourly in 10°C steps from -30°C up to $+50^{\circ}\text{C}$.

The supply voltage was varied between 85% and 115% of nominal voltage.

The EUT was set in "Radio Resource Control (RRC) mode" in the middle channel using the Universal Radio Communication tester R&S CMW500 and the maximum frequency error was measured using the built-in calibrated frequency meter.

The worst case LTE mode for conducted power was used for the test.

In order to check that the frequency stability is sufficient such that the fundamental emissions stay within the authorized bands of operation, a reference point is established at the applicable unwanted emissions limit using a RBW equal to the RBW required by the unwanted emissions specification of the applicable regulatory standard. These reference points measured using the Low and High channel of operation are identified as fL

and f_H respectively. The worst-case frequency offset determined in the above methods is added or subtracted from the values of f_L and f_H to check that the resulting frequencies remain within the band.

The reference point measurements were made at the RF output terminals of the EUT using an attenuator, power splitter and spectrum analyser. The EUT was controlled via the Universal Radio Communication tester R&S CMW500 selecting maximum transmission power of the EUT and different modes of modulation.

Test Setup

1. Frequency Tolerance:

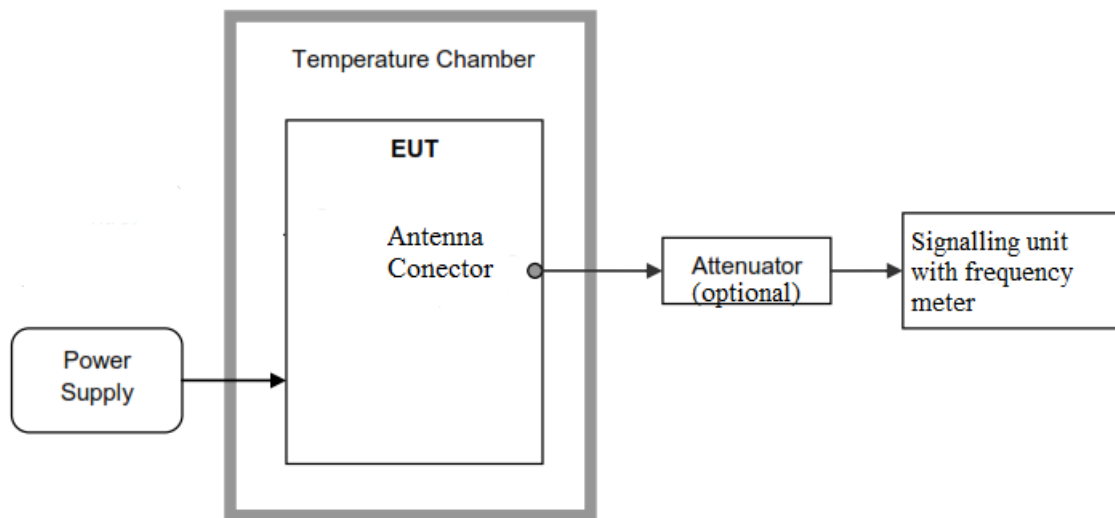

2. Reference Frequency Points f_L and f_H :

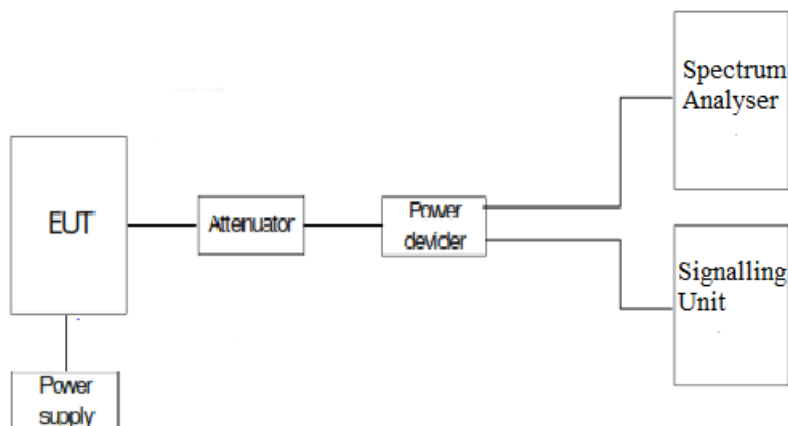

Results

LTE Cat 1bis Band 14:

The worst case modulation in terms of Frequency Stability is BW=10 MHz, QPSK, RB Size=1, RB Offset=0.

1. Frequency Tolerance:

- **Frequency Stability over Temperature Variations:**

Temperature (°C)	Frequency Error (Hz)	Frequency Error (ppm)
+85	1,44	0,001815889
+80	5,49	0,006923077
+70	2,23	0,002812106
+60	2,92	0,003682219
+50	4.62	0.005825977
+40	2.75	0.003467844
+30	2.26	0.002849937
+20	4.09	0.005157629
+10	3.46	0.004363178
0	5.31	0.006696091
-10	3.45	0.004350567
-20	3.36	0.004237074
-30	5.96	0.007515763

- **Frequency Stability over Voltage Variations.**

Battery Supply voltage	Voltage (V)	Frequency Error (Hz)	Frequency Error (ppm)
Vmax	5.5	6.17	0.00778058
Vmin (*)	3.2	5.29	0.00667087

2. Reference Frequency Points fL and fH:

The worst-case frequency offsets added or subtracted per band and bandwidth:

fL (MHz)	788.0114
fH (MHz)	797.9663

The reference frequency points fL and fH stay within the authorized blocks for all the band above.

Measurement uncertainty (Hz) $\leq \pm 249.55$

Results

PASS

Modulation Characteristics

Limits

1. LTE Cat 1bis Band 14:

- * FCC § 2.1047: Measurements required: Modulation characteristics.
- * RSS-140 Clause 4.1: Equipment shall employ digital modulation techniques.

Method

For LTE the EUT operates with QPSK and 16QAM modes in which the information is digitised and coded into a bit stream. The RF transmission is multiplexed using *Orthogonal Frequency Division Multiplexing (OFDM)* using different possible arrangement of subcarriers (Resource Blocks RB).

Test Setup

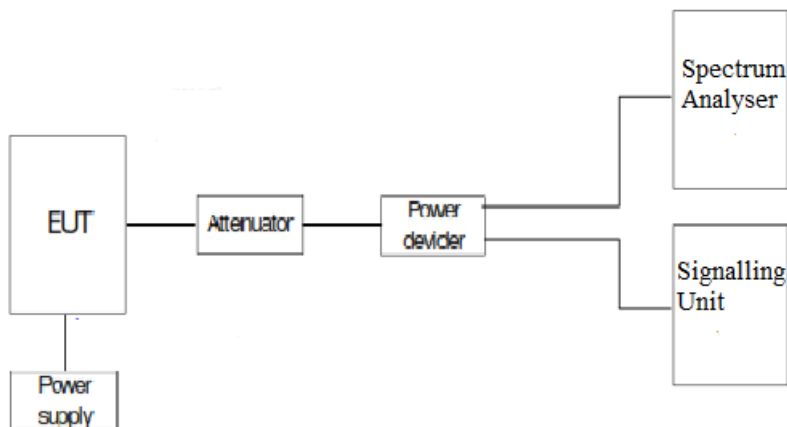

Results

The following plots show the modulation schemes in the EUT.

LTE Cat 1bis Band 14: BW=10 MHz. QPSK.

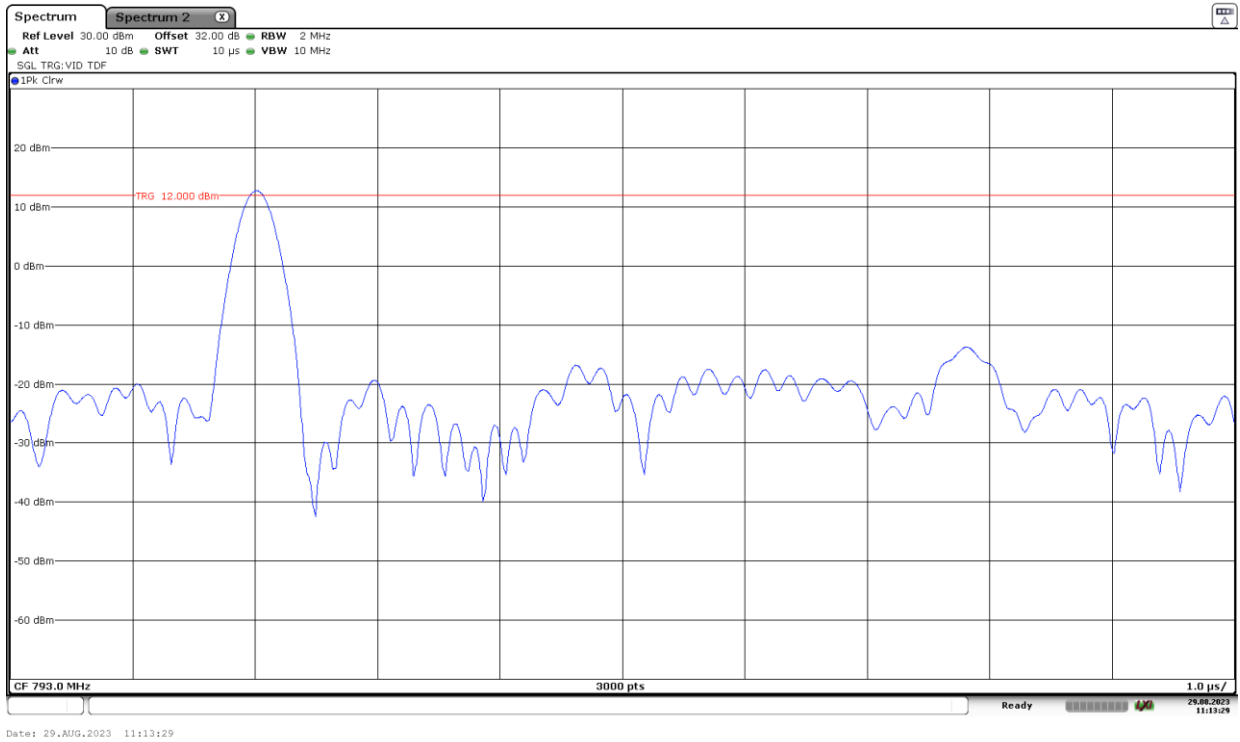

LTE Cat 1bis Band 14: BW=10 MHz. 16QAM.

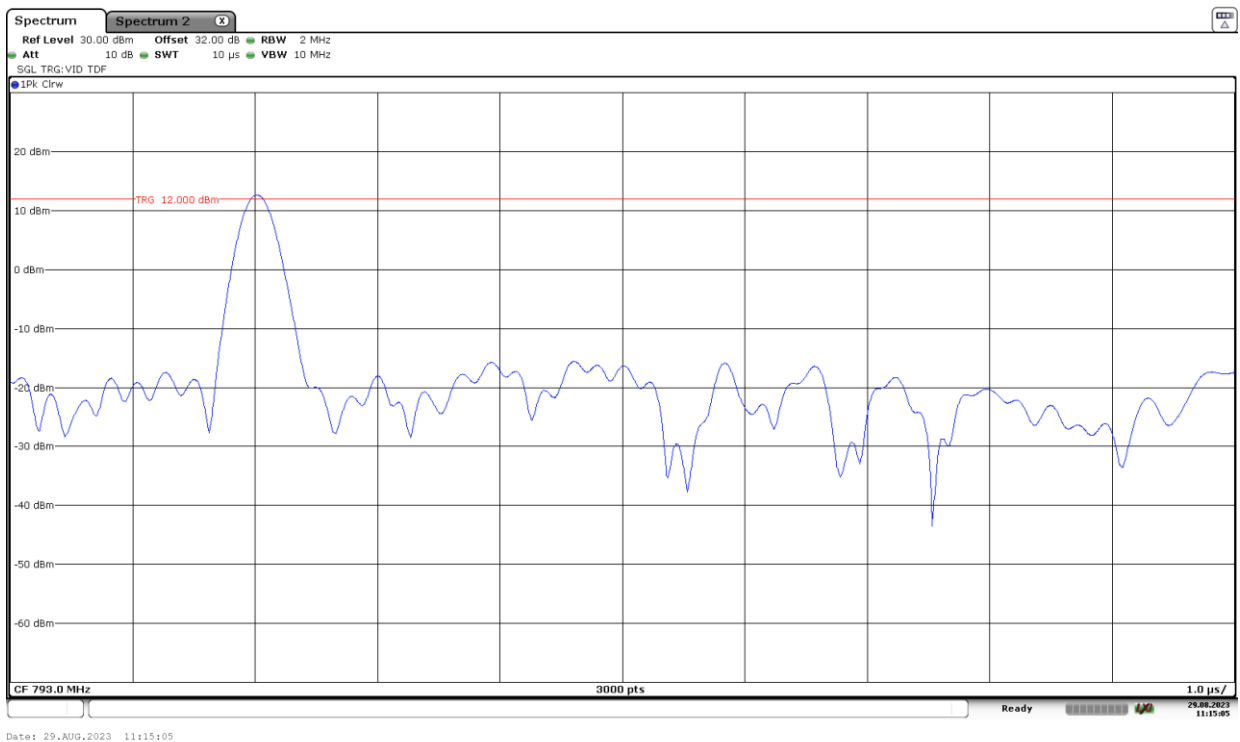

Occupied Bandwidth

Limits

1. LTE Cat 1bis Band 14:

* FCC § 2.1049. Measurements required: Occupied bandwidth.

* RSS-Gen Clause 6.7: The occupied bandwidth or the “99% emission bandwidth” is defined as the frequency range between two points, one above and the other below the carrier frequency, within which 99% of the total transmitted power of the fundamental transmitted emission is contained. The occupied bandwidth shall be reported for all equipment in addition to the specified bandwidth required in the applicable RSSs.

Method

The occupied bandwidth measurement was performed at the output terminals of the EUT using an attenuator, power splitter and spectrum analyser. The EUT was controlled via the Universal Radio Communication tester R&S CMW500 selecting maximum transmission power of the EUT and different modes of modulation. The 99% occupied bandwidth and the -26 dBc bandwidth were measured directly using the built-in bandwidth measuring option of spectrum analyser.

Test Setup

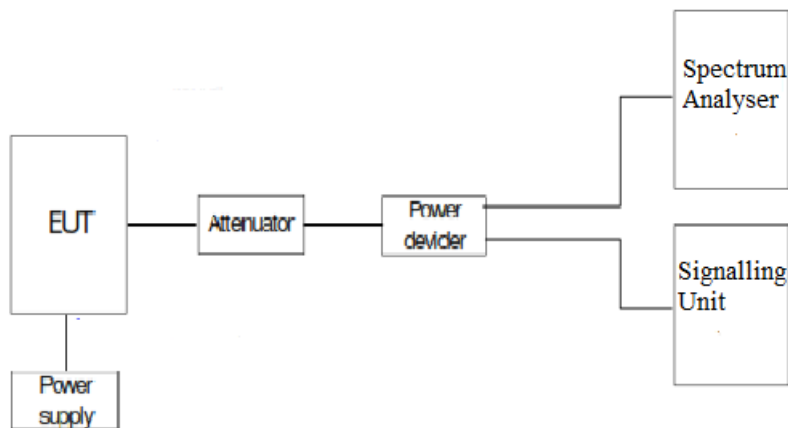

Results

LTE Bands: The worst case of Occupied Bandwidth corresponds to Resource Blocks (RB) Size all, regardless the nominal bandwidth selected.

LTE Cat 1bis Band 14:

LTE Cat 1bis Band 14. BW=5 MHz. QPSK. RB Size=Max.

	Low Channel	High Channel
99% Occupied Bandwidth (MHz)	4.567	4.560
-26 dBc Bandwidth (MHz)	5.616	5.621
Measurement uncertainty (kHz)	<±4.67	

LTE Cat 1bis Band 14. BW=5 MHz. 16QAM. RB Size = Max.

	Low Channel	High Channel
99% Occupied Bandwidth (MHz)	4.547	4.733
-26 dBc Bandwidth (MHz)	5.625	5.710
Measurement uncertainty (kHz)	<±4.67	

LTE Cat 1bis Band 14. BW = 5 MHz. QPSK.

Low Channel:

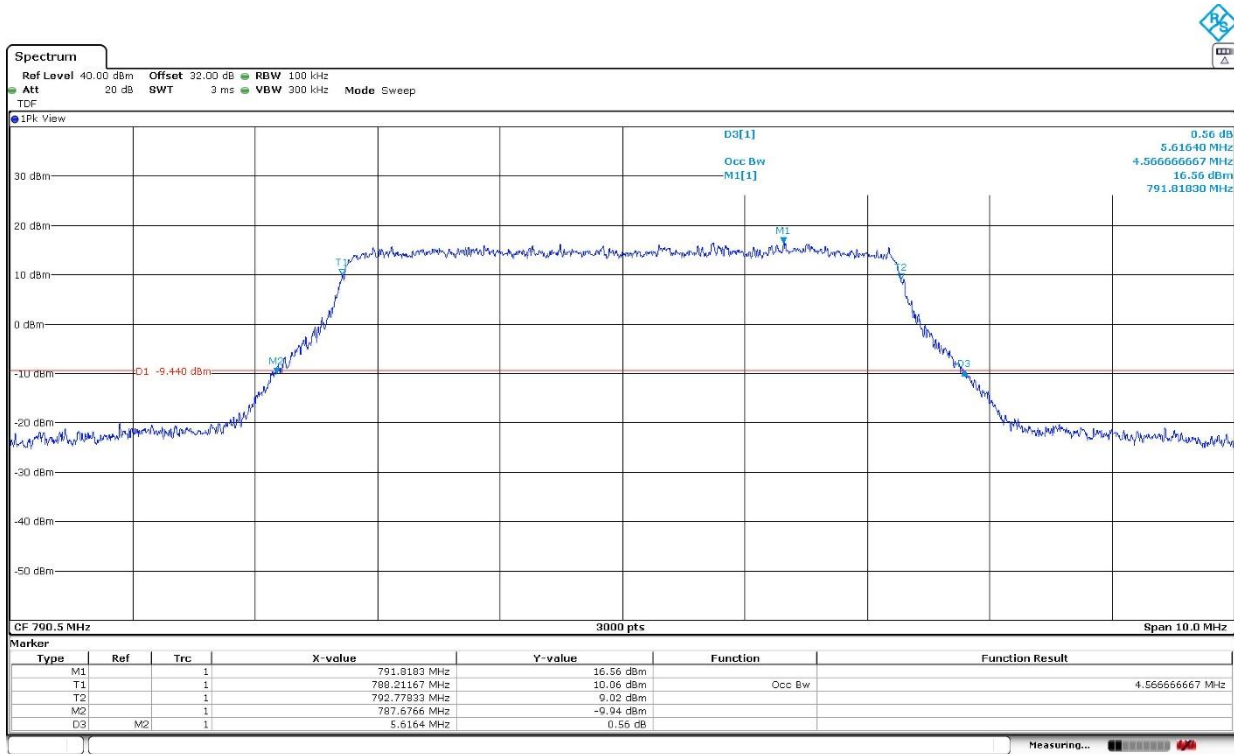

High Channel:

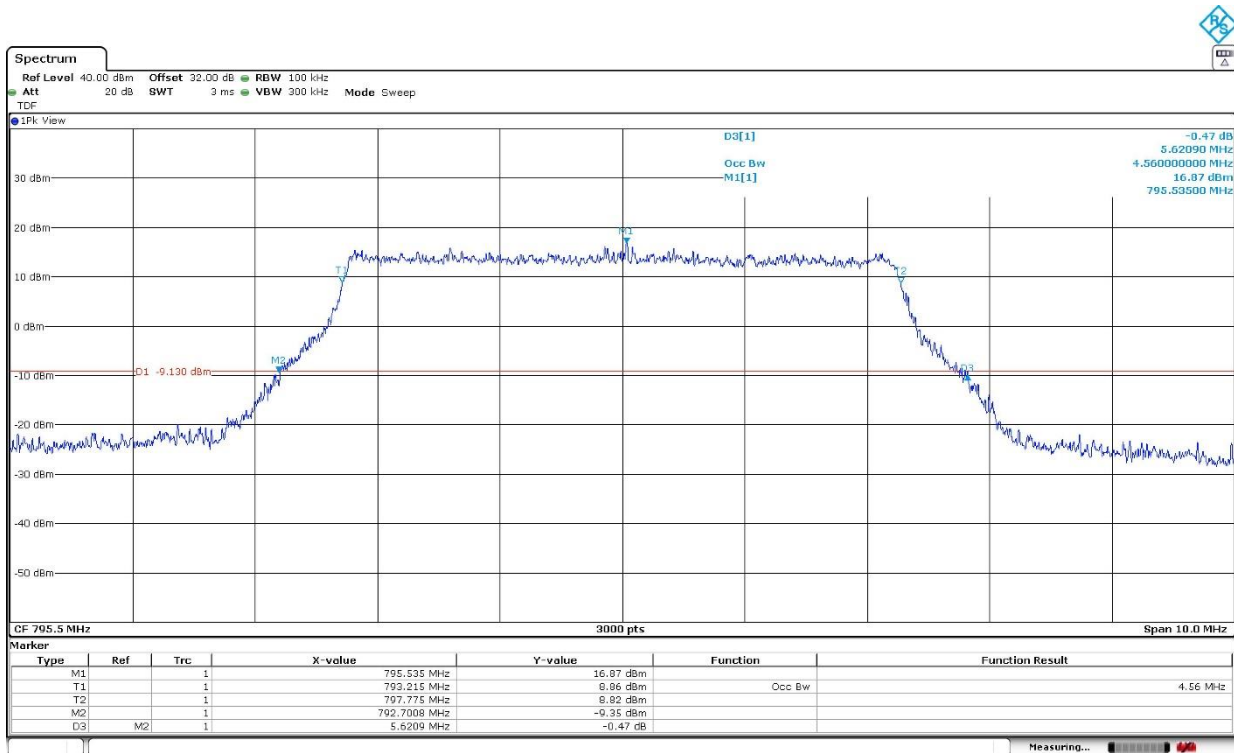

LTE Cat 1bis Band 14. BW = 5 MHz. 16QAM.

Low Channel:

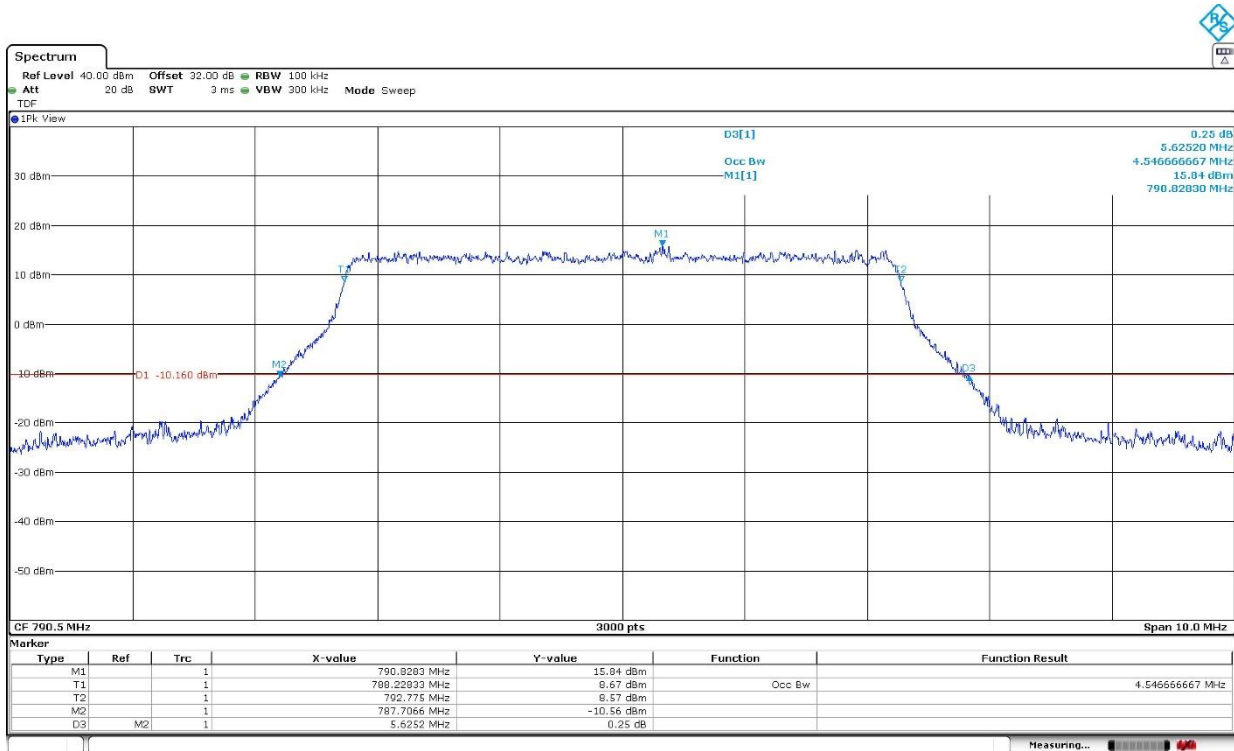

High Channel:

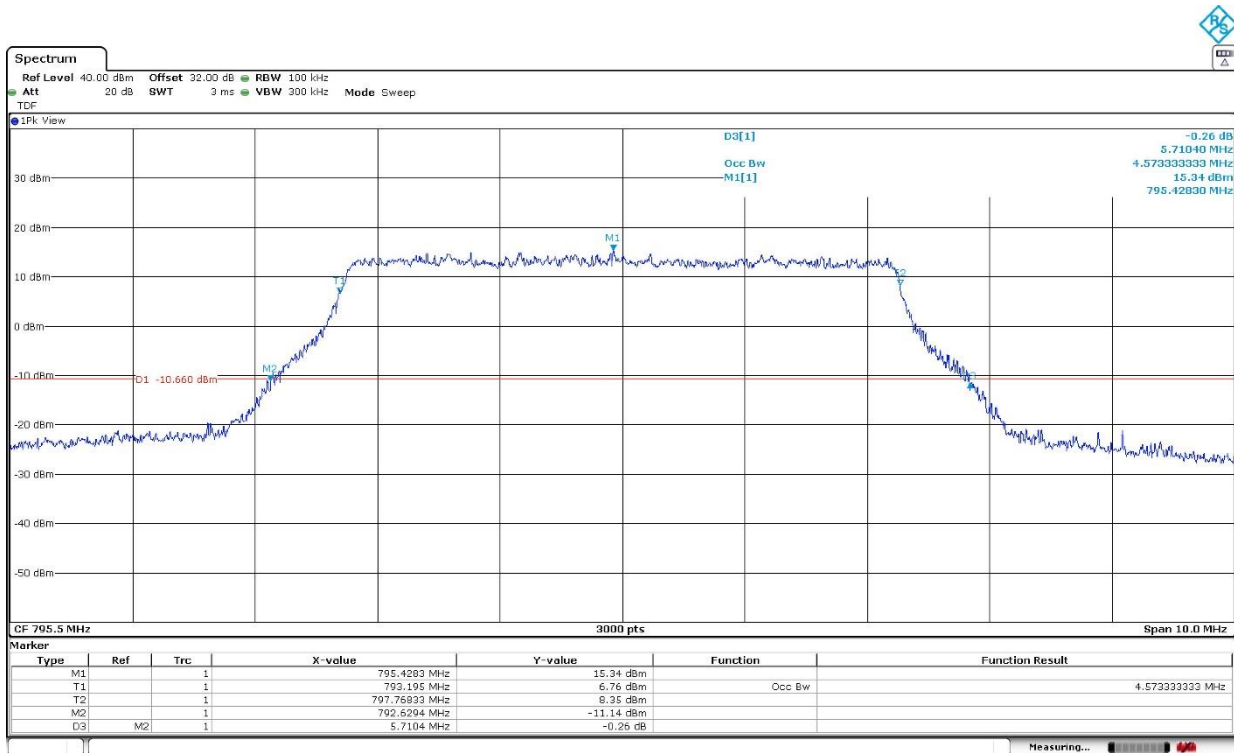

LTE Cat 1bis Band 14. BW=10 MHz. QPSK. RB Size=Max.

	Low Channel
99% Occupied Bandwidth (MHz)	9.300
-26 dBc Bandwidth (MHz)	11.926
Measurement uncertainty (kHz)	<±4.67

LTE Cat 1bis Band 14. BW=10 MHz. 16QAM. RB Size = Max.

	Low Channel
99% Occupied Bandwidth (MHz)	4.620
-26 dBc Bandwidth (MHz)	6.612
Measurement uncertainty (kHz)	<±4.67

LTE Cat 1bis Band 14. BW = 10 MHz. QPSK.

Middle Channel:

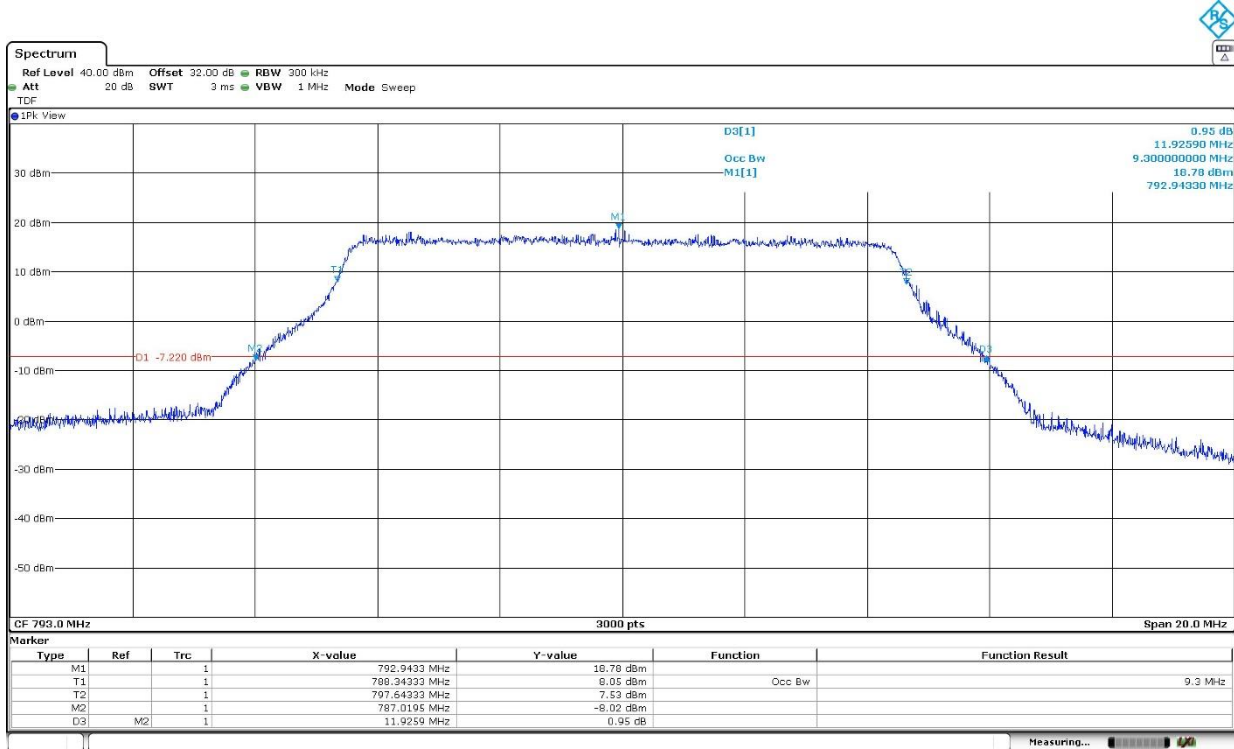

LTE Cat 1bis Band 14. BW = 10 MHz. 16QAM.

Middle Channel:

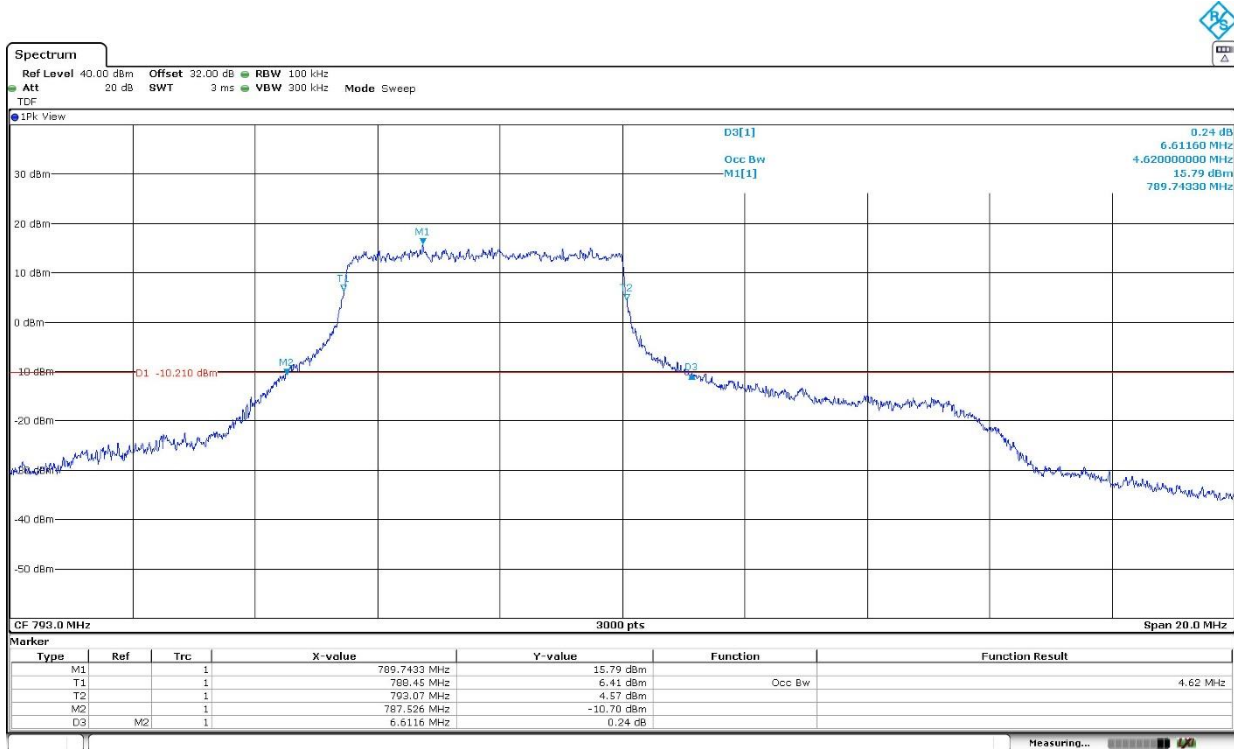

Spurious emissions at antenna terminals

Limits

1. LTE Cat 1bis Band 14:

* FCC § 90.543 (e) (2) (3) & (5):

Transmitters operating in 758-768 MHz and 788-798 MHz bands must meet the emission limitations in (e) of this section.

(e) For operations in the 758-768 MHz and the 788-798 MHz bands, the power of any emission outside the licensee's frequency band(s) of operation shall be attenuated below the transmitter power (P) within the licensed band(s) of operation, measured in watts, in accordance with the following:

(1) On all frequencies between 769-775 MHz and 799-805 MHz, by a factor not less than $76 + 10 \log (P)$ dB in a 6.25 kHz band segment, for base and fixed stations.

(2) On all frequencies between 769-775 MHz and 799-805 MHz, by a factor not less than $65 + 10 \log (P)$ dB in a 6.25 kHz band segment, for mobile and portable stations.

(3) On any frequency between 775-788 MHz, above 805 MHz, and below 758 MHz, by at least $43 + 10 \log (P)$ dB.

(4) Compliance with the provisions of paragraphs (e)(1) and (2) of this section is based on the use of measurement instrumentation such that the reading taken with any resolution bandwidth setting should be adjusted to indicate spectral energy in a 6.25 kHz segment.

(5) Compliance with the provisions of paragraph (e)(3) of this section is based on the use of measurement instrumentation employing a resolution bandwidth of 100 kHz or greater. However, in the 100 kHz bands immediately outside and adjacent to the frequency block, a resolution bandwidth of 30 kHz may be employed.

* RSS-140 Clause 4.4:

The power of any unwanted emission outside the band 788-798 MHz shall be attenuated below the Transmitter output power P in dBW as follows, where p is the transmitter output power in watts:

- a. For any frequency between 769-775 MHz and 799-806 MHz:
 - i. $76 + 10 \log (p)$, dB in a 6.25 kHz band for fixed and base station equipment
 - ii. $65 + 10 \log (p)$, dB in a 6.25 kHz band for mobile and portable/hand-held equipment
- b. For any frequency between 775-788 MHz, above 806 MHz, and below 758 MHz: $43 + 10 \log (p)$, dB in a bandwidth of 100 kHz or greater. However, in the 100 kHz bands immediately outside and adjacent to the frequency bands 758-768 MHz and 788-798 MHz, a resolution bandwidth of 30 kHz may be employed.

Method

The EUT RF output connector was connected to a spectrum analyser and to the Universal Radio Communication tester R&S CMW500 (selecting maximum transmission power of the EUT and different modes of modulation) using a 50 Ohm attenuator and a power divider.

The reading of the spectrum analyser is corrected with the attenuation loss of connection between output terminal of EUT and input of the spectrum analyser.

The configuration of Resource Blocks and modulation which is the worst case for conducted power was used.

Measurement Limit:

According to specification, the power of emissions shall be attenuated below the transmitter power (P) by a factor not less $65 + 10 \log (P)$ dB in a 6.25 kHz band segment. P in watts.

At P_o transmitting power, the specified minimum attenuation becomes $65 + 10 \log (P_o)$, and the level in dBm relative P_o becomes:

$$P_o \text{ (dBm)} - [65 + 10 \log (P_o \text{ in mwatts}) - 30] = - 35 \text{ dBm}$$

According to specification, the power of emissions shall be attenuated below the transmitter power (P) by a factor of at least $43 + 10 \log (P)$ dB. P in watts.

At P_o transmitting power, the specified minimum attenuation becomes $43 + 10 \log (P_o)$, and the level in dBm relative P_o becomes:

$$P_o \text{ (dBm)} - [43 + 10 \log (P_o \text{ in mwatts}) - 30] = - 13 \text{ dBm}$$

Test Setup

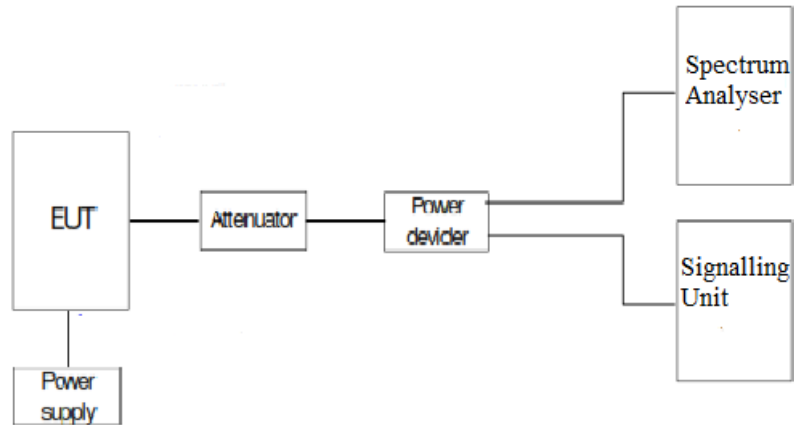

Results

Test performed on the worst-case modulation, RB Size and RB Offset for each LTE band.

LTE Cat 1bis Band 14: BW=5 MHz. QPSK. RB Size=1. RB Offset=0.

Frequency range 9 KHz - 8 GHz:

- Low Channel: No spurious frequencies detected at less than 20 dB below the limit.
(Peak detector).
- High Channel: Spurious frequencies detected at less than 20 dB below the limit:
(Peak detector, but the range 799-806 MHz measured with Average detector).

Frequency (MHz)	Emission limitations conducted (dBm)
799.83895	-46
801.09888	-53.4
802.03205	-39.97

Verdict

PASS

Subrange	Step Size	Detectors	Bandwidth	Sweep Time	Preamp
Receiver: [FSV 40]					
9 kHz - 150 kHz	14.1 Hz	PK+	300 Hz	Coupled	0 dB
150 kHz - 30 MHz	932.812 Hz	PK+	10 kHz	Coupled	0 dB
30 MHz - 1 GHz	30.312 kHz	PK+	100 kHz	Coupled	0 dB
1 GHz - 10 GHz	281.25 kHz	PK+	1 MHz	Coupled	0 dB

LTE Cat 1bis Band 14: BW=5 MHz. QPSK. RB Size=1. RB Offset=0.

Low Channel:

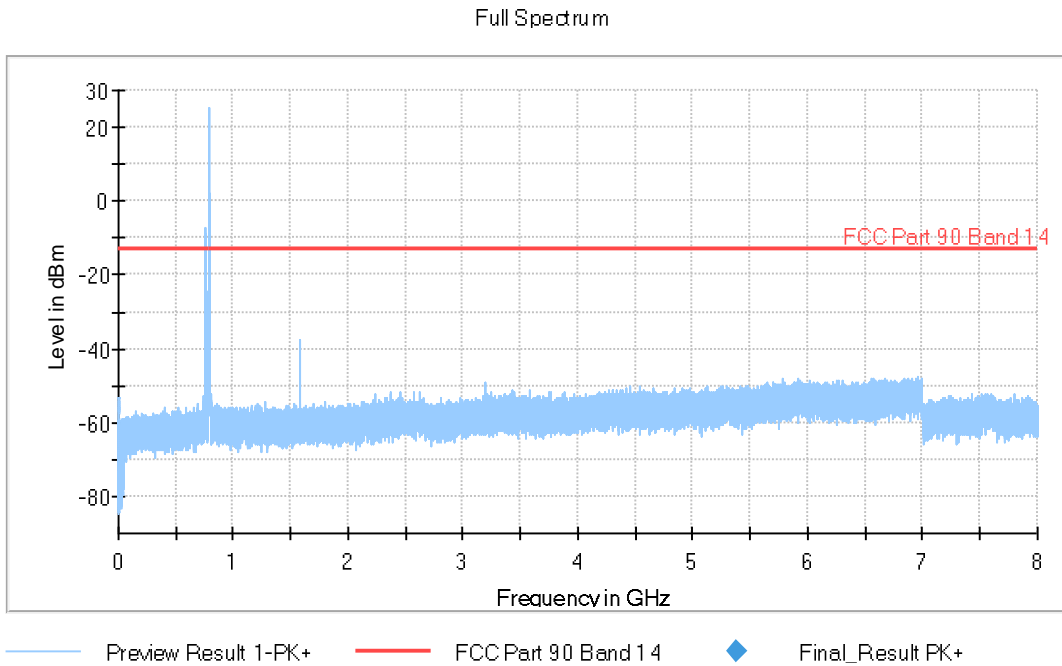

The peak above the limit is the carrier frequency.

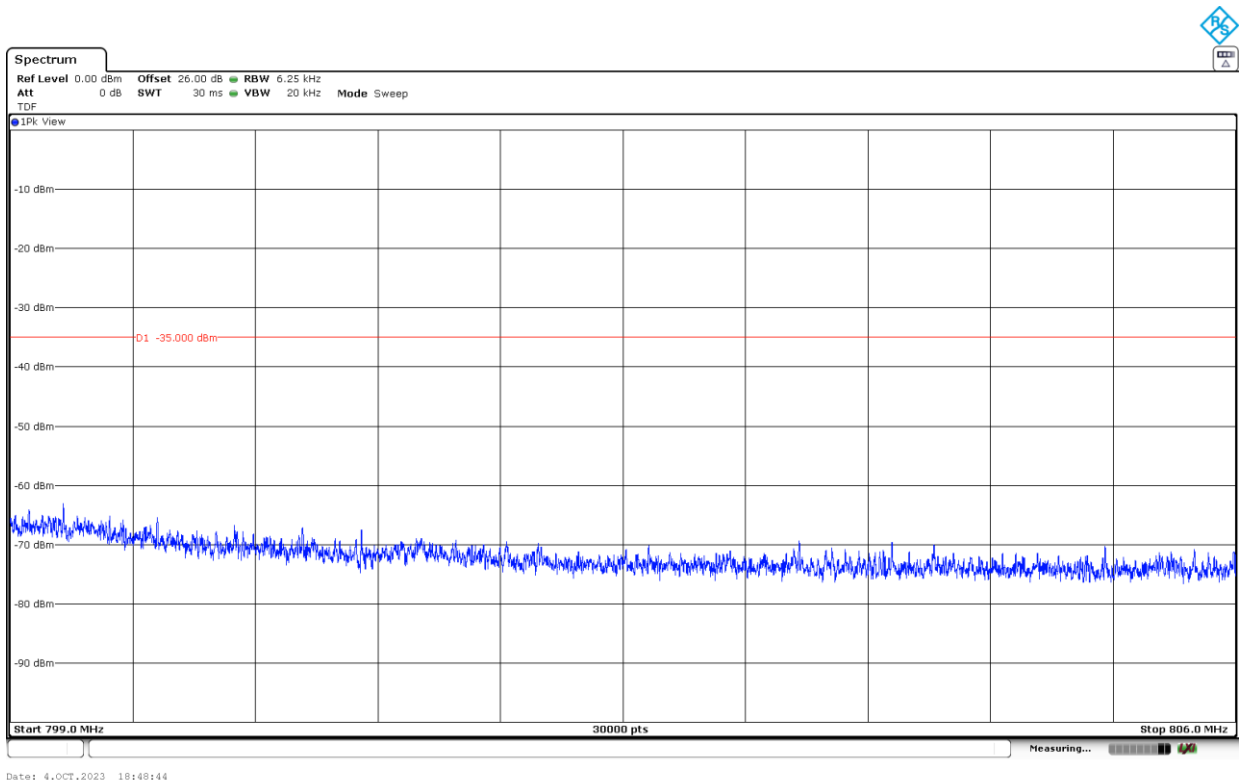
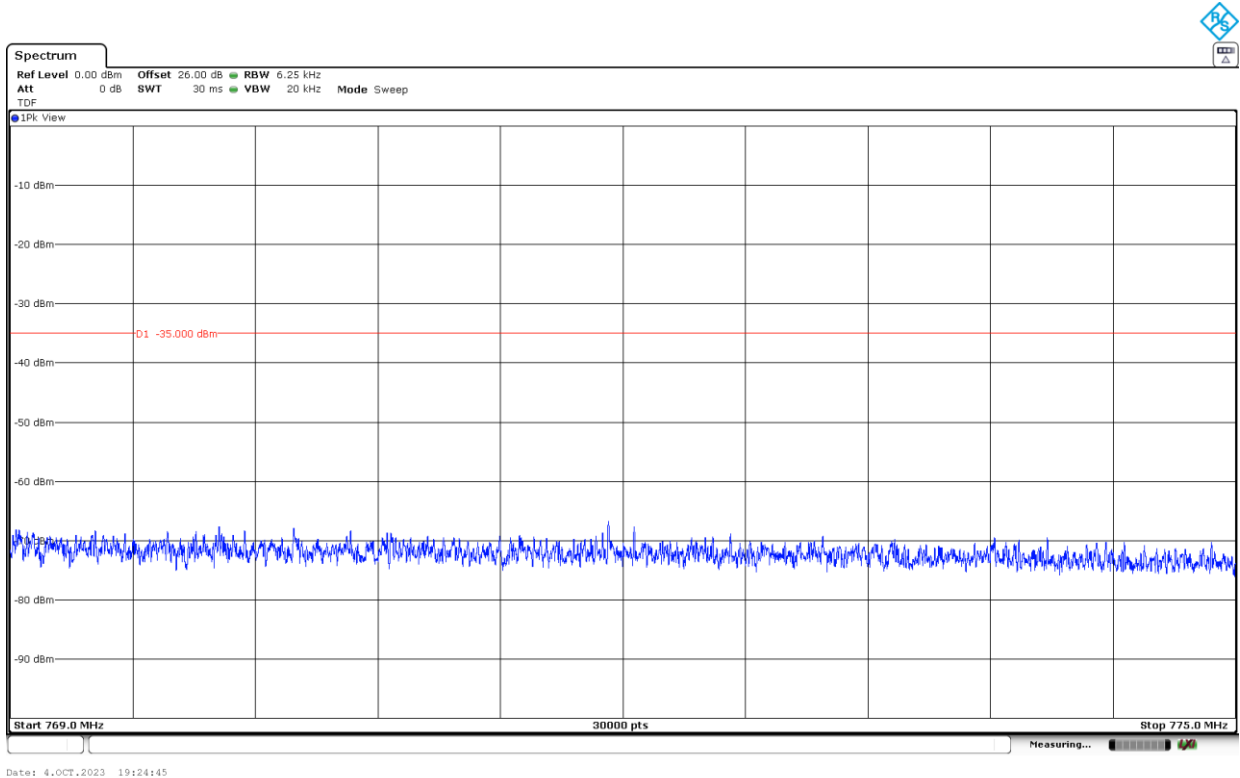

High Channel:

Full Spectrum

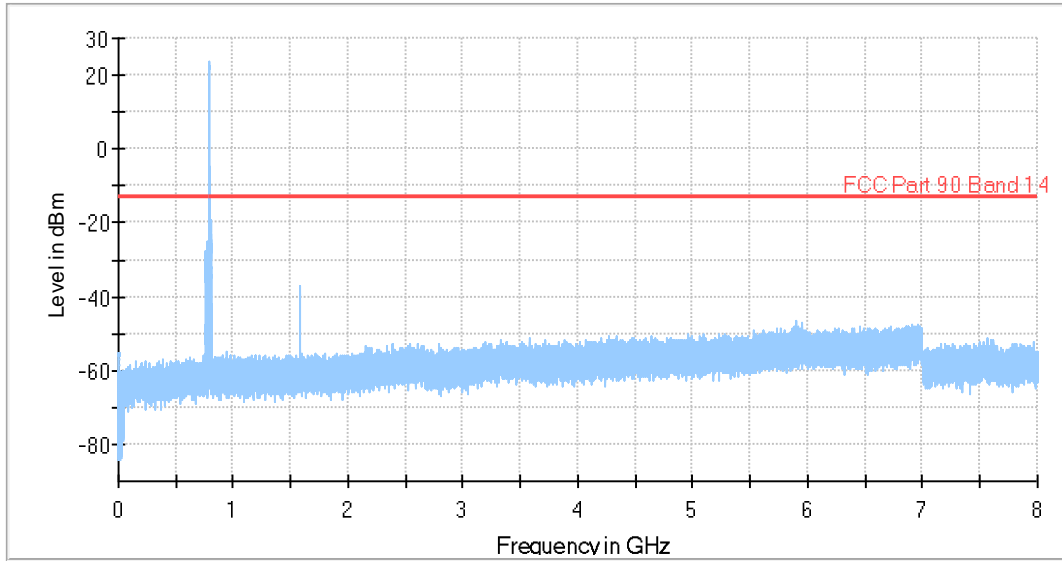

— Preview Result 1-PK+ — FCC Part 90 Band 14 ◆ Final_Result PK+

The peak above the limit is the carrier frequency.

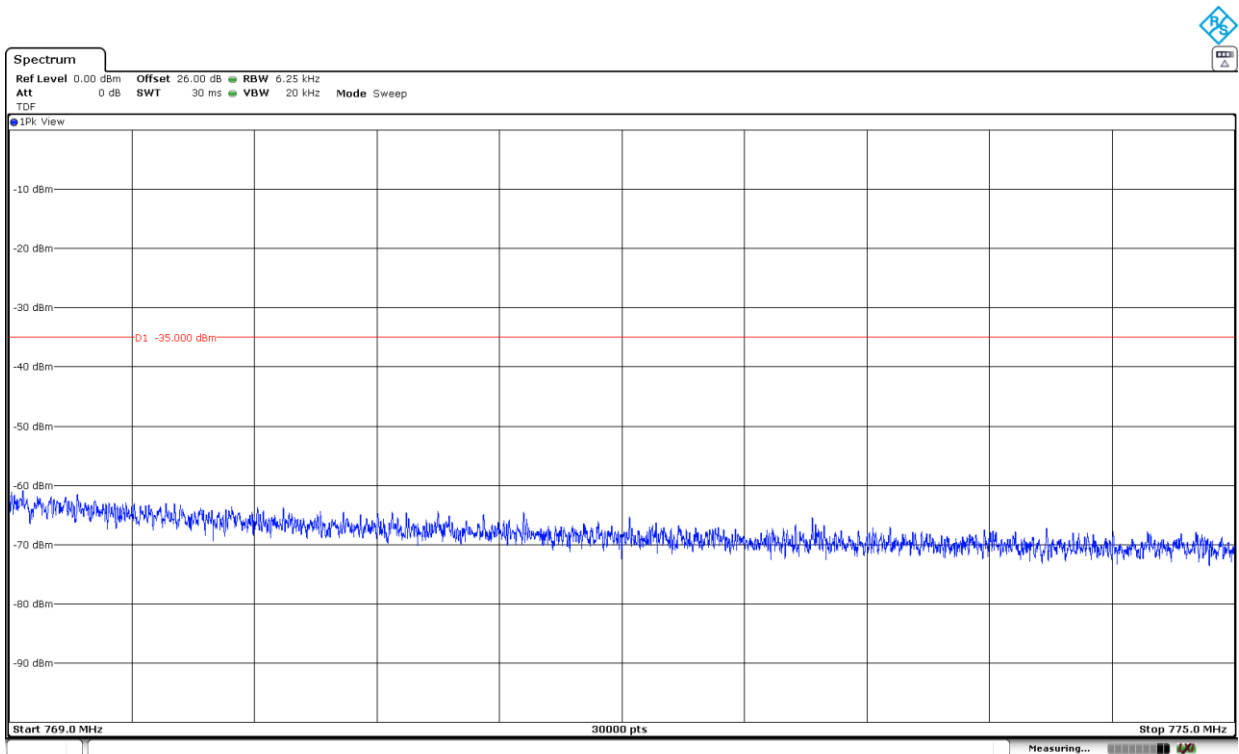

Date: 4.OCT.2023 19:17:06

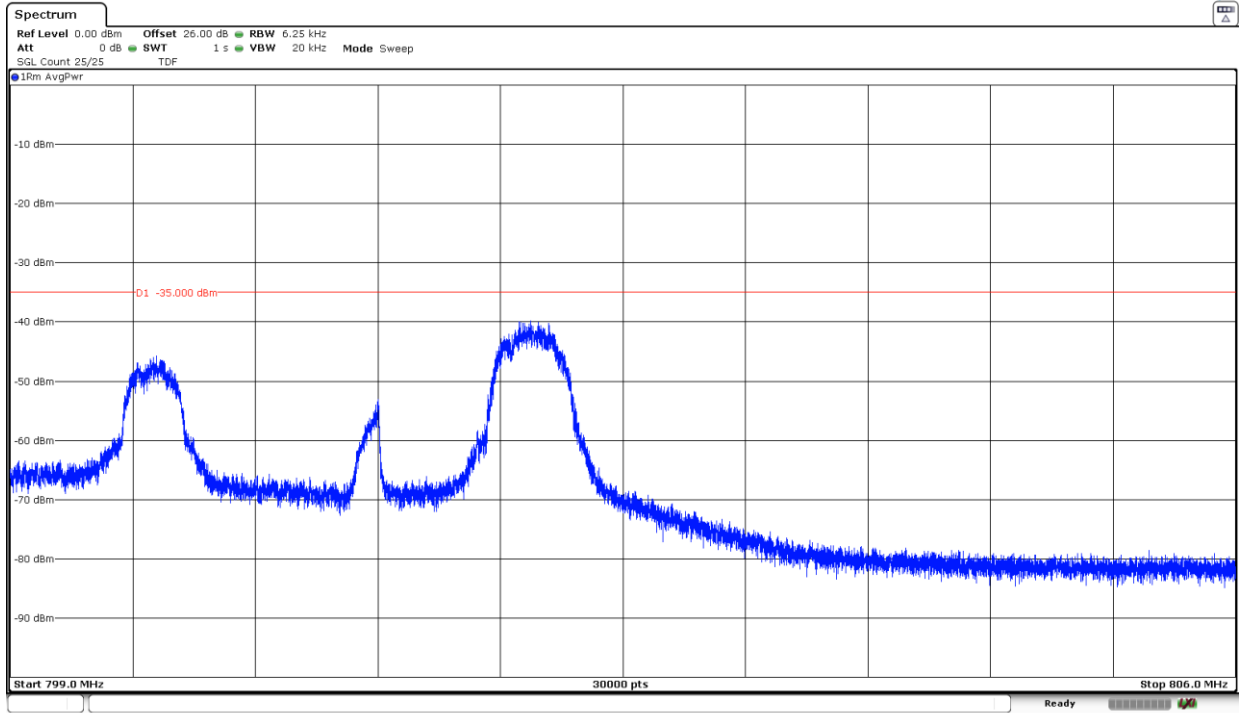

Date: 4.OCT.2023 19:01:34

Spurious Emissions at Antenna Terminals at Block Edges

Limits

1. LTE Cat 1bis Band 14:

* FCC § 90.543 (e) (2) (3) & (5):

Transmitters operating in 758-768 MHz and 788-798 MHz bands must meet the emission limitations in (e) of this section.

(e) For operations in the 758-768 MHz and the 788-798 MHz bands, the power of any emission outside the licensee's frequency band(s) of operation shall be attenuated below the transmitter power (P) within the licensed band(s) of operation, measured in watts, in accordance with the following:

(1) On all frequencies between 769-775 MHz and 799-805 MHz, by a factor not less than $76 + 10 \log (P)$ dB in a 6.25 kHz band segment, for base and fixed stations.

(2) On all frequencies between 769-775 MHz and 799-805 MHz, by a factor not less than $65 + 10 \log (P)$ dB in a 6.25 kHz band segment, for mobile and portable stations.

(3) On any frequency between 775-788 MHz, above 805 MHz, and below 758 MHz, by at least $43 + 10 \log (P)$ dB.

(4) Compliance with the provisions of paragraphs (e)(1) and (2) of this section is based on the use of measurement instrumentation such that the reading taken with any resolution bandwidth setting should be adjusted to indicate spectral energy in a 6.25 kHz segment.

(5) Compliance with the provisions of paragraph (e)(3) of this section is based on the use of measurement instrumentation employing a resolution bandwidth of 100 kHz or greater. However, in the 100 kHz bands immediately outside and adjacent to the frequency block, a resolution bandwidth of 30 kHz may be employed.

* RSS-140 Clause 4.4:

The power of any unwanted emission outside the band 788-798 MHz shall be attenuated below the Transmitter output power P in dBW as follows, where p is the transmitter output power in watts:

- a. For any frequency between 769-775 MHz and 799-806 MHz:
 - i. $76 + 10 \log (p)$, dB in a 6.25 kHz band for fixed and base station equipment
 - ii. $65 + 10 \log (p)$, dB in a 6.25 kHz band for mobile and portable/hand-held equipment
- b. For any frequency between 775-788 MHz, above 806 MHz, and below 758 MHz: $43 + 10 \log (p)$, dB in a bandwidth of 100 kHz or greater. However, in the 100 kHz bands immediately outside and adjacent to the frequency bands 758-768 MHz and 788-798 MHz, a resolution bandwidth of 30 kHz may be employed.

Method

The EUT RF output connector was connected to a spectrum analyzer and to the Universal Radio Communication tester R&S CMW500 (selecting maximum transmission power of the EUT and different modes of modulation) using a 50-Ohm attenuator and a power splitter.

The reading of the spectrum analyser is corrected with the path loss of the connection between the output terminal of the EUT and the input of the spectrum analyzer.

The configuration of modulation which is the worst case for conducted power was used.

As stated in FCC § 90.543, in the 100 kHz bands immediately outside and adjacent to the frequency block, a resolution bandwidth of 30 kHz may be employed.

As stated in RSS-140, in the 100 kHz bands immediately outside and adjacent to the frequency bands 758-768 MHz and 788-798 MHz, a resolution bandwidth of 30 kHz may be employed.

Measurement Limit:

At P_o transmitting power, the specified minimum attenuation $43 + 10 \log_{10} p$ (watts) becomes:

$$P_o \text{ (dBm)} - [43 + 10 \log (P_o \text{ in mwatts}) - 30] = -13 \text{ dBm}$$

Test Setup

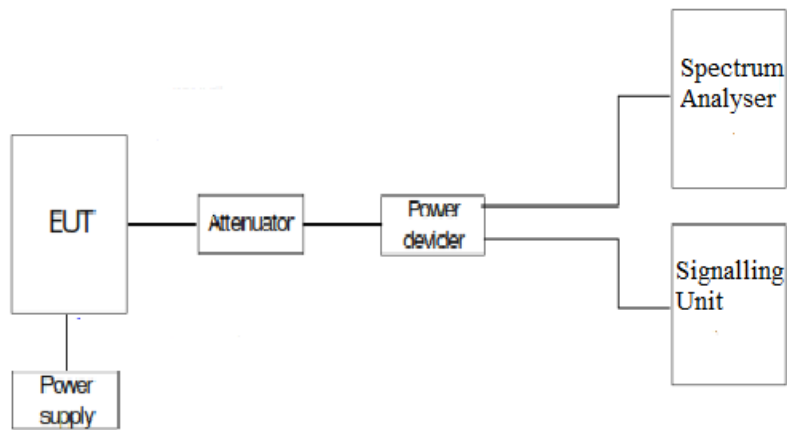

Results

LTE Cat 1bis Band 14:

Preliminary measurements determined the BW=5 MHz, QPSK as the worst case.

LTE Cat 1bis Band 14. QPSK.	RB=1. Offset=0. BW=5 MHz	RB=1. Offset=0. BW=10 MHz
Maximum measured level at <u>Low Block Edge</u> at antenna port (dBm)	-13.14	-14.67

LTE Cat 1bis Band 14. QPSK.	RB=All. Offset=0. BW=5 MHz	RB=All. Offset=0. BW=10 MHz
Maximum measured level at <u>Low Block Edge</u> at antenna port (dBm)	-19.92	-24.13

LTE Cat 1bis Band 14. QPSK.	RB=1. Offset=Max. BW=5 MHz	RB=1. Offset=Max. BW=10 MHz
Maximum measured level at <u>High Block Edge</u> at antenna port (dBm)	-13.37	-14.78

LTE Cat 1bis Band 14. QPSK.	RB=All. Offset=0. BW=5 MHz	RB=All. Offset=0. BW=10 MHz
Maximum measured level at <u>High Block Edge</u> at antenna port (dBm)	-20.62	-24.69

Measurement uncertainty (dB): ± 2.76

Verdict

Pass

The plots below are for the worst case configuration specified before.

LTE Cat 1bis Band 14: BW=5 MHz. QPSK. RB Size=1. RB Offset=0. Low Block Edge:

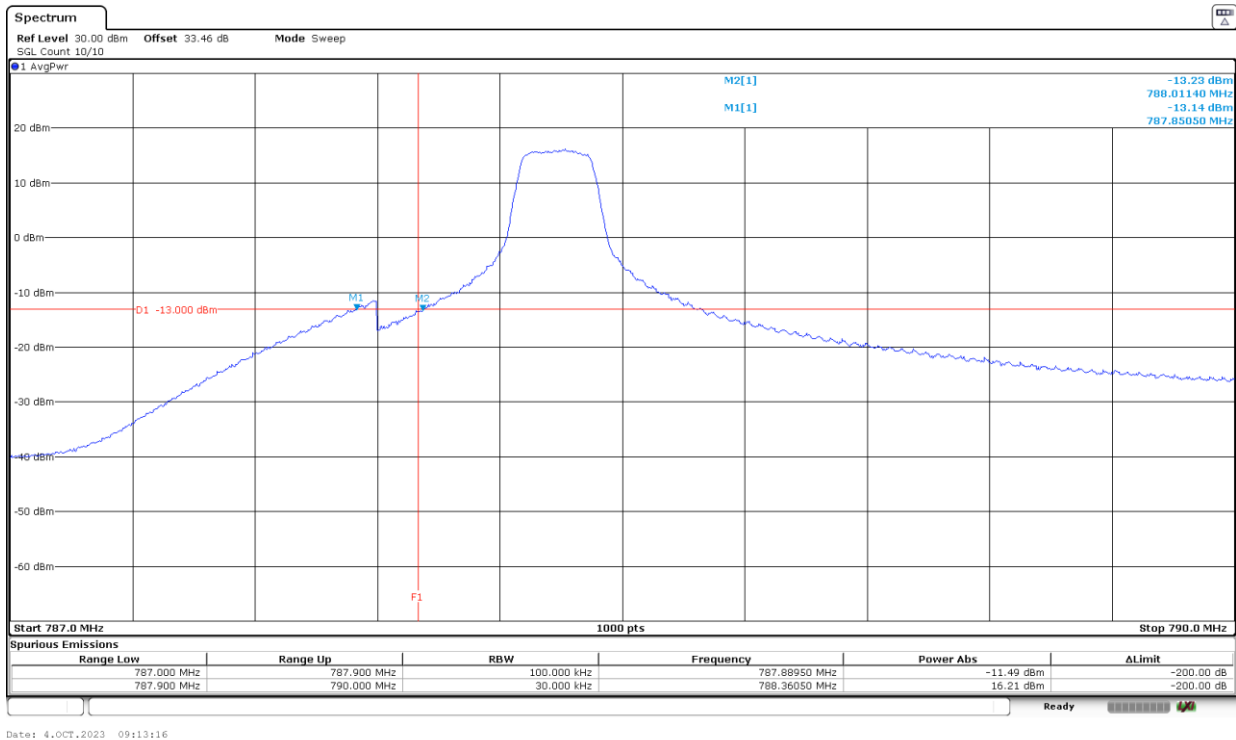

Date: 4.OCT.2023 09:13:16

LTE Cat 1bis Band 14: BW=5 MHz. QPSK. RB Size=All. RB Offset=0. Low Block Edge:

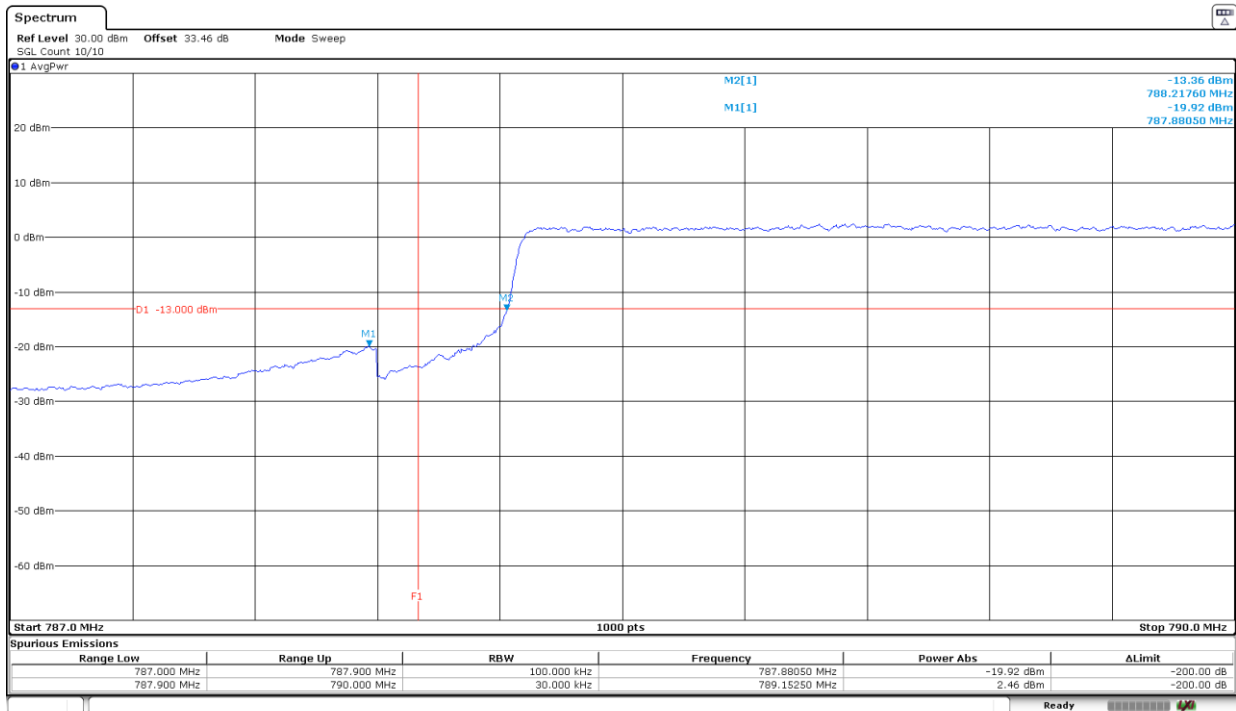

Date: 4.OCT.2023 09:11:05

LTE Cat 1bis Band 14: BW=5 MHz. QPSK. RB Size=1. RB Offset=Max. High Block Edge:

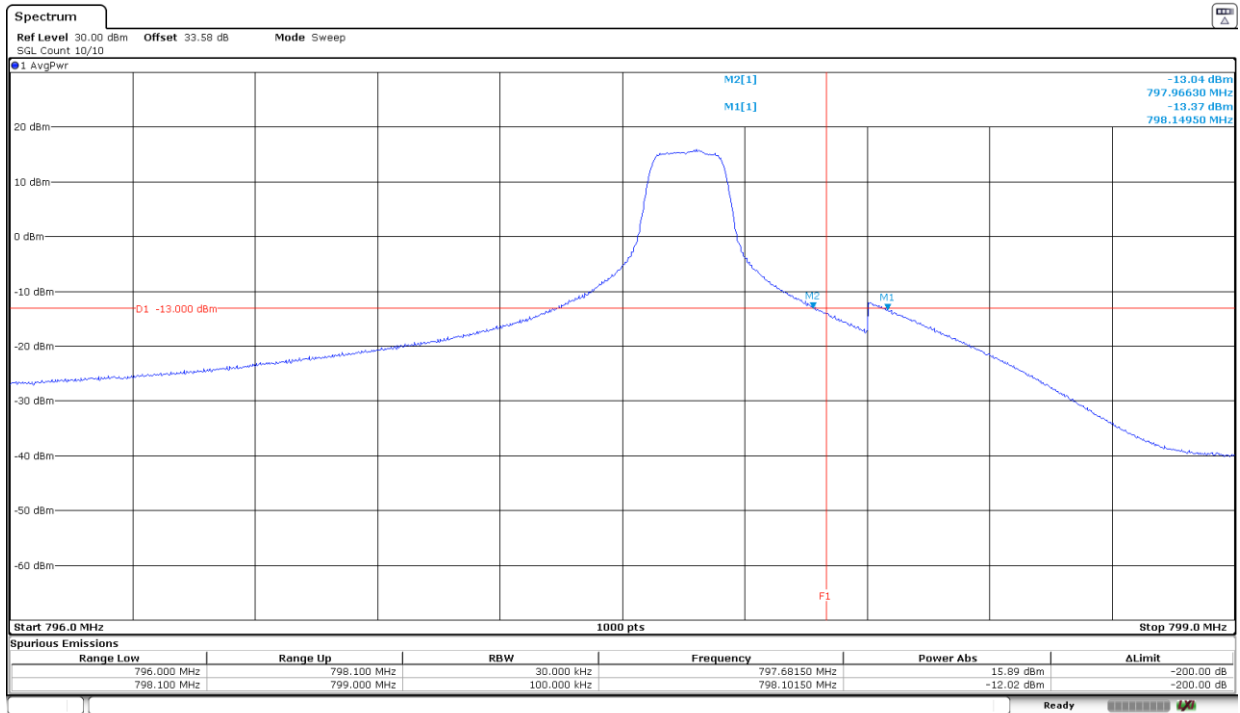

Date: 4.OCT.2023 08:56:24

LTE Cat 1bis Band 14: BW=5 MHz. QPSK. RB Size=All. RB Offset=0. High Block Edge:

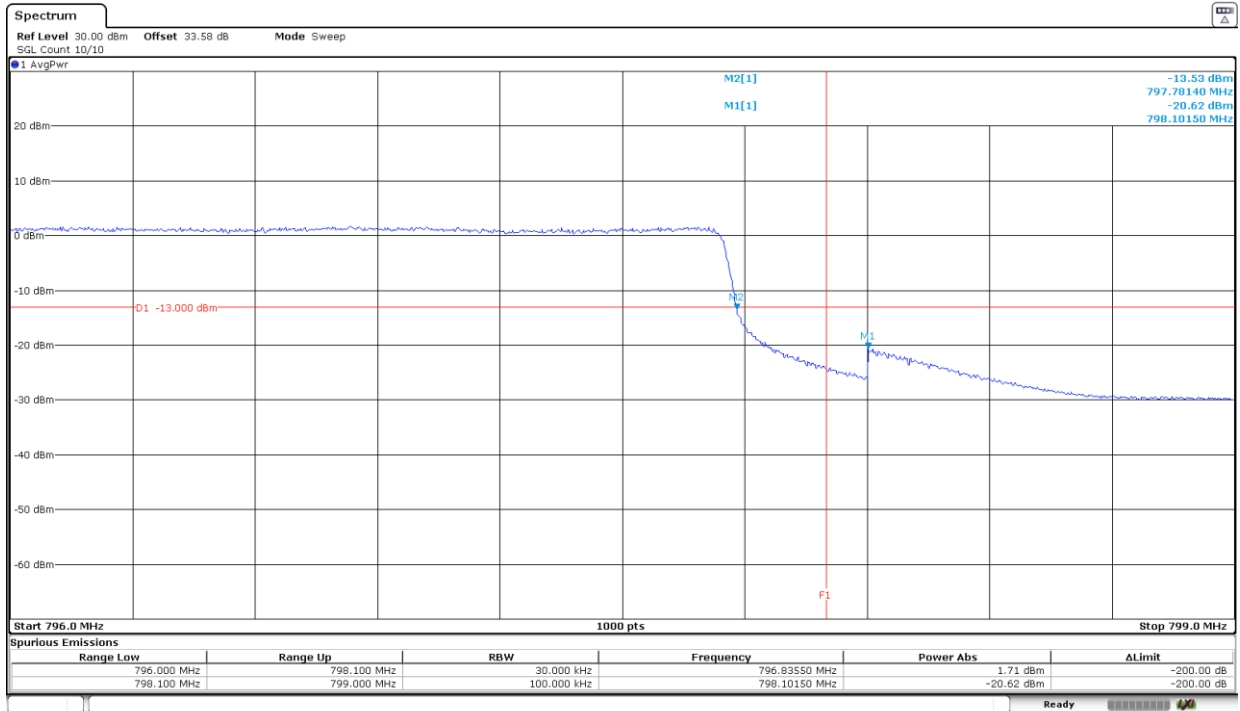

Date: 4.OCT.2023 08:54:18

Radiated Emissions

Limits

1. LTE Cat 1bis Band 14:

* FCC § 90.543 (e) & (f):

Transmitters operating in 758-768 MHz and 788-798 MHz bands must meet the emission limitations in (e) of this section.

(e) For operations in the 758-768 MHz and the 788-798 MHz bands, the power of any emission outside the licensee's frequency band(s) of operation shall be attenuated below the transmitter power (P) within the licensed band(s) of operation, measured in watts, in accordance with the following:

(1) On all frequencies between 769-775 MHz and 799-805 MHz, by a factor not less than $76 + 10 \log (P)$ dB in a 6.25 kHz band segment, for base and fixed stations.

(2) On all frequencies between 769-775 MHz and 799-805 MHz, by a factor not less than $65 + 10 \log (P)$ dB in a 6.25 kHz band segment, for mobile and portable stations.

(3) On any frequency between 775-788 MHz, above 805 MHz, and below 758 MHz, by at least $43 + 10 \log (P)$ dB.

(4) Compliance with the provisions of paragraphs (e) (1) and (2) of this section is based on the use of measurement instrumentation such that the reading taken with any resolution bandwidth setting should be adjusted to indicate spectral energy in a 6.25 kHz segment.

(5) Compliance with the provisions of paragraph (e) (3) of this section is based on the use of measurement instrumentation employing a resolution bandwidth of 100 kHz or greater. However, in the 100 kHz bands immediately outside and adjacent to the frequency block, a resolution bandwidth of 30 kHz may be employed.

(f) For operations in the 758–775 MHz and 788–805 MHz bands, all emissions including harmonics in the band 1559–1610 MHz shall be limited to -70 dBW/MHz equivalent isotropically radiated power (EIRP) for wideband signals, and -80 dBW EIRP for discrete emissions of less than 700 Hz bandwidth. For the purpose of equipment authorization, a transmitter shall be tested with an antenna that is representative of the type that will be used with the equipment in normal operation.

* RSS-140 Clause 4.4:

The power of any unwanted emission outside the bands 758-768 MHz and 788-798 MHz shall be attenuated below the transmitter output power P in dBW as follows, where p is the transmitter output power in watts:

a) For any frequency between 769-775 MHz and 799-806 MHz:

- i) $76 + 10 \log (p)$, dB in a 6.25 kHz band for fixed and base station equipment.
- ii) $65 + 10 \log (p)$, dB in a 6.25 kHz band for mobile and portable/hand-held equipment

b) For any frequency between 775-788 MHz, above 806 MHz, and below 758 MHz:

$43 + 10 \log (p)$, dB in a bandwidth of 100 kHz or greater. However, in the 100 kHz bands immediately outside and adjacent to the frequency bands 758-768 MHz and 788-798 MHz, a resolution bandwidth of 30 kHz may be employed.

In addition, the equivalent isotropically radiated power (e.i.r.p.) of all emissions, including harmonics in the band 1559-1610 MHz, shall not exceed -70 dBW/MHz for wideband emissions, and -80 dBW/kHz for discrete emissions of less than 700 Hz bandwidth.

Method

The measurement was performed with the EUT inside an anechoic chamber. The spectrum was scanned from 30 MHz to at least the 10th harmonic of the High frequency generated within the equipment.

For radiated emissions measurements performed at frequencies less than or equal to 1 GHz, the EUT was placed on a RF-transparent table or support at a nominal height of 80 cm above the reference ground plane, at a 3 meter distance from the measuring antenna.

For radiated measurements performed at frequencies above 1 GHz, the EUT shall be placed on an RF transparent table or support at a nominal height of 1.5 m above the ground plane, at a 3 meter distance from the measuring antenna.

Detected emissions were maximized at each frequency by rotating the EUT and adjusting the height and polarization of the measuring antenna. The maximum meter reading was recorded.

Measurement limit:

According to specification, the power of emissions shall be attenuated below the transmitter power (P) by a factor of at least $43 + 10 \log (P)$ dB, P in watts.

At P_o transmitting power, the specified minimum attenuation becomes $43+10\log (P_o)$, and the level in dBm relative P_o becomes:

$$P_o \text{ (dBm)} - [43 + 10 \log (P_o \text{ in mwatts}) - 30] = - 13 \text{ dBm}$$

The maximum field strength (dB μ V/m) of each detected emission at less than 20 dB respect to the limit is converted to an equivalent EIRP level (dBm) according to ANSI C63.26 with the formula:

$EIRP \text{ (dBm)} = E \text{ (dB}\mu\text{V/m)} + 20 \log(D) - 104.8$; where D is the measurement distance (in the far field region) in m. $D = 3 \text{ m}$

According to specification. the power of emissions shall be attenuated below the transmitter power (P) by a factor not less $65 + 10 \log (P)$ dB in a 6.25 kHz band segment. P in watts.

At P_o transmitting power. the specified minimum attenuation becomes $65+10\log (P_o)$. and the level in dBm relative P_o becomes:

$$P_o \text{ (dBm)} - [65 + 10 \log (P_o \text{ in mwatts}) - 30] = - 35 \text{ dBm}$$

For the LTE Cat 1bis Band 14, a resolution bandwidth / video bandwidth of 100 kHz / 300 kHz was used for frequencies below 1 GHz and 1 MHz / 3 MHz for frequencies above 1 GHz.

Test Setup

Radiated measurements below 1 GHz:

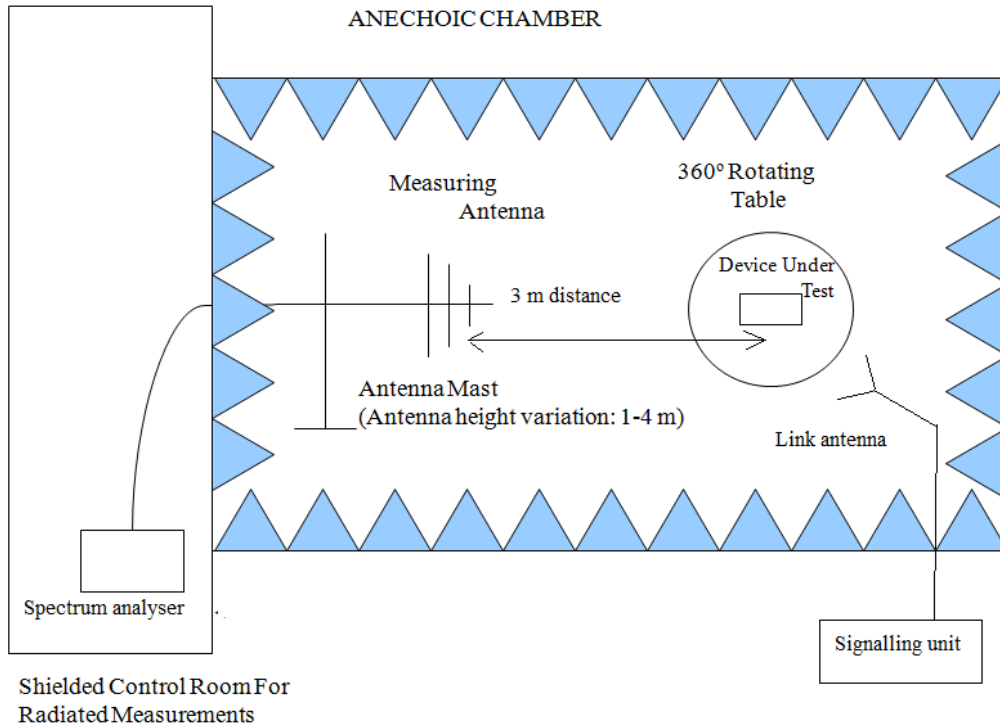

Radiated measurements above 1 GHz:

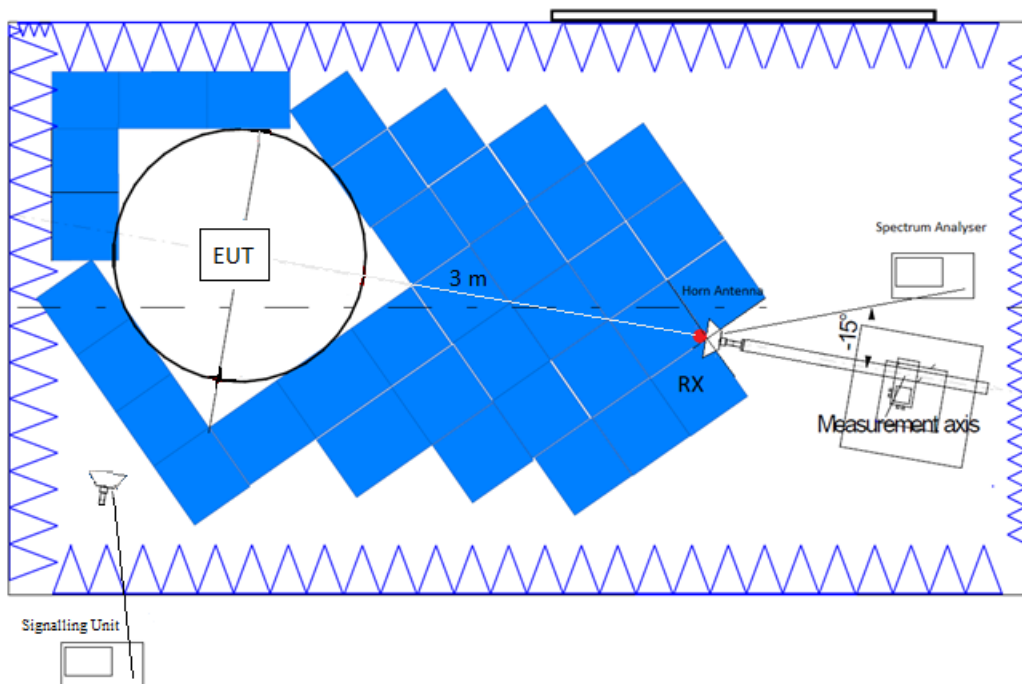

Results

Measurements required on one frequency near top channel and one frequency near bottom channel, according to FCC § 15.31 (m).

LTE Cat 1bis Band 14:

A preliminary scan determined the BW=5 MHz, QPSK, RB Size=1, RB Offset=0 as the worst-case. The next results are for this worst-case configuration.

- LOW CHANNEL:

Frequency range 30 MHz - 1 GHz:

Spurious frequencies at less than 20 dB below the limit:

Spurious frequency (MHz)	E.I.R.P (dBm)	Polarization	Detector
779.7121	-25.14	V	Peak

Frequency range 1 - 8 GHz:

Spurious frequencies at less than 20 dB below the limit:

Spurious frequency (MHz)	E.I.R.P (dBm)	Polarization	Detector
1576.6469	-57.93	H	Peak

- HIGH CHANNEL:

Frequency range 30 MHz - 1 GHz:

Spurious frequencies at less than 20 dB below the limit:

Spurious frequency (MHz)	E.I.R.P (dBm)	Polarization	Detector
784.6896	-22.41	V	Peak
802.0135	-38.65	V	Peak
799.8085	-43.69	V	Peak
801.1015	-53.1	V	Peak

Frequency range 1 - 8 GHz:

Spurious frequencies at less than 20 dB below the limit:

Spurious frequency (MHz)	E.I.R.P (dBm)	Polarization	Detector
1586.6514	-58.6	H	Peak

Measurement uncertainty (dB): < ± 5.35 for $f \geq 30$ MHz up to 1 GHz
< ± 4.32 for $f \geq 1$ GHz up to 8.5 GHz

Verdict

Pass

LTE Cat 1bis Band 14:

FREQUENCY RANGE 30 MHz - 1 GHz:

- LOW CHANNEL:

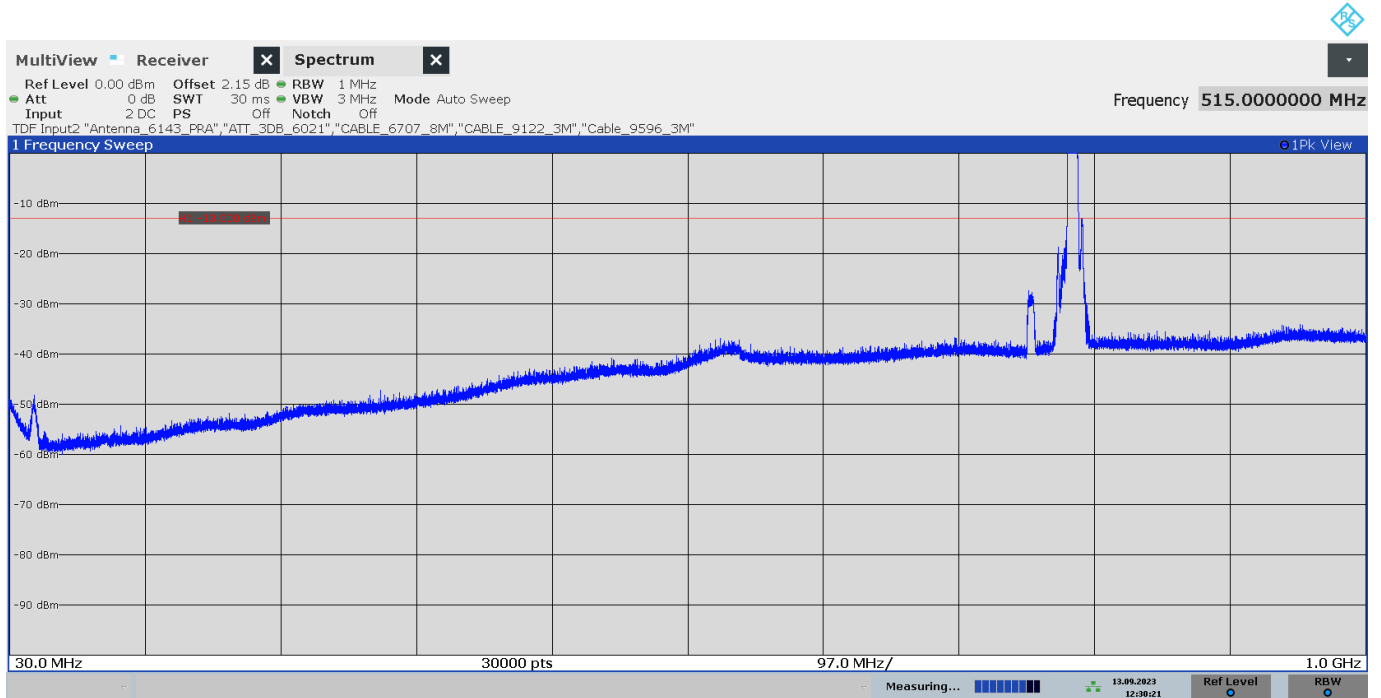

12:30:21 13.09.2023

The peak above the limit is the carrier frequency:
 LTE Cat 1bis Band 14, 790.5 MHz

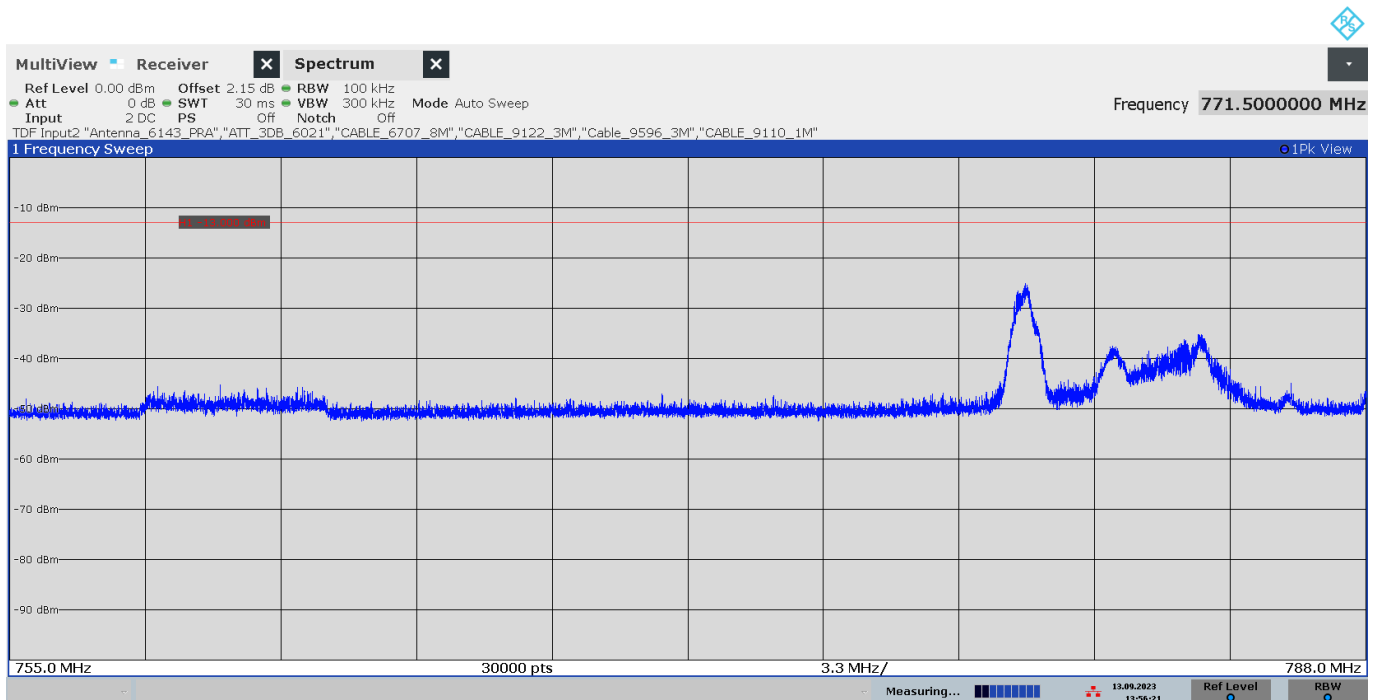

13:56:22 13.09.2023

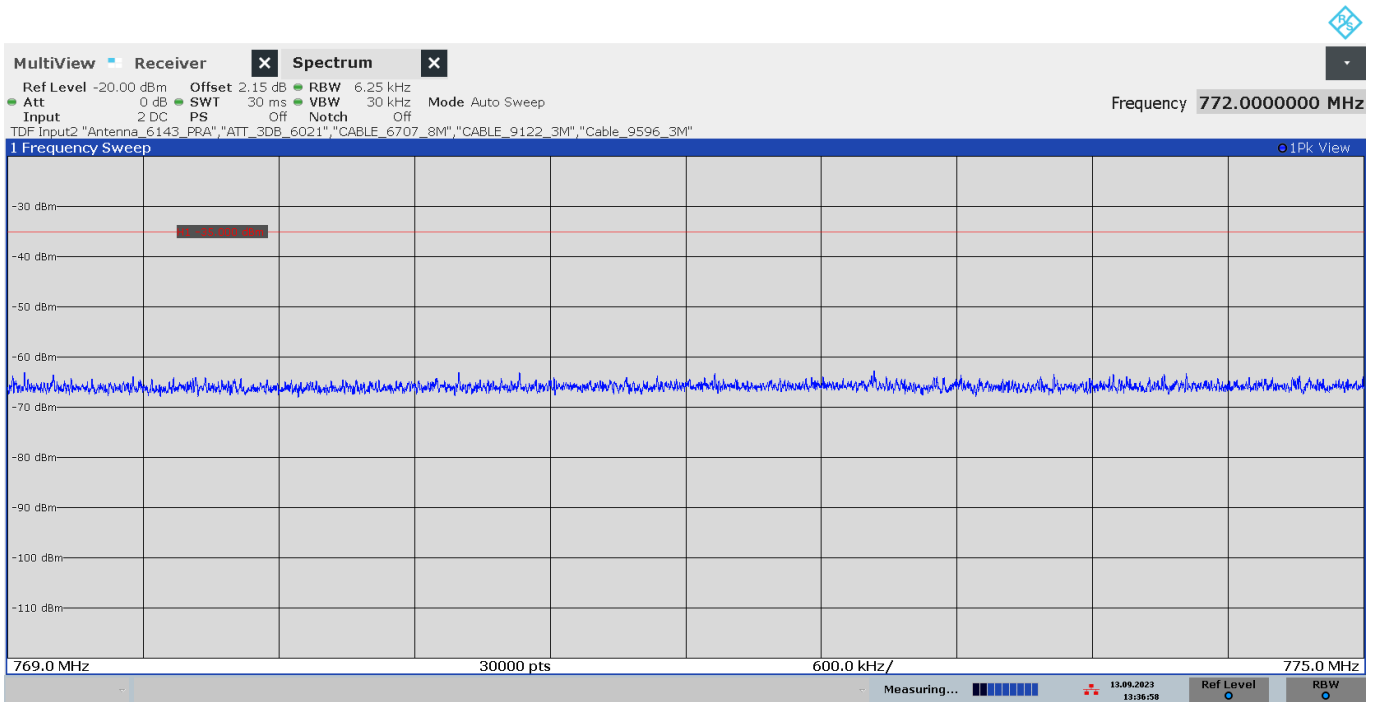

13:36:58 13.09.2023

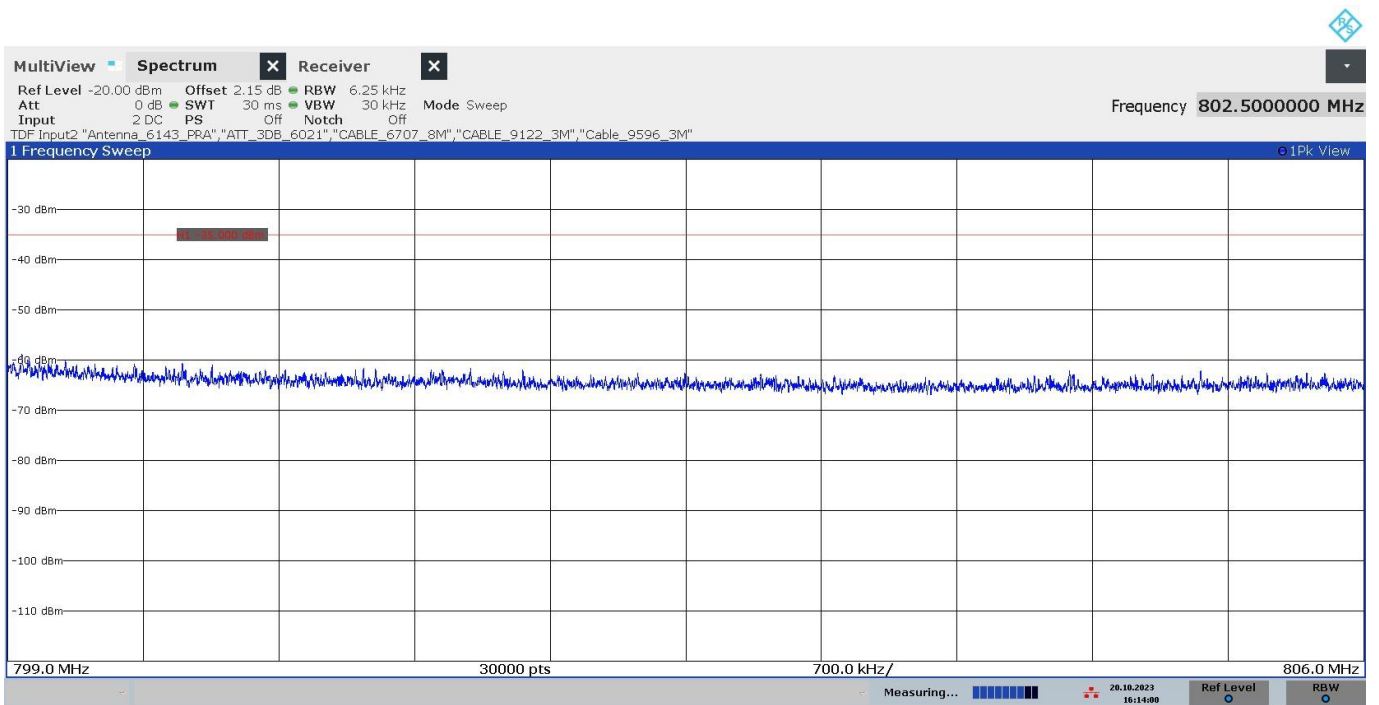

16:14:01 20.10.2023

- HIGH CHANNEL:

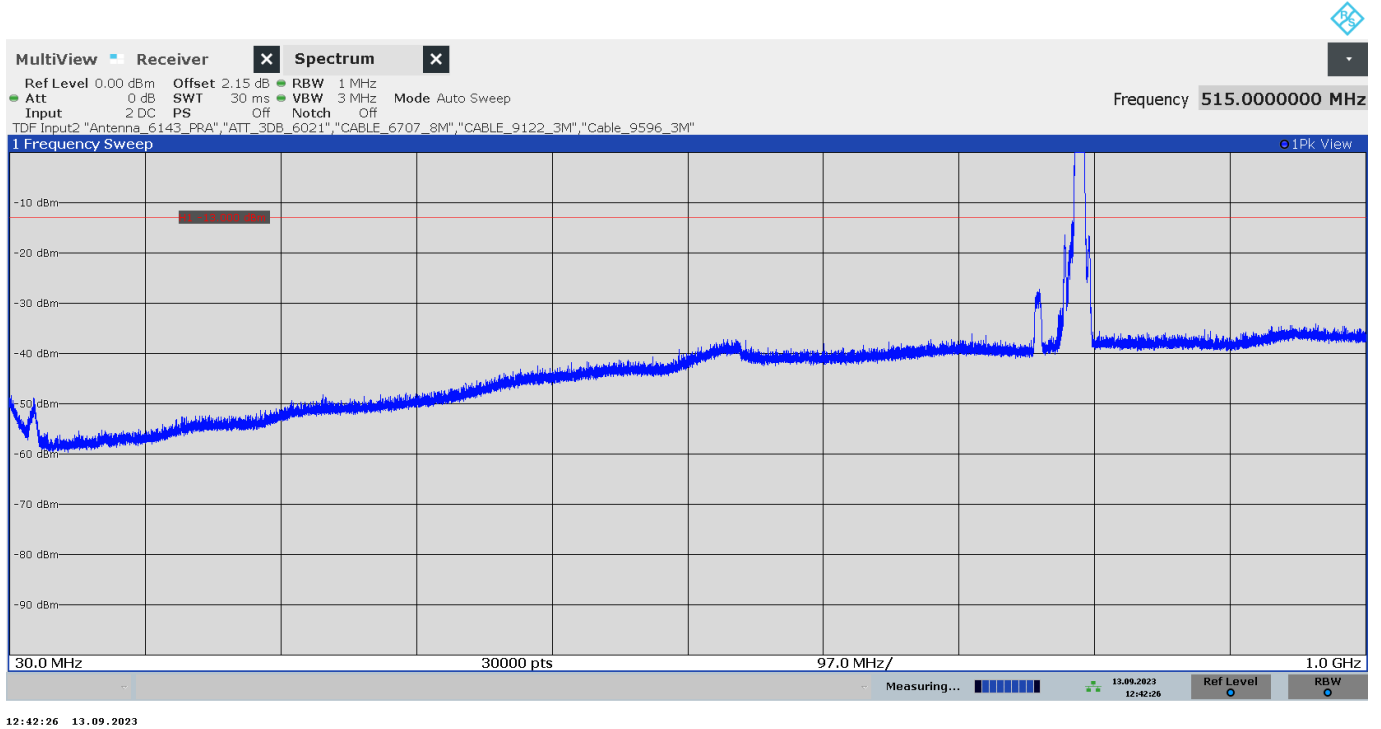

12:42:26 13.09.2023

The peak above the limit is the carrier frequency:
 LTE Cat 1bis Band 14, 795.5 MHz

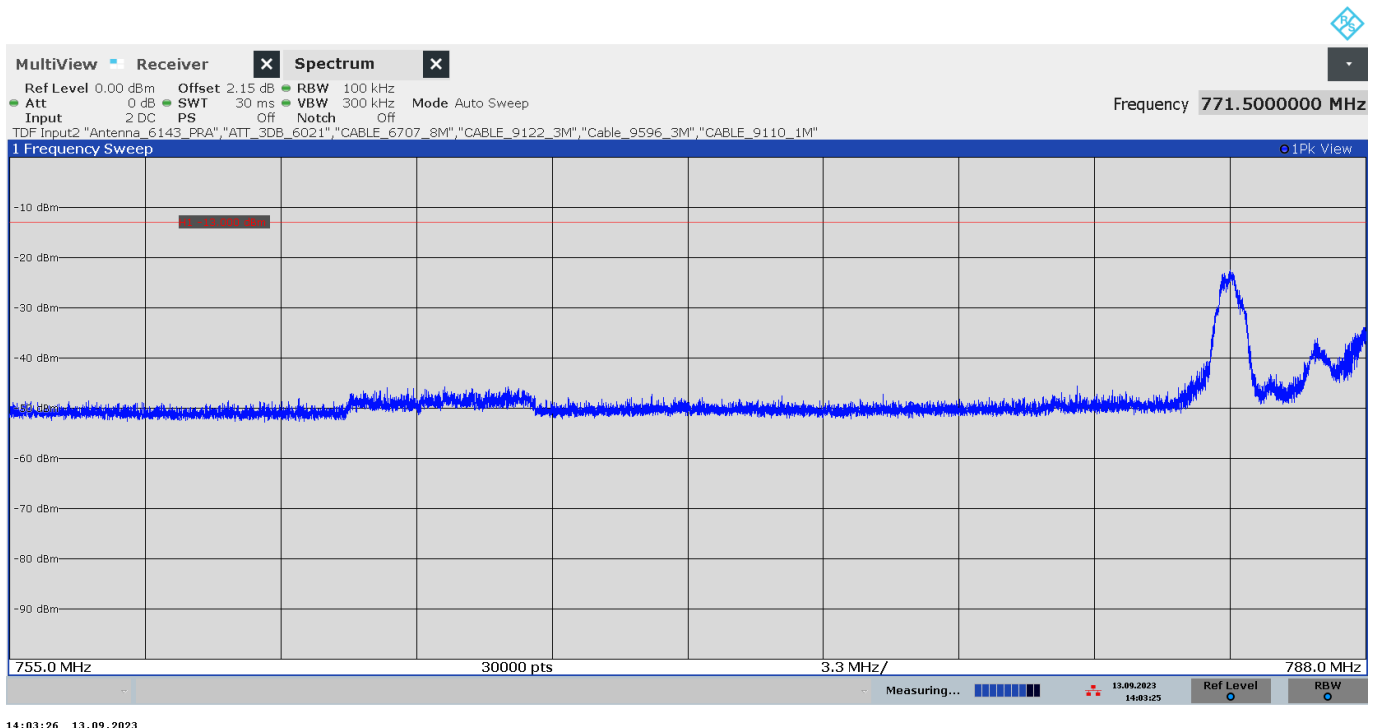

14:03:26 13.09.2023

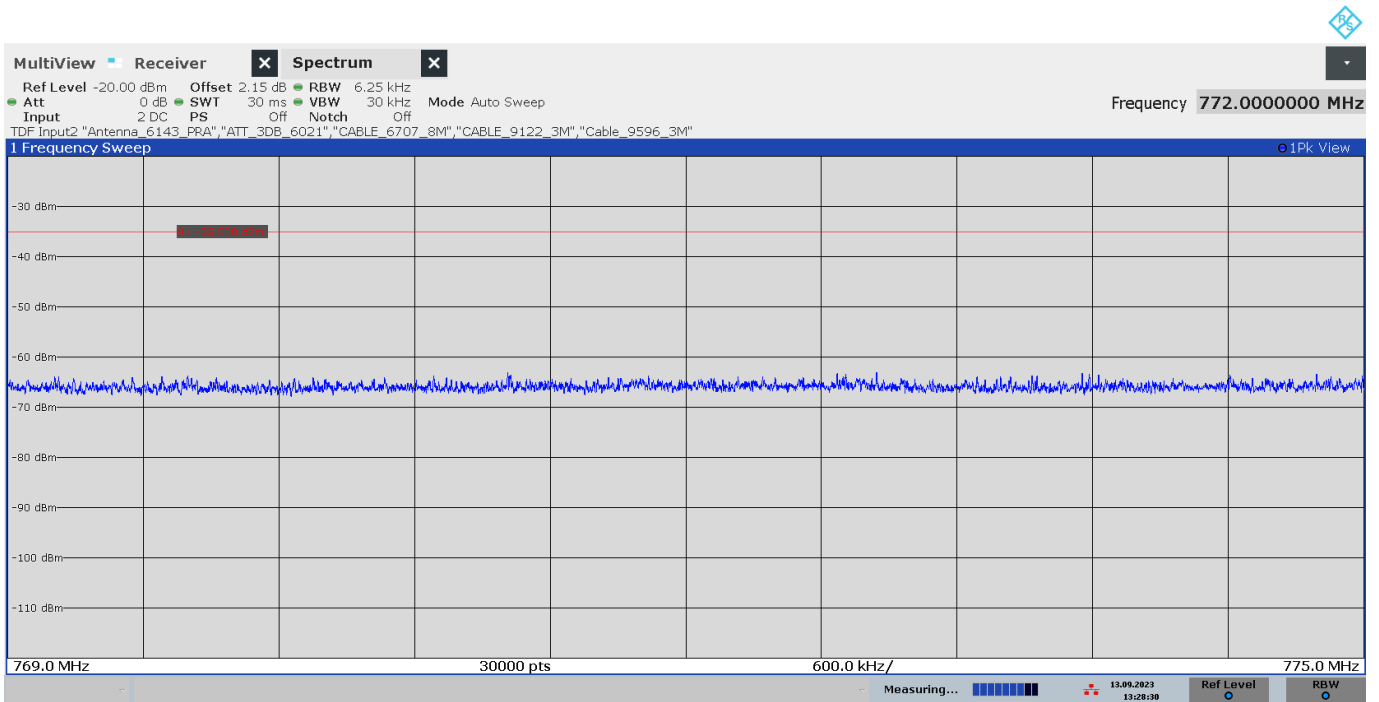

13:28:30 13.09.2023

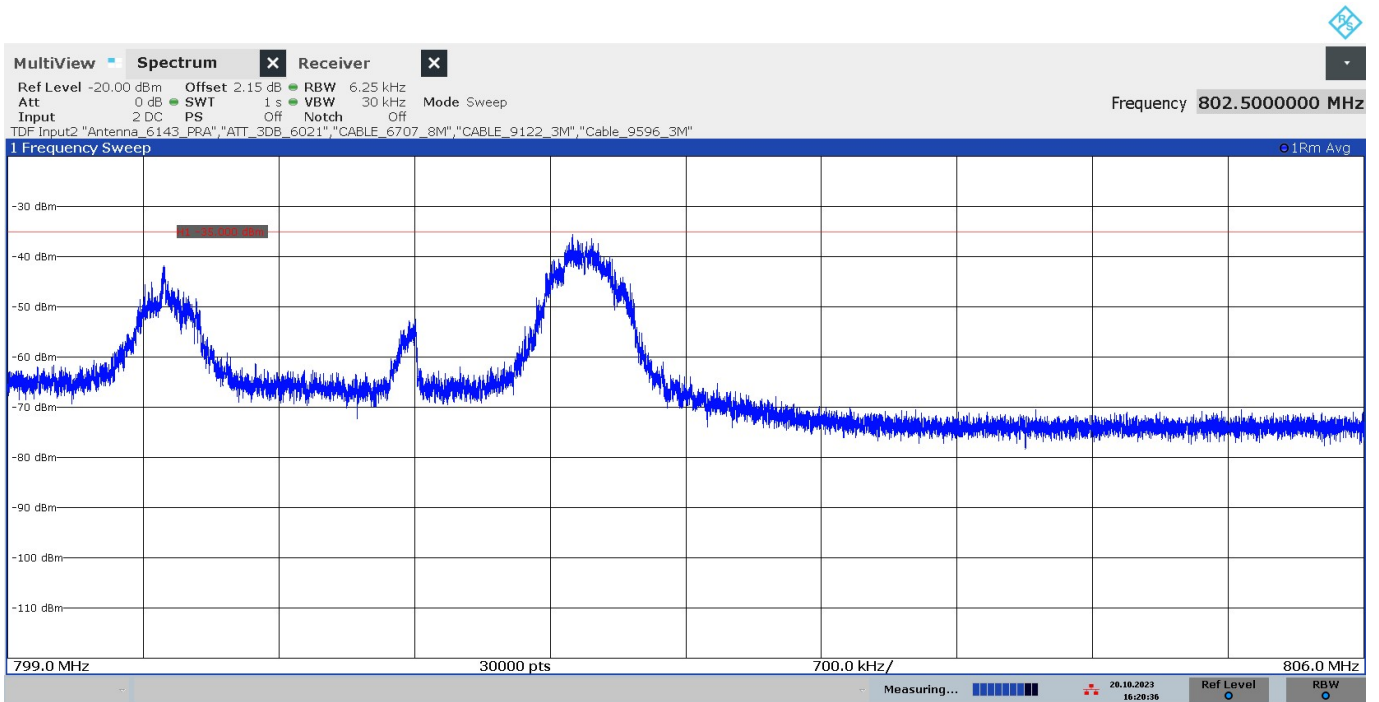

16:20:37 20.10.2023

FREQUENCY RANGE 1 - 8 GHz:

- LOW CHANNEL:

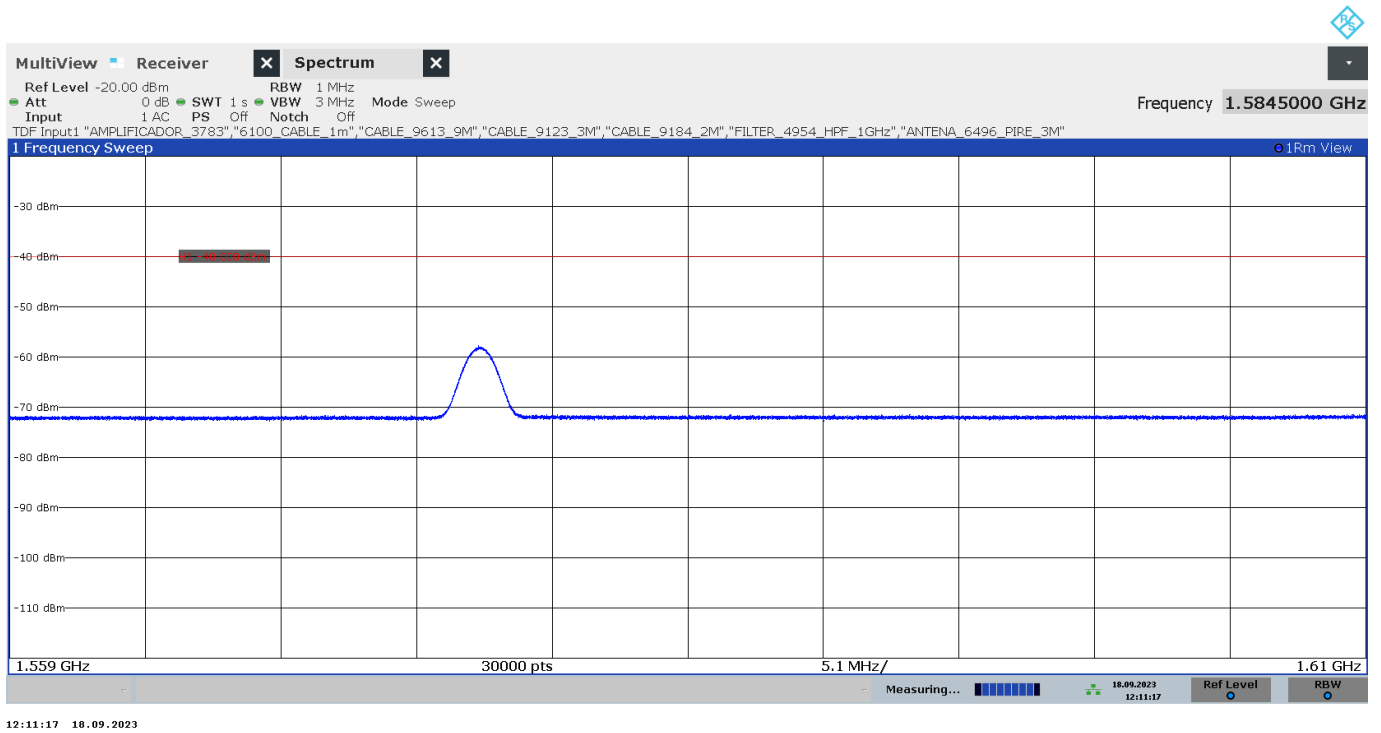
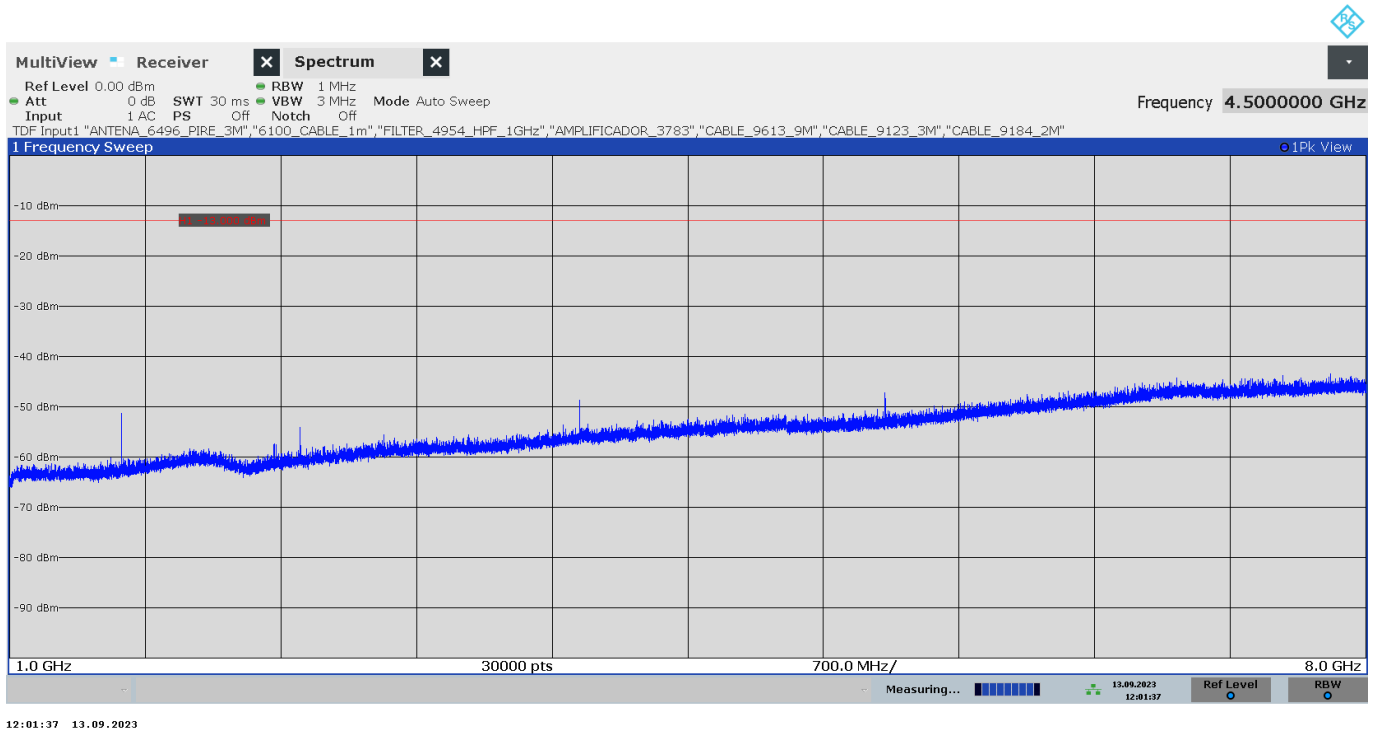

- HIGH CHANNEL:

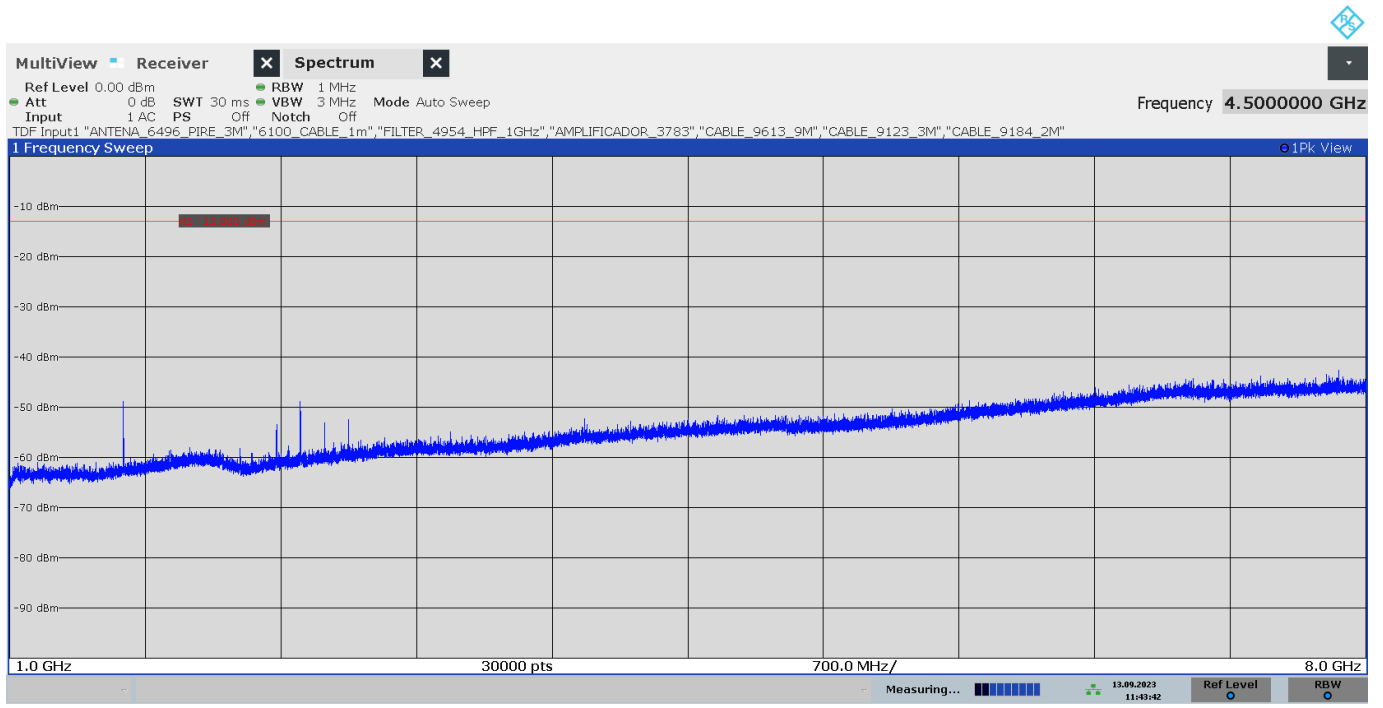

11:43:42 13.09.2023

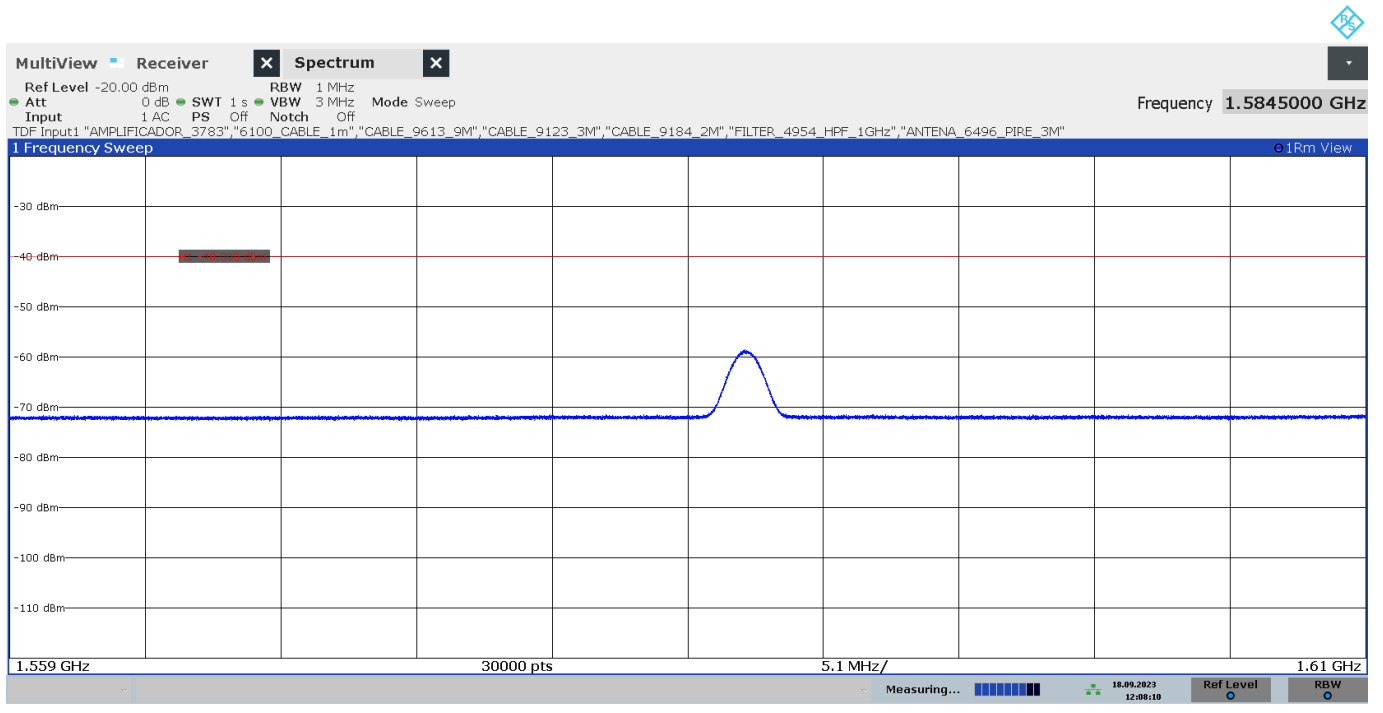

12:08:10 13.09.2023