

ISED CABid: ES1909
 Lab. Company Number: 4621A

Test report No:
 75461RRF.001

Test Report

USA FCC Part 22

CANADA RSS-132

(*) Identification of item tested	LTE Cat 1bis module
(*) Trademark	Sequans Communications
(*) Model and /or type reference	GC02S1-NA2
Other identification of the product	FCC ID: 2AAGMGC02SA IC: 12732A-GC02SA
(*) Features	4G LTE module HW version: Rev1 SW version: LR9.0.1.1-59215
Applicant	SEQUANS COMMUNICATIONS 55 Boulevard Charles de Gaulle, 92700 Colombes, France
Test method requested, standard	USA FCC Part 22 (10-1-21 Edition). CANADA RSS-132 Issue 4, Jan. 2023. ANSI C63.26-2015. KDB 971168 D01 Power Meas License Digital Systems v03r01, April. 2018.
Summary	IN COMPLIANCE
Approved by (name / position & signature)	José Manuel Gómez Galván EMC Consumer & RF Lab. Manager
Date of issue	2023-11-09
Report template No	FDT08_24 (*) "Data provided by the client"

Index

Competences and guarantees	3
General conditions	3
Uncertainty	3
Data provided by the client	3
Usage of samples	4
Test sample description	4
Identification of the client	5
Testing period and place	5
Document history	5
Environmental conditions	5
Remarks and comments	6
Testing verdicts	7
Summary	7
Appendix A: Test results for FCC 22 / RSS-132	8

Competences and guarantees

DEKRA Testing and Certification is a testing laboratory accredited by the National Accreditation Body (ENAC - Entidad Nacional de Acreditación) to perform the tests indicated in the Certificate No. 51/LE 147.

DEKRA Testing and Certification is an FCC-recognized accredited testing laboratory with appropriate scope of accreditation that covers the performed tests in this report.

DEKRA Testing and Certification is an ISED-recognized accredited testing laboratory, CABid: ES1909, Company Number: 4621A, with the appropriate scope of accreditation that covers the performed tests in this report.

In order to assure the traceability to other national and international laboratories, DEKRA Testing and Certification has a calibration and maintenance program for its measurement equipment.

DEKRA Testing and Certification guarantees the reliability of the data presented in this report, which is the result of the measurements and the tests performed to the item under test on the date and under the conditions stated on the report and it is based on the knowledge and technical facilities available at DEKRA Testing and Certification at the time of performance of the test.

DEKRA Testing and Certification is liable to the client for the maintenance of the confidentiality of all information related to the item under test and the results of the test.

The results presented in this Test Report apply only to the particular item under test established in this document.

IMPORTANT: No parts of this report may be reproduced or quoted out of context, in any form or by any means, except in full, without the previous written permission of DEKRA Testing and Certification.

General conditions

1. This report is only referred to the item that has undergone the test.
2. This report does not constitute or imply on its own an approval of the product by the Certification Bodies or competent Authorities.
3. This document is only valid if complete; no partial reproduction can be made without previous written permission of DEKRA Testing and Certification S.A.U.
4. This test report cannot be used partially or in full for publicity and/or promotional purposes without previous written permission of DEKRA Testing and Certification S.A.U. and the Accreditation Bodies.

Uncertainty

Uncertainty (factor $k=2$) was calculated according to the DEKRA Testing and Certification S.A.U. internal document PODT000.

Data provided by the client

The following data has been provided by the client:

1. Information relating to the description of the sample ("Identification of the item tested", "Trademark", "Model and/or type reference tested").
2. The sample model is GC02S1-NA2. The Calliope 2 GC02S1 modules are based on Sequans's second-generation Calliope 2 silicon and delivers optimized 4G LTE Cat 1 connectivity for IoT, M2M and consumer devices such as wearables and hearables that require voice support and speed higher than LTE-M.

DEKRA Testing and Certification S.A.U. declines any responsibility with respect to the information provided by the client and that may affect the validity of results.

Usage of samples

Samples undergoing test have been selected by: The client.

- Sample S/01 is composed of the following elements:

Control Nº	Description	Model	Serial Nº	Date of reception
75461B/005 *	LTE Cat 1bis module	GC02S1-NA2	C2E230509001024	21-07-2023
75461B/008	Antenna Cable	-	-	21-07-2023
75461B/004 **	LTE Cat 1bis module	GC02S1-NA2	C2E230509001008	21-07-2023

Sample S/01 has undergone the following test(s): The conducted tests indicated in Appendix A.

* : Used in the conducted tests but the PAPR, Spurious Emissions at Antenna Terminals at Block Edge tests.

** : Used in the PAPR, Spurious Emissions at Antenna Terminals at Block Edge tests.

- Sample S/02 is composed of the following elements:

Control Nº	Description	Model	Serial Nº	Date of reception
75461B/004	LTE Cat 1bis module	GC02S1-NA2	C2E230509001008	21-07-2023
75461B/001	Antenna	OmniLOG 90200	20200100252	21-07-2023
75461B/012	Antenna Cable	-	-	21-07-2023

Sample S/02 has undergone the following test(s): The radiated tests indicated in Appendix A.

Test sample description

Ports.....:	Port name and description	Cable				
		Specified max length [m]	Attached during test	Shielded	Coupled to patient ⁽³⁾	
	USB		<input checked="" type="checkbox"/>	<input type="checkbox"/>	<input type="checkbox"/>	
Supplementary information to the ports.....:	-					
Rated power supply	Voltage and Frequency		Reference poles			
	<input type="checkbox"/>	AC:	<input type="checkbox"/>	<input type="checkbox"/>	<input type="checkbox"/>	<input type="checkbox"/>
	<input checked="" type="checkbox"/>	DC: 3.2 to 5.5 V				
Rated Power..... :	-					
Clock frequencies..... :	-					
Other parameters	-					
Software version..... :	LR9.0.1.1-59215					
Hardware version	Rev1					
Dimensions in cm (W x H x D) ... :	21 x 1.8 x 19.5 mm					
Mounting position	<input checked="" type="checkbox"/>	Table top equipment				

	<input type="checkbox"/>	Wall/Ceiling mounted equipment		
	<input type="checkbox"/>	Floor standing equipment		
	<input type="checkbox"/>	Hand-held equipment		
	<input type="checkbox"/>	Other:		
Modules/parts..... :	Module/parts of test item	Type	Manufacturer	
	-	-	-	
Accessories (not part of the test item)	Description		Type	Manufacturer
	USB Cables		USB	-
	Antennas		Antenna	-
Documents as provided by the applicant	Description		File name	Issue date
	-		-	-

Identification of the client

SEQUANS COMMUNICATIONS
 55 Boulevard Charles de Gaulle, 92700, Colombes, France

Testing period and place

Test Location	DEKRA Testing and Certification S.A.U.
Date (start)	2023-08-14
Date (finish)	2023-08-30

Document history

Report number	Date	Description
75461RRF.001	2023-11-09	First release.

Environmental conditions

In the control chamber, the following limits were not exceeded during the test:

Temperature	Min. = 15 °C Max. = 35 °C
Relative humidity	Min. = 20 % Max. = 75 %

In the semi-anechoic chamber, the following limits were not exceeded during the test:

Temperature	Min. = 15 °C Max. = 35 °C
Relative humidity	Min. = 20 % Max. = 75 %

In the chamber for conducted measurements, the following limits were not exceeded during the test:

Temperature	Min. = 15 °C Max. = 35 °C
Relative humidity	Min. = 20 % Max. = 75 %

Remarks and comments

The tests have been performed by the technical personnel: Pablo Redondo, Antonio Maireles, Rafael Fernández, Ireneo Bibang, Sergio Carrasco, Fernando Chito.

Used instrumentation:

Control No.	Equipment	Next Calibration
8002	Climatic Chamber BINDER MK 56	2024-03
6157	Signal and Spectrum Analyzer 10 Hz - 40 GHz ROHDE AND SCHWARZ FSV40	2023-10
9229	Wideband Radio Communication Tester ROHDE AND SCHWARZ CMW500	2024-06
6794	Shielded Room ETS LINDGREN S101	N/A
6254	Attenuator 6 dB 2W DC-26.5 GHz, TECHNIWAVE TWSMAG2	2024-03
2214	Power Divider DC-25 GHz PICOSECOND PULSE LABS 5333-104	2023-12
7794	Signal and Spectrum Analyzer 10 Hz - 40 GHz ROHDE AND SCHWARZ FSV40	2025-04
7798	EMC/RF Testing SW ROHDE AND SCHWARZ WMS32	N/A
6791	Semianechoic Absorber Lined Chamber ETS LINDGREN FACT 3 200 STP	N/A
6792	Shielded Room ETS LINDGREN S101	N/A
6143	Biconical/Log Antenna 30 MHz - 6 GHz ETS LINDGREN 3142E	2023-10
4612	Horn Antenna 1-18 GHz SCHWARZBECK MESS-ELEKTRONIK BBHA 9120 D	2024-07
3783	RF Preamplifier G>30dB, 1-18GHz BONN ELEKTRONIK BLMA 0118-3A	2023-12
6142	RF Preamplifier, G>38dB 30MHz-6GHz BONN ELEKTRONIK BLNA 0360-01N	2024-06
7817	EMI Test Receiver 2 Hz - 44 GHz, ROHDE AND SCHWARZ ESW44	2023-12
6667	Wideband Radio Communication Tester ROHDE AND SCHWARZ CMW500	2024-06
4848	EMC/RF Testing SW ROHDE AND SCHWARZ EMC32	N/A

Testing verdicts

Not Applicable:	N/A
Pass:	P
Fail:	F
Not Measured:	N/M

Summary

Appendix A: LTE Cat 1bis Band 5.

FCC PART 22 / RSS-132 PARAGRAPH		
Requirement – Test case	Verdict	Remark
FCC 22.913 / RSS-132 5.4: RF Output Power	P	
FCC 2.1047 / RSS-132 5.2: Modulation Characteristics	P	
FCC 22.355 / RSS-132 5.3: Frequency Stability	P	
FCC 2.1049: Occupied Bandwidth	P	
FCC 22.917 / RSS-132 5.5: Spurious Emissions at Antenna Terminals	P	
FCC 22.917 / RSS-132 5.5: Spurious Emissions at Antenna Terminals at Block Edges	P	
FCC 22.917 / RSS-132 5.5: Radiated Emissions	P	
<u>Supplementary information and remarks:</u>		
None.		

Appendix A: Test results for FCC 22 / RSS-132

INDEX

TEST CONDITIONS	10
RF Output Power	10
Frequency Stability	15
Modulation Characteristics	20
Occupied Bandwidth	20
Spurious emissions at antenna terminals.....	22
Spurious emissions at antenna terminals at Block Edges.....	30
Radiated emissions	34

TEST CONDITIONS

(*): Declared by the Applicant.

POWER SUPPLY (*):

Vnominal: 3.8 Vdc
 Vminimum: 3.2 Vdc
 Vmaximum: 5.5 Vdc

Type of Power Supply: DC External.

ANTENNA (*):

MIDDLE BAND		ANTENNA TYPE
LTE Cat 1bis Band 5	+2 dBi	External (OmniLOG 90200)
LTE Cat 1bis Band 5	+1.1 dBi	Internal (FR01-S4-210)

Note: Pre-scan determines that external antenna is the worst case in terms of radiated spurious emissions.

TEST FREQUENCIES:

LTE Cat 1bis Band 5. QPSK and 16QAM:

	Channel (Frequency MHz)	
	BW=5 MHz	BW=10 MHz
Low	20425 (826.50)	20450 (829.00)
Middle	20525 (836.50)	20525 (836.50)
High	20625 (846.50)	20600 (844.00)

Note: BW=1.4 MHz and 3 MHz not supported.

RF Output Power

Limits

* FCC § 22.913:

Licensees in the Cellular Radiotelephone Service are subject to the effective radiated power (ERP) limits and other requirements in this Section. See also § 22.169.

(a) Maximum ERP. The ERP of transmitters in the Cellular Radiotelephone Service must not exceed the limits in this section.

(5) The ERP of mobile transmitters and auxiliary test transmitters must not exceed 7 watts (38.45 dBm E.R.P.).

* FCC § 2.1046. Measurements required: RF power output.

* RSS-132, 5.4:

The transmitter output power shall be measured in terms of average power. The equivalent radiated power (e.r.p.) shall not exceed 7 watts for mobile equipment and 3 watts for portable equipment.

The effective isotropic radiated power (e.i.r.p.) shall not exceed the limits specified in SRSP-503 for base station equipment.

In addition, the peak-to-average power ratio (PAPR) of the transmitter shall not exceed 13 dB for more than 0.1% of the time using a signal corresponding to the highest PAPR during periods of continuous transmission.

Method

The conducted RF output power measurements were made at the RF output terminals of the EUT using the power meter of the Universal Radio Communication tester R&S CMW500, selecting maximum transmission power of the EUT and different modes of modulation.

The peak-to-average power ratio (PAPR) is measured using an attenuator, power splitter and spectrum analyser with a Complementary Cumulative Distribution Function implemented.

The maximum equivalent isotropically radiated power (e.i.r.p.) is calculated by adding the declared maximum antenna gain (dBi).

The maximum effective radiated power e.r.p. is calculated from the maximum equivalent isotropically radiated power (e.i.r.p.) by subtracting 2.15 dB:

$$\text{E.R.P.} = \text{E.I.R.P.} - 2.15 \text{ dB}$$

Test Setup

1. CONDUCTED AVERAGE POWER:

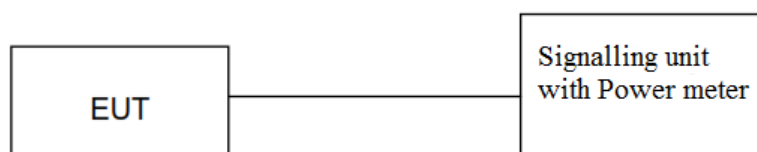

2. PEAK-TO-AVERAGE POWER RATIO (PAPR):

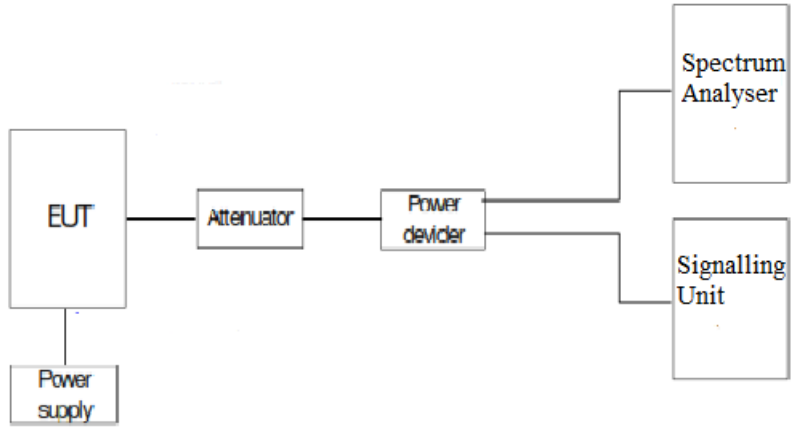

Results

1. CONDUCTED AVERAGE POWER:

LTE Cat 1bis Band 5:

Preliminary measurements determined the worst case of RF Power is BW=10 MHz, Middle Channel, QPSK, RB Size=1, RB Offset=0.

BANDWIDTH (MHz)	CHANNEL	FREQUENCY (MHz)	MODULATION	RB SIZE	RB OFFSET	AVERAGE POWER (dBm)
10	Low 20450	829 MHz	QPSK	1	0	22.32
				1	24	22.4
				1	49	22.37
				25	0	21.29
				25	12	21.34
				25	24	21.29
				50	0	21.17
			16-QAM	1	0	21.43
				1	24	21.51
				1	49	21.47
				25	0	20.29
				25	12	20.34
				25	24	20.32
				50	0	*
	Middle 20525	836.5 MHz	QPSK	1	0	22.75
				1	24	22.64
				1	49	22.65
				25	0	21.5
				25	12	21.44
				25	24	21.43
				50	0	21.36
			16-QAM	1	0	21.39
				1	24	21.37
				1	49	21.39
				25	0	20.47
				25	12	20.43
				25	24	20.45
50				0	*	
High 20600	844 MHz	QPSK	1	0	22.61	
			1	24	22.57	
			1	49	22.31	
			25	0	21.33	
			25	12	21.42	
			25	24	21.26	
			50	0	21.23	
		16-QAM	1	0	21.43	
			1	24	21.49	

				1	49	21.2
				25	0	20.32
				25	12	20.36
				25	24	20.25
				50	0	*

* Not supported

BW=10 MHz. QPSK:

MAX POWER	QPSK COND. POWER AVG (dBm)	ANTENNA GAIN (dBi)	RAD. POWER AVG EIRP(dBm)	RAD. POWER AVG ERP(dBm)
LOW	22.4	2	24.4	22.25
MIDDLE	22.75	2	24.75	22.6
HIGH	22.61	2	24.61	22.46
MAX:	22.75		24.75	22.6

BW=10 MHz. 16QAM:

MAX POWER	16QAM COND. POWER AVG (dBm)	ANTENNA GAIN (dBi)	RAD. POWER AVG EIRP(dBm)	RAD. POWER AVG ERP(dBm)
LOW	21.51	2	23.51	21.36
MIDDLE	21.39	2	23.39	21.24
HIGH	21.49	2	23.49	21.34
MAX:	21.51		23.51	21.36

2. PEAK-TO-AVERAGE POWER RATIO (PAPR):

LTE Cat 1bis Band 5:

Preliminary measurements determined the worst-case of PAPR is BW=10 MHz, Middle Channel, 16QAM, RB Size=1, RB Offset=49.

Low Channel:

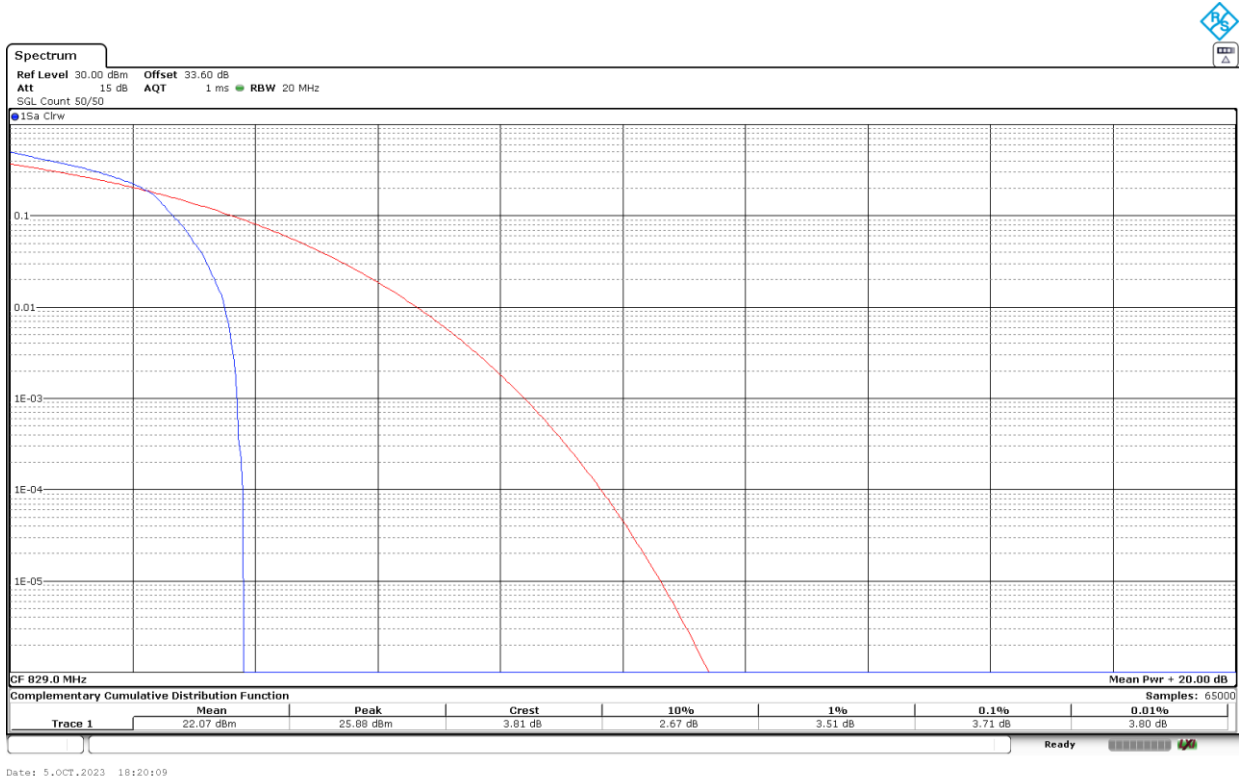

Middle Channel:

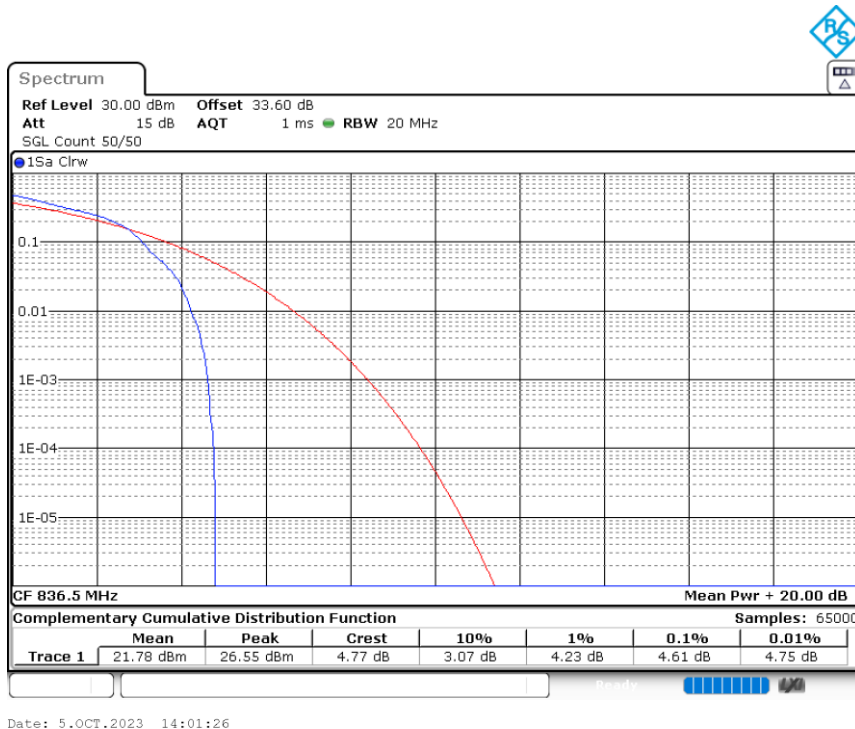

High Channel:

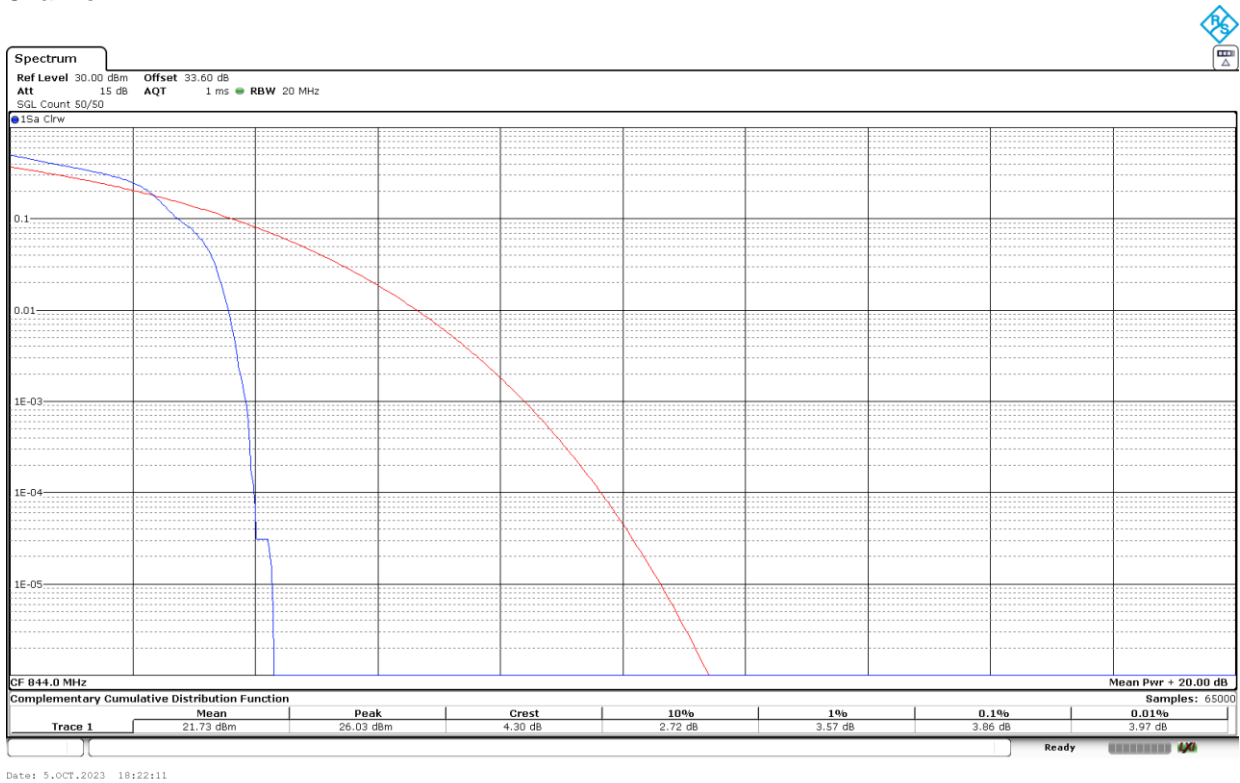

16QAM	Low	Middle	High
PAPR (dB)	3.71	4.61	3.86

Measurement uncertainty (dB) ± 1.11

Verdict

Pass

Frequency Stability

Limits

* FCC § 22.355:

Except as otherwise provided in this part, the carrier frequency of each transmitter in the Public Mobile Services must be maintained within the tolerances given in Table C–1 of this section.

Table C–1—Frequency Tolerance for Transmitters in the Public Mobile Services

Frequency range (MHz)	Base, fixed (ppm)	Mobile >3 watts (ppm)	Mobile ≤3 watts (ppm)
821 to 896	1.5	2.5	2.5

* FCC § 2.1055: Measurements required: Frequency stability.

* RSS-132, 5.3. The frequency stability shall be sufficient to ensure that the occupied bandwidth stays within each of the sub-bands when tested at the temperature and supply voltage variations specified in RSS-Gen.

Method

The frequency tolerance measurements over temperature variations were made over the temperature range of -30°C to +50°C. The EUT was placed inside a climatic chamber and the temperature was raised hourly in 10°C steps from -30°C up to +50°C.

The supply voltage was varied between 85% and 115% of nominal voltage.

The EUT was set in “Radio Resource Control (RRC) mode” in the middle channel using the Universal Radio Communication tester R&S CMW500 and the maximum frequency error was measured using the built-in calibrated frequency meter.

The reference point measurements were made at the RF output terminals of the EUT using an attenuator, power splitter and spectrum analyser. The EUT was controlled via the Universal Radio Communication tester R&S CMW500 selecting maximum transmission power of the EUT and different modes of modulation.

Test Setup

1. Frequency Tolerance:

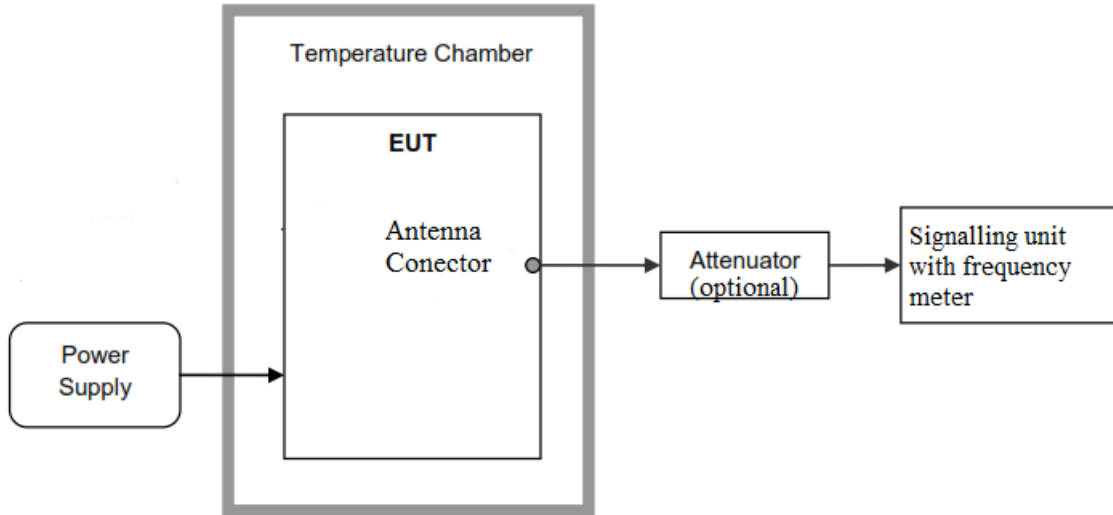

Results

LTE Cat 1bis Band 5:

The worst case modulation in terms of Frequency Stability is BW=5 MHz, QPSK, RB Size=1, RB Offset=0.

1. Frequency Tolerance:

- Frequency Stability over Temperature Variations:

Temperature (°C)	Frequency Error (Hz)	Frequency Error (ppm)
+85	0,16	0,000191273
+80	2,11	0,002522415
+70	-2,01	-0,002402869
+60	-1,46	-0,001745368
+50	1.04	0.001243276
+40	-0.9	-0.001075912
+30	-1.33	-0.001589958
+20	-0.63	-0.000753138
+10	-1.84	-0.002199641
0	-1.99	-0.00237896
-10	-1.49	-0.001781231
-20	-1.57	-0.001876868
-30	-1.19	-0.001422594

- Frequency Stability over Voltage Variations.

Supply voltage	Voltage (V)	Frequency Error (Hz)	Frequency Error (ppm)
Vmax	5.5	-1.9	-0.002271369
Vmin	3.2	-1.67	-0.001996414

2. Reference Frequency Points fL and fH:

The worst-case frequency offsets added or subtracted per band and bandwidth:

fL (MHz)	824.1356
fH (MHz)	848.8555

The reference frequency points fL and fH stay within the authorized blocks for the band above.

Measurement uncertainty (Hz) $\leq \pm 249.55$

Verdict

Pass

Modulation Characteristics

Limits

- * FCC § 2.1047: Measurements required: Modulation characteristics.
- * RSS-132, 5.2: Digital modulation shall be used.

Method

For LTE the EUT operates with QPSK and 16QAM modes in which the information is digitized and coded into a bit stream. The RF transmission is multiplexed using *Orthogonal Frequency Division Multiplexing (OFDM)* using different possible arrangement of subcarriers (Resource Blocks RB).

Test Setup

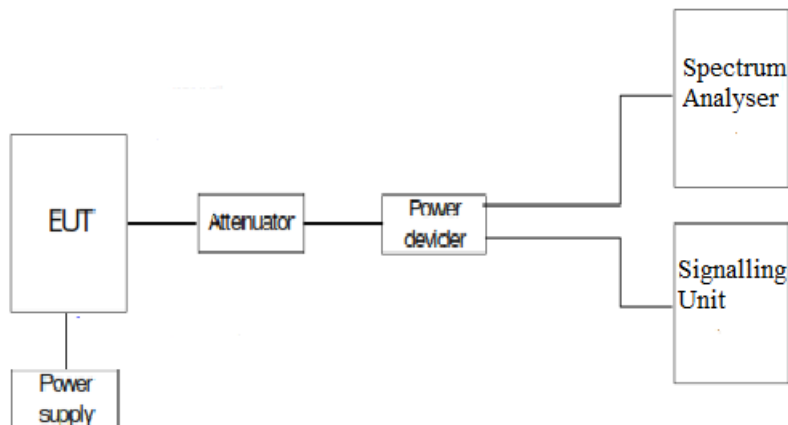

Results

The following plots show the modulation schemes in the EUT.

LTE Cat 1bis Band 5: BW=5 MHz. QPSK. RB Size=25. RB Offset=0.

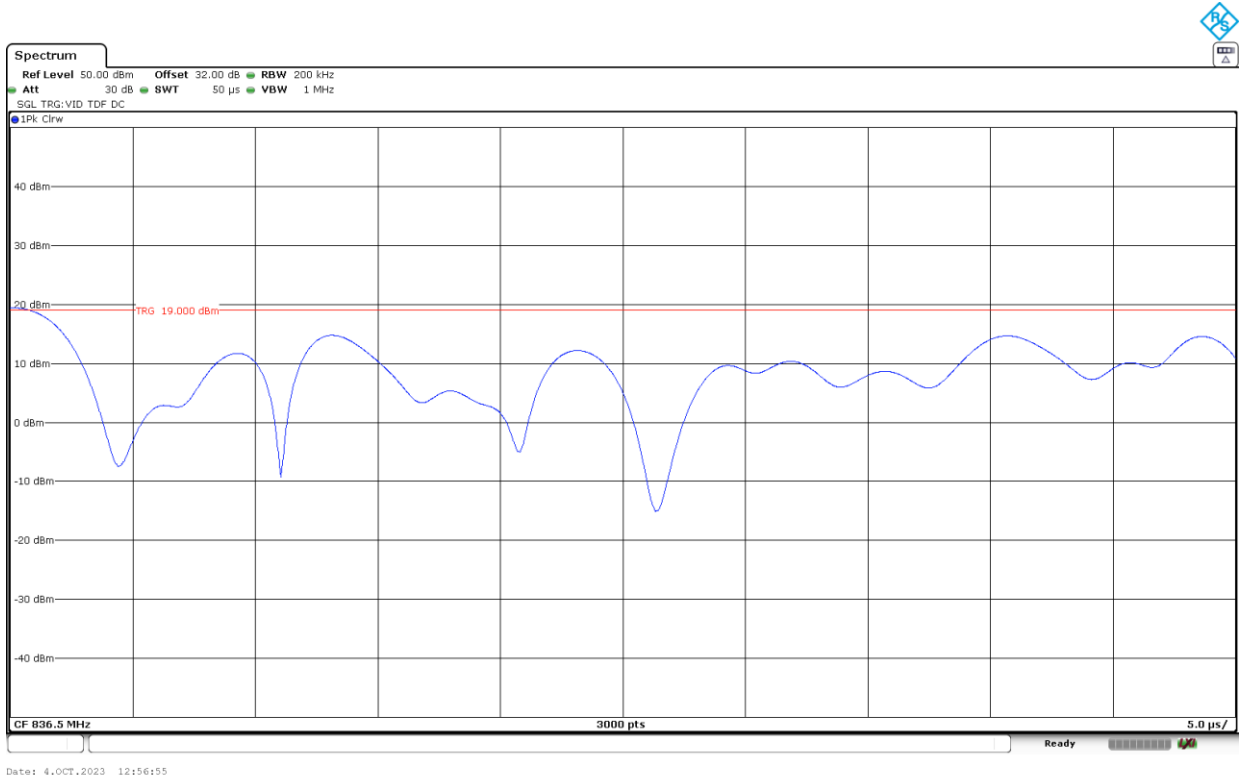

LTE Cat 1bis Band 5: BW=5 MHz. 16QAM. RB Size=25. RB Offset=0.

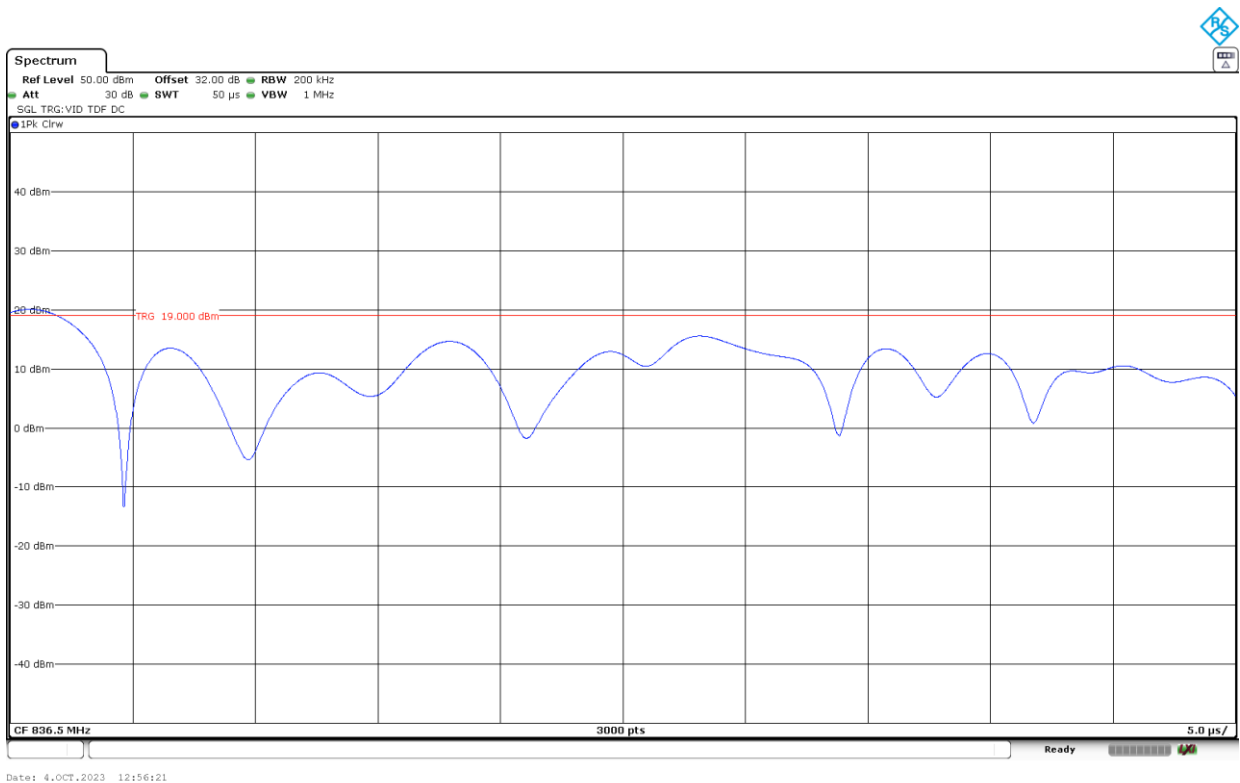

Occupied Bandwidth

Limits

- * FCC § 2.1049. Measurements required: Occupied bandwidth.
- * RSS-Gen, 6.7: Occupied bandwidth (or 99% emission bandwidth).

Method

The occupied bandwidth measurement was performed at the output terminals of the EUT using an attenuator, power splitter and spectrum analyser. The EUT was controlled via the Universal Radio Communication tester R&S CMW500 selecting maximum transmission power of the EUT and different modes of modulation. The 99% occupied bandwidth and the -26 dBc bandwidth were measured directly using the built-in bandwidth measuring option of spectrum analyser.

Test Setup

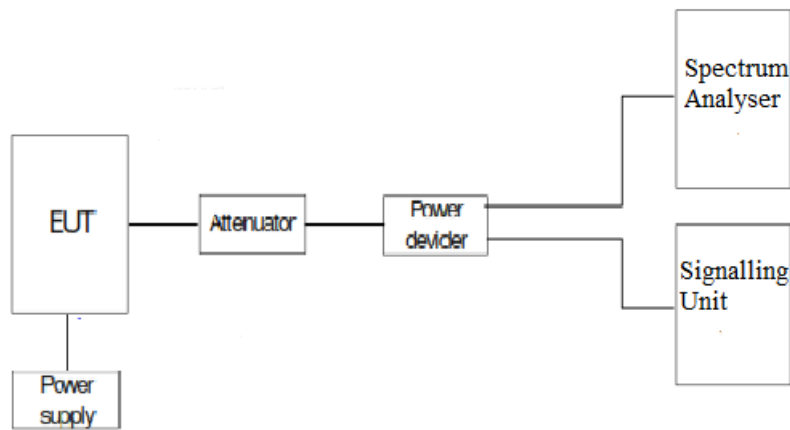

Results

The worst case of occupied bandwidth corresponds to Resource Block (RB) Size All and Offset 0 regardless the nominal bandwidth selected.

LTE Cat 1bis Band 5:

LTE Cat 1bis Band 5. BW=5 MHz. QPSK. RB Size=All. RB Offset=0.

Channel	Low	Middle	High
99% Occupied Bandwidth (kHz)	4550.00	4580.00	4540.00
-26 dBc Bandwidth (kHz)	5553.00	5425.00	5526.00
Measurement uncertainty (kHz)	<±3.75		

LTE Cat 1bis Band 5. BW=5 MHz. 16QAM. RB Size=All. RB Offset=0.

Channel	Low	Middle	High
99% Occupied Bandwidth (kHz)	4540.00	4560.00	4560.00
-26 dBc Bandwidth (kHz)	5624.00	5665.00	5626.00
Measurement uncertainty (kHz)	<±3.75		

LTE Cat 1bis Band 5. BW=5 MHz. QPSK. RB Size=All.

Low Channel:

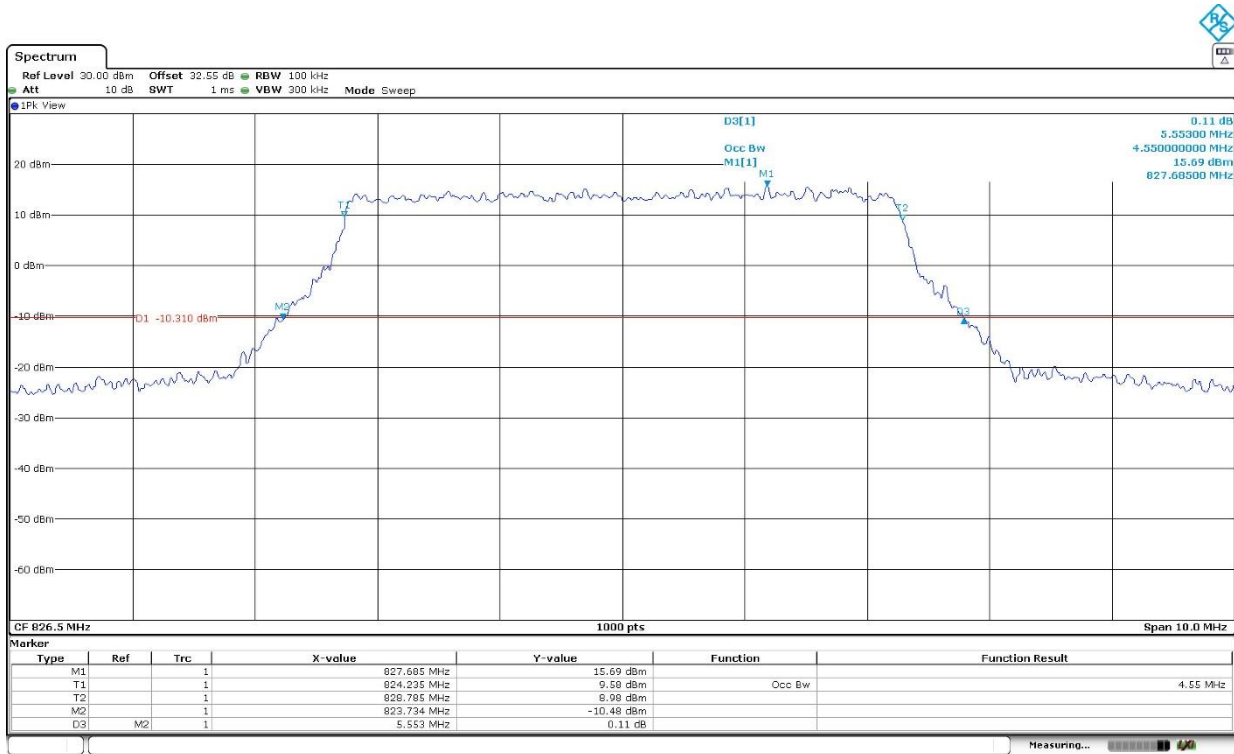

Middle Channel:

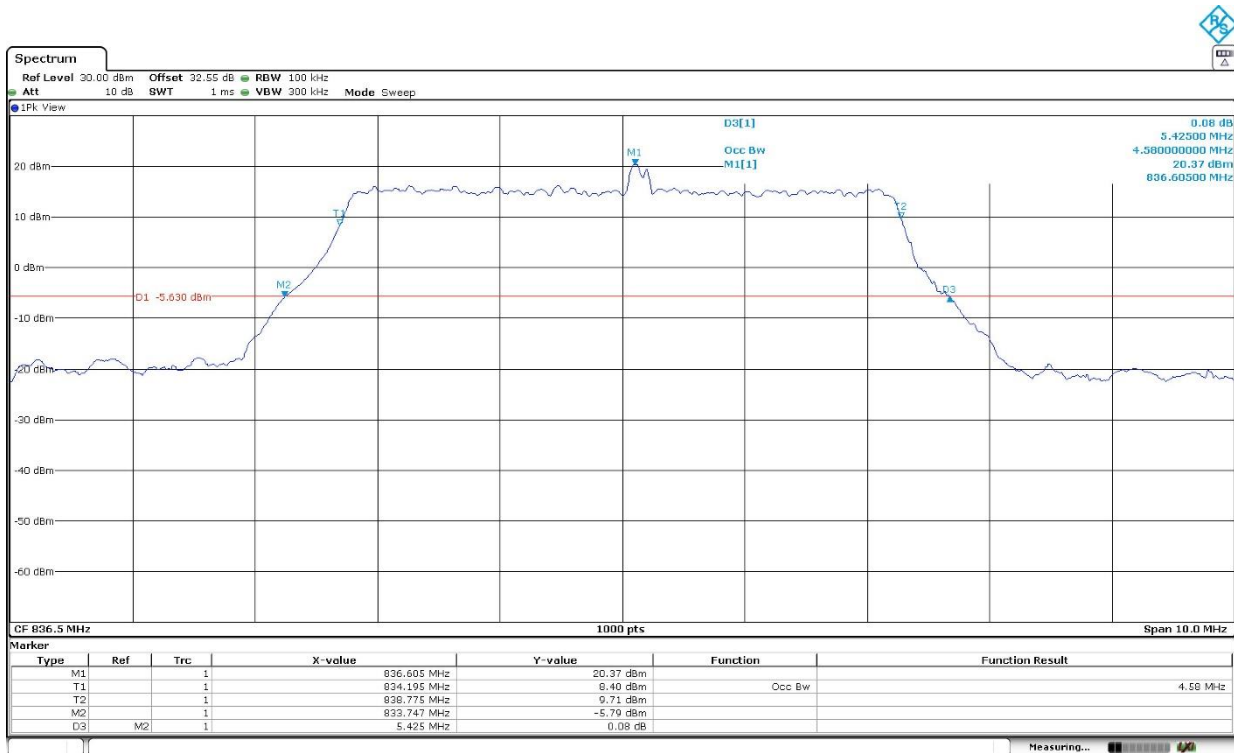

High Channel:

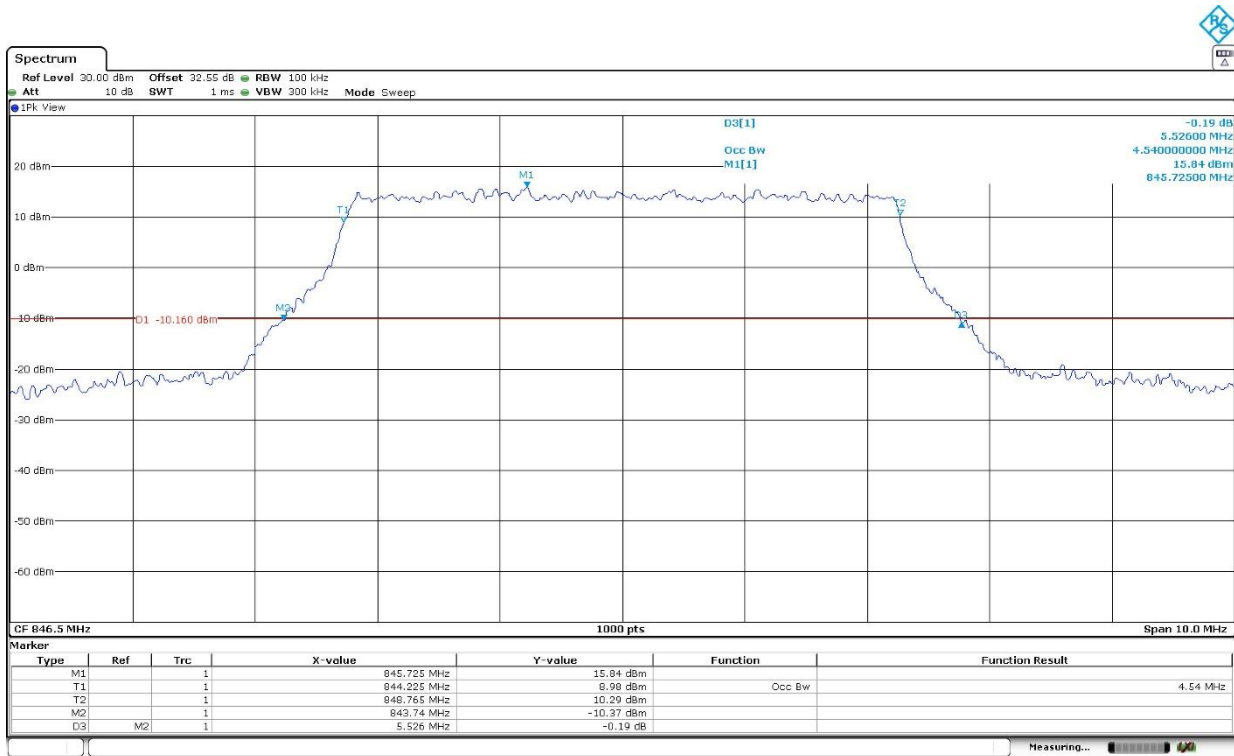

LTE Cat 1bis Band 5. BW=5 MHz. 16QAM. RB Size=All.

Low Channel:

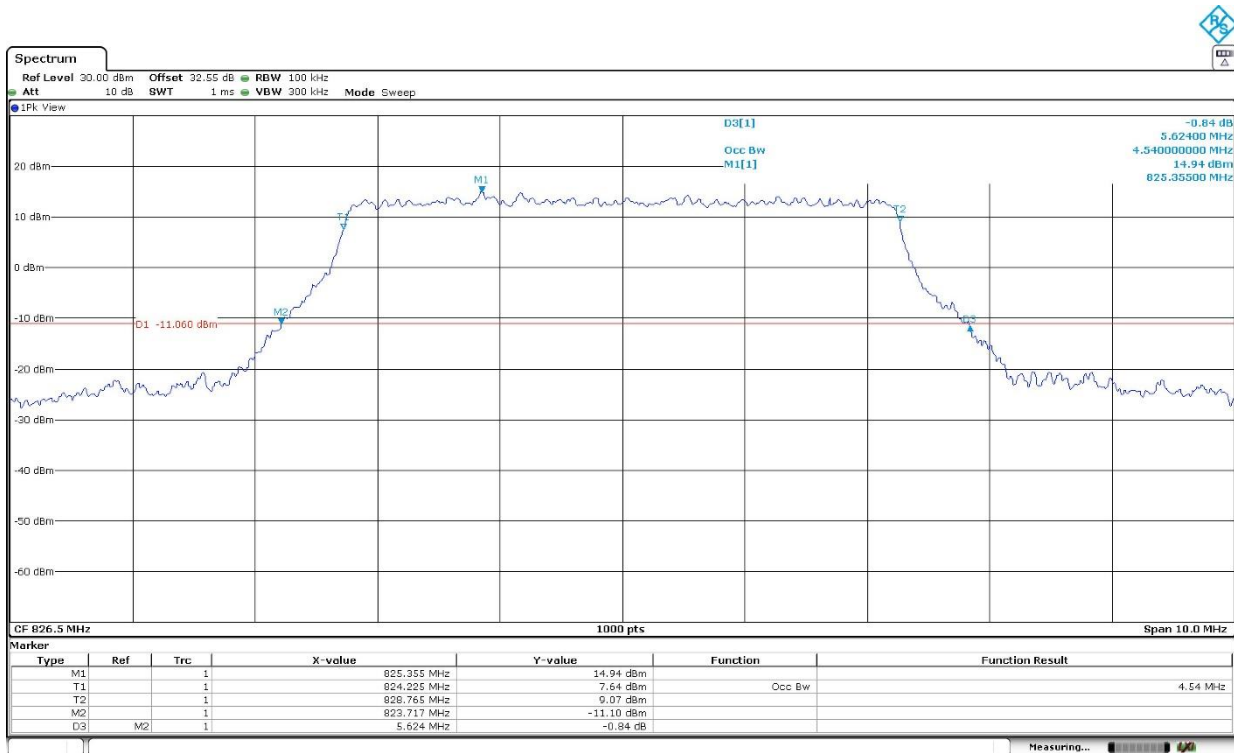

Middle Channel:

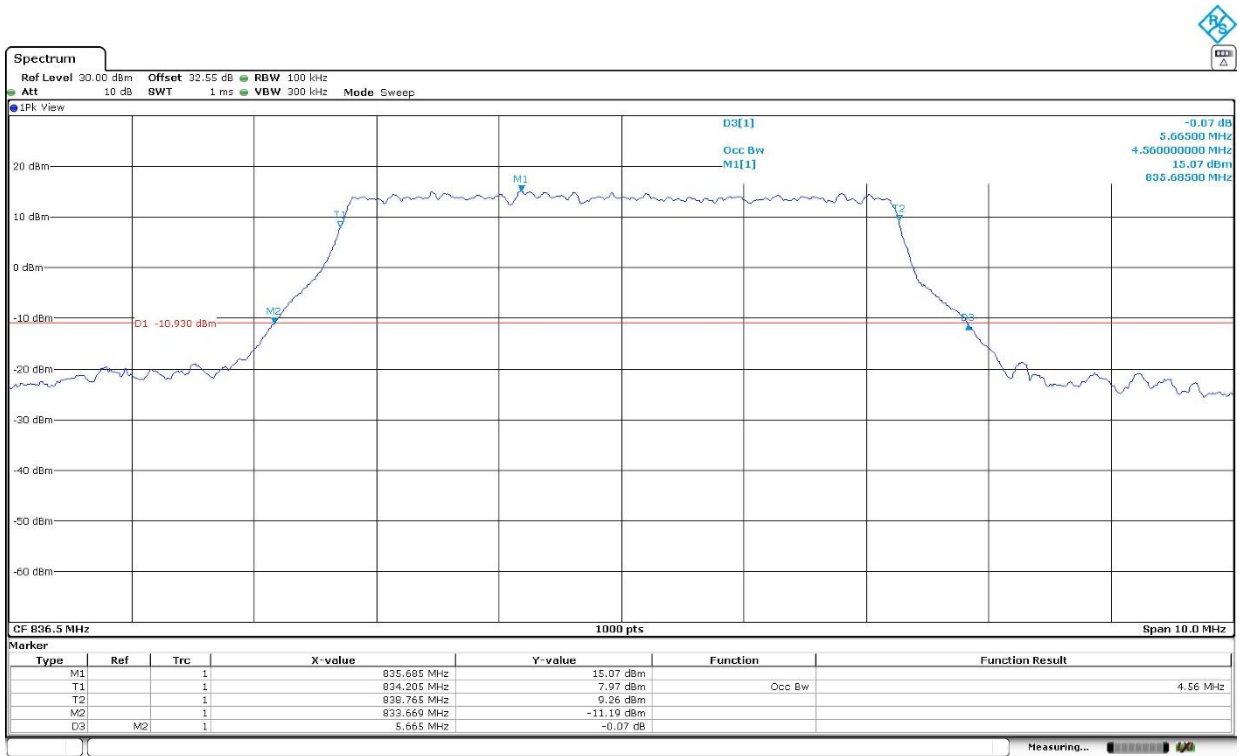

High Channel:

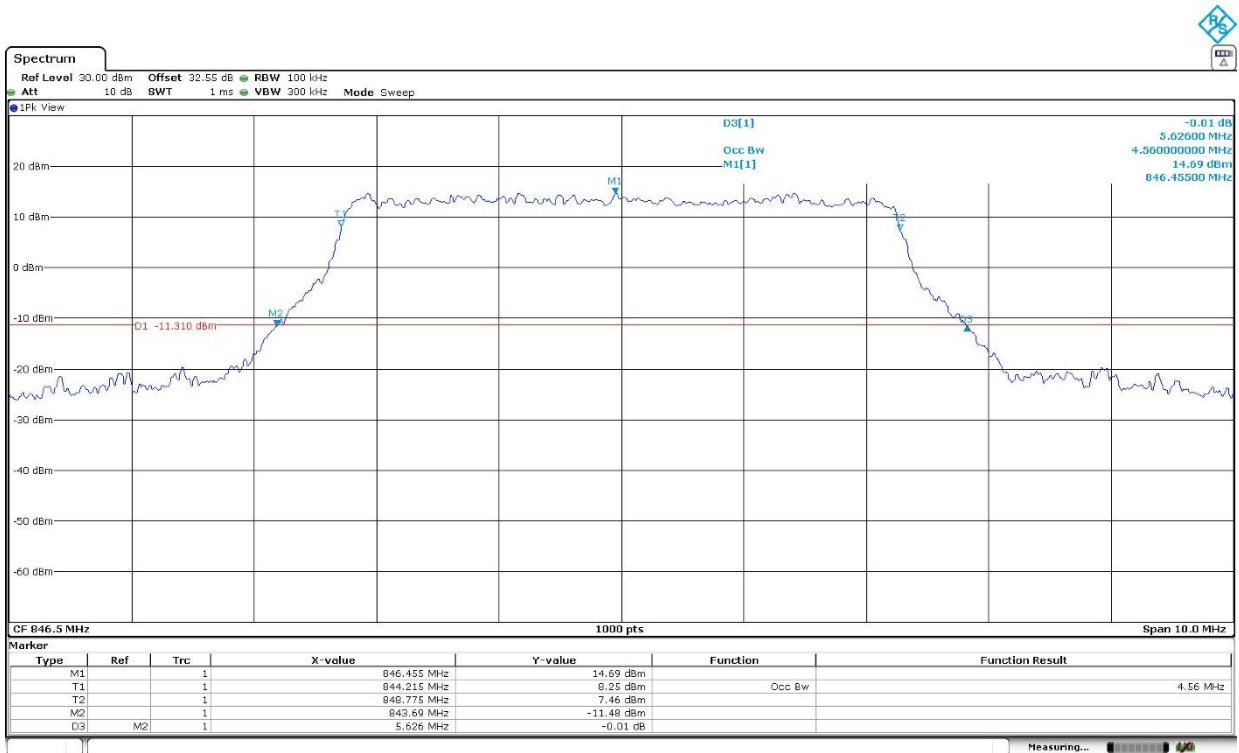

LTE Cat 1bis Band 5. BW=10 MHz. QPSK. RB Size=All. RB Offset=0.

Channel	Low	Middle	High
99% Occupied Bandwidth (kHz)	9240.00	9340.00	9260.00
-26 dBc Bandwidth (kHz)	12102.00	12137.00	11996.00
Measurement uncertainty (kHz)	<±3.75		

LTE Cat 1bis Band 5. BW=10 MHz. 16QAM. RB Size=All. RB Offset=0.

Channel	Low	Middle	High
99% Occupied Bandwidth (kHz)	5220.00	5060.00	5320.00
-26 dBc Bandwidth (kHz)	9011.00	8009.00	8420.00
Measurement uncertainty (kHz)	<±3.75		

LTE Cat 1bis Band 5. BW=10 MHz. QPSK. RB Size=All.

Low Channel:

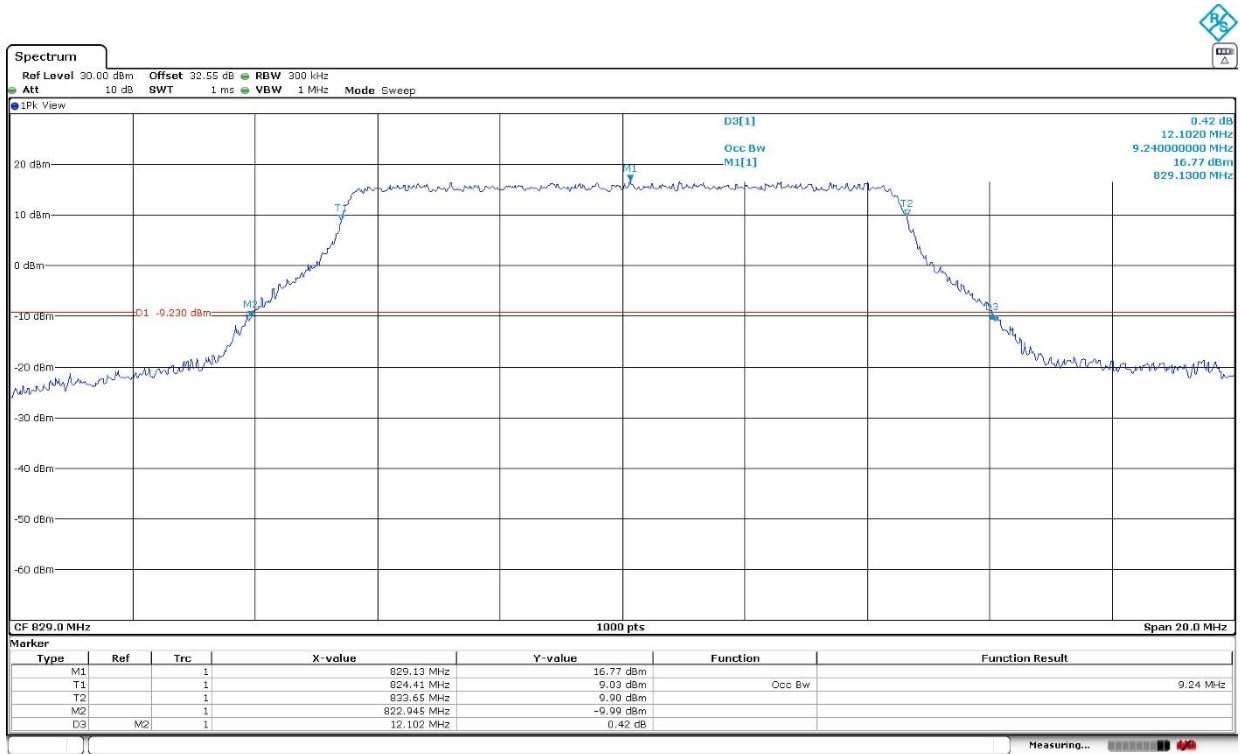

Middle Channel:

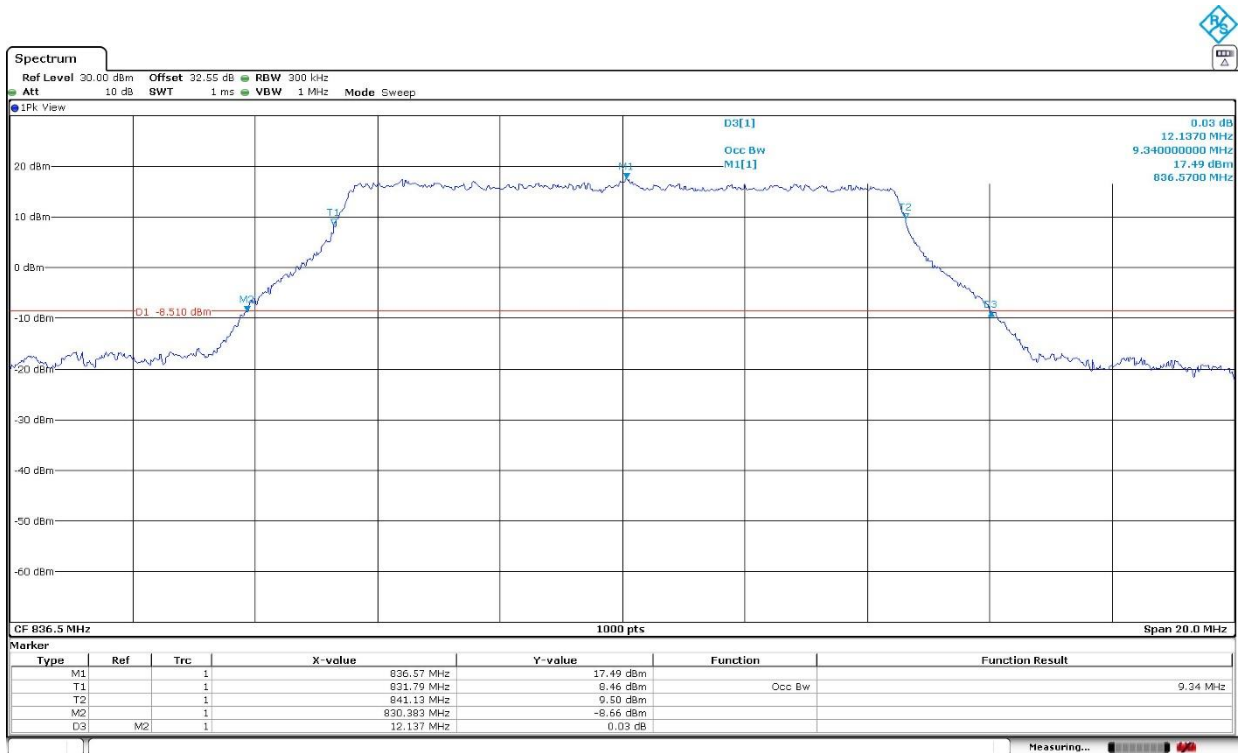

High Channel:

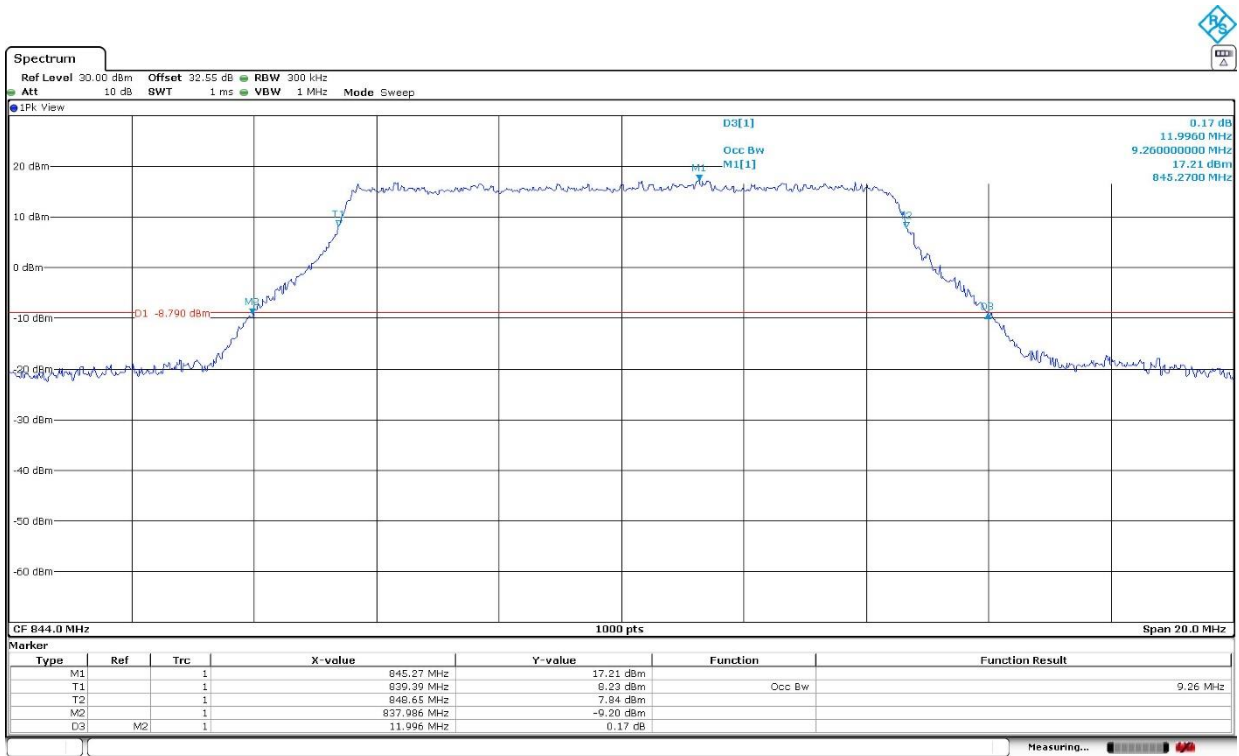

LTE Cat 1bis Band 5. BW=10 MHz. 16QAM. RB Size=All.

Low Channel:

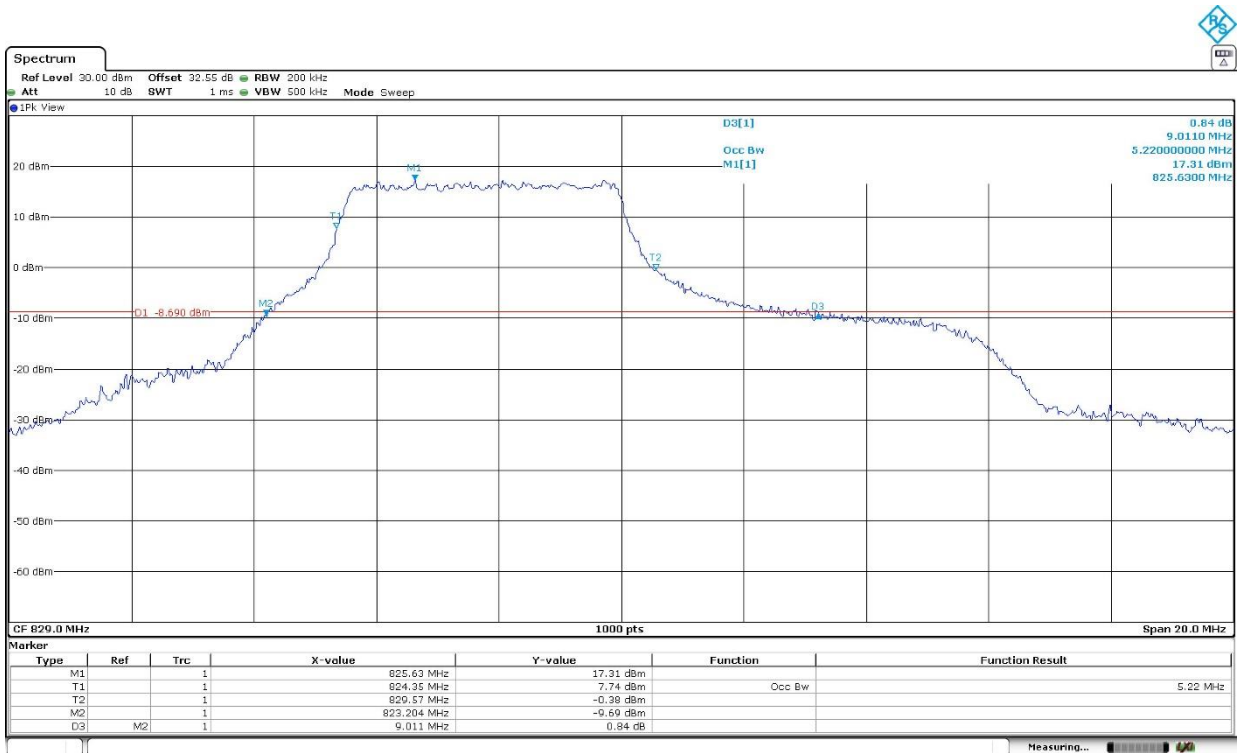

Middle Channel:

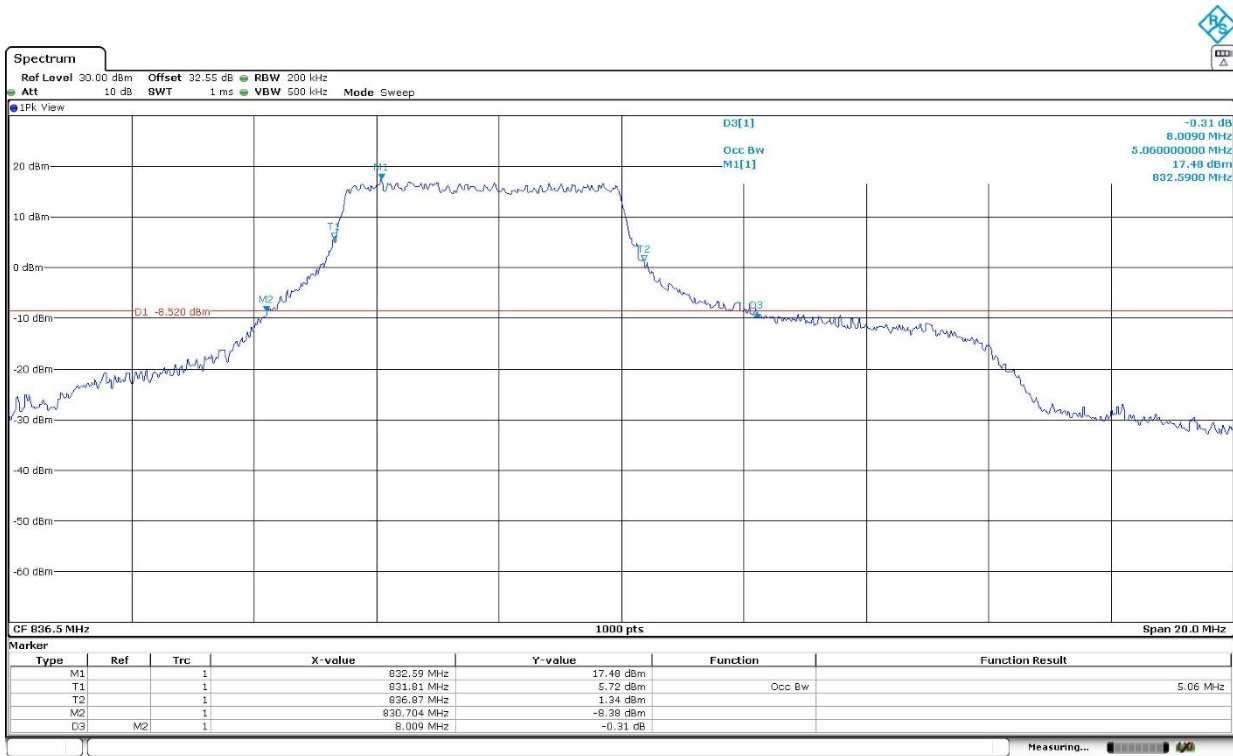

High Channel:

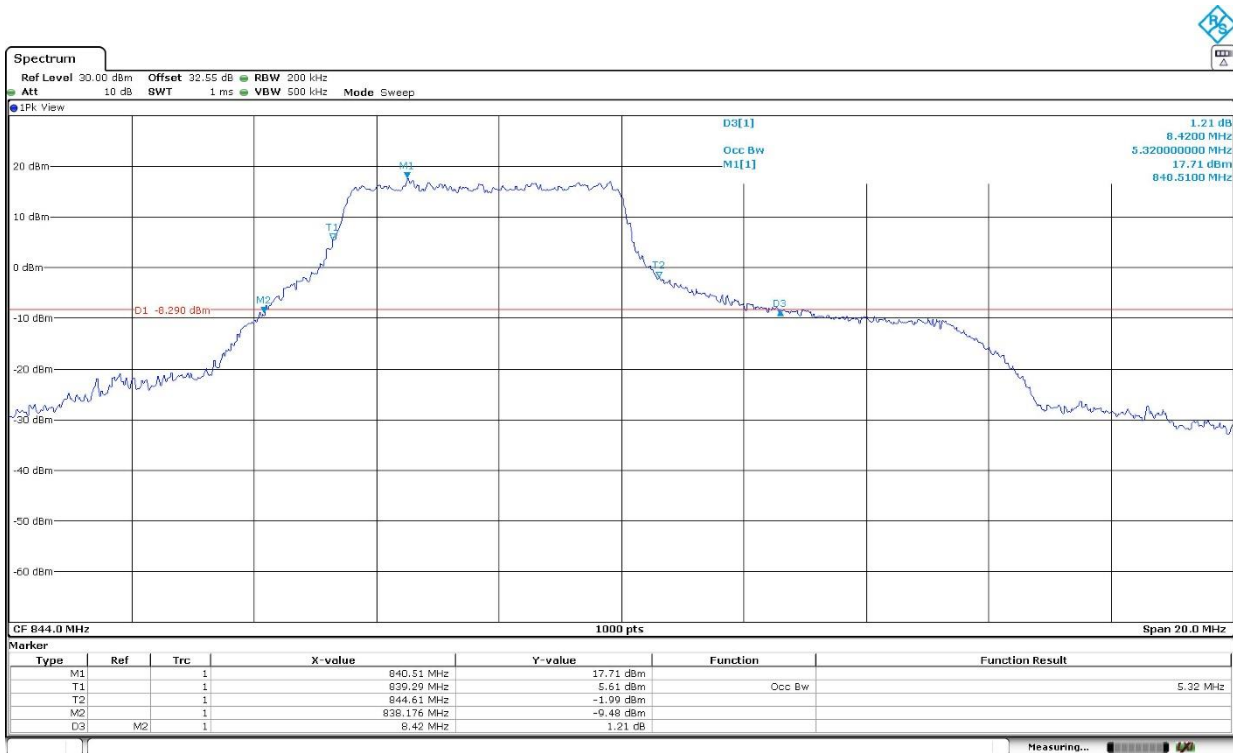

Spurious emissions at antenna terminals

Limits

* FCC § 2.1051 and § 22.917:

The power of any emission outside of the authorized operating frequency ranges must be attenuated below the transmitting power (P) by a factor of at least $43 + 10 \log(P)$ dB.

Compliance with these rules is based on the use of measurement instrumentation employing a reference bandwidth as follows:

In the spectrum below 1 GHz, instrumentation should employ a reference bandwidth of 100 kHz or greater. In the 1 MHz bands immediately outside and adjacent to the frequency block, a resolution bandwidth of at least one percent of the emission bandwidth of the fundamental emission of the transmitter may be employed.

- * RSS-132. 5.5: Mobile and base station equipment shall comply with the limits in (i) and (ii) below.
- i. In the first 1.0 MHz band immediately outside and adjacent to each of the sub-bands specified in Section 5.1, the power of emissions per any 1% of the occupied bandwidth shall be attenuated (in dB) below the transmitter output power P (dBW) by at least $43 + 10 \log_{10} P$ (watts).
 - ii. After the first 1.0 MHz immediately outside and adjacent to each of the sub-bands, the power of emissions in any 100 kHz bandwidth shall be attenuated (in dB) below the transmitter output power P (dBW) by at least $43 + 10 \log_{10} P$ (watts). If the measurement is performed using 1% of the occupied bandwidth, power integration over 100 kHz is required.

Method

The EUT RF output connector was connected to a spectrum analyser and to the Universal Radio Communication tester R&S CMW500 (selecting maximum transmission power of the EUT and different modes of modulation) using a 50-Ohm attenuator and a power divider.

The reading of the spectrum analyser is corrected with the attenuation loss of connection between output terminal of EUT and input of the spectrum analyser.

The configuration of Resource Blocks and modulation which is the worst case for conducted power was used.

Test Setup

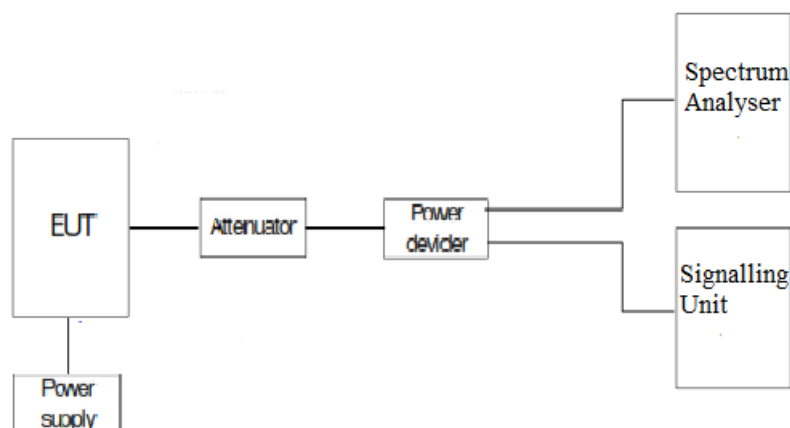

Results

LTE Cat 1bis Band 5:

A preliminary scan determined the worst-case:

BW=10 MHz. QPSK. RB Size=1. RB Offset=0.

The next results are for this worst-case configuration.

Frequency range 9 KHz - 10 GHz:

- Low Channel: No spurious frequencies at less than 20 dB below the limit.
- Middle Channel: No spurious frequencies at less than 20 dB below the limit.
- High Channel: No spurious frequencies at less than 20 dB below the limit.

Measurement uncertainty (dB): $<\pm 2.76$

Verdict: PASS

LTE Cat 1bis Band 5: BW=10 MHz. QPSK. RB Size=1. RB Offset=0.

Subrange	Step Size	Detectors	Bandwidth	Sweep Time	Preamp
Receiver: [FSV 40]					
9 kHz - 150 kHz	14.1 Hz	PK+	300 Hz	Coupled	0 dB
150 kHz - 30 MHz	932.812 Hz	PK+	10 kHz	Coupled	0 dB
30 MHz - 1 GHz	30.312 kHz	PK+	100 kHz	Coupled	0 dB
1 GHz - 10 GHz	281.25 kHz	PK+	1 MHz	Coupled	0 dB

Low Channel:

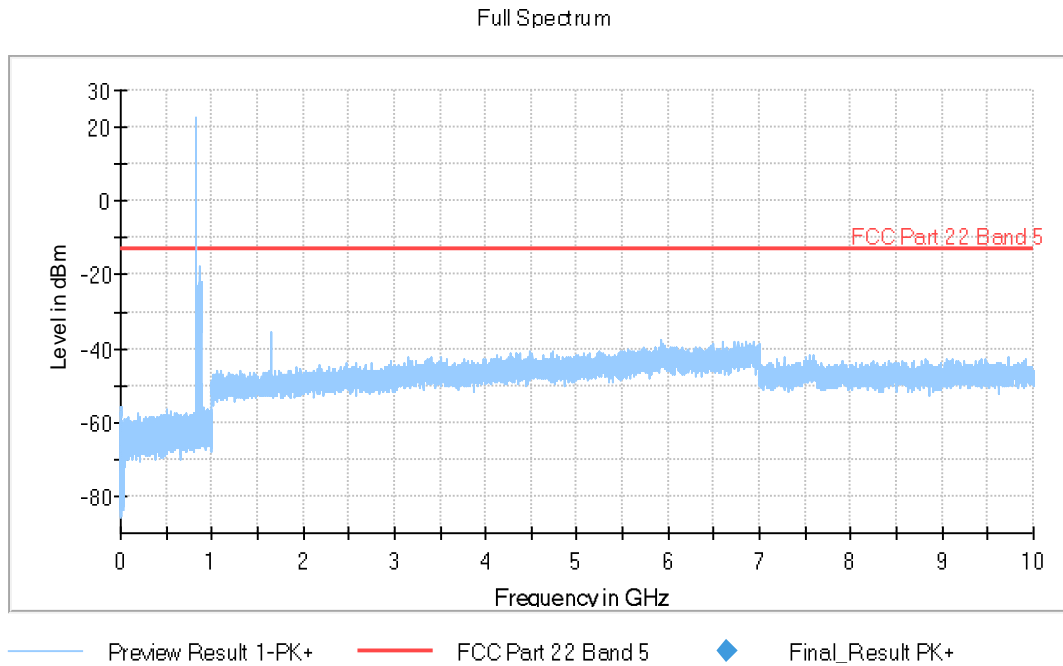

The peak above the limit is the carrier frequency. Downlink is also shown in the graphic.

Middle Channel:

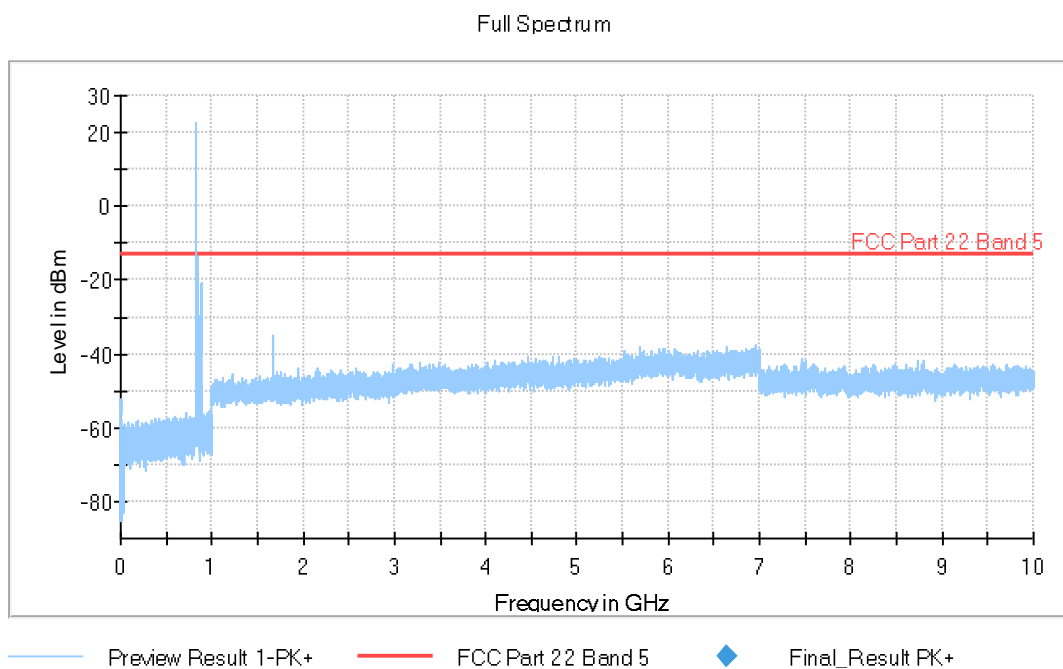

The peak above the limit is the carrier frequency. Downlink is also shown in the graphic.

High Channel:

Full Spectrum

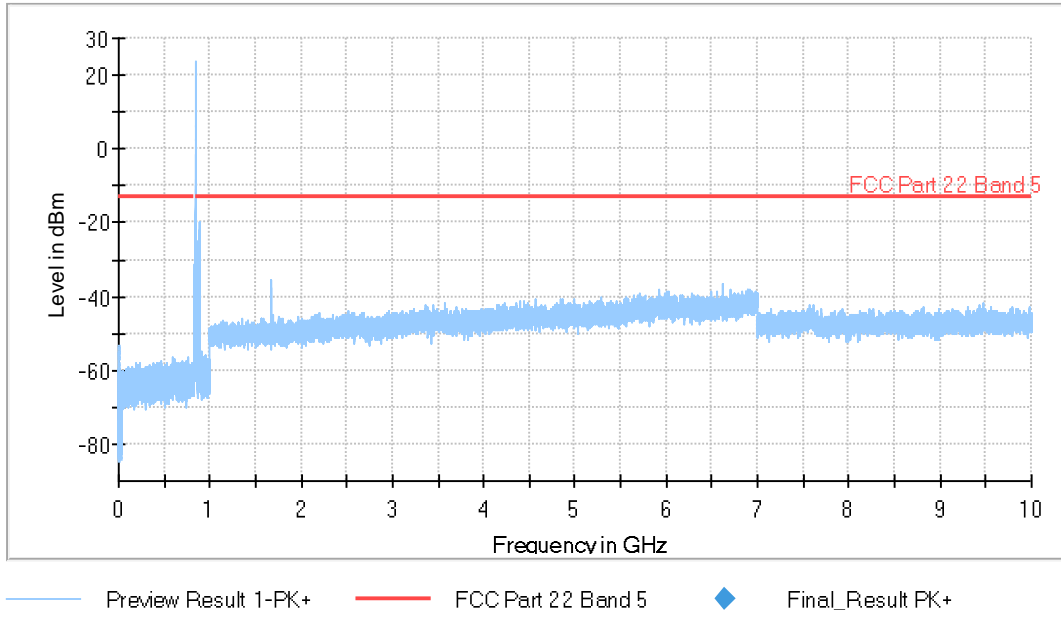

The peak above the limit is the carrier frequency. Downlink is also shown in the graphic.

Spurious emissions at antenna terminals at Block Edges

Limits

* FCC § 2.1051 and § 22.917:

The power of any emission outside of the authorized operating frequency ranges must be attenuated below the transmitting power (P) by a factor of at least $43 + 10 \log(P)$ dB.

Compliance with these rules is based on the use of measurement instrumentation employing a reference bandwidth as follows:

In the spectrum below 1 GHz, instrumentation should employ a reference bandwidth of 100 kHz or greater. In the 1 MHz bands immediately outside and adjacent to the frequency block, a resolution bandwidth of at least one percent of the emission bandwidth of the fundamental emission of the transmitter may be employed.

- * RSS-132. 5.5: Mobile and base station equipment shall comply with the limits in (i) and (ii) below.
- i. In the first 1.0 MHz band immediately outside and adjacent to each of the sub-bands specified in Section 5.1, the power of emissions per any 1% of the occupied bandwidth shall be attenuated (in dB) below the transmitter output power P (dBW) by at least $43 + 10 \log_{10} P$ (watts).
 - ii. After the first 1.0 MHz immediately outside and adjacent to each of the sub-bands, the power of emissions in any 100 kHz bandwidth shall be attenuated (in dB) below the transmitter output power P (dBW) by at least $43 + 10 \log_{10} P$ (watts). If the measurement is performed using 1% of the occupied bandwidth, power integration over 100 kHz is required.

Method

The EUT RF output connector was connected to a spectrum analyzer and to the Universal Radio Communication tester R&S CMW500 (selecting maximum transmission power of the EUT and different modes of modulation) using a 50-Ohm attenuator and a power splitter.

The reading of the spectrum analyser is corrected with the path loss of the connection between the output terminal of the EUT and the input of the spectrum analyzer.

The configuration of modulation which is the worst case for conducted power was used.

As stated in FCC part 22.917 / RSS-132 Clause 5.5, in the 1 MHz bands immediately outside and adjacent to the frequency block or band a resolution bandwidth of at least one percent of the emission bandwidth of the fundamental emission of the transmitter may be employed.

Measurement Limit:

At P_o transmitting power, the specified minimum attenuation $43 + 10 \log_{10} p$ (watts) becomes:

$$P_o \text{ (dBm)} - [43 + 10 \log (P_o \text{ in mwatts}) - 30] = -13 \text{ dBm}$$

Test Setup

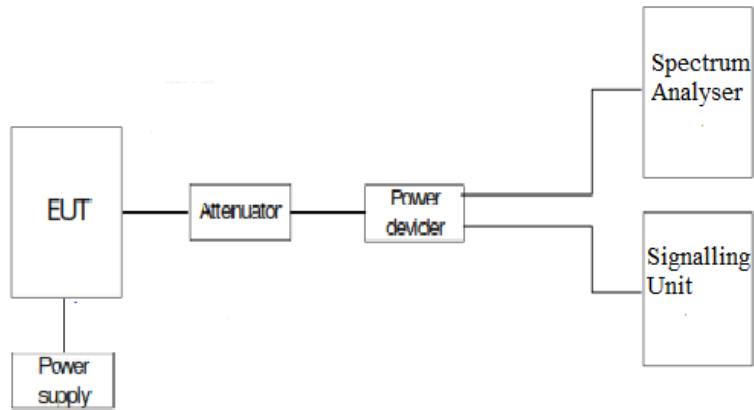

Results

LTE Cat 1bis Band 5:

Preliminary measurements determined QPSK, BW=5 MHz as the worst case.

LTE Cat 1bis Band 5. QPSK.	RB=1. Offset =0. BW=5 MHz	RB=1. Offset =0. BW=10 MHz
Maximum measured level at <u>Low Block Edge</u> at antenna port (dBm)	-20.37	-24.74

LTE Cat 1bis Band 5. QPSK.	RB= All. Offset=0. BW=5 MHz	RB= All. Offset=0. BW=10 MHz
Maximum measured level at <u>Low Block Edge</u> at antenna port (dBm)	-19.64	-23.48

LTE Cat 1bis Band 5. QPSK.	RB=1. Offset =Max. BW=5 MHz	RB=1. Offset =Max. BW=10 MHz
Maximum measured level at <u>High Block Edge</u> at antenna port (dBm)	-19.84	-25.12

LTE Cat 1bis Band 5. QPSK.	RB= All. Offset=0. BW=5 MHz	RB= All. Offset=0. BW=10 MHz
Maximum measured level at <u>High Block Edge</u> at antenna port (dBm)	-20.6	-22.15

Measurement uncertainty (dB): ± 2.76

Verdict

Pass

The plots below are for the worst case configuration specified before.

LTE Cat 1bis Band 5. BW=5 MHz. QPSK. RB Size= 1. RB Offset = 0. Low Block Edge:

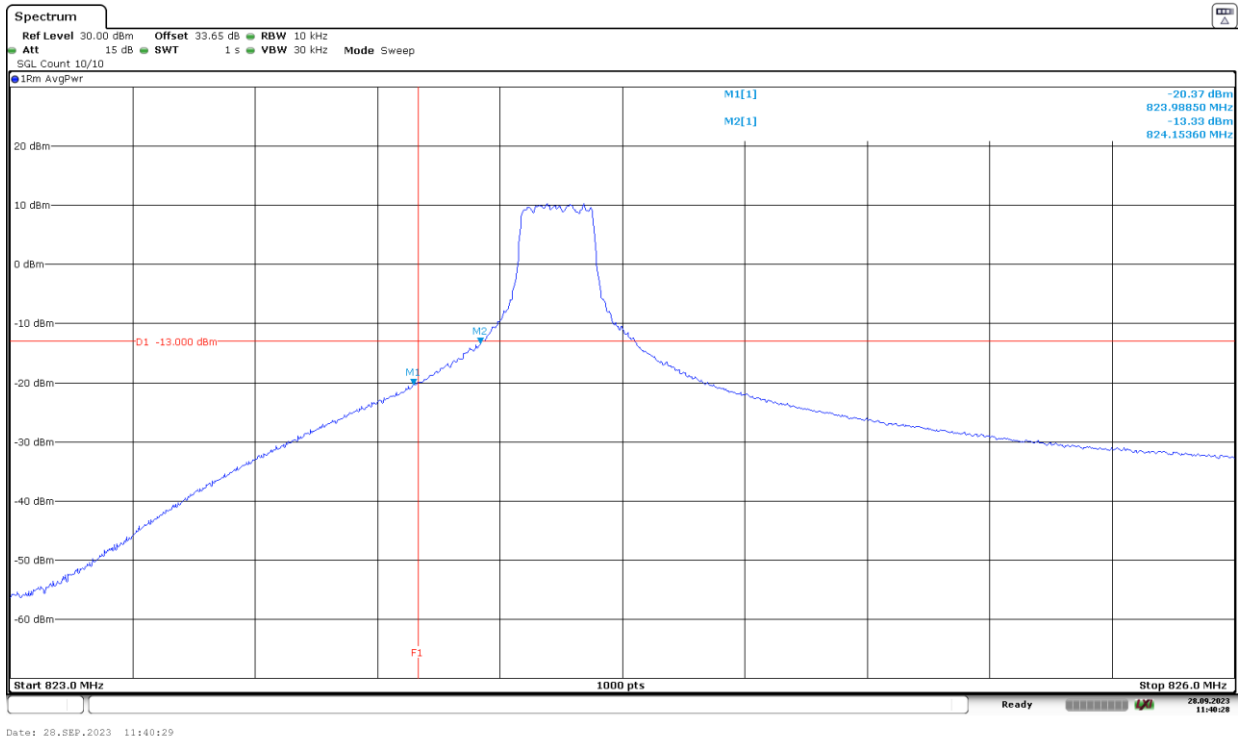

The equipment transmits at the maximum output power.

LTE Cat 1bis Band 5. BW=5 MHz. QPSK. RB Size=1. RB Offset=Max. High Block Edge:

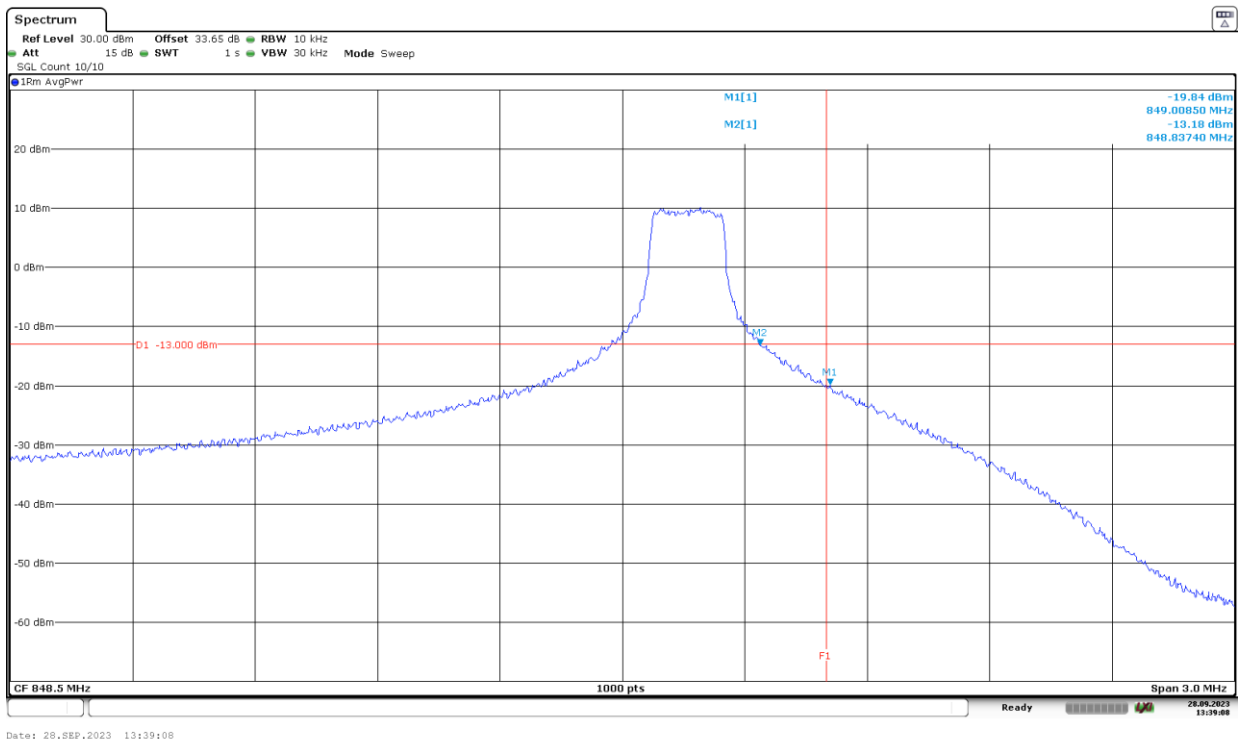

The equipment transmits at the maximum output power.

LTE Cat 1bis Band 5. BW=5 MHz. QPSK. RB Size=All. RB Offset=0. Low Block Edge:

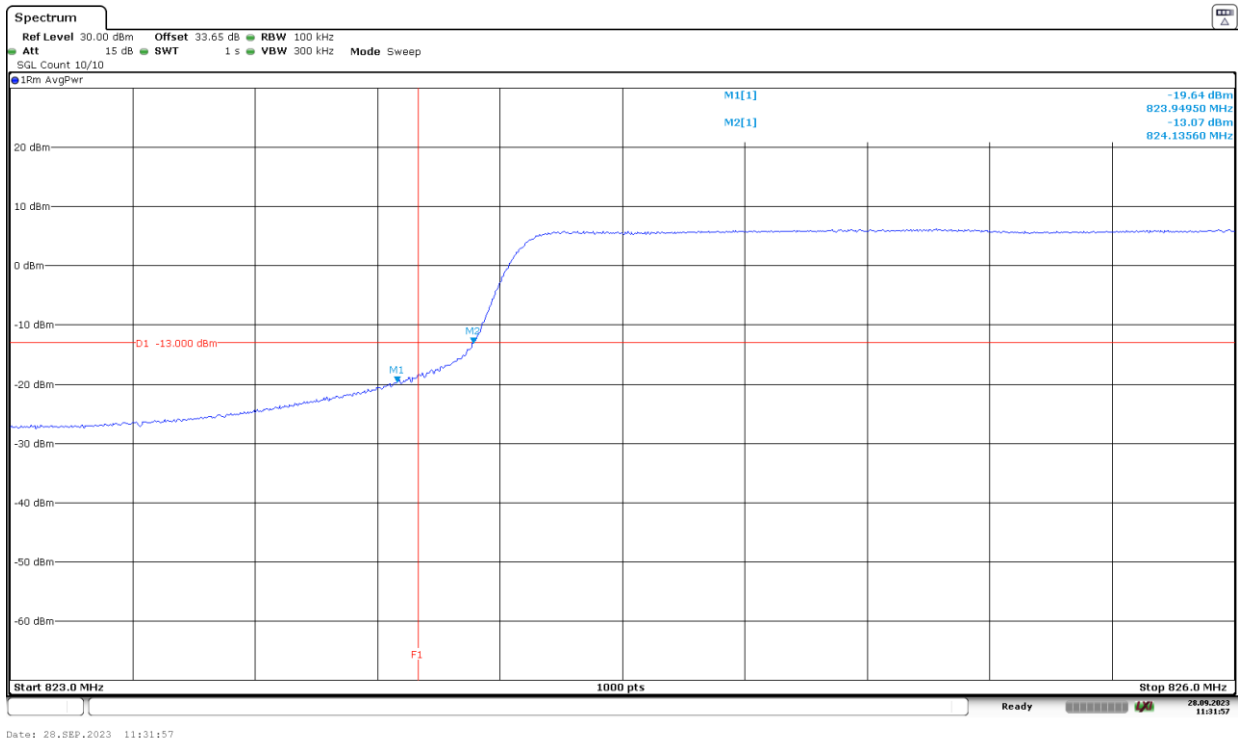

The equipment transmits at the maximum output power.

LTE Cat 1bis Band 5. BW=5 MHz. QPSK. RB Size=All. RB Offset=0. High Block Edge:

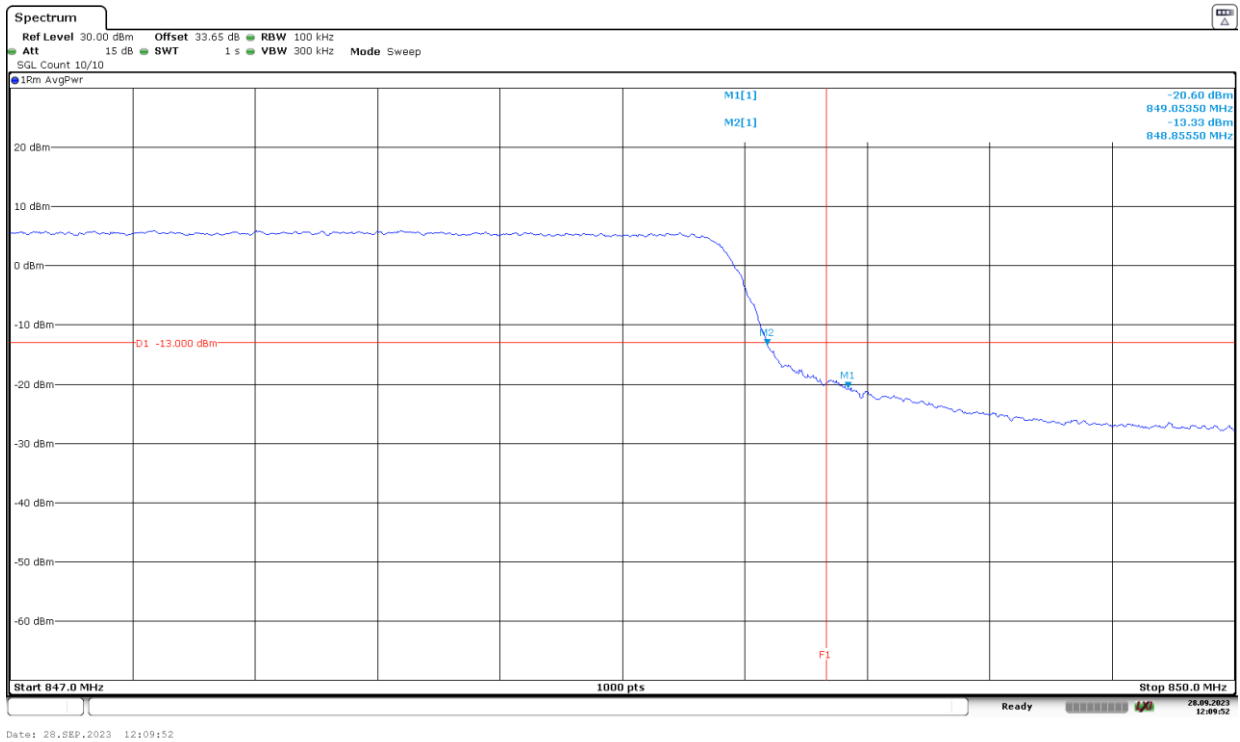

The equipment transmits at the maximum output power.

Verdict: PASS

Radiated emissions

Limits

* FCC § 2.1051 and § 22.917:

The power of any emission outside of the authorized operating frequency ranges must be attenuated below the transmitting power (P) by a factor of at least $43 + 10 \log(P)$ dB.

Compliance with these rules is based on the use of measurement instrumentation employing a reference bandwidth as follows:

In the spectrum below 1 GHz, instrumentation should employ a reference bandwidth of 100 kHz or greater. In the 1 MHz bands immediately outside and adjacent to the frequency block, a resolution bandwidth of at least one percent of the emission bandwidth of the fundamental emission of the transmitter may be employed.

- * RSS-132. 5.5: Mobile and base station equipment shall comply with the limits in (i) and (ii) below.
- iii. In the first 1.0 MHz band immediately outside and adjacent to each of the sub-bands specified in Section 5.1, the power of emissions per any 1% of the occupied bandwidth shall be attenuated (in dB) below the transmitter output power P (dBW) by at least $43 + 10 \log_{10} P$ (watts).
 - iv. After the first 1.0 MHz immediately outside and adjacent to each of the sub-bands, the power of emissions in any 100 kHz bandwidth shall be attenuated (in dB) below the transmitter output power P (dBW) by at least $43 + 10 \log_{10} P$ (watts). If the measurement is performed using 1% of the occupied bandwidth, power integration over 100 kHz is required.

Method

The measurement was performed with the EUT inside an anechoic chamber. The spectrum was scanned from 30 MHz to at least the 10th harmonic of the high frequency generated within the equipment.

The EUT was placed on a 80 centimetres high non-conductive stand at a 3 meter distance from the measuring antenna.

Detected emissions were maximized at each frequency by rotating the EUT and adjusting the height and polarization of the measuring antenna. The maximum meter reading was recorded.

Measurement Limit:

According to specification, the power of emissions shall be attenuated below the transmitter power (P) by a factor of at least $43 + 10 \log (P)$ dB, P in watts.

At P_o transmitting power, the specified minimum attenuation becomes $43+10\log (P_o)$, and the level in dBm relative P_o becomes:

$$P_o \text{ (dBm)} - [43 + 10 \log (P_o \text{ in mwatts}) - 30] = - 13 \text{ dBm}$$

The maximum field strength (dB μ V/m) of each detected emission at less than 20 dB respect to the limit is converted to an equivalent EIRP level (dBm) according to ANSI C63.26 with the formula:

$EIRP \text{ (dBm)} = E \text{ (dB}\mu\text{V/m)} + 20 \log(D) - 104.8$; where D is the measurement distance (in the far field region) in m. D = 3 m

Test Setup

Radiated measurements below 1 GHz:

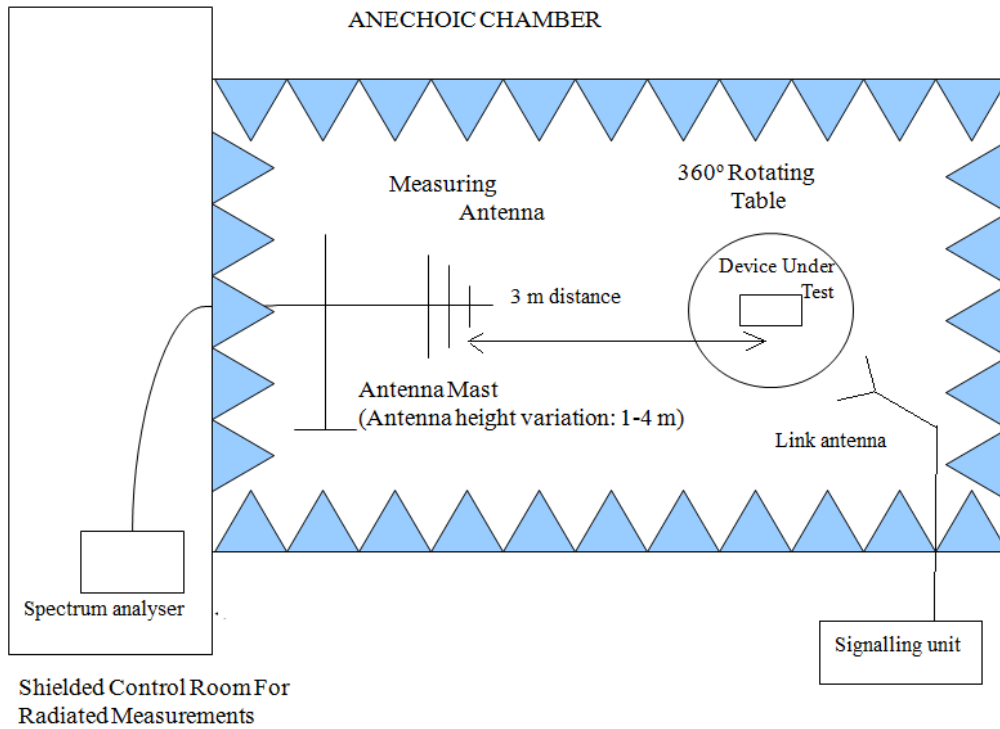

Radiated measurements above 1 GHz:

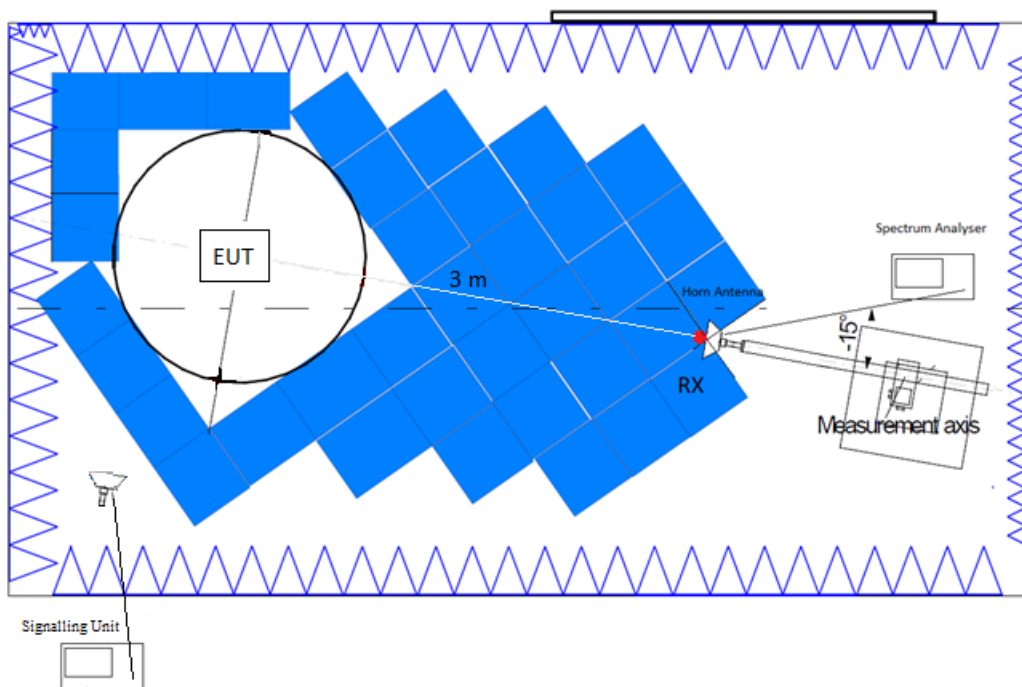

Results

LTE Cat 1bis Band 5:

A preliminary scan determined the BW=10 MHz, QPSK, RB Size=1, RB Offset=0 as the worst case. The following results are for this worst-case configuration.

- LOW CHANNEL:

Frequency range 30 MHz - 1 GHz:

No spurious frequencies at less than 20 dB below the limit.

Frequency range 1 - 10 GHz:

No spurious frequencies at less than 20 dB below the limit.

- MIDDLE CHANNEL:

Frequency range 30 MHz - 1 GHz:

No spurious frequencies at less than 20 dB below the limit.

Frequency range 1 - 10 GHz:

No spurious frequencies at less than 20 dB below the limit.

- HIGH CHANNEL:

Frequency range 30 MHz - 1 GHz:

No spurious frequencies at less than 20 dB below the limit.

Frequency range 1 - 10 GHz:

No spurious frequencies at less than 20 dB below the limit.

Measurement uncertainty (dB): $<\pm 5.03$ for $f \geq 30$ MHz up to 1 GHz
 $<\pm 4.32$ for $f \geq 1$ GHz up to 10 GHz

Verdict: PASS

FREQUENCY RANGE 30 MHz - 1 GHz:

- LOW CHANNEL:

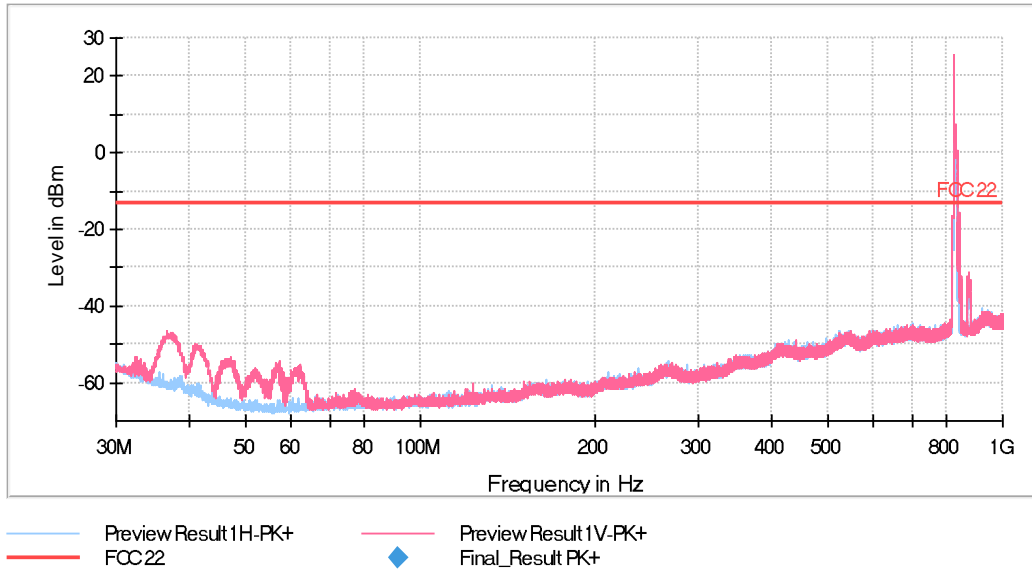

The peak above the limit is the carrier frequency.

- MIDDLE CHANNEL:

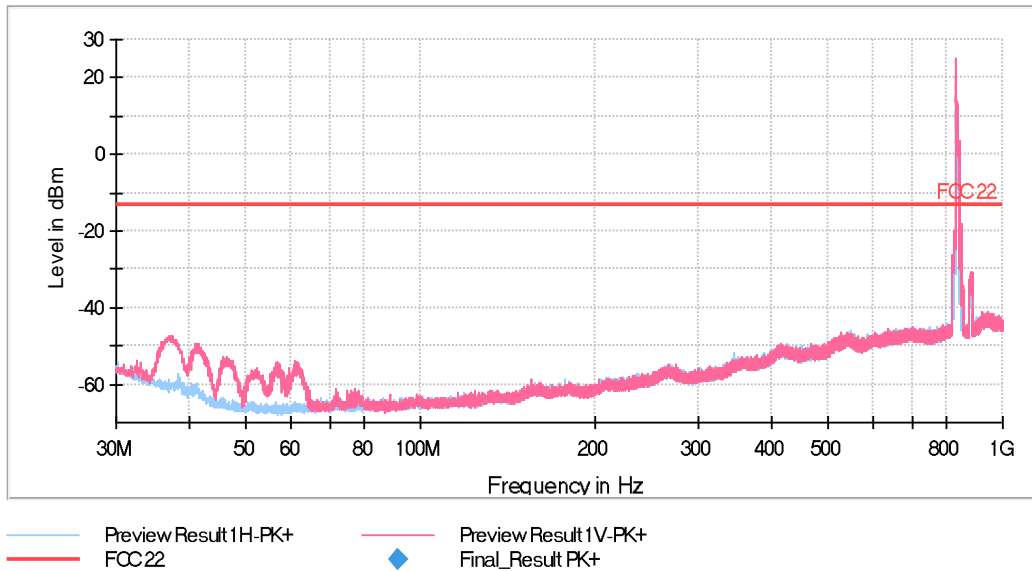

The peak above the limit is the carrier frequency.

- HIGH CHANNEL:

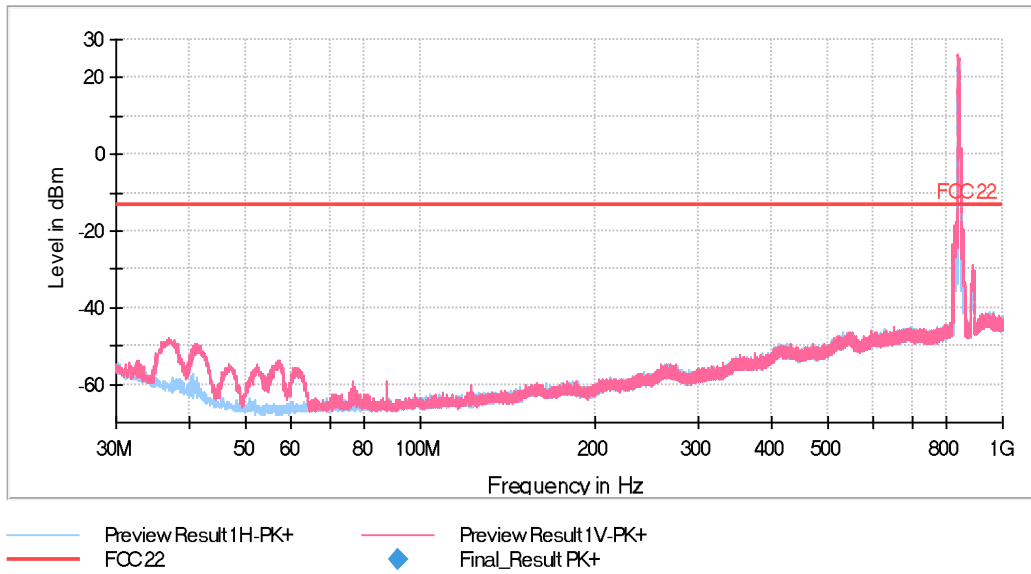

The peak above the limit is the carrier frequency.

FREQUENCY RANGE 1 - 10 GHz:

- LOW CHANNEL:

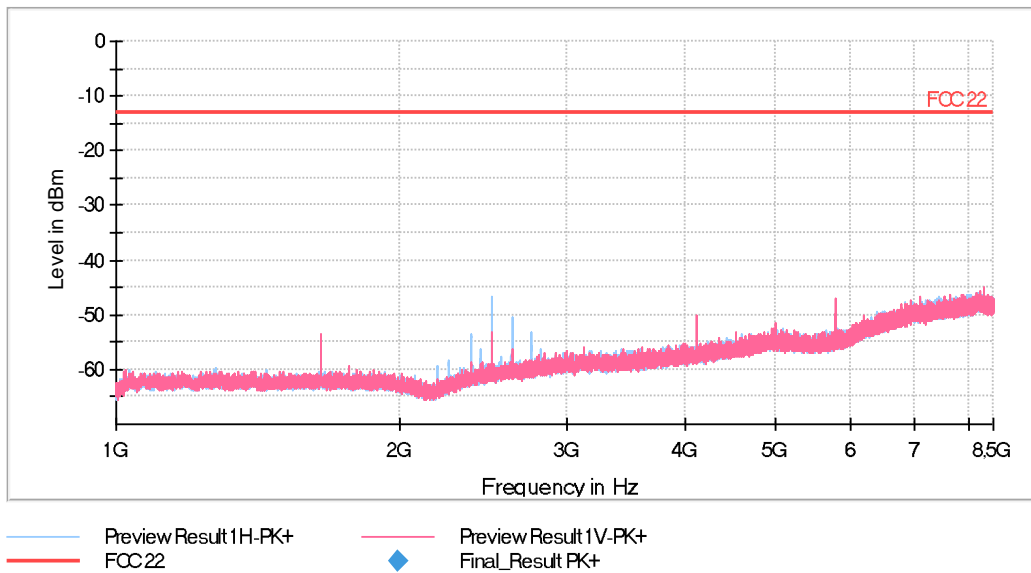

- MIDDLE CHANNEL:

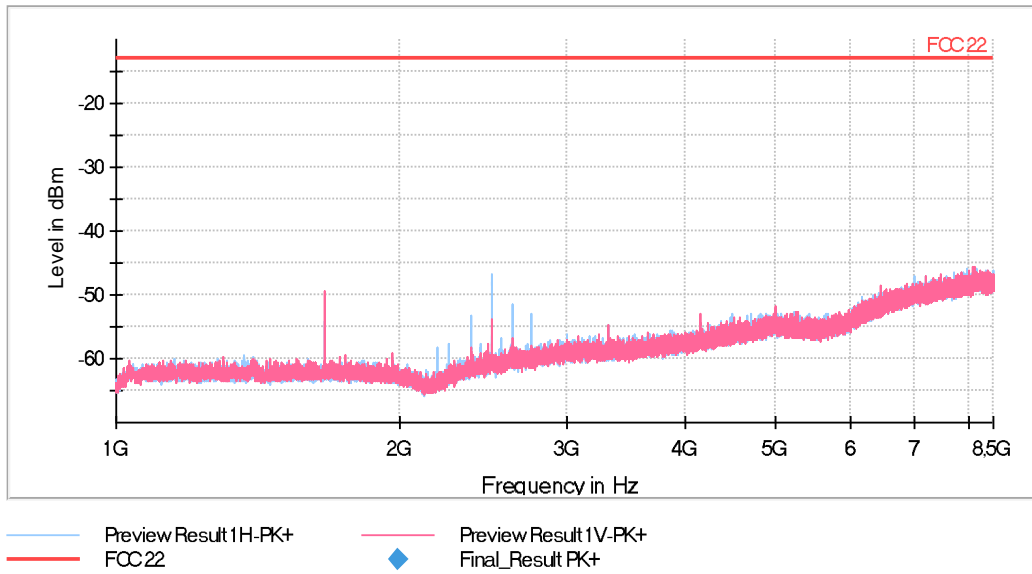

- HIGH CHANNEL:

