

ISED CABid: ES1909

Test Report No:
 NIE: 71232RRF.003

Test Report

USA FCC Part 27

CANADA IC RSS-130, RSS-139

(*) Identification of item tested	LTE Cat-M Cellular communication module in SiP packaging
(*) Trademark	Sequans Communications
(*) Model and /or type reference	SKY66431
Other identification of the product	FCC ID: 2AAGM66431 IC: 12732A-66431
(*) Features	LTE-M, 3GPP LTE Release 14 HW Version: V1 SW Version: LR8.0.6.1-56267
Applicant	SEQUANS COMMUNICATIONS 55 Boulevard Charles de Gaulle, 92700 Colombes France
Test method requested, standard	USA FCC Part 27 (10-1-21 Edition). CANADA RSS-130 Issue 2, Feb. 2019. CANADA RSS-139 Issue 3, Jul. 2015. ANSI C63.26: 2015. KDB 971168 D01 Power Meas License Digital Systems v03r01, April 2018.
Summary	IN COMPLIANCE
Approved by (name / position & signature)	Rafael López Martín EMC Consumer & RF Lab. Manager
Date of issue	2022-10-25
Report template No	FDT08_24 (* "Data provided by the client")

Index

Competences and guarantees	3
General conditions	3
Uncertainty	3
Data provided by the client.....	3
Usage of samples	4
Test sample description	4
Identification of the client.....	6
Testing period and place.....	6
Document history	6
Environmental conditions	7
Remarks and comments	8
Testing verdicts.....	9
Summary	9
Appendix A: Test results for FCC Part 27 / RSS-130, RSS-139.....	10

Competences and guarantees

DEKRA Testing and Certification is a testing laboratory accredited by the National Accreditation Body (ENAC - Entidad Nacional de Acreditación) to perform the tests indicated in the Certificate No. 51/LE 147.

DEKRA Testing and Certification is an FCC-recognized accredited testing laboratory with appropriate scope of accreditation that covers the performed tests in this report.

DEKRA Testing and Certification is an ISED-recognized accredited testing laboratory, CABid: ES1909, with the appropriate scope of accreditation that covers the performed tests in this report.

In order to assure the traceability to other national and international laboratories, DEKRA Testing and Certification has a calibration and maintenance program for its measurement equipment.

DEKRA Testing and Certification guarantees the reliability of the data presented in this report, which is the result of the measurements and the tests performed to the item under test on the date and under the conditions stated on the report and it is based on the knowledge and technical facilities available at DEKRA Testing and Certification at the time of performance of the test.

DEKRA Testing and Certification is liable to the client for the maintenance of the confidentiality of all information related to the item under test and the results of the test.

The results presented in this Test Report apply only to the particular item under test established in this document.

IMPORTANT: No parts of this report may be reproduced or quoted out of context, in any form or by any means, except in full, without the previous written permission of DEKRA Testing and Certification.

General conditions

1. This report is only referred to the item that has undergone the test.
2. This report does not constitute or imply on its own an approval of the product by the Certification Bodies or competent Authorities.
3. This document is only valid if complete; no partial reproduction can be made without previous written permission of DEKRA Testing and Certification.
4. This test report cannot be used partially or in full for publicity and/or promotional purposes without previous written permission of DEKRA Testing and Certification and the Accreditation Bodies.

Uncertainty

Uncertainty (factor $k=2$) was calculated according to the DEKRA Testing and Certification S.A.U. internal document PODT000.

Data provided by the client

The following data has been provided by the client:

1. Information relating to the description of the sample ("Identification of the item tested", "Trademark", "Model and/or type reference tested").
2. The sample model SKY66431 is a Most compact LTE modem and RF front-end in a single package:
 - Same chipset as GM02S module i.e. SQN3430.
 - Integrated baseband, transceiver, RF front end, RAM memory, crystals and power management.
 - 8.8 x 11.3 x 1.585 (max.) mm BGA package, 0.5 and 1 mm pitch.
 - Compliant to 3GPP Rel-14, upgradeable to 3GPP Rel-15 & 16.
 - Optimized for half-duplex operation (HD-FDD) for LTE-M.

DEKRA Testing and Certification S.A.U. declines any responsibility with respect to the information provided by the client and that may affect the validity of results.

Usage of samples

Samples undergoing test have been selected by: The client.

- Sample S/01 is composed of the following elements:

Control No.	Description	Model	Serial No.	Date of reception
71232B/004	LTE Cat-M Cellular communication module in SiP packaging	SKY66431	171	2022/07/14

Auxiliary elements used with the Sample S/01:

Control No.	Description	Model	Serial No.	Date of reception
71605/014	SMA Cable	--	--	2022/04/04
71605/019	USB Cable	--	--	2022/04/04

Sample S/01 has undergone the following test(s): The Conducted tests indicated in Appendix A.

- Sample S/02 is composed of the following elements:

Control No.	Description	Model	Serial No.	Date of reception
71232B/004	LTE Cat-M Cellular communication module in SiP packaging	SKY66431	171	2022/07/14

Auxiliary elements used with the Sample S/02:

Control No.	Description	Model	Serial No.	Date of reception
71605/019	USB Cable	--	--	2022/04/04

Sample S/02 has undergone the following test(s): The Radiated tests indicated in Appendix A.

Test sample description

Ports.....:	Port name and description	Cable					
		Specified max length [m]	Attached during test	Shielded	Coupled to patient ⁽³⁾		
	USB	2	<input checked="" type="checkbox"/>	<input type="checkbox"/>	<input type="checkbox"/>		
	-		<input type="checkbox"/>	<input type="checkbox"/>	<input type="checkbox"/>		
	-		<input type="checkbox"/>	<input type="checkbox"/>	<input type="checkbox"/>		
Supplementary information to the ports.....:	-						
Rated power supply	Voltage and Frequency		Reference poles				
			L1	L2	L3	N	PE
	<input type="checkbox"/>	AC:	<input type="checkbox"/>	<input type="checkbox"/>	<input type="checkbox"/>	<input type="checkbox"/>	<input type="checkbox"/>
	<input checked="" type="checkbox"/>	DC: 3.3V USB port					
Rated Power.....:	-						
Clock frequencies.....:	-						
Other parameters	-						
Software version.....:	LR8.0.6.1-56267						
Hardware version	V1						
Dimensions in cm (W x H x D) ...:	-						
Mounting position	<input checked="" type="checkbox"/>	Table top equipment					
	<input type="checkbox"/>	Wall/Ceiling mounted equipment					
	<input type="checkbox"/>	Floor standing equipment					
	<input type="checkbox"/>	Hand-held equipment					
	<input type="checkbox"/>	Other:					
Modules/parts.....:	Module/parts of test item		Type	Manufacturer			
	NEKTAR-EVK						
	USB Cable						
	External antenna						
	-						
Accessories (not part of the test item)	Description		Type	Manufacturer			
	-						
	-						
Documents as provided by the applicant.....:	Description		File name	Issue date			
	-						
	-						

(3) Only for Medical Equipment

Identification of the client

SEQUANS COMMUNICATIONS
55 Boulevard Charles de Gaulle, 92700 Colombes, France

Testing period and place

Test Location	DEKRA Testing and Certification S.A.U.
Date (start)	2022-07-25
Date (finish)	2022-09-15

Document history

Report number	Date	Description
71232RRF.003	2022-10-25	First release.

Environmental conditions

In the control chamber, the following limits were not exceeded during the test:

Temperature	Min. = 15 °C Max. = 35 °C
Relative humidity	Min. = 20 % Max. = 75 %

In the semianechoic chamber, the following limits were not exceeded during the test:

Temperature	Min. = 15 °C Max. = 35 °C
Relative humidity	Min. = 20 % Max. = 75 %

In the chamber for conducted measurements, the following limits were not exceeded during the test:

Temperature	Min. = 15 °C Max. = 35 °C
Relative humidity	Min. = 20 % Max. = 75 %

Remarks and comments

The tests have been performed by the technical personnel: Miguel Manuel López, José Manuel Jiménez.

Used instrumentation:

Conducted Measurements

	Last Calibration	Due Calibration
1. Shielded Room ETS LINDGREN S101	N/A	N/A
2. Wideband Radio Communication Tester ROHDE AND SCHWARZ CMW500	2021/09	2023/09
3. Signal Analyzer 20 Hz to 8 GHz ROHDE AND SCHWARZ FSQ8	2020/10	2022/10
4. Spectrum analyser Rohde & Schwarz FSV40	2021/10	2023/10
5. Climatic chamber HERAEUS VMT 04/35	2022/07	2024/07
6. DC Power Supply Keysight Technologies U8002A	N/A	N/A
7. Digital multimeter FLUKE 179	2021/11	2022/11

Radiated Measurements

	Last Calibration	Due Calibration
1. Semianechoic Absorber Lined Chamber ETS LINDGREN FACT 3 200 STP	N/A	N/A
2. Shielded Room ETS LINDGREN S101	N/A	N/A
3. Biconical/Log Antenna 30 MHz - 6 GHz ETS LINDGREN 3142E	2020/04	2023/04
4. Horn Antenna 1-18 GHz SCHWARZBECK MESS-ELEKTRONIK BBHA 9120 D	2019/11	2022/11
5. RF Preamplifier, 40 dB ,1-18 GHz BONN ELEKTRONIK BLMA 0118-1M	2022/07	2023/07
6. Signal and Spectrum Analyzer 10 Hz - 40 GHz ROHDE AND SCHWARZ FSV40	2022/05	2024/05
7. EMI Test Receiver 7 GHz ROHDE AND SCHWARZ ESR7	2021/11	2023/11
8. Wideband Radio Communication Tester ROHDE AND SCHWARZ CMW500	N/A	N/A
9. EMC/RF Test SW ROHDE AND SCHWARZ EMC32	N/A	N/A

Testing verdicts

Not applicable:	N/A
Pass:	P
Fail:	F
Not measured:	N/M

Summary

FCC PART 27 / RSS-130, RSS-139		
Requirement – Test case	Verdict	Remark
FCC 27.50 / RSS-130 4.6, RSS-139 6.5: RF Output Power	P	
FCC 2.1047 / RSS-130 4.2, RSS-139 6.2: Modulation Characteristics	P	
FCC 27.54 / RSS-130 4.5, RSS-139 6.4: Frequency Stability	P	
FCC 2.1049 / RSS-130 4.5, RSS-139 6.4: Occupied Bandwidth	P	
FCC 27.53 / RSS-130 4.7, RSS-139 6.6: Spurious Emissions at Antenna Terminals	P	
FCC 27.53 / RSS-130 4.7, RSS-139 6.6: Radiated Emissions	P	
<u>Supplementary information and remarks:</u> None.		

Appendix A: Test results for FCC Part 27 / RSS-130, RSS-139

INDEX

TEST CONDITIONS	12
RF Output Power	15
Frequency Stability	32
Modulation Characteristics	36
Occupied Bandwidth	40
Spurious Emissions at Antenna Terminals.....	54
Spurious Emissions at Antenna Terminals at Block Edges	67
Radiated Emissions	88

TEST CONDITIONS

(*): Data provided by the applicant.

POWER SUPPLY (*):

Vnormal: 3.3 Vdc (*)

Vminimum: 2.805 Vdc

Vmaximum: 3.795 Vdc

Type of Power Supply: USB.

ANTENNA (*):

Device with external and internal antennas.

After a preliminary scan, the determined worst case for the Radiated tests is the internal antenna.

For the Conducted tests, the gain of the internal antenna is used.

Declared Gain for antennas:

Low bands	Gain (dBi)	Antenna type
LTE Bands 12, 13 and 17	+1.1	Internal
	+0.17	External

Middle bands	Gain (dBi)	Antenna type
LTE Bands 4 and 66	+2.4	Internal
	+2.1	External

TEST FREQUENCIES:

LTE Band 4. QPSK AND 16QAM MODULATIONS.

	Channel per Nominal Bandwidth (Frequency, MHz)					
	BW = 1.4 MHz (*)	BW = 3 MHz (*)	BW = 5 MHz	BW = 10 MHz	BW = 15 MHz	BW = 20 MHz
Low	19957 (1710.7)	19965 (1711.5)	19975 (1712.5)	20000 (1715.0)	20025 (1717.5)	20050 (1720.0)
Middle	20175 (1732.5)	20175 (1732.5)	20175 (1732.5)	20175 (1732.5)	20175 (1732.5)	20175 (1732.5)
High	20393 (1754.3)	20385 (1753.5)	20375 (1752.5)	20350 (1750.0)	20325 (1747.5)	20300 (1745.0)

(*) The EUT does not support the Nominal Bandwidths 1.4 MHz, 3 MHz.

NOTE: Band 4 is completely included in band 66, so the channels of band 66 were tested to give conformity to the assigned block 1710-1780 MHz. Only high block edge of band 4 was tested to give conformity to the assigned block 1710-1755 MHz.

LTE Band 12: QPSK AND 16QAM MODULATIONS.

	Channel per Nominal Bandwidth (Frequency, MHz)			
	BW = 1.4 MHz (*)	BW = 3 MHz (*)	BW = 5 MHz	BW = 10 MHz
Low	23017 (699.7)	23025 (700.5)	23035 (701.5)	23060 (704.0)
Middle	23095 (707.5)	23095 (707.5)	23095 (707.5)	23095 (707.5)
High	23173 (715.3)	23165 (714.5)	23155 (713.5)	23130 (711.0)

(*) The EUT does not support the Nominal Bandwidths 1.4 MHz, 3 MHz.

LTE Band 13: QPSK AND 16QAM MODULATIONS.

	Channel per Nominal Bandwidth (Frequency, MHz)	
	BW = 5 MHz	BW = 10 MHz
Low	23205 (779.5)	N/A
Middle	23230 (782)	23230 (782)
High	23255 (784.5)	N/A

LTE Band 17: QPSK AND 16QAM MODULATIONS.

	Channel per Nominal Bandwidth (Frequency, MHz)	
	BW = 5 MHz	BW = 10 MHz
Low	23755 (706.5)	23780 (709)
Middle	23790 (710)	23790 (710)
High	23825 (713.5)	23800 (711)

NOTE: Band 17 is completely included in band 12, so the channels of band 12 were tested to give conformity to the assigned block. Only low block edge of band 17 was tested to give conformity to the assigned block.

LTE Band 66. QPSK AND 16QAM MODULATIONS.

	Channel per Nominal Bandwidth (Frequency, MHz)					
	BW = 1.4 MHz (*)	BW = 3 MHz (*)	BW = 5 MHz	BW = 10 MHz	BW = 15 MHz	BW = 20 MHz
Low	131979 (1710.7)	131987 (1711.5)	131997 (1712.5)	132022 (1715.0)	132047 (1717.5)	132072 (1720.0)
Middle	132322 (1745)	132322 (1745)	132322 (1745)	132322 (1745)	132322 (1745)	132322 (1745)
High	132665 (1779.3)	132657 (1778.5)	132647 (1777.5)	132622 (1775)	132597 (1772.5)	132572 (1770)

(*) The EUT does not support the Nominal Bandwidths 1.4 MHz, 3 MHz.

RF Output Power

SPECIFICATION

FCC §27.50 (b) (10):

Portable stations (hand-held devices) transmitting in the 746-757 MHz, 776-788 MHz, and 805-806 MHz bands are limited to 3 watts ERP.

FCC §27.50 (c) (10):

Portable stations (hand-held devices) in the 600 MHz uplink band and the 698-746 MHz band, and fixed and mobile stations in the 600 MHz uplink band are limited to 3 watts ERP.

FCC §27.50 (d) (4) & (5):

Fixed, mobile, and portable (hand-held) stations operating in the 1710-1755 MHz band and mobile and portable stations operating in the 1695-1710 MHz and 1755-1780 MHz bands are limited to 1 watt EIRP. Fixed stations operating in the 1710-1755 MHz band are limited to a maximum antenna height of 10 meters above ground. Mobile and portable stations operating in these bands must employ a means for limiting power to the minimum necessary for successful communications.

In measuring transmissions in this band using an average power technique, the peak-to-average ratio (PAR) of the transmission may not exceed 13 dB.

RSS-130 Clause 4.6:

4.6.1 General

The transmitter output power shall be measured in terms of average power. In addition, the peak-to-average power ratio (PAPR) of the transmitter shall not exceed 13 dB for more than 0.1% of the time and shall use a signal corresponding to the High PAPR during periods of continuous transmission.

4.6.3 Frequency bands 698-756 MHz and 777-787 MHz

The e.r.p. shall not exceed 30 watts for mobile equipment and outdoor fixed subscriber equipment. The e.r.p. shall not exceed 3 watts for portable equipment and indoor fixed subscriber equipment.

RSS-139 Clause 6.5:

The equivalent isotropically radiated power (e.i.r.p.) for mobile and portable transmitters shall not exceed one watt. The e.i.r.p. for fixed and base stations in the band 1710-1780 MHz shall not exceed one watt.

In addition, the peak to average power ratio (PAPR) of the equipment shall not exceed 13 dB for more than 0.1% of the time, using a signal that corresponds to the High PAPR during periods of continuous transmission.

METHOD

The conducted RF output power measurements were made at the RF output terminals of the EUT using the power meter of the Universal Radio Communication tester R&S CMW500, selecting maximum transmission power of the EUT and different modes of modulation.

The maximum equivalent isotropically radiated power (e.i.r.p.) is calculated by adding the declared maximum antenna gain (dBi).

The maximum effective radiated power e.r.p. is calculated from the maximum equivalent isotropically radiated power (e.i.r.p.) by subtracting 2.15 dB:

$$E.R.P. = E.I.R.P. - 2.15 \text{ dB}$$

The peak-to-average power ratio (PAPR) is measured using an attenuator, power splitter and spectrum analyser with a Complementary Cumulative Distribution Function implemented.

The EUT was controlled via the Universal Radio Communication tester R&S CMW500 selecting maximum transmission power of the EUT and different modes of modulation.

TEST SETUP

1. Conducted average power:



2. Peak-to-average power ratio (PAPR):

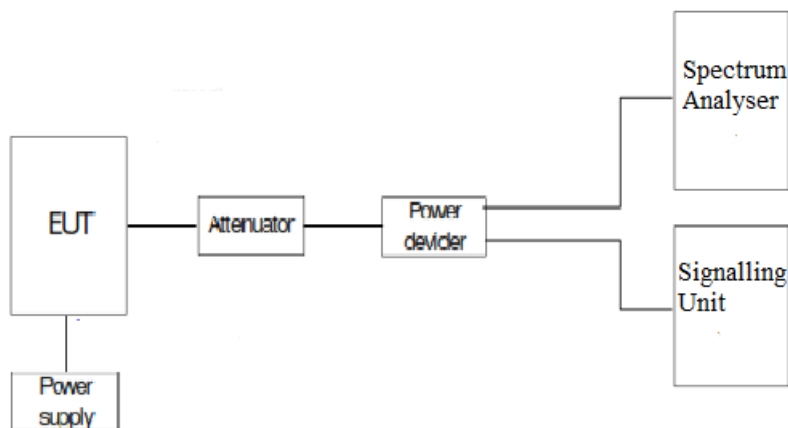

RESULTS

1. CONDUCTED AVERAGE POWER:

LTE BAND 12:

LTE Band 12. QPSK MODULATION. Bandwidth = 5 MHz.

Channel	Low	Middle	High
Maximum declared antenna gain (dBi)	1.10		
Measured maximum average power (dBm) at antenna port	23.78	23.71	23.70
Maximum equivalent isotropically radiated power (E.I.R.P.) (dBm)	24.88	24.81	24.80
Maximum effective radiated power E.R.P. (dBm)	22.73	22.66	22.65
PAPR (dB)	(*)		
Measurement uncertainty (dB)	<±0.66		

Average Power Worst Case: Modulation QPSK. RB Size: 1. RB Offset: 0. Narrow Band: 0.

(*): Preliminary measurements determined 16QAM as the worst-case modulation in terms of PAPR.

LTE Band 12. 16QAM MODULATION. Bandwidth = 5 MHz.

Channel	Low	Middle	High
Maximum declared antenna gain (dBi)	1.10		
Measured maximum average power (dBm) at antenna port	23.70	23.50	23.67
Maximum equivalent isotropically radiated power (E.I.R.P.) (dBm)	24.80	24.60	24.77
Maximum effective radiated power E.R.P. (dBm)	22.65	22.45	22.62
PAPR (dB)	5.32	5.32	5.34
Measurement uncertainty (dB)	<±0.66		

Average Power Worst Case: Modulation 16QAM. RB Size: 1. RB Offset: 0. Narrow Band: 0.

PAPR Worst Case Modulation 16QAM. RB Size: 5. RB Offset: 0. Narrow Band: 0.

LTE Band 12. QPSK MODULATION. Bandwidth = 10 MHz.

Channel	Low	Middle	High
Maximum declared antenna gain (dBi)	1.10		
Measured maximum average power (dBm) at antenna port	23.72	23.70	23.70
Maximum equivalent isotropically radiated power (E.I.R.P.) (dBm)	24.82	24.80	24.80
Maximum effective radiated power E.R.P. (dBm)	22.67	22.65	22.65
PAPR (dB)	(*)		
Measurement uncertainty (dB)	<±0.66		

Average Power Worst Case: Modulation QPSK. RB Size: 1. RB Offset: 0. Narrow Band: 0.

(*): Preliminary measurements determined 16QAM as the worst-case modulation in terms of PAPR.

LTE Band 12. 16QAM MODULATION. Bandwidth = 10 MHz.

Channel	Low	Middle	High
Maximum declared antenna gain (dBi)	1.10		
Measured maximum average power (dBm) at antenna port	23.48	23.55	23.36
Maximum equivalent isotropically radiated power (E.I.R.P.) (dBm)	24.58	24.65	24.46
Maximum effective radiated power E.R.P. (dBm)	22.43	22.50	22.31
PAPR (dB)	4.47	5.27	5.14
Measurement uncertainty (dB)	<±0.66		

Average Power Worst Case: Modulation 16QAM. RB Size: 1. RB Offset: 0. Narrow Band: 0.

PAPR Worst Case Modulation 16QAM. RB Size: 5. RB Offset: 0. Narrow Band: 0.

LTE BAND 13:

LTE Band 13. QPSK MODULATION. Bandwidth = 5 MHz.

Channel	Low	Middle	High
Maximum declared antenna gain (dBi)	1.10		
Measured maximum average power (dBm) at antenna port	23.15	23.18	23.17
Maximum equivalent isotropically radiated power (E.I.R.P.) (dBm)	24.25	24.28	24.27
Maximum effective radiated power E.R.P. (dBm)	22.10	22.13	22.12
PAPR (dB)	(*)		
Measurement uncertainty (dB)	<±0.66		

Average Power Worst Case: Modulation QPSK. RB Size: 1. RB Offset: 0. Narrow Band: 0.

(*): Preliminary measurements determined 16QAM as the worst-case modulation in terms of PAPR.

LTE Band 13. 16QAM MODULATION. Bandwidth = 5 MHz.

Channel	Low	Middle	High
Maximum declared antenna gain (dBi)	1.10		
Measured maximum average power (dBm) at antenna port	22.25	23.01	22.34
Maximum equivalent isotropically radiated power (E.I.R.P.) (dBm)	23.35	24.11	23.44
Maximum effective radiated power E.R.P. (dBm)	21.20	21.96	21.29
PAPR (dB)	5.22	5.26	5.16
Measurement uncertainty (dB)	<±0.66		

Average Power Worst Case: Modulation 16QAM. RB Size: 1. RB Offset: 0. Narrow Band: 0.

PAPR Worst Case Modulation 16QAM. RB Size: 5. RB Offset: 0. Narrow Band: 0.

LTE Band 13. QPSK MODULATION. Bandwidth = 10 MHz.

Channel	Low	Middle	High
Maximum declared antenna gain (dBi)	N/A	1.10	N/A
Measured maximum average power (dBm) at antenna port		23.16	
Maximum equivalent isotropically radiated power (E.I.R.P.) (dBm)		24.26	
Maximum effective radiated power E.R.P. (dBm)		22.11	
PAPR (dB)		(*)	
Measurement uncertainty (dB)	<±0.66		

Average Power Worst Case: Modulation QPSK. RB Size: 1. RB Offset: 0. Narrow Band: 0.

(*): Preliminary measurements determined 16QAM as the worst-case modulation in terms of PAPR.

LTE Band 13. 16QAM MODULATION. Bandwidth = 10 MHz.

Channel	Low	Middle	High
Maximum declared antenna gain (dBi)	1.10		
Measured maximum average power (dBm) at antenna port	N/A	22.95	N/A
Maximum equivalent isotropically radiated power (E.I.R.P.) (dBm)		24.05	
Maximum effective radiated power E.R.P. (dBm)		21.90	
PAPR (dB)		4.66	
Measurement uncertainty (dB)	<±0.66		

Average Power Worst Case: Modulation 16QAM. RB Size: 1. RB Offset: 0. Narrow Band: 0.

PAPR Worst Case Modulation 16QAM. RB Size: 5. RB Offset: 0. Narrow Band: 0.

LTE BAND 66:

LTE Band 66. QPSK MODULATION. Bandwidth = 5 MHz.

Channel	Low	Middle	High
Maximum declared antenna gain (dBi)	2.40		
Measured maximum average power (dBm) at antenna port	22.82	22.04	22.76
Maximum equivalent isotropically radiated power (E.I.R.P.) (dBm)	25.22	24.44	25.16
Maximum effective radiated power E.R.P. (dBm)	23.07	22.29	23.01
PAPR (dB)	(*)		
Measurement uncertainty (dB)	<±0.66		

Average Power Worst Case: Modulation QPSK. RB Size: 1. RB Offset: 0. Narrow Band: 0.

(*): Preliminary measurements determined 16QAM as the worst-case modulation in terms of PAPR.

LTE Band 66. 16QAM MODULATION. Bandwidth = 5 MHz.

Channel	Low	Middle	High
Maximum declared antenna gain (dBi)	2.40		
Measured maximum average power (dBm) at antenna port	21.74	21.91	21.75
Maximum equivalent isotropically radiated power (E.I.R.P.) (dBm)	24.14	24.31	24.15
Maximum effective radiated power E.R.P. (dBm)	21.99	22.16	22.00
PAPR (dB)	5.24	5.21	5.19
Measurement uncertainty (dB)	<±0.66		

Average Power Worst Case: Modulation 16QAM. RB Size: 1. RB Offset: 0. Narrow Band: 0.

PAPR Worst Case Modulation 16QAM. RB Size: 5. RB Offset: 0. Narrow Band: 0.

LTE Band 66. QPSK MODULATION. Bandwidth = 10 MHz.

Channel	Low	Middle	High
Maximum declared antenna gain (dBi)	2.40		
Measured maximum average power (dBm) at antenna port	22.81	22.85	22.74
Maximum equivalent isotropically radiated power (E.I.R.P.) (dBm)	25.21	25.25	25.14
Maximum effective radiated power E.R.P. (dBm)	23.06	23.10	22.99
PAPR (dB)	(*)		
Measurement uncertainty (dB)	<±0.66		

Average Power Worst Case: Modulation QPSK. RB Size: 1. RB Offset: 0. Narrow Band: 0.

(*): Preliminary measurements determined 16QAM as the worst-case modulation in terms of PAPR.

LTE Band 66. 16QAM MODULATION. Bandwidth = 10 MHz.

Channel	Low	Middle	High
Maximum declared antenna gain (dBi)	2.40		
Measured maximum average power (dBm) at antenna port	21.71	22.69	21.70
Maximum equivalent isotropically radiated power (E.I.R.P.) (dBm)	24.11	25.09	24.10
Maximum effective radiated power E.R.P. (dBm)	21.96	22.94	21.95
PAPR (dB)	4.63	4.79	4.78
Measurement uncertainty (dB)	<±0.66		

Average Power Worst Case: Modulation 16QAM. RB Size: 1. RB Offset: 0. Narrow Band: 0.

PAPR Worst Case Modulation 16QAM. RB Size: 5. RB Offset: 0. Narrow Band: 0.

LTE Band 66. QPSK MODULATION. Bandwidth = 15 MHz.

Channel	Low	Middle	High
Maximum declared antenna gain (dBi)	2.40		
Measured maximum average power (dBm) at antenna port	22.85	22.91	22.80
Maximum equivalent isotropically radiated power (E.I.R.P.) (dBm)	25.25	25.31	25.20
Maximum effective radiated power E.R.P. (dBm)	23.10	23.16	23.05
PAPR (dB)	5.20	4.92	4.09
Measurement uncertainty (dB)	<±0.66		

Average Power Worst Case: Modulation QPSK. RB Size: 1. RB Offset: 0. Narrow Band: 0.

PAPR Worst Case Modulation QPSK. RB Size: 1. RB Offset: 0. Narrow Band: 0.

LTE Band 66. 16QAM MODULATION. Bandwidth = 15 MHz.

Channel	Low	Middle	High
Maximum declared antenna gain (dBi)	2.40		
Measured maximum average power (dBm) at antenna port	21.69	22.81	21.77
Maximum equivalent isotropically radiated power (E.I.R.P.) (dBm)	24.09	25.21	24.17
Maximum effective radiated power E.R.P. (dBm)	21.94	23.06	22.02
PAPR (dB)	(*)		
Measurement uncertainty (dB)	<±0.66		

Average Power Worst Case: Modulation 16QAM. RB Size: 1. RB Offset: 0. Narrow Band: 0.

(*): Preliminary measurements determined QPSK as the worst-case modulation in terms of PAPR.

LTE Band 66. QPSK MODULATION. Bandwidth = 20 MHz.

Channel	Low	Middle	High
Maximum declared antenna gain (dBi)	2.40		
Measured maximum average power (dBm) at antenna port	23.46	22.94	23.21
Maximum equivalent isotropically radiated power (E.I.R.P.) (dBm)	25.86	25.34	25.61
Maximum effective radiated power E.R.P. (dBm)	23.71	23.19	23.46
PAPR (dB)	4.13	4.82	3.96
Measurement uncertainty (dB)	<±0.66		

Average Power Worst Case: Modulation QPSK. RB Size: 6. RB Offset: 0. Narrow Band: 0.

PAPR Worst Case Modulation QPSK. RB Size: 1. RB Offset: 0. Narrow Band: 0.

LTE Band 66. 16QAM MODULATION. Bandwidth = 20 MHz.

Channel	Low	Middle	High
Maximum declared antenna gain (dBi)	2.40		
Measured maximum average power (dBm) at antenna port	23.26	22.73	23.04
Maximum equivalent isotropically radiated power (E.I.R.P.) (dBm)	25.66	25.13	25.44
Maximum effective radiated power E.R.P. (dBm)	23.51	22.98	23.29
PAPR (dB)	(*)		
Measurement uncertainty (dB)	<±0.66		

Average Power Worst Case: Modulation 16QAM. RB Size: 5. RB Offset: 0. Narrow Band: 0.

(*): Preliminary measurements determined QPSK as the worst-case modulation in terms of PAPR.

2. PEAK-TO-AVERAGE POWER RATIO (PAPR):

LTE Band 12:

The next results are for the worst-case configuration.

LTE Band 12. Bandwidth = 5 MHz. Modulation 16 QAM. RB Size: 5. RB Offset: 0. Narrow Band: 0.

Low Channel:

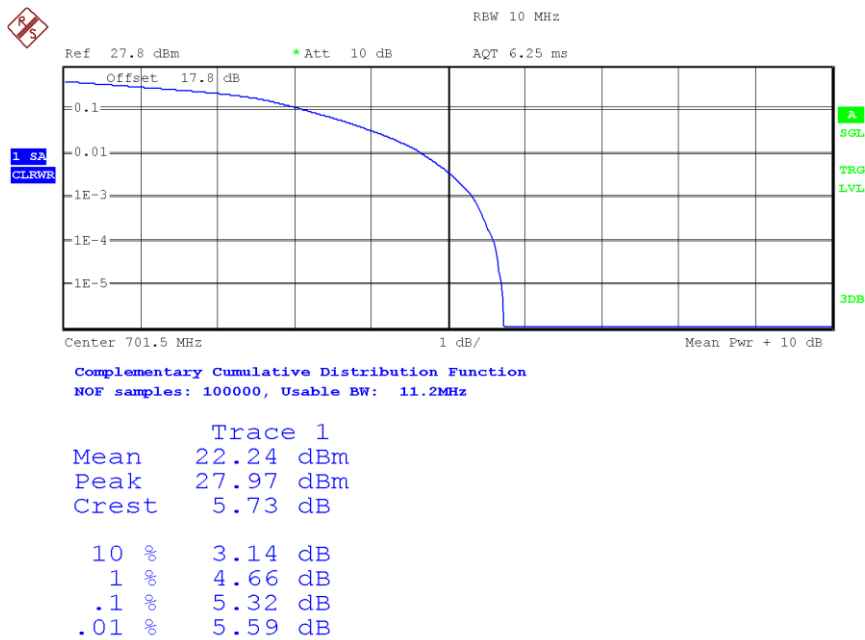

Middle Channel:

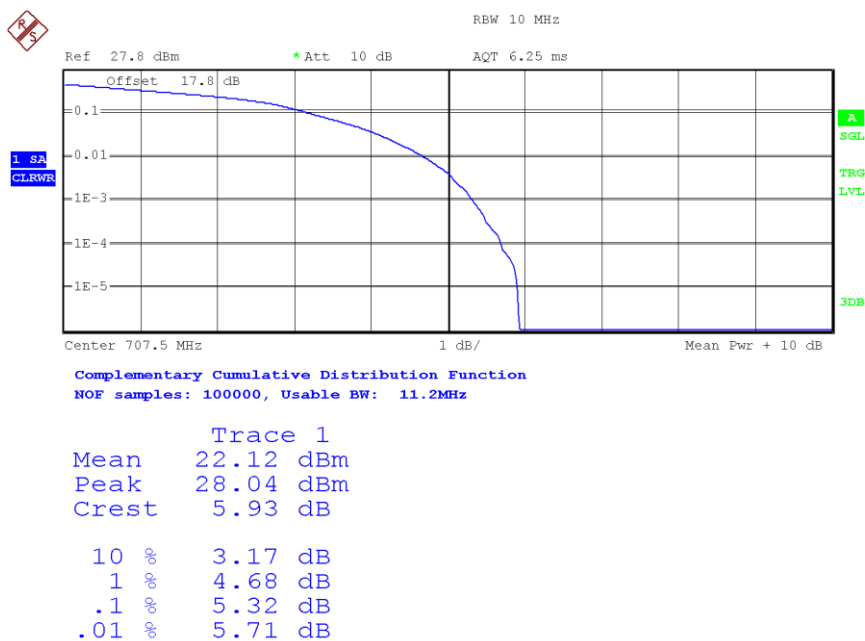

High Channel:

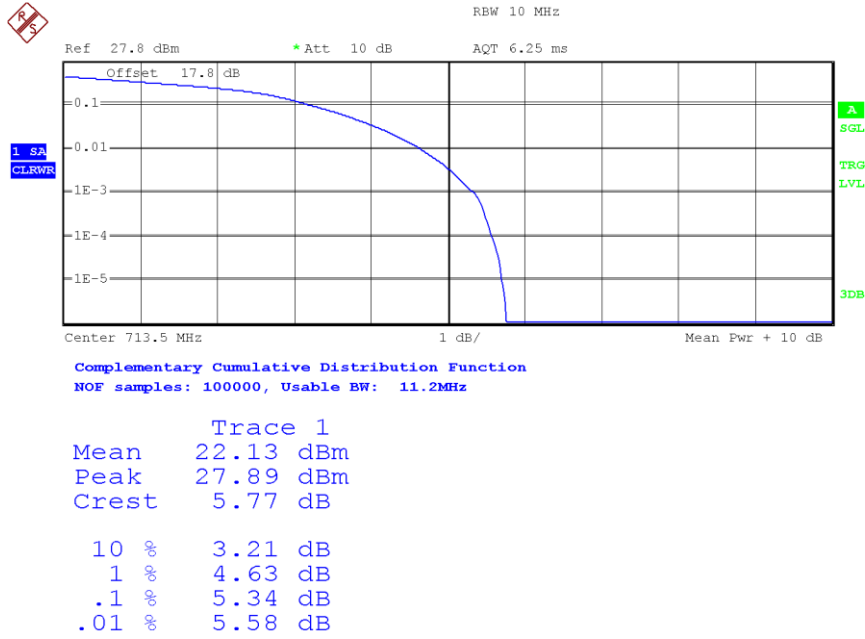

LTE Band 13:

The next results are for the worst-case configuration.

LTE Band 13. Bandwidth = 5 MHz. Modulation 16 QAM. RB Size: 5. RB Offset: 0. Narrow Band: 0.

Low Channel:

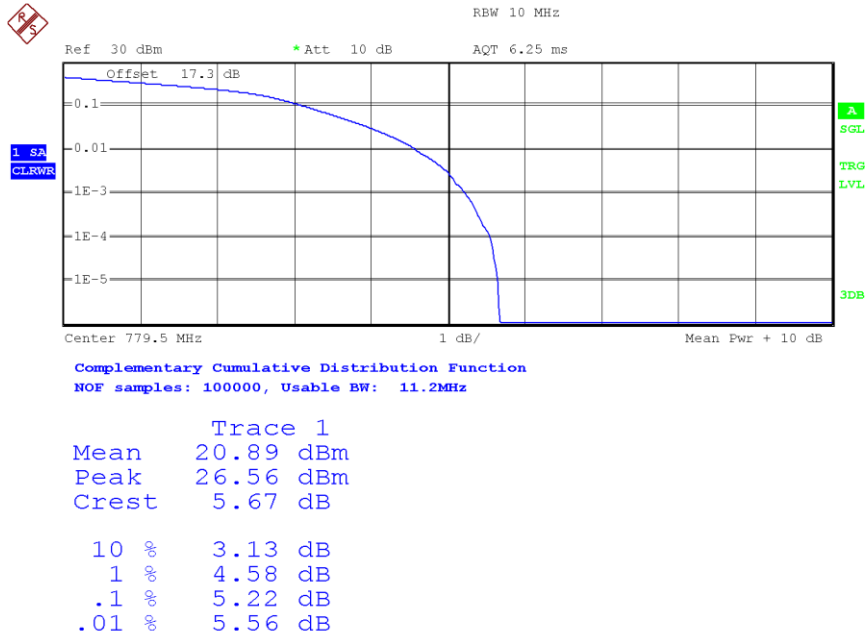

Middle Channel:

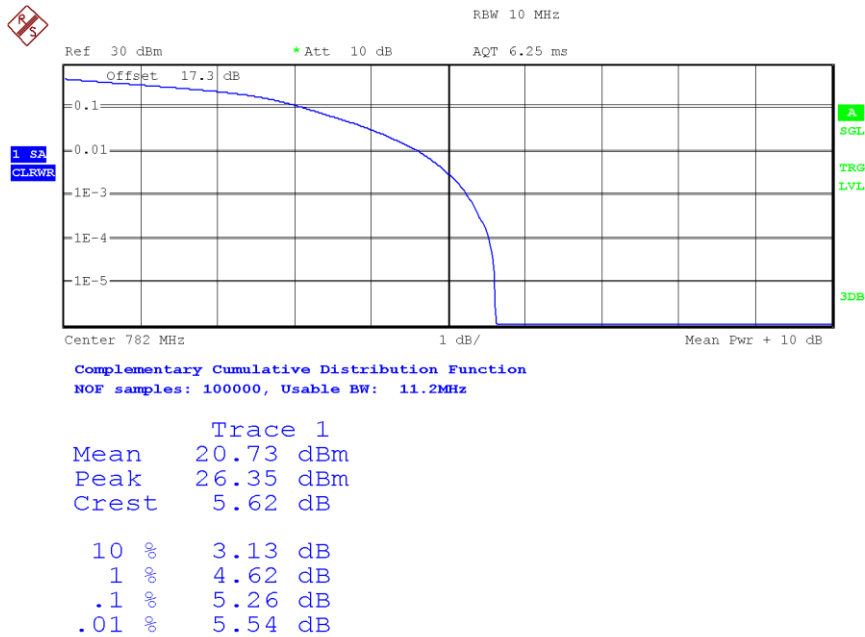

High Channel:

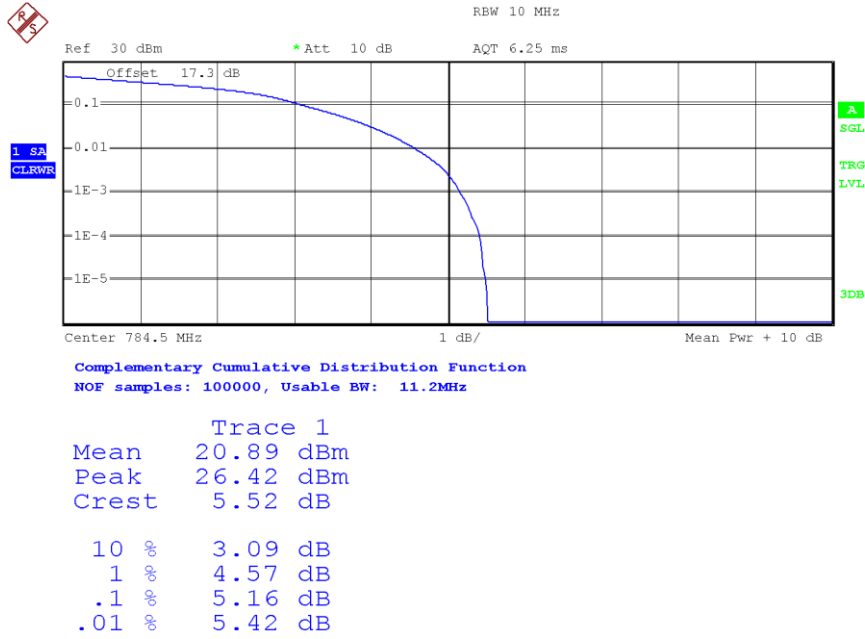

LTE Band 66:

The next results are for the worst-case configuration.

LTE Band 66. Bandwidth = 5 MHz. Modulation 16 QAM. RB Size: 5. RB Offset: 0. Narrow Band: 0.

Low Channel:

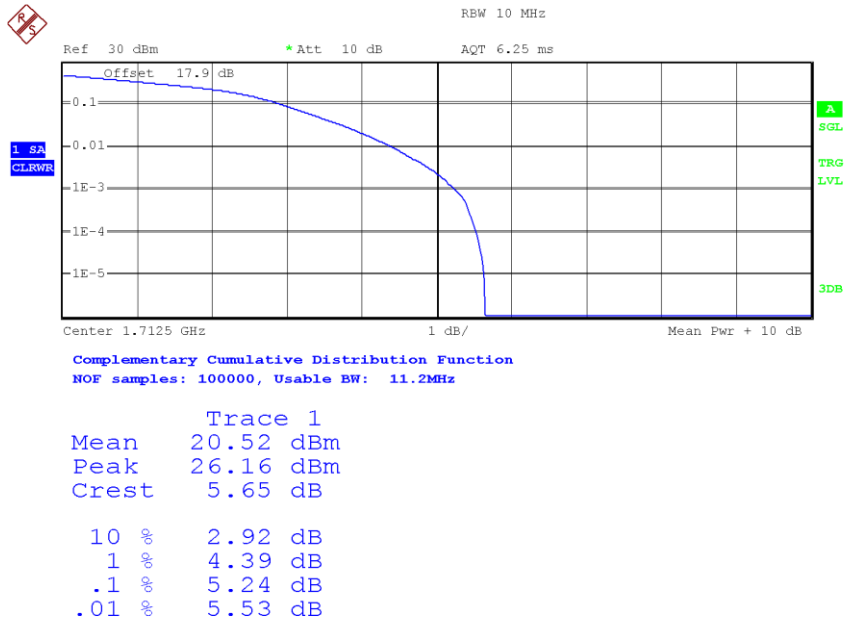

Middle Channel:

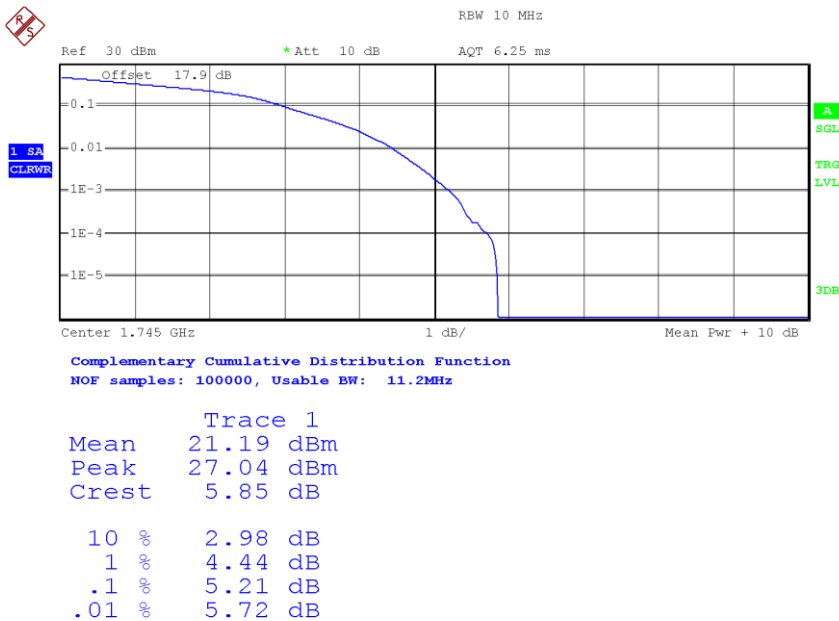

High Channel:

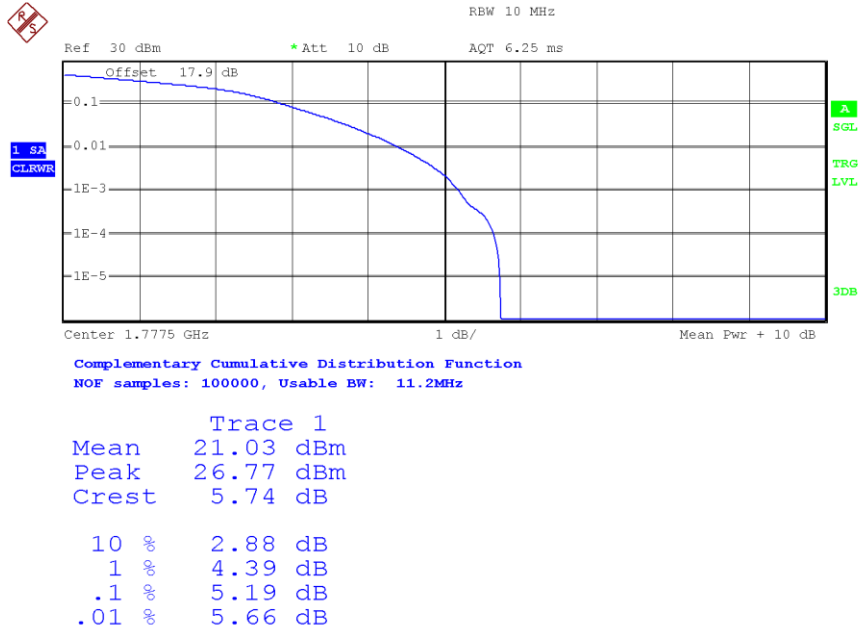

LTE Band 12:

Channel	Measured maximum average power (dBm) at antenna port	Maximum declared antenna gain (dBi)	Maximum equivalent isotropically radiated power (E.I.R.P.) (dBm)	Maximum effective radiated power E.R.P. (dBm)	PAPR (dB)
Low	23.78	1.10	24.88	22.73	5.32
Middle	23.71		24.81	22.66	5.32
High	23.70		24.80	22.65	5.34
Measurement uncertainty (dB)	<±0.66				

LTE Band 13:

Channel	Measured maximum average power (dBm) at antenna port	Maximum declared antenna gain (dBi)	Maximum equivalent isotropically radiated power (E.I.R.P.) (dBm)	Maximum effective radiated power E.R.P. (dBm)	PAPR (dB)
Low	23.15	1.10	24.25	22.10	5.22
Middle	23.18		24.28	22.13	5.26
High	23.17		24.27	22.12	5.16
Measurement uncertainty (dB)	<±0.66				

LTE Band 66:

Channel	Measured maximum average power (dBm) at antenna port	Maximum declared antenna gain (dBi)	Maximum equivalent isotropically radiated power (E.I.R.P.) (dBm)	Maximum effective radiated power E.R.P. (dBm)	PAPR (dB)
Low	23.46	2.40	25.86	23.71	5.24
Middle	22.94		25.34	23.19	5.21
High	23.21		25.61	23.46	5.19
Measurement uncertainty (dB)	<±0.66				

Verdict: PASS

Frequency Stability

SPECIFICATION

FCC §27.54 & §2.1055. The frequency stability shall be sufficient to ensure that the fundamental emissions stay within the authorized bands of operation.

RSS-130, Clause 4.5 & RSS-139, Clause 6.4. The frequency stability shall be sufficient to ensure that the occupied bandwidth remains within each frequency block range when tested at the temperature and supply voltage variations specified in RSS-Gen.

METHOD

The frequency tolerance measurements over temperature variations were made over the temperature range of -30°C to $+50^{\circ}\text{C}$. The EUT was placed inside a climatic chamber and the temperature was raised hourly in 10°C steps from -30°C up to $+50^{\circ}\text{C}$.

The supply voltage was varied between 85% and 115% of nominal voltage.

The EUT was set in "Radio Resource Control (RRC) mode" on the middle channel using the Universal Radio Communication tester R&S CMW500 and the maximum frequency error was measured using the built-in calibrated frequency meter.

The worst case LTE mode for conducted power was used for the test.

In order to check that the frequency stability is sufficient such that the fundamental emissions stay within the authorized bands of operation, a reference point is established at the applicable unwanted emissions limit using a RBW equal to the RBW required by the unwanted emissions specification of the applicable regulatory standard. These reference points measured using the lowest and highest channel of operation are identified as fL and fH respectively. The worst-case frequency offset determined in the above methods is added or subtracted from the values of fL and fH to check that the resulting frequencies remain within the band.

The reference point measurements were made at the RF output terminals of the EUT using an attenuator, power splitter and spectrum analyser. The EUT was controlled via the Universal Radio Communication tester R&S CMW500 selecting maximum transmission power of the EUT and different modes of modulation.

TEST SETUP

Frequency tolerance:

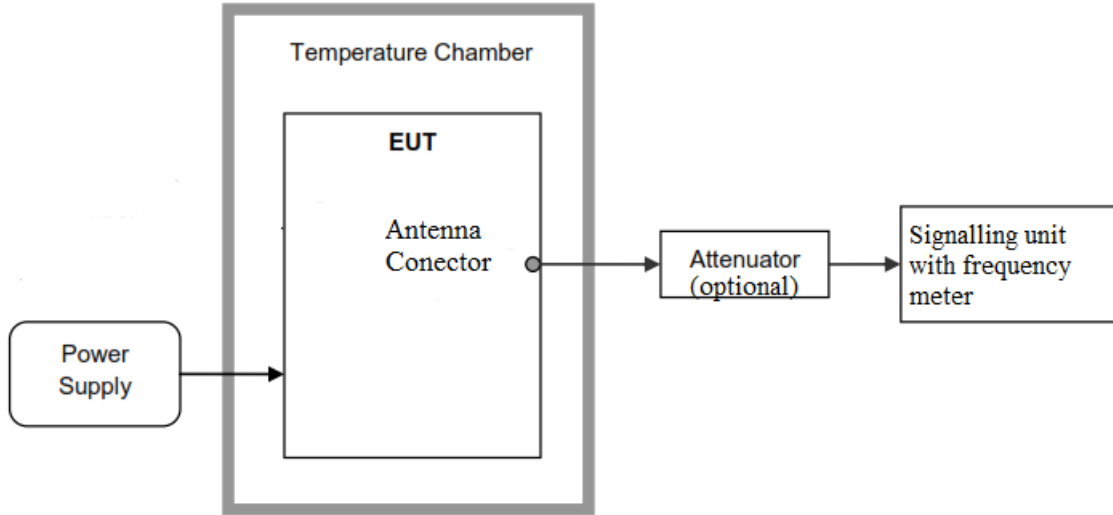

Reference points f_L and f_H :

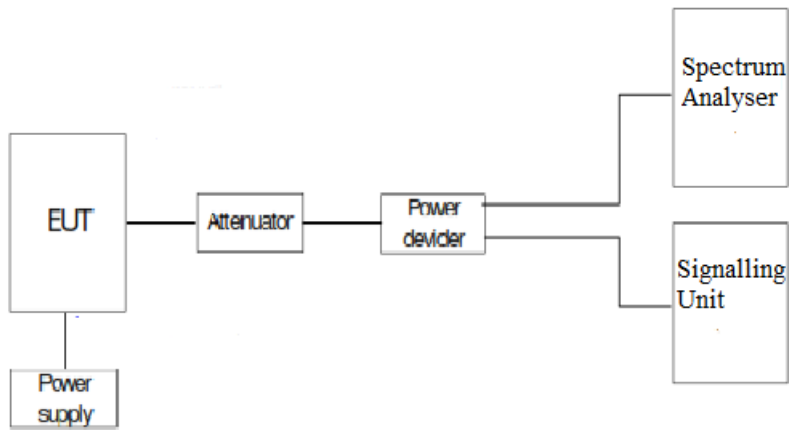

RESULTS

1. FREQUENCY TOLERANCE:

- Frequency stability over temperature variations.

LTE Band 12:

Temperature (°C)	Frequency Error (Hz)	Frequency Error (ppm)
+50	-15.50	-0.021908127
+40	-12.48	-0.017639576
+30	-16.59	-0.023448763
+20	-14.86	-0.021003534
+10	-16.09	-0.022742049
0	-13.14	-0.018572438
-10	-11.41	-0.016127208
-20	-9.51	-0.013441696
-30	-11.15	-0.015759717

LTE Band 13:

Temperature (°C)	Frequency Error (Hz)	Frequency Error (ppm)
+50	-17.74	-0.022685422
+40	-21.56	-0.027570332
+30	-28.22	-0.036086957
+20	-26.75	-0.034207161
+10	-24.12	-0.030843990
0	-12.75	-0.016304348
-10	-24.18	-0.030920716
-20	-16.51	-0.021112532
-30	-12.79	-0.016355499

LTE Band 66:

Temperature (°C)	Frequency Error (Hz)	Frequency Error (ppm)
+50	-8.59	-0.004922636
+40	-15.57	-0.008922636
+30	-17.88	-0.010246418
+20	-9.34	-0.005352436
+10	-13.78	-0.007896848
0	-17.65	-0.010114613
-10	-18.37	-0.010527221
-20	-10.66	-0.006108883
-30	-7.04	-0.004034384

- **Frequency stability over voltage variations.**

LTE Band 12:

Supply voltage	Voltage (V)	Frequency Error (Hz)	Frequency Error (ppm)
Vmax	3.795	-10.44	-0.014756184
Vmin	2.805	-11.22	-0.015858657

LTE Band 13:

Supply voltage	Voltage (V)	Frequency Error (Hz)	Frequency Error (ppm)
Vmax	3.795	-18.48	-0.023631714
Vmin	2.805	-21.69	-0.027736573

LTE Band 66:

Supply voltage	Voltage (V)	Frequency Error (Hz)	Frequency Error (ppm)
Vmax	3.795	-19.09	-0.010939828
Vmin	2.805	-6.45	-0.003696275

2. REFERENCE FREQUENCY POINTS f_L AND f_H:

The worst-case frequency offsets added or subtracted per band and bandwidth:

LTE Band 12: QPSK. Nominal bandwidth 5MHz

f _L (MHz)	698.999200
f _H (MHz)	715.950000

LTE Band 13: QPSK. Nominal bandwidth 5MHz

f _L (MHz)	776.065800
f _H (MHz)	786.952500

LTE Band 66: QPSK. Nominal bandwidth 5MHz

f _L (MHz)	1710.081000
f _H (MHz)	1779.917670

The reference frequency points f_L and f_H stay within the authorized blocks for the band above.

Measurement uncertainty (Hz): <±207.77

Verdict: PASS

Modulation Characteristics

SPECIFICATION

FCC §2.1047.

RSS-130, Clause 4.2: Equipment certified under this standard shall employ digital modulation.

RSS-139, Clause 6.2: The devices may employ any type of modulation techniques. The type of modulation used must be reported.

METHOD

For LTE the EUT operates with QPSK and 16QAM modulation modes in which the information is digitised and coded into a bit stream. The RF transmission is multiplexed using *Orthogonal Frequency Division Multiplexing (OFDM)* using different possible arrangement of subcarriers (Resource Blocks RB).

TEST SETUP

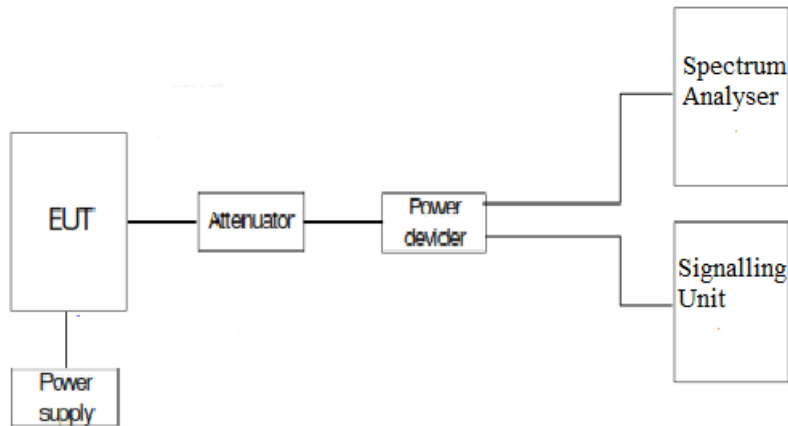

RESULTS

The following plots show the modulation schemes in the EUT.

LTE Band 12:

QPSK. Nominal Bandwidth 5 MHz.

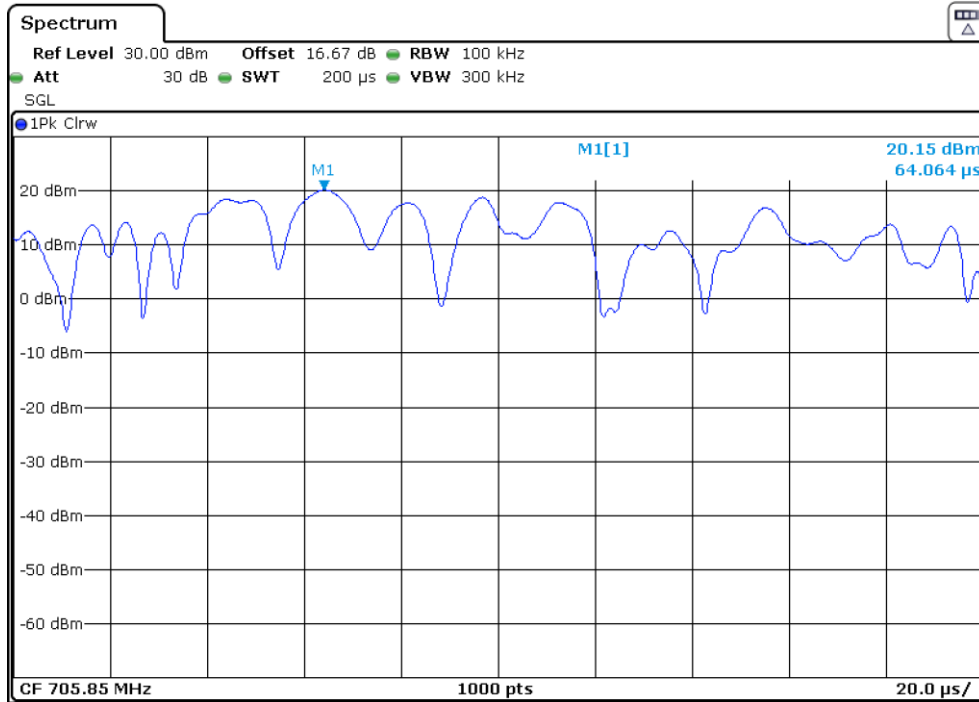

16QAM. Nominal Bandwidth 5 MHz.

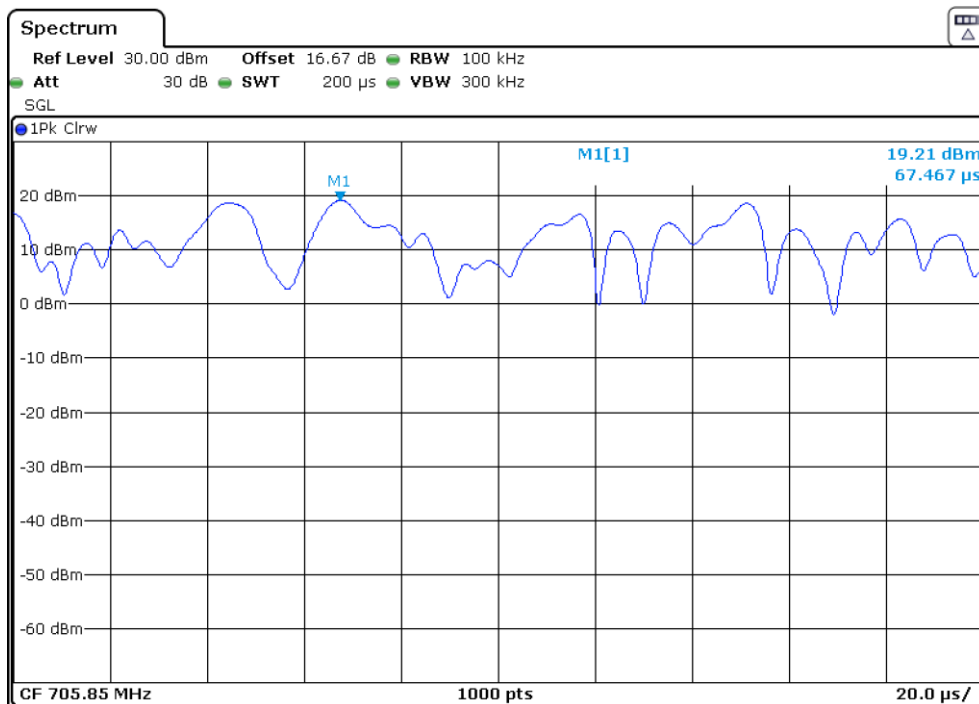

LTE Band 13:

QPSK. Nominal Bandwidth 5 MHz.

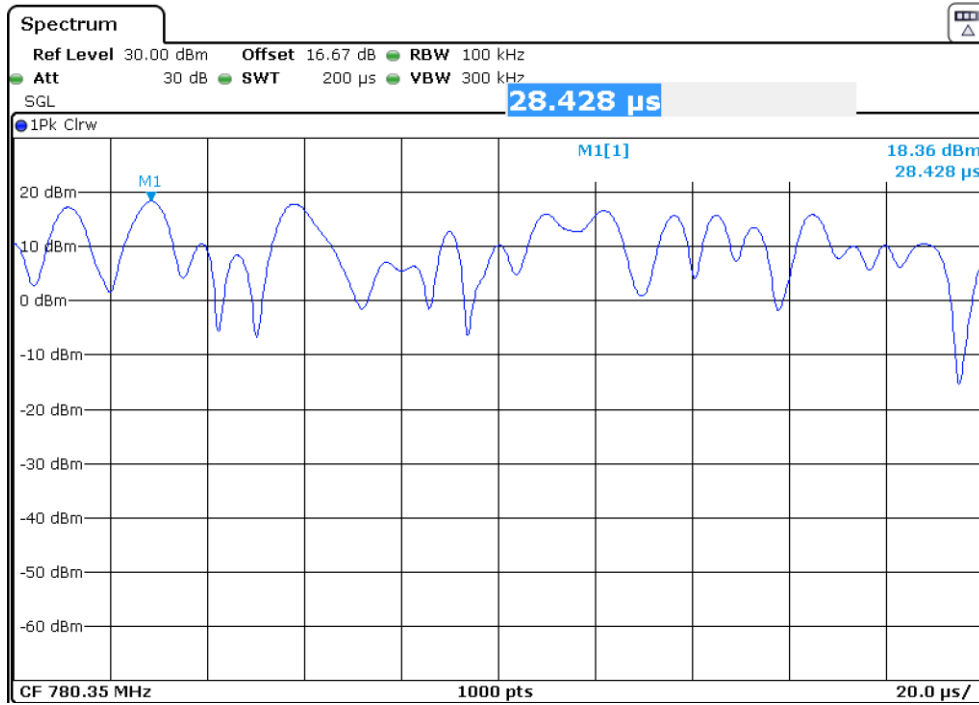

16QAM. Nominal Bandwidth 5 MHz.

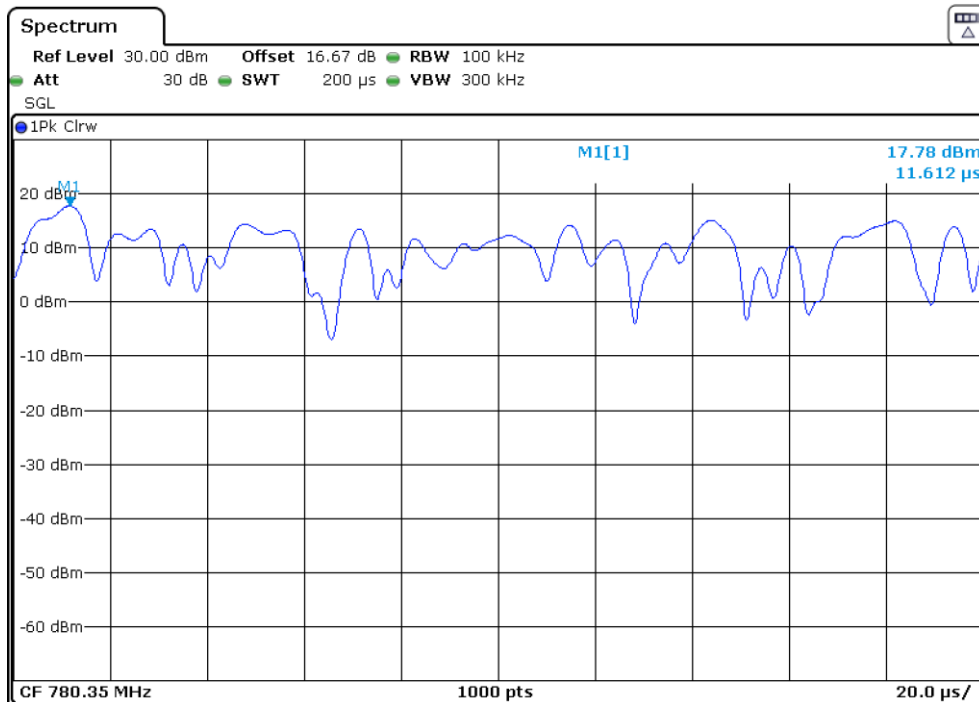

LTE Band 66:

QPSK. Nominal Bandwidth 5 MHz.

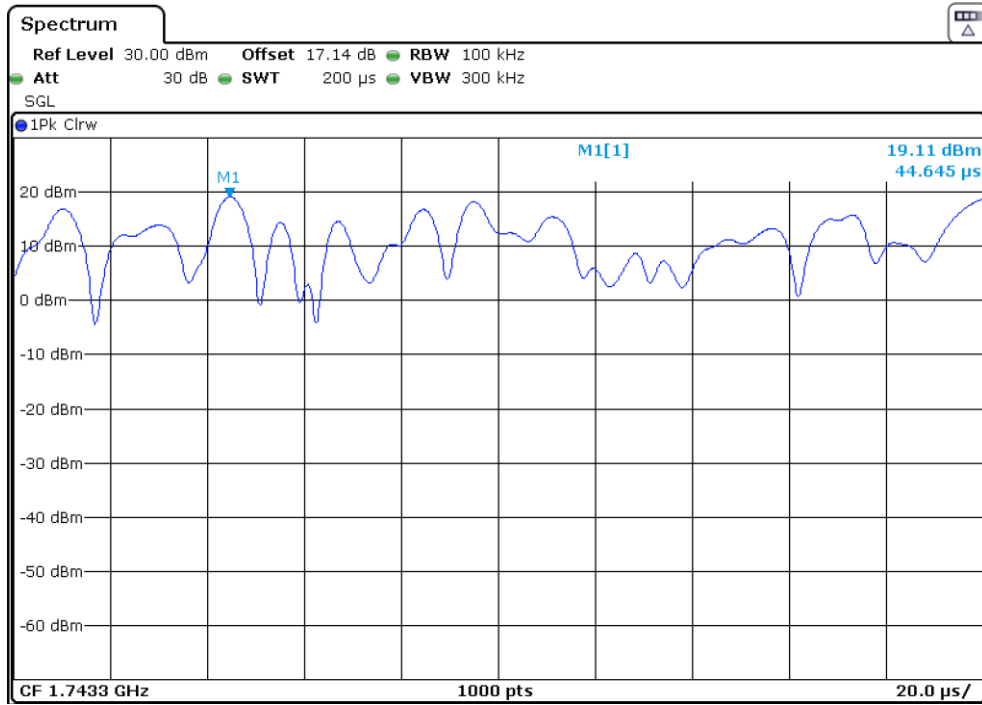

16QAM. Nominal Bandwidth 5 MHz.

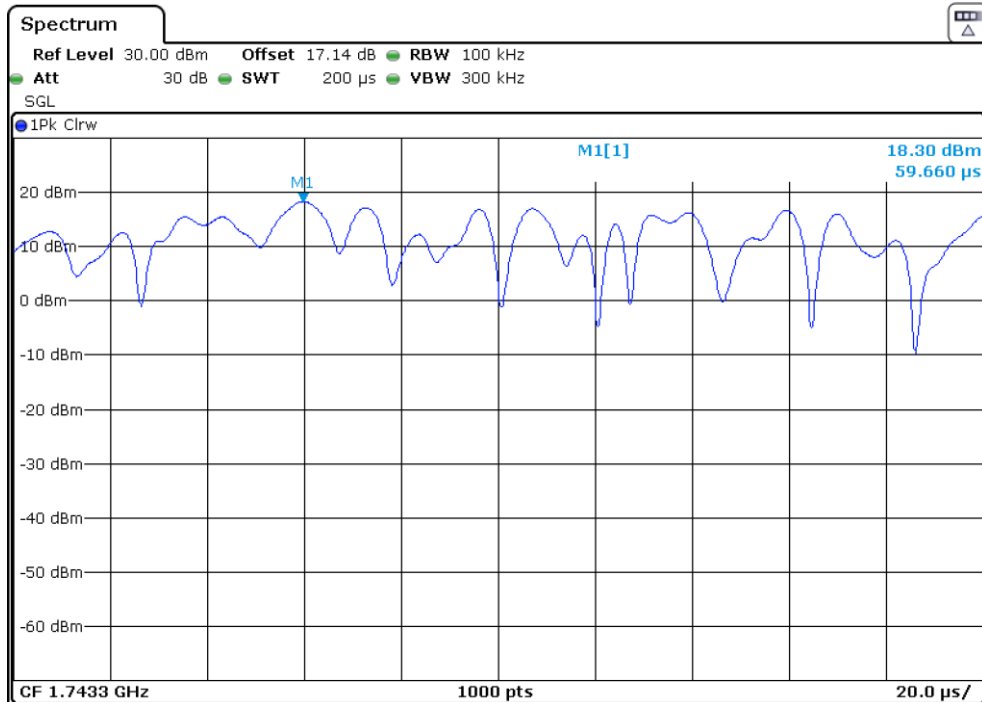

Occupied Bandwidth

SPECIFICATION

FCC §2.1049: Measurements required: Occupied bandwidth.

RSS-Gen, Clause 6.7.

METHOD

The occupied bandwidth measurement was performed at the output terminals of the EUT using an attenuator, power splitter and spectrum analyser. The EUT was controlled via the Universal Radio Communication tester R&S CMW500 selecting maximum transmission power of the EUT and different modes of modulation. The 99% occupied bandwidth and the -26 dBc bandwidth were measured directly using the built-in bandwidth measuring option of spectrum analyser.

TEST SETUP

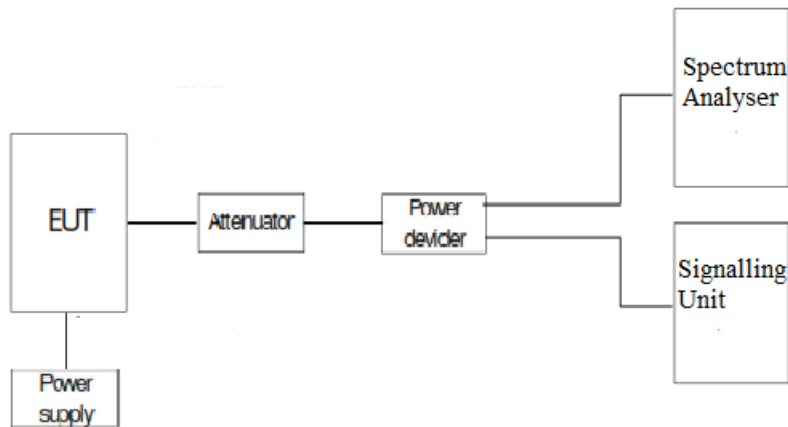

RESULTS

The worst case of occupied bandwidth corresponds to all Resource Blocks (RB) offset 0 regardless either the Narrowband position or the Nominal Bandwidth selected.

LTE Band 12:

QPSK. Nominal Bandwidth 5 MHz. Narrowband = 0, Position 1.

Channel	Low	Middle	High
99% Occupied Bandwidth (MHz)	1.113000	1.108000	1.109000
-26 dBc Bandwidth (MHz)	1.420000	1.404500	1.409000
Measurement uncertainty (kHz)	<±3.75		

16QAM. Nominal Bandwidth 5 MHz. Narrowband = 0, Position 1.

Channel	Low	Middle	High
99% Occupied Bandwidth (MHz)	0.951500	0.964500	0.965000
-26 dBc Bandwidth (MHz)	1.386000	1.389500	1.354500
Measurement uncertainty (kHz)	<±3.75		

LTE Band 13:

QPSK. Nominal Bandwidth 5 MHz. Narrowband = 0, Position 1.

Channel	Low	Middle	High
99% Occupied Bandwidth (MHz)	1.111500	1.108500	1.106500
-26 dBc Bandwidth (MHz)	1.439000	1.406500	1.421000
Measurement uncertainty (kHz)	<±3.75		

16QAM. Nominal Bandwidth 5 MHz. Narrowband = 0, Position 1.

Channel	Low	Middle	High
99% Occupied Bandwidth (MHz)	0.953000	0.955000	0.960000
-26 dBc Bandwidth (MHz)	1.323000	1.373000	1.376500
Measurement uncertainty (kHz)	<±3.75		

LTE Band 66:

QPSK. Nominal Bandwidth 5 MHz. Narrowband = 0, Position 1.

Channel	Low	Middle	High
99% Occupied Bandwidth (MHz)	1.104500	1.104500	1.105500
-26 dBc Bandwidth (MHz)	1.415500	1.366500	1.394550
Measurement uncertainty (kHz)	<±3.75		

16QAM. Nominal Bandwidth 5 MHz. Narrowband = 0, Position 1.

Channel	Low	Middle	High
99% Occupied Bandwidth (MHz)	0.969000	0.937000	0.956500
-26 dBc Bandwidth (MHz)	1.376000	1.354500	1.358050
Measurement uncertainty (kHz)	<±3.75		

LTE Band 12. QPSK. Nominal Bandwidth 5 MHz. Narrowband = 0. Position 1.

Low Channel:

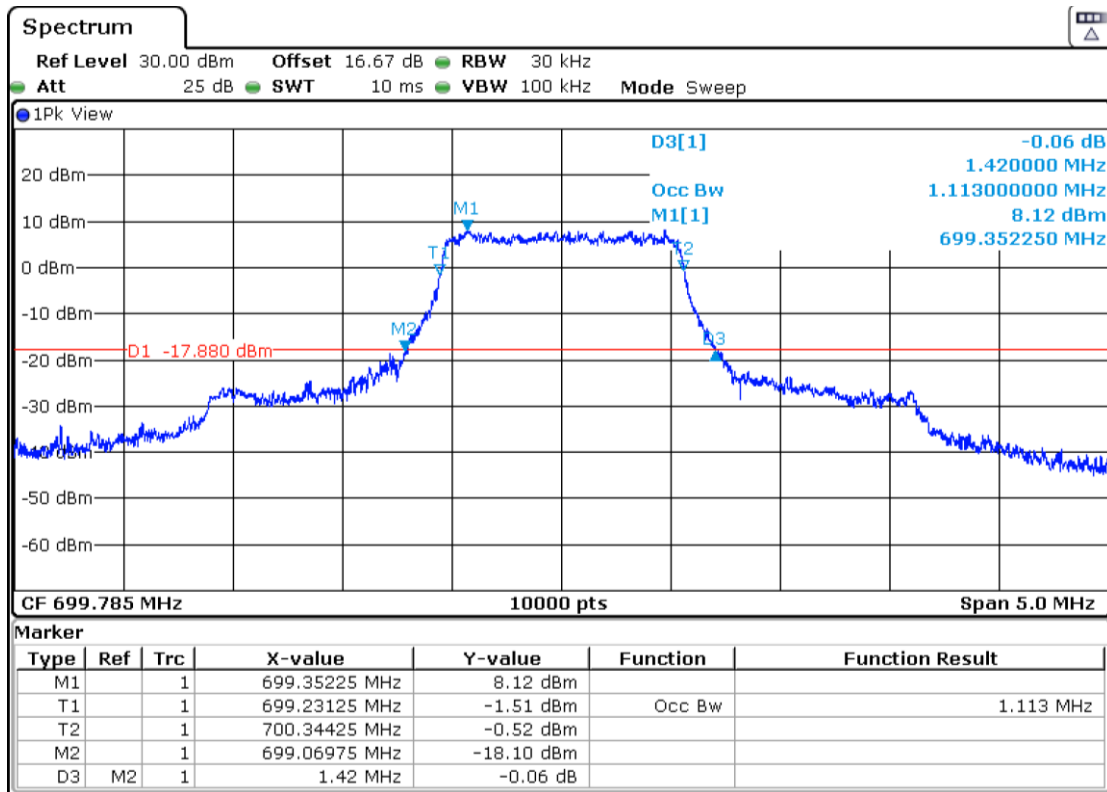

Middle Channel:

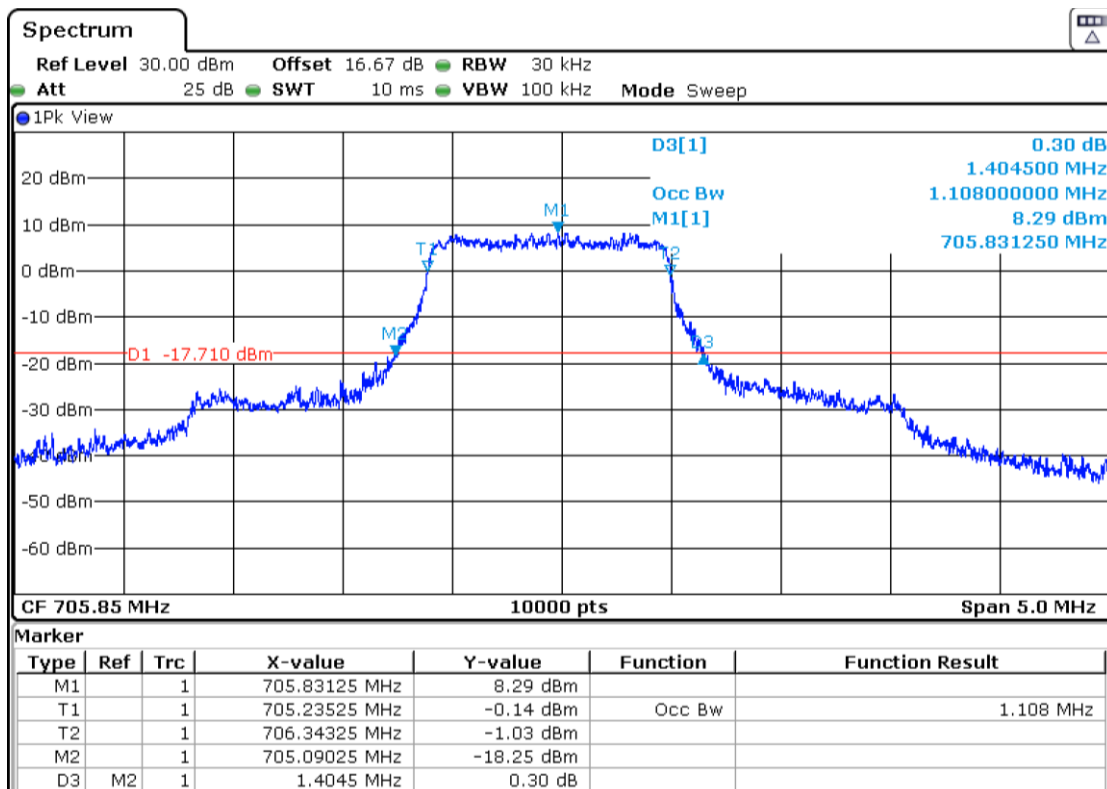

High Channel:

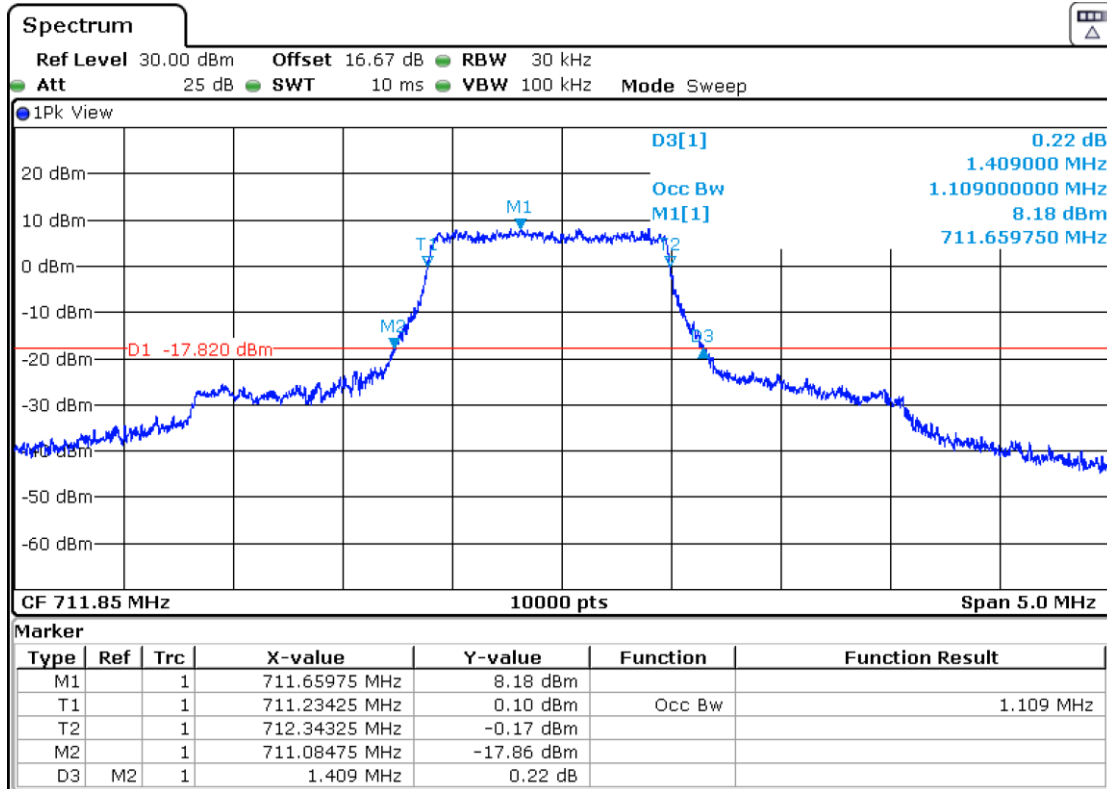

LTE Band 12. 16QAM. Nominal Bandwidth 5 MHz. Narrowband = 0. Position 1.

Low Channel:

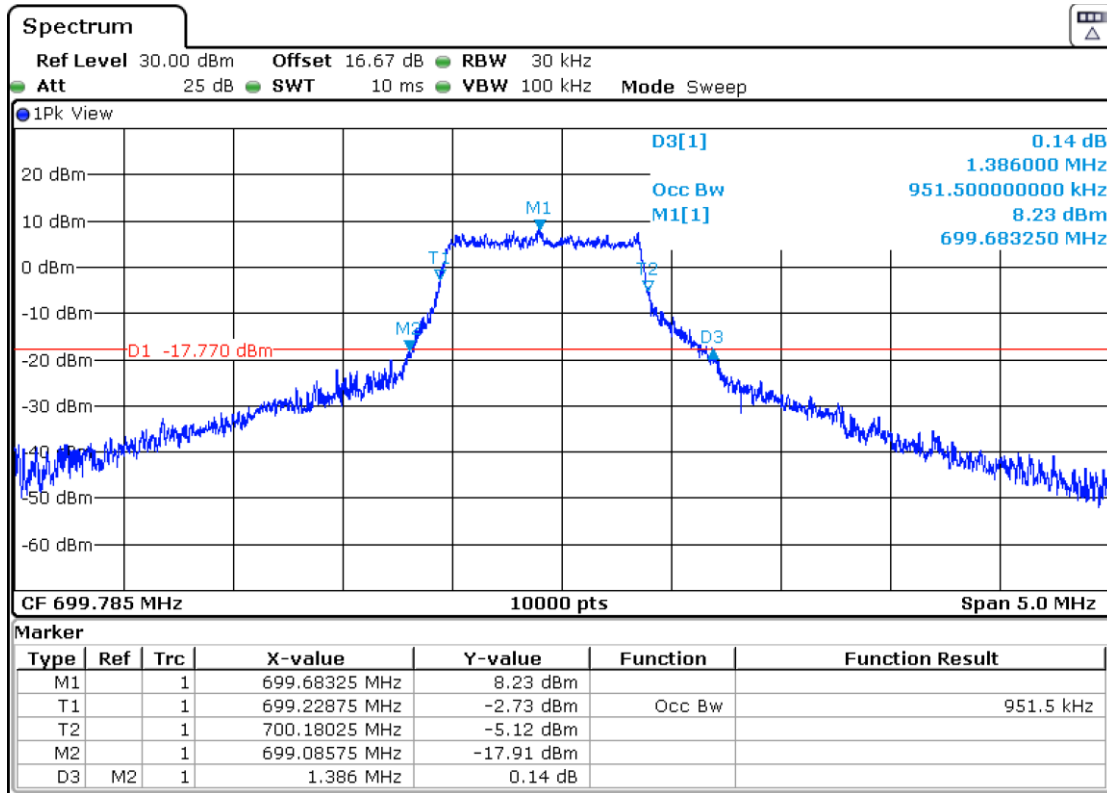

Middle Channel:

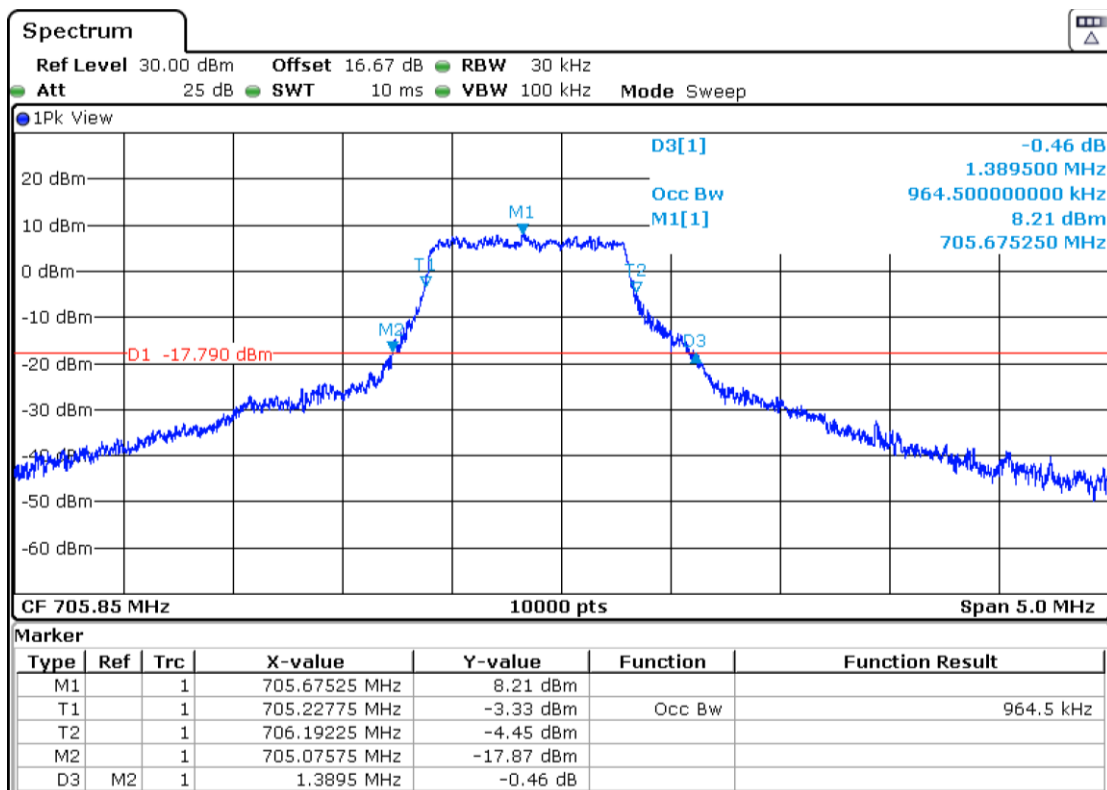

High Channel:

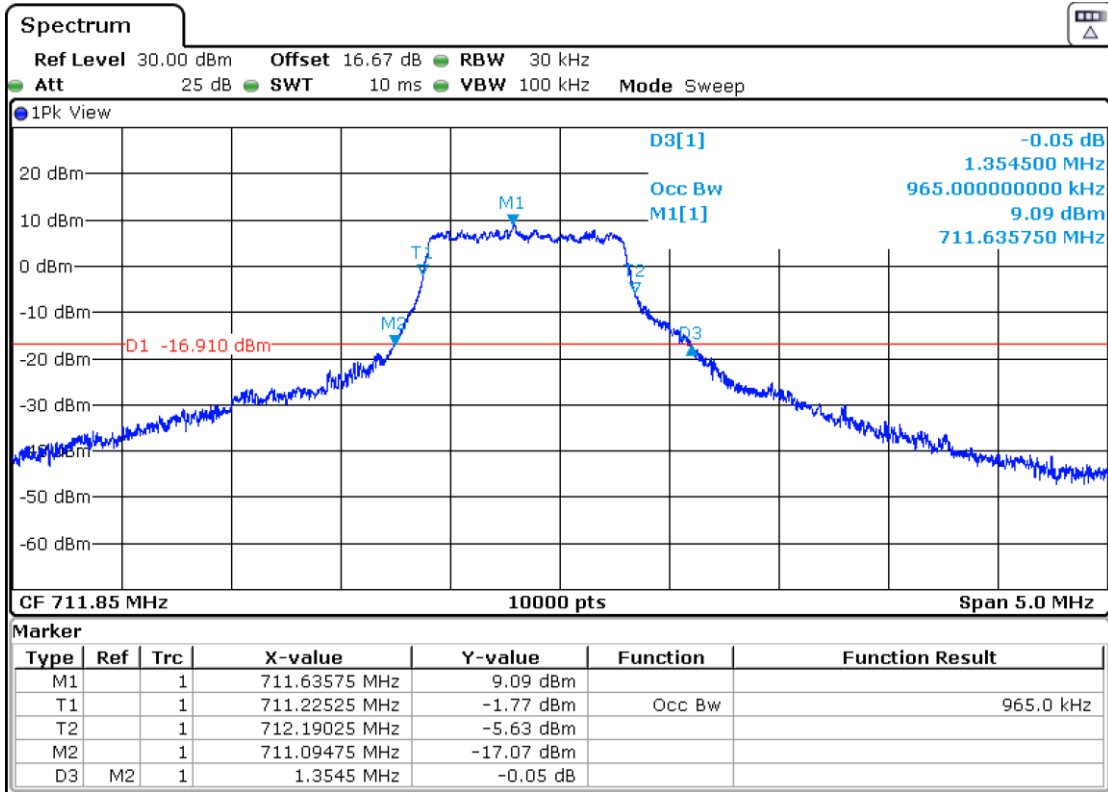

LTE Band 13. QPSK. Nominal Bandwidth 5 MHz. Narrowband = 0. Position 1.

Low Channel:

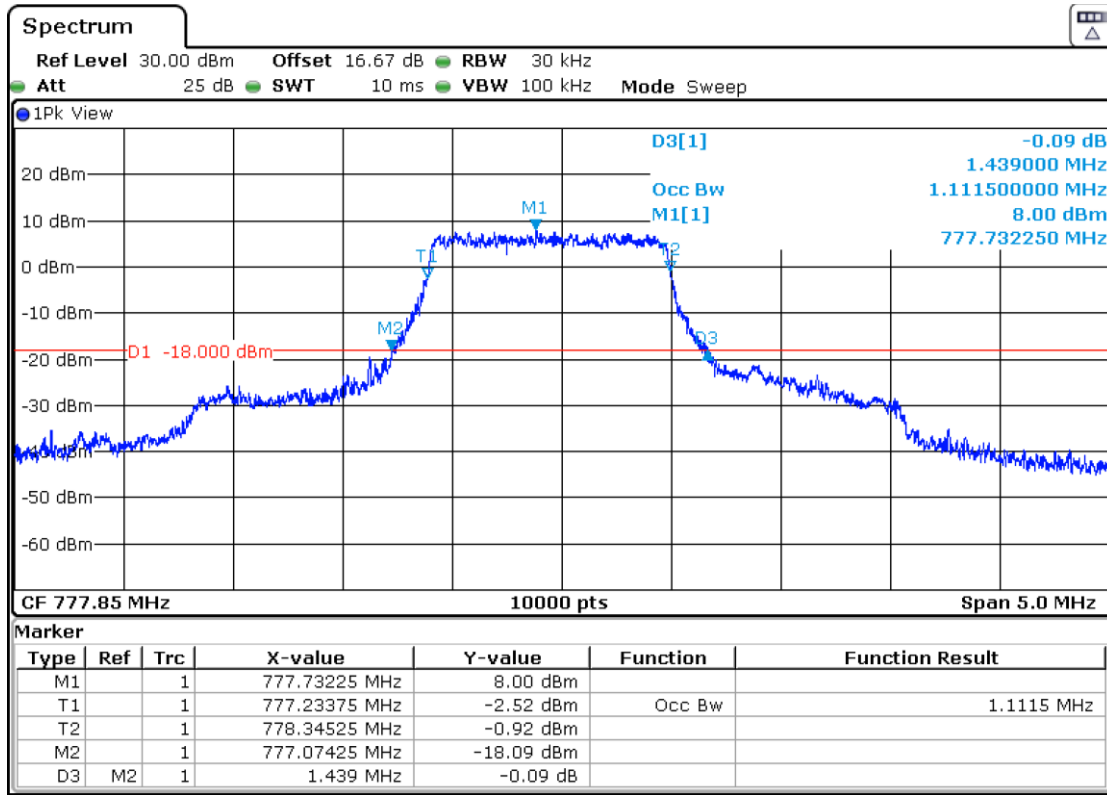

Middle Channel:

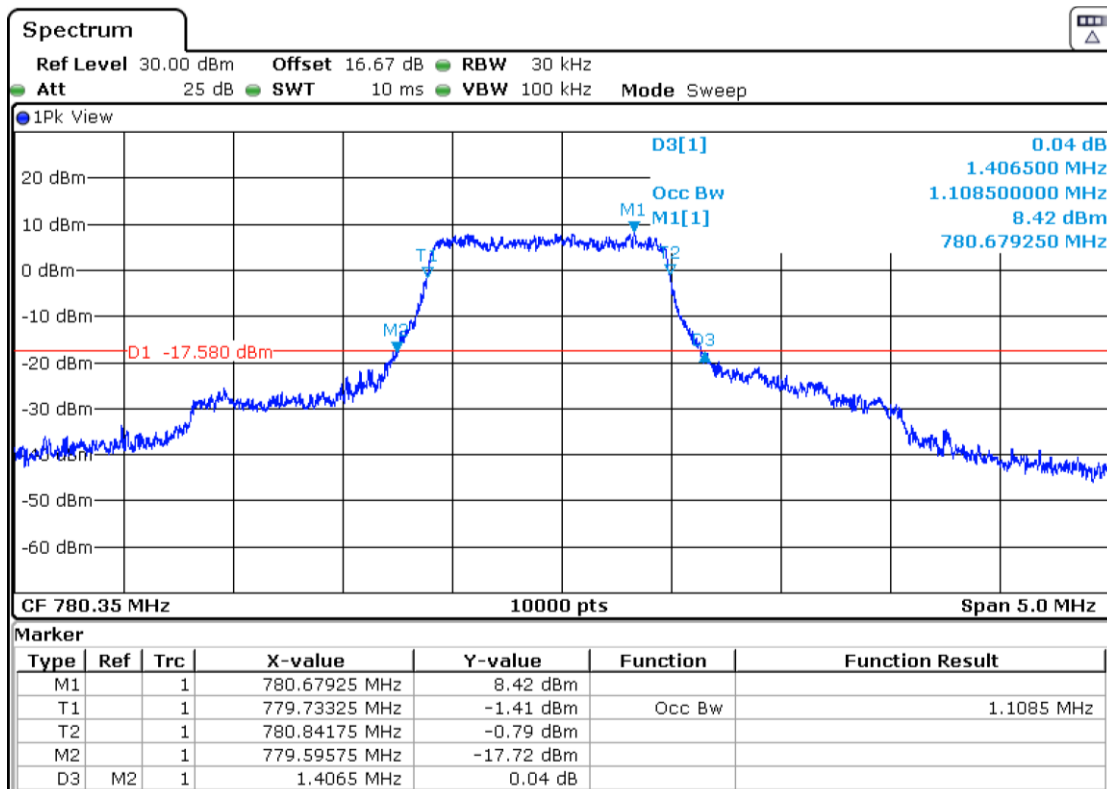

High Channel:

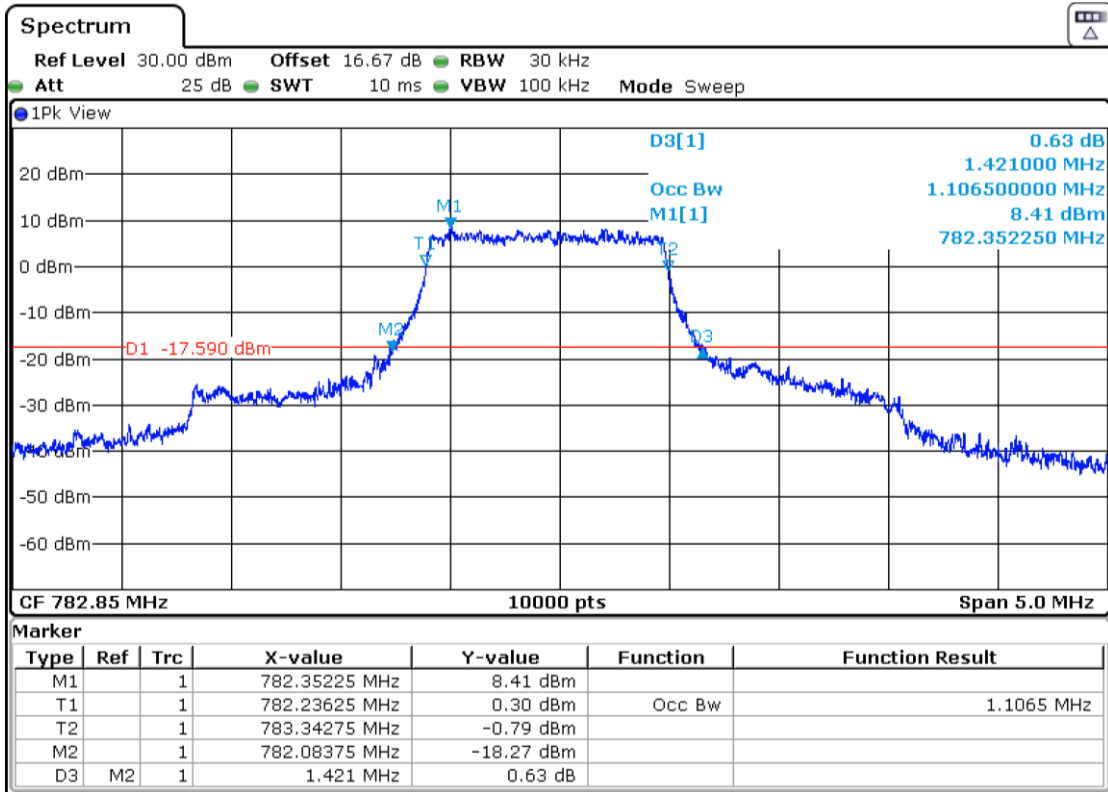

LTE Band 13. 16QAM. Nominal Bandwidth 5 MHz. Narrowband = 0. Position 1.

Low Channel:

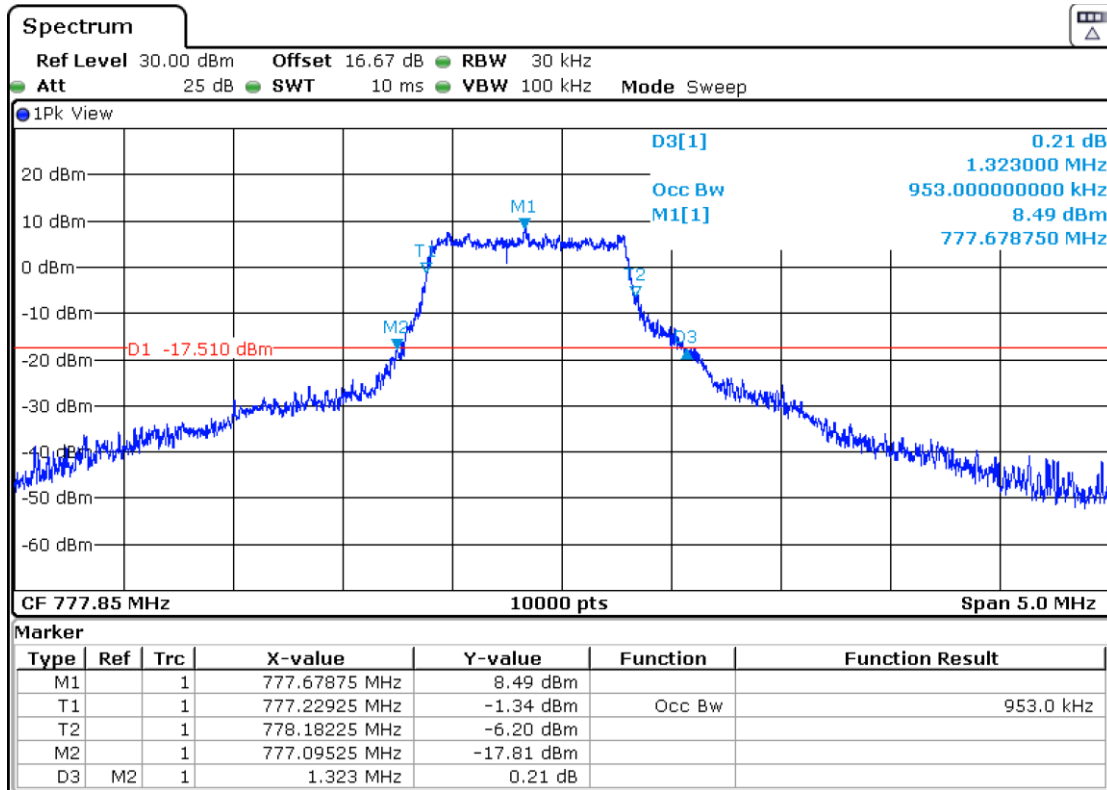

Middle Channel:

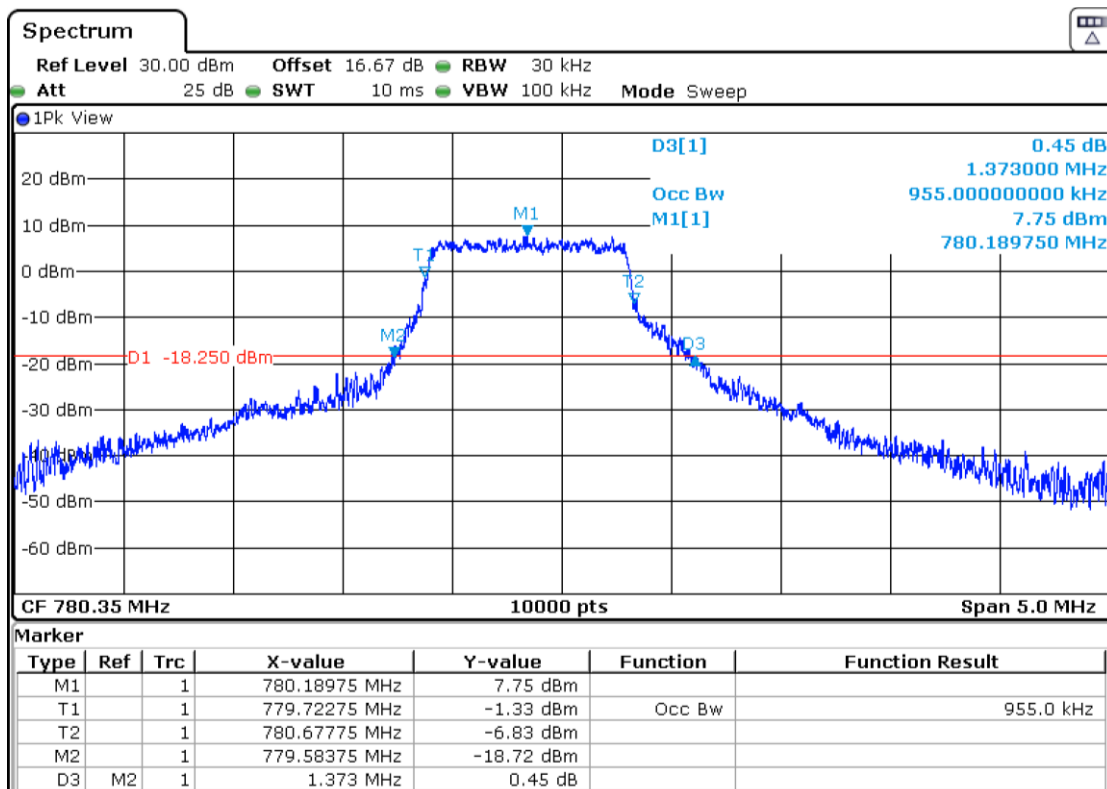

High Channel:

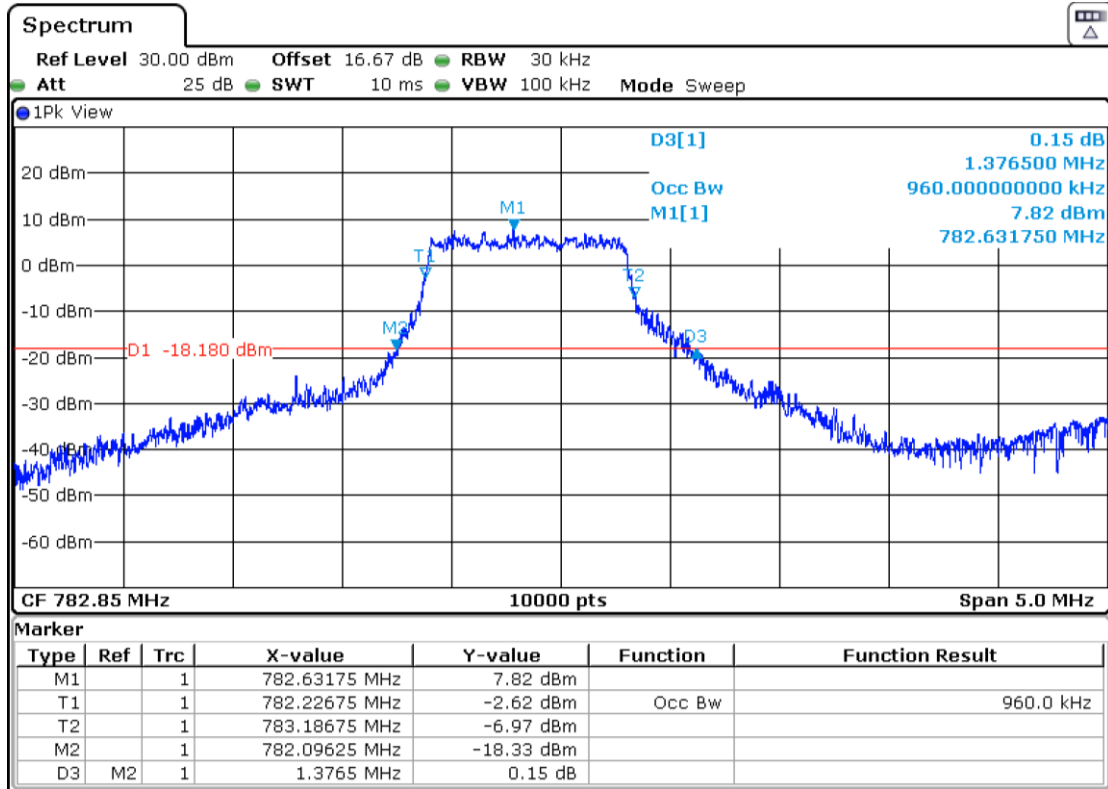

LTE Band 66. QPSK. Nominal Bandwidth 5 MHz. Narrowband = 0. Position 1.

Low Channel:

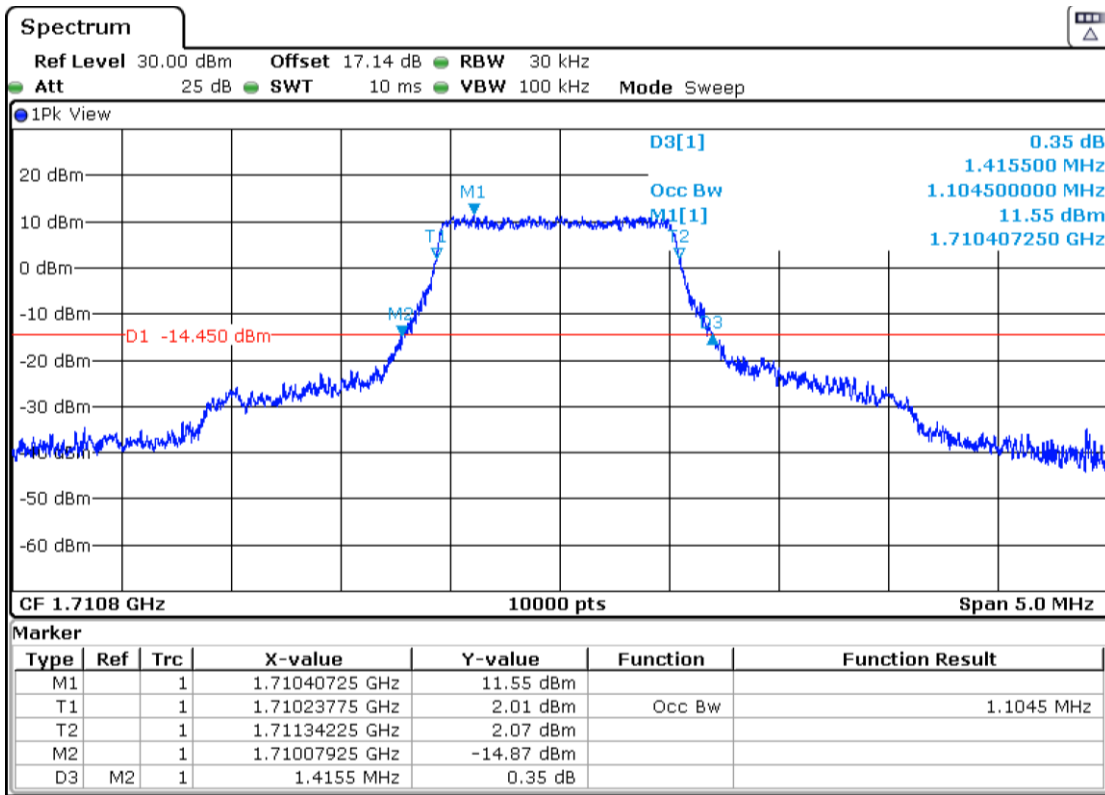

Middle Channel:

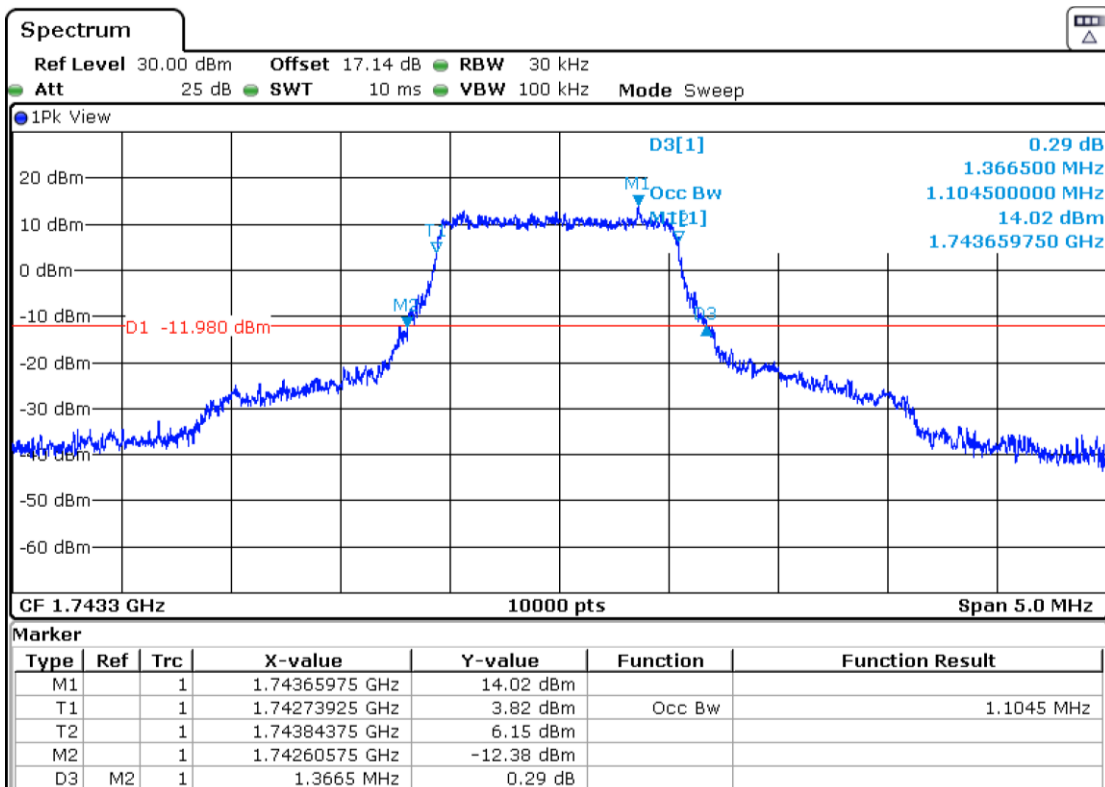

High Channel:

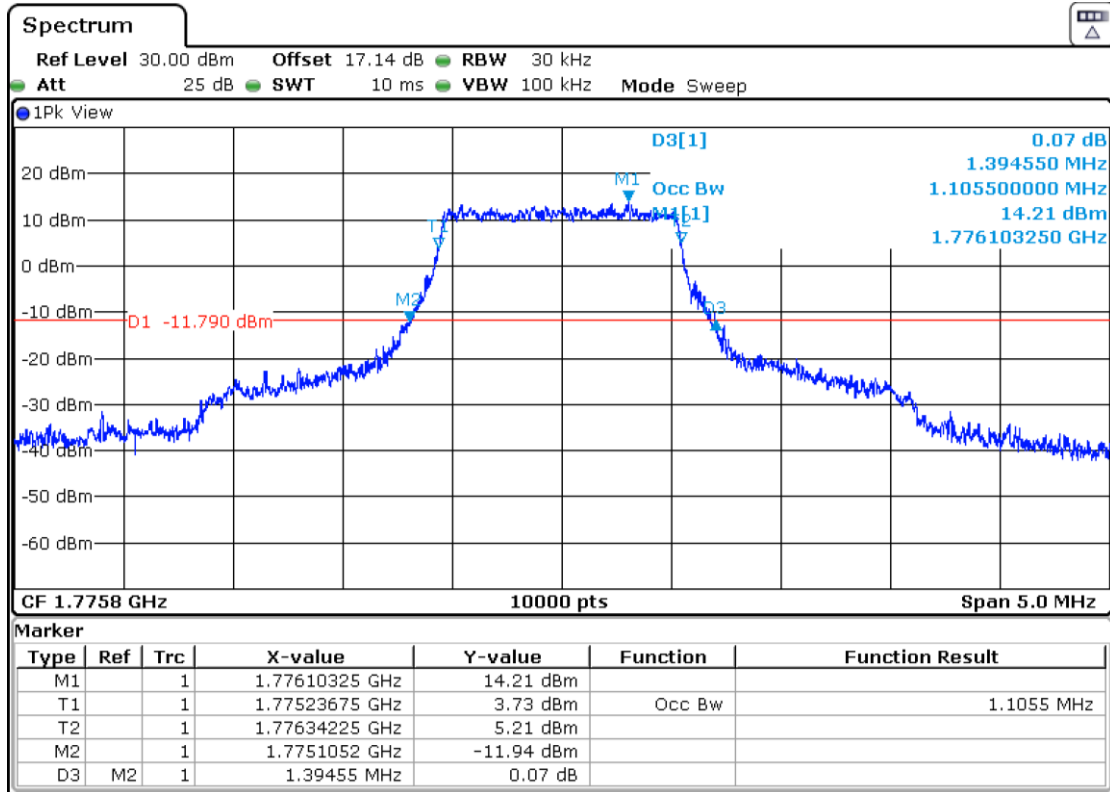

LTE Band 66. 16QAM. Nominal Bandwidth 5 MHz. Narrowband = 0. Position 1.

Low Channel:

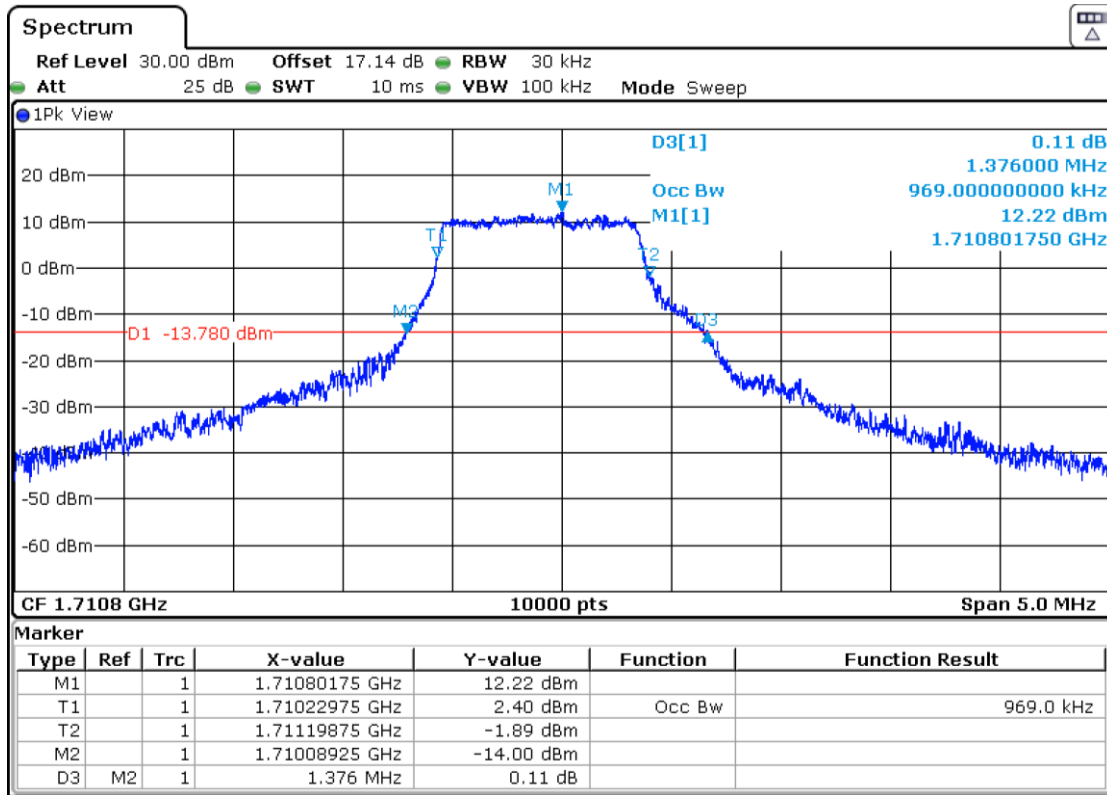

Middle Channel:

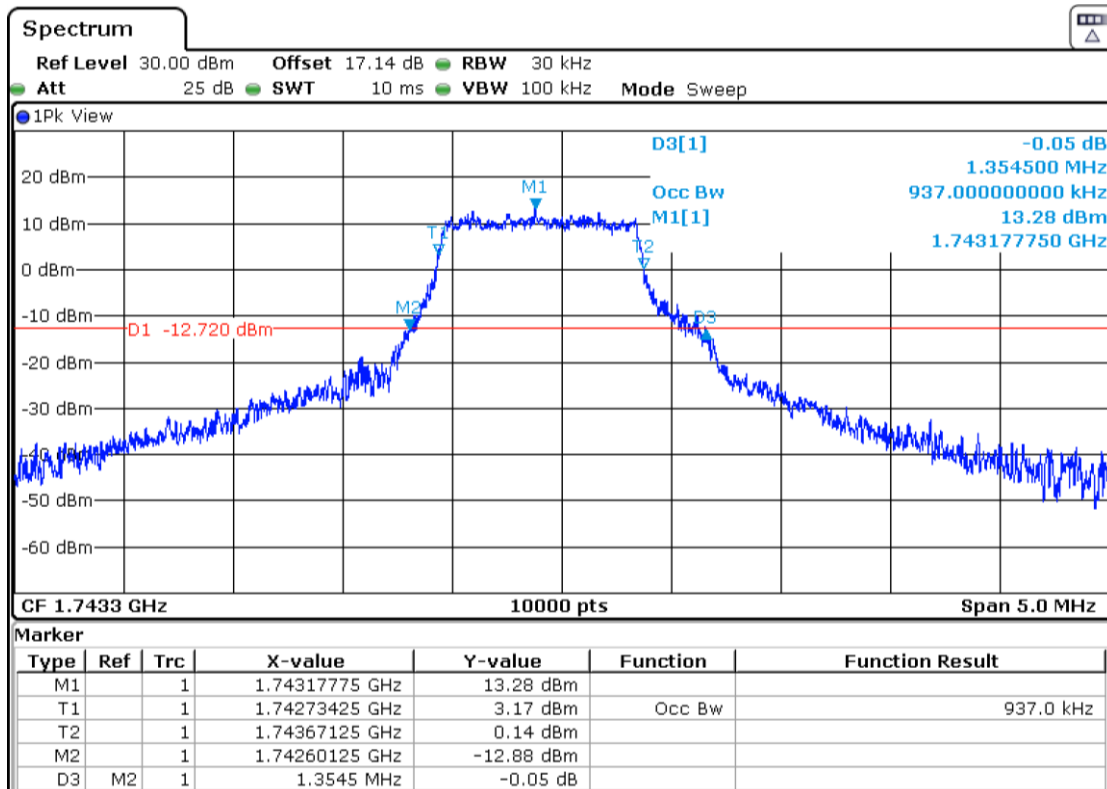

High Channel:

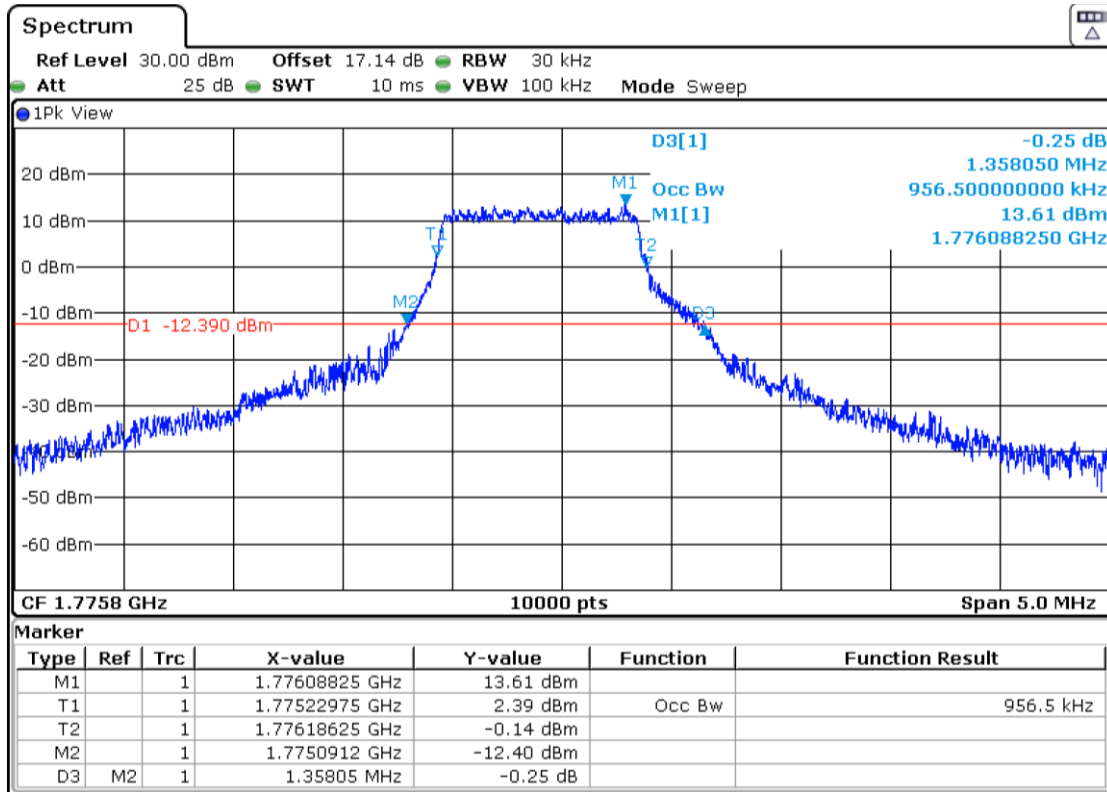

Spurious Emissions at Antenna Terminals

SPECIFICATION

FCC §27.53 (c):

On any frequency outside the 776-788 MHz band, the power of any emission shall be attenuated outside the band below the transmitter power (P) by at least $43 + 10 \log (P)$ dB. Compliance is based on the use of measurement instrumentation employing a resolution bandwidth of 100 kHz or greater.

On all frequencies between 763-775 MHz and 793-805 MHz, by a factor not less than $65 + 10 \log (P)$ dB in a 6.25 kHz band segment, for mobile and portable stations. Compliance is based on the use of measurement instrumentation such that the reading taken with any resolution bandwidth setting should be adjusted to indicate spectral energy in a 6.25 kHz segment.

FCC §27.53 (g):

For operations in the 600 MHz band and the 698-746 MHz band, the power of any emission outside a licensee's frequency band(s) of operation shall be attenuated below the transmitter power (P) within the licensed band(s) of operation, measured in watts, by at least $43 + 10 \log (P)$ dB. Compliance with this provision is based on the use of measurement instrumentation employing a resolution bandwidth of 100 kilohertz or greater.

RSS-130, Clause 4.7.1:

The unwanted emissions in any 100 kHz bandwidth on any frequency outside the low frequency edge and the high frequency edge of each frequency block range(s), shall be attenuated below the transmitter power, P (dBW), by at least $43 + 10 \log_{10} p$ (watts), dB.

RSS-130, Clause 4.7.2:

The power of any unwanted emissions in any 6.25 kHz bandwidth for all frequencies between 763-775 MHz and 793-806 MHz shall be attenuated below the transmitter power, P (dBW), by at least $65 + 10 \log_{10} p$ (watts), dB, for mobile and portable equipment.

FCC §27.53 (h), RSS-139, Clause 6.6:

According to specification, for operations in the 1695-1710 MHz, 1710-1755 MHz, 1755-1780 MHz, 1915-1920 MHz, 1995-2000 MHz, 2000-2020 MHz, 2110-2155 MHz, 2155-2180 MHz, and 2180-2200 bands, the power of any emission outside a licensee's frequency block shall be attenuated below the transmitter power (P) in watts by at least $43 + 10 \log_{10} (P)$ dB. Compliance with this provision is based on the use of measurement instrumentation employing a resolution bandwidth of 1 megahertz or greater.

At P_o transmitting power, the specified minimum attenuation becomes $43+10 \log (P_o)$, and the level in dBm relative to P_o becomes:

$$P_o \text{ (dBm)} - [43 + 10 \log (P_o \text{ in mW}) - 30] = -13 \text{ dBm}$$

At P_o transmitting power, the specified minimum attenuation becomes $65+10 \log (P_o)$, and the level in dBm relative to P_o becomes:

$$P_o \text{ (dBm)} - [65 + 10 \log (P_o \text{ in mW}) - 30] = -35 \text{ dBm}$$

METHOD

The EUT RF output connector was connected to a spectrum analyser and to the Universal Radio Communication tester R&S CMW500 (selecting maximum transmission power of the EUT and different modes of modulation) using a 50-Ohm attenuator and a power divider.

The spectrum was investigated from 9 kHz to 8 GHz for LTE Bands 12 & 13 and from 9 kHz to 18 GHz for LTE Band 66.

The reading of the spectrum analyser is corrected with the attenuation loss of connection between output terminal of EUT and input of the spectrum analyser.

The configuration of Resource Blocks and modulation which is the worst case for conducted power was used.

TEST SETUP

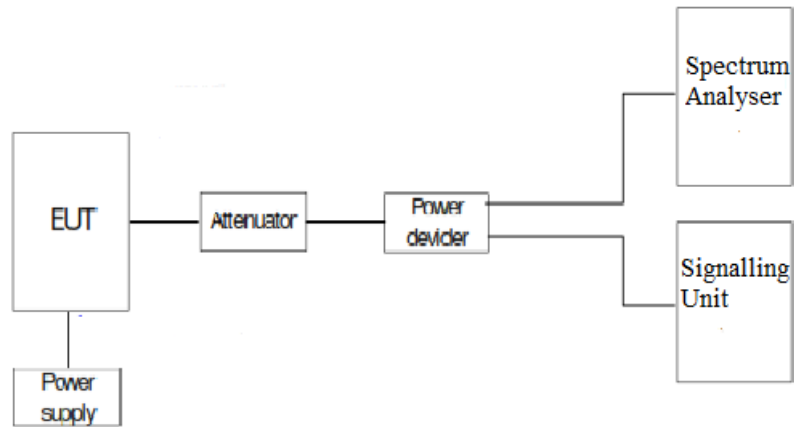

RESULTS:

LTE Band 12: QPSK. Nominal Bandwidth 5 MHz. RB Size 1, RB Offset 0. Narrowband = 0, Position 1.

- Low Channel: No spurious frequencies at less than 20 dB below the limit.
- Middle Channel: No spurious frequencies at less than 20 dB below the limit.
- High Channel: No spurious frequencies at less than 20 dB below the limit

LTE Band 13: QPSK. Nominal Bandwidth 5 MHz. RB Size 1, RB Offset 0. Narrowband = 0, Position 1.

- Low Channel: Spurious frequencies at less than 20 dB below the limit.

Spurious Frequency (MHz)	Emission Limitations Conducted (dBm)	Limit (dBm)
774.880	-43.27	-35

- Middle Channel: No spurious frequencies at less than 20 dB below the limit.

Spurious Frequency (MHz)	Emission Limitations Conducted (dBm)	Limit (dBm)
774.797	-54.97	-35

- High Channel: No spurious frequencies at less than 20 dB below the limit

LTE Band 66: QPSK. Nominal Bandwidth 20 MHz. RB Size 6, RB Offset 0. Narrowband = 0, Position 1.

- Low Channel: No spurious frequencies at less than 20 dB below the limit.
- Middle Channel: No spurious frequencies at less than 20 dB below the limit.
- High Channel: No spurious frequencies at less than 20 dB below the limit

Measurement uncertainty (dB): ± 2.76

Verdict: PASS

LTE Band 12. QPSK. Nominal Bandwidth 5 MHz. RB Size 1, RB Offset 0. Narrowband 0, Position 1.

Low Channel:

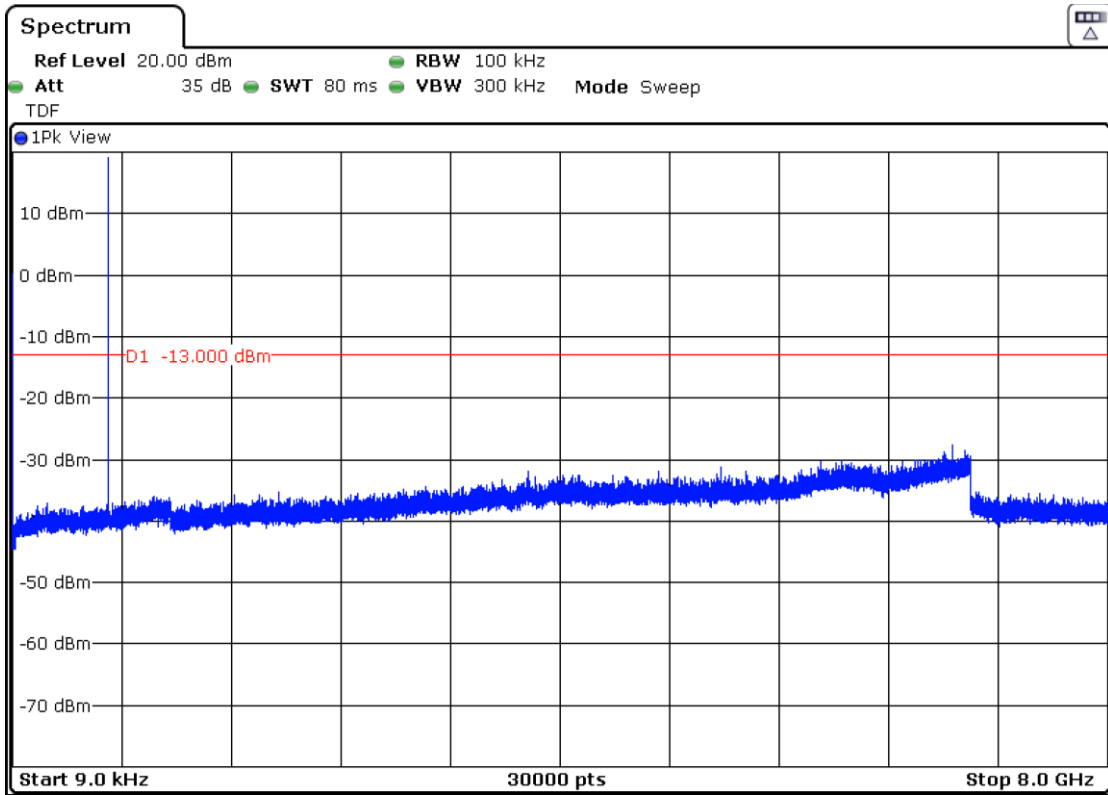

The peak above the limit is the carrier frequency.

Middle Channel:

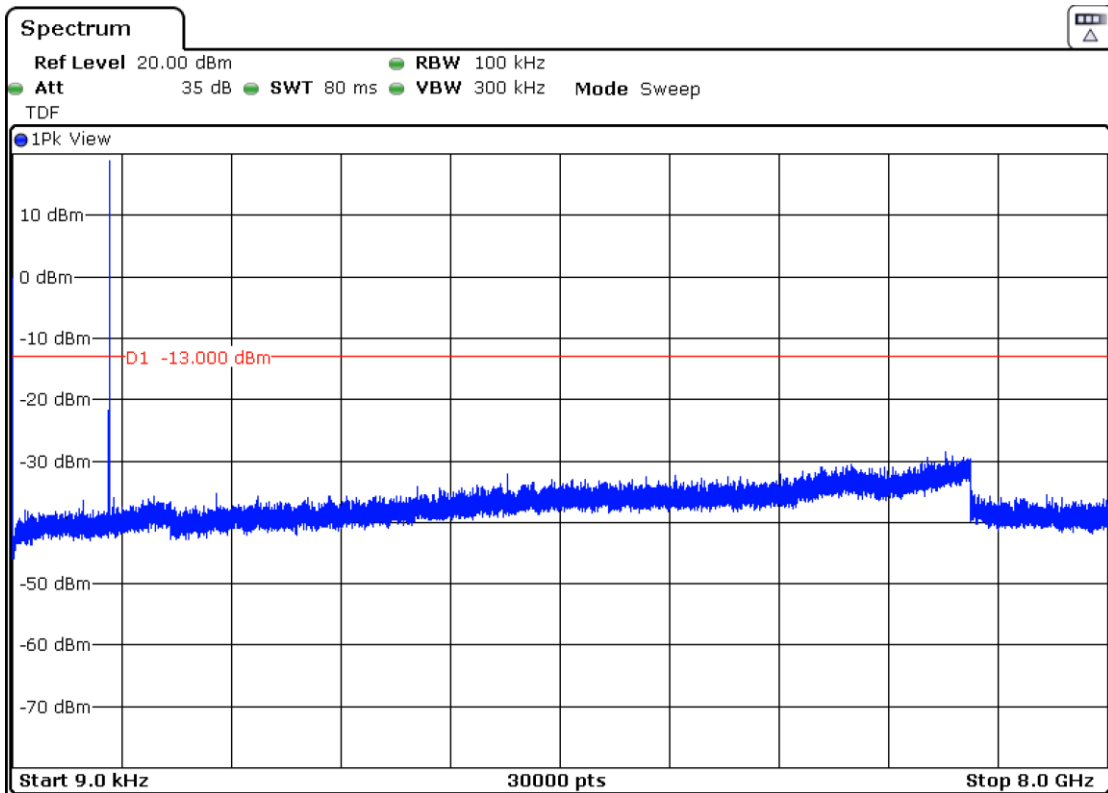

The peak above the limit is the carrier frequency.

High Channel:

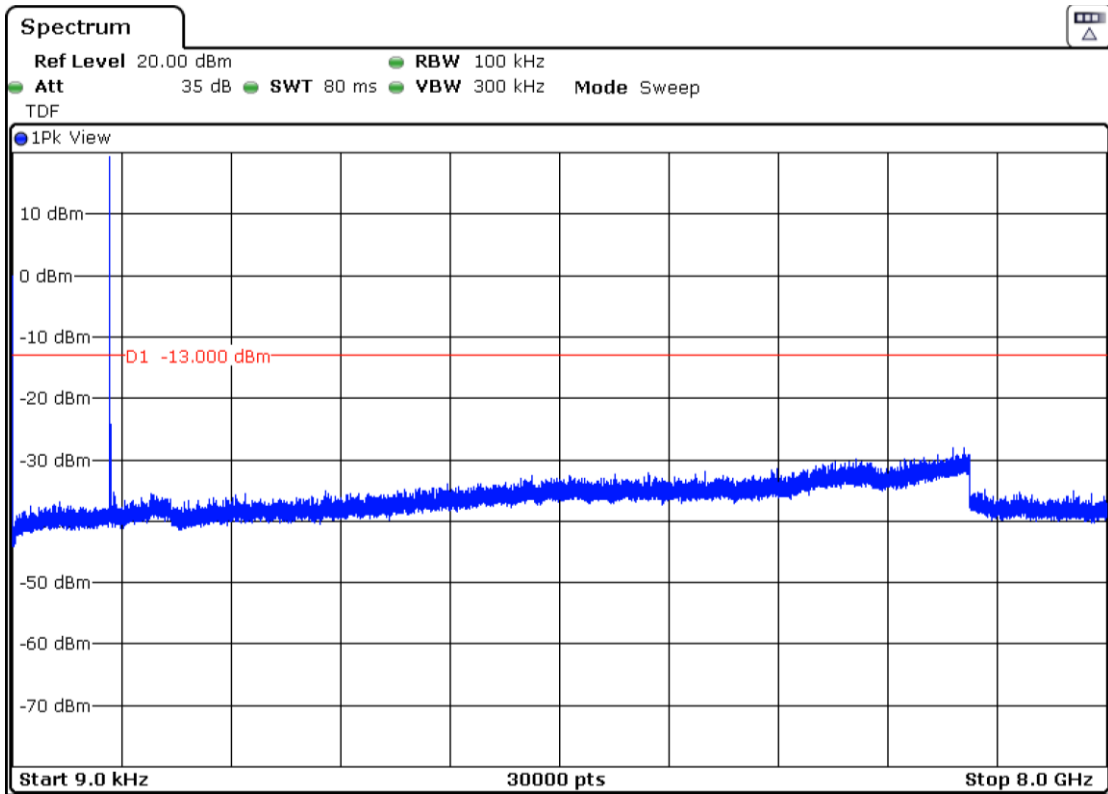

The peak above the limit is the carrier frequency.

LTE Band 13. QPSK. Nominal Bandwidth 5 MHz. RB Size 1, RB Offset 0. Narrowband 0, Position 1.

Low Channel:

- Frequency range 9 kHz – 8 GHz:

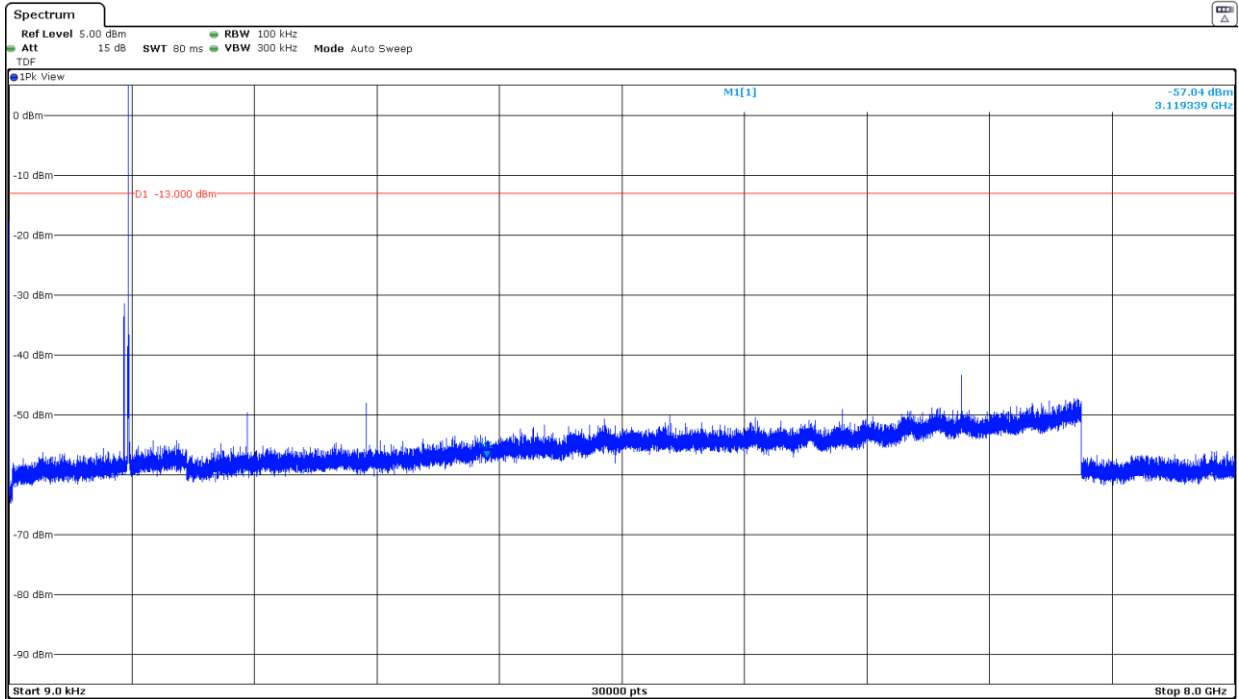

The peak above the limit is the carrier frequency.

- Frequency range 763 MHz – 775 MHz:

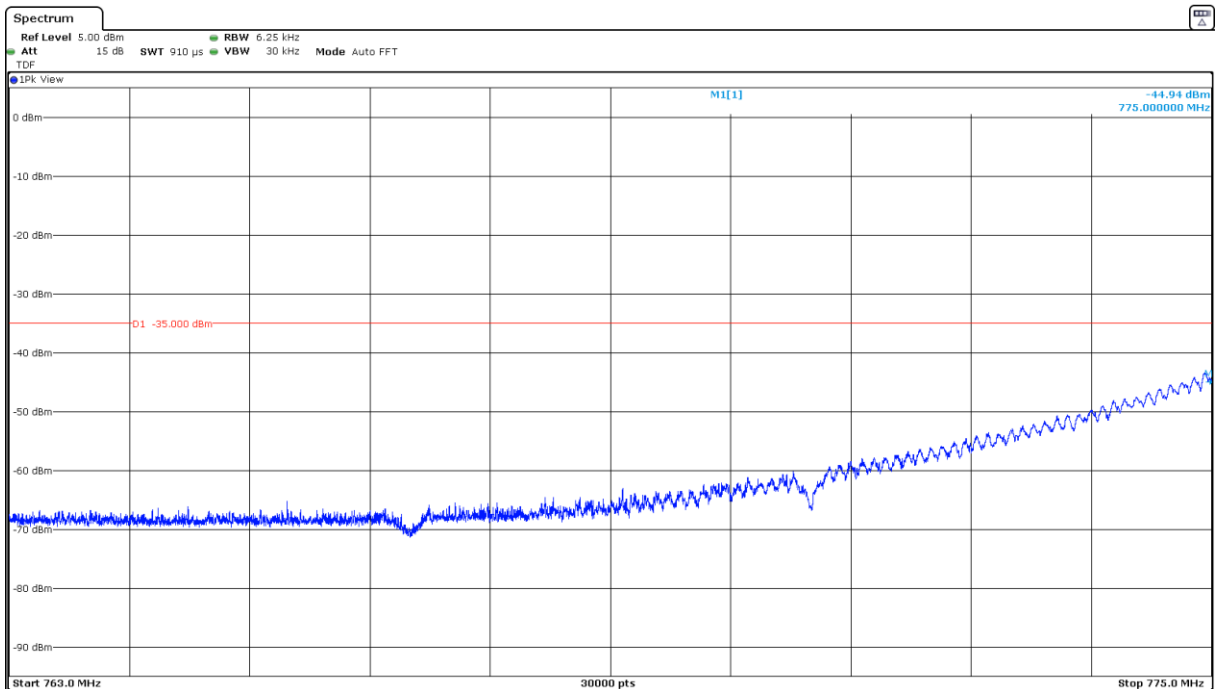

- Frequency range 793 MHz – 806 MHz:

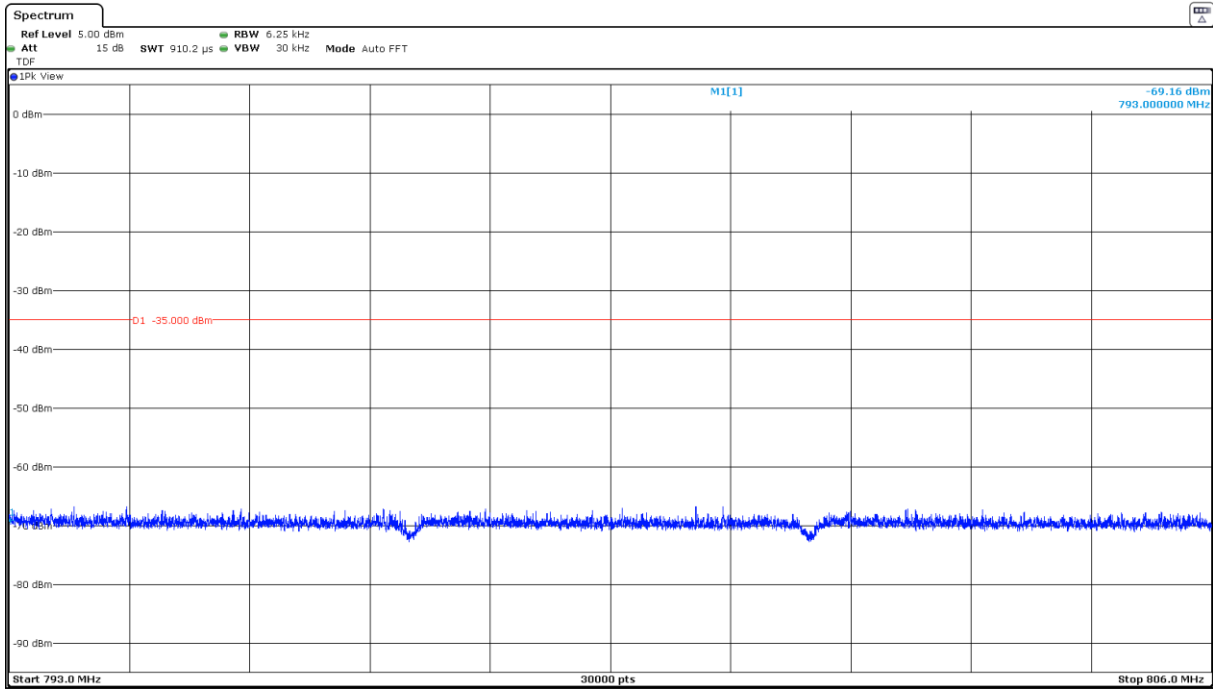

Middle Channel:

- Frequency range 9 kHz – 8 GHz:

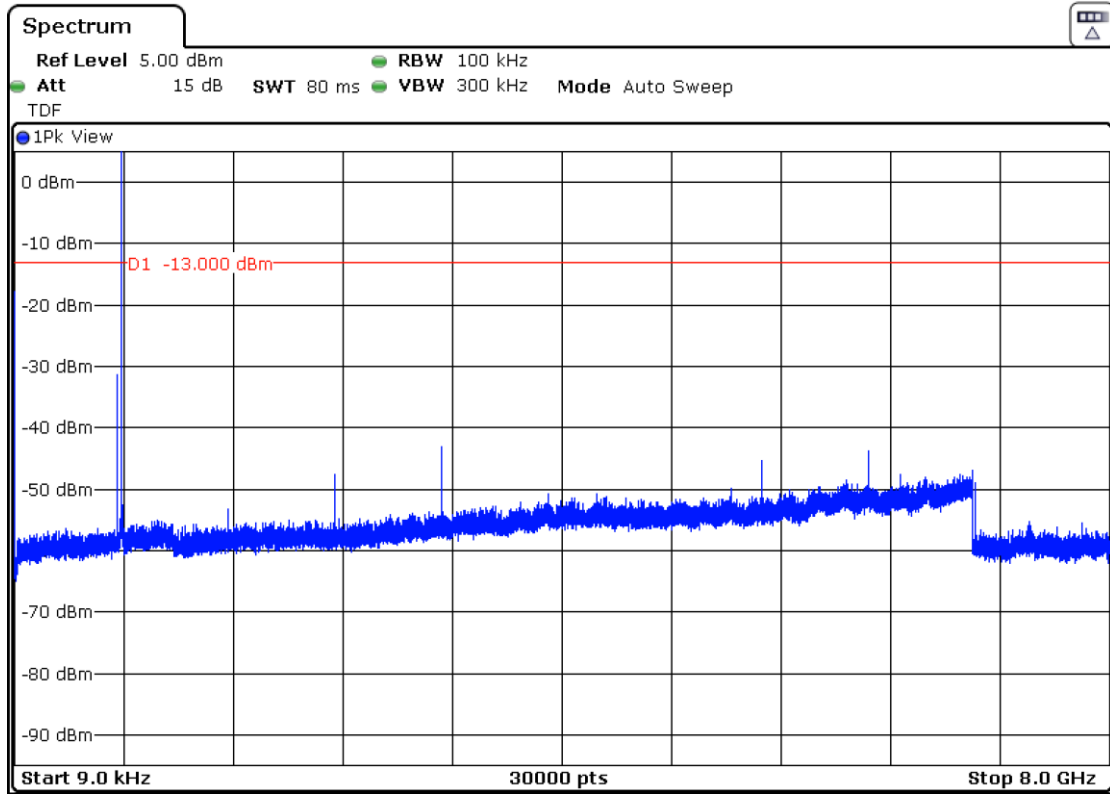

The peak above the limit is the carrier frequency.

- Frequency range 763 MHz – 775 MHz:

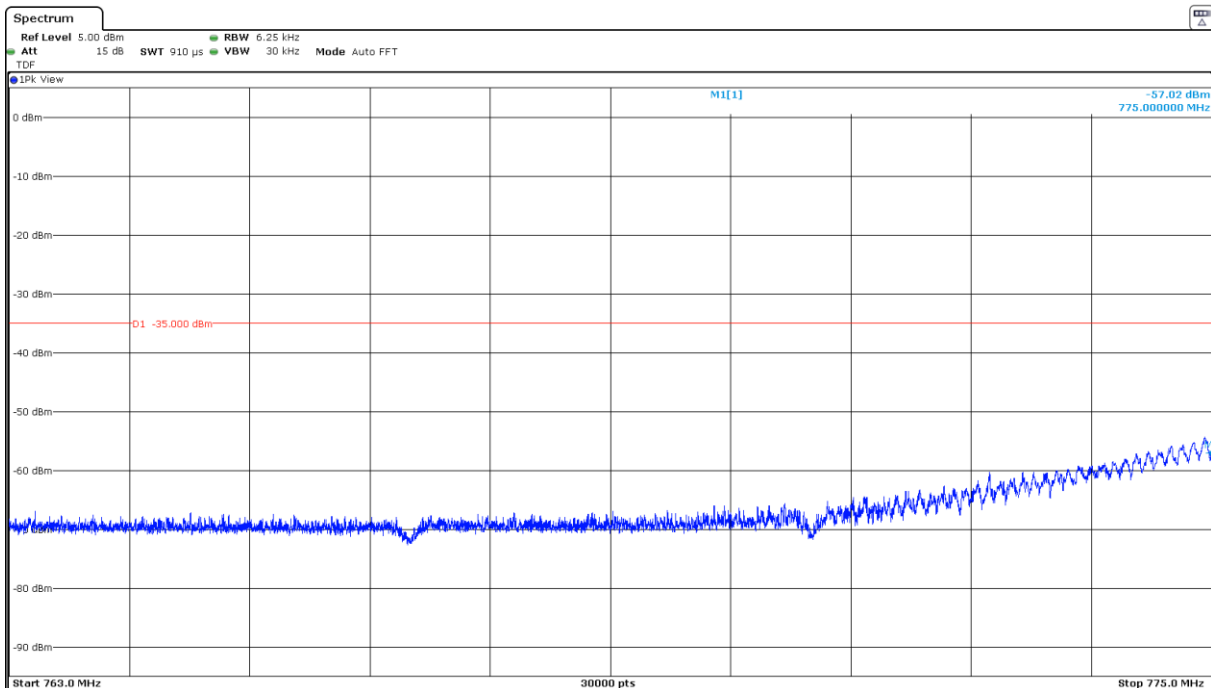

- Frequency range 793 MHz – 806 MHz:

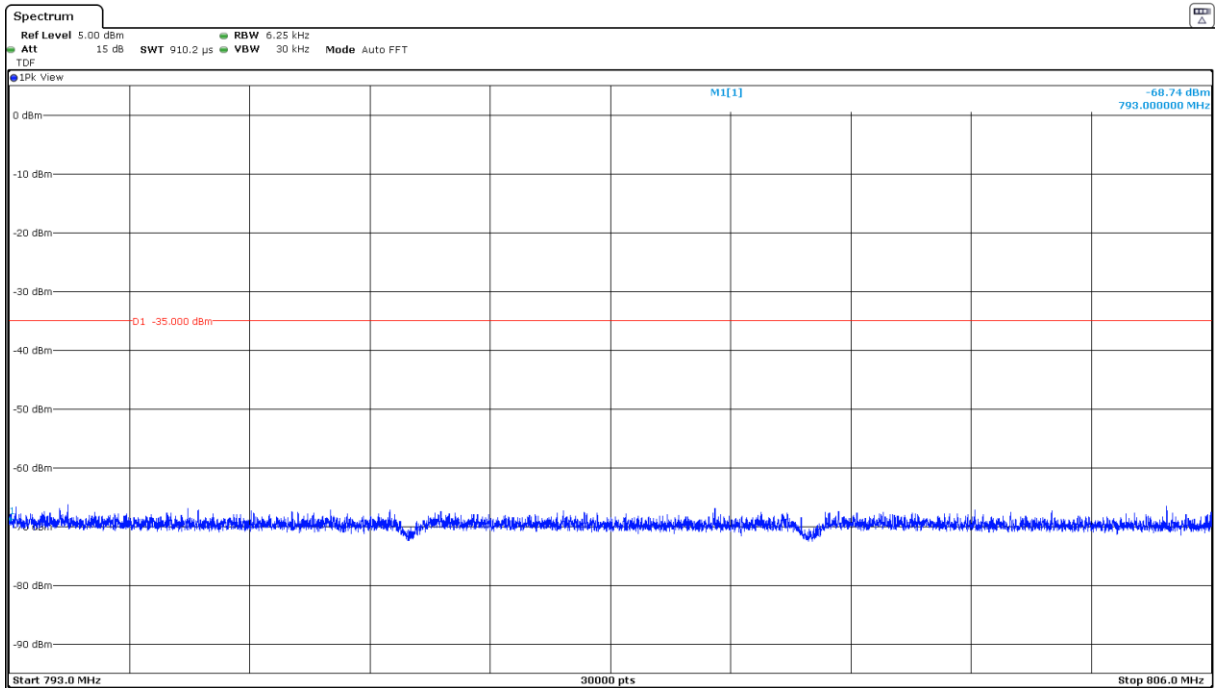

High Channel:

- Frequency range 9 kHz – 8 GHz:

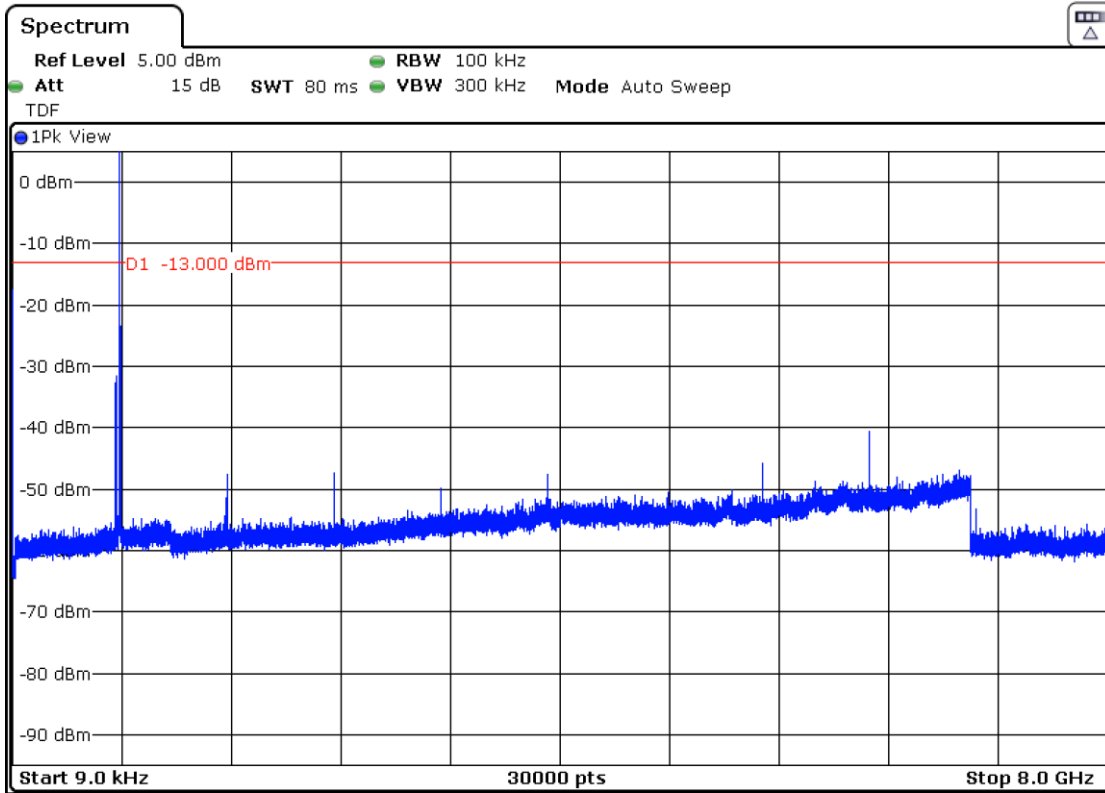

The peak above the limit is the carrier frequency.

- Frequency range 763 MHz – 775 MHz:

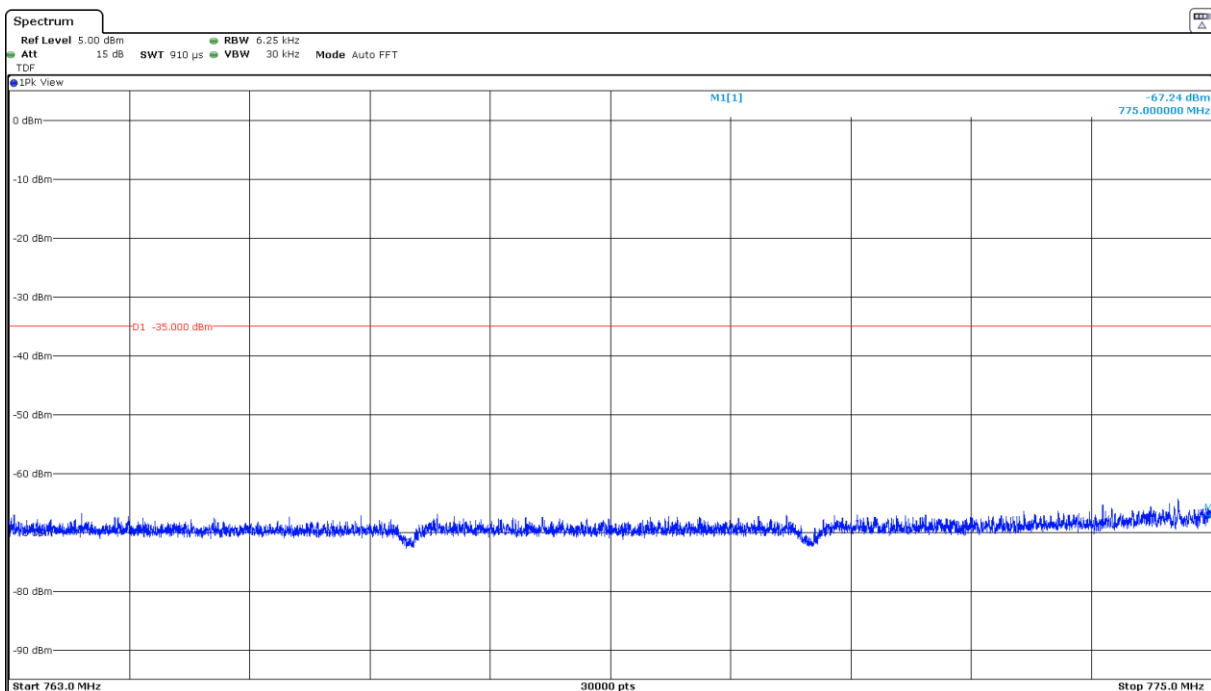

- Frequency range 793 MHz – 806 MHz:

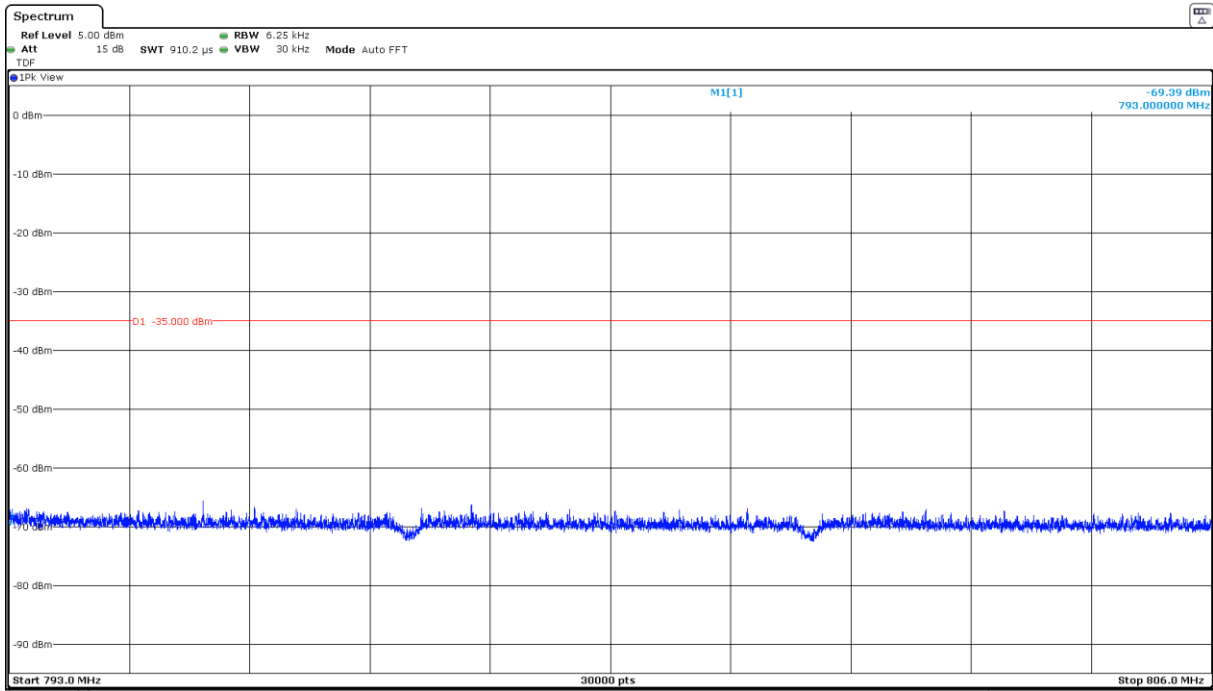

LTE Band 66. QPSK. Nominal Bandwidth 20 MHz. RB Size 1, RB Offset 0. Narrowband = 0, Position 1.

Low Channel:

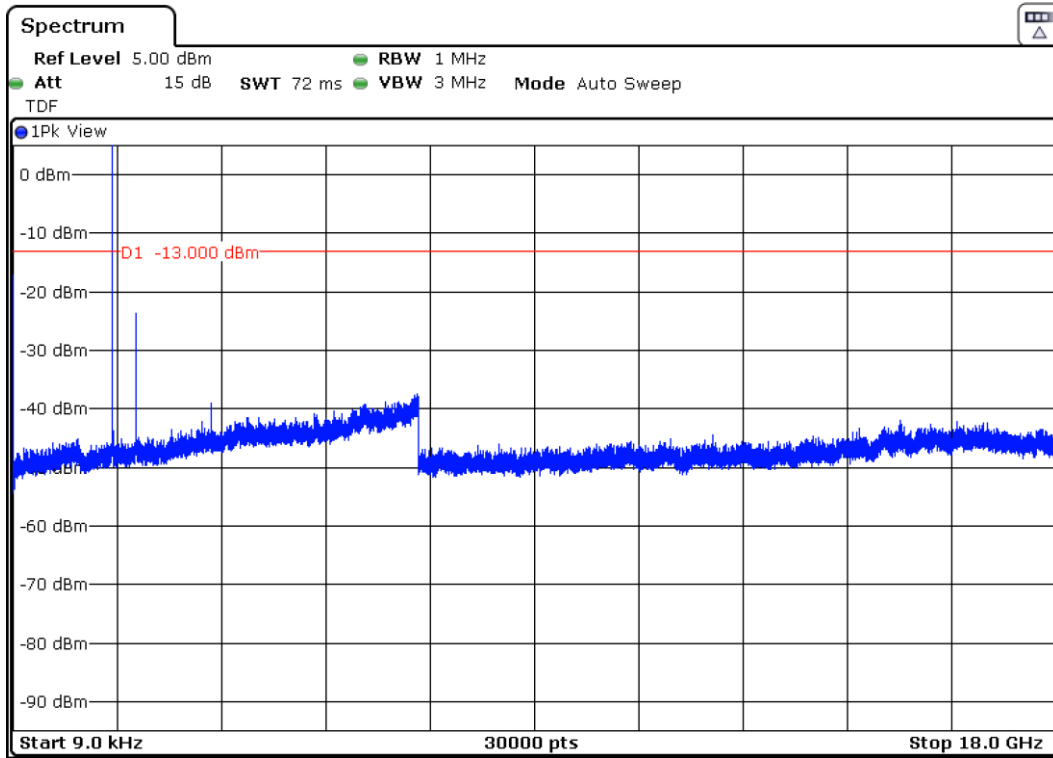

The peak above the limit is the carrier frequency.
 The highest peak next to the carrier is the Downlink frequency.

Middle Channel:

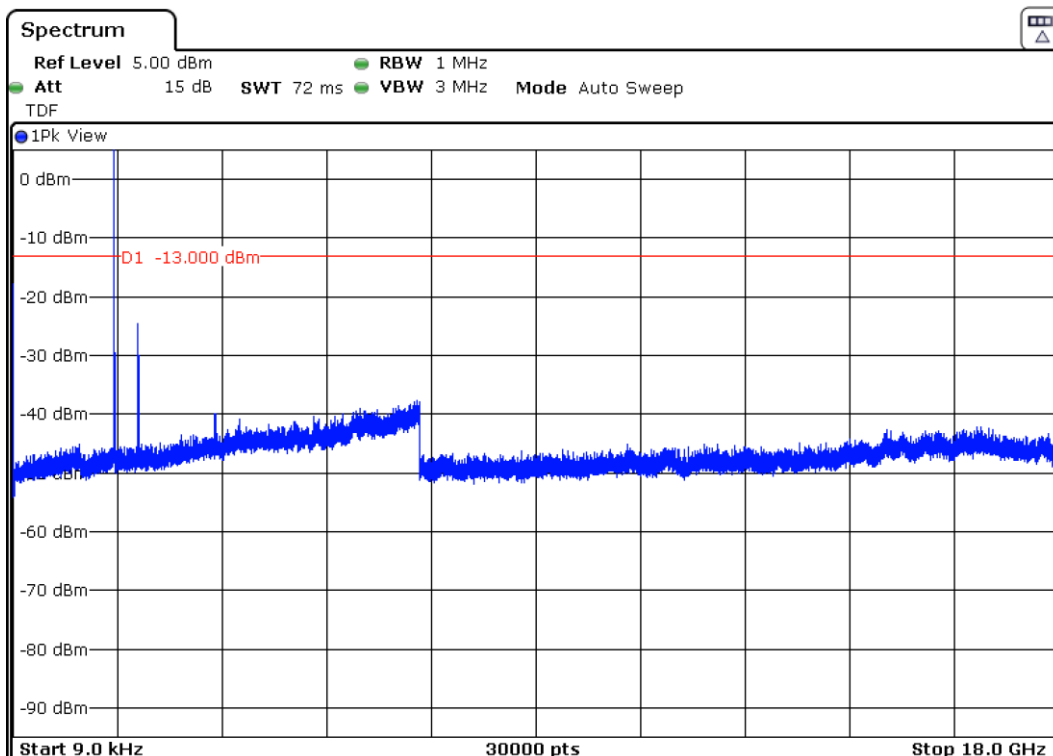

The peak above the limit is the carrier frequency.
 The highest peak next to the carrier is the Downlink frequency.

High Channel:

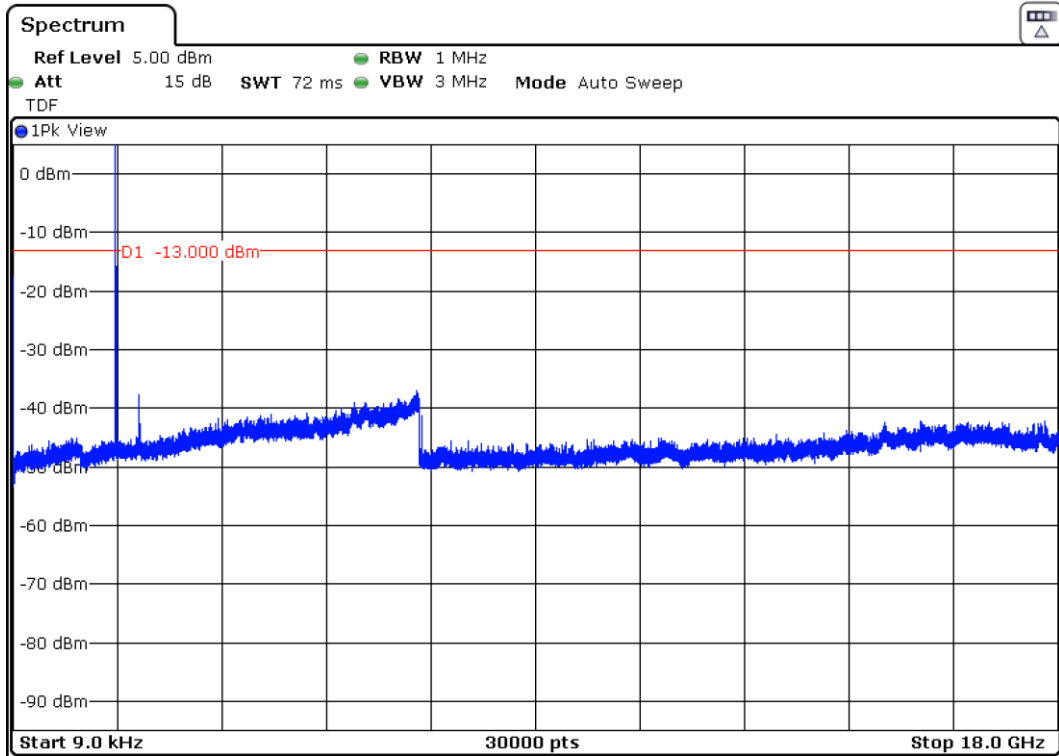

The peak above the limit is the carrier frequency.
The highest peak next to the carrier is the Downlink frequency.

Spurious Emissions at Antenna Terminals at Block Edges

SPECIFICATION

FCC §27.53 (c):

On any frequency outside the 776-788 MHz band, the power of any emission shall be attenuated outside the band below the transmitter power (P) by at least $43 + 10 \log (P)$ dB.

FCC §27.53 (g):

For operations in the 600 MHz band and the 698-746 MHz band, the power of any emission outside a licensee's frequency band(s) of operation shall be attenuated below the transmitter power (P) within the licensed band(s) of operation, measured in watts, by at least $43 + 10 \log (P)$ dB.

RSS-130 Clause 4.7.1:

The unwanted emissions in any 100 kHz bandwidth on any frequency outside the low frequency edge and the high frequency edge of each frequency block range(s), shall be attenuated below the transmitter power, P (dBW), by at least $43 + 10 \log_{10} p$ (watts), dB.

FCC §27.53 (h), RSS-139 Clause 6.6:

According to specification, for operations in the 1695-1710 MHz, 1710-1755 MHz, 1755-1780 MHz, 1915-1920 MHz, 1995-2000 MHz, 2000-2020 MHz, 2110-2155 MHz, 2155-2180 MHz, and 2180-2200 bands, the power of any emission outside a licensee's frequency block shall be attenuated below the transmitter power (P) in watts by at least $43 + 10 \log_{10} (P)$ dB.

At P_o transmitting power, the specified minimum attenuation becomes $43+10 \log (P_o)$, and the level in dBm relative to P_o becomes:

$$P_o \text{ (dBm)} - [43 + 10 \log (P_o \text{ in mW}) - 30] = -13 \text{ dBm}$$

METHOD

The EUT RF output connector was connected to a spectrum analyser and to the Universal Radio Communication tester R&S CMW500 (selecting maximum transmission power of the EUT and different modes of modulation) using a 50-Ohm attenuator and a power splitter.

The reading of the spectrum analyser is corrected with the attenuation loss of connection between output terminal of EUT and input of the spectrum analyser.

For LTE Bands 4 and 66, as stated in FCC part 27.53 (h) (3) / RSS-139 Clause 6.6, in the 1 MHz bands immediately outside and adjacent to the licensee's frequency block, a resolution bandwidth of at least one percent of the emission bandwidth of the fundamental emission of the transmitter may be employed.

For LTE Band 12, as stated in FCC part 27.53 (g) / RSS-130 Clause 4.7.1, in the 100 kHz bands immediately outside and adjacent to the licensee's frequency block or band, a resolution bandwidth of 30 kHz may be employed.

For LTE Bands 12 and 13, as stated in FCC part 27.53 (c) (5) / RSS-130 Clause 4.7.1, in the 100 kHz bands immediately outside and adjacent to the frequency block, a resolution bandwidth of at least 30 kHz may be employed.

TEST SETUP

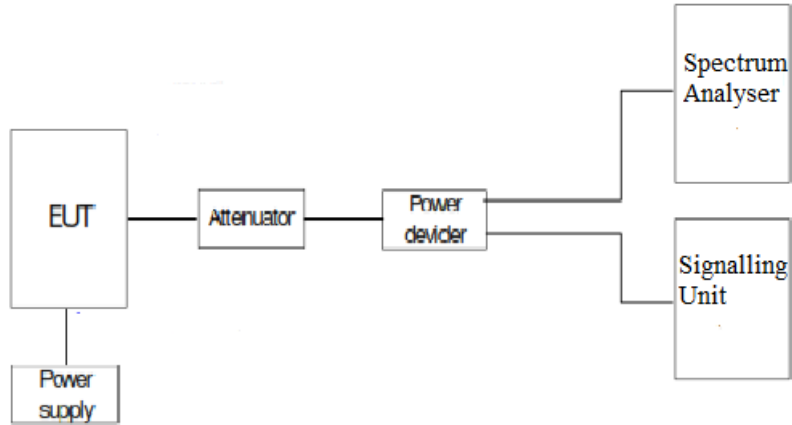

RESULTS:

LTE Band 4:

Preliminary measurements determined QPSK as the worst-case modulation in terms of band edge results. The next results are for this worst-case configuration.

High Block Edge. Narrowband = Max.

LTE QPSK MODULATION:	RB=1. Offset=Max. BW = 5 MHz	RB=1. Offset=Max. BW = 10 MHz	RB=1. Offset=Max. BW = 15 MHz	RB=1. Offset=Max. BW = 20 MHz
Maximum measured level at <u>Highest Block Edge</u> at antenna port (dBm)	-19.00	-28.38	-30.96	-38.69

LTE QPSK MODULATION:	RB = All. Offset = 0. BW = 5 MHz	RB = All. Offset = 0. BW = 10 MHz	RB = All. Offset = 0. BW = 15 MHz	RB = All. Offset = 0. BW = 20 MHz
Maximum measured level at <u>Highest Block Edge</u> at antenna port (dBm)	-22.84	-28.01	-24.70	-39.60

LTE Band 12:

Preliminary measurements determined QPSK as the worst-case modulation in terms of band edge results. The next results are for this worst-case configuration.

Low Block Edge. Narrowband = 0.

LTE QPSK MODULATION:	RB=1. Offset = 0. BW = 5 MHz	RB=1. Offset = 0. BW = 10 MHz
Maximum measured level at <u>Lowest Block Edge</u> at antenna port (dBm)	-35.72	-39.70

LTE QPSK MODULATION:	RB = All. Offset = 0. BW = 5 MHz	RB = All. Offset = 0. BW = 10 MHz
Maximum measured level at <u>Lowest Block Edge</u> at antenna port (dBm)	-30.21	-38.22

High Block Edge. Narrowband = Max.

LTE QPSK MODULATION:	RB=1. Offset=Max. BW = 5 MHz	RB=1. Offset=Max. BW = 10 MHz
Maximum measured level at <u>Highest Block Edge</u> at antenna port (dBm)	-19.04	-22.77

LTE QPSK MODULATION:	RB = All. Offset = 0. BW = 5 MHz	RB = All. Offset = 0. BW = 10 MHz
Maximum measured level at <u>Highest Block Edge</u> at antenna port (dBm)	-22.05	-20.62

LTE Band 13:

Preliminary measurements determined QPSK as the worst-case modulation in terms of band edge results. The next results are for this worst-case configuration.

Low Block Edge. Narrowband = 0.

LTE QPSK MODULATION:	RB=1. Offset = 0. BW = 5 MHz	RB=1. Offset = 0. BW = 10 MHz
Maximum measured level at <u>Lowest</u> Block Edge at antenna port (dBm)	-17.76	-19.02

LTE QPSK MODULATION:	RB = All. Offset = 0. BW = 5 MHz	RB = All. Offset = 0. BW = 10 MHz
Maximum measured level at <u>Lowest</u> Block Edge at antenna port (dBm)	-18.52	-16.80

High Block Edge. Narrowband = Max.

LTE QPSK MODULATION:	RB=1. Offset=Max. BW = 5 MHz	RB=1. Offset=Max. BW = 10 MHz
Maximum measured level at <u>Highest</u> Block Edge at antenna port (dBm)	-19.53	-22.46

LTE QPSK MODULATION:	RB = All. Offset = 0. BW = 5 MHz	RB = All. Offset = 0. BW = 10 MHz
Maximum measured level at <u>Highest</u> Block Edge at antenna port (dBm)	-20.26	-17.41

LTE Band 17:

Preliminary measurements determined QPSK as the worst-case modulation in terms of band edge results. The next results are for this worst-case configuration.

Low Block Edge. Narrowband = 0.

LTE QPSK MODULATION:	RB=1. Offset = 0. BW = 5 MHz	RB=1. Offset = 0. BW = 10 MHz
Maximum measured level at <u>Lowest Block Edge</u> at antenna port (dBm)	-14.35	-21.51

LTE QPSK MODULATION:	RB = All. Offset = 0. BW = 5 MHz	RB = All. Offset = 0. BW = 10 MHz
Maximum measured level at <u>Lowest Block Edge</u> at antenna port (dBm)	-22.20	-19.00

LTE Band 66:

Preliminary measurements determined QPSK as the worst-case modulation in terms of band edge results. The next results are for this worst-case configuration.

Low Block Edge. Narrowband = 0.

LTE QPSK MODULATION:	RB=1. Offset = 0. BW = 5 MHz	RB=1. Offset = 0. BW = 10 MHz	RB=1. Offset = 0. BW = 15 MHz	RB=1. Offset = 0. BW = 20 MHz
Maximum measured level at <u>Lowest Block Edge</u> at antenna port (dBm)	-18.99	-29.85	-33.17	-38.78

LTE QPSK MODULATION:	RB = All. Offset = 0. BW = 5 MHz	RB = All. Offset = 0. BW = 10 MHz	RB = All. Offset = 0. BW = 15 MHz	RB = All. Offset = 0. BW = 20 MHz
Maximum measured level at <u>Lowest Block Edge</u> at antenna port (dBm)	-26.72	-29.09	-29.03	-36.15

High Block Edge. Narrowband = Max.

LTE QPSK MODULATION:	RB=1. Offset=Max. BW = 5 MHz	RB=1. Offset=Max. BW = 10 MHz	RB=1. Offset=Max. BW = 15 MHz	RB=1. Offset=Max. BW = 20 MHz
Maximum measured level at <u>Highest Block Edge</u> at antenna port (dBm)	-21.94	-31.73	-34.30	-39.81

LTE QPSK MODULATION:	RB = All. Offset =0. BW = 5 MHz	RB = All. Offset =0. BW = 10 MHz	RB = All. Offset =0. BW = 15 MHz	RB = All. Offset =0. BW = 20 MHz
Maximum measured level at <u>Highest Block Edge</u> at antenna port (dBm)	-25.27	-29.35	-27.04	-38.38

Measurement uncertainty: $\pm 2.76\text{ dB}$

Verdict: PASS

LTE Band 4:

LTE Band 4. QPSK MODULATION. BW=5 MHz. RB=1. Offset=Max. Narrowband=3. High Block Edge:

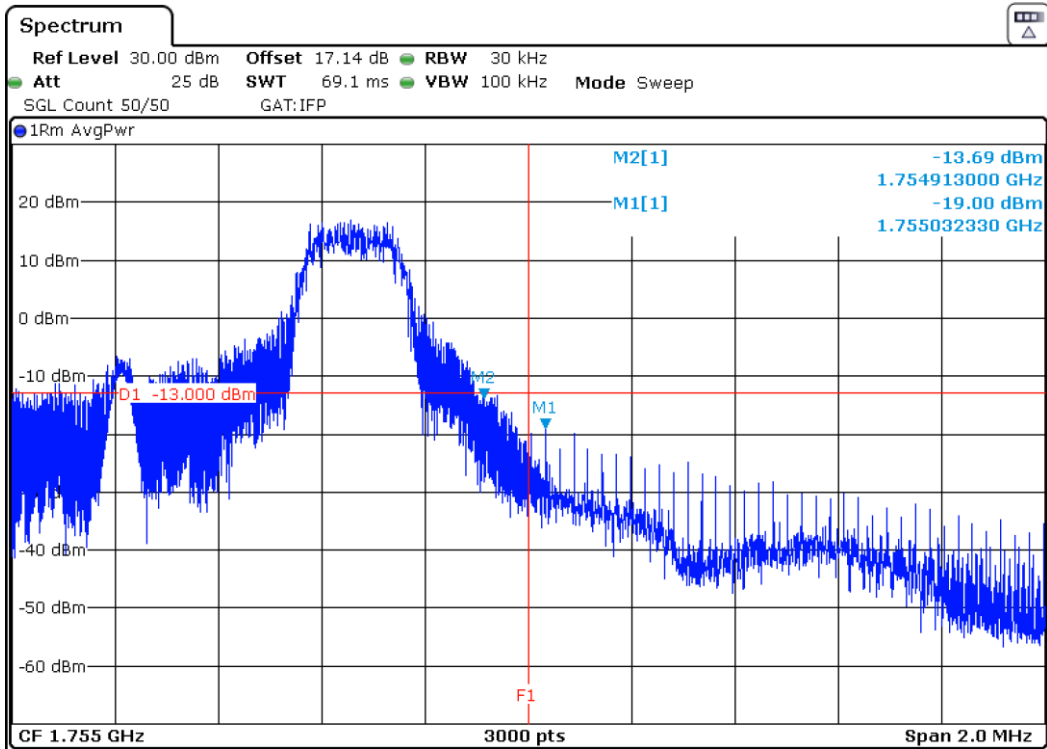

The equipment transmits at the maximum output power

LTE Band 4. QPSK MODULATION. BW=5 MHz. RB=All. Offset=0. Narrowband=3. High Block Edge:

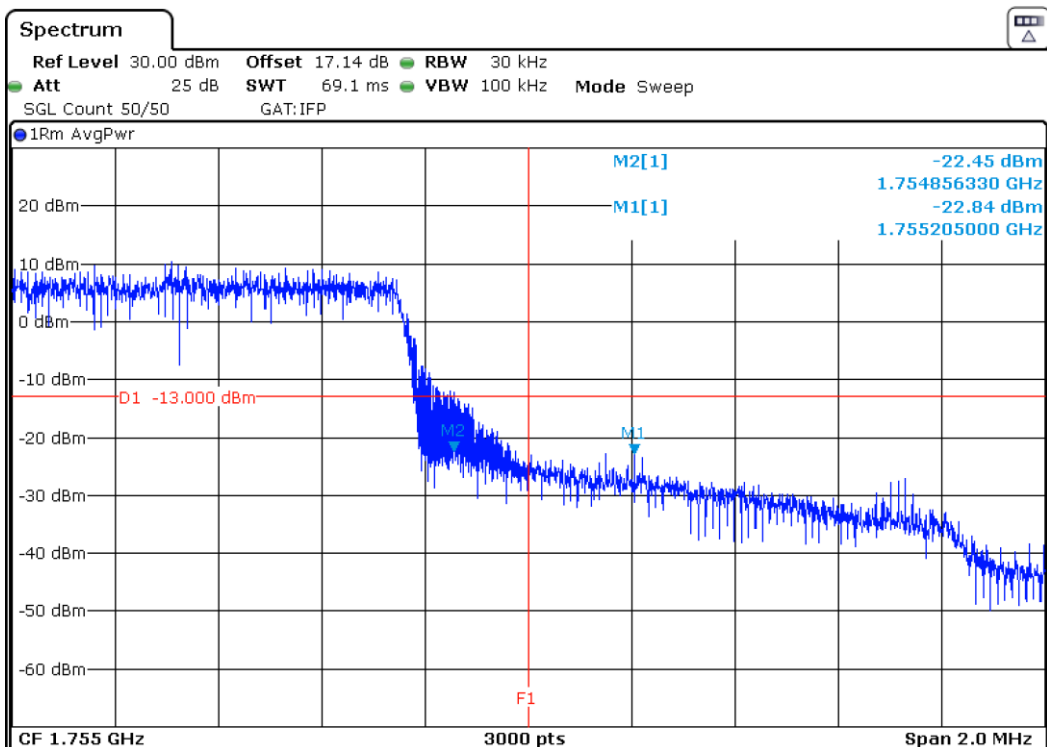

The equipment transmits at the maximum output power

LTE Band 4. QPSK MODULATION. BW=10 MHz. RB=1. Offset=Max. Narrowband=7. High Block Edge:

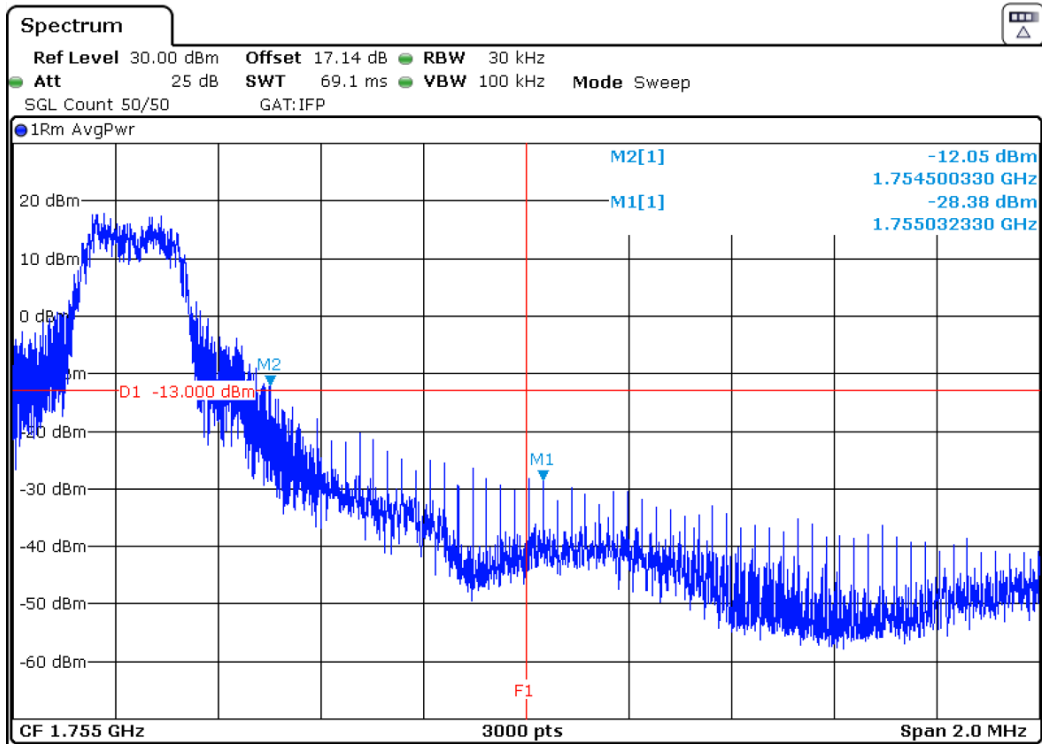

The equipment transmits at the maximum output power

LTE Band 4. QPSK MODULATION. BW=10 MHz. RB=All. Offset=0. Narrowband=7. High Block Edge:

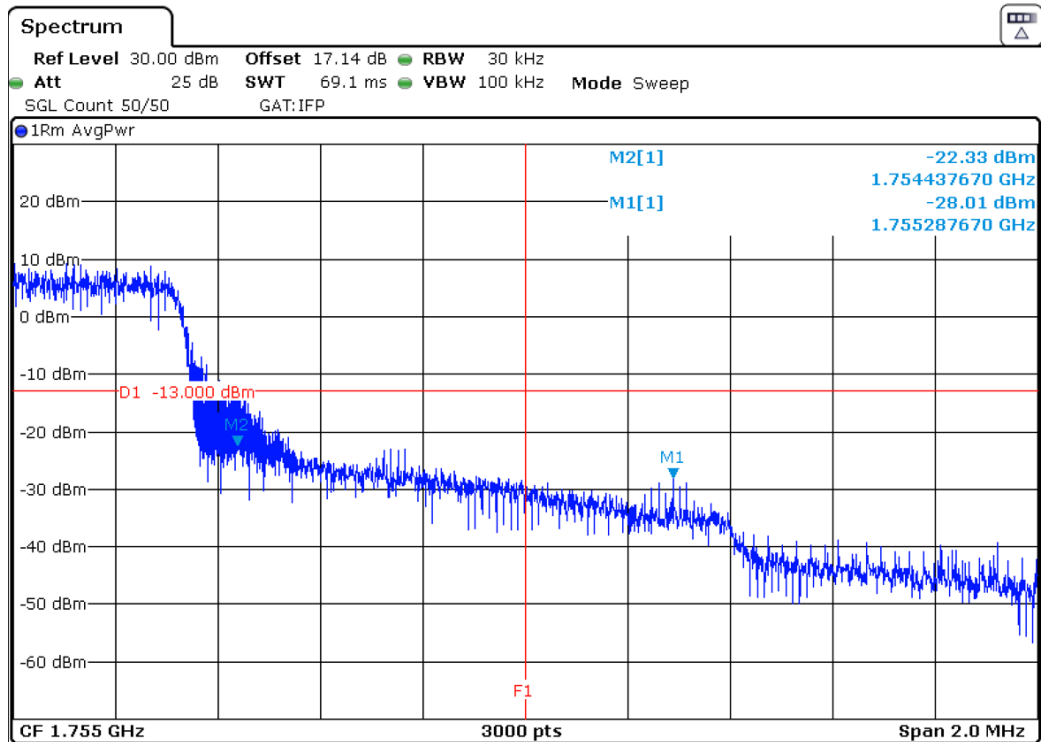

The equipment transmits at the maximum output power

LTE Band 4. QPSK MODULATION. BW=15 MHz. RB=1. Offset=Max. Narrowband=11. High Block Edge:

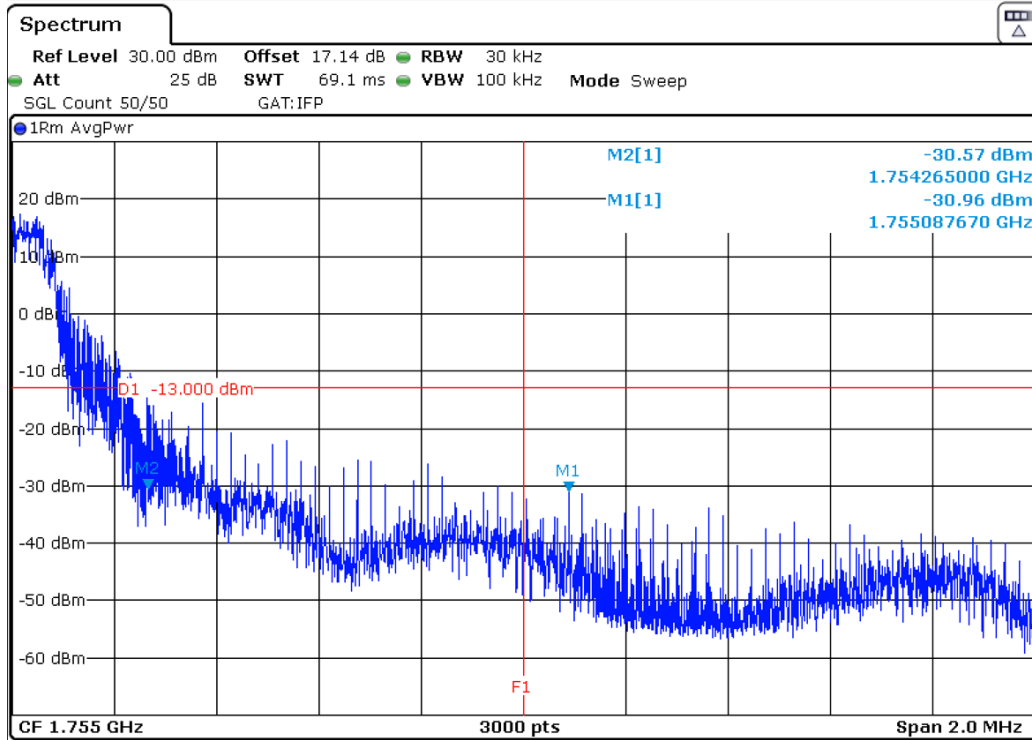

The equipment transmits at the maximum output power

LTE Band 4. QPSK MODULATION. BW=15 MHz. RB=All. Offset=0. Narrowband=11. High Block Edge:

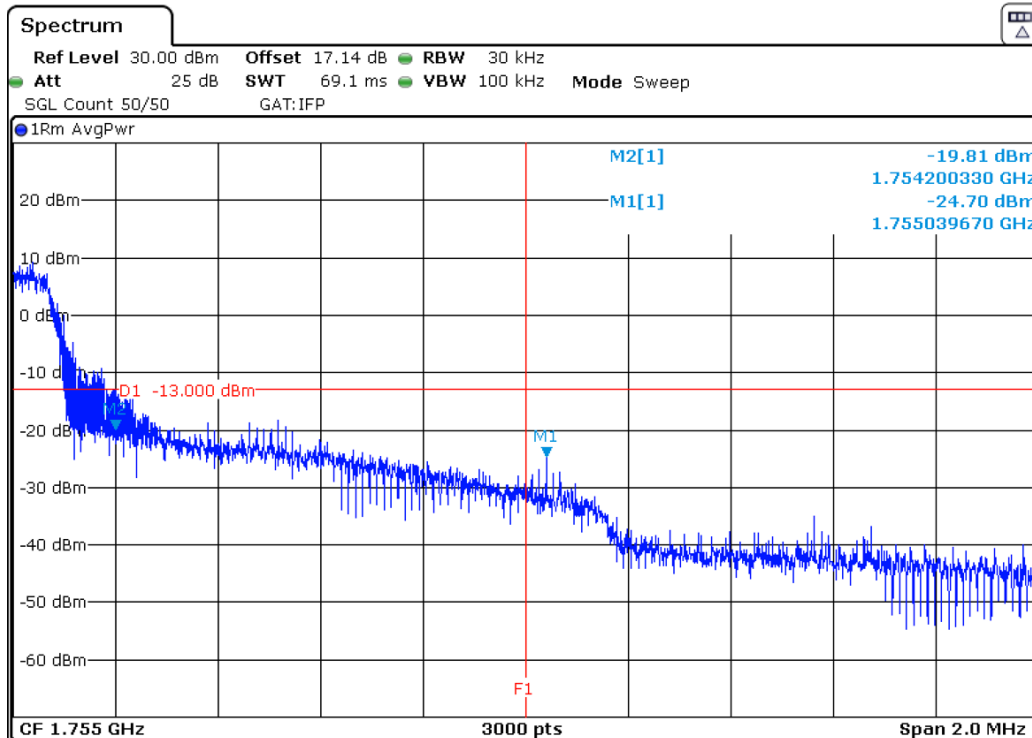

The equipment transmits at the maximum output power

LTE Band 4. QPSK MODULATION. BW=20 MHz. RB=1. Offset=Max. Narrowband=15. High Block Edge:

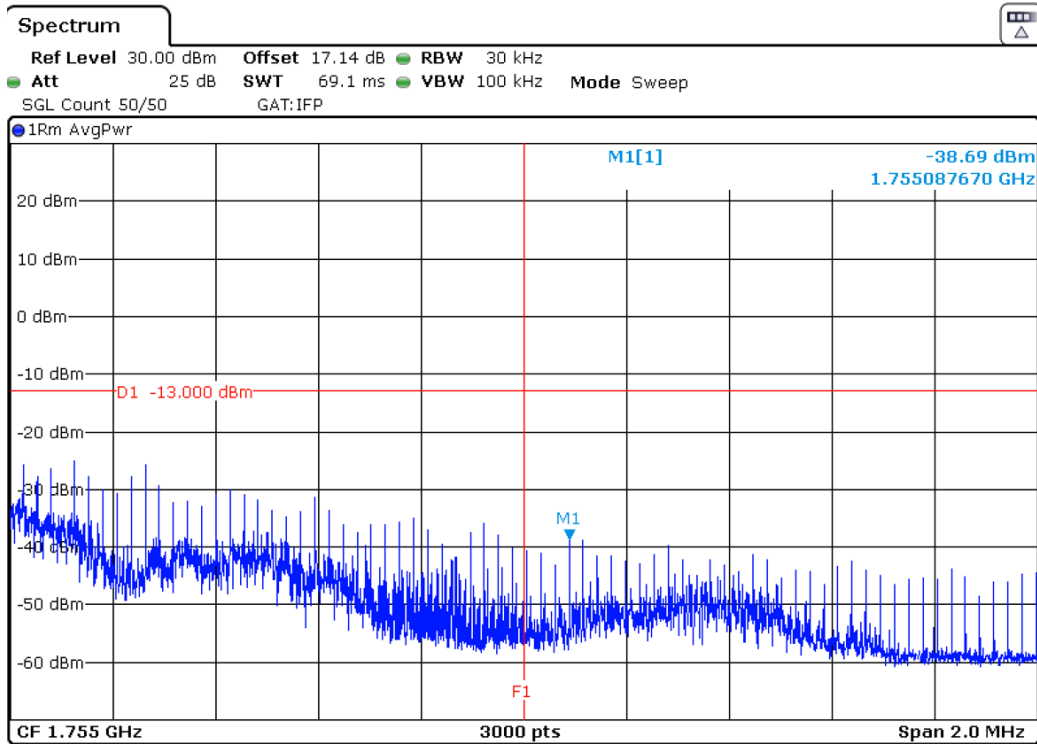

The equipment transmits at the maximum output power

LTE Band 4. QPSK MODULATION. BW=20 MHz. RB=All. Offset=0. Narrowband=15. High Block Edge:

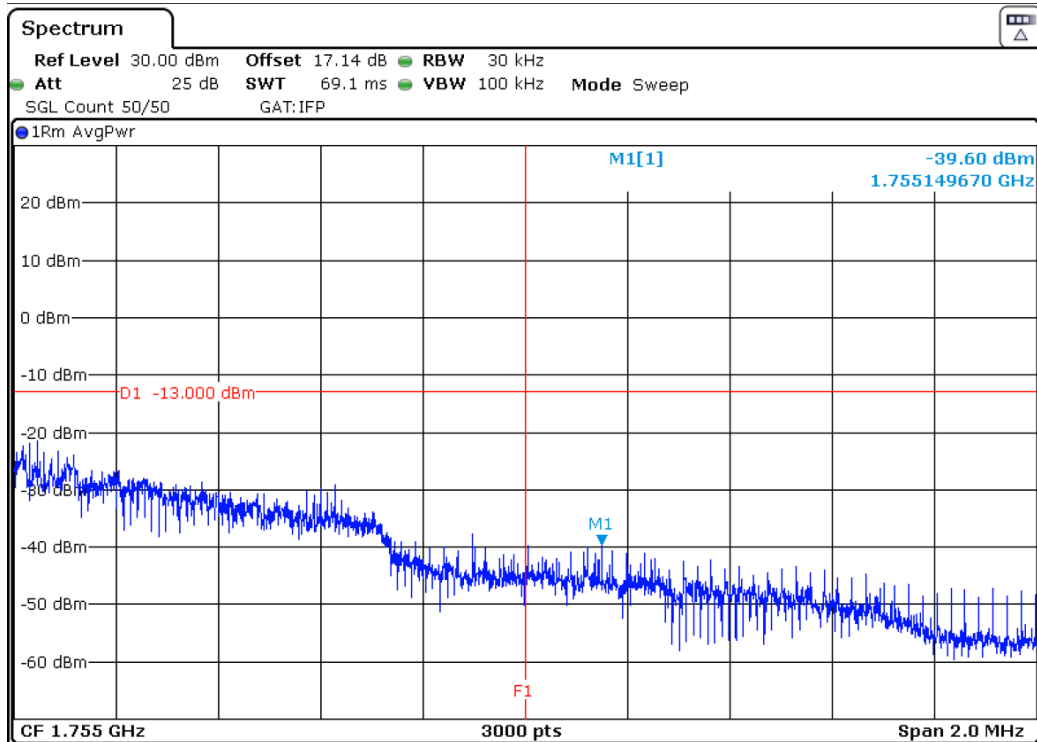

The equipment transmits at the maximum output power

LTE Band 12:

LTE Band 12. QPSK MODULATION. BW=5 MHz. RB=1. Offset=0. Narrowband=0. Low Block Edge:

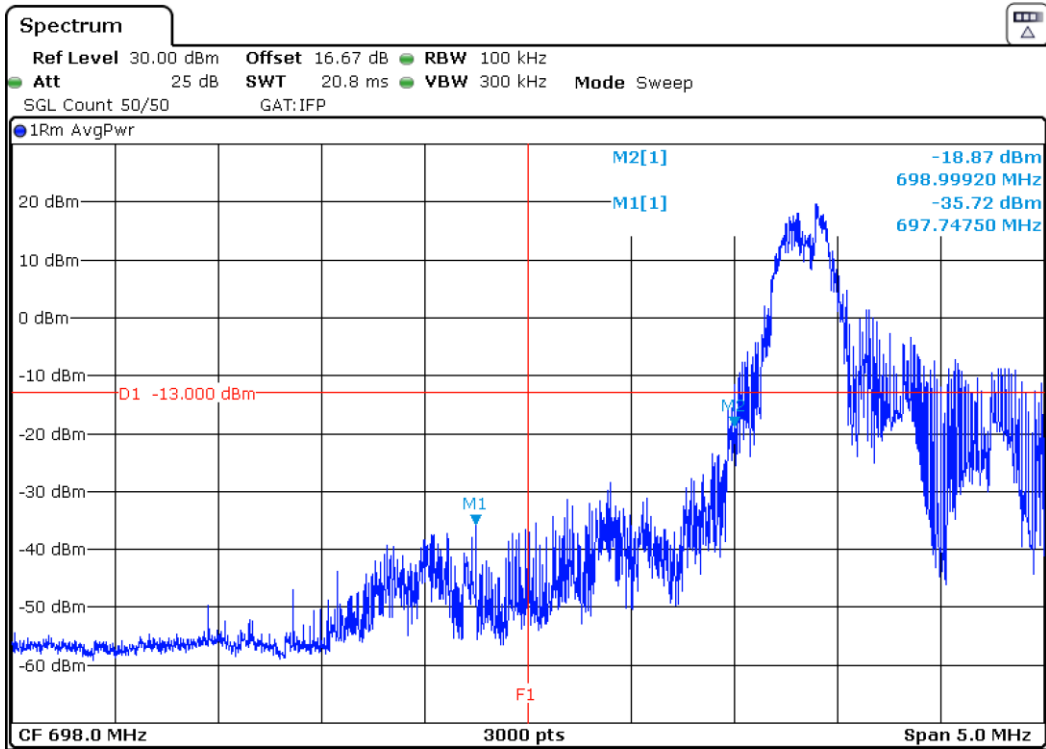

The equipment transmits at the maximum output power

LTE Band 12. QPSK MODULATION. BW=5 MHz. RB=All. Offset=0. Narrowband=0. Low Block Edge:

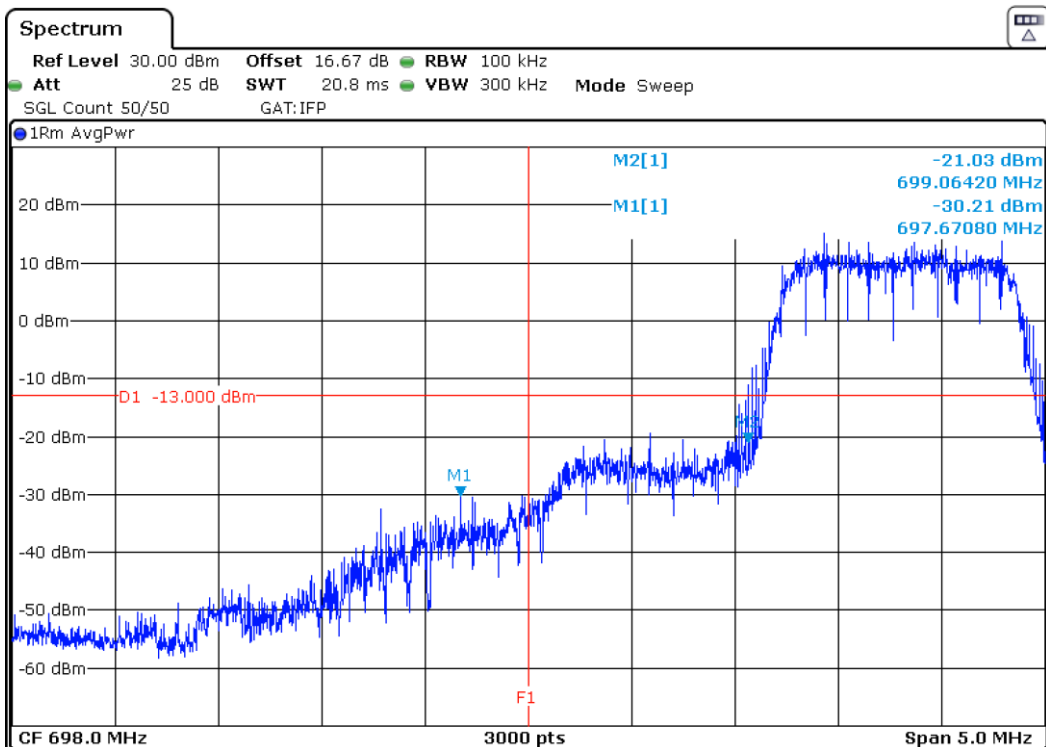

The equipment transmits at the maximum output power

LTE Band 12. QPSK MODULATION. BW=5 MHz. RB=1. Offset=Max. Narrowband=3. High Block Edge:

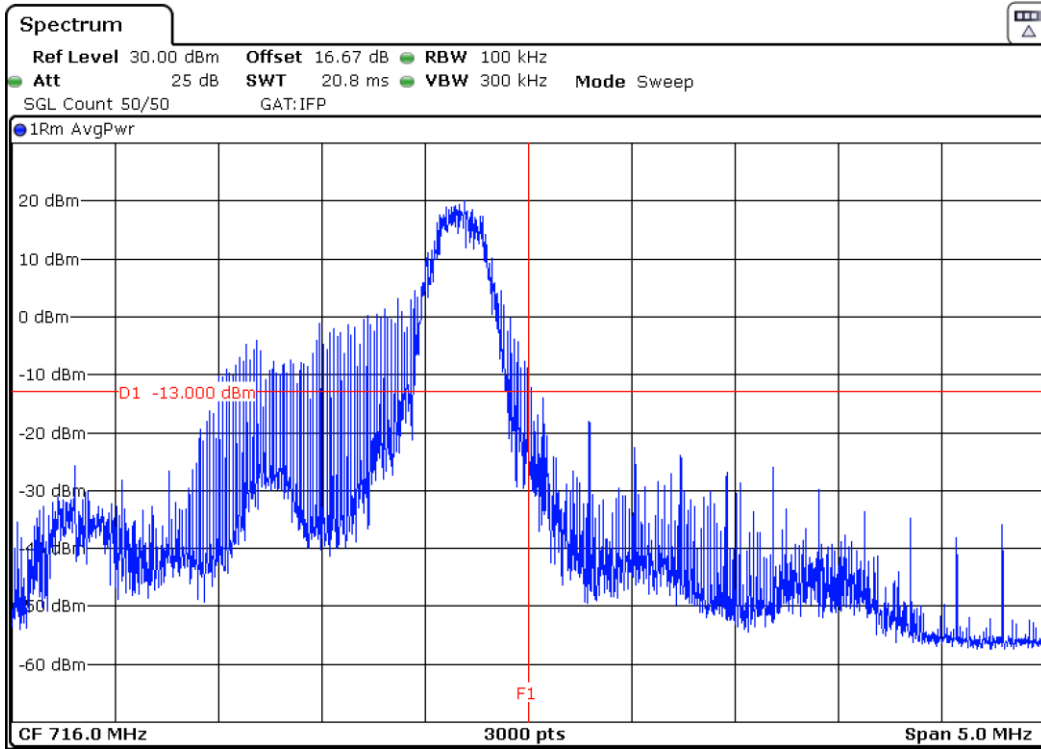

The equipment transmits at the maximum output power

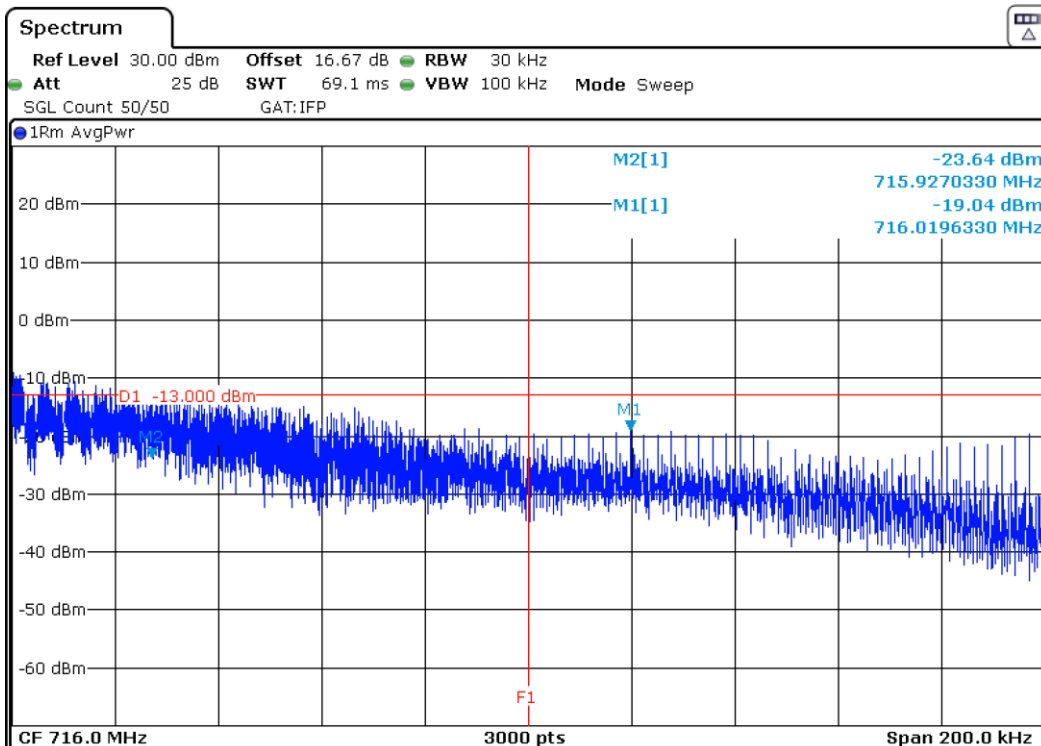

Zoom (200 kHz) with RBW = 30 kHz.

LTE Band 12. QPSK MODULATION. BW=5 MHz. RB=All. Offset=0. Narrowband=3. High Block Edge:

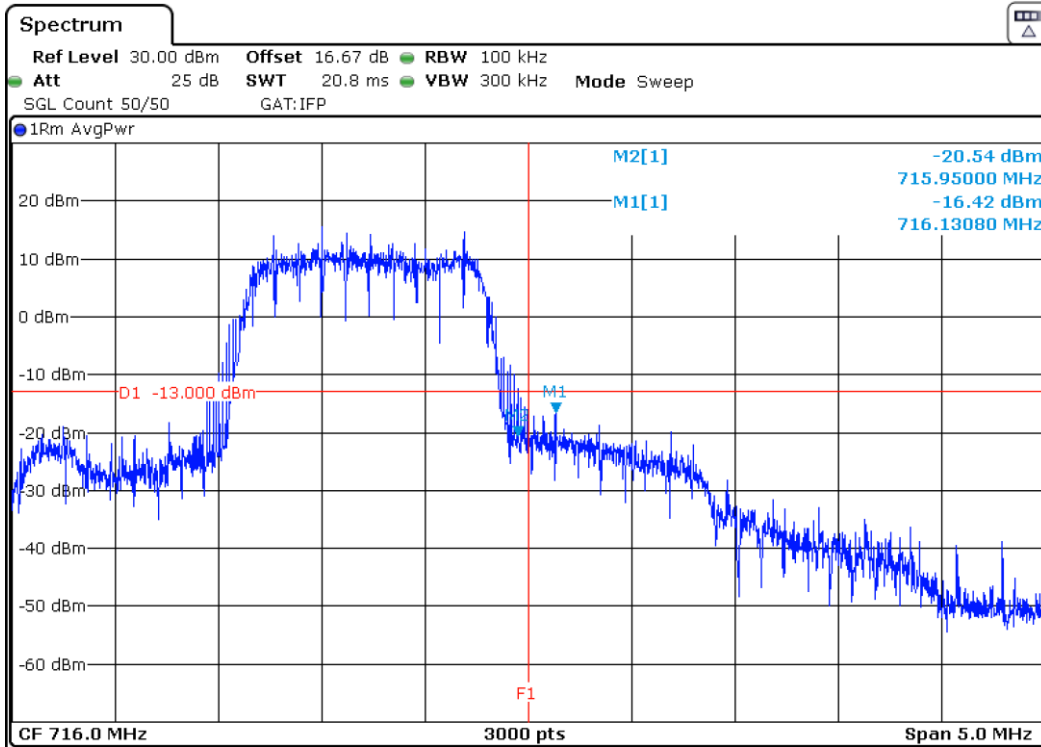

The equipment transmits at the maximum output power

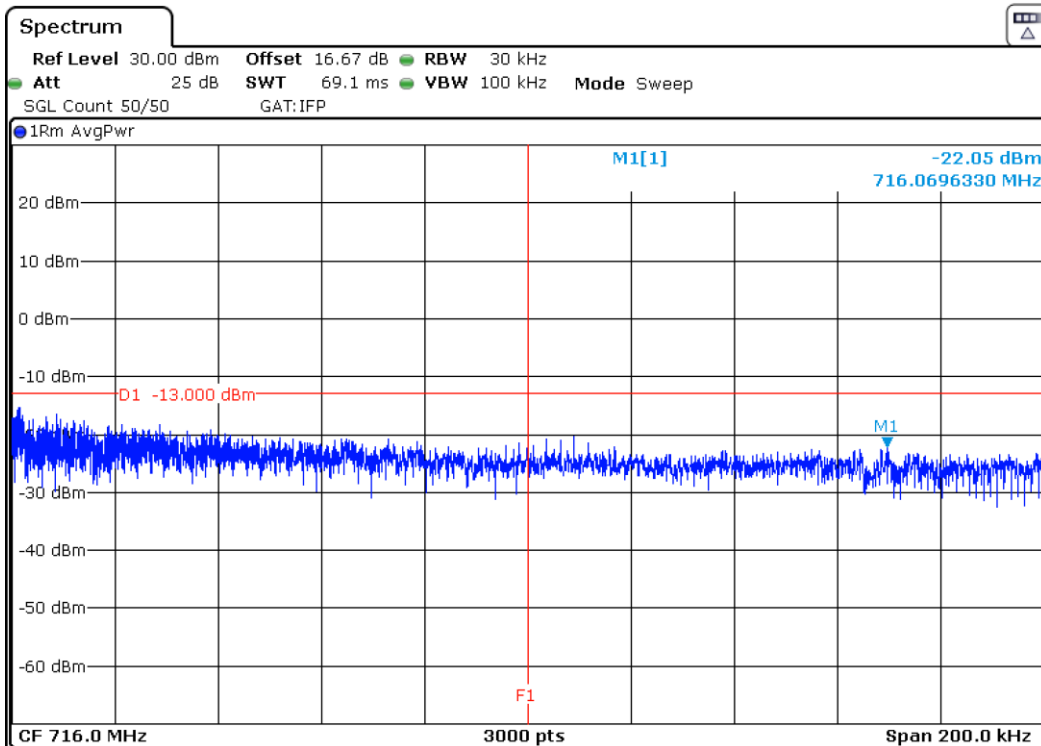

Zoom (200 kHz) with RBW = 30 kHz.

LTE Band 12. QPSK MODULATION. BW=10 MHz. RB=1. Offset=0. Narrowband=0. Low Block Edge:

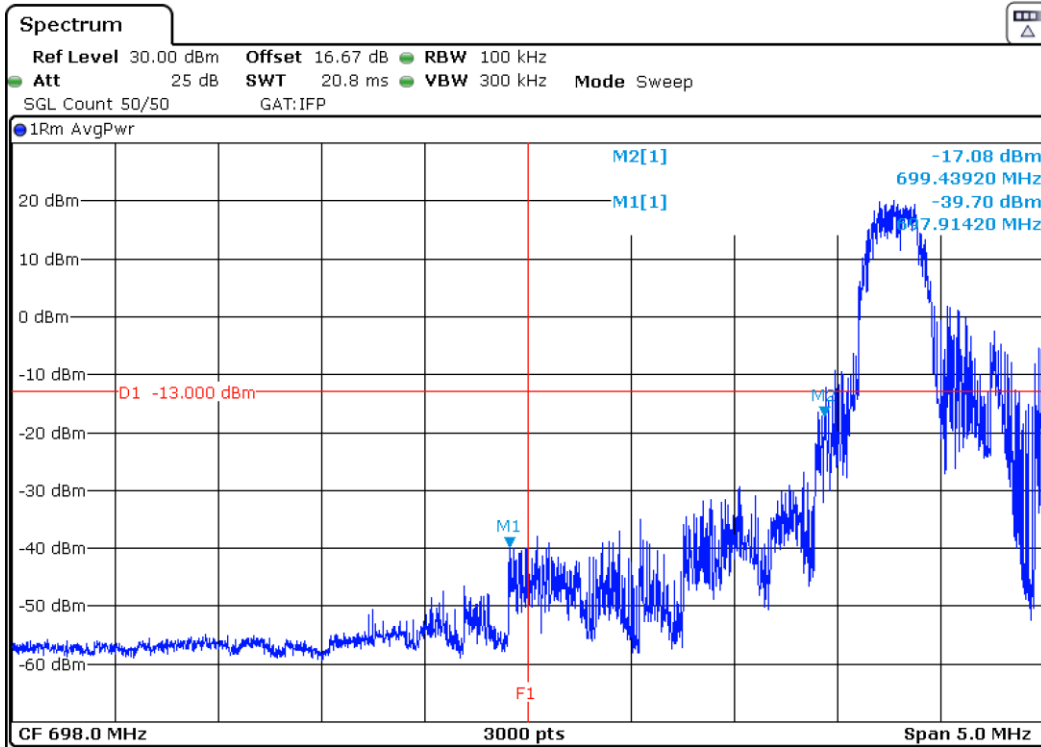

The equipment transmits at the maximum output power

LTE Band 12. QPSK MODULATION. BW=10 MHz. RB=All. Offset=0. Narrowband=0. Low Block Edge:

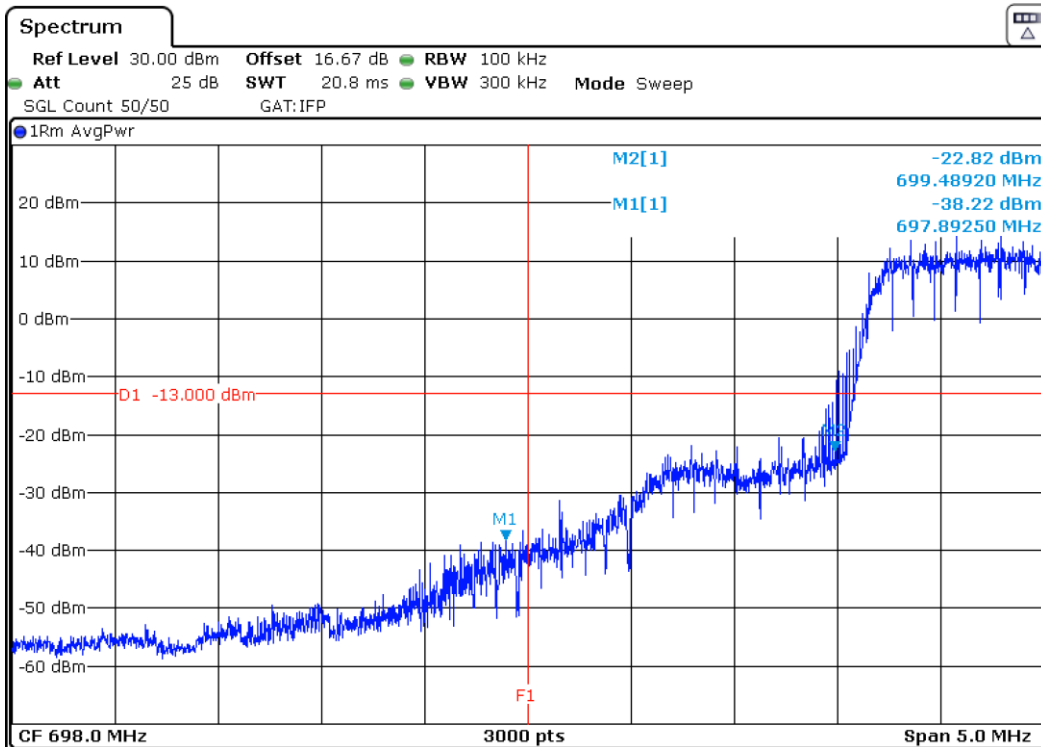

The equipment transmits at the maximum output power

LTE Band 12. QPSK MODULATION. BW=10 MHz. RB=1. Offset=Max. Narrowband=7. High Block Edge:

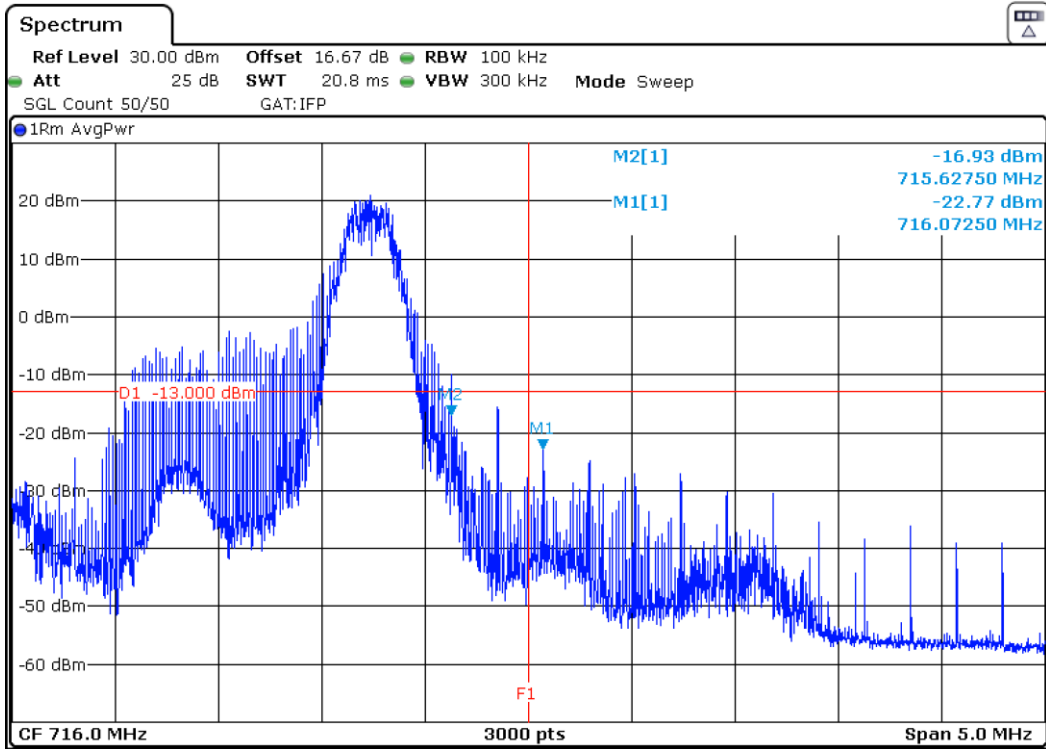

The equipment transmits at the maximum output power

LTE Band 12. QPSK MODULATION. BW=10 MHz. RB=All. Offset=0. Narrowband=7. High Block Edge:

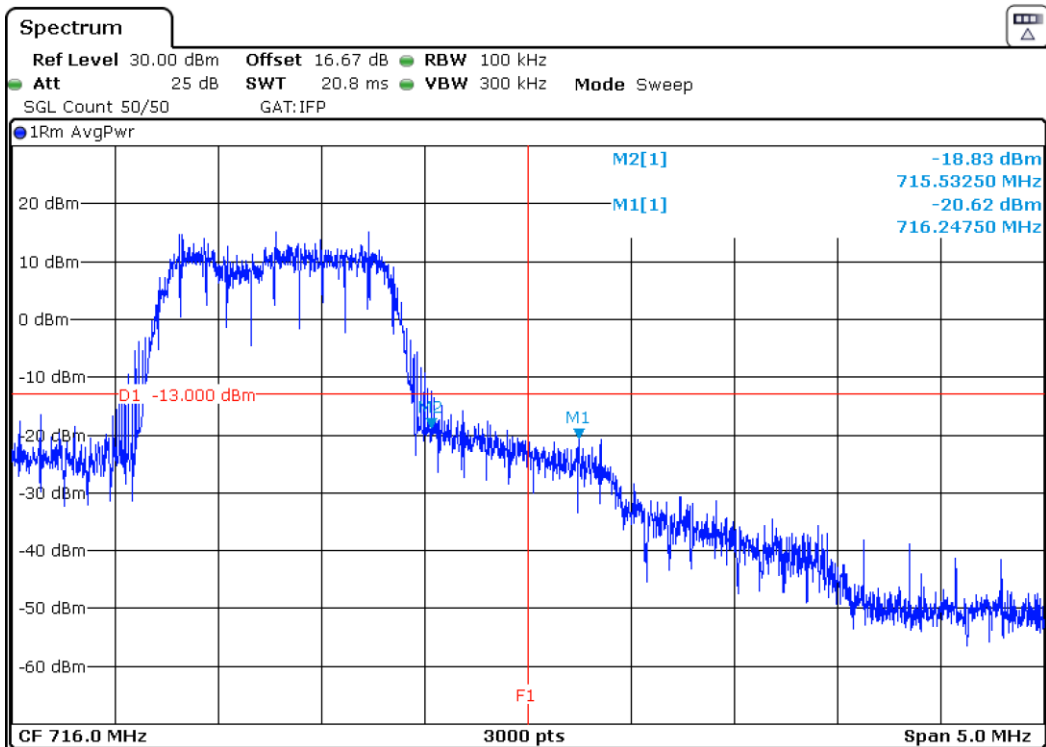

The equipment transmits at the maximum output power