



FCC Part 15, Subpart C Test Report

FCC ID: 2AAGF-STOCKIIBT

Applicant: Zound Industries International AB

Address: Centralplan 15 SE-111 20 Stockholm Sweden

Manufacturer: Zound Industries International AB

Address: Centralplan 15 SE-111 20 Stockholm Sweden

Product: PORTABLE LOUDSPEAKER

Brand: Marshall

Test Model(s): STOCKWELL II BT

Series Model(s): N/A

Test Date: Dec. 27, 2021~Jan. 06, 2022

Issued Date: Jan. 25, 2022

Issued By: Hwa-Hsing (Dongguan) Testing Co., Ltd.

Address: No.101, Bld N1, Yuyuan 2Rd, Yuyuan Industrial Park, HuangJiang Town, Dongguan, China

Test Firm Registration No.: 915896

Standards: 47 CFR FCC Part 15, Subpart C (Section 15.247)
ANSI C63.10:2013

The above equipment has been tested by **Hwa-Hsing (Dongguan) Testing Co., Ltd.**, and found compliance with the requirement of the above standards. The test record, data evaluation & Equipment Under Test (EUT) configurations represented herein are true and accurate accounts of the measurements of the sample's EMC characteristics under the conditions specified in this report.

Prepared by :

Candy Zhang/ Report Engineer

Reviewed by :

Tank tan/ Project Engineer

Approved by :

Harry Li/ Technical Director

This report is for your exclusive use. Any copying or replication of this report to or for any other person or entity, or use of our name or trademark, is permitted only with our prior written permission. This report sets forth our findings solely with respect to the test samples identified herein. The results set forth in this report are not indicative or representative of the quality or characteristics of the lot from which a test sample was taken or any similar or identical product unless specifically and expressly noted. Our report includes all of the tests requested by you and the results thereof based upon the information that you provided to us. You have 60 days from date of issuance of this report to notify us of any material error or omission caused by our negligence, provided, however, that such notice shall be in writing and shall specifically address the issue you wish to raise. A failure to raise such issue within the prescribed time shall constitute your unqualified acceptance of the completeness of this report, the tests conducted and the correctness of the report contents. Unless specific mention, the uncertainty of measurement has been explicitly taken into the account to declare the compliance or non-compliance to the specification. The report must not be used by the client to claim product certification, approval, or endorsement by A2LA or any agency of the federal government. The report must not be used by the client to claim product certification, approval, or endorsement by TAF or any government agencies.



Table of Contents

Release Control Record	4
1 Summary of Test Results	5
1.1 Measurement Uncertainty.....	5
1.2 Modification Record.....	5
2 General Information	6
2.1 General Description of EUT.....	6
2.2 Description of Test Modes.....	7
2.2.1 Test Mode Applicability and Tested Channel Detail.....	8
2.3 Description of Support Units.....	10
2.3.1 Configuration of System under Test.....	10
3 Test Types and Results	11
3.1 Radiated Emission and Bandedge Measurement.....	11
3.1.1 Limits of Radiated Emission and Bandedge Measurement.....	11
3.1.2 Test Instruments.....	12
3.1.3 Test Procedures.....	13
3.1.4 Deviation from Test Standard.....	14
3.1.5 Test Setup.....	15
3.1.6 EUT Operating Conditions.....	16
3.1.7 Test Results.....	17
3.2 Conducted Emission Measurement.....	29
3.2.1 Limits of Conducted Emission Measurement.....	29
3.2.2 Test Instruments.....	29
3.2.3 Test Procedures.....	30
3.2.4 Test Setup.....	30
3.2.5 EUT Operating Condition.....	30
3.2.6 Deviation from Test Standard.....	30
3.2.7 Test Results.....	31
3.3 Number of Hopping Frequency Used.....	33
3.3.1 Limits of Hopping Frequency Used Measurement.....	33
3.3.2 Test Setup.....	33
3.3.3 Test Instruments.....	33
3.3.4 Test Procedure.....	33
3.3.5 Deviation from Test Standard.....	33
3.3.6 Test Results.....	34
3.4 Dwell Time on Each Channel.....	35
3.4.1 Limits of Dwell Time on Each Channel Measurement.....	35
3.4.2 Test Setup.....	35
3.4.3 Test Instruments.....	35
3.4.4 Test Procedures.....	35
3.4.5 Deviation from Test Standard.....	35
3.4.6 Test Results.....	36
3.5 Channel Bandwidth.....	39
3.5.1 Limits of Channel Bandwidth Measurement.....	39
3.5.2 Test Setup.....	39
3.5.3 Test Instruments.....	39
3.5.4 Test Procedure.....	39
3.5.5 Deviation from Test Standard.....	39
3.5.6 EUT Operating Condition.....	39
3.5.7 Test Results.....	40
3.6 Occupied Bandwidth Measurement.....	42
3.6.1 Test Setup.....	42



3.6.2	Test Instruments	42
3.6.3	Test Procedure	42
3.6.4	Deviation from Test Standard	42
3.6.5	EUT Operating Conditions	42
3.6.6	Test Results	43
3.7	Hopping Channel Separation	45
3.7.1	Limits of Hopping Channel Separation Measurement	45
3.7.2	Test Setup	45
3.7.3	Test Instruments	45
3.7.4	Test Procedure	45
3.7.5	Deviation from Test Standard	45
3.7.6	Test Results	46
3.8	Maximum Output Power	48
3.8.1	Limits of Maximum Output Power Measurement	48
3.8.2	Test Setup	48
3.8.3	Test Instruments	48
3.8.4	Test Procedure	48
3.8.5	Deviation from Test Standard	49
3.8.6	EUT Operating Condition	49
3.8.7	Test Results	50
3.9	Conducted Out of Band Emission Measurement	53
3.9.1	Limits of Conducted Out of Band Emission Measurement	53
3.9.2	Test Setup	53
3.9.3	Test Instruments	53
3.9.4	Test Procedure	53
3.9.5	Deviation from Test Standard	54
3.9.6	EUT Operating Condition	54
3.9.7	Test Results	55
4	Pictures of Test Arrangements	61
5	Test Instruments	62
	Appendix – Information on the Testing Laboratories	63



Release Control Record

Issue No.	Description	Date Issued
211126EL31-RF-US-01	Original Release	Jan. 25, 2022



1 Summary of Test Results

47 CFR FCC Part 15, Subpart C (Section 15.247) KDB 558074 D01 15.247 Meas Guidance v05r02 ANSI C63.10:2013;			
FCC Clause	Test Item	Result	Remarks
15.207	AC Power Conducted Emission	Pass	Meet the requirement of limit.
15.247(a)(1) (iii)	Number of Hopping Frequency Used	Pass	Meet the requirement of limit.
15.247(a)(1) (iii)	Dwell Time on Each Channel	Pass	Meet the requirement of limit.
15.247(a)(1)	1. Hopping Channel Separation 2. Spectrum Bandwidth of a Frequency Hopping Sequence Spread Spectrum System	Pass	Meet the requirement of limit.
15.247(b)	Maximum Peak Output Power	Pass	Meet the requirement of limit.
---	Occupied Bandwidth Measurement	Pass	Reference only
15.205 & 209	Radiated Emissions	Pass	Meet the requirement of limit.
15.247(d)	Band Edge Measurement	Pass	Meet the requirement of limit.
15.247(d)	Antenna Port Emission	Pass	Meet the requirement of limit.
15.203	Antenna Requirement	Pass	No antenna connector is used.

Note1: If the Frequency Hopping System operating in 2400-2483.5MHz band and the output power less than 125mW. The hopping channel carrier frequencies separated by a minimum of 25kHz or two-thirds of the 20dB bandwidth of hopping channel whichever is greater.

Note2: The EUT has been verified to comply with the requirements of FCC Part 15, Subpart B, Class B (sDoC). The test report has been issued separately.

1.1 Measurement Uncertainty

Where relevant, the following measurement uncertainty levels have been estimated for tests performed on the EUTas specified in CISPR 16-4-2:

The listed uncertainties are the worst-case uncertainty for the entire range of measurement. Please note that the uncertainty values are provided for informational purposes only and are not used in determining the PASS/FAIL results.

Measurement	Frequency	Expanded Uncertainty (k=2) (±)
Conducted Emissions at mains ports	150kHz ~ 30MHz	2.66 dB
Radiated Emissions up to 1 GHz	9KHz ~ 30MHz	2.16 dB
	30MHz ~ 1000MHz	3.47 dB
Radiated Emissions above 1 GHz	1GHz ~ 18GHz	4.84 dB
	18GHz ~ 40GHz	4.67 dB

Note: This uncertainty represents an expanded uncertainty expressed at approximately the 95% confidence level using a coverage factor of k = 2.

1.2 Modification Record

There were no modifications required for compliance.



2 General Information

2.1 General Description of EUT

Product	PORTABLE LOUDSPEAKER
Brand	Marshall
Test Model(s)	STOCKWELL II BT
Series Model(s)	N/A
FCC ID:	2AAGF-STOCKIIBT
Status of EUT	EngineeringPrototype
Power Supply Rating	DC7.2V from battery or DC 5V-12V,3A Max for Adapter
Modulation Type	GFSK, $\pi/4$ DQPSK,8DPSK
Transfer Rate	1/2/3Mbps
Operating Frequency	2402 ~ 2480MHz
Number of Channel	79
Output Power (Peak)	12.34dBm
Antenna Type	FPCB Antenna
Antenna Gain	5.15dBi Maximum peak Gain
Antenna Connector	N/A
Accessory Device	N/A
Cable Supplied	USB Cable: Unshielded, 120cm

Note:

1. Please refer to the EUT photo document (Reference No.:211126EL31-1&-2) for detailed product photo.
2. The above EUT information is declared by manufacturer and for more detailed features description, please refer to the manufacturer's specifications or User's Manual.



2.2 Description of Test Modes

79 channels are provided to this EUT:

Channel	Freq. (MHz)	Channel	Freq. (MHz)	Channel	Freq. (MHz)	Channel	Freq. (MHz)
0	2402	20	2422	40	2442	60	2462
1	2403	21	2423	41	2443	61	2463
2	2404	22	2424	42	2444	62	2464
3	2405	23	2425	43	2445	63	2465
4	2406	24	2426	44	2446	64	2466
5	2407	25	2427	45	2447	65	2467
6	2408	26	2428	46	2448	66	2468
7	2409	27	2429	47	2449	67	2469
8	2410	28	2430	48	2450	68	2470
9	2411	29	2431	49	2451	69	2471
10	2412	30	2432	50	2452	70	2472
11	2413	31	2433	51	2453	71	2473
12	2414	32	2434	52	2454	72	2474
13	2415	33	2435	53	2455	73	2475
14	2416	34	2436	54	2456	74	2476
15	2417	35	2437	55	2457	75	2477
16	2418	36	2438	56	2458	76	2478
17	2419	37	2439	57	2459	77	2479
18	2420	38	2440	58	2460	78	2480
19	2421	39	2441	59	2461		



2.2.1 Test Mode Applicability and Tested Channel Detail

EUT Configure Mode	Applicable test items	X-Axis	Y-Axis	Z-Axis	Voltage Supply
Conducted	AC Power Conducted Emission	N/A	N/A	N/A	AC120V/60Hz of adapter input
Radiated	Radiated Emissions	√	√	√	
Antenna Port Conducted Measurement	Number of Hopping Frequency Used	N/A	N/A	N/A	
	Dwell Time on Each Channel	N/A	N/A	N/A	
	Band Edge Measurement	N/A	N/A	N/A	
	Antenna Port Emission	N/A	N/A	N/A	
	Conducted power	N/A	N/A	N/A	
	Hopping Channel Separation	N/A	N/A	N/A	
	Spectrum Bandwidth of a Frequency Hopping Sequence Spread Spectrum System	N/A	N/A	N/A	

- *: The EUT had been pre-tested on the positioned of each 3 Axis. The worst case was found when positioned on **Z-plane**.
- “N/A” means no effect.

Test Condition:

Applicable test items	Environmental Conditions	Test Data	Tested by
AC Power Conducted Emission	25deg. C, 65%RH	Jan. 05, 2022	Jim Xu
Radiated Emissions	25deg. C, 65%RH	Jan. 04, 2022	Jim Xu
Antenna Port Conducted Measurement	25deg. C, 65%RH	Jan. 06, 2022	Scott He

- Pre-Scan has been conducted to determine the worst-case mode from all possible combinations between available modulations, data rates and antenna ports (if EUT with antenna diversity architecture). Following channel(s) was (were) selected for the final test as listed below.



Radiated Emission Test (Above 1 GHz):

EUT Configure Mode	Available Channel	Tested Channel	Modulation Technology	Modulation Type	Packet Type
-	0 to 78	0, 39, 78	FHSS	GFSK	DH5
-	0 to 78	0, 39, 78	FHSS	8DPSK	3DH5

Radiated Emission Test (Below 1 GHz):

EUT Configure Mode	Available Channel	Tested Channel	Modulation Technology	Modulation Type	Packet Type
-	0 to 78	0	FHSS	8DPSK	3DH5

Power Line Conducted Emission Test:

EUT Configure Mode	Available Channel	Tested Channel	Modulation Technology	Modulation Type	Packet Type
-	0 to 78	0	FHSS	8DPSK	3DH5

Antenna Port Conducted Measurement:

This item includes all test value of each mode, but only includes spectrum plot of worst value of each mode.

EUT Configure Mode	Available Channel	Tested Channel	Modulation Technology	Modulation Type	Packet Type
-	0 to 78	0, 39, 78	FHSS	GFSK	DH5
-	0 to 78	0, 39, 78	FHSS	8DPSK	3DH5



2.3 Description of Support Units

The EUT has been tested as an independent unit together with other necessary accessories or support units. The following support units or accessories were used to form a representative test configuration during the tests.

No.	Product	Brand	Model No.	Serial No.	FCC ID
1.	Notebook	HUAWEI	NbD-WFH9	EUEPM21725002655	N/A

No.	Signal Cable Description of The Above Support Units
1.	USB serial cable Un-shieldin1.2m
2.	/
3.	/

2.3.1 Configuration of System under Test

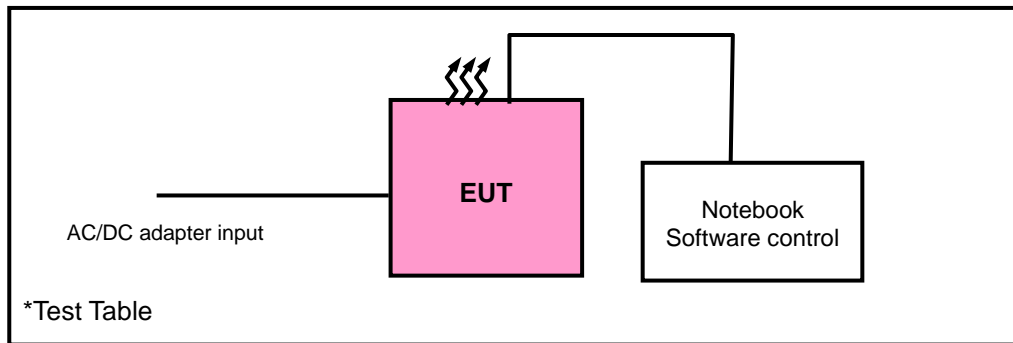



3 Test Types and Results

3.1 Radiated Emission and Bandedge Measurement

3.1.1 Limits of Radiated Emission and Bandedge Measurement

Radiated emissions which fall in the restricted bands must comply with the radiated emission limits specified as below table. Other emissions shall be at least 20 dB below the highest level of the desired power:

Frequencies (MHz)	Field Strength (microvolts/meter)	Measurement Distance (meters)
0.009 ~ 0.490	2400/F(kHz)	300
0.490 ~ 1.705	24000/F(kHz)	30
1.705 ~ 30.0	30	30
30 ~ 88	100	3
88 ~ 216	150	3
216 ~ 960	200	3
Above 960	500	3

* DTS emissions in non-restricted frequency bands Subclause 11.11 of ANSI C63.10 is applicable.

* DTS emissions in restricted frequency bands Subclause 11.12 of ANSI C63.10 is applicable

Note:

1. The lower limit shall apply at the transition frequencies.
2. Emission level (dBuV/m) = 20 log Emission level (uV/m).
3. For frequencies above 1000 MHz, the field strength limits are based on average detector, however, the peak field strength of any emission shall not exceed the maximum permitted average limits, specified above by more than 20 dB under any condition of modulation.



3.1.2 Test Instruments

Radiated emission below 30MHz:

Equipment	Manufacturer	Model No.	Serial No.	Next Cal.
EMI Test Receiver	Rohde&Schwarz	ESCI 7	100962	2022/09/12
3m Semi-anechoic Chamber	MAORUI	9m*6m*6m	NSEMC003	2022/04/14
Test software	FARAD	FARAD	EZ_EMCV1.1.4.2	N/A
Loop Antenna	EMCI	HLA 6121	45745	2022/04/13
Preamplifier	EMCI	EMC001340	980201	2022/09/12
Antenna Tower	MF	MFA-440H	NA	NA
Turn Table	MF	MFT-201SS	NA	NA
Antenna Tower&Turn Table Controller	MF	MF-7802	NA	NA

Frequency Range below 1GHz:

Equipment	Manufacturer	Model No.	Serial No.	Next Cal.
EMI Test Receiver	Rohde&Schwarz	ESCI 7	100962	2022/09/12
Broadband antenna	Schwarzbeck	VULB 9168	00937	2022/04/15
3m Semi-anechoic Chamber	MAORUI	9m*6m*6m	NSEMC003	2022/04/14
Signal Amplifier	Com-power	PAM-103	18020051	2022/03/14
Attenuator	Rohde&Schwarz	TS2GA-6dB	18101101	N/A
Test software	FARAD	FARAD	EZ_EMCV1.1.4.2	N/A

Frequency Range 1-18GHz:

Equipment	Manufacturer	Model No.	Serial No.	Next Cal.
3m Semi-anechoic Chamber	MAORUI	9m*6m*6m	NSEMC003	2022/04/14
Horn Antenna	Schwarzbeck	BBHA 9170	01959	2022/04/15
Broadband Coaxial Preamplifier	Schwarzbeck	BBV 9718	00025	2022/03/14
Spectrum	Keysight	N9020A	MY51240612	2022/09/12
Antenna Tower	MF	MFA-440H	NA	NA
Turn Table	MF	MFT-201SS	NA	NA
Antenna Tower&Turn Table Controller	MF	MF-7802	NA	NA

Frequency Range 18-40GHz:

Equipment	Manufacturer	Model No.	Serial No.	Next Cal.
3m Semi-anechoic Chamber	MAORUI	9m*6m*6m	NSEMC003	2022/04/14
Spectrum Analyzer	Rohde&Schwarz	FSV-40N	101783	2022/03/14
Horn Antenna	Schwarzbeck	BBHA 9170	BBHA9170242	2022/04/15
Pre-Amplifier	EMCI	EMC 184045	980102	2022/03/14
Antenna Tower	MF	MFA-440H	NA	NA
Turn Table	MF	MFT-201SS	NA	NA
Antenna Tower&Turn Table Controller	MF	MF-7802	NA	NA

- Note: 1. The calibration interval of the above test instruments is 12months (The Antenna and Chamber was 24 months) and the calibrations are traceable to CEPREI/CHINA.
 2. The test was performed in 966.



3.1.3 Test Procedures

a. **Peak emission levels are measured by setting the instrument as follow:**

1) RBW& VBWsetting as a function of frequency:

Frequency	RBW	VBW
9kHz~150kHz	200Hz	600Hz
0.15MHz~30MHz	9kHz	30kHz
30MHz~1000MHz	120kHz	300kHz
>1000MHz	1MHz	3MHz

- 2) Detector = peak.
- 3) Sweep time = auto.
- 4) Trace mode = max hold.
- 5) Allow sweeps to continue until the trace stabilizes. (Note that the required measurement time may be lengthened for low-duty-cycle applications.)

Note: If the peak-detected amplitude can be shown to comply with the average limit, then it is not necessary to perform a separate average measurement

b. **Average emission levels are measured by setting the instrument as follow:**

● **Trace averaging with continuous EUT transmission at full power**

If the EUT can be configured or modified to transmit continuously (D ≥ 98%). then the average emission levels shall be measured using the following method (with EUT transmitting continuously):

- 1) RBW=1 MHz (unless otherwise specified).
- 2) VBW≥ 3 *RBW.
- 3) Detector =RMS
- 4) Sweep time = auto.
- 5) Perform a trace average of at least 100 traces.

● **Trace averaging across ON and OFF times of the EUT transmissions followed by duty cycle correction**

If continuous transmission of the EUT (D≥98%) cannot be achieved and the duty cycle is constant (duty cycle variations are less than ±2%). then the following procedure shall be used

- 1) The EUT shall be configured to operate at the maximum achievable duty cycle.
- 2) Measure the duty cycle D of the transmitter output signal as described in 11.6.
- 3) RBW=1 MHz (unless otherwise specified).
- 4) VBW≥ 3 *RBW.
- 5) Detector =RMS
- 6) Sweep time = auto.
- 7) Perform a trace average of at least 100 traces.

A correction factor shall be added to the measurement results prior to comparing with the emission limit to compute the emission level that would have been measured had the test been performed at 100% duty cycle. The correction factor is computed as follows:

*If power averaging (rms) mode was used in step 5). then the applicable correction factor is [10 10g (1/ D)], where D is the duty cycle.

**If linear voltage averaging mode was used in step f). then the applicable correction factor is [20 10g (1/D)], where D is the duty cycle.

***If a specific emission is demonstrated to be continuous (D > 98%) rather than turning ON and OFF with the transmit cycle, then no duty cycle correction is required for that



● **Reduced VBW Averaging across ON and OFF times of the EUT transmissions with max hold**

If continuous transmission of the EUT ($D > 98\%$) cannot be achieved and the duty cycle is not constant (duty cycle variations exceed $\pm 2\%$), then the following procedure shall be used:

- 1) RBW = 1 MHz.
 - 2) $VBW \geq 1/T$.
 - 3) Detector = peak
 - 4) Sweep time = auto.
 - 5) Trace mode = max hold.
 - 6) Allow max hold to run for at least $[50 \times (1/D)]$ traces
- c. The EUT was placed on the top of a rotating table 0.8 meters (below 1GHz) / 1.5 meters (1-18GHz) / 1.5 meters (18-40GHz) above the reference ground. The table was rotated 360 degrees to determine the position of the highest radiation.
- d. The EUT was set 3 meters away from the interference-receiving antenna (Below 1GHz) & (Above 1-18GHz), which was mounted on the top of a variable-height antenna tower. The EUT was set 1 meters away from the interference-receiving antenna (18-40GHz).
- e. The height of antenna is varied from one meter to four meters above the ground to determine the maximum value of the field strength. Both horizontal and vertical polarizations of the antenna are set to make the measurement.
- f. For each suspected emission, the EUT was arranged to its worst case and then the antenna was tuned to heights from 1 meter to 4 meters and the rotatable table was turned from 0 degrees to 360 degrees to find the maximum reading.
- g. The test-receiver system was set to quasi-peak detect function and specified bandwidth with maximum hold mode when the test frequency is below 1 GHz.

The test-receiver system was set to peak and average detected function and specified bandwidth with maximum hold mode when the test frequency is above 1 GHz. If the peak reading value also meets average limit, measurement with the average detector is unnecessary.

Note:

1. Test procedures for measuring FHSS device: The use of a duty cycle correction factor (DCCF) is permitted for calculating average radiated field strength emission levels for an FHSS device in 15.247. This DCCF can be applied when the unwanted emission limit is subject to an average field strength limit (e.g., within a Government Restricted band) and the conditions specified in Section 15.35(c) can be satisfied. The average radiated field strength is calculated by subtracting the DCCF from the maximum radiated field strength level as determined through measurement. The maximum radiated field strength level represents the worst-case (maximum amplitude) RMS measurement of the emission(s) during continuous transmission (i.e., not including any time intervals during which the transmitter is off or is transmitting at a reduced power level). It is also acceptable to apply the DCCF to a measurement performed with a peak detector instead of the specified RMS power averaging detector. Note that Section 15.35(c) specifies that the DCCF shall represent the worst-case (greatest duty cycle) over any 100 msec transmission period. Subclause 7.5 of ANSI C63.10 provides additional measurement guidance applicable to determination of the DCCF.
2. All modes of operation were investigated and the worst-case emissions are reported.

3.1.4 Deviation from Test Standard

No deviation.



3.1.5 Test Setup

Radiated emission below 30MHz:

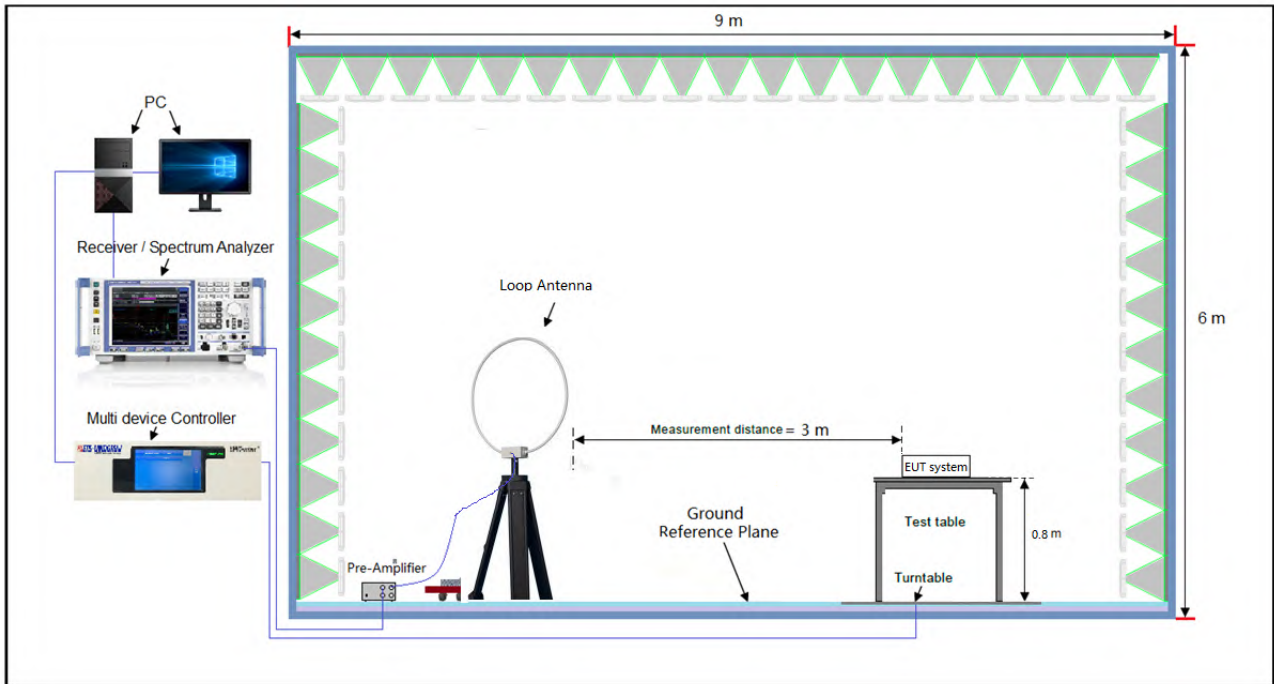

Frequency Range below 1GHz:

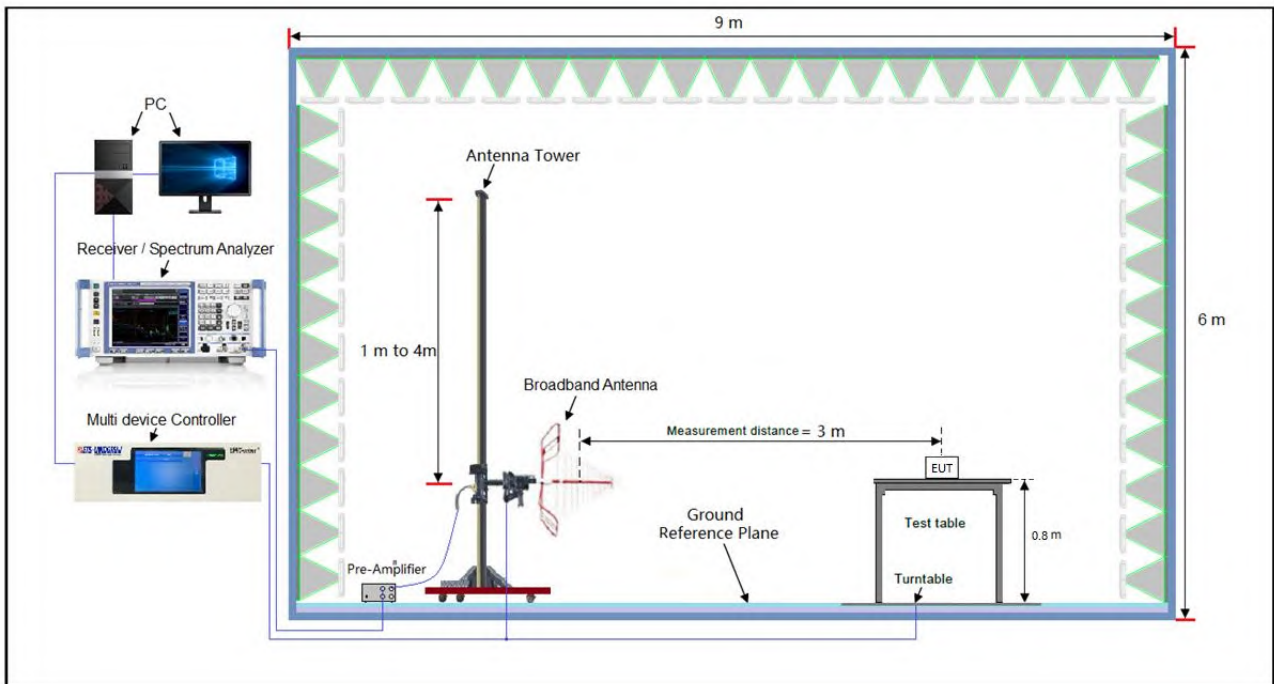



Frequency Range above 1GHz:

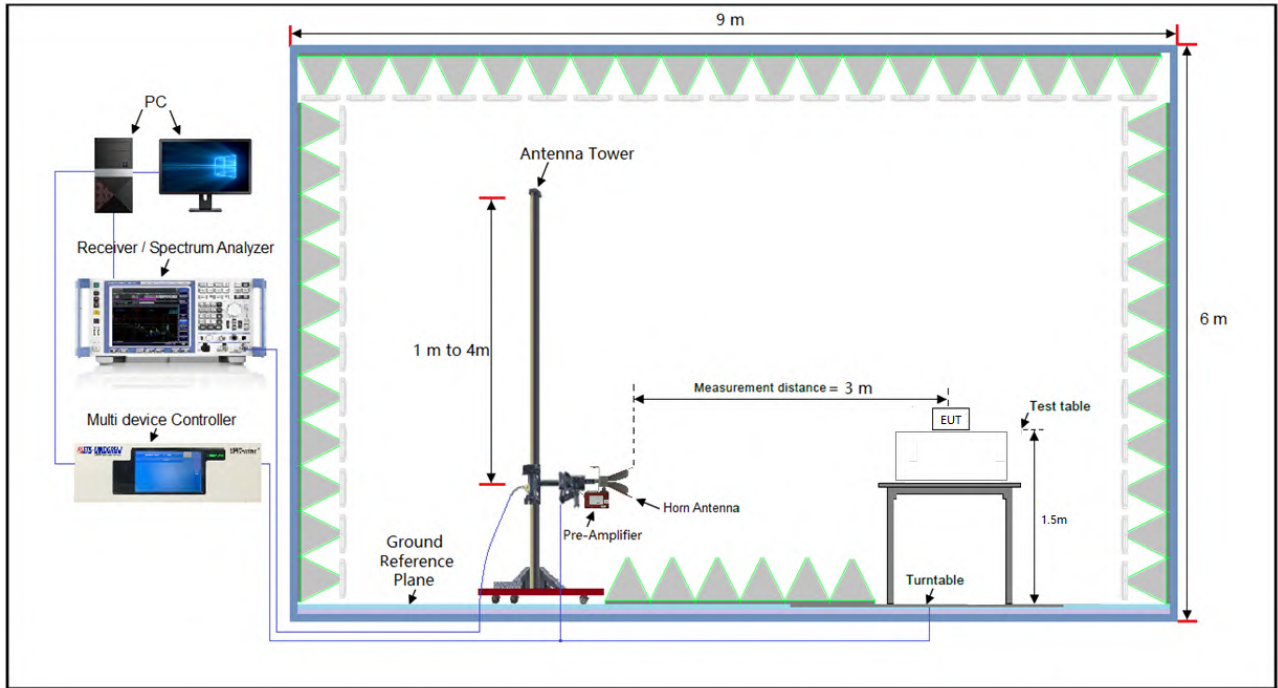

Frequency Range 18-40GHz:

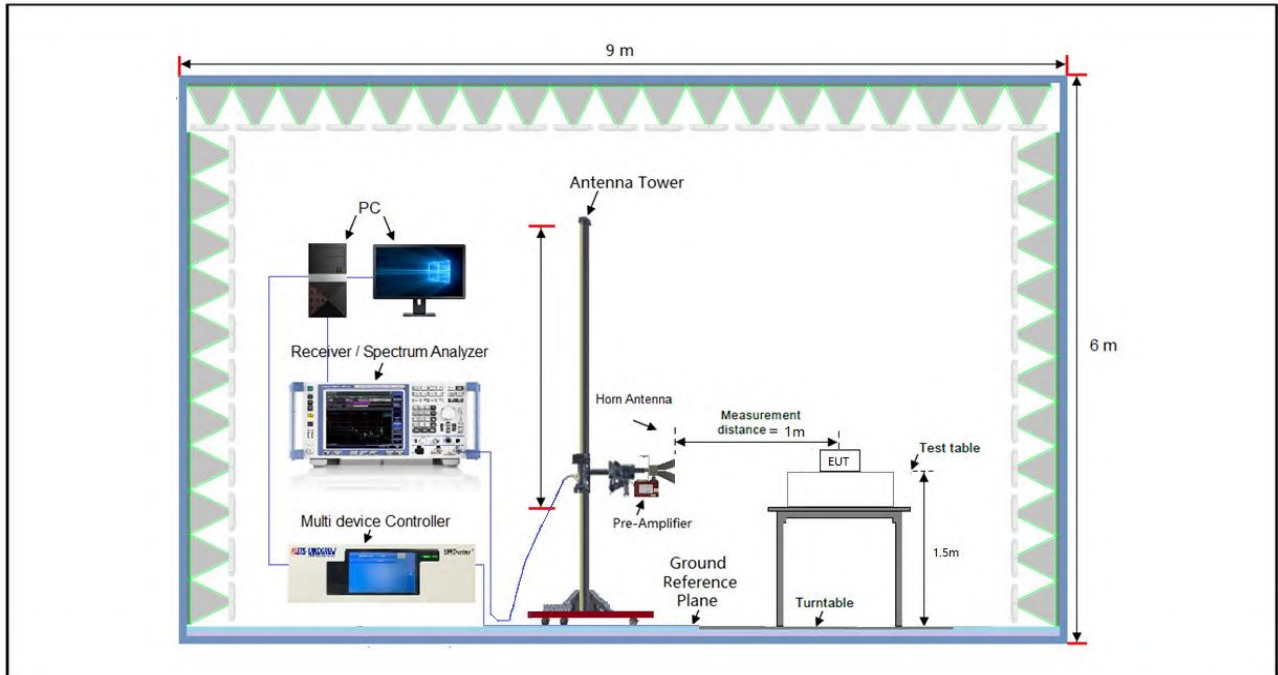

*For the actual test configuration, please refer to the attached file (Test Setup Photo).

3.1.6 EUT Operating Conditions

Set the EUT under transmission condition continuously at specific channel frequency.



3.1.7 Test Results

9 kHz ~ 30 MHz Data:

The amplitude of spurious emissions attenuated more than 20 dB below the permissible value is not required to be report.

30 MHz ~ 1GHz Worst-Case Data:

Frequency Range	30MHz ~ 1GHz	Detector Function	Peak (PK) Quasi-peak (QP)
Test Channel	Channel 0		

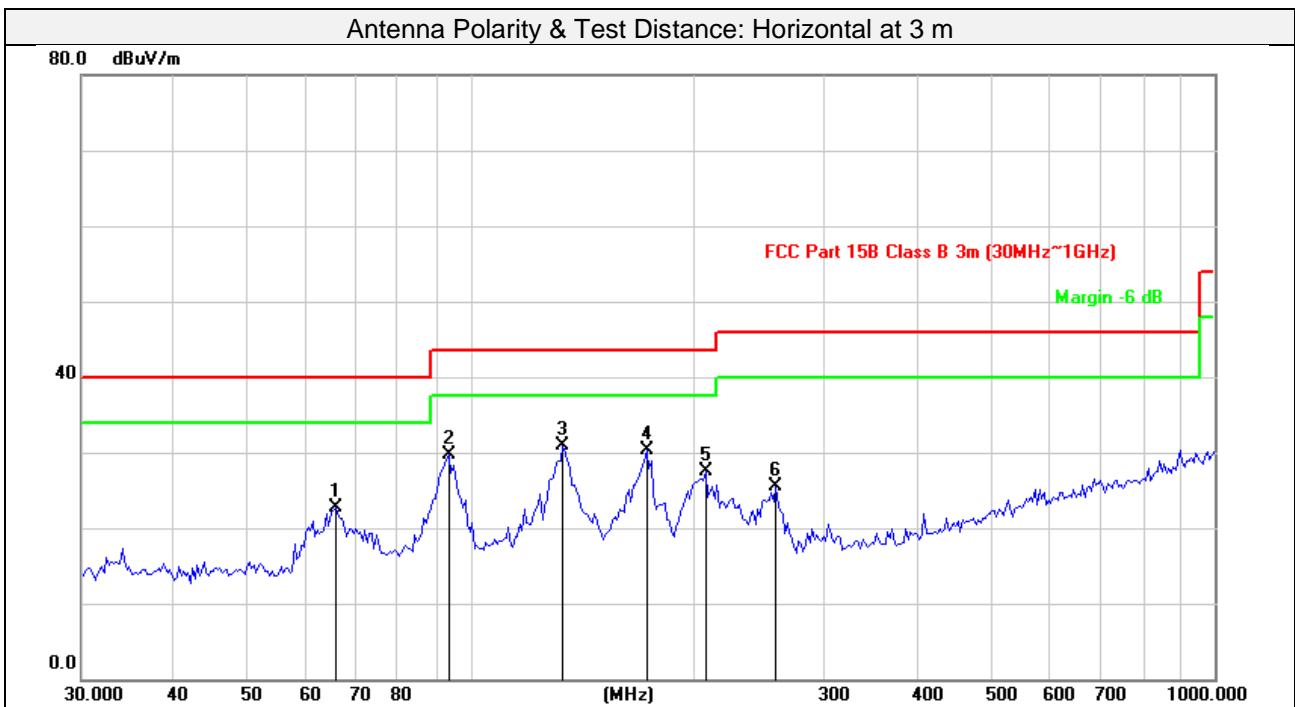

No.	Frequency (MHz)	Reading (dBuV)	Factor (dB)	Emission Level (dBuV/m)	Limit (dBuV/m)	Margin (dB)	Detector	Antenna Height (cm)	Table Angle (Degree)
1	65.9067	45.49	-22.87	22.62	40.00	-17.38	peak	200	125
2	93.6532	53.64	-24.02	29.62	43.50	-13.88	peak	100	45
3	133.0809	52.22	-21.38	30.84	43.50	-12.66	peak	200	187
4	172.5976	49.16	-18.90	30.26	43.50	-13.24	peak	100	217
5	207.1967	49.92	-22.41	27.51	43.50	-15.99	peak	200	230
6	257.6265	46.40	-20.94	25.46	46.00	-20.54	peak	100	168

Remarks:

- 1.Emission Level = Read Level + Factor (Antenna Factor + Cable Loss - Preamp Factor)
- 2.Margin value = Emission level – Limit value



Frequency Range	30MHz ~ 1GHz	Detector Function	Peak (PK) Quasi-peak (QP)
Test Channel	Channel 0		

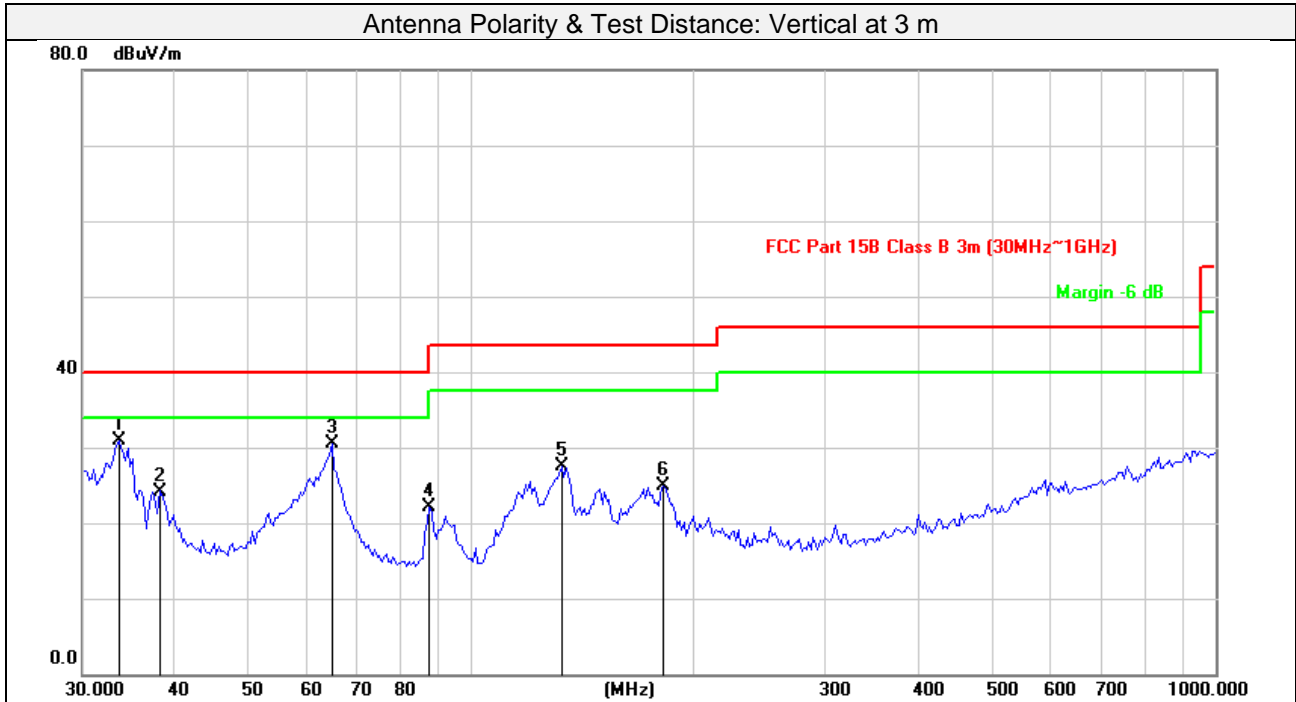

No.	Frequency (MHz)	Reading (dBuV)	Factor (dB)	Emission Level (dBuV/m)	Limit (dBuV/m)	Margin (dB)	Detector	Antenna Height (cm)	Table Angle (Degree)
1 *	33.5700	53.45	-22.64	30.81	40.00	-9.19	peak	100	247
2	38.0964	46.80	-22.60	24.20	40.00	-15.80	peak	200	255
3	64.9869	53.39	-22.85	30.54	40.00	-9.46	peak	200	269
4	87.9136	46.34	-24.23	22.11	40.00	-17.89	peak	100	168
5	132.1489	48.85	-21.44	27.41	43.50	-16.09	peak	100	130
6	181.3000	44.94	-20.13	24.81	43.50	-18.69	peak	300	125

Remarks:

1. Emission Level = Read Level + Factor (Antenna Factor + Cable Loss - Preamp Factor)
2. Margin value = Emission level – Limit value



Above 1GHz Data:

GFSK

Frequency Range	1GHz ~ 25GHz	Detector Function	Peak (PK) Average (AVG)
Test Channel	Channel 0		

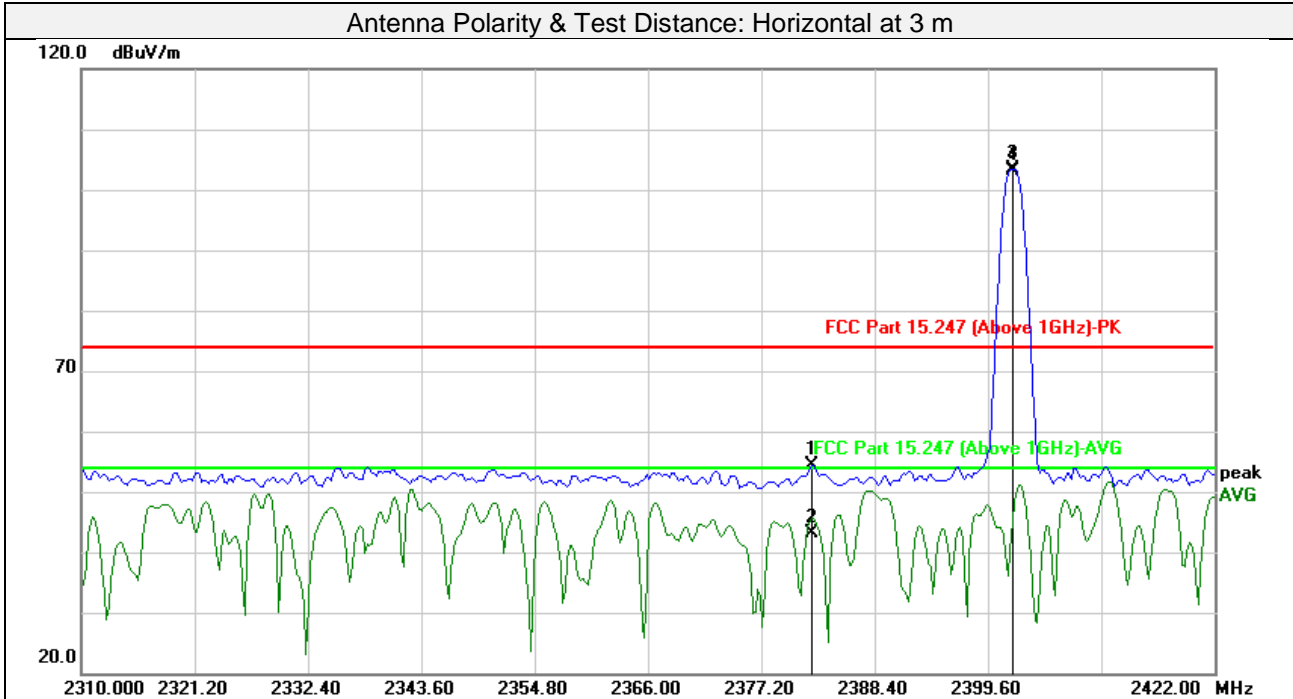

No.	Frequency (MHz)	Reading (dBuV)	Factor (dB)	Emission Level (dBuV/m)	Limit (dBuV/m)	Margin (dB)	Detector	Antenna Height (cm)	Table Angle (Degree)
1	2382.273	56.71	-2.40	54.31	74.00	-19.69	peak	354	227
2	2382.273	45.55	-2.40	43.15	54.00	-10.85	AVG	354	227
3#	2402.024	105.84	-2.39	103.45			peak	354	227
4#	2402.024	105.62	-2.39	103.23			AVG	354	227
5	3603.000	58.75	-0.59	58.16	74.00	-15.84	peak	117	372
6	3603.000	43.26	-0.59	42.67	54.00	-11.33	AVG	117	372
7	4804.000	54.01	2.63	56.64	74.00	-17.36	peak	279	61
8	4804.000	40.00	2.63	42.63	54.00	-11.37	AVG	279	61
9	7206.000	48.81	9.41	58.22	74.00	-15.78	peak	100	103
10	7206.000	34.49	9.41	43.90	54.00	-10.10	AVG	100	103

Remarks:

- Emission Level = Read Level + Factor (Antenna Factor + Cable Loss - Preamp Factor)
Margin value = Emission level – Limit value
- #2402MHz: Fundamental frequency.



Frequency Range	1GHz ~ 25GHz	Detector Function	Peak (PK) Average (AVG)
Test Channel	Channel 0		

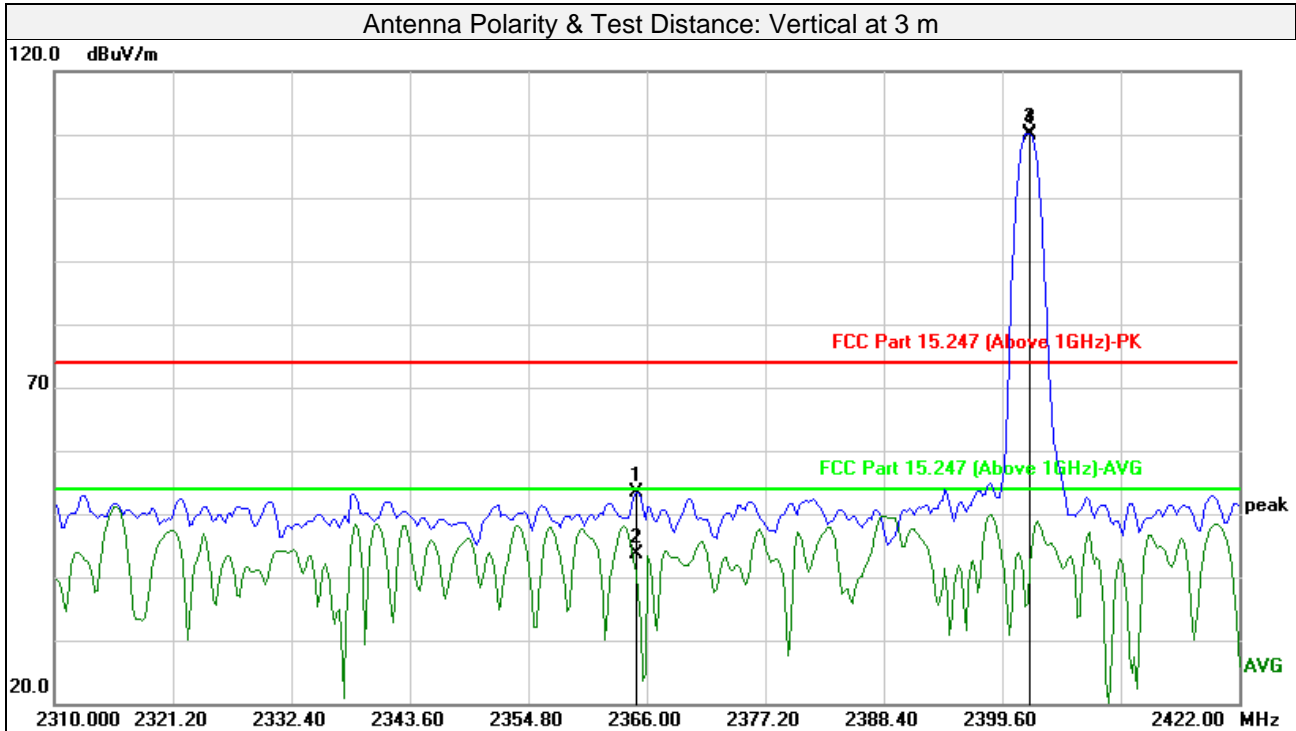

No.	Frequency (MHz)	Reading (dBuV)	Factor (dB)	Emission Level (dBuV/m)	Limit (dBuV/m)	Margin (dB)	Detector	Antenna Height (cm)	Table Angle (Degree)
1	2364.990	55.77	-2.43	53.34	74.00	-20.66	peak	252	116
2	2364.990	46.18	-2.43	43.75	54.00	-10.25	AVG	252	116
3#	2402.249	112.41	-2.39	110.02			peak	252	116
4#	2402.249	112.23	-2.39	109.84			AVG	252	116
5	3603.000	64.65	-0.59	64.06	74.00	-9.94	peak	100	73
6	3603.000	46.82	-0.59	46.23	54.00	-7.77	AVG	100	73
7	4804.000	54.83	2.63	57.46	74.00	-16.54	peak	100	150
8	4804.000	40.73	2.63	43.36	54.00	-10.64	AVG	100	150
9	7206.000	50.72	9.41	60.13	74.00	-13.87	peak	100	189
10	7206.000	37.83	9.41	47.24	54.00	-6.76	AVG	100	189

Remarks:

1. Emission Level = Read Level + Factor (Antenna Factor + Cable Loss - Preamp Factor)

Margin value = Emission level – Limit value

2. #2402MHz: Fundamental frequency.



Frequency Range	1GHz ~ 25GHz	Detector Function	Peak (PK) Average (AVG)
Test Channel	Channel 39		

Antenna Polarity & Test Distance: Horizontal at 3 m									
No.	Frequency (MHz)	Reading (dBuV)	Factor (dB)	Emission Level (dBuV/m)	Limit (dBuV/m)	Margin (dB)	Detector	Antenna Height (cm)	Table Angle (Degree)
1 #	2440.820	104.13	-2.34	101.79			peak	179	244
2 #	2440.820	103.93	-2.34	101.59			AVG	179	244
3	3660.000	58.12	-0.46	57.66	74.00	-16.34	peak	100	74
4	3660.000	42.97	-0.46	42.51	54.00	-11.49	AVG	100	74
5	4880.000	54.23	3.58	57.81	74.00	-16.19	peak	247	240
6	4880.000	40.04	3.58	43.62	54.00	-10.38	AVG	247	240
7	7320.000	46.67	9.64	56.31	74.00	-17.69	peak	230	160
8	7320.000	30.69	9.64	40.33	54.00	-13.67	AVG	230	160
Antenna Polarity & Test Distance: Vertical at 3 m									
No.	Frequency (MHz)	Reading (dBuV)	Factor (dB)	Emission Level (dBuV/m)	Limit (dBuV/m)	Margin (dB)	Detector	Antenna Height (cm)	Table Angle (Degree)
1#	2440.820	113.41	-2.34	111.07			peak	220	65
2#	2440.820	113.20	-2.34	110.86			AVG	220	65
3	3660.000	64.39	-0.46	63.93	74.00	-10.07	peak	166	82
4	3660.000	47.27	-0.46	46.81	54.00	-7.19	AVG	166	82
5	4880.000	56.06	3.58	59.64	74.00	-14.36	peak	247	240
6	4880.000	41.07	3.58	44.65	54.00	-9.35	AVG	247	240
7	7320.000	48.24	9.64	57.88	74.00	-16.12	peak	245	360
8	7320.000	33.00	9.64	42.64	54.00	-11.36	AVG	245	360

Remarks:

- Emission Level = Read Level + Factor (Antenna Factor + Cable Loss - Preamp Factor)
Margin value = Emission level – Limit value
- #2441MHz: Fundamental frequency.



Frequency Range	1GHz ~ 25GHz	Detector Function	Peak (PK) Average (AVG)
Test Channel	Channel 78		

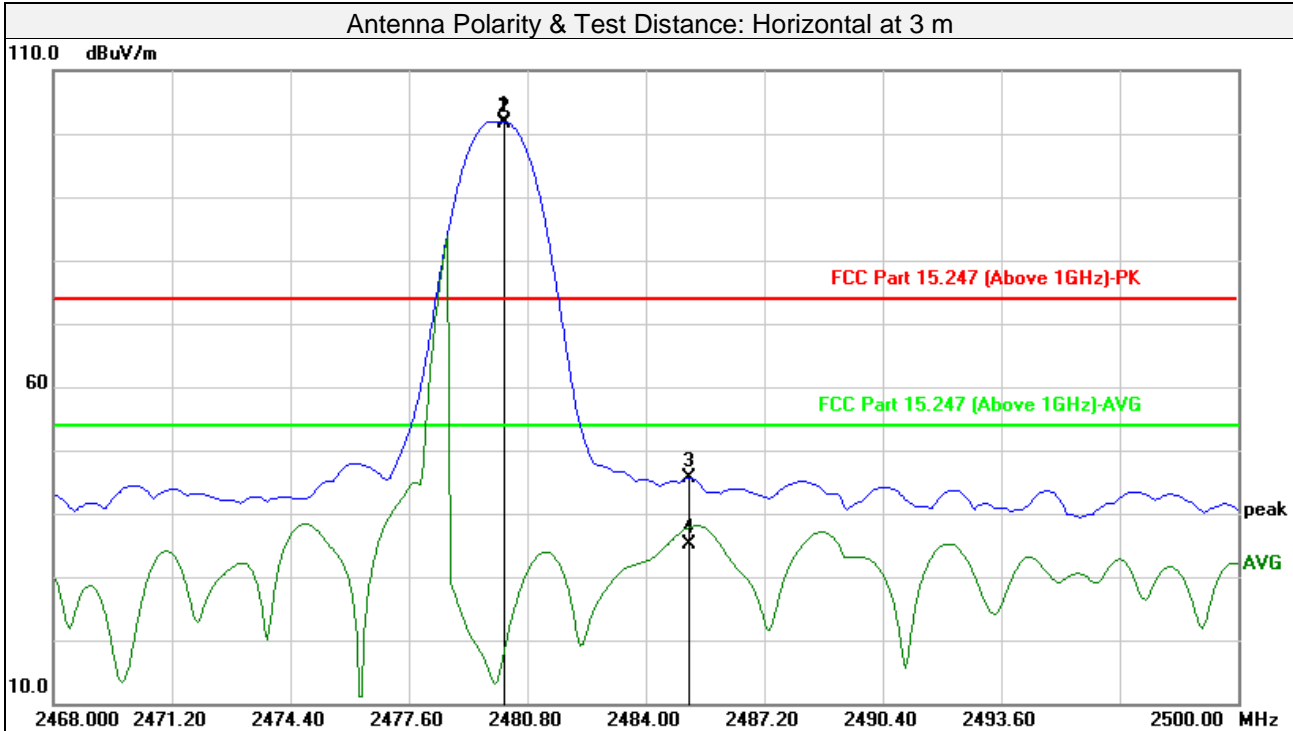

No.	Frequency (MHz)	Reading (dBuV)	Factor (dB)	Emission Level (dBuV/m)	Limit (dBuV/m)	Margin (dB)	Detector	Antenna Height (cm)	Table Angle (Degree)
1#	2480.184	104.16	-2.29	101.87			peak	100	257
2#	2480.184	103.96	-2.29	101.67			AVG	100	257
3	2485.186	47.85	-2.28	45.57	74.00	-28.43	peak	100	257
4	2485.186	37.42	-2.28	35.14	54.00	-18.86	AVG	100	257
5	3660.000	57.61	-0.46	57.15	74.00	-16.85	peak	100	102
6	3660.000	42.87	-0.46	42.41	54.00	-11.59	AVG	100	102
7	4960.000	56.85	3.50	60.35	74.00	-13.65	peak	100	122
8	4960.000	41.47	3.50	44.97	54.00	-9.03	AVG	100	122
9	7440.000	47.43	9.88	57.31	74.00	-16.69	peak	136	250
10	7440.000	31.48	9.88	41.36	54.00	-12.64	AVG	136	250

Remarks:

- Emission Level = Read Level + Factor (Antenna Factor + Cable Loss - Preamp Factor)
Margin value = Emission level – Limit value
- #2480MHz: Fundamental frequency.



Frequency Range	1GHz ~ 25GHz	Detector Function	Peak (PK) Average (AVG)
Test Channel	Channel 78		

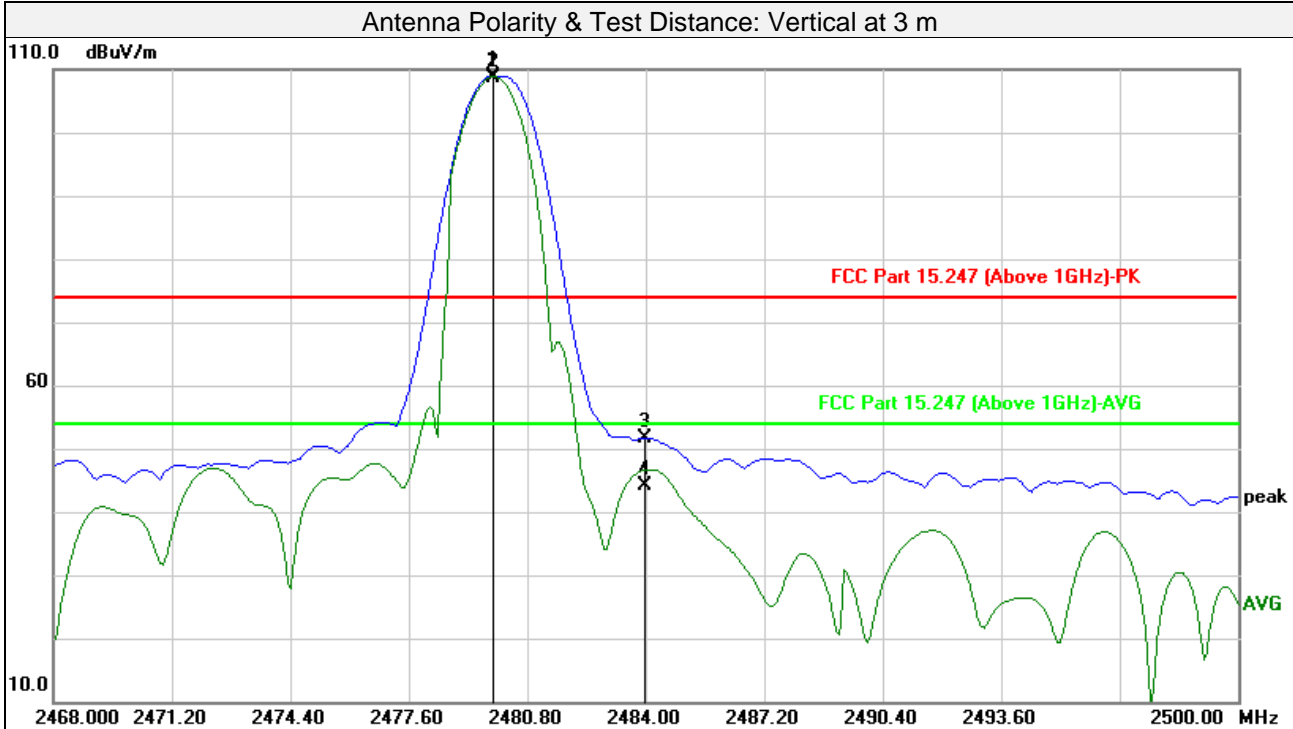

No.	Frequency (MHz)	Reading (dBuV)	Factor (dB)	Emission Level (dBuV/m)	Limit (dBuV/m)	Margin (dB)	Detector	Antenna Height (cm)	Table Angle (Degree)
1#	2479.864	111.19	-2.29	108.90			peak	120	138
2#	2479.864	110.98	-2.29	108.69			AVG	120	138
3	2483.968	53.97	-2.29	51.68	74.00	-22.32	peak	120	138
4	2483.968	46.43	-2.29	44.14	54.00	-9.86	AVG	120	138
5	3660.000	66.84	-0.46	66.38	74.00	-7.62	peak	100	81
6	3660.000	48.33	-0.46	47.87	54.00	-6.13	AVG	100	81
7	4960.000	57.63	3.50	61.13	74.00	-12.87	peak	127	132
8	4960.000	42.39	3.50	45.89	54.00	-8.11	AVG	127	132
9	7440.000	48.43	9.88	58.31	74.00	-15.69	peak	100	200
10	7440.000	32.99	9.88	42.87	54.00	-11.13	AVG	100	200

Remarks:

- Emission Level = Read Level + Factor (Antenna Factor + Cable Loss - Preamp Factor)
Margin value = Emission level – Limit value
- #The 2480MHz: Fundamental frequency.



8DPSK

Frequency Range	1GHz ~ 25GHz	Detector Function	Peak (PK) Average (AVG)
Test Channel	Channel 0		

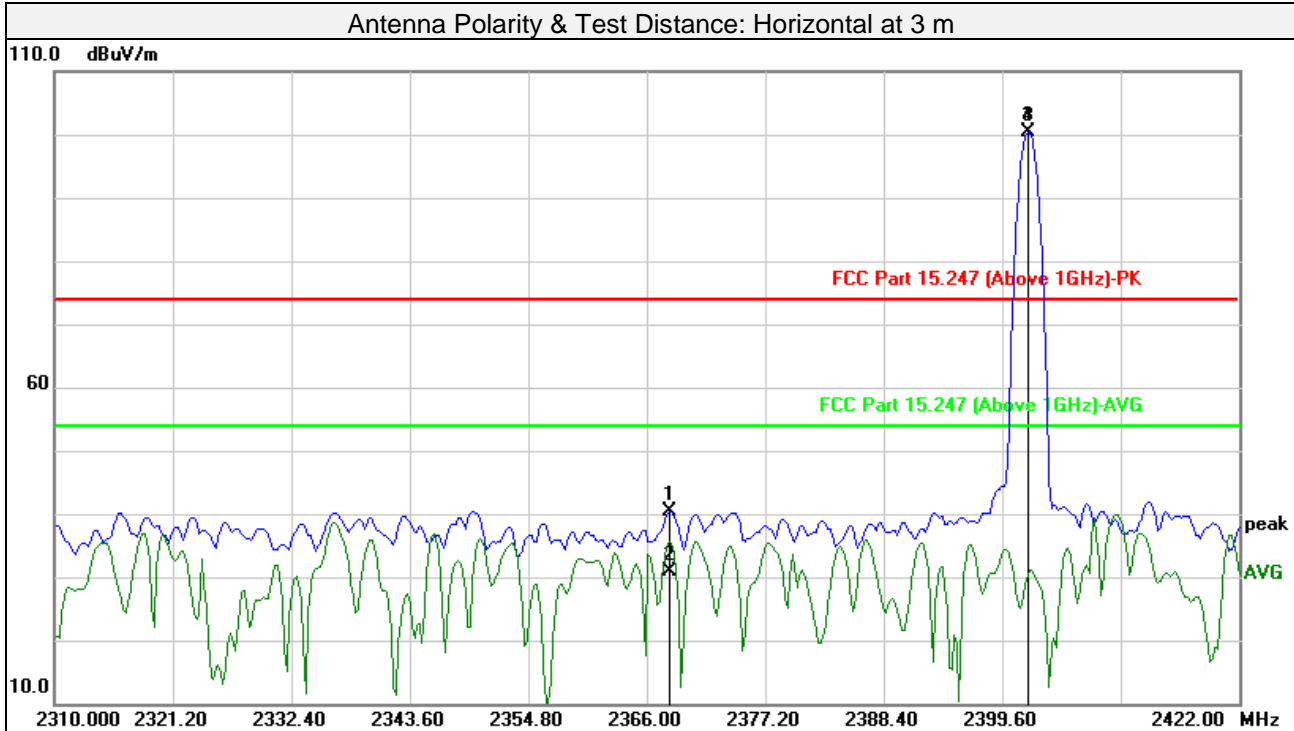

No.	Frequency (MHz)	Reading (dBuV)	Factor (dB)	Emission Level (dBuV/m)	Limit (dBuV/m)	Margin (dB)	Detector	Antenna Height (cm)	Table Angle (Degree)
1	2368.132	42.69	-2.41	40.28	74.00	-33.72	peak	147	261
2	2368.132	33.25	-2.41	30.84	54.00	-23.16	AVG	147	261
3#	2402.024	102.83	-2.39	100.44			peak	147	261
4#	2402.024	102.83	-2.39	100.44			AVG	147	261
5	3660.000	56.46	-0.46	56.00	74.00	-18.00	peak	100	124
6	3660.000	42.37	-0.46	41.91	54.00	-12.09	AVG	100	124
7	4804.000	58.81	2.63	61.44	74.00	-12.56	peak	235	360
8	4804.000	43.16	2.63	45.79	54.00	-8.21	AVG	235	360
9	7206.000	50.92	9.41	60.33	74.00	-13.67	peak	100	164
10	7206.000	35.98	9.41	45.39	54.00	-8.61	AVG	100	164

Remarks:

- Emission Level = Read Level + Factor (Antenna Factor + Cable Loss - Preamp Factor)
Margin value = Emission level – Limit value
- #2402MHz: Fundamental frequency.



Frequency Range	1GHz ~ 25GHz	Detector Function	Peak (PK) Average (AVG)
Test Channel	Channel 0		

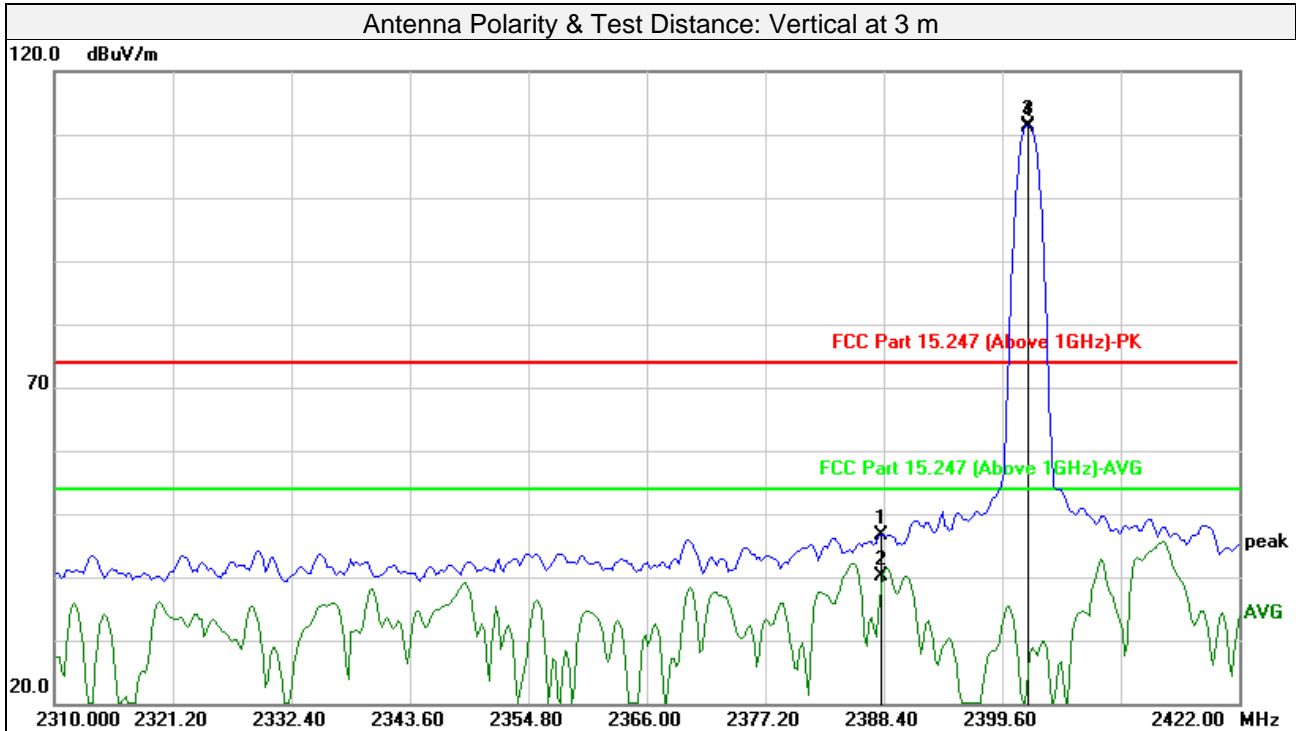

No.	Frequency (MHz)	Reading (dBuV)	Factor (dB)	Emission Level (dBuV/m)	Limit (dBuV/m)	Margin (dB)	Detector	Antenna Height (cm)	Table Angle (Degree)
1	2388.108	49.06	-2.40	46.66	74.00	-27.34	peak	208	96
2	2388.108	42.52	-2.40	40.12	54.00	-13.88	AVG	208	96
3#	2402.024	113.69	-2.39	111.30			peak	208	96
4#	2402.024	113.62	-2.39	111.23			AVG	208	96
5	3660.000	64.23	-0.46	63.77	74.00	-10.23	peak	100	61
6	3660.000	48.73	-0.46	48.27	54.00	-5.73	AVG	100	61
7	4804.000	59.70	2.63	62.33	74.00	-11.67	peak	200	320
8	4804.000	43.35	2.63	45.98	54.00	-8.02	AVG	200	320
9	7206.000	52.15	9.41	61.56	74.00	-12.44	peak	250	100
10	7206.000	36.25	9.41	45.66	54.00	-8.34	AVG	250	100

Remarks:

1. Emission Level = Read Level + Factor (Antenna Factor + Cable Loss - Preamp Factor)

Margin value = Emission level – Limit value

2. #2402MHz: Fundamental frequency.



Frequency Range	1GHz ~ 25GHz	Detector Function	Peak (PK) Average (AVG)
Test Channel	Channel 39		

Antenna Polarity & Test Distance: Horizontal at 3 m									
No.	Frequency (MHz)	Reading (dBuV)	Factor (dB)	Emission Level (dBuV/m)	Limit (dBuV/m)	Margin (dB)	Detector	Antenna Height (cm)	Table Angle (Degree)
1#	2440.980	104.17	-2.34	101.83			peak	120	246
2#	2440.980	104.12	-2.34	101.78			AVG	120	246
3	3660.000	57.22	-0.46	56.76	74.00	-17.24	peak	100	104
4	3660.000	42.81	-0.46	42.35	54.00	-11.65	AVG	100	104
5	4882.000	55.04	3.60	58.64	74.00	-15.36	peak	100	231
6	4882.000	40.71	3.60	44.31	54.00	-9.69	AVG	100	231
7	7323.000	49.03	9.64	58.67	74.00	-15.33	peak	100	200
8	7323.000	34.02	9.64	43.66	54.00	-10.34	AVG	100	200
Antenna Polarity & Test Distance: Vertical at 3 m									
No.	Frequency (MHz)	Reading (dBuV)	Factor (dB)	Emission Level (dBuV/m)	Limit (dBuV/m)	Margin (dB)	Detector	Antenna Height (cm)	Table Angle (Degree)
1#	2440.980	113.96	-2.34	111.62			peak	233	100
2#	2440.980	113.96	-2.34	111.62			AVG	233	100
3	3660.000	64.69	-0.46	64.23	74.00	-9.77	peak	100	39
4	3660.000	46.54	-0.46	46.08	54.00	-7.92	AVG	100	39
5	4882.000	56.22	3.60	59.82	74.00	-14.18	peak	123	300
6	4882.000	41.98	3.60	45.58	54.00	-8.42	AVG	123	300
7	7323.000	50.70	9.64	60.34	74.00	-13.66	peak	100	100
8	7323.000	36.02	9.64	45.66	54.00	-8.34	AVG	100	100

Remarks:

- Emission Level = Read Level + Factor (Antenna Factor + Cable Loss - Preamp Factor)
Margin value = Emission level – Limit value
- #2441MHz: Fundamental frequency.



Frequency Range	1GHz ~ 25GHz	Detector Function	Peak (PK) Average (AVG)
Test Channel	Channel 78		

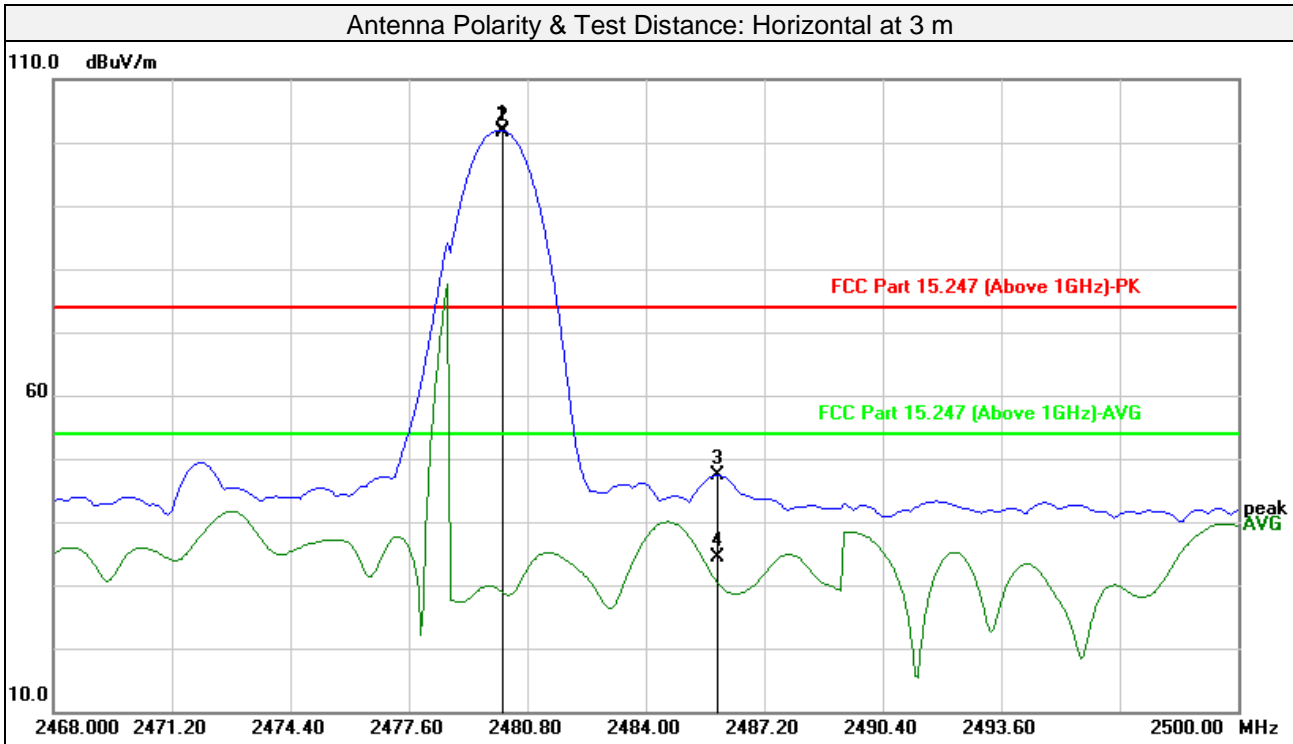

No.	Frequency (MHz)	Reading (dBuV)	Factor (dB)	Emission Level (dBuV/m)	Limit (dBuV/m)	Margin (dB)	Detector	Antenna Height (cm)	Table Angle (Degree)
1#	2480.120	104.13	-2.29	101.84			peak	100	259
2#	2480.120	104.04	-2.29	101.75			AVG	100	259
3	2485.956	49.59	-2.28	47.31	74.00	-26.69	peak	100	259
4	2485.956	36.61	-2.28	34.33	54.00	-19.67	AVG	100	259
5	3660.000	57.82	-0.46	57.36	74.00	-16.64	peak	100	91
6	3660.000	42.77	-0.46	42.31	54.00	-11.69	AVG	100	91
7	4960.000	54.86	3.50	58.36	74.00	-15.64	peak	245	236
8	4960.000	40.15	3.50	43.65	54.00	-10.35	AVG	245	236
9	7440.000	47.98	9.88	57.86	74.00	-16.14	peak	100	360
10	7440.000	32.43	9.88	42.31	54.00	-11.69	AVG	100	360

Remarks:

3. Emission Level = Read Level + Factor (Antenna Factor + Cable Loss - Preamp Factor)
Margin value = Emission level – Limit value
4. #2480MHz: Fundamental frequency.



Frequency Range	1GHz ~ 25GHz	Detector Function	Peak (PK) Average (AVG)
Test Channel	Channel 78		

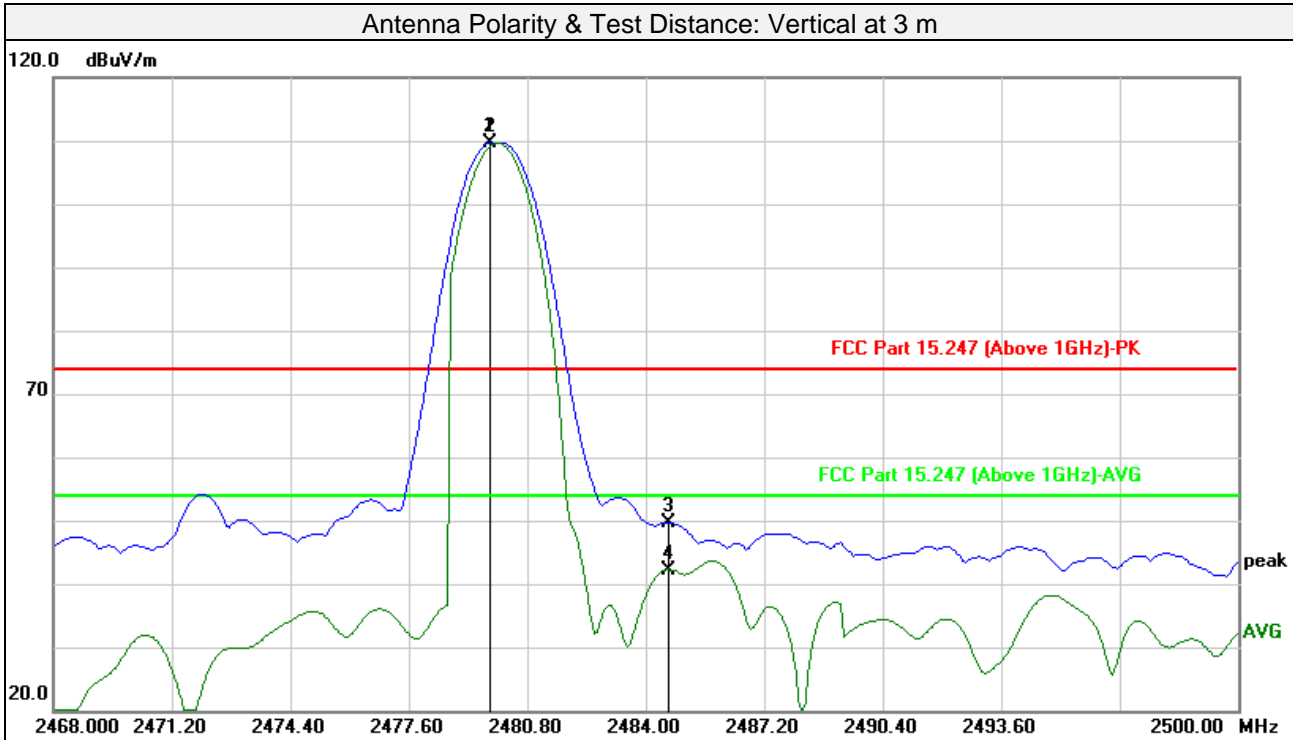

No.	Frequency (MHz)	Reading (dBuV)	Factor (dB)	Emission Level (dBuV/m)	Limit (dBuV/m)	Margin (dB)	Detector	Antenna Height (cm)	Table Angle (Degree)
1#	2479.800	111.91	-2.29	109.62			peak	100	83
2#	2479.800	111.86	-2.29	109.57			AVG	100	83
3	2484.609	52.00	-2.28	49.72	74.00	-24.28	peak	100	83
4	2484.609	44.49	-2.28	42.21	54.00	-11.79	AVG	100	83
5	3660.000	67.11	-0.46	66.65	74.00	-7.35	peak	100	65
6	3660.000	48.72	-0.46	48.26	54.00	-5.74	AVG	100	65
7	4960.000	57.22	3.50	60.72	74.00	-13.28	peak	100	119
8	4960.000	41.82	3.50	45.32	54.00	-8.68	AVG	100	119
9	7440.000	48.76	9.88	58.64	74.00	-15.36	peak	100	200
10	7440.000	34.01	9.88	43.89	54.00	-10.11	AVG	100	200

Remarks:

- Emission Level = Read Level + Factor (Antenna Factor + Cable Loss - Preamp Factor)
Margin value = Emission level – Limit value
- #The 2480MHz: Fundamental frequency.



3.2 Conducted Emission Measurement

3.2.1 Limits of Conducted Emission Measurement

Frequency (MHz)	Conducted Limit (dBuV)	
	Quasi-peak	Average
0.15 - 0.5	66 - 56	56 - 46
0.50 - 5.0	56	46
5.0 - 30.0	60	50

Note: 1. The lower limit shall apply at the transition frequencies.
 2. The limit decreases in line with the logarithm of the frequency in the range of 0.15 to 0.50MHz.

3.2.2 Test Instruments

Description & Manufacturer	Model No.	Serial No.	Due Date of Calibration
EMI Test Receiver Rohde&Schwarz	ESCI3	101418	2022/09/12
Artificial Mains Network Rohde&Schwarz	ENV216	3560.6550.15	2022/09/12
Test software FARAD	EZ_EMCC V1.1.4.2	N/A	N/A
Hygrothermograph Yuhuaze	HTC-1	NA	2022/09/12
Digital Multimeter FLUKE	15B+	43512617WS	2022/09/12

Note: 1. The calibration interval of the above test instruments is 12 months and the calibrations are traceable to CEPREI/CHINA.
 2. The test was performed in Shielded Room 1.



3.2.3 Test Procedures

- The EUT was placed 0.4 meters from the conducting wall of the shielded room with EUT being connected to the power mains through a line impedance stabilization network (LISN). Other support units were connected to the power mains through another LISN. The two LISNs provide 50 ohm/ 50uH of coupling impedance for the measuring instrument.
- Both lines of the power mains connected to the EUT were checked for maximum conducted interference.
- The frequency range from 150kHz to 30MHz was searched. Emission levels under (Limit – 20dB)was not recorded.

Note: All modes of operation were investigated and the worst-case emissions are reported.

3.2.4 Test Setup

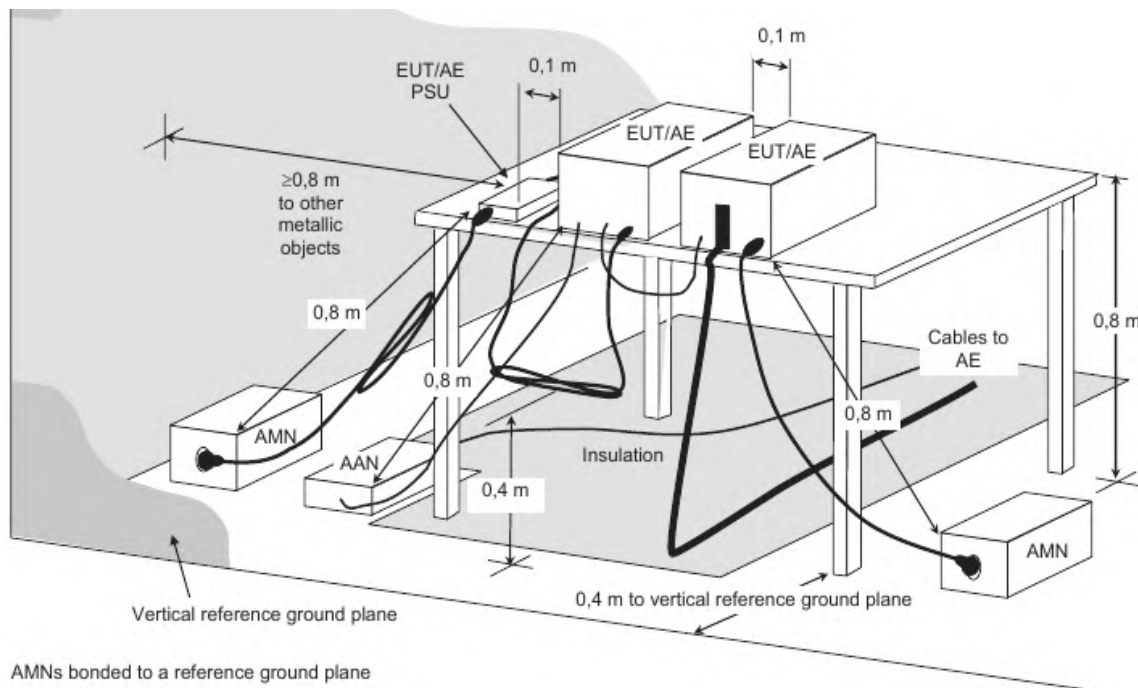

For the actual test configuration, please refer to the attached file (Test Setup Photo).

3.2.5 EUT Operating Condition

Set the EUT under transmission condition continuously at specific channel frequency.

3.2.6 Deviation from Test Standard

No deviation.



3.2.7 Test Results

Frequency Range	150kHz ~ 30MHz	Detector Function & Resolution bandwidth	Quasi-Peak (QP) / Average (AV), 9kHz
-----------------	----------------	--	--------------------------------------

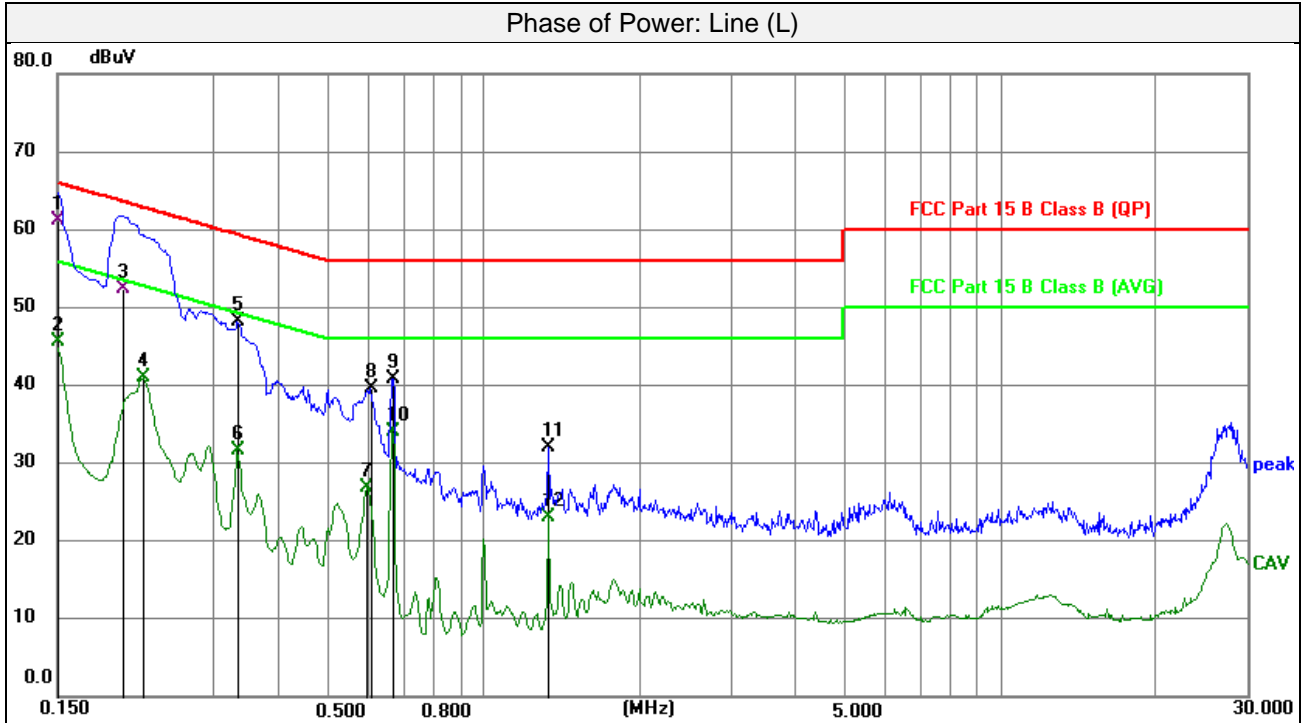

No.	Frequency (MHz)	Reading (dBuV)	Correction Factor (dB)	Emission Level (dBuV)	Limit (dBuV)	Margin (dB)	Remark
1	0.1500	51.47	9.71	61.18	66.00	-4.82	QP
2	0.1500	35.89	9.71	45.60	56.00	-10.40	AVG
3	0.2000	42.57	9.72	52.29	63.61	-11.32	QP
4	0.2198	31.29	9.72	41.01	52.83	-11.82	AVG
5	0.3345	38.47	9.74	48.21	59.34	-11.13	peak
6	0.3345	21.79	9.74	31.53	49.34	-17.81	AVG
7	0.5977	17.09	9.80	26.89	46.00	-19.11	AVG
8	0.6045	29.78	9.80	39.58	56.00	-16.42	peak
9	0.6675	30.98	9.82	40.80	56.00	-15.20	peak
10	0.6675	24.28	9.82	34.10	46.00	-11.90	AVG
11	1.3358	22.10	9.86	31.96	56.00	-24.04	peak
12	1.3358	13.28	9.86	23.14	46.00	-22.86	AVG

Remarks:

1. Q.P. and AV. are abbreviations of quasi-peak and average individually.
2. The emission levels of other frequencies were very low against the limit.
3. Margin value = Emission level - Limit value
4. Correction factor = Insertion loss + Cable loss
5. Emission Level = Correction Factor + Reading Value.



Frequency Range	150kHz ~ 30MHz	Detector Function & Resolution bandwidth	Quasi-Peak (QP) / Average (AV), 9kHz
-----------------	----------------	--	--------------------------------------

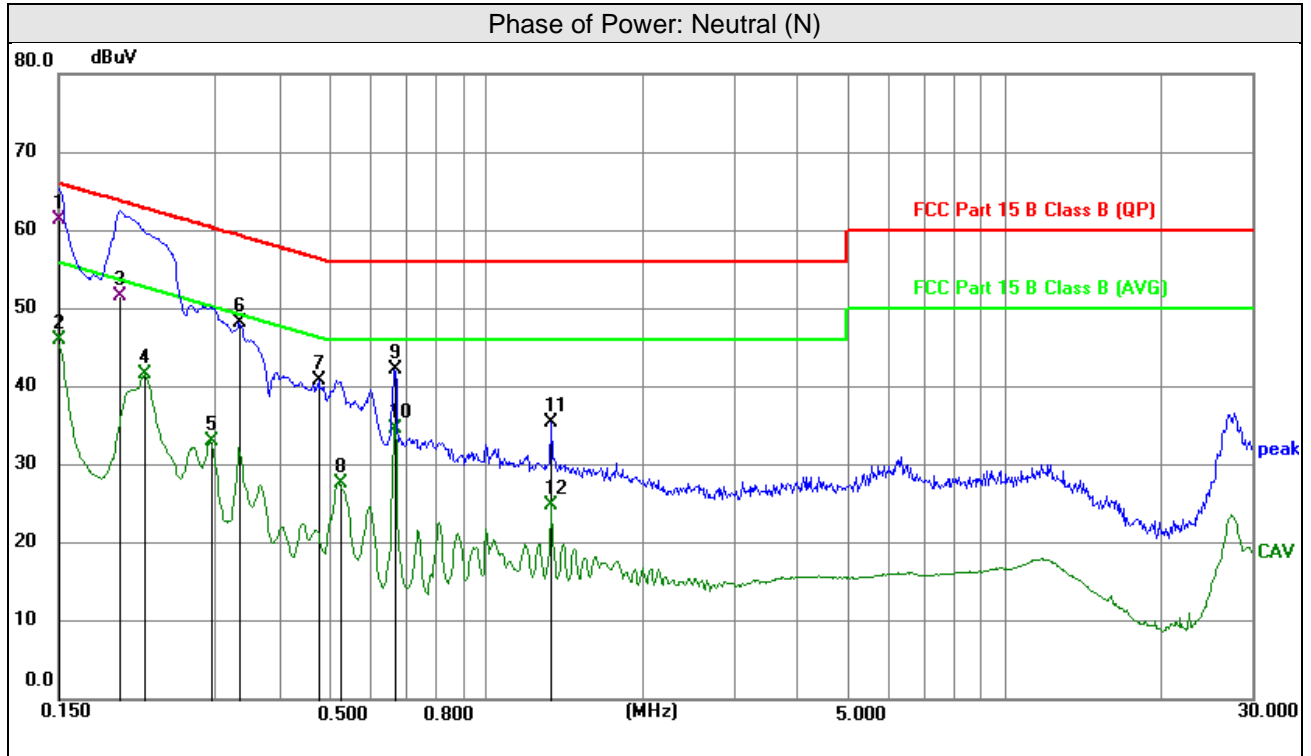

No.	Frequency	Reading	Correct Factor	Emission Level	Limit	Margin	Remark
	(MHz)	(dBuV)	dB	(dBuV)	(dBuV)	(dB)	Detector
1	0.1500	51.61	9.67	61.28	66.00	-4.72	QP
2	0.1500	36.41	9.67	46.08	56.00	-9.92	AVG
3	0.1970	41.83	9.68	51.51	63.74	-12.23	QP
4	0.2198	31.84	9.68	41.52	52.83	-11.31	AVG
5	0.2940	23.29	9.69	32.98	50.41	-17.43	AVG
6	0.3345	38.45	9.68	48.13	59.34	-11.21	peak
7	0.4762	31.09	9.70	40.79	56.41	-15.62	peak
8	0.5212	18.00	9.70	27.70	46.00	-18.30	AVG
9	0.6675	32.54	9.72	42.26	56.00	-13.74	peak
10	0.6675	24.96	9.72	34.68	46.00	-11.32	AVG
11	1.3380	25.75	9.73	35.48	56.00	-20.52	peak
12	1.3380	15.08	9.73	24.81	46.00	-21.19	AVG

Remarks:

1. Q.P. and AV. are abbreviations of quasi-peak and average individually.
2. The emission levels of other frequencies were very low against the limit.
3. Margin value = Emission level - Limit value
4. Correction factor = Insertion loss + Cable loss
5. Emission Level = Correction Factor + Reading Value.



3.3 Number of Hopping Frequency Used

3.3.1 Limits of Hopping Frequency Used Measurement

At least 15 channels frequencies, and should be equally spaced.

3.3.2 Test Setup

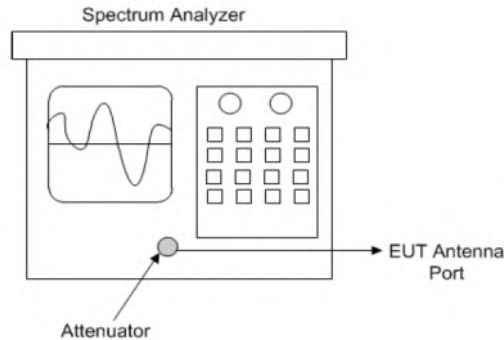

Spectrum analyzer test configuration

3.3.3 Test Instruments

Refer to section 5 to get information of above instrument.

3.3.4 Test Procedure

- Check the calibration of the measuring instrument (SA) using either an internal calibrator or a known signal from an external generator.
- Turn on the EUT and connect its antenna terminal to measurement via a low loss cable. Then set it to any one measured frequency within its operating range and make sure the instrument is operated in its linear range.
- Set the SA on MaxHold Mode, and then keep the EUT in hopping mode. Record all the signals from each channel until each one has been recorded.
- Set the SA on View mode and then plot the result on SA screen.
- Repeat above procedures until all frequencies measured were complete.

3.3.5 Deviation from Test Standard

No deviation.



3.3.6 Test Results

There are 79 hopping frequencies in the hopping mode. Please refer to next page for the test result. On the plots, it shows that the hopping frequencies are equally spaced.





3.4 Dwell Time on Each Channel

3.4.1 Limits of Dwell Time on Each Channel Measurement

The average time of occupancy on any channel shall not be greater than 0.4 seconds within a period of 0.4 seconds multiplied by the number of hopping channels employed.

3.4.2 Test Setup

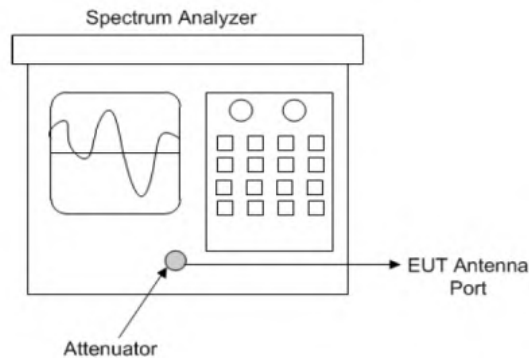

Spectrum analyzer test configuration

3.4.3 Test Instruments

Refer to section 5 to get information of above instrument.

3.4.4 Test Procedures

- Check the calibration of the measuring instrument (SA) using either an internal calibrator or a known signal from an external generator.
- Turn on the EUT and connect its antenna terminal to measurement via a low loss cable. Then set it to any one measured frequency within its operating range and make sure the instrument is operated in its linear range.
- Adjust the center frequency of SA on any frequency be measured and set SA to zero span mode. And then, set RBW and VBW of spectrum analyzer to proper value.
- Measure the time duration of one transmission on the measured frequency. And then plot the result with time difference of this time duration.
- Repeat above procedures until all different time-slot modes have been completed.

3.4.5 Deviation from Test Standard

No deviation.



3.4.6 Test Results

GFSK

Mode	Number of Hopping Channel	Number of transmission in a period (channel number*0.4 sec)				Length of transmission time (msec)	Result (msec)	Limit (msec)	Verdict
		Period (sec)	Sweep time (sec)	times in a sweep	times in a period				
DH1	79	31.6	3.16	33	330	0.39	128.7	400	Pass
DH3	79	31.6	3.16	17	170	1.64	278.8	400	Pass
DH5	79	31.6	3.16	11	110	2.89	317.9	400	Pass

Note: Test plots of the transmitting time slot are shown as below.

8DPSK

Mode	Number of Hopping Channel	Number of transmission in a period (channel number*0.4 sec)				Length of transmission time (msec)	Result (msec)	Limit (msec)	Verdict
		Period (sec)	Sweep time (sec)	times in a sweep	times in a period				
3DH1	79	31.6	3.16	33	330	0.40	132.0	400	Pass
3DH3	79	31.6	3.16	16	160	1.65	264.0	400	Pass
3DH5	79	31.6	3.16	12	120	2.90	348.0	400	Pass

Note: Test plots of the transmitting time slot are shown as below.



GFSK

DH1

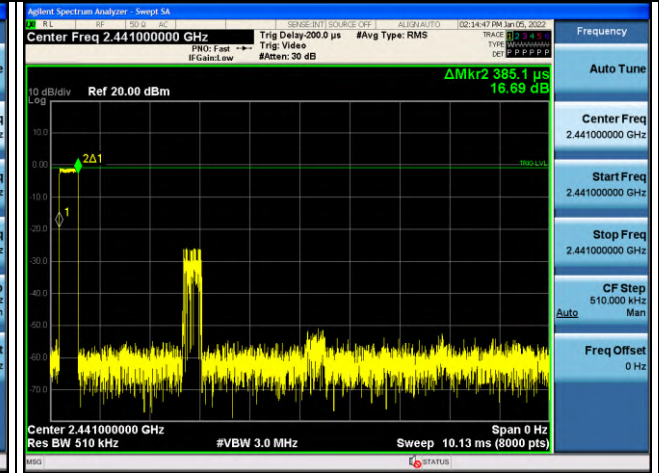
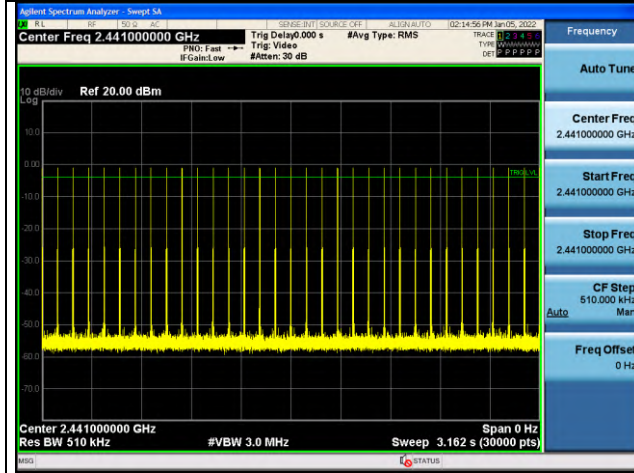

DH3

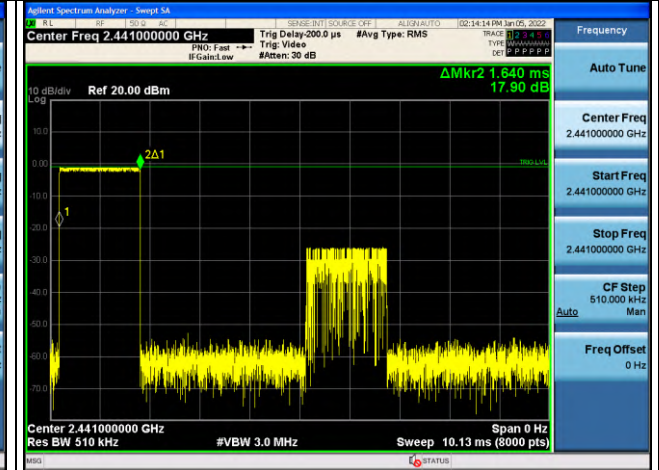
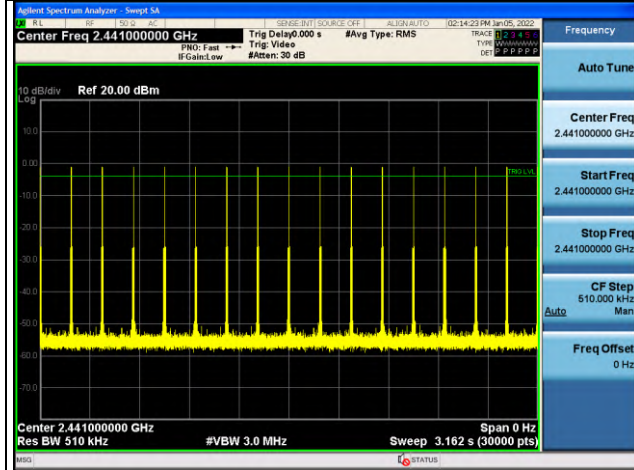

DH5

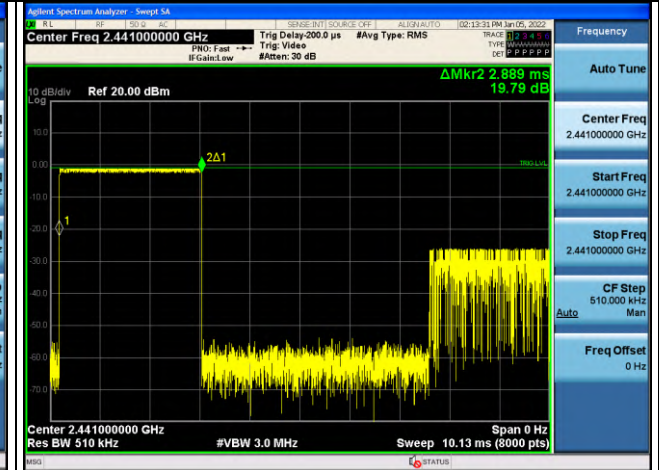
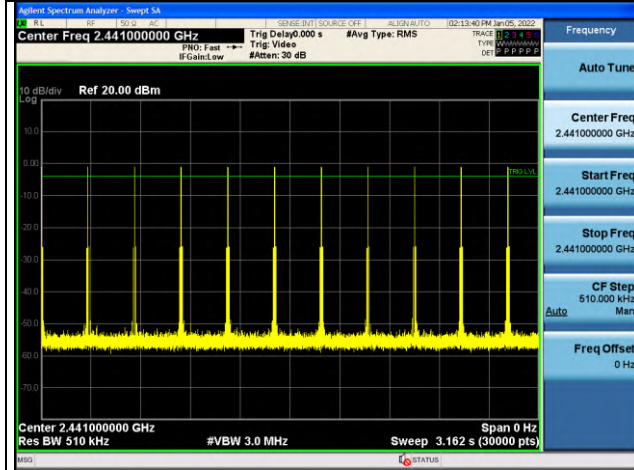



8DPSK

3DH1

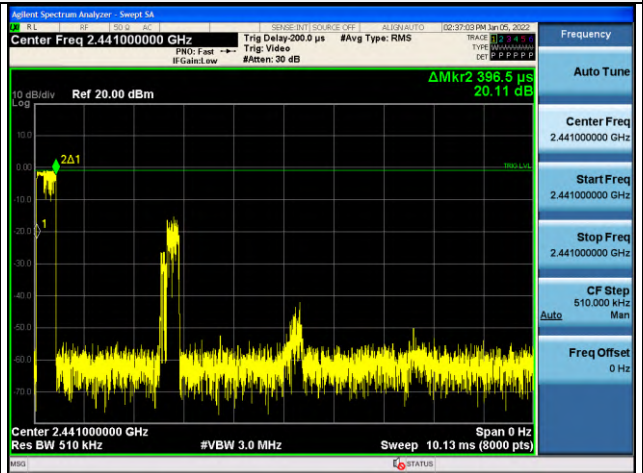
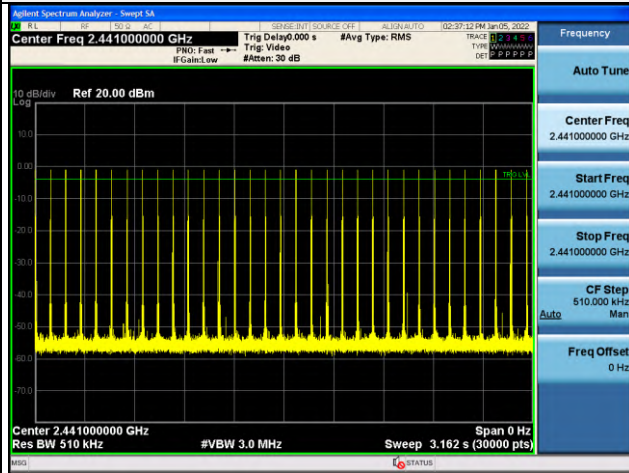

3DH3

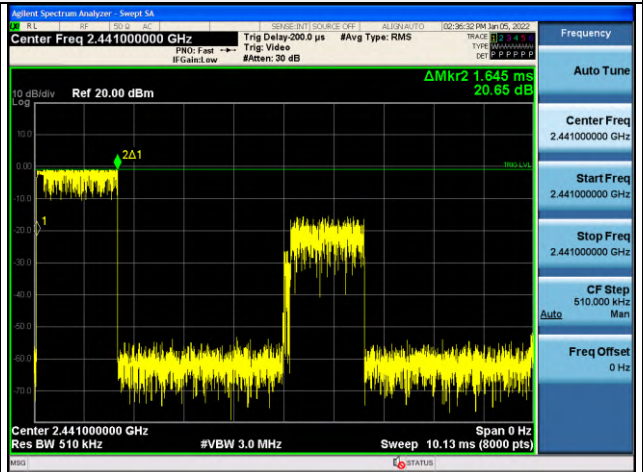
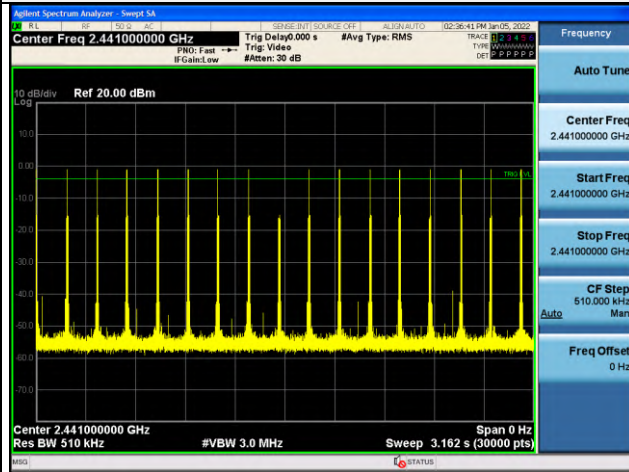

3DH5

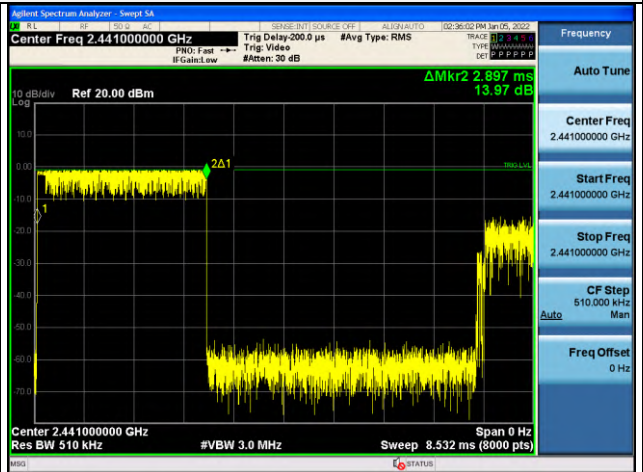
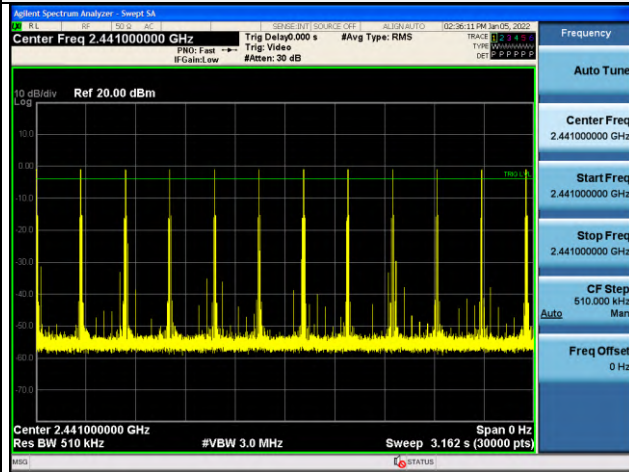



3.5 Channel Bandwidth

3.5.1 Limits of Channel Bandwidth Measurement

For frequency hopping system operating in the 2400-2483.5 MHz, if the 20 dB bandwidth of hopping channel is greater than 25 kHz, two-thirds 20 dB bandwidth of hopping channel shall be a minimum limit for the hopping channel separation.

3.5.2 Test Setup

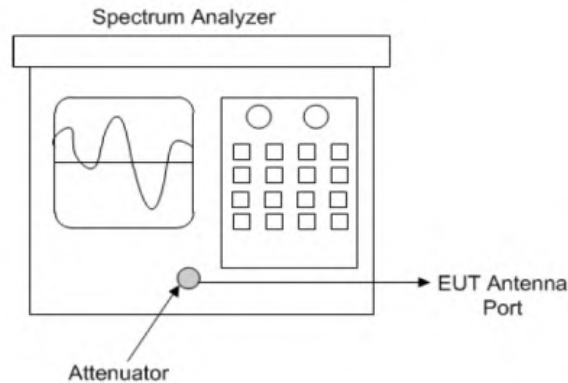

Spectrum analyzer test configuration

3.5.3 Test Instruments

Refer to section 5 to get information of above instrument.

3.5.4 Test Procedure

- Check the calibration of the measuring instrument using either an internal calibrator or a known signal from an external generator.
- Turn on the EUT and connect it to measurement instrument. Then set it to any one convenient frequency within its operating range. Set a reference level on the instrument equal to the highest peak value.
- Measure the frequency difference of two frequencies that were attenuated 20 dB from the reference level. Record the frequency difference as the emission bandwidth.
- Repeat above procedures until all frequencies measured were complete.

3.5.5 Deviation from Test Standard

No deviation.

3.5.6 EUT Operating Condition

The software provided by client enabled the EUT to transmit and receive data at lowest, middle and highest channel frequencies individually.



3.5.7 Test Results

Channel	Frequency (MHz)	20dB Bandwidth (MHz)	
		GFSK	8DPSK
0	2402	1.125	1.383
39	2441	1.086	1.383
78	2480	1.074	1.389





3.6 Occupied Bandwidth Measurement

3.6.1 Test Setup

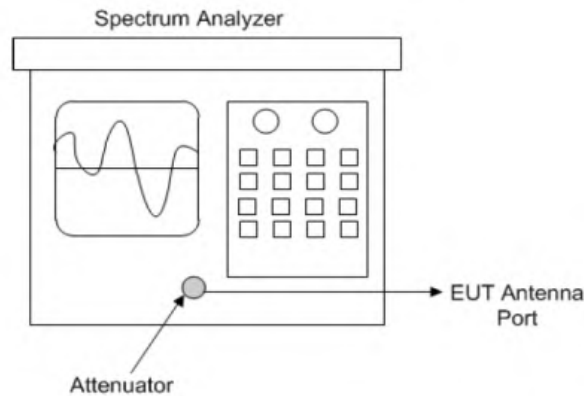

Spectrum analyzer test configuration

3.6.2 Test Instruments

Refer to section 5 to get information of above instrument

3.6.3 Test Procedure

The transmitter output was connected to the spectrum analyzer through an attenuator. The bandwidth of the fundamental frequency was measured by spectrum analyzer with resolution bandwidth in the range of 1% to 5% of the anticipated emission bandwidth, and a video bandwidth at least 3x the resolution bandwidth and set the detector to PEAK. The width of a frequency band such that, below the lower and above the upper frequency limits, the mean powers emitted are each equal to a specified percentage 0.5% of the total mean power of a given emission.

3.6.4 Deviation from Test Standard

No deviation.

3.6.5 EUT Operating Conditions

The software provided by client to enable the EUT under transmission condition continuously at lowest, middle and highest channel frequencies individually.



3.6.6 Test Results

Channel	Frequency (MHz)	OccupiedBandwidth (MHz)	
		GFSK	8DPSK
0	2402	0.85973	1.1935
39	2441	0.87218	1.2023
78	2480	0.88362	1.1910





3.7 Hopping Channel Separation

3.7.1 Limits of Hopping Channel Separation Measurement

At least 25 kHz or two-third of 20 dB hopping channel bandwidth (whichever is greater).

3.7.2 Test Setup

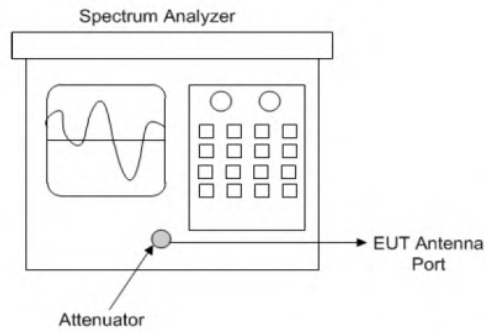

Spectrum analyzer test configuration

3.7.3 Test Instruments

Refer to section 5 to get information of above instrument.

3.7.4 Test Procedure

Measurement Procedure REF

- Check the calibration of the measuring instrument using either an internal calibrator or a known signal from an external generator.
- Turn on the EUT and connect it to measurement instrument. Then set it to any one convenient frequency within its operating range.
- By using the MaxHold function record the separation of two adjacent channels.
- Measure the frequency difference of these two adjacent channels by SA MARK function. And then plot the result on SA screen.
- Repeat above procedures until all frequencies measured were complete.

3.7.5 Deviation from Test Standard

No deviation.



3.7.6 Test Results

Channel No.	Frequency (MHz)	Adjacent Channel Separation (MHz)		Minimum Limit (MHz)		Pass / Fail
		GFSK	8DPSK	GFSK	8DPSK	
0	2402	1.005	1.005	0.75	0.92	Pass
39	2441	1.002	1.005	0.72	0.92	Pass
78	2480	1.005	1.005	0.71	0.92	Pass

Note:The minimum limit is two-third 20 dB bandwidth.



Spectrum Plot

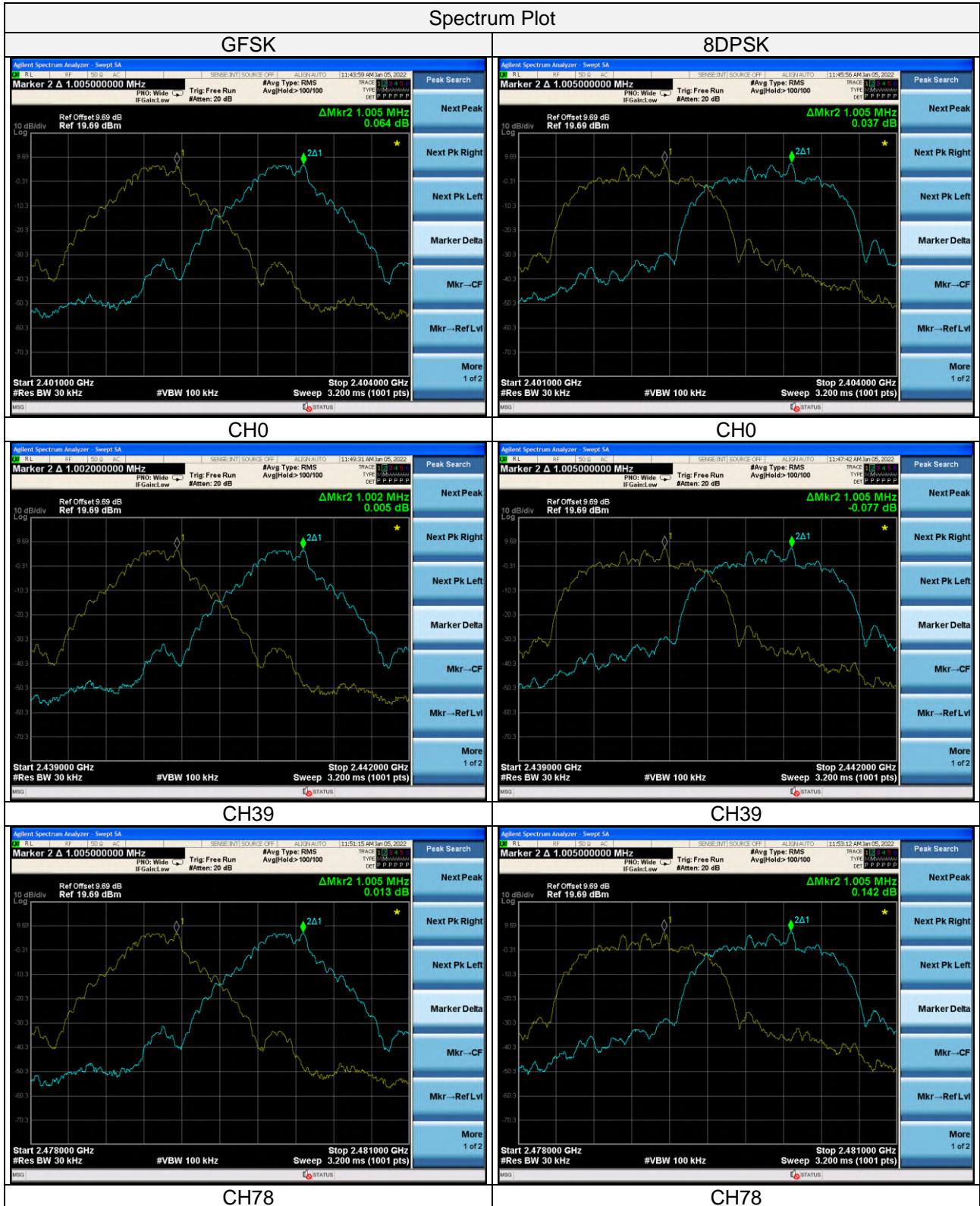



3.8 Maximum Output Power

3.8.1 Limits of Maximum Output Power Measurement

The Maximum Output Power Measurement is 125mW.

3.8.2 Test Setup

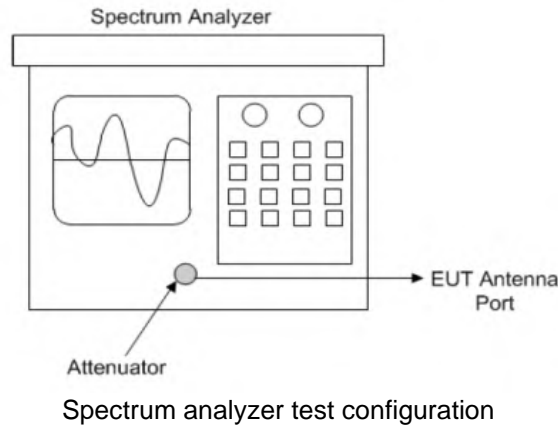

3.8.3 Test Instruments

Refer to section 5 to get information of above instrument.

3.8.4 Test Procedure

Measurement using a spectrum analyzer (SA), Selection of test method:

The proper test method is selected based on the following criteria:

- a) **Method AVGSA-1 or method AVGSA-1A (alternative)** shall be applied if either of the following conditions can be satisfied:
 - 1) The EUT transmits continuously (or with a D> 98%).
 - 2) Sweep triggering can be implemented in such a way that the device transmits at the maximum power control level throughout the duration of each of the instrument sweeps to be averaged. This condition can generally be achieved by triggering the instrument's sweep if the duration of the sweep (with the instrument configured as in method AVGSA-1) is equal to or shorter than the duration T of each transmission from the EUT, and if those transmissions exhibit full power throughout their durations.
- b) **Method AVGSA-2 or method AVGSA-2A (alternative)** shall be applied if the conditions of the preceding item a) cannot be achieved and the transmissions exhibit a constant duty cycle during the measurement duration. Duty cycle will be considered to be constant if variations are less than +2%.
- c) **Method AVGSA-3 or method AVGSA-3A (alternative)** shall be applied if the conditions of the preceding item a) and item b) cannot be achieved.



Method AVGSA-3 or method AVGSA-3A:

- a) Check the calibration of the measuring instrument using either an internal calibrator or a known signal from an external generator.
- b) Turn on the EUT and connect it to measurement instrument. Then set it to any one convenient frequency within its operating range. Set a reference level on the measuring instrument equal to the highest peak value.
- c) SA Setting:
 - 1* Set span to at least 1.5 times the OBW
 - 2* Set sweep trigger to "free run."
 - 3* Set RBW= 1% to 5% of the OBW. not to exceed 1MHz.
 - 4* Set VBW $\geq 3 \times$ RBW
 - 5* Number of points in sweep $\geq 2 \times$ span /RBW.(This gives bin-to-bin spacing \leq RBW / 2. so that narrowband signals are not lost between frequency bins).
 - 6* Sweep time \leq (number of points in sweep) x T. where T is defined in 11.6. If this gives a sweep time less than the auto sweep time of the instrument. then method AVGSA-3 shall not be used (use AVGSA-3A). The purpose of this step is so that the averaging time in each bin is less than or equal to the minimum time of a transmission.
 - 7* Detector =RMS (power averaging).
 - 8* Trace mode =max hold.
 - 9* Allow max hold to run for at least 60 s or longer as needed to allow the trace to stabilize.
 - 10* Compute power by integrating the spectrum across the OBW of the signal using the instrument's band power measurement function with band limits set equal to the OBW band edges. If the instrument does not have a band power function. then sum the spectrum levels (in power units) at intervals equal to the RBW extending across the entire OBW
- d. Measure the captured power within the band and recording the plot.
- e. Repeat above procedures until all frequencies required were complete.

3.8.5 Deviation from Test Standard

No deviation.

3.8.6 EUT Operating Condition

The software provided by client enabled the EUT to transmit and receive data at lowest, middle and highest channel frequencies individually.



3.8.7 Test Results

PEAK POWER

Channel No.	Freq. (MHz)	Output Power (mW)		Output Power (dBm)		Power Limit (mW)	Pass / Fail
		GFSK	8DPSK	GFSK	8DPSK		
0	2402	10.25	16.22	10.11	12.10	125	Pass
39	2441	10.13	16.33	10.06	12.13	125	Pass
78	2480	10.76	17.14	10.32	12.34	125	Pass

AVERAGE POWER

Channel No.	Freq. (MHz)	Output Power (mW)		Output Power (dBm)		Power Limit (mW)	Pass / Fail
		GFSK	8DPSK	GFSK	8DPSK		
0	2402	6.41	6.67	8.07	8.24	125	Pass
39	2441	6.65	7.78	8.23	8.31	125	Pass
78	2480	7.64	7.40	8.83	8.69	125	Pass



Peak Power Spectrum Plot

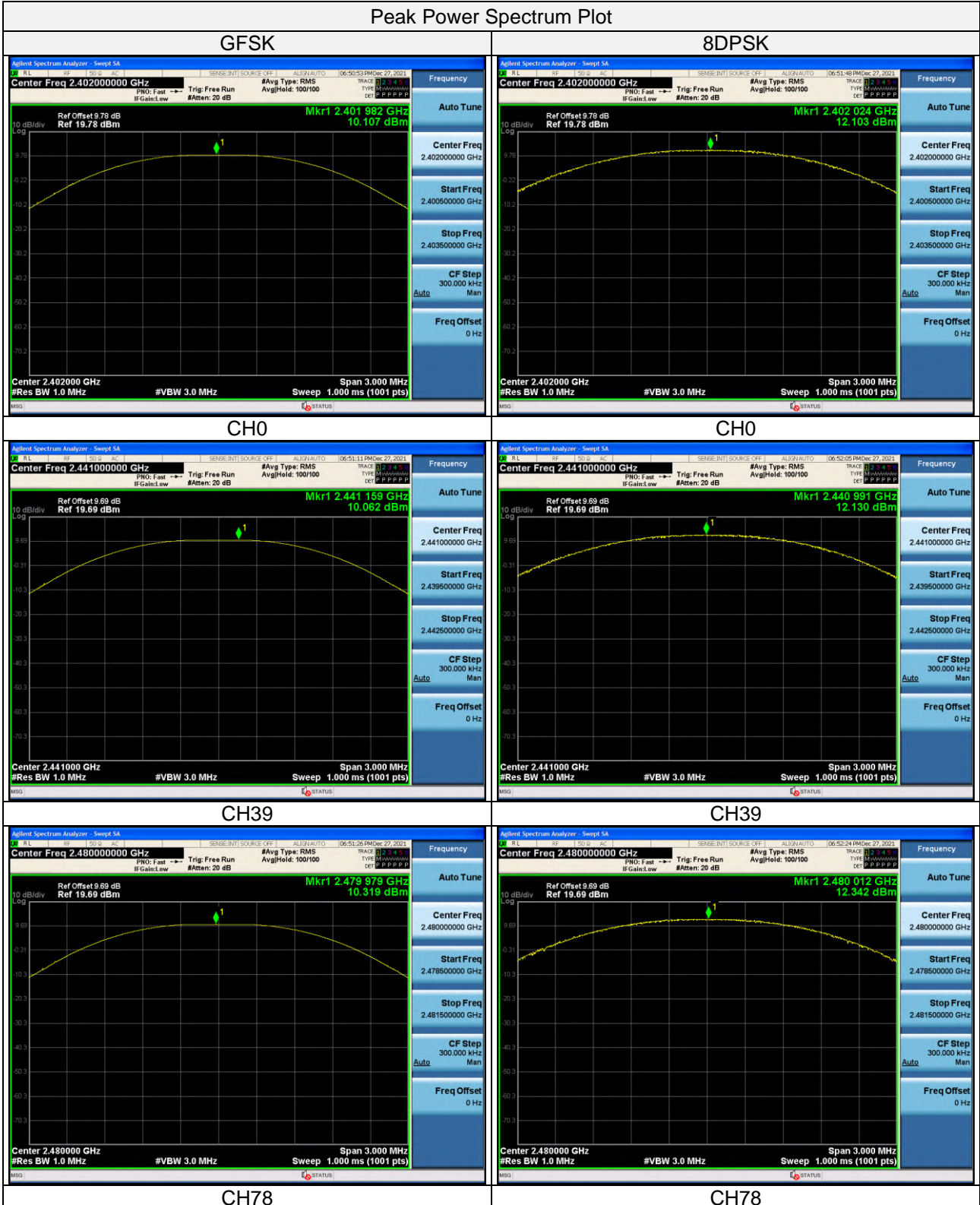

Lab: Hwa-Hsing (Dongguan) Testing Co., Ltd.
Address: No.101, Bld N1, Yuyuan 2Rd, Yuyuan Industrial Park,
HuangJiang Town, Dongguan, China

Tel: 0769-83078199
Web.: www.hwa-hsing.com
E-Mail: customerservice.dg@hwa-hsing.com

Release
Ver. 1.3

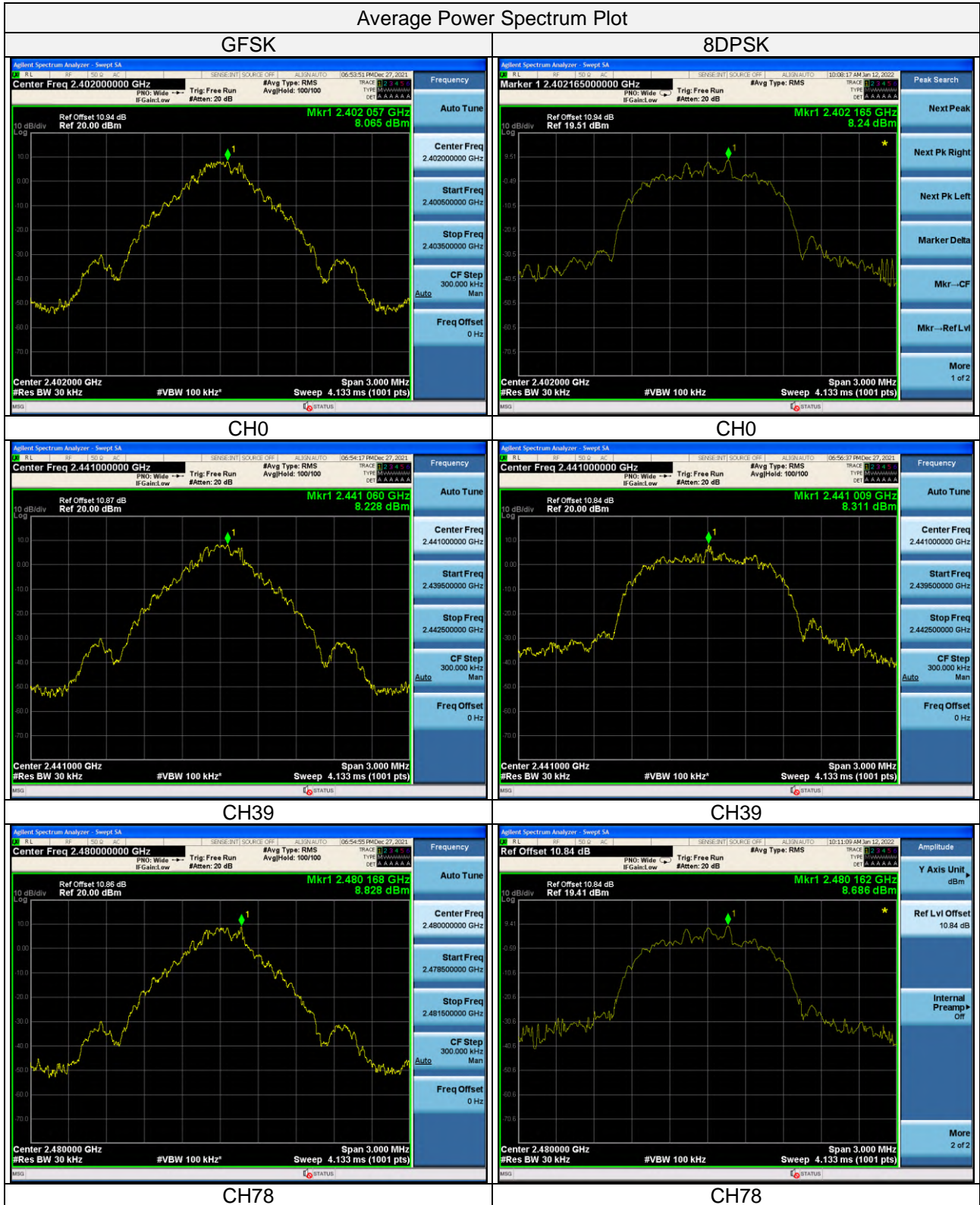



3.9 Conducted Out of Band Emission Measurement

3.9.1 Limits of Conducted Out of Band Emission Measurement

- a. **If the maximum peak conducted output power procedure was used to determine compliance as described in 11.9.1**, then the peak output power measured in any 100 kHz bandwidth outside of the authorized frequency band shall be attenuated by at least 20 dB relative to the maximum in-band peak PSD level in 100 kHz (i.e., 20 dBc).
- b. **If maximum conducted (average) output power was used to determine compliance as described in 11.9.2**, then the peak power in any 100 kHz bandwidth outside of the authorized frequency band shall be attenuated by at least 30 dB relative to the maximum in-band peak PSD level in 100 kHz (i.e., 30 dBc)

3.9.2 Tets Setup

- DTS emissions in non-restricted frequency bands Subclause 11.11 of ANSI C63.10 is applicable.
- DTS emissions in restricted frequency bands Subclause 11.12 of ANSI C63.10 is applicable

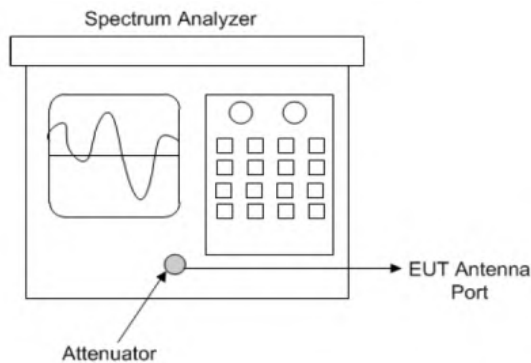

Spectrum analyzer test configuration

3.9.3 Test Instruments

Refer to section 5 to get information of above instrument.

3.9.4 Test Procedure

- a. Establish a reference level by using the following procedure:
 - 1) Set instrument center frequency to DTS channel center frequency.
 - 2) Set the span to 21.5 times the DTS bandwidth)
 - 3) Set the RBW= 100 kHz)
 - 4) Set the VBW $\geq 3 \times$ RBW
 - 5) Detector = peak
 - 6) Sweep time = auto coupling
 - 7) Trace mode =max hold
 - 8) Allow trace to fully stabilize
 - 9) Use the peak marker function to determine the maximum PSD level.

Note that the channel found to contain the maximum PSD level can be used to establish the reference level.



- b. Establish an emission level by using the following procedure:
- 1) Set the center frequency and span to encompass frequency range to be measured.
 - 2) Set the RBW = 100 kHz
 - 3) Set the VBW \geq 300 kHz.
 - 4) Detector = peak.
 - 5) Sweep time = auto couple.
 - 6) Trace mode = max hold.
 - 7) Allow trace to fully stabilize.
 - 8) Use the peak marker function to determine the maximum power level in any 100 kHz band segment within the fundamental EBW.

3.9.5 Deviation from Test Standard

No deviation.

3.9.6 EUT Operating Condition

The software provided by client enabled the EUT to transmit and receive data at lowest, middle and highest channel frequencies individually.



3.9.7 Test Results

The spectrum plots are attached on the following images. D1 line indicates the highest level, D2 line indicates the 20dB offset below D1. It shows compliance with the requirement.

GFSK

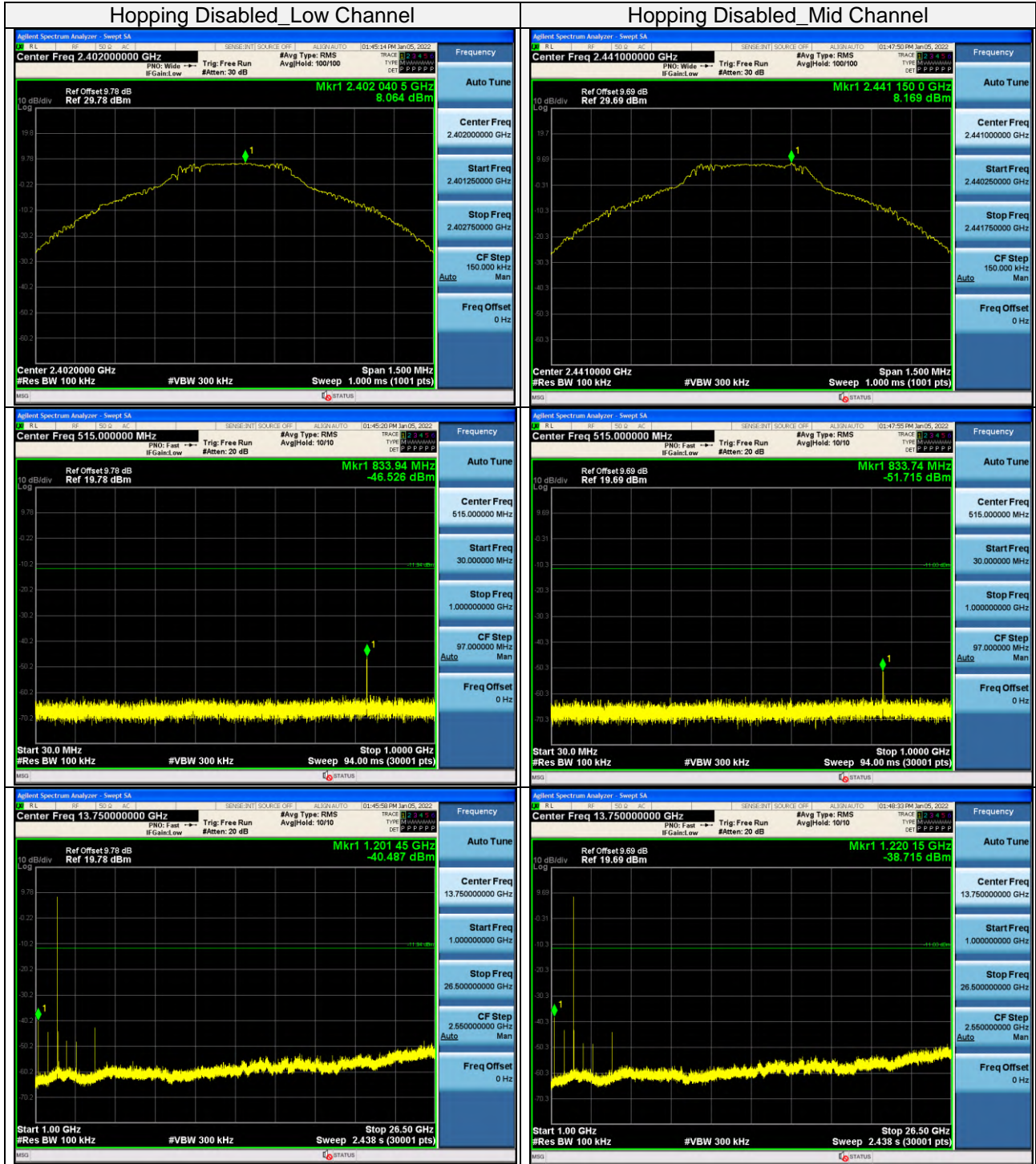

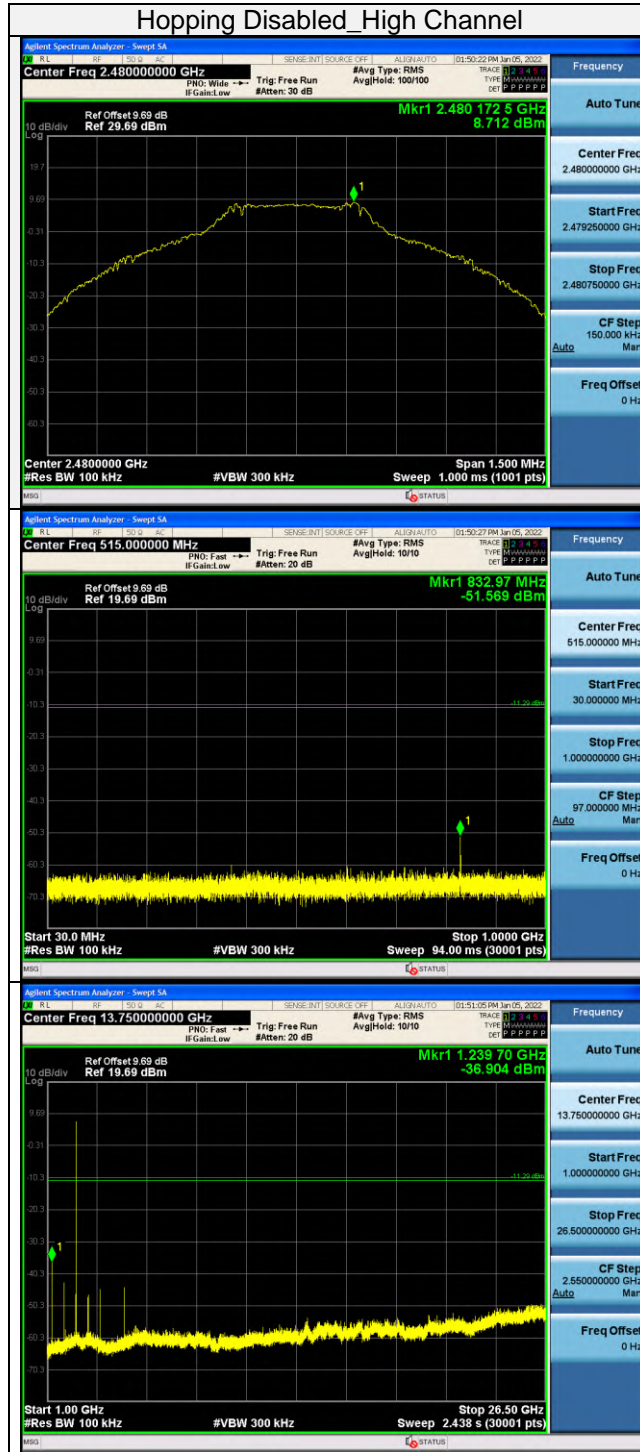



8DPSK

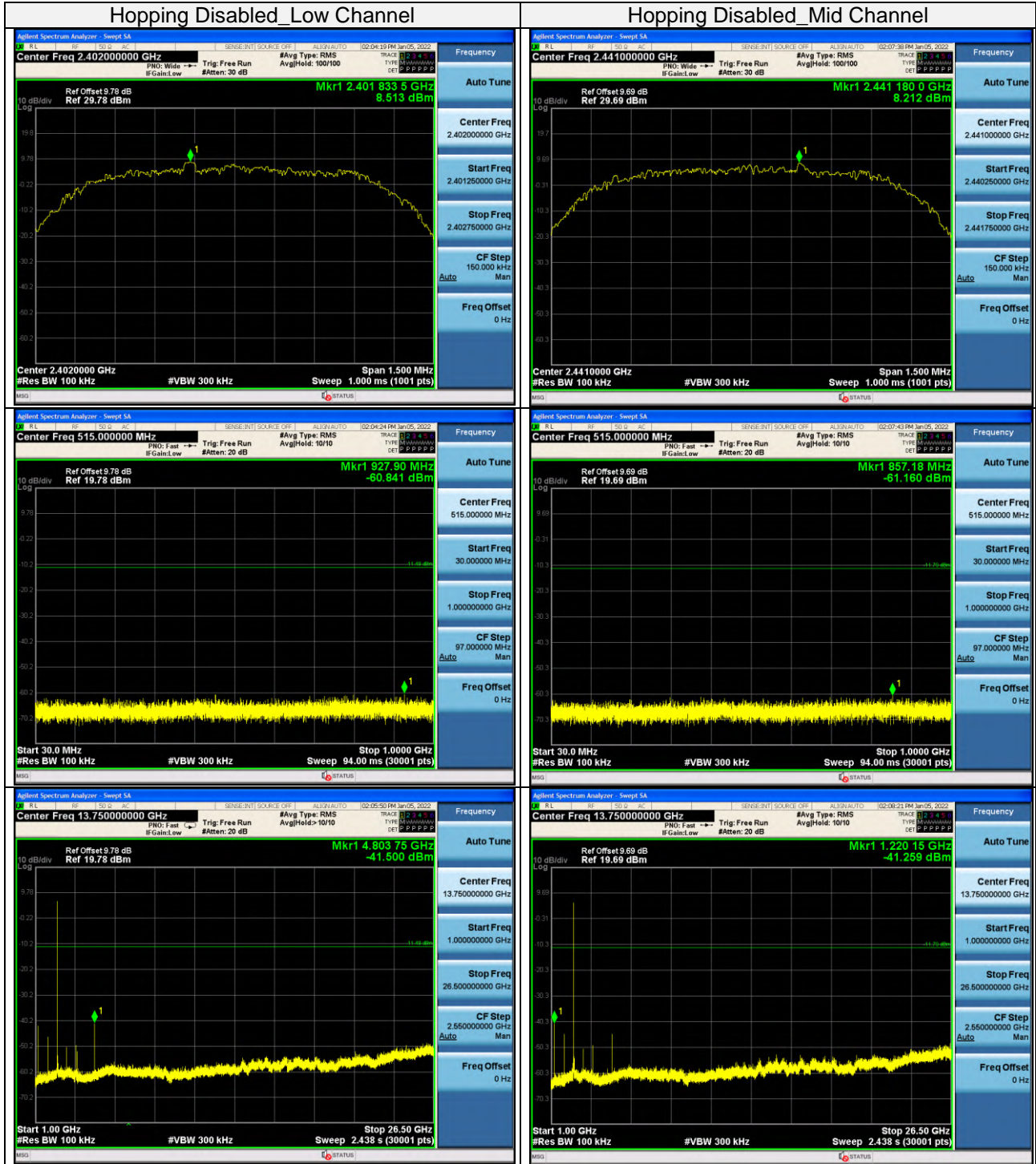

Lab: Hwa-Hsing (Dongguan) Testing Co., Ltd.
Address: No.101, Bld N1, Yuyuan 2Rd, Yuyuan Industrial Park,
HuangJiang Town, Dongguan, China

Tel: 0769-83078199
Web.: www.hwa-hsing.com
E-Mail: customerservice.dg@hwa-hsing.com

Release
Ver. 1.3

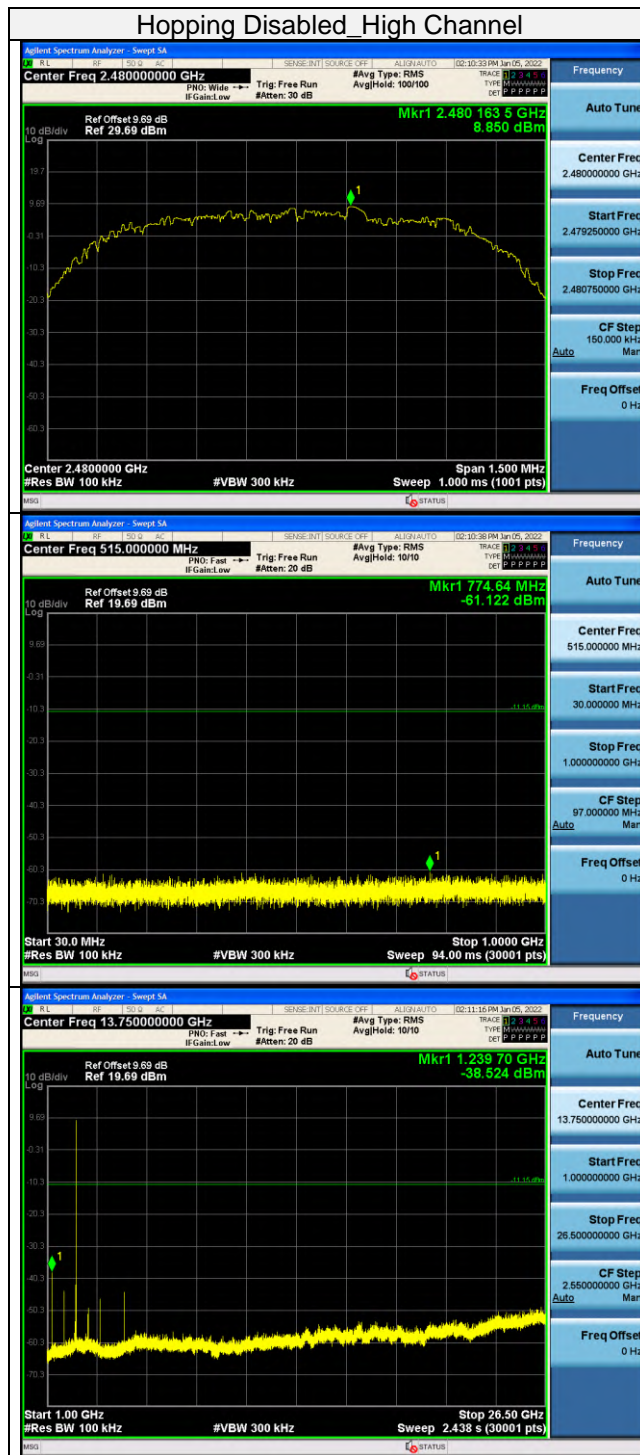



Bandedge: GFSK

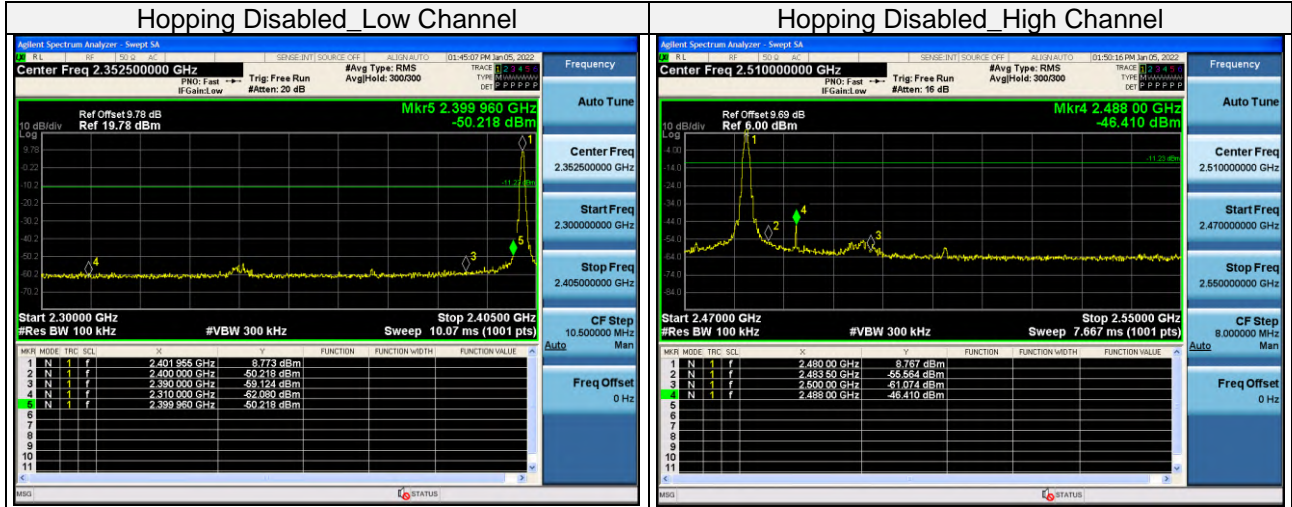

Bandedge: 8DPSK

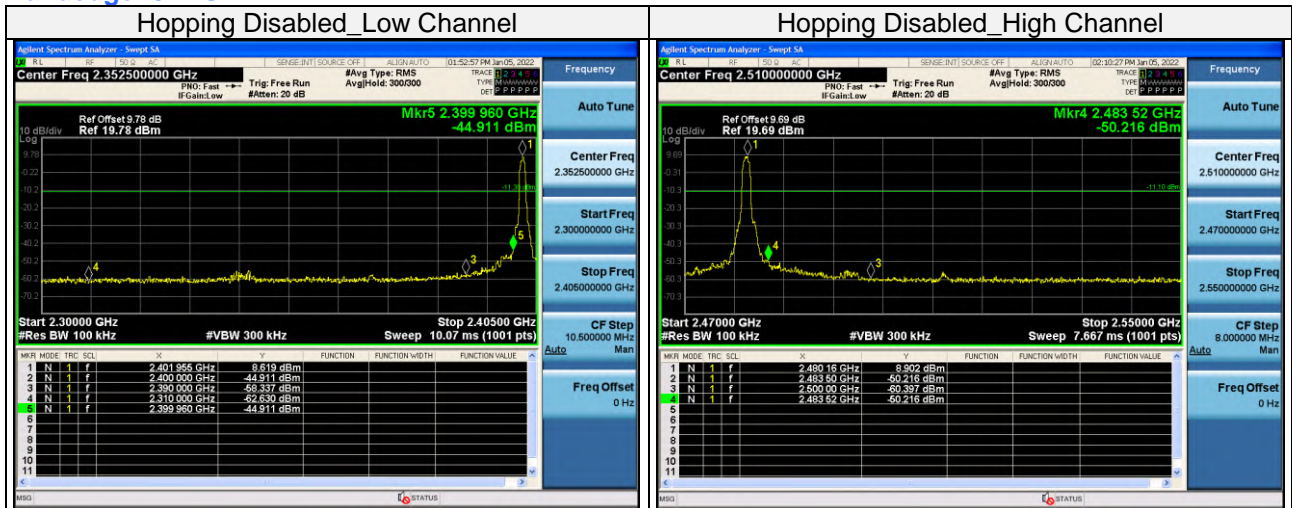



GFSK

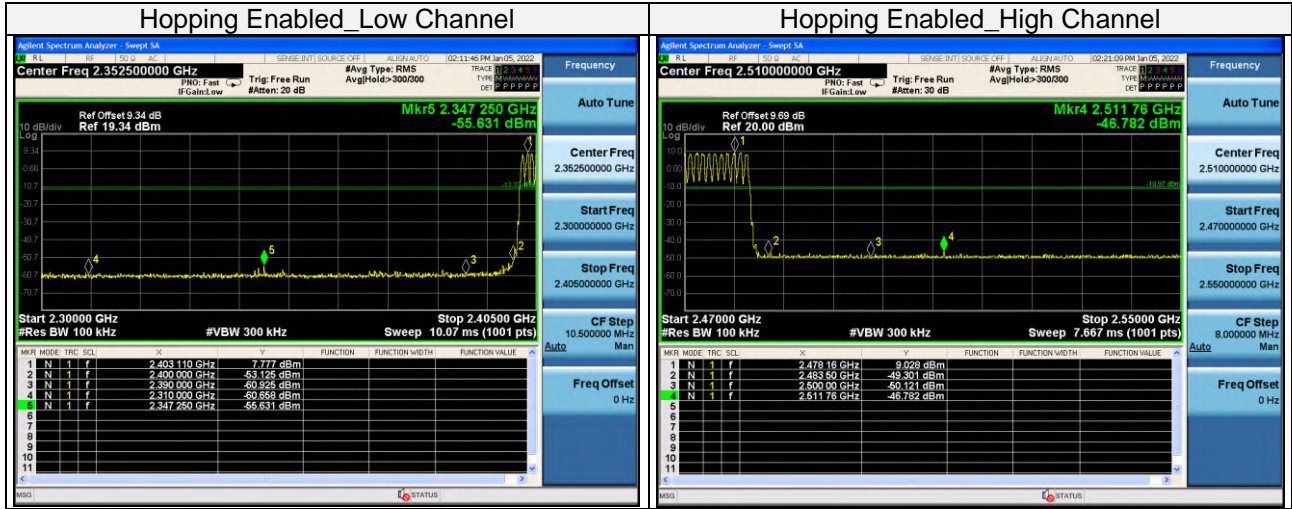

8DPSK

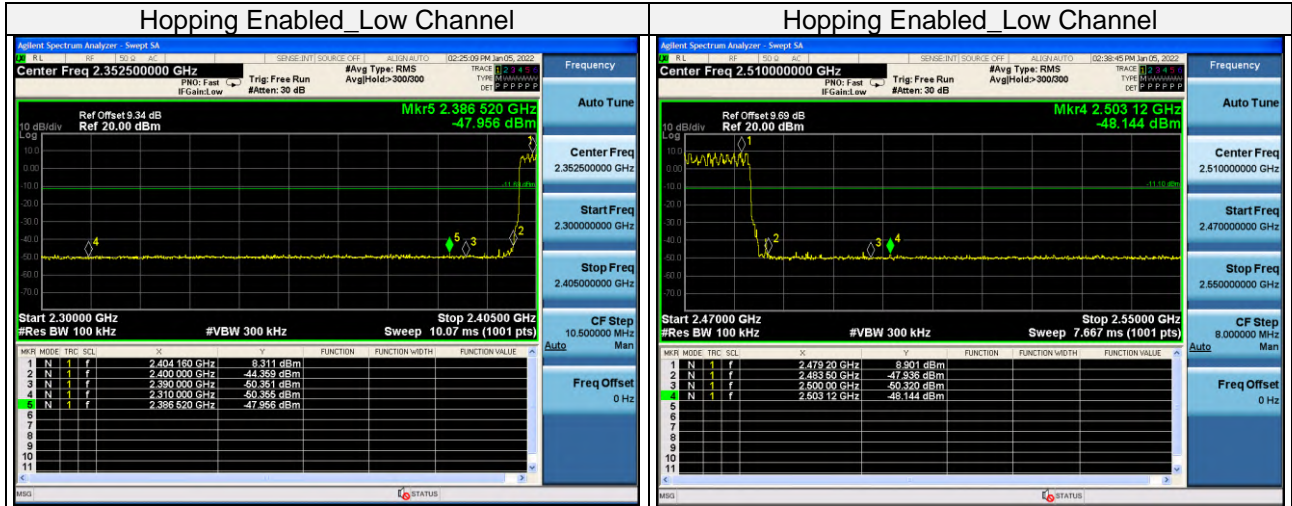

Lab: Hwa-Hsing (Dongguan) Testing Co., Ltd.
Address: No.101, Bld N1, Yuyuan 2Rd, Yuyuan Industrial Park,
HuangJiang Town, Dongguan, China

Tel: 0769-83078199
Web.: www.hwa-hsing.com
E-Mail: customerservice.dg@hwa-hsing.com

Release
Ver. 1.3



HWA-HSING Test Report No.:211126EL31-RF-US-01

4 Pictures of Test Arrangements

Please refer to the attached file (Test Setup Photo).



5 Test Instruments

Description & Manufacturer	Model No.	Serial No.	Due Date of Calibration
Spectrum Keysight	N9020A	MY51240612	2022/09/12
Spectrum Analyzer Rohde&Schwarz	FSV-40N	101783	2022/09/12
Power Meter 10Hz~18GHz Tonscend	JS0806-2	188060126	2022/09/12
Signal generator Keysight	E4421B	GB40051020	2022/09/12
Signal generator Keysight	N5182A	MY47420944	2022/09/12
Test Software Tonscend	JS0806-2	NA	NA
Hygrothermograph Yuhuaze	HTC-1	NA	2022/09/12

Note:

1. The calibration interval of the above test instruments is 12 months and the calibrations are traceable to CEPREI/CHINA.
2. The test was performed in Chamber 1.



Appendix – Information on the Testing Laboratories

We, [Hwa-Hsing \(Dongguan\) Co., Ltd.](#), A global provider of TESTING and CERTIFICATION services for consumer products, electronic products and wireless information technology products. Adhering to the core values “HONEST and TRUSTWORTHY, OBJECTIVE and IMPARTIALITY, RIGOROUS and AFFICIENT”, commitment to provide professional, perfect and efficient comprehensive ONE-STOP solution of TESTING and CERTIFICATION services for Manufacturers, Buyers, Traders, Brands, Retailers. Assist client to better manage risk, protect their brands, reduce costs and cut time to over 150 markets in global. Our laboratories are FCC recognized accredited test firms and accredited and approved according to ISO/IEC 17025.

If you have any comments, please feel free to contact us at the following:

Lab Address: [No.101, Bld N1, Yuyuan 2Rd, Yuyuan Industrial Park, HuangJiang Town, Dongguan, China](#)

Contact Tel: [0769-83078199](tel:0769-83078199)

Email: Customerservice.dg@hwa-hsing.com

Web Site: www.hwa-hsing.com

The address and road map of all our labs can be found in our web site also.

--- END ---