

**ELECTROMAGNETIC EMISSIONS COMPLIANCE REPORT
INTENTIONAL RADIATOR CERTIFICATION TO
FCC PART 15 SUBPART C REQUIREMENT**

OF

ACTIVE STEREO LOUDSPEAKER

Model No.: ACTON

Trade Mark: 

FCC ID: 2AAGF-ACTON

Report No.: KAD140731134E

Issue Date: September 25, 2014

Prepared for

**Zound Industries
Torsgatan 2 111 23 Stockholm Sweden**

Prepared by

DONGGUAN EMTEK CO., LTD.

**No.281, Guantai Road, Nancheng District,
Dongguan, Guangdong, China
TEL: 86-769-22807078
FAX: 86-769-22807079**

**This report shall not be reproduced, except in full, without the written approval of
DONGGUAN EMTEK CO., LTD.**

VERIFICATION OF COMPLIANCE

Applicant:	Zound Industries Torsgatan 2 111 23 Stockholm Sweden
Manufacturer:	DONGUAN TRISTAR ELECTRONIC CO., LTD. NO.24A DongXing AVE South, ZhenXingWei, TangXia Town, DongGuan City, China
Product Description:	ACTIVE STEREO LOUDSPEAKER
Trade Mark:	
Model Number:	ACTON
File Number:	KAD140731134E
Date of Test:	July 31, 2014 to September 13, 2014

We hereby certify that:

The above equipment was tested by DONGGUAN EMTEK CO., LTD. The test data, data evaluation, test procedures, and equipment configurations shown in this report were made in accordance with the procedures given in ANSI C63.4 (2009) and the energy emitted by the sample EUT tested as described in this report is in compliance with conducted and radiated emission limits of FCC Rules Part 15.247(2013).

The test results of this report relate only to the tested sample identified in this report.

Approved By



**Sam.Lv / Q.A. Manager
DONGGUAN EMTEK CO., LTD.**

Modified Information

Version	Summary	Revision Date	Report No.
Ver.1.0	Original Report	/	KAD140731134E

Table of Contents

1. GENERAL INFORMATION	6
1.1 PRODUCT DESCRIPTION.....	6
1.2 TEST METHODOLOGY.....	7
1.3 SPECIAL ACCESSORIES.....	7
1.4 EQUIPMENT MODIFICATIONS	7
1.5 TEST FACILITY	7
2. SYSTEM TEST CONFIGURATION.....	8
2.1 EUT CONFIGURATION.....	8
2.2 EUT EXERCISE.....	8
2.3 TEST PROCEDURE	8
2.4 CONFIGURATION OF TESTED SYSTEM	9
3. DESCRIPTION OF TEST MODES.....	10
4. CONDUCTED EMISSIONS TEST	11
4.1 MEASUREMENT PROCEDURE:	11
4.2 TEST SET-UP (BLOCK DIAGRAM OF CONFIGURATION).....	11
4.3 MEASUREMENT EQUIPMENT USED:	11
4.4 CONDUCTED EMISSION LIMIT	12
4.5 MEASUREMENT RESULT:.....	12
4.6 CONDUCTED MEASUREMENT PHOTOS:	15
5. RADIATED EMISSION TEST	16
5.1 MEASUREMENT PROCEDURE	16
5.2 TEST SET-UP (BLOCK DIAGRAM OF CONFIGURATION).....	17
5.3 MEASUREMENT EQUIPMENT USED:	18
5.4 RADIATED EMISSION LIMIT	18
5.5 MEASUREMENT RESULT.....	19
5.6 RADIATED MEASUREMENT PHOTOS:	29
6. 6DB BANDWIDTH MEASUREMENT	30
6.1 MEASUREMENT PROCEDURE	30
6.2 TEST SET-UP (BLOCK DIAGRAM OF CONFIGURATION).....	30
6.3 MEASUREMENT EQUIPMENT USED:	30
6.4 MEASUREMENT RESULTS:.....	30
7. MAXIMUM PEAK OUTPUT POWER TEST	33
7.1 MEASUREMENT PROCEDURE	33
7.2 TEST SET-UP (BLOCK DIAGRAM OF CONFIGURATION).....	33
7.3 MEASUREMENT EQUIPMENT USED:	33
7.4 PEAK POWER OUTPUT LIMIT	33

7.5 MEASUREMENT RESULTS:.....	34
8. POWER SPECTRAL DENSITY MEASUREMENT.....	36
8.1 MEASUREMENT PROCEDURE	36
8.2 TEST SET-UP (BLOCK DIAGRAM OF CONFIGURATION).....	36
8.3 MEASUREMENT EQUIPMENT USED:	36
8.4 MEASUREMENT PROCEDURE	36
8.5 MEASUREMENT RESULTS:.....	37
9. BAND EDGE TEST	41
9.1 MEASUREMENT PROCEDURE	41
9.2 TEST SET-UP (BLOCK DIAGRAM OF CONFIGURATION).....	41
9.3 MEASUREMENT RESULTS:.....	42
10 ANTENNA APPLICATION	43
10.1 ANTENNA REQUIREMENT	43
10.2 RESULT	43

1. GENERAL INFORMATION

1.1 Product Description

The Zound Industries, Model: ACTON (referred to as the EUT in this report) The EUT is an short range, lower power transmitter as an Input Device. It is designed by way of utilizing the following modulation achieves the system operating.

- A). Operation Frequency: 2402-2480MHz
- B). Kind of device: Bluetooth 4.0
- C). Modulation: GFSK
- D). Number of Channel: 40
- E). Channel space: 2MHz
- F). Rated RF Output Power: 2.44dBm(0.001754W)
- G). Antenna Type: Internal PCB antenna
- H). Antenna GAIN: 0 dBi
- I). Input Rating: AC100-240V, 50-60Hz, 70W

Channel List:

Channel	Frequency (MHz)	Channel	Frequency (MHz)	Channel	Frequency (MHz)
01	2402	15	2430	29	2458
02	2404	16	2432	30	2460
03	2406	17	2434	31	2462
04	2408	18	2436	32	2464
05	2410	19	2438	33	2466
06	2412	20	2440	34	2468
07	2414	21	2442	35	2470
08	2416	22	2444	36	2472
09	2418	23	2446	37	2474
10	2420	24	2448	38	2476
11	2422	25	2450	39	2478
12	2424	26	2452	40	2480
13	2426	27	2454		
14	2428	28	2456		

Note:

1. Test of channel was included the lowest 2402MHz, middle 2442MHz and highest frequency 2480MHz in highest data rate and to perform the test, then record on this report.

1.2 Test Methodology

Both conducted and radiated testing were performed according to the procedures in ANSI C63.4 (2009). Radiated testing was performed at an antenna to EUT distance 3 meters.

Tested in accordance with FCC KDB Publication No. 558074 D01 DTS Meas. Guidance v03r02 (June 05, 2014) for compliance to FCC 47CFR 15.247 requirements.

1.3 Special Accessories

Not available for this EUT intended for grant.

1.4 Equipment Modifications

Not available for this EUT intended for grant.

1.5 Test Facility

Site Description

EMC Lab. : Accredited by FCC, June 18, 2014
The Certificate Number is 247565

Accredited by Industry Canada, February 19, 2014
The Certificate Number is 9444A.

Name of Firm : DONGGUAN EMTEK CO., LTD

Site Location : No.281, Guantai Road, Nancheng District,
Dongguan, Guangdong, China

2. System Test Configuration

2.1 EUT Configuration

The EUT configuration for testing is installed on RF field strength measurement to meet the Commissions requirement and operating in a manner which intends to maximize its emission characteristics in a continuous transmission application.

2.2 EUT Exercise

The Transmitter was operated in the transmission operating mode. the Tx frequency was fixed which was for the purpose of the measurements.

2.3 Test Procedure

2.3.1 Conducted Emissions

The EUT is a placed on as turn table which is 0.8 m above ground plane. According to the requirements in Section 13.1.4.1 of ANSI C63.4-2009. Conducted emissions from the EUT measured in the frequency range between 0.15 MHz and 30MHz using CISPR Quasi-Peak and average detector mode.

2.3.2 Radiated Emissions

The EUT is a placed on as turn table which is 0.8 m above ground plane. The turn table shall rotate 360 degrees to determine the position of maximum emission level. EUT is set 3m away from the receiving antenna which varied from 1m to 4m to find out the highest emission. And also, each emission was to be maximized by changing the polarization of receiving antenna both horizontal and vertical. In order to find out the max. Emission was rotated through three orthogonal axes according to the requirements in Section 13.1.4.1 of ANSI C63.4-2009.

2.4 Configuration of Tested System

Fig. 2-1 Configuration of Tested System

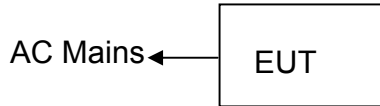

Table 2-1 Equipment Used in Tested System

Item	Equipment	Brand	Model No.	FCC ID	Note
1.	ACTIVE STEREO LOUDSPEAKER	<i>Marshall</i> AMPLIFICATION	ACTON	2AAGF-ACTON	EUT

Note:

- (1) Unless otherwise denoted as EUT in 『Remark』 column , device(s) used in tested system is a support equipment.
- (2) All cases of EUT are tested, only the result of the worst case was recorded in the report.

3. Description of test modes

This is Digital Transmission system(DTS) and have one type of modulation GFSK.

The 3 channels of lower, middle and higher were chosen for test.

1. For lowest channel : 2402MHz(Channel 01)
2. For middle channel : 2442MHz(Channel 21)
3. For highest channel: 2480MHz(Channel 40)

4. Conducted Emissions Test

4.1 Measurement Procedure:

1. The EUT was placed on a table, which is 0.8m above ground plane.
2. Maximum procedure was performed on the six highest emissions to ensure EUT compliance.
3. Repeat above procedures until all frequency measured was complete.

4.2 Test SET-UP (Block Diagram of Configuration)

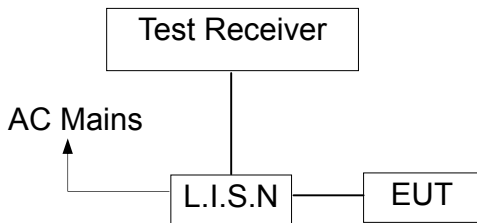

4.3 Measurement Equipment Used:

Conducted Emission Test Site # 4					
EQUIPMENT TYPE	MFR	MODEL NUMBER	SERIAL NUMBER	Last Cal.	Due date
Test Receiver	Rohde & Schwarz	ESCS30	828985/018	05/16/2014	05/15/2015
L.I.S.N	Rohde & Schwarz	ESH2-Z5	834549/005	05/16/2014	05/15/2015
L.I.S.N	Rohde & Schwarz	ESH2-Z5	834549/005	05/16/2014	05/15/2015
50ΩCoaxial Switch	Anritsu	MP59B	M20531	05/16/2014	05/15/2015

4.4 Conducted Emission Limit

(7) Conducted Emission

Frequency(MHz)	Quasi-peak	Average
0.15-0.5	66-56	56-46
0.5-5.0	56	46
5.0-30.0	60	50

Note:

1. The lower limit shall apply at the transition frequencies
2. The limit decreases in line with the logarithm of the frequency in the range of 0.15 to 0.50MHz.

4.5 Measurement Result:

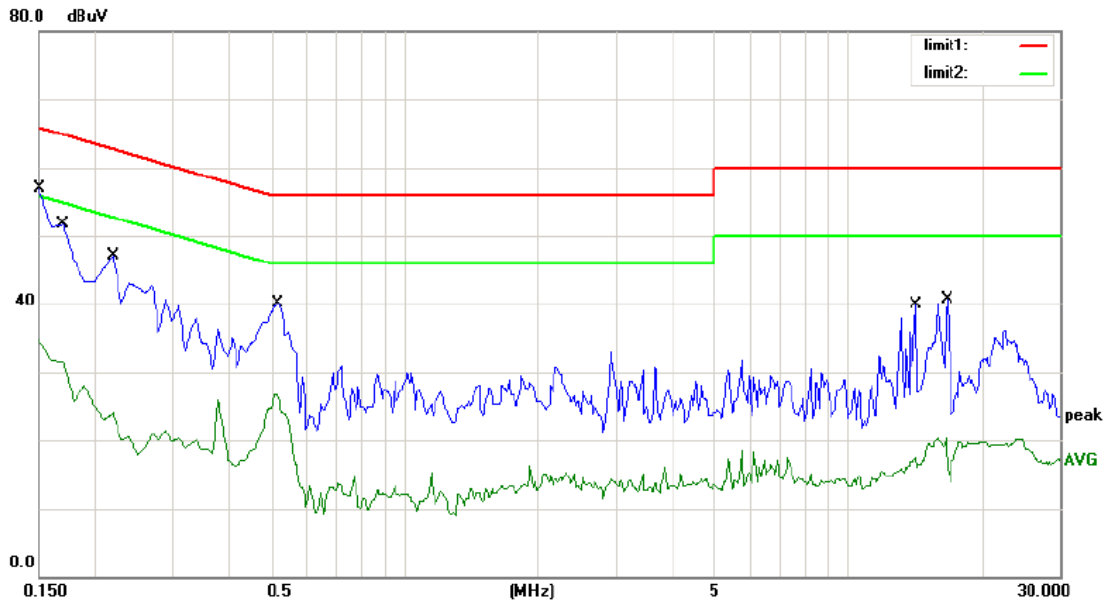

Site site #1 Phase: **L1** Temperature: 24
 Limit: (CE)FCC PART 15 class B_QP Power: AC 120V/60Hz Humidity: 55 %
 Mode: BT Link
 Note:

No.	Mk.	Freq. MHz	Reading Level dBuV	Correct Factor dB	Measure- ment dBuV	Limit dBuV	Over dB	Detector	Comment
1	*	0.1500	57.00	0.00	57.00	66.00	-9.00	QP	
2		0.1500	34.93	0.00	34.93	56.00	-21.07	AVG	
3		0.1700	51.62	0.00	51.62	64.96	-13.34	QP	
4		0.1700	31.55	0.00	31.55	54.96	-23.41	AVG	
5		0.2200	47.10	0.00	47.10	62.82	-15.72	QP	
6		0.2200	24.04	0.00	24.04	52.82	-28.78	AVG	
7		0.5200	40.18	0.00	40.18	56.00	-15.82	QP	
8		0.5200	26.69	0.00	26.69	46.00	-19.31	AVG	
9		14.2500	39.99	0.00	39.99	60.00	-20.01	QP	
10		14.2500	19.48	0.00	19.48	50.00	-30.52	AVG	
11		16.7500	40.72	0.00	40.72	60.00	-19.28	QP	
12		16.7500	20.40	0.00	20.40	50.00	-29.60	AVG	

*:Maximum data x:Over limit l:over margin Comment: Factor build in receiver.

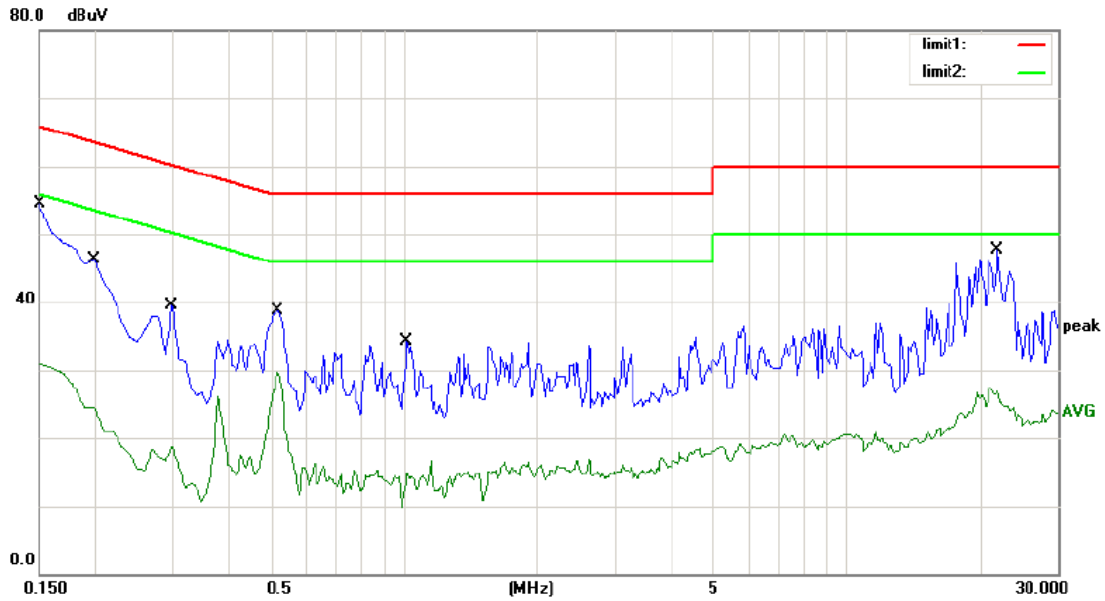

Site site #1 Phase: **N** Temperature: 24
 Limit: (CE)FCC PART 15 class B_QP Power: AC 120V/60Hz Humidity: 55 %
 Mode: BT Link
 Note:

No.	Mk.	Freq. MHz	Reading Level dBuV	Correct Factor dB	Measure- ment dBuV	Limit dBuV	Over dB	Detector	Comment
1	*	0.1500	54.41	0.00	54.41	66.00	-11.59	QP	
2		0.1500	30.98	0.00	30.98	56.00	-25.02	AVG	
3		0.2000	46.33	0.00	46.33	63.61	-17.28	QP	
4		0.2000	24.57	0.00	24.57	53.61	-29.04	AVG	
5		0.3000	39.44	0.00	39.44	60.24	-20.80	QP	
6		0.3000	18.72	0.00	18.72	50.24	-31.52	AVG	
7		0.5200	38.70	0.00	38.70	56.00	-17.30	QP	
8		0.5200	29.66	0.00	29.66	46.00	-16.34	AVG	
9		1.0200	34.31	0.00	34.31	56.00	-21.69	QP	
10		1.0200	14.96	0.00	14.96	46.00	-31.04	AVG	
11		21.9500	47.75	0.00	47.75	60.00	-12.25	QP	
12		21.9500	26.96	0.00	26.96	50.00	-23.04	AVG	

*:Maximum data x:Over limit l:over margin Comment: Factor build in receiver.

4.6 Conducted Measurement Photos:



5. Radiated Emission Test

5.1 Measurement Procedure

- 1 The EUT was placed on a turn table which is 0.8m above ground plane.
2. Maximum procedure was performed on the six highest emissions to ensure EUT compliance.
3. And also, each emission was to be maximized by changing the polarization of receiving antenna both horizontal and vertical.
4. Repeat above procedures until all frequency measured were complete.

When spectrum scanned from 30MHz to 1GHz setting resolution bandwidth 120KHz and video bandwidth 300KHz:

EMI Test Receiver	Setting
Attenuation	Auto
RB	120KHz
VB	300KHz
Detector	QP
Trace	Max hold

When spectrum scanned above 1GHz setting resolution bandwidth 1MHz, video bandwidth 3MHz:

EMI Test Receiver	Setting
Attenuation	Auto
RB	1MHz
VB	3MHz
Detector	Peak
Trace	Max hold

When spectrum scanned above 1GHz setting resolution bandwidth 1MHz, video bandwidth 10Hz:

EMI Test Receiver	Setting
Attenuation	Auto
RB	1MHz
VB	10Hz
Detector	AVG
Trace	Max hold

5.2 Test SET-UP (Block Diagram of Configuration)

(A) Radiated Emission Test Set-Up, Frequency Below 30MHz

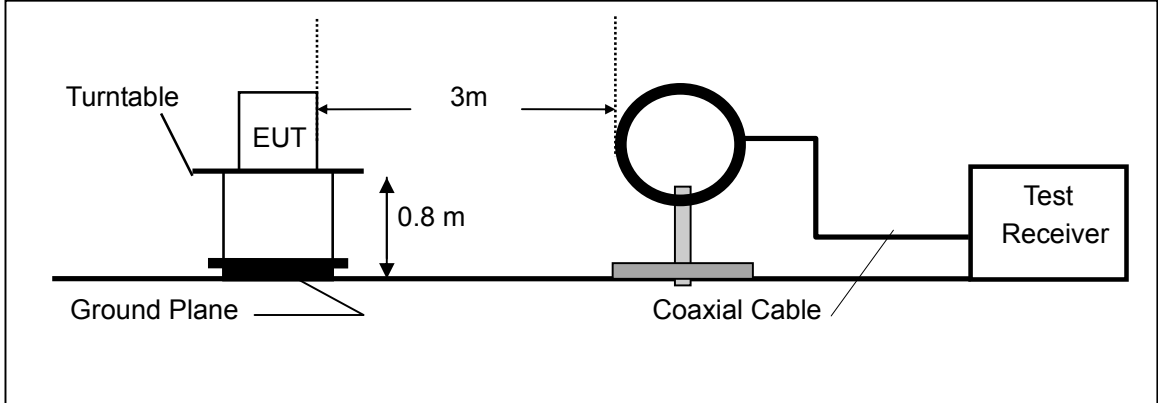

(B) Radiated Emission Test Set-Up, Frequency Below 1000MHz

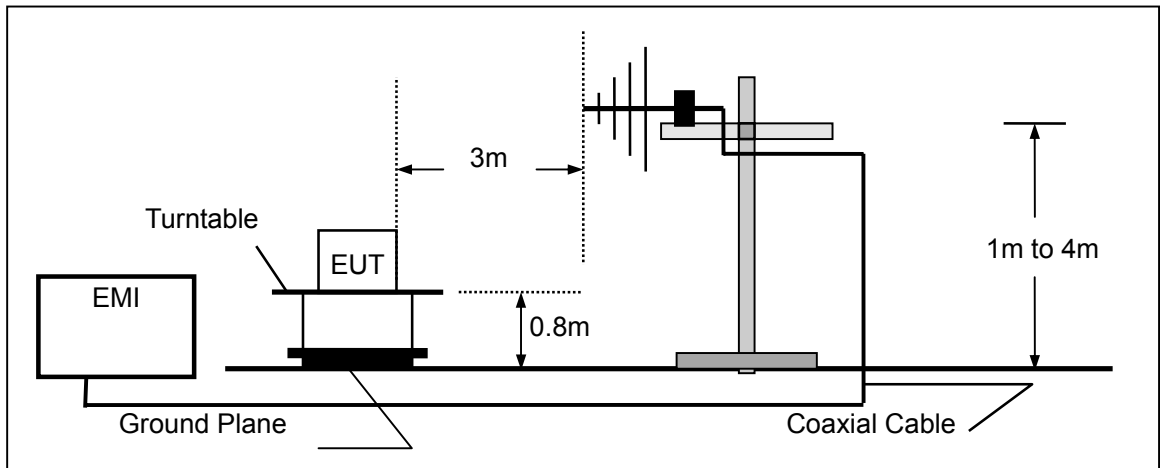

(C) Radiated Emission Test Set-Up, Frequency above 1000MHz

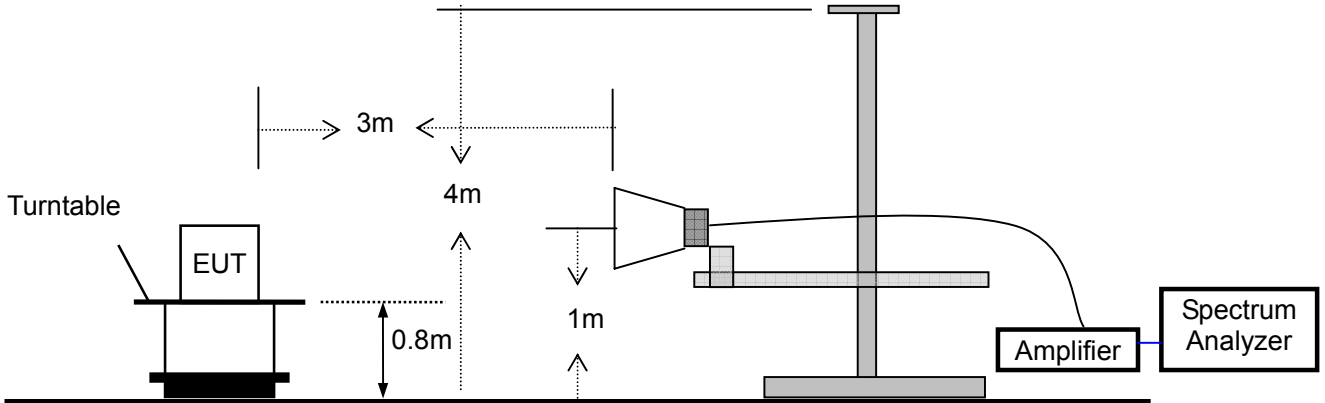

5.3 Measurement Equipment Used:

EQUIPMENT TYPE	MFR	MODEL NUMBER	SERIAL NUMBER	LAST CAL.	CAL DUE.
EMI Test Receiver	Rohde & Schwarz	ESU	1302.6005.26	05/16/2014	05/15/2015
Pre-Amplifier	HP	8447D	2944A07999	05/16/2014	05/15/2015
Bilog Antenna	SCHWARZBECK	VULB9163	142	05/16/2014	05/15/2015
Loop Antenna	ARA	PLA-1030/B	1029	05/16/2014	05/15/2015
Horn Antenna	Schwarzbeck	BBHA9170	BBHA9170399	05/16/2014	05/15/2015
Horn Antenna	Schwarzbeck	BBHA 9120	D143	05/16/2014	05/15/2015
Cable	Schwarzbeck	AK9513	ACRX1	05/19/2014	05/18/2015
Cable	Schwarzbeck	N/A	FP2RX2	05/19/2014	05/18/2015
Cable	Schwarzbeck	AK9513	CRPX1	05/19/2014	05/18/2015
Cable	Schwarzbeck	AK9513	CRRX2	05/19/2014	05/18/2015

5.4 Radiated emission limit

Frequency MHz	Distance Meter	Field Strength	
		uV/m	dBuV/m
0.009 – 0.490	300	10000 *	20log 2400/F(KHz) + 80
		2400/F(KHz)	
0.490 – 1.705	30	100 *	20log 24000/F(KHz) +
		24000/F(KHz)	40
1.705 – 30.00	30	100* 30	20log 30 + 40
30~88	3	100	40.0
88~216	3	150	43.5
216~960	3	200	46.0
Above 960	3	500	54.0

Note: The frequencies above 1000MHz, as measured using instrumentation with a peak detector function was corresponding to 20dB above maximum permitted average limit.

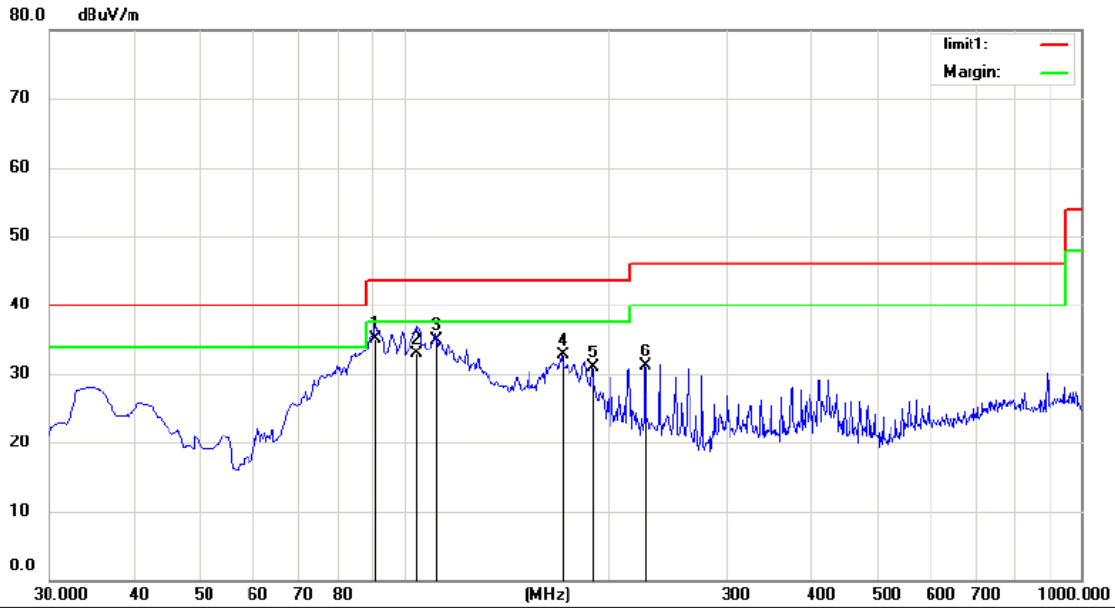

Site Chamber #1 Polarization: **Horizontal** Temperature: 26
 Limit: (RE)FCC Part 15B 3m Power: AC 120V/60Hz Humidity: 55 %
 Mode: TX2402
 Note:

No.	Mk.	Freq.	Reading Level	Correct Factor	Measurement	Limit	Over	Antenna Height	Table Degree	
		MHz	dBuV	dB	dBuV/m	dBuV/m	dB	cm	degree	Comment
1	*	91.1100	55.79	-20.68	35.11	43.50	-8.39	QP		
2		104.6900	51.25	-18.26	32.99	43.50	-10.51	QP		
3		111.4800	52.36	-17.48	34.88	43.50	-8.62	QP		
4		171.6200	51.30	-18.51	32.79	43.50	-10.71	QP		
5		190.0500	49.14	-18.32	30.82	43.50	-12.68	QP		
6		226.9100	47.12	-16.10	31.02	46.00	-14.98	QP		

*:Maximum data x:Over limit !:over margin

Operator: QIU

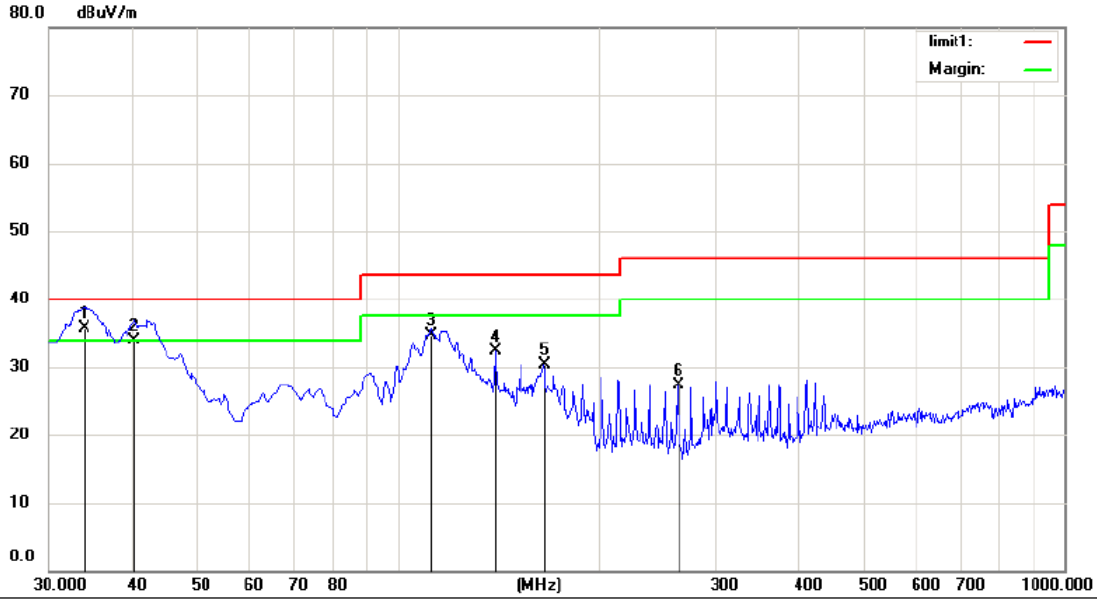

Site Chamber #1 Polarization: **Vertical** Temperature: 26
 Limit: (RE)FCC Part 15B 3m Power: AC 120V/60Hz Humidity: 55 %
 Mode: TX2402
 Note:

No.	Mk.	Freq. MHz	Reading Level dBuV	Correct Factor dB	Measure- ment dBuV/m	Limit dBuV/m	Over dB	Antenna Height cm	Table Degree	Comment
1	*	33.9172	49.93	-14.30	35.63	40.00	-4.37	QP		
2		40.4170	47.63	-13.65	33.98	40.00	-6.02	QP		
3		112.4500	52.22	-17.43	34.79	43.50	-8.71	QP		
4		140.5800	49.36	-17.09	32.27	43.50	-11.23	QP		
5		165.8000	48.67	-18.40	30.27	43.50	-13.23	QP		
6		263.7700	42.58	-15.34	27.24	46.00	-18.76	QP		

*:Maximum data x:Over limit !:over margin

Operator: QIU

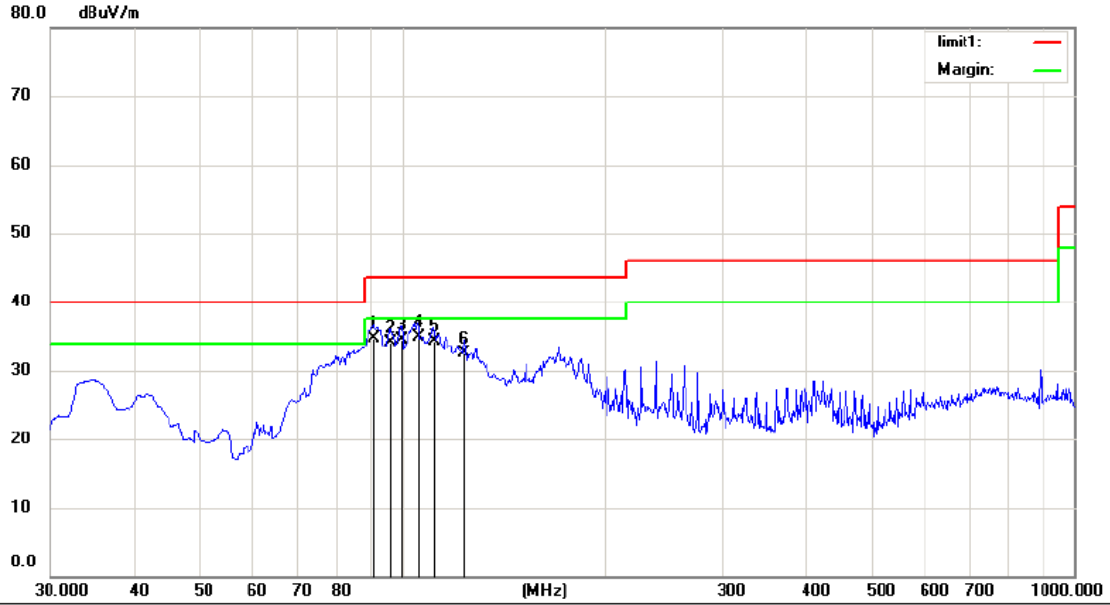

Site Chamber #1 Polarization: **Horizontal** Temperature: 26
 Limit: (RE)FCC Part 15B 3m Power: AC 120V/60Hz Humidity: 55 %
 Mode: TX2442
 Note:

No.	Mk.	Freq.	Reading Level	Correct Factor	Measurement	Limit	Over	Antenna Height	Table Degree	
		MHz	dBuV	dB	dBuV/m	dBuV/m	dB	Detector	cm	degree
1		91.1100	55.29	-20.68	34.61	43.50	-8.89	QP		
2		95.9600	54.03	-19.83	34.20	43.50	-9.30	QP		
3		99.8400	53.61	-19.09	34.52	43.50	-8.98	QP		
4	*	105.6600	53.09	-18.12	34.97	43.50	-8.53	QP		
5		111.4800	51.86	-17.48	34.38	43.50	-9.12	QP		
6		124.0900	49.04	-16.50	32.54	43.50	-10.96	QP		

*:Maximum data x:Over limit !:over margin

Operator: QIU

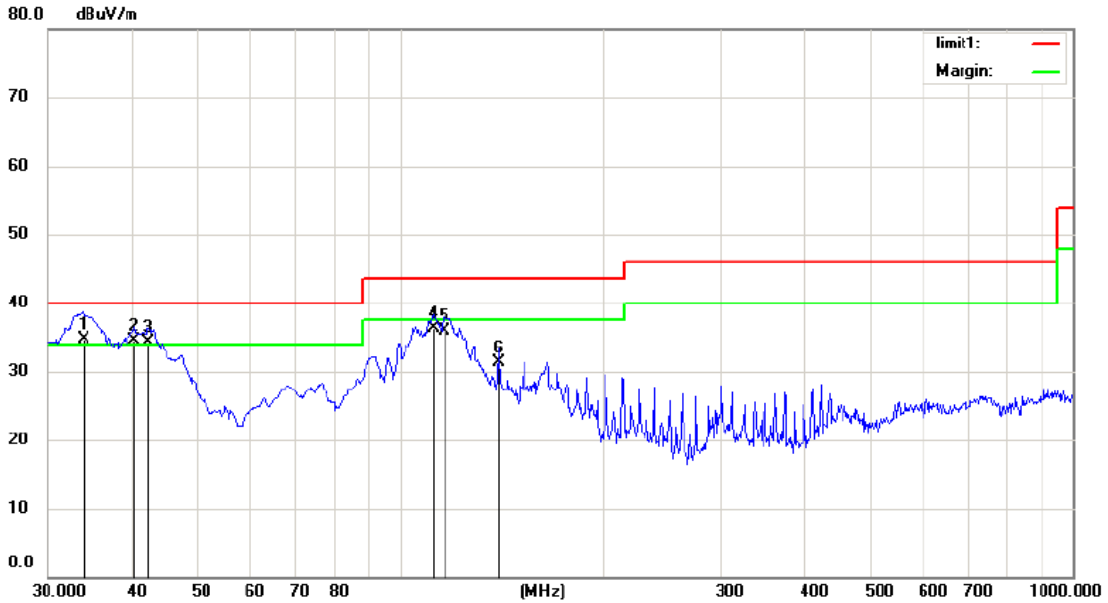

Site Chamber #1 Polarization: **Vertical** Temperature: 26
 Limit: (RE)FCC Part 15B 3m Power: AC 120V/60Hz Humidity: 55 %
 Mode: TX2442
 Note:

No.	Mk.	Freq. MHz	Reading Level dBuV	Correct Factor dB	Measure- ment dBuV/m	Limit dBuV/m	Over dB	Detector	Antenna Height cm	Table Degree	Comment
1	*	33.8800	48.93	-14.31	34.62	40.00	-5.38	QP			
2	!	40.4170	48.13	-13.65	34.48	40.00	-5.52	QP			
3	!	42.3021	47.76	-13.52	34.24	40.00	-5.76	QP			
4		112.4500	53.72	-17.43	36.29	43.50	-7.21	QP			
5		116.5400	53.01	-17.19	35.82	43.50	-7.68	QP			
6		140.5800	48.36	-17.09	31.27	43.50	-12.23	QP			

*:Maximum data x:Over limit !:over margin

Operator: QIU

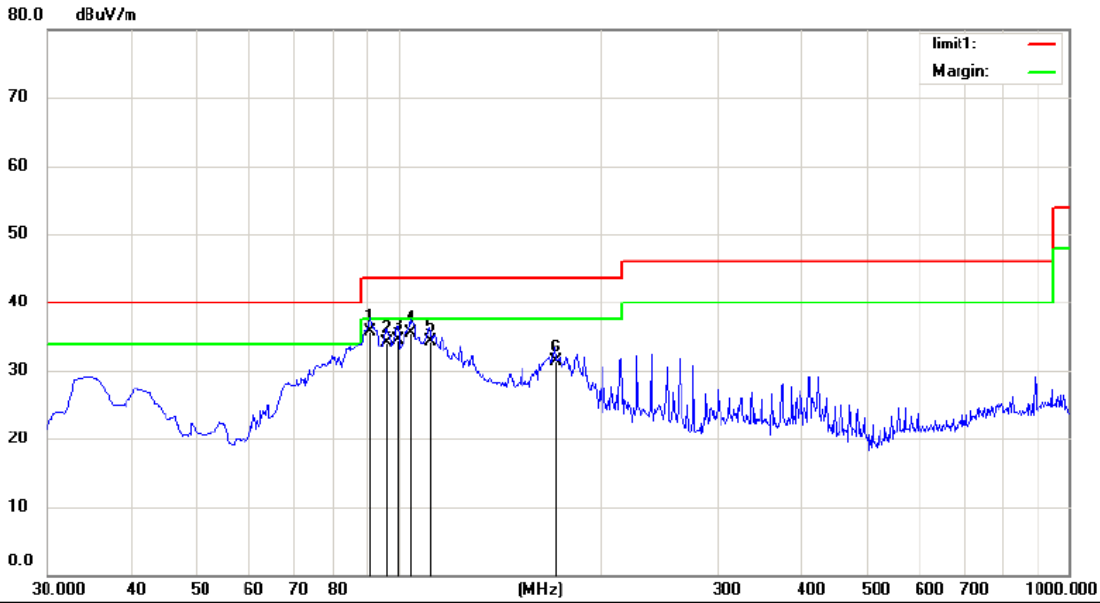

Site Chamber #1 Polarization: **Horizontal** Temperature: 26
 Limit: (RE)FCC Part 15B 3m Power: AC 120V/60Hz Humidity: 55 %
 Mode:TX2480
 Note:

No.	Mk.	Freq.	Reading Level	Correct Factor	Measurement	Limit	Over	Antenna Height	Table Degree	
		MHz	dBuV	dB	dBuV/m	dBuV/m	dB	cm	degree	Comment
1	*	91.1100	56.29	-20.68	35.61	43.50	-7.89	QP		
2		95.9600	54.03	-19.83	34.20	43.50	-9.30	QP		
3		99.8400	53.61	-19.09	34.52	43.50	-8.98	QP		
4		104.6900	53.75	-18.26	35.49	43.50	-8.01	QP		
5		111.4800	51.86	-17.48	34.38	43.50	-9.12	QP		
6		171.6200	49.80	-18.51	31.29	43.50	-12.21	QP		

*:Maximum data x:Over limit !:over margin

Operator: QIU

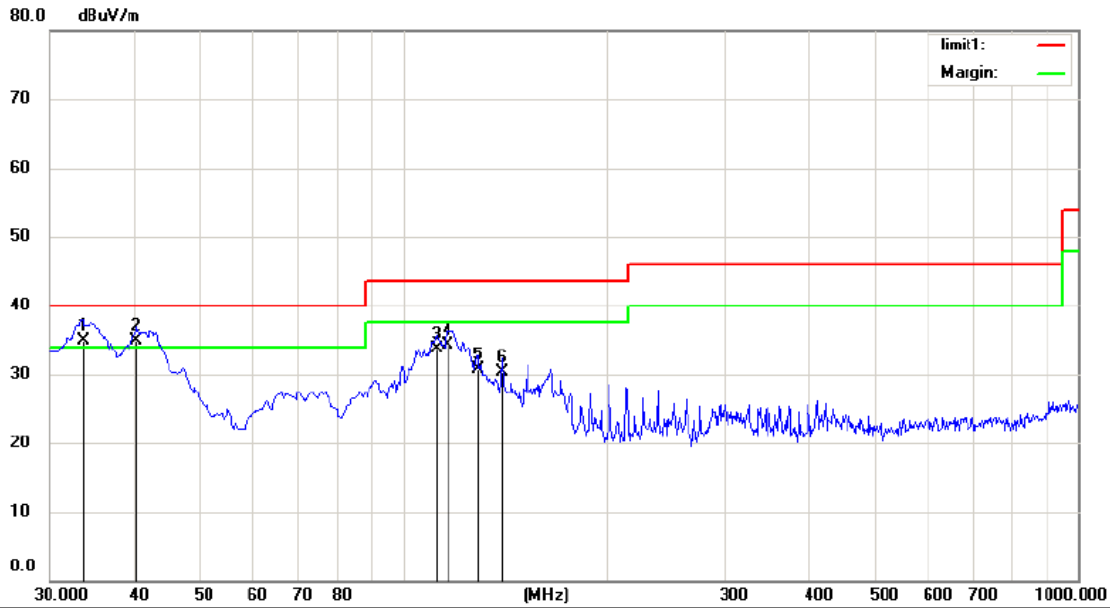

Site Chamber #1 Polarization: **Vertical** Temperature: 26
 Limit: (RE)FCC Part 15B 3m Power: AC 120V/60Hz Humidity: 55 %
 Mode:TX2480
 Note:

No.	Mk.	Freq. MHz	Reading Level dBuV	Correct Factor dB	Measure- ment dBuV/m	Limit dBuV/m	Over dB	Detector	Antenna Height cm	Table Degree	Comment
1	!	33.5623	49.31	-14.36	34.95	40.00	-5.05	QP			
2	*	40.4170	48.63	-13.65	34.98	40.00	-5.02	QP			
3		112.4500	51.22	-17.43	33.79	43.50	-9.71	QP			
4		116.5400	51.51	-17.19	34.32	43.50	-9.18	QP			
5		128.9400	47.07	-16.35	30.72	43.50	-12.78	QP			
6		140.5800	47.36	-17.09	30.27	43.50	-13.23	QP			

*:Maximum data x:Over limit !:over margin

Operator: QIU

Above 1000MHz

Operation Mode: TX Mode (CH01: 2402MHz) Test Date : August 21, 2014
 Frequency Range: 1-25GHz Temperature : 25 °C
 Test Result: PASS Humidity : 50 %
 Measured Distance: 3m Test By: Andy

Freq. (MHz)	Ant. Pol. H/V	Emission Level(dBuV/m)		Limit 3m(dBuV/m)		Margin(dB)	
		PK	AV	PK	AV	PK	AV
4804	V	66.13	48.22	74	54	-7.87	-5.78
7206	V	65.18	47.13	74	54	-8.82	-6.87
9608	V	64.02	46.85	74	54	-9.98	-7.15
12010	V	63.27	45.75	74	54	-10.73	-8.25
14412	V	62.75	44.33	74	54	-11.25	-9.67
16814	V	61.83	43.95	74	54	-12.17	-10.05
4804	H	65.22	47.16	74	54	-8.78	-6.84
7206	H	64.03	46.25	74	54	-9.97	-7.75
9608	H	63.95	45.95	74	54	-10.05	-8.05
12010	H	62.49	44.87	74	54	-11.51	-9.13
14412	H	61.33	43.69	74	54	-12.67	-10.31
16814	H	60.95	42.95	74	54	-13.05	-11.05

Other harmonics emissions are lower than 20dB below the allowable limit.

- Note:**
- (1) All Readings are Peak Value and AV.
 - (2) Emission Level= Reading Level+ Probe Factor +Cable Loss.
 - (3) The average measurement was not performed when the peak measured data under the limit of average detection.

Operation Mode: TX Mode (CH21: 2442MHz) Test Date : August 21, 2014
 Frequency Range: 1-25GHz Temperature : 25 °C
 Test Result: PASS Humidity : 50 %
 Measured Distance: 3m Test By: Andy

Freq. (MHz)	Ant. Pol. H/V	Emission Level(dBuV/m)		Limit 3m(dBuV/m)		Margin(dB)	
		PK	AV	PK	AV	PK	AV
4884	V	65.85	47.13	74	54	-8.15	-6.87
7326	V	64.19	46.22	74	54	-9.81	-7.78
9768	V	63.23	45.95	74	54	-10.77	-8.05
12210	V	62.87	44.72	74	54	-11.13	-9.28
14652	V	61.02	43.19	74	54	-12.98	-10.81
17094	V	60.78	42.85	74	54	-13.22	-11.15
4884	H	64.33	46.22	74	54	-9.67	-7.78
7326	H	63.95	45.19	74	54	-10.05	-8.81
9768	H	62.73	44.28	74	54	-11.27	-9.72
12210	H	61.09	43.95	74	54	-12.91	-10.05
14652	H	60.82	42.10	74	54	-13.18	-11.90
17094	H	59.13	41.89	74	54	-14.87	-12.11

Other harmonics emissions are lower than 20dB below the allowable limit.

- Note:**
- (1) All Readings are Peak Value and AV.
 - (2) Emission Level= Reading Level+ Probe Factor +Cable Loss.
 - (3) The average measurement was not performed when the peak measured data under the limit of average detection.

Operation Mode: TX Mode (CH40: 2480MHz) Test Date : August 21, 2014
 Frequency Range: 1-25GHz Temperature : 25 °C
 Test Result: PASS Humidity : 50 %
 Measured Distance: 3m Test By: Andy

Freq. (MHz)	Ant. Pol. H/V	Emission Level(dBuV/m)		Limit 3m(dBuV/m)		Margin(dB)	
		PK	AV	PK	AV	PK	AV
4960	V	64.23	46.25	74	54	-9.77	-7.75
7440	V	63.29	45.95	74	54	-10.71	-8.05
9920	V	62.16	44.25	74	54	-11.84	-9.75
12400	V	61.07	43.95	74	54	-12.93	-10.05
14880	V	60.22	42.13	74	54	-13.78	-11.87
17360	V	59.75	41.07	74	54	-14.25	-12.93
4960	H	65.13	45.95	74	54	-8.87	-8.05
7440	H	64.28	44.23	74	54	-9.72	-9.77
9920	H	63.95	43.52	74	54	-10.05	-10.48
12400	H	62.72	42.16	74	54	-11.28	-11.84
14880	H	61.49	41.07	74	54	-12.51	-12.93
17360	H	60.59	40.85	74	54	-13.41	-13.15

Other harmonics emissions are lower than 20dB below the allowable limit.

- Note:**
- (1) All Readings are Peak Value and AV.
 - (2) Emission Level= Reading Level+ Probe Factor +Cable Loss.
 - (3) The average measurement was not performed when the peak measured data under the limit of average detection.

5.6 Radiated Measurement Photos:

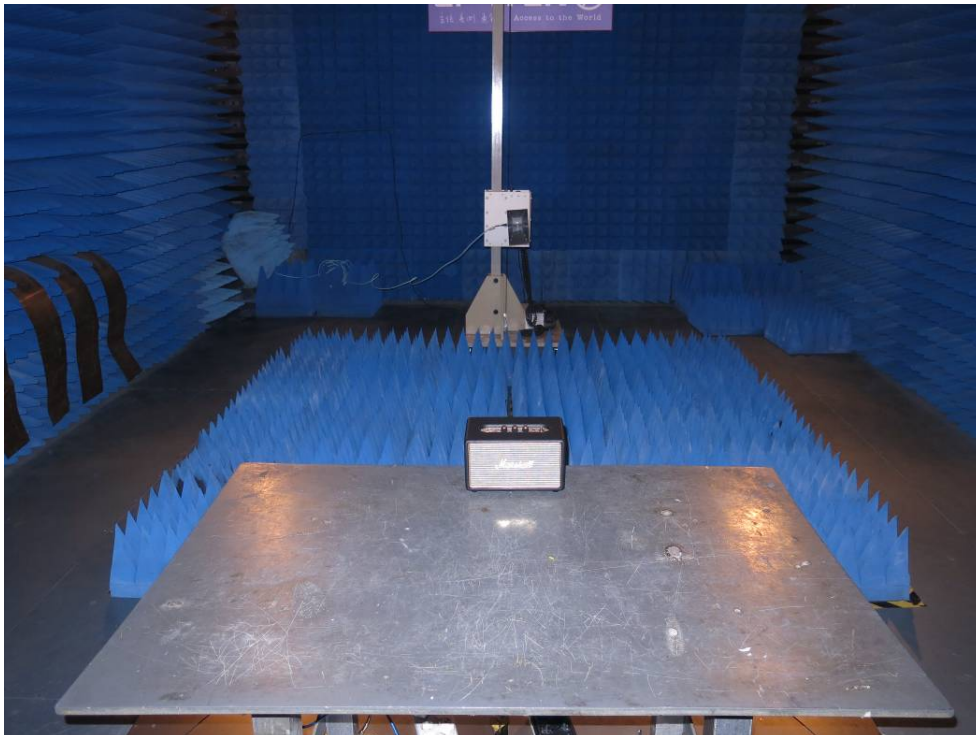
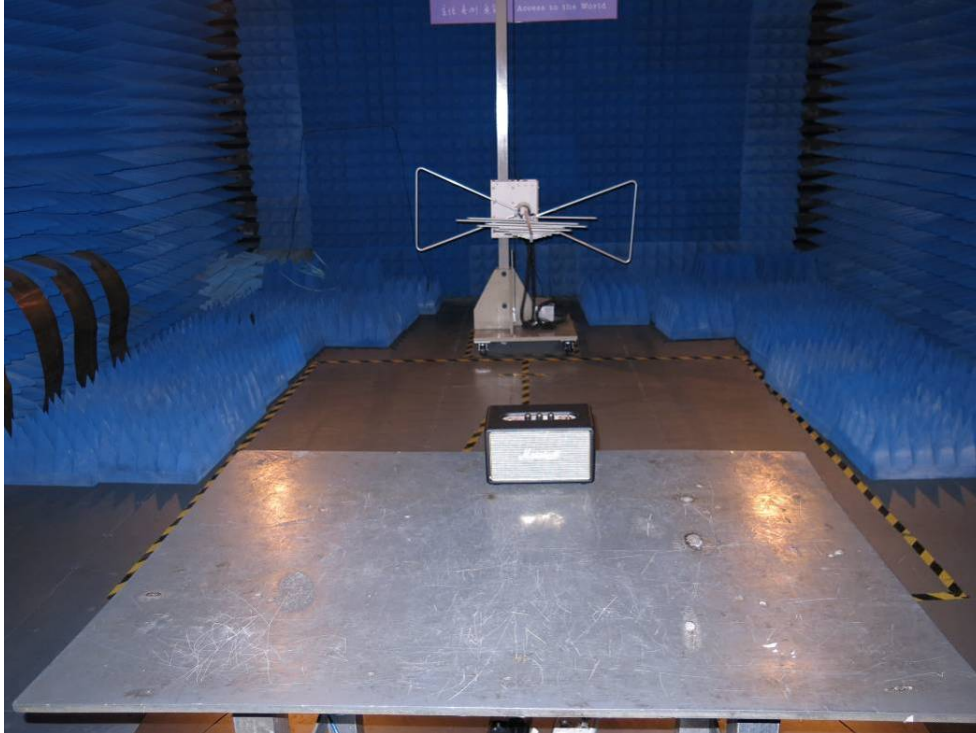

6. 6dB Bandwidth Measurement

6.1 Measurement Procedure

The EUT was operating in Bluetooth mode or could be controlled its channel. Printed out the test result from the spectrum by hard copy function.

6.2 Test SET-UP (Block Diagram of Configuration)

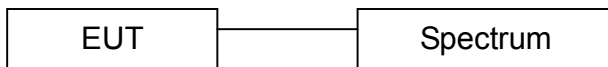

6.3 Measurement Equipment Used:

EQUIPMENT TYPE	MFR	MODEL NUMBER	SERIAL NUMBER	LAST CAL.	CAL DUE.
Spectrum Analyzer	Rohde & Schwarz	FSV30	1321.3008K	05/16/2014	05/15/2015

6.4 Measurement Results:

The following table is the setting of spectrum analyzer.

EMI Test Receiver	Setting
Attenuation	Auto
Span	2MHz
RB	100kHz
VB	300kHz
Detector	Peak
Trace	Max hold
Limit: The minimum 6dB bandwidth shall be at least 500kHz.	

Refer to attached data chart.

Spectrum Detector: PK Test Date : August 21, 2014
 Test By: Andy Temperature : 25 °C
 Test Result: PASS Humidity : 50 %

Channel number	Channel frequency (MHz)	Measurement level (KHz)	Required Limit (KHz)
01	2402	706	>500
21	2442	700	>500
40	2480	712	>500

Channel 01:

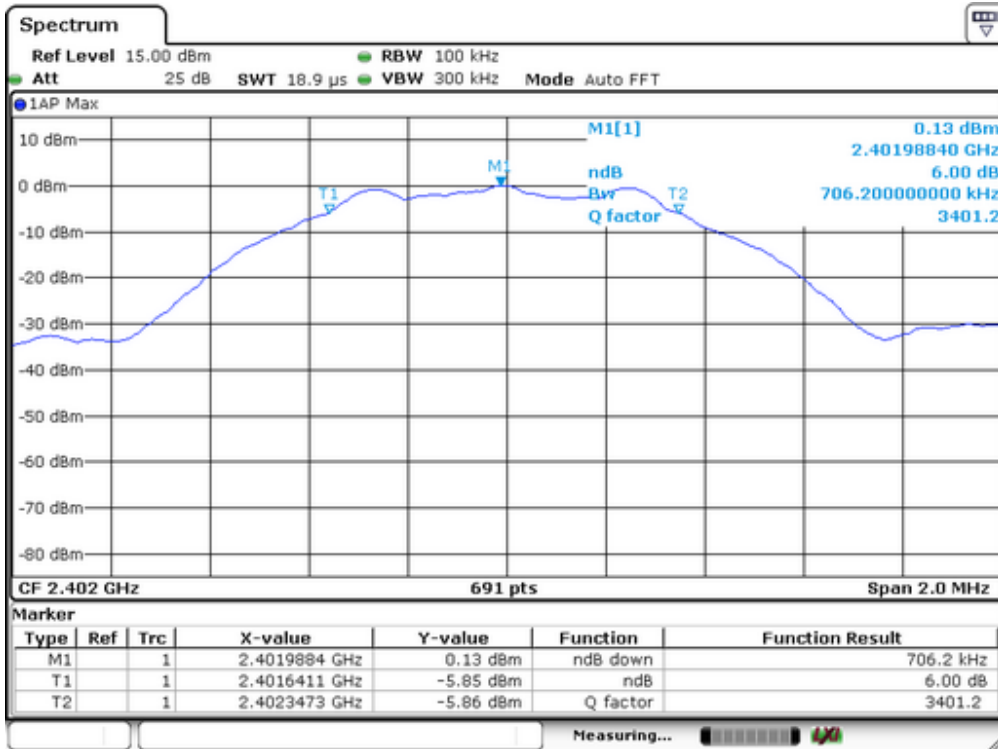

Channel 21:

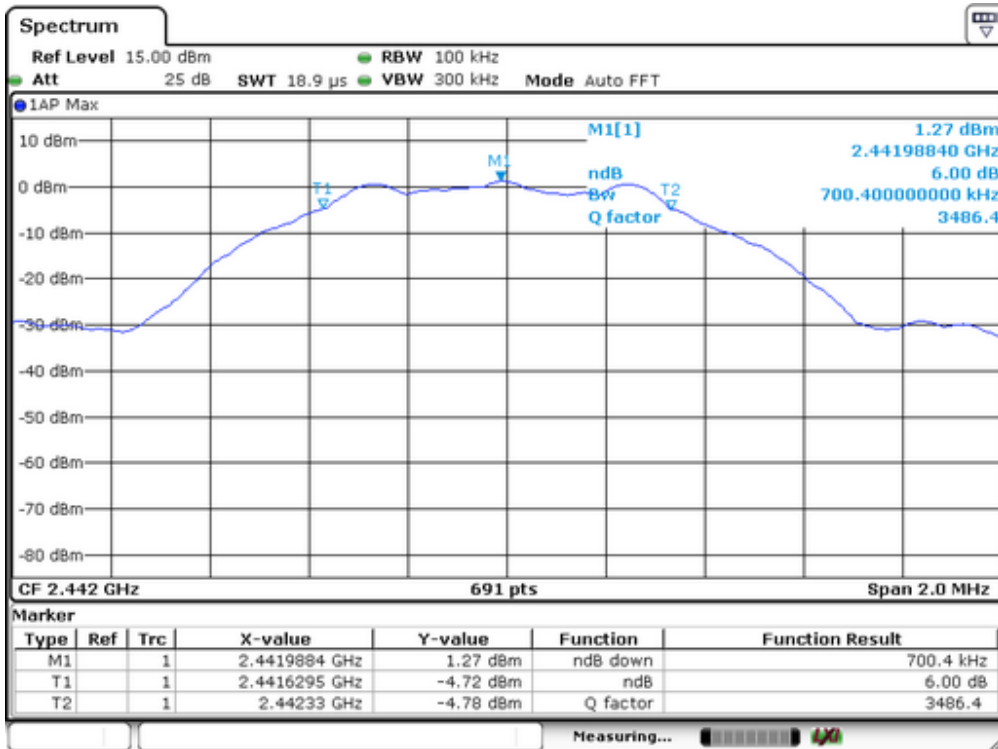

Channel 40:

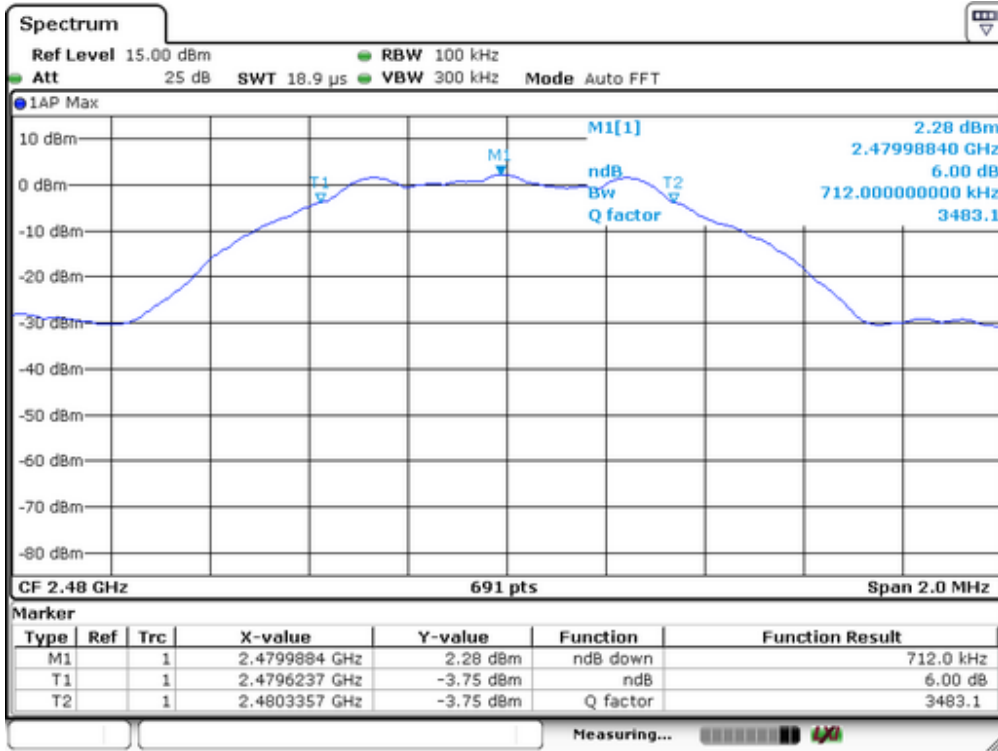

7. MAXIMUM PEAK OUTPUT POWER TEST

7.1 Measurement Procedure

- a. The Transmitter output (antenna port) was connected to the spectrum Analyzer.
- b. Turn on the EUT and then record the peak power value.
- c. Repeat above procedures on all channels needed to be tested.

7.2 Test SET-UP (Block Diagram of Configuration)

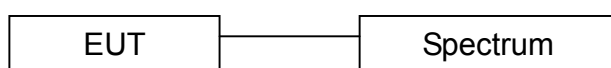

7.3 Measurement Equipment Used:

EQUIPMENT TYPE	MFR	MODEL NUMBER	SERIAL NUMBER	LAST CAL.	CAL DUE.
Spectrum Analyzer	Rohde & Schwarz	FSV30	1321.3008K	05/16/2014	05/15/2015

7.4 Peak Power output limit

The following table is the setting of spectrum analyzer.

EMI Test Receiver	Setting
Attenuation	Auto
Span	6MHz
RB	3MHz
VB	3MHz
Detector	Peak
Trace	Max hold
Limit: The maximum peak power shall be less 1Watt.	

7.5 Measurement Results:
 Refer to attached data chart.

Spectrum Detector: PK Test Date : August 21, 2014
 Test By: Andy Temperature : 25 °C
 Test Result: PASS Humidity : 50 %

Channel number	Channel Frequency (MHz)	Peak Power output(dBm)	Peak Power Limit(W)	Pass/Fail
01	2402	0.50	1W(30dBm)	PASS
21	2442	1.57	1W(30dBm)	PASS
40	2480	2.44	1W(30dBm)	PASS

Channel 01

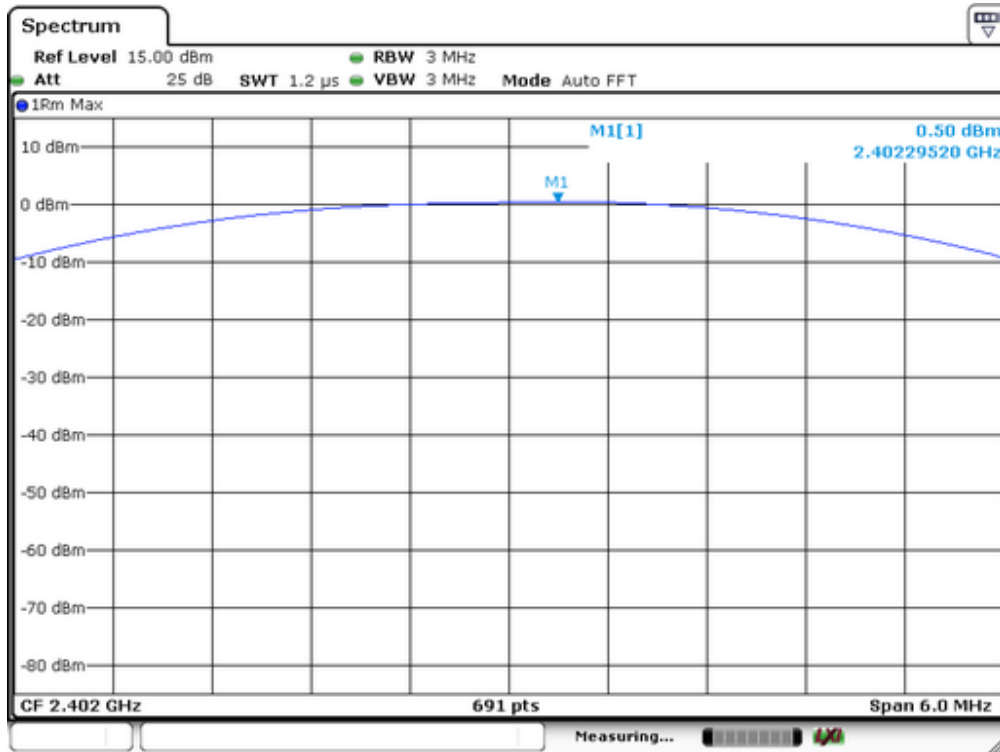

Channel 21

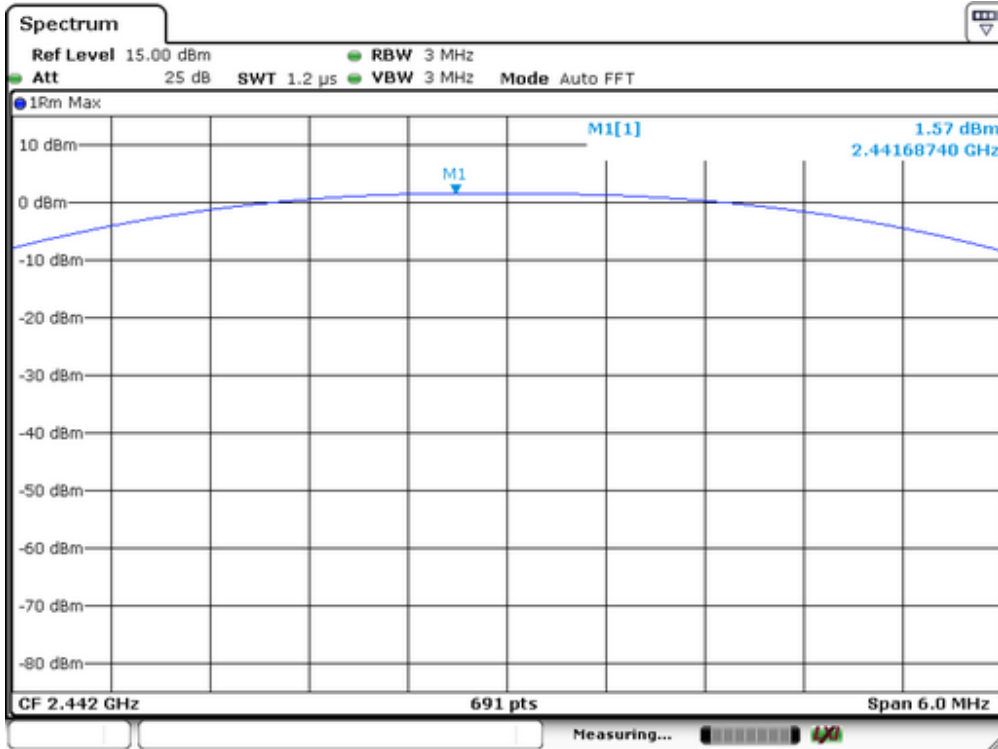

Channel 40

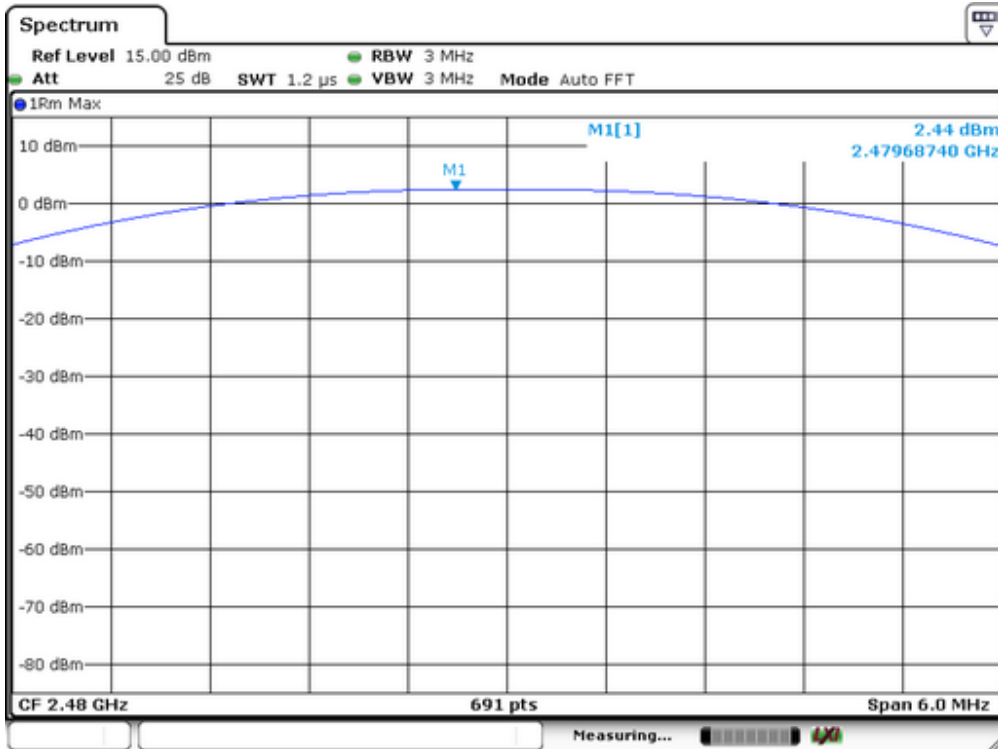

8. Power Spectral Density Measurement

8.1 Measurement Procedure

The EUT was operating in Bluetooth mode or could be controlled its channel. Printed out the test result from the spectrum by hard copy function.

8.2 Test SET-UP (Block Diagram of Configuration)

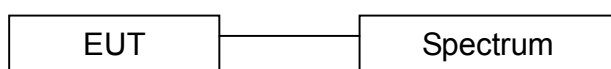

8.3 Measurement Equipment Used:

EQUIPMENT TYPE	MFR	MODEL NUMBER	SERIAL NUMBER	LAST CAL.	CAL DUE.
Spectrum Analyzer	Rohde & Schwarz	FSV30	1321.3008K	05/16/2014	05/15/2015

8.4 Measurement Procedure

8.4.1 The RF output of EUT was connected to the spectrum analyzer by RF cable and attenuator. The path loss was compensated to the results for each measurement.

8.4.2. Set to the maximum power setting and enable the EUT transmit continuously.

8.4.3. Make the measurement with the spectrum analyzer's resolution bandwidth (RBW) = 3 kHz. Video bandwidth VBW = 10 kHz In order to make an accurate measurement, set the span to 1.5 times DTS Channel Bandwidth. (6dB BW)

8.4.4. Detector = peak, Sweep time = auto couple, Trace mode = max hold, Allow trace to fully stabilize. Use the peak marker function to determine the maximum power level.

8.4.5. Measure and record the results in the test report.

8.4.6. The Measured power density (dBm)/ 100KHz is a reference level and used as 20dBc down limit line for Conducted Band Edges and Conducted Spurious Emission.

8.5 Measurement Results:

The following table is the setting of spectrum analyzer.

Spectrum analyzer	Setting
Attenuation	Auto
Span Frequency	Set the span to 1.5 times the DTS bandwidth.
RB	$3\text{kHz} \leq \text{RBW} \leq 100\text{kHz}$
VB	3 x RBW
Detector	Peak
Trace	Max hold
Sweep Time	Automatic

Refer to attached data chart.

Spectrum Detector:	PK	Test Date :	August 21, 2014
Test By:	Andy	Temperature :	25 °C
Test Result:	PASS	Humidity :	50 %

Channel number	Channel frequency (MHz)	Measurement level (dBm)		Required Limit (dBm)	Pass/Fail
01	2402	0.08	-15.45	8	PASS
21	2442	1.35	-14.01	8	PASS
40	2480	2.33	-12.78	8	PASS

PSD 100kHz Plot:
Channel 01

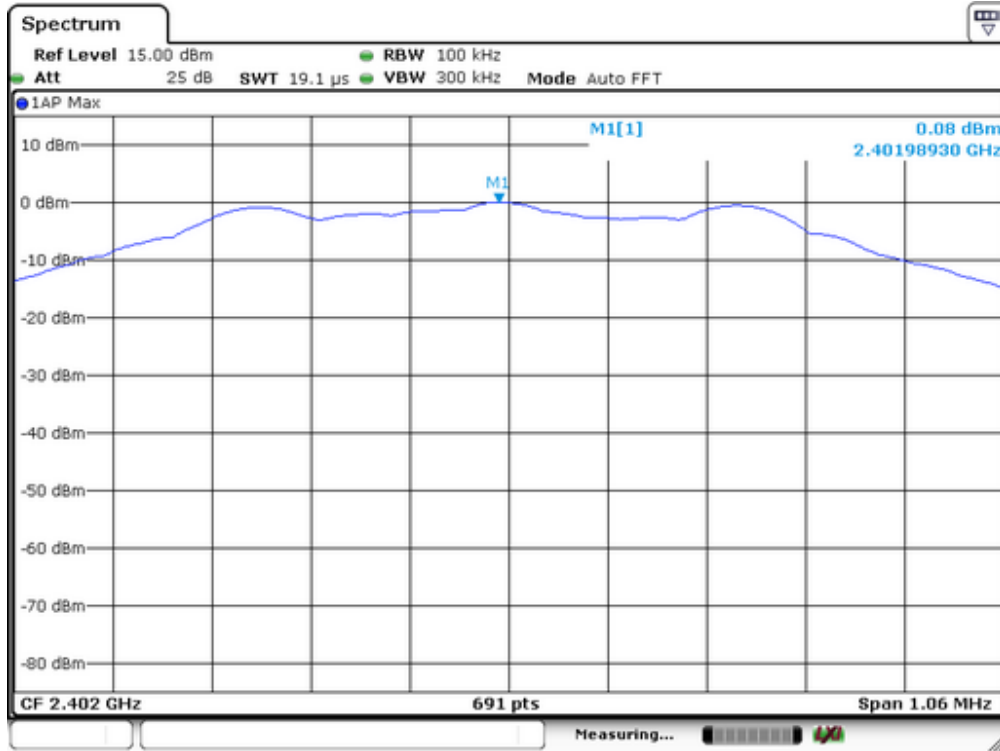

Channel 21

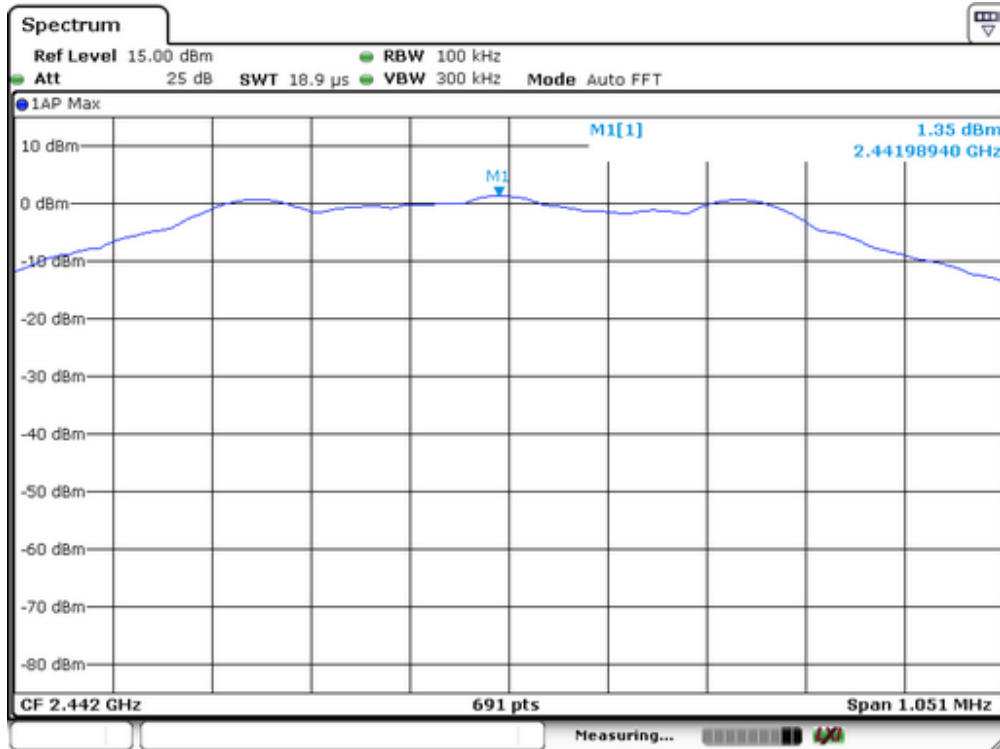

Channel 40

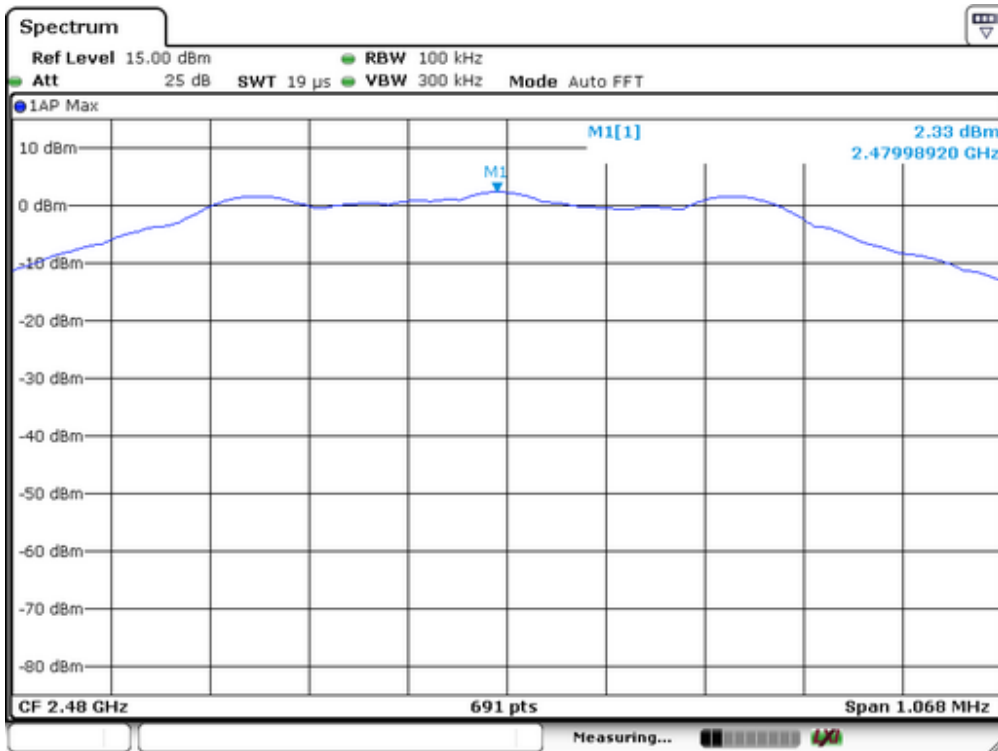

PSD 3KHz Plot:
Channel 01

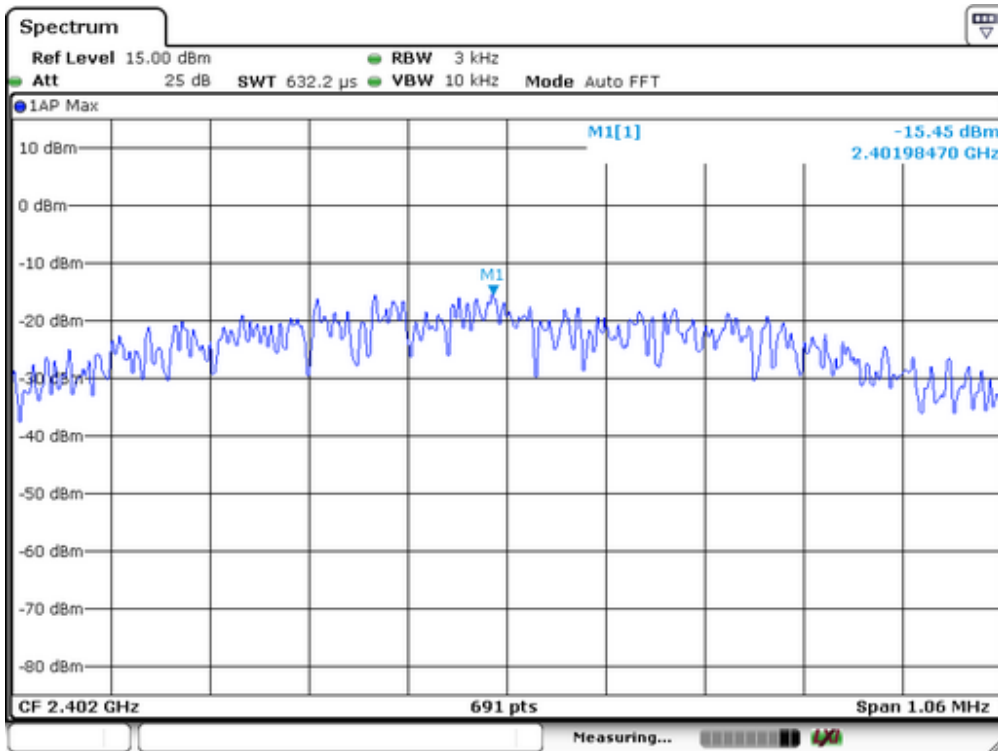

Channel 21

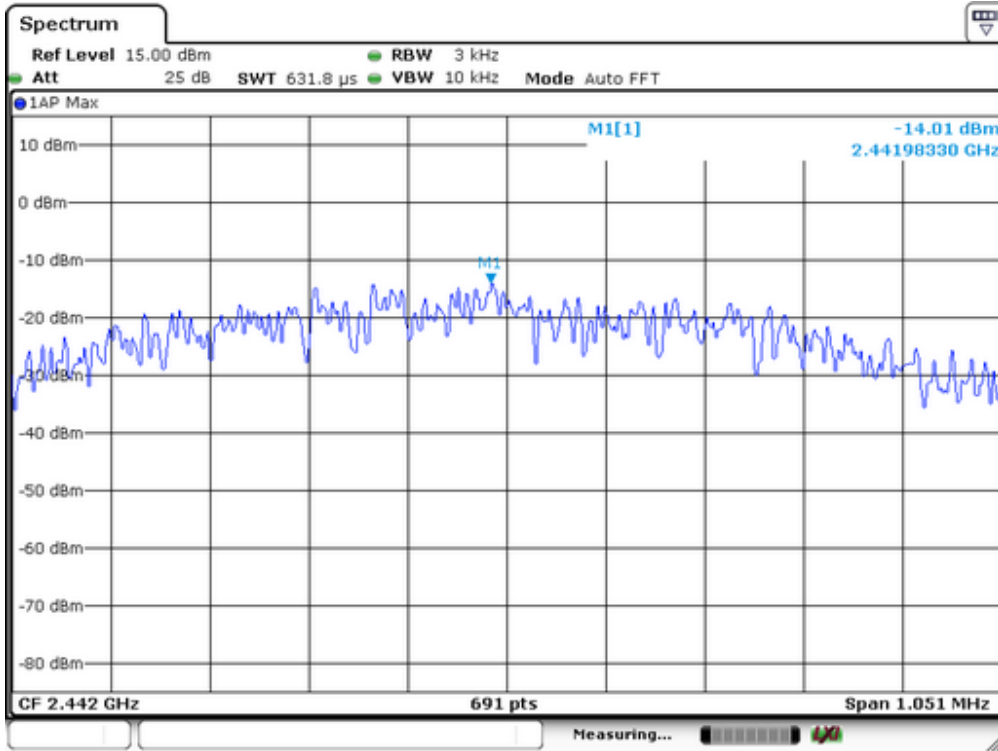

Channel 40

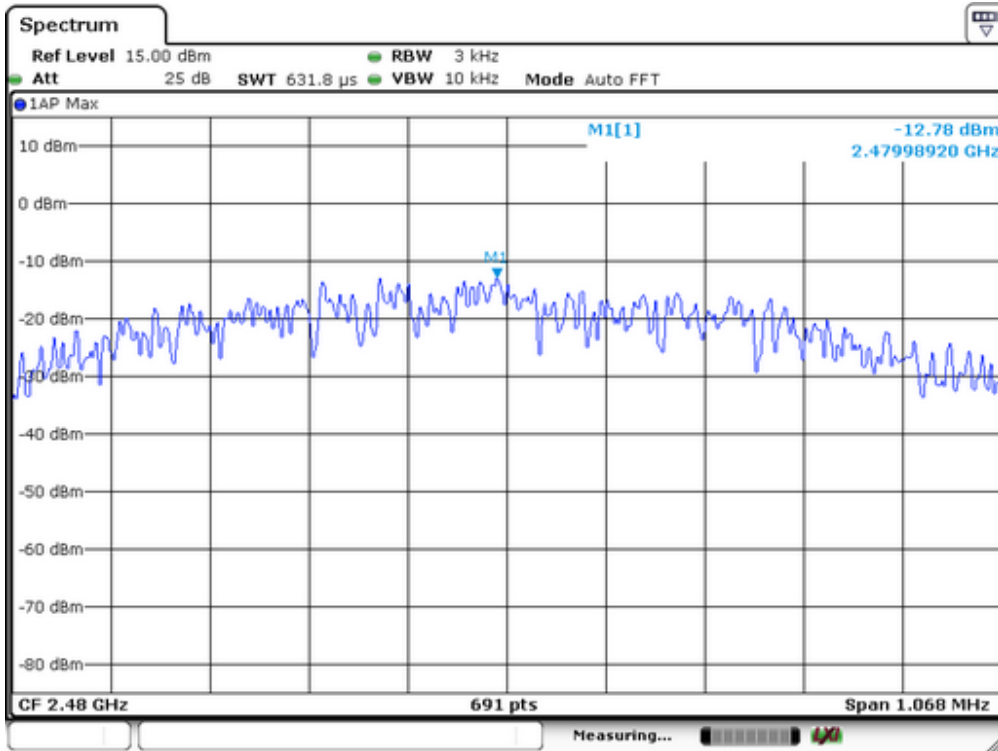

9. Band EDGE test

9.1 Measurement Procedure

For Conducted Test

1. The transmitter output is connected to a spectrum analyzer. The resolution bandwidth is set to 100KHz. The video bandwidth is set to 300KHz.
2. The spectrum from 30MHz to 26 GHz is investigated with the transmitter set to the lowest, middle, and highest channels.
3. Preliminary tests on individual chains, and on all chains with a combiner, were performed. The worst-case configuration was with a combiner, therefore final test were preformed with all chains feeding a combiner.

For Radiated emission Test

1. The EUT was Operating in hopping mode or could be controlled its channel. Printed out test result from the spectrum by hard copy function.
2. The EUT was placed on a turn table which is 0.8m above ground plane.
3. Maximum procedure was performed on the six highest emissions to ensure EUT compliance.
4. And also, each emission was to be maximized by changing the polarization of receiving antenna both horizontal and vertical.
5. Repeat above procedures until all frequency measured were complete.

The following table is the setting of spectrum analyzer.

Spectrum analyzer	Setting
Attenuation	Auto
Span Frequency	10MHz
RB	100KHz
VB	300KHz
Detector	Peak
Trace	Max hold
Sweep Time	Automatic

9.2 Test SET-UP (Block Diagram of Configuration)

For Conducted Test

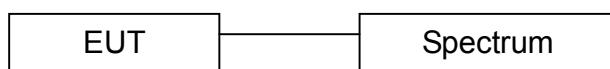

For Radiated emission Test

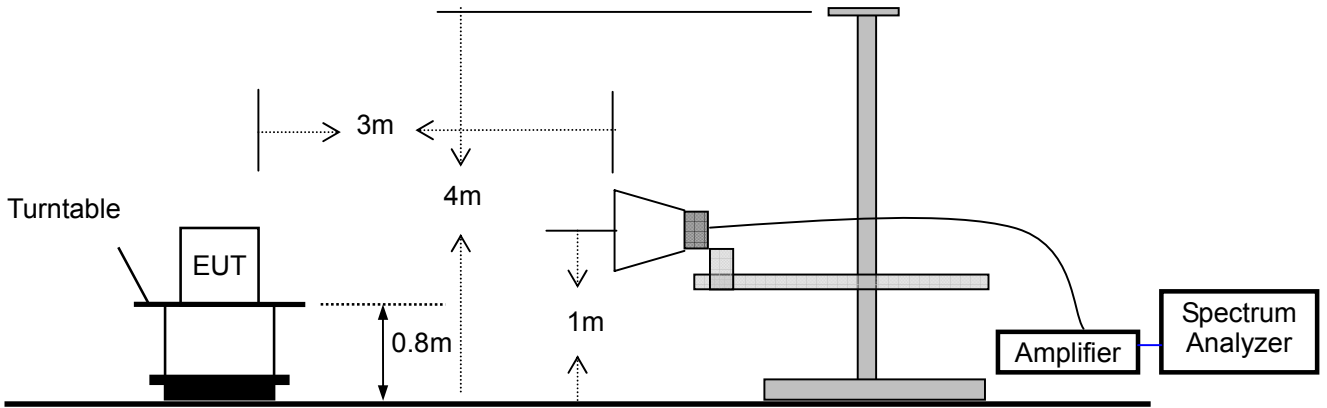

9.3 Measurement Results:

Refer to attached data chart.

Spectrum Detector:	PK	Test Date :	August 21, 2014
Test By:	Andy	Temperature :	25 °C
Test Result:	PASS	Humidity :	50 %

1. Conducted Test

Frequency (MHz)	Peak Power Output(dBm)	Emission read Value(dBm)	Result of Band edge(dBc)	Band edge Limit(dBc)
<2400	0.50	-43.46	43.96	>20dBc
>2483.5	2.44	-53.53	55.97	>20dBc

2. Radiated emission Test

Frequency (MHz)	Antenna polarization (H/V)	Emission (dBuV/m)		Band edge Limit (dBuV/m)	
		PK	AV	PK	AV
<2400	H	65.13	48.22	74.00	54.00
<2400	V	59.39	45.01	74.00	54.00
>2483.5	H	64.08	47.16	74.00	54.00
>2483.5	V	58.19	43.51	74.00	54.00

10 Antenna Application

10.1 Antenna requirement

The EUT'S antenna is met the requirement of FCC part 15C section 15.203 and 15.247.

FCC part 15C section 15.247 requirements:

Systems operating in the 2402-2480MHz band that are used exclusively for fixed, point-to-point operations may employ transmitting antennas with directional gain greater than 6dBi provided the maximum peak output power of the intentional radiator is reduced by 1dB for every 3dB that the directional gain of the antenna exceeds 6dBi.

10.2 Result

The EUT's antenna is a chip antenna and integrated on PCB, The antenna's gain is 0dBi and meets the requirement.

APPENDIX I (PHOTOS OF EUT)



