

VT-M2M-TC VM User's Manual

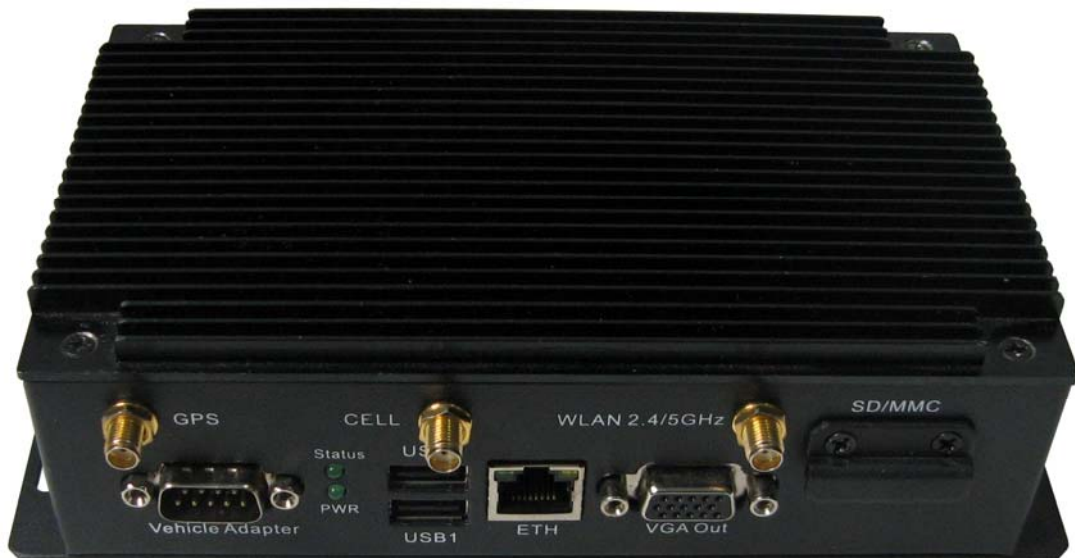

Chengdu Vantron Technology, Ltd.
www.vantrontech.com.cn

All Rights Reserved

Revision History:

No.	Version	Description	Date
1	V1.0	First release	Aug.30, 2013
2	V2.1	Change SmartDisplay Audio to mono line-out(left channel)	Oct.10, 2013
3	V2.2	Add FCC warning statement	Dec. 11, 2013
4	V2.3	Change power in to DC6-36V(default 12V)	Dec. 16, 2013
5	V2.4	Update product picture	Jan. 2, 2014
6	V2.5	Update the order information	Jan.17,2014
7	V2.6	Add 802.11a mode Add install requirements	Jan 23,2014
8	V2.7	Update product picture	Feb 20,2014

Table of Contents

Part I: Hardware Platform	5
1 Foreword	6
1.1 Copyright Notice.....	6
1.2 Notes.....	6
1.3 Statement.....	6
1.4 Disclaimer.....	6
1.5 Limitation of Liability/Non-warranty.....	7
1.6 Safety Instructions.....	7
1.7 Precautions.....	7
1.8 Safety Instructions for Power Cables and Accessories.....	7
2 Overview	9
2.1 Introduction.....	9
2.2 Product Series.....	10
3 M2M-TC VM Hardware Instructions	11
3.1 Product Appearance.....	11
3.2 Specifications.....	12
3.3 Interface Instructions.....	14
3.4 Dimension.....	15
3.5 Interface Description.....	16
3.5.1 Wide-Range Power Interface.....	16
3.5.2 Smart Display Connector.....	18
3.5.3 Ethernet Interface.....	20
3.5.4 D Sub-9 RS232 Connector.....	21
3.5.5 RS232/485,CAN,External IO Connector.....	22
3.5.6 VGA Interface.....	23
3.5.7 USB Host Connector.....	24
3.5.8 LED.....	24
3.6 Operation Notice.....	25
3.6.1 Change SIM Card.....	25
4 Tips	26
Part II: Software Reference	28
1 Introduction	28
1.1 About This Manual.....	28
1.2 Linux OS Support.....	28
1.3 Sample Programs.....	28
1.4 Functionalities layout.....	29
2 Base Control	30
2.1 Power Control.....	30
2.2 Can Control.....	30
2.3 GPIO Control.....	30
2.4 Serial COM Control.....	31
2.5 Audio And Video Control.....	32
2.6 SD card Control.....	32
2.7 ADXL345 Control.....	32

2.8	Watchdog	32
2.9	PnI7 Control	33
2.10	MCU Power Control	33
2.11	Touch Screen	34
2.12	Host AP	35
2.13	OnBorad.....	38
3	Network Module	39
3.1	WIFI Control	39
3.2	3G Control	40
3.3	Bluetooth Control.....	43
4	GPS Module	48
4.1	Get GPS Data	48
4.2	GPS Data Format.....	48
5	Update System	52
5.1	Make USB boot Stick and Copy Image to USB stick	52
5.2	Update steps.....	54

Part I: Hardware Platform

1 Foreword

1.1 Copyright Notice

While all information contained herein have been carefully checked to assure its accuracy in technical details and printing, Vantron assumes no responsibility resulting from any error or features of this manual, or from improper uses of this manual or the software. Please contact our technical department for relevant operation solutions if there is any problem that cannot be solved according to this manual.

Vantron reserves all rights of this manual, including the right to change the content, form, product features, and specifications contained herein at any time without prior notice. The latest version of this manual is at www.vantrontech.com.cn. Please contact Vantron for further information:

Vantron Technology (Vantron)



E-mail: sales@vantrontech.com

The trademarks and registered trademarks in this manual are properties of their respective owners. No part of this manual may be copied, reproduced, translated or sold. No changes or other purposes are permitted without the prior written consent of Vantron.

Vantron reserves the right of all publicly-released copies of this manual.

1.2 Notes

Applicable notes are listed in the following table:

Sign	Notice Type	Description
	Notice	Important information and regulations
	Caution	Caution for latent damage to system or harm to personnel

1.3 Statement

It is recommended to read and comply with this manual before operating VT-M2M TC which provides important guidance and helps decreasing the danger of injury, electric shock, fire, or any damage to the device.

1.4 Disclaimer

Vantron assumes no legal liability of accidents resulting from failure of conforming to the safety instructions.

1.5 Limitation of Liability/Non-warranty

For direct or indirect damage to this device or other devices of Vantron caused by failure of conforming to this manual or the safety instructions on device label, Vantron assumes neither warranty nor legal liability even if the device is still under warranty.

The VT-M2M-TC VM should be installed, debugged and maintained by professional people.

The outside antennas are not permitted to be installed or to be changed by non-professional people. To run the device normally, only specify antennas are approved to be assembled together by professional people.

Unit shall be used with indoor-use antenna only. No antenna for this unit can be installed outdoor.

1.6 Safety Instructions

- ✧ Keep and comply with all operation instructions, warnings, and information.
- ✧ Pay attention to warnings on this device.
- ✧ Read the following precautions so as to decrease the danger of injury, electric shock, fire, or any damage to the device.

1.7 Precautions

- ✧ Pay attention to the product labels/safety instructions printed on silk screens.
- ✧ Do not try repairing this product unless declared in this manual.
- ✧ Keep away from heat source, such as heater, heat dissipater, or engine casing.
- ✧ Do not insert other items into the slot (if any) of this device.
 - Keep the ventilation slot ventilated for cooling.
 - System fault may arise if other items are inserted into this device.
- ✧ Installation: ensure correct installation according to instructions from the manufacturer with recommended installation tools.
- ✧ Ensure ventilation and smoothness according to relevant ventilation standard.

1.8 Safety Instructions for Power Cables and Accessories



Proper power source only

Start only with power source that satisfies voltage label and the voltage necessary according to this manual. Please contact technical support personnel of Vantron for any uncertainty about the requirements of necessary power source.



Use tested power source

This product still contains a button lithium battery as a real-time clock after its external power source is removed and therefore should not be short-circuited

during transportation or placed under high temperature.



Place cables properly:

Do not place cables at any place with extrusion danger.



Cleaning Instructions

- ✧ Please power off before cleaning the device.
- ✧ Do not use spray detergent.
- ✧ Clean with a damp cloth.
- ✧ Do not try cleaning exposed electronic components unless with a dust collector.
- ✧ Support for special fault: Power off and contact technical support personnel of Vantron in case of the following faults:
 - The device is damaged.
 - The temperature is excessively high.
 - Fault is still not solved after the operation according to the manual.

2 Overview

2.1 Introduction

Thank you for choosing Vantron. It is our commitment to provide our valued customers with the embedded devices equipped with the state-of-the-art technology and the best product services.

Vantron's M2M products are based on the most advanced ARM and Intel Atom processors and have low-power consumption and high integration. The products are designed for applications of M2M in industrials, medicals, financial, retail, vehicle, and transportations etc.

2.2 Product Series

Order Code

VT-M2M-TC VM-4-1GM-8GF-GW2P-V

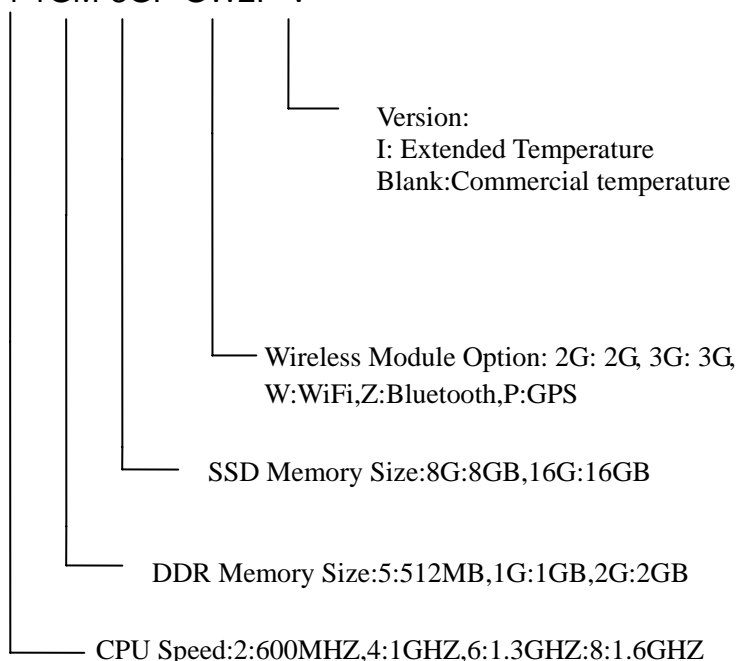

Order Examples:

VT-M2M-TC VM-4-1GM-8GF	ATOM E640 Processor, 1GHz CPU, 1GB DDR2
VT-M2M-TC VM-6-1GM-8GF-W	ATOM E660 Processor, 1.3GHz CPU, 1GB DDR2, 8G Flash, WLAN
VT-M2M-TC VM-8-1GM-8GF-3GW	ATOM E680 Processor, 1.6GHz CPU, 1GB DDR2, 8G Flash , 3G,WLAN

Accessories:

Install Mechanical tools,1pc
IO Terminal (12x3.81mm) (Optional),1pc
3G Antenna(Optional),1pc
WiFi Antenna(Optional),1pc
Bluetooth Antenna(Optional),1pc
GPS Antenna(Optional),1pc
Smart Display Cable

3 M2M-TC VM Hardware Instructions

3.1 Product Appearance



Front Side View



Back Side View



Bottom View for optional embedded modules

3.2 Specifications

Specifications		
CPU	Processor	Intel® ATOM™, E620(T)0.6GHz E640(T)1GHz, E660(T)1.3GHz, E680(T),1.6GHz 32KB Instruction cache +23KB L1 cache, 512KB L2 cache
Memory	On Board RAM	DDR2 512MB (up to 2GB)@800MHz
	ROM Internal	Half SATA SSD Module Internal (8GB or others)
Display	Chipset	Intel® Platform Controller Hub EG20T. Support LCD/SDVO, Simultaneous/dual view display
	Resolution	Up to 1280 x 1024 @ 85Hz for VGA Decode:H.264,MPEG4, MPEG2,VC1,WMV-9, Div-X Encode:H.264,MPEG4
	Interface	1xVGA (DB15) 1xLVDS (Optional Internal)
Wireless Communication	WLAN	Optional 1X (Mini PCIE or USB2.0)802.11a/ b/g/n Wireless Module, external antenna
	3G Module	Optional 1x mini PCIE 3G Broad Band Module with SIM slot
	Bluetooth	Bluetooth Class1. Wireless Transmit Module
	GPS	Optional 1X GPS module, external antenna
Peripheral Interfaces	Ethernet	1x10/100/1000-BaseT(RJ45)
	USB	2xUSB2.0 Host (Type A)
	Audio	HD Audio, 1xMIC in 3.5mm, 1xstereo Headphone 3.5mm,SmartDisplay mono line-out(left channel)
	COM Port	1xDB9 External, 1xRS232/485 Internal 1xCAN 2.0b up to 1Mbit/s
	Alarm	Buzzer Out
	SD card	1xSD card Slot (Optional)
	RTC	Supported
	Control	Power Button on the back
	GPIO	Reserved GPIO X6(Terminal)
	UART	1x full function UART use DB9,MAX: 1.0M Baud
	Security	Security(Optional)
Software	OS	Linux
	Applications	SDK Available
Power	Input	DC6-36V(default 12V), Locked Power Jack
	Consumption	8W (Pulse15W), Sleep 2W. (without 3G.GPS.Ziabee.WLAN)
Mechanical	Dimensions	170x102x52mm (Box)
	Install Brackets	192x102x52mm
	Weight	0.6Kg (1.2KKg package Kit)
	Enclosure	Aluminum Alloy with Black Color
Environment Condition	Temperature	Operating: -0°C ~ +60°C (ETR: -40°C ~ +80°C Optional)

		Storage: -20°C ~ +70°C, (ETR: -40°C ~ +85°C Optional)
	Humidity	5-95%RH at 25-35 (Non-Condensation)
	Cooling Mode	Fan less, Heat Sink
	Approvals	UL, FCC Class B, and CE

3.3 Interface Instructions



Front Side View



Back Side View

3.4 Dimension

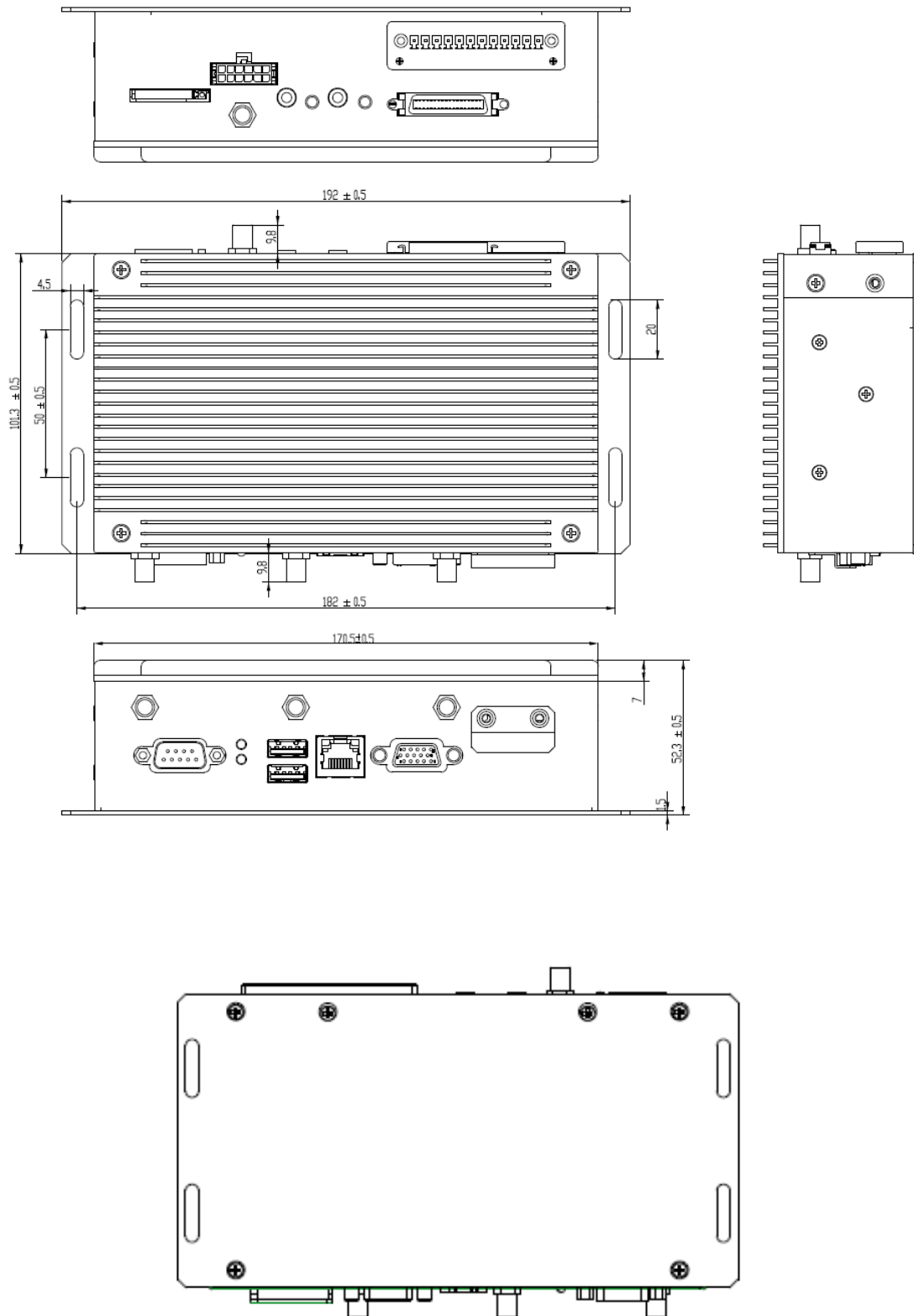

3.5 Interface Description

3.5.1 Wide-Range Power Interface

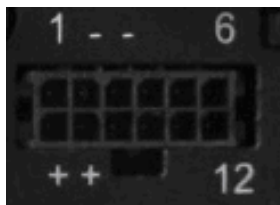

Power connector outlook

Pin	Description
1	Chassis Ground
2	Ground
3	Ground
4	N/C(Not Connect)
5	N/C(Not Connect)
6	N/C(Not Connect)
7	Power Input (6 ~ 36 VDC)
8	Power Input (6 ~ 36 VDC)
9	Acc Ignition Input
10	Ground
11	N/C(Not Connect)
12	Power button Input (optional)

Power connector photo



Pin Definition of Power Cord

Pin	Definition	Color
7,8	+	Red
2,3	-	Black
1	Chassis Ground	Blue
9	Ignition	White

3.5.2 Smart Display Connector



Smart Display Connector Photo

Pin Definition of Smart Display Connector

Pin	Description	Pin	Description
1	LCD_BL_EN(Backlight Enable output)	19	USB_D-(USB Data Negative Output Pin)
2	Panel_PWR_EN(Panel Power Enable output)	20	USB_D+(USB Data Positive Output Pin)
3	LVDS Ground(ground pin)	21	USB Ground(ground pin)
4	Reset_BTN#(Reset Signal Input)	22	USB Ground(ground pin)
5	LVDS_CLKP(Positive Clock Signal Input Pin)	23	+12 VDC output(+/- 10%, max 1.5A)
6	LVDS_CLKN(Negative Clock Signal Input Pin)	24	+12 VDC output(+/- 10%, max 1.5A)
7	LVDS Ground(ground pin)	25	+12 VDC output(+/- 10%, max 1.5A)
8	LVDS Ground(ground pin)	26	+12 VDC output(+/- 10%, max 1.5A)
9	LVDS_DATAP2(LVDS Data2 Positive Input Pin)	27	Power Ground(ground pin)
10	LVDS_DATAN2(LVDS Data2 Negative Input Pin)	28	Power Ground(ground pin)
11	RS232_TXD1(RS232 Data output Pin)	29	Power Ground(ground pin)
12	RS232_RXD1(RS232 Data input Pin)	30	Power Ground(ground pin)
13	LVDS_DATAP1(LVDS Data1 Positive Input Pin)	31	N/C(Not Connect)
14	VDS_DATAN1(LVDS Data1 Negative Input Pin)	32	N/C(Not Connect)
15	LVDS Ground(ground pin)	33	N/C(Not Connect)
16	LVDS Ground(ground pin)	34	Power Button Input #
17	VDS_DATAP0(LVDS Data0 Positive Input Pin)	35	Audio Ground
18	VDS_DATAN0(LVDS Data0 Negative Input Pin)	36	Mono. Line-out(left channel)

Optional Smart Display Cable.



3.5.3 Ethernet Interface

Standard RJ45 interface, supporting 10M/100M/1000M self-adaptation, this is a standard RJ45 Ethernet port

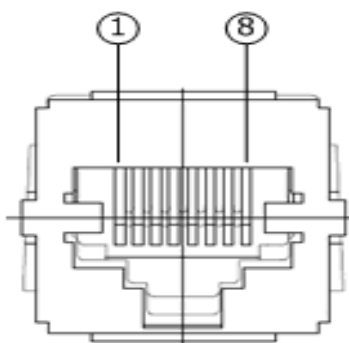

Pin	Description	Remarks
1	L_MDI_OP	IO
2	L_MDI_ON	IO
3	L_MDI_1P	IO
4	L_MDI_1N	IO
7	L_MDI_2P	IO
8	L_MDI_2N	IO
9	L_MDI_3P	IO
10	L_MDI_3N	IO

3.5.4 D Sub-9 RS232 Connector

Standard vertical DB-9 male connector ,The bit rate 460K

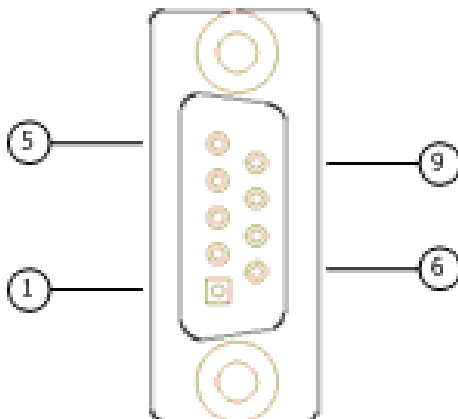

Pin	Description	Remarks
1	DCD1/422TX+/485_A	BIOS set
2	RXD1/422TX-/485_B	BIOS set
3	TXD1/422RX+	BIOS set
4	DTR1/422RX-	BIOS set
5	DGND (ground pin)	
6	DSR1	
7	RTS1	
8	CTS1	
9	RI1	

3.5.5 RS232/485,CAN,External IO Connector

12pins 3.81 pitch terminal with screw lock

Load capacity: more than 128 nodes/RS485 channel -- bit rate: 115200

CAN: The bit rate can be programmed to a maximum of 1Mbit/s



Pin	Description	Remarks
1	TXD2/485_2_A	BIOS set
2	RXD2/485_2_B	BIOS set
3	DGND	
4	CANH	
5	CANL	
6	DGND	
7	EXTIO0	3.3V Level
8	EXTIO1	3.3V Level
9	EXTIO2	3.3V Level
10	EXTIO3	3.3V Level
11	EXTIO4	3.3V Level
12	EXTIO5	3.3V Level

3.5.6 VGA Interface

Standard vertical DB-15 Female VGA connector
bit rate: 460K

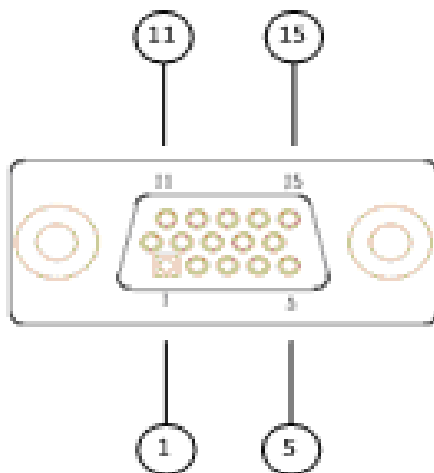

Pin	Description
1	RED
2	GREEN
3	BLUE
4	N.C.
5	GND
6	GND
7	GND
8	GND
9	+5VDC
10	GND
11	N.C.
12	SD_DDC
13	HSYNC
14	VHYNC
15	SC_DDC

3.5.7 USB Host Connector

Dual vertical USB A type interface, USB2.0

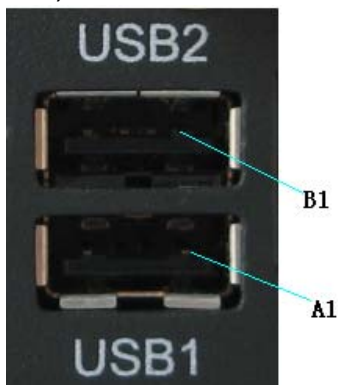

Pin	Description
A1	USB1_VCC(+5VDC)
A2	USB1_D-
A3	USB1_D+
A4	USB1_DGND(ground pin)
B1	USB2_VCC(+5VDC)
B2	USB2_D-
B3	USB2_D+
B4	USB2_DGND(ground pin)

3.5.8 LED



PWR LED: light system power OK(main power up);off system power turn off
 Status LED:Blink SATA HDD active.

3.6 Operation Notice

3.6.1 Change SIM Card

Push the small button on the left of SIM Card Holder, and install the SIM card to the holder. Then push the holder into the Slot.

4 Tips



Waste Disposal

It is recommended to disassemble the device before abandoning it in conformity with local regulations. Please ensure that the abandoned batteries are disposed according to local regulations on waste disposal. Do not throw batteries into fire (explosive) or put in common waste canister. Products or product packages with the sign of “explosive” should not be disposed like household waste but delivered to specialized electrical & electronic waste recycling/disposal center. Proper disposal of this sort of waste helps avoiding harm and adverse effect upon surroundings and people’s health. Please contact local organizations or recycling/disposal center for more recycling/disposal methods of related products.

Comply with the following safety tips:



Do not use in combustible and explosive environment

Keep away from combustible and explosive environment for fear of danger.

Keep away from all energized circuits.

Operators should not remove enclosure from the device. Only the group or person with factory certification is permitted to open the enclosure to adjust and replace the structure and components of the device. Do not change components unless the power cord is removed. In some cases, the device may still have residual voltage even if the power cord is removed. Therefore, it is a must to remove and fully discharge the device before contact so as to avoid injury.



Unauthorized changes to this product or its components are prohibited.

In the aim of avoiding accidents as far as possible, it is not allowed to replace the system or change components unless with permission and certification. Please contact the technical department of Vantron or local branches for help.



Pay attention to caution signs.

Caution signs in this manual remind of possible danger. Please comply with relevant safety tips below each sign. Meanwhile, you should strictly conform to all safety tips for operation environment.



Notice

Considering that reasonable efforts have been made to assure accuracy of this manual, Vantron assumes no responsibility of possible missing contents and information, errors in contents, citations, examples, and source programs. Vantron reserves the right to make necessary changes to this manual without prior notice. No part of this manual may be reprinted or publicly released in for

 **FCC Warning:**

This device complies with FCC class B Rules. Operation is subject to the following conditions.

- (1) This device may not cause harmful interference.
- (2) This device must accept any interference received, including interference that may cause undesired operation.

Note: This equipment has been tested and found to comply with the limits for a Class B digital device, pursuant to part 15 of the FCC Rules. These limits are designed to provide reasonable protection against harmful interference in a residential installation. This equipment generates, uses and can radiate radio frequency energy and, if not installed and used in accordance with the instructions, may cause harmful interference to radio communications. However, there is no guarantee that interference will not occur in a particular installation. If this equipment does cause harmful interference to radio or television reception, which can be determined by turning the equipment off and on, the user is encouraged to try to correct the interference by one or more of the following measures:

- Reorient or relocate the receiving antenna.
- Consult the dealer or an experienced radio/TV technician for help.

Modifications not authorized by the manufacturer may void users authority to operate this device. (In the aim of avoiding accidents as far as possible, it is not allowed to replace the system or change components unless with permission and certification. Please contact the technical department of Vantron or local branches for help.)

**RF exposure warning**

This equipment must be installed and operated in accordance with provide instructions and the antenna used for this transmitter must be installed to provide a separation distance of at least 20 cm from all persons and must not be co-located or operation in conjunction with any other antenna or transmitter. End-users and installers must be provide with antenna installation instructions and transmitter operating conditions for satisfying RF exposure compliance.

Part II: Software Reference

1 Introduction

Thank you for choosing Vantron. It is our commitment to provide our valued customers with the embedded devices equipped with the state of the art technology and the best product services.

Vantron's M2M products are based on the most advanced ARM and Intel Atom processors and have low power consumption and high integration. The products are designed for applications of M2M in industrials, medicals, financial, retail, vehicle, and transportations etc.

1.1 About This Manual

This manual is for user how to use sample programs in Linux system and how to use device in Linux system.

1.2 Linux OS Support

The TV-M2M-TC VM supports the following Linux operating systems.

- Ubuntu 12.04.2 LTS

The Ubuntu 12.04.2 LTS default normal user is **vantron**, password is **vantron**.

1.3 Sample Programs

Vantron supports many sample programs for TV-M2M-TV VM. You can test device modules through these sample programs, and can be the reference that you develop.

- client CAN data send program
- loopback CAN data receive program
- gpiocli GPIO test program
- power Power control for modules in the set
- serialedemo Serial testing and send AT Command program
- gps Get the gps information

- mcupower Power control configure
- mcupowerui Power control configure UI
- adxl Digital Accelerometer
- pnl Pnl7 control
- hostapdup Host AP up
- hostapdoff Host AP off

1.4 Functionalities layout

The below table lists VT-M2M-TC VM features.

Chips or Interfaces	Details
UART	VT-M2M-TC has 4 UART ports: /dev/ttyS0 :RS232 DB9 COM Port /dev/ttyS1 : Green Terminal Pin 1,2 /dev/ttyS2 :GPS /dev/ttyS3 : Pnl7 button control
USB Host portx2	
1xEthernet	\$sudo ifconfig eth0 192.168.16.143
Audio MIC IN	ALSA audio device \$ arecord -t wav test.wav
Audio Out	ALSA audio device \$aplay test.wav
Video player	\$mplayer /programs/tmp/1.mp4
Green Terminal	1 :TXD2 2 :RXD2 3 :GND 4 :CANH 5 :CANL 6 :GND 7 :EXTIO0 8 :EXTIO1 9 :EXTIO2 10 :EXTIO3 11 :EXTIO4 1.1 EXTIO5

2 Base Control

Open the terminal (CTRL+ALT+T), then get into the demo directory.

The directory patch is **/programs/demo**.

ex:

```
$cd /programs/demo
```

2.1 Power Control

power can|gps|3g] [on|off]

can: Power control of CAN Module

gps: Power control of GPS Module

3g: Power control of 3G Module

ex1: Turn on power of can module

```
$sudo ./power can on
```

ex2: Turn off power of can module

```
$sudo ./power can off
```

2.2 Can Control

a. Close can device

```
$sudo ifconfig can0 down
```

b. Configure can, set can's baud rate to 1Mbps, or 100000(100kbps)

```
$sudo ip link set can0 type can bitrate 100000
```

```
$sudo ifconfig can0 up
```

c. Receive can data, it will receive can data which from other side

```
$sudo ./loopback
```

d. Send can data, it will send can package with ID of 0x02

```
$sudo ./client
```

2.3 GPIO Control

gpioctl <dirin|dirout|get|set|clear> <gpionum>

dirin: Set specified GPIO as input type

dirout: Set specified GPIO as output

get: Read GPIO input level. Need set the GPIO as input first.

set: Set GPIO as high level. Need set the GPIO as output first.

clear: Clear GPIO to low level, need set the GPIO as output first.

gpionum: The GPIO be operated. 0 to 5 is EXTIO, 10 is back light power

ex1: Set EXTIO2 to high.

```
$sudo ./gpioctl dirout 2
```

```
$sudo ./gpioctl set 2
```

ex2: Read level of EXTIO2.

```
$sudo ./gpioctl dirin 2
```

```
$sudo ./gpioctl get 2
```

ex3: Set EXTIO2 to low.

```
$sudo ./gpioctl dirout 2
```

```
$sudo ./gpioctl clear 2
```

2.4 Serial COM Control

a. RS232 DB9 COM :

Open the CuteCom, this software get from “Ubuntu Software Center”.

```
$sudo cutecom
```

Select Device, Baudrate, Data bits, Stop bits, Parity , Handshake, then press “Open device” button.

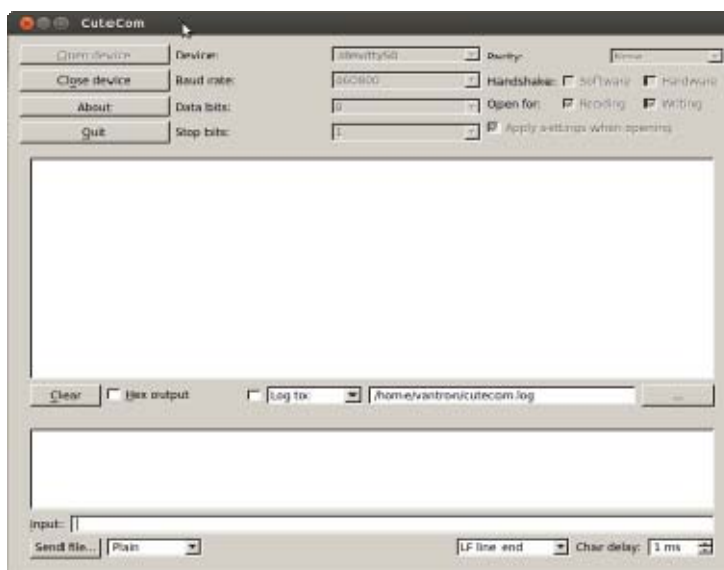

b. COM port on green terminal:

Short Pin 1, 2 of green terminal

```
$sudo ./serialdemo -d /dev/ttyS1 -b 9600 -r -w "hello"
```

Can display some “hello” outputs

2.5 Audio And Video Control

- a. Audio arecord:

```
$sudo arecord -t wav test.wav
```

- b. Audio aplay:

```
$sudo aplay test.wav
```

- c. Video player, the test video in “/programs/tmp “:

```
$sudo mplayer /programs/tmp/1.mp4
```

2.6 SD card Control

- a. Insert SD card ,then look over device:

```
$sudo fdisk -l
```

- b. mount SD card device:

```
$sudo mount /dev/mmcbk0 /mnt
```

2.7 ADXL345 Control

Get Digital Accelerometer:

```
$sudo ./adxl  
X: 233  
Y: 2  
Z: 3ed
```

2.8 Watchdog

- a. Configure watchdog driver:

```
$sudo vim /etc/default/watchdog  
#Start watchdog at boot time? 0 or 1  
run_watchdog=1  
#Load module before starting watchdog  
watchdog_module="sch311x_wdt"  
#Specify additional watchdog options here (see manpage).
```

- b. Configure watchdog:

```
$sudo vim /etc/watchdog.conf
```

c. Start watchdog or reboot system:

```
$sudo watchdog
```

2.9 Pnl7 Control

The communication protocol in the PNL CD/DVD

740P56-5KxxxxxxVT_PNL7_xxx/SW/CommunicationProtocol MCU with PC V1.x.pdf.

Control pnl7 and get button event from pnl7.

```
$sudo ./pnl
1.Get pnl version    2. Get pnl back light value
.....
.....
25. Exit
Input Select:
```

2.10 MCU Power Control

The communication protocol in this CD/DVD

SW/doc/vm-smbus-protocol_xx.pdf.

a. Get the MCU power value (D-Dec H-Hex):

```
$sudo ./mcpower get 1
MCU on delay:(Dec)5 (Hex)5
```

b. Set the MCU power value , set value is Dec:

```
$sudo ./mcpower set 1 200
MCU on delay OK
```

c. Set and get MCU power value form UI:

```
$sudo ./mcpowerui
```

First, press “read” button to get the MCU power value.

Second, set the MCU power value, then press “write” button.

The value range need refer to the communication protocol.

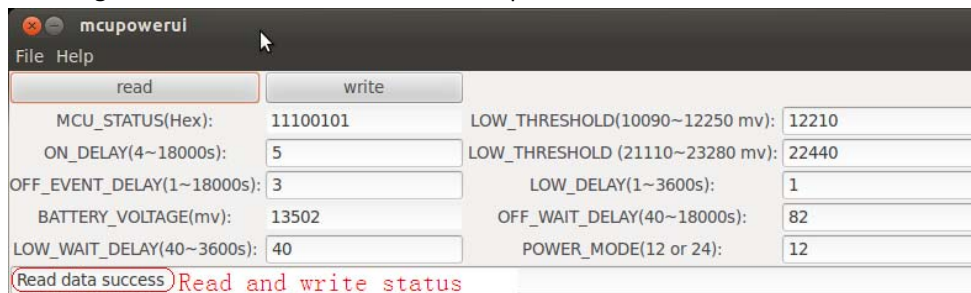

d. Example of the method of changing the low DC input voltage detection value:

1. Use power supply equal or more than 12V output.
2. **"Read"** all values
3. Change this value to **10.8V**, to settle long cable with voltage drop issue.
4. **"Write"** settings to save the ACC power management parameter.

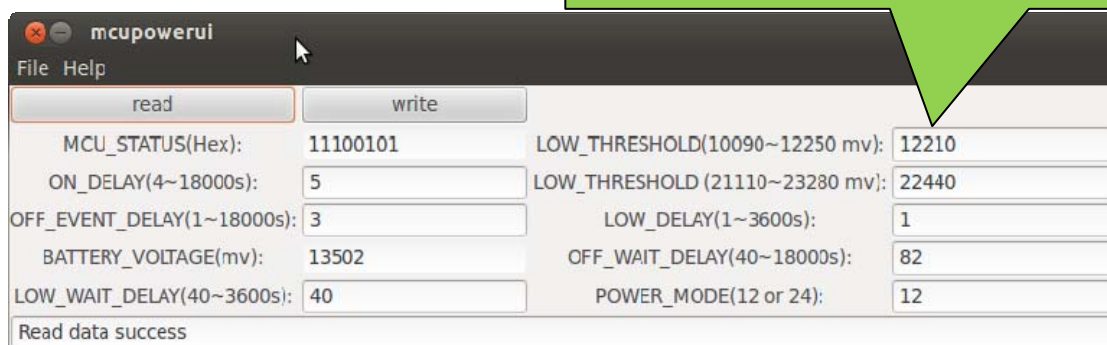

2.11 Touch Screen

- a. Start "penMount Utility" following diagram:



- b. Then calibrate and set touch screen:

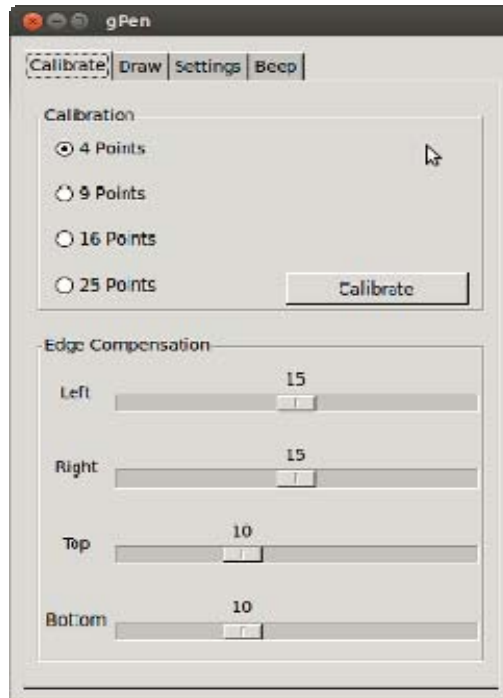

2.12 Host AP

First of all, disconnect all network.

- a. Open the WIFIAP software:

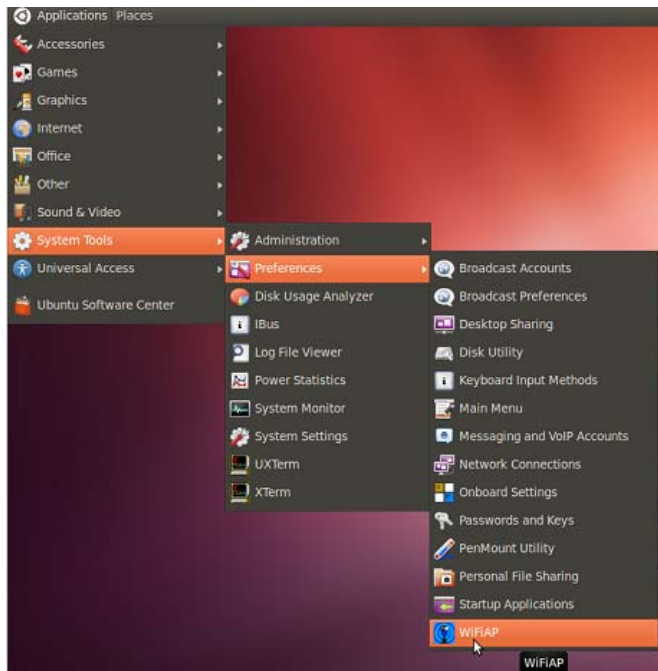

b. Input the pass word and you will into the following interface:

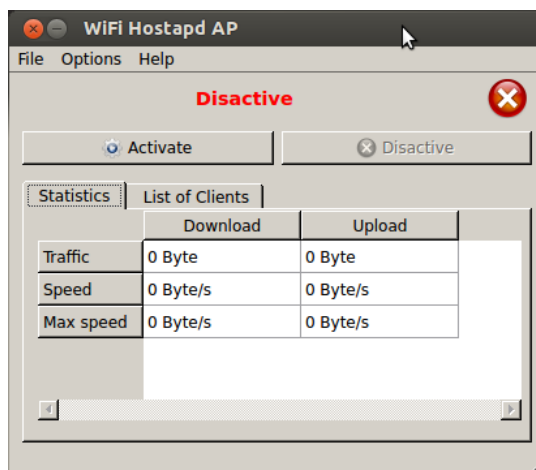

c. Open Options->Settings, set the host AP and DNSMASQ:

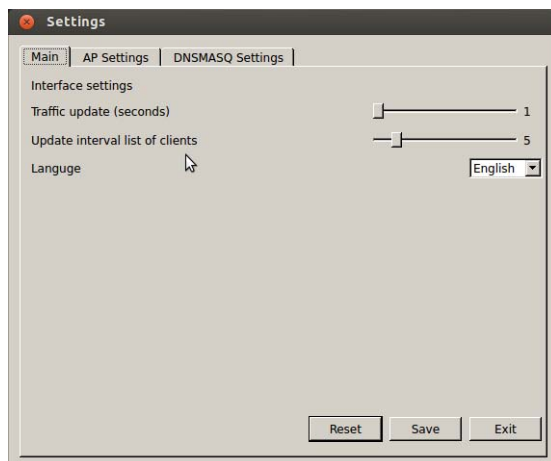

Note: When you changed the setting, you need click "Save".

d. Connect Ethernet (eth0) or cell (ppp0), then activate the host AP:

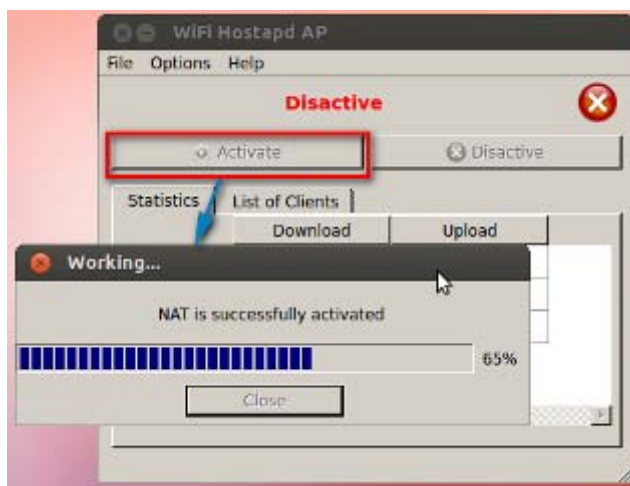

e. The active host AP:

When activate the host AP, you can scan and connect the hot port, and access to the other network which you configure.

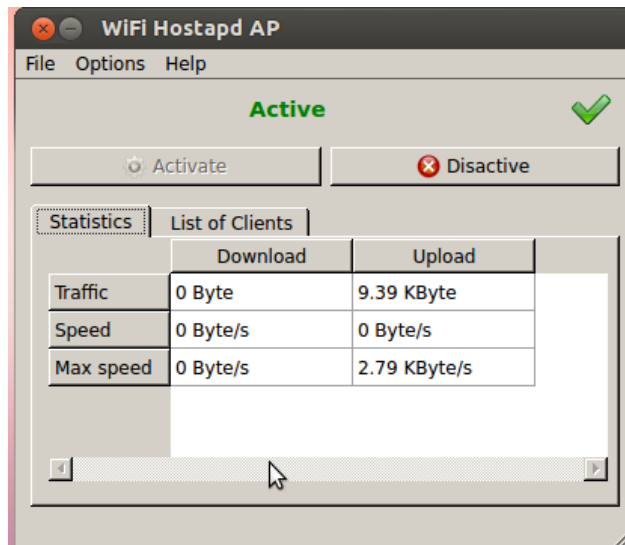

f. Close the activation state:

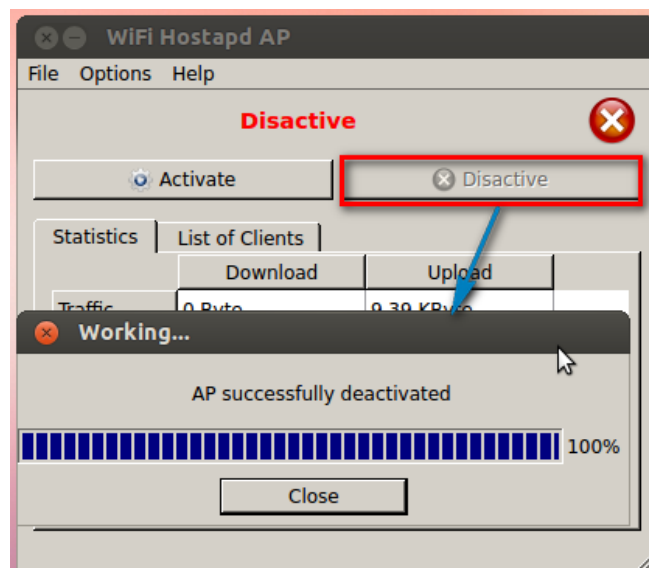

2.13 OnBorad

a. Open onboard

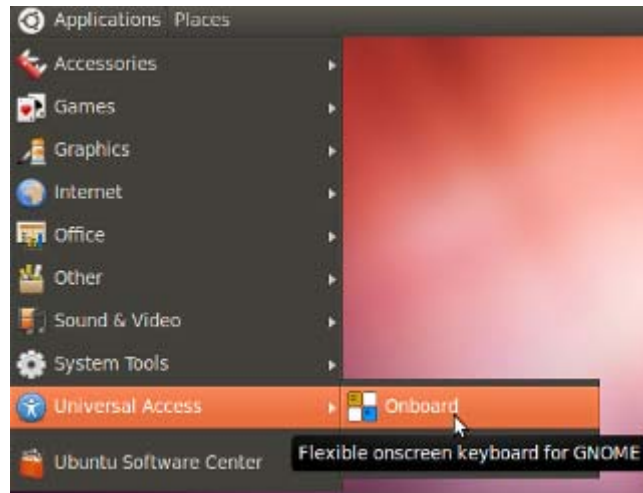

b. Preferences or Quit

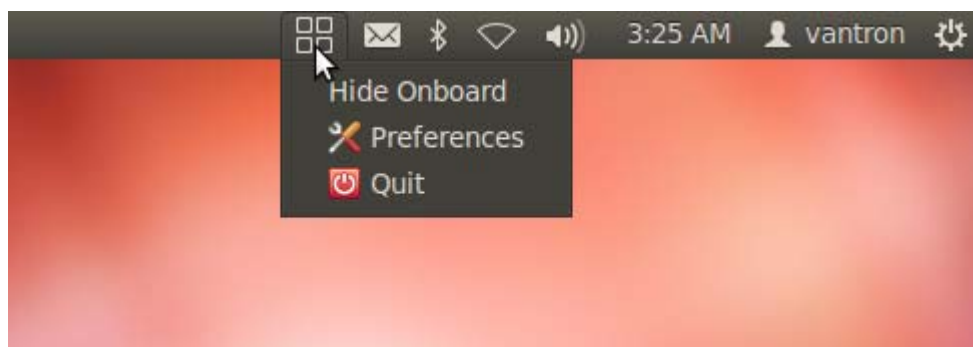

3 Network Module

The network be managed by the network connections, can use network connections tool from system tools.

3.1 WIFI Control

- a. Connect the WIFI hotspot:



3.2 3G Control

Note: When you disconnected the 3G or connected error, you must restart the device:

```
$sudo power 3g off
$sudo power 3g on
```

- a. Open network connections.



- b. Select mobile Broadband and press "add" button to add device:

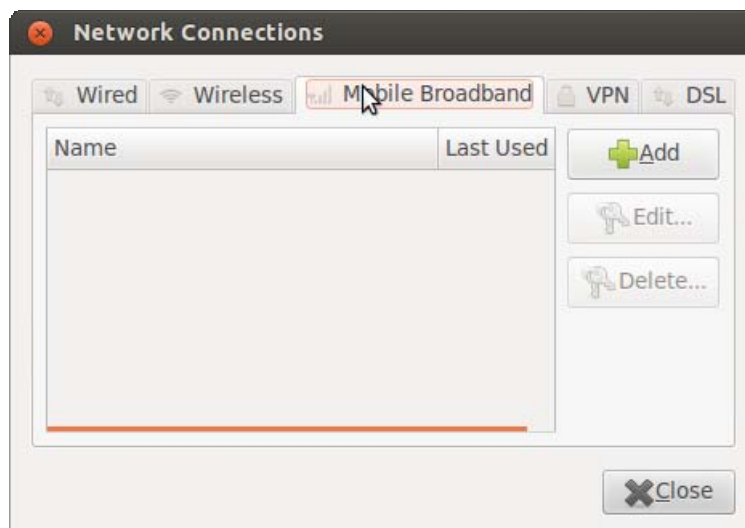

c. Select the telit wireless device.

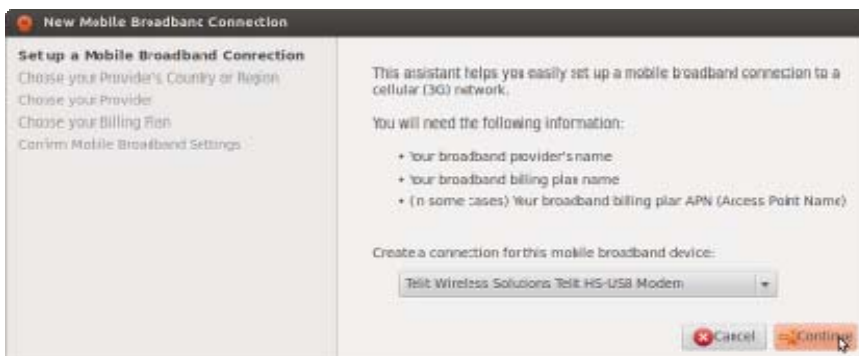

d. Select country, we are in China, so we select China.



e. Select provider from list:

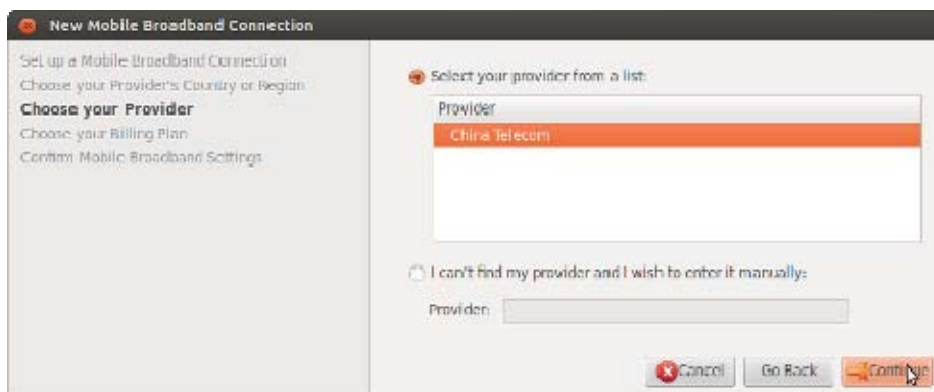

f. Apply the config:



g. Set phone number , user and password:

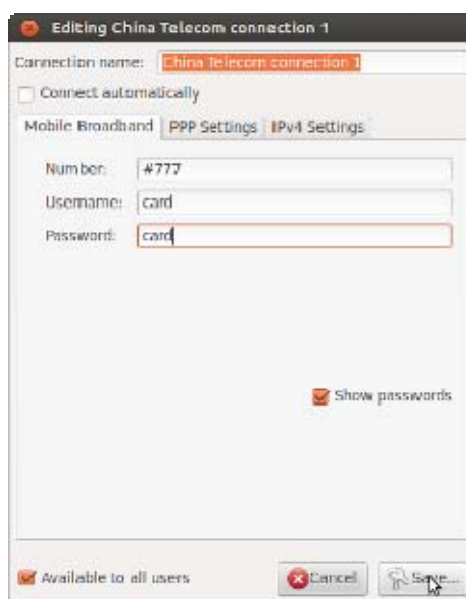

h. Connect the internet:



3.3 Bluetooth Control

Bluetooth is a wireless protocol that allows you to connect many different types of devices to your computer. Bluetooth is commonly used for headsets and input devices like mice and keyboards. You can also use Bluetooth to send files between devices, such as from your computer to your cell phone.

Turn Bluetooth on or off

Enable or disable the Bluetooth device on your computer.

Connect your computer to a Bluetooth device

Pair Bluetooth devices.

Remove a connection between Bluetooth devices

Remove a device from the list of Bluetooth devices.

Send a file to a Bluetooth device

Share files to Bluetooth devices such as your phone.

What is Bluetooth visibility?

Whether or not other devices can discover your computer.

Detailed contents make reference to a following:

<https://help.ubuntu.com/lts/ubuntu-help/bluetooth.html>

3.3.1 Pair Bluetooth devices

- a. Looking at the top panel of your desktop and if you see a small icon that resembles the standard Bluetooth logo near the clock (to the right edge of the top panel) as shown below.

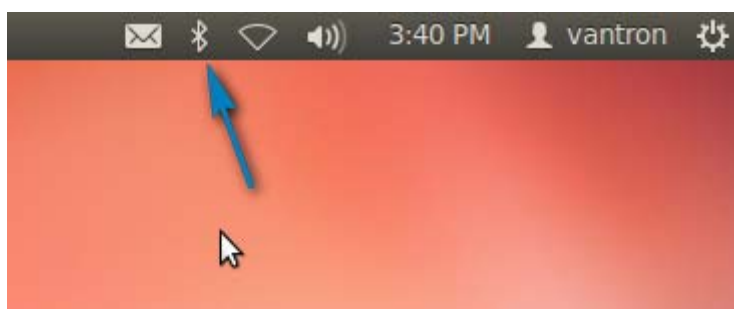

- b. Make sure you've enabled Bluetooth on your device. If it's a mobile phone, then you'll have to manually enable it and also make sure it's 'visible' (discover mode) to other devices.

- c. Then locate that small Bluetooth icon on the top panel and click on it. Then from the menu that you get, click on that which says 'Bluetooth Settings...'
- d. This should open the default configuration window and you'll see a button that lets you turn on/off Bluetooth as shown below. Now simply click and drag it to the right-side until it says 'ON' to turn it on.

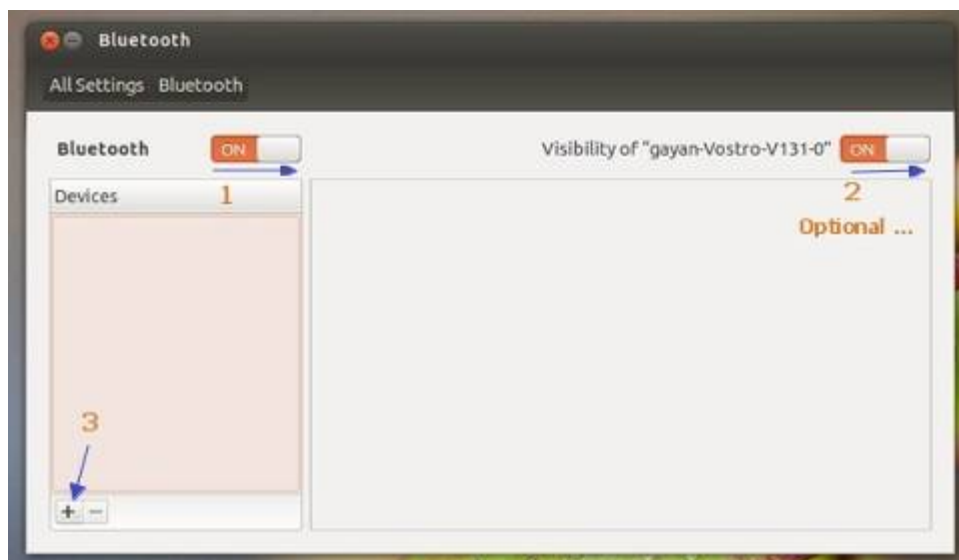

Then click on the '+' sign at the bottom of the 'Bluetooth Settings' window to add the device (shown in the above screenshot).

- e. Click 'Continue' button and then Ubuntu will scan and connect any 'visible' Bluetooth device.



As you can see in below screenshots, it detected Samsung mobile phone and if you have more than one, then they'll be listed, one by one.

- f. Now when you're ready, click on the device that you want a connection to be established and click 'Continue'.



- g. This PIN number is only displayed for a few seconds so you should better hurry up . If it's a phone, then your phone will ask for this PIN code automatically.

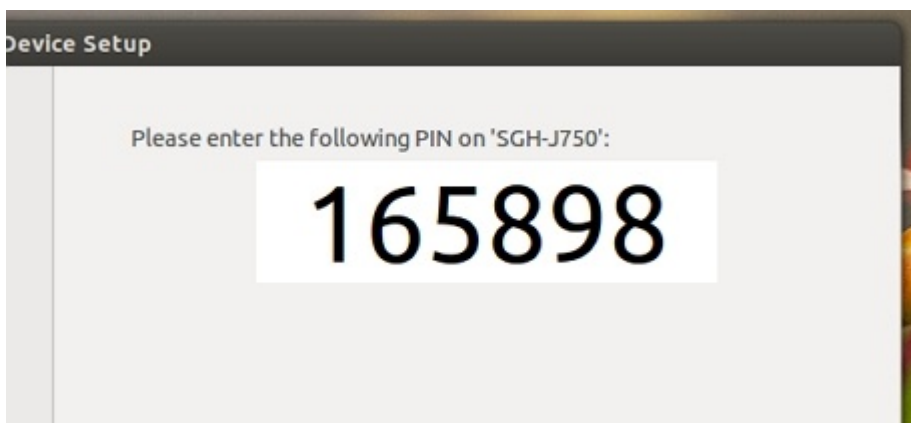

- h. If you successfully entered the PIN number then you should see a message saying that the set up was successful as shown below. If you failed entered the PIN number, you can close the window and restart the Bluetooth setting again.

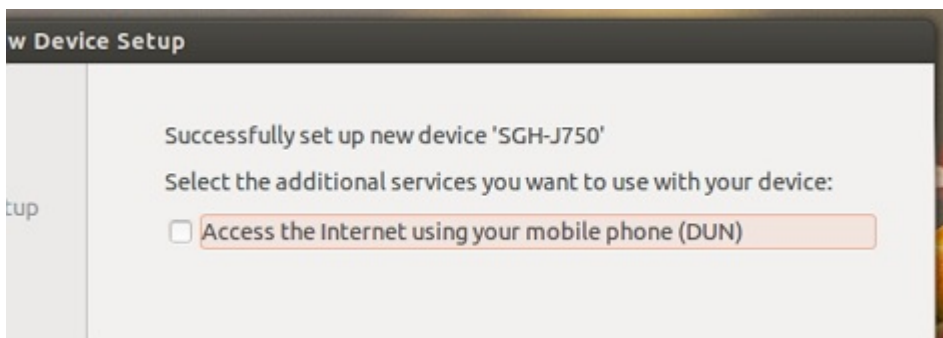

3.3.2 Send File

You can use the Bluetooth device, if you've connected a mobile phone then you can use 'Bluetooth Settings' window.

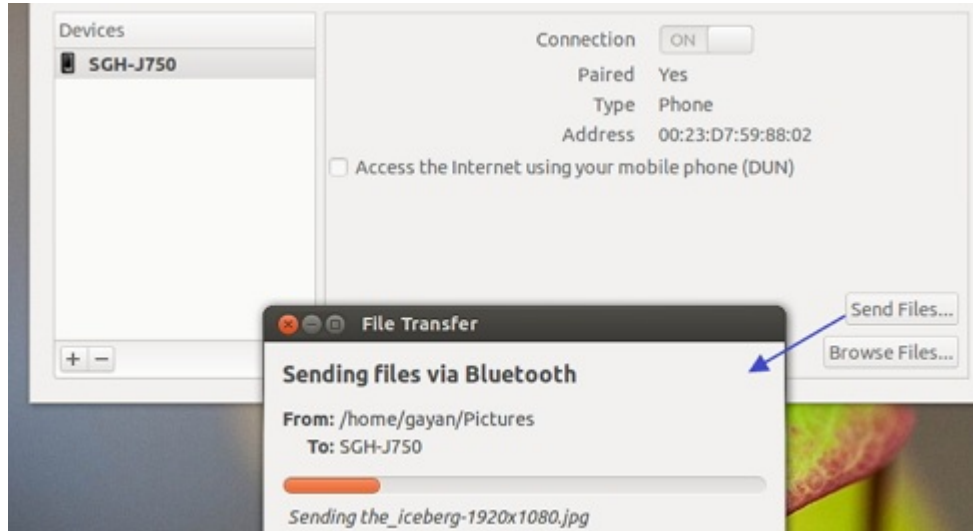

Click on the Bluetooth icon on the top panel for sending or browsing files etc as shown below.

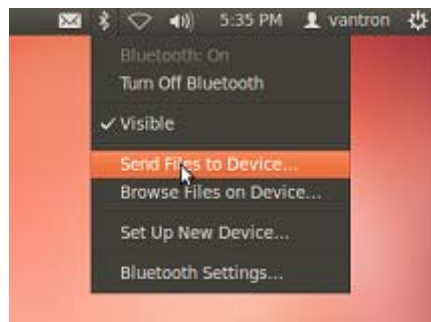

3.3.3 Accept File

- a. First of all, make sure the Bluetooth devices are 'visible', pair the Bluetooth devices.
- b. Open file sharing.



- c. Configure Bluetooth.

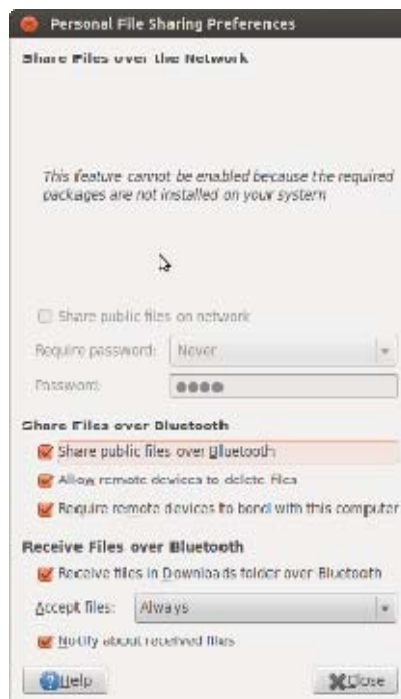

- d. Send file from others Bluetooth device, the file will be saved in **/home/vantron/Download**.

4 GPS Module

4.1 Get GPS Data

Open /dev/ttyS2 , read GPS data

```
$sudo ./gps 38400 /dev/ttyS2
```

4.2 GPS Data Format

4.2.1 GPGGA

Global Positioning System Fix Data

Name	Example Data	Description
Sentence Identifier	\$GPGGA	Global Positioning System Fix Data
Time	170834	17:08:34 Z
Latitude	4124.8963, N	41d 24.8963' N or 41d 24' 54" N
Longitude	08151.6838, W	81d 51.6838' W or 81d 51' 41" W
Fix Quality: - 0 = Invalid - 1 = GPS fix - 2 = DGPS fix	1	Data is from a GPS fix
Number of Satellites	05	5 Satellites are in view
Horizontal Dilution of Precision (HDOP)	1.5	Relative accuracy of horizontal position
Altitude	280.2, M	280.2 meters above mean sea level
Height of geoid above WGS84 ellipsoid	-34.0, M	-34.0 meters
Time since last DGPS update	blank	No last update
DGPS reference station id	blank	No station id
Checksum	*75	Used by program to check for transmission errors

ex: \$GPGGA,hhmmss.ss,llll.ll,a,yyyyy.yy,a,x,xx,x.x,x.x,M,x.x,M,x.x,xxxx

hhmmss.ss = UTC of position

llll.ll = latitude of position

a = N or S
 yyyyy.yy = Longitude of position
 a = E or W
 x = GPS Quality indicator (0=no fix, 1=GPS fix, 2=Dif. GPS fix)
 xx = number of satellites in use
 x.x = horizontal dilution of precision
 x.x = Antenna altitude above mean-sea-level
 M = units of antenna altitude, meters
 x.x = Geoidal separation
 M = units of geoidal separation, meters
 x.x = Age of Differential GPS data (seconds)
 xxxx = Differential reference station ID

4.2.2 GPGSA

GPS DOP and active satellites

ex1: \$GPGSA,A,3,,,,,16,18,,22,24,,,3.6,2.1,2.2*3C
 ex2: \$GPGSA,A,3,19,28,14,18,27,22,31,39,,,,,1.7,1.0,1.3*35
 ex3: \$GPGSA,<1>,<2>,<3>,<4>,,,,,<11>,<12>,<13>,<14>,<15>,<16>,<17> *<18>
 1 = Mode:
 M=Manual, forced to operate in 2D or 3D
 A=Automatic, 3D/2D
 2 = Mode:
 1=Fix not available
 2=2D
 3=3D
 3-14 = IDs of SVs used in position fix (null for unused fields)
 15 = PDOP
 16 = HDOP
 17 = VDOP
 18 = checksum

4.2.3 GPGSV

GPS Satellites in view

ex: \$GPGSV,3,1,11,03,03,111,00,04,15,270,00,06,01,010,00,13,06,292,00*74
 \$GPGSV,3,2,11,14,25,170,00,16,57,208,39,18,67,296,40,19,40,246,00*74
 \$GPGSV,3,3,11,22,42,067,42,24,14,311,43,27,05,244,00,,,,*4D
 \$GPGSV,1,1,13,02,02,213,,03,-3,000,,11,00,121,,14,13,172,05*67

1 = Total number of messages of this type in this cycle

- 2 = Message number
- 3 = Total number of SVs in view
- 4 = SV PRN number
- 5 = Elevation in degrees, 90 maximum
- 6 = Azimuth, degrees from true north, 000 to 359
- 7 = SNR, 00-99 dB (null when not tracking)
- 8-11 = Information about second SV, same as field 4-7
- 12-15 = Information about third SV, same as field 4-7
- 16-19 = Information about fourth SV, same as field 4-7

4.2.4 GPRMC

Recommended minimum specific GPS/Transit data

ex1: \$GPRMC,081836,A,3751.65,S,14507.36,E,000.0,360.0,130998,011.3,E*62

ex2: \$GPRMC,225446,A,4916.45,N,12311.12,W,000.5,054.7,191194,020.3,E*68

225446	Time of fix 22:54:46 UTC
A	Navigation receiver warning A = OK, V = warning
4916.45,N	Latitude 49 deg. 16.45 min North
12311.12,W	Longitude 123 deg. 11.12 min West
000.5	Speed over ground, Knots
054.7	Course Made Good, True
191194	Date of fix 19 November 1994
020.3,E	Magnetic variation 20.3 deg East
*68	mandatory checksum

ex3: \$GPRMC,220516,A,5133.82,N,00042.24,W,173.8,231.8,130694,004.2,W*70

1 2 3 4 5 6 7 8 9 10 11 12

1	220516	Time Stamp
2	A	validity - A-ok, V-invalid
3	5133.82	current Latitude
4	N	North/South
5	00042.24	current Longitude
6	W	East/West
7	173.8	Speed in knots
8	231.8	True course
9	130694	Date Stamp
10	004.2	Variation
11	W	East/West
12	*70	checksum

ex4: \$GPRMC,hhmmss.ss,A,llll.ll,a,yyyyy.yy,a,x.x,x.x,ddmmyy,x.x,a*hh

- 1 = UTC of position fix
- 2 = Data status (V=navigation receiver warning)
- 3 = Latitude of fix
- 4 = N or S
- 5 = Longitude of fix
- 6 = E or W
- 7 = Speed over ground in knots
- 8 = Track made good in degrees True
- 9 = UT date
- 10 = Magnetic variation degrees (Easterly var. subtracts from true course)
- 11 = E or W
- 12 = Checksum

4.2.5 GPVTG

Track Made Good and Ground Speed.

ex1: \$GPVTG,360.0,T,348.7,M,000.0,N,000.0,K*43

ex2: \$GPVTG,054.7,T,034.4,M,005.5,N,010.2,K

054.7,T	True track made good
034.4,M	Magnetic track made good
005.5,N	Ground speed, knots
010.2,K	Ground speed, Kilometers per hour

ex3: \$GPVTG,t,T,,,s.ss,N,s.ss,K*hh

- 1 = Track made good
- 2 = Fixed text 'T' indicates that track made good is relative to true north
- 3 = not used
- 4 = not used
- 5 = Speed over ground in knots
- 6 = Fixed text 'N' indicates that speed over ground in in knots
- 7 = Speed over ground in kilometers/hour
- 8 = Fixed text 'K' indicates that speed over ground is in kilometers/hour
- 9 = Checksum

The actual track made good and speed relative to the ground.

\$GPVTG,x.x,T,x.x,M,x.x,N,x.x,K

x.x,T = Track, degrees True

x.x,M = Track, degrees Magnetic

x.x,N = Speed, knots

x.x,K = Speed, Km/hr

5 Update System

5.1 Make USB boot Stick and Copy Image to USB stick

Create PC condition:

Create a bootable USB stick on Windows XP/ Win7, the first thing you need to do is insert a USB stick with at least 2GB of free space into your PC.

Here use an USB installer tool to write the image ISO to USB stick. Please copy the file **SW/tools/Universal-USB-Installer-1.9.3.5.exe** to your PC anywhere.

USB stick making steps in detail as follows:

- a. Copy **SW/image/xxx.iso** image into your PC.
- b. Select the "Try Unlisted Linux ISO" from the dropdown list.

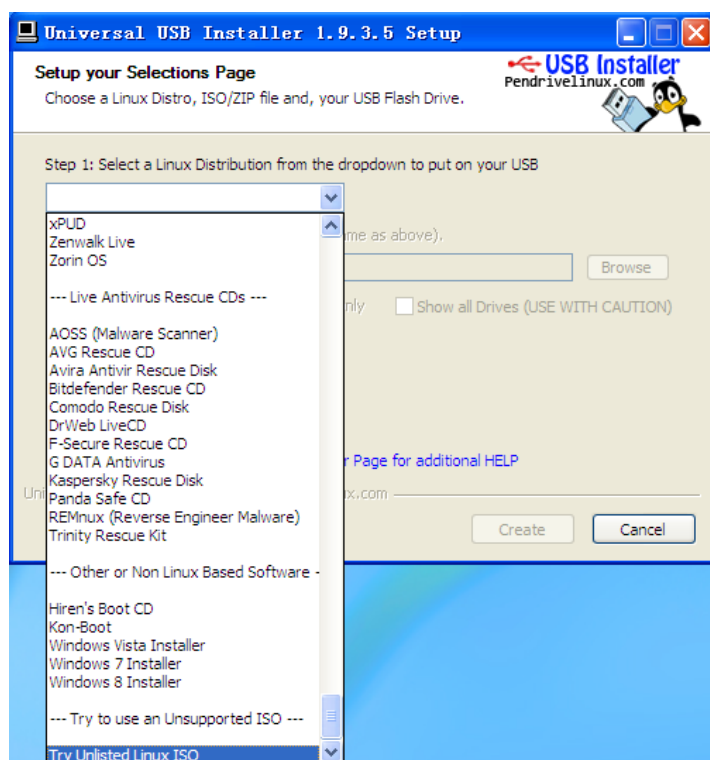

- c. Click '**Browse**' and select the image ISO file.

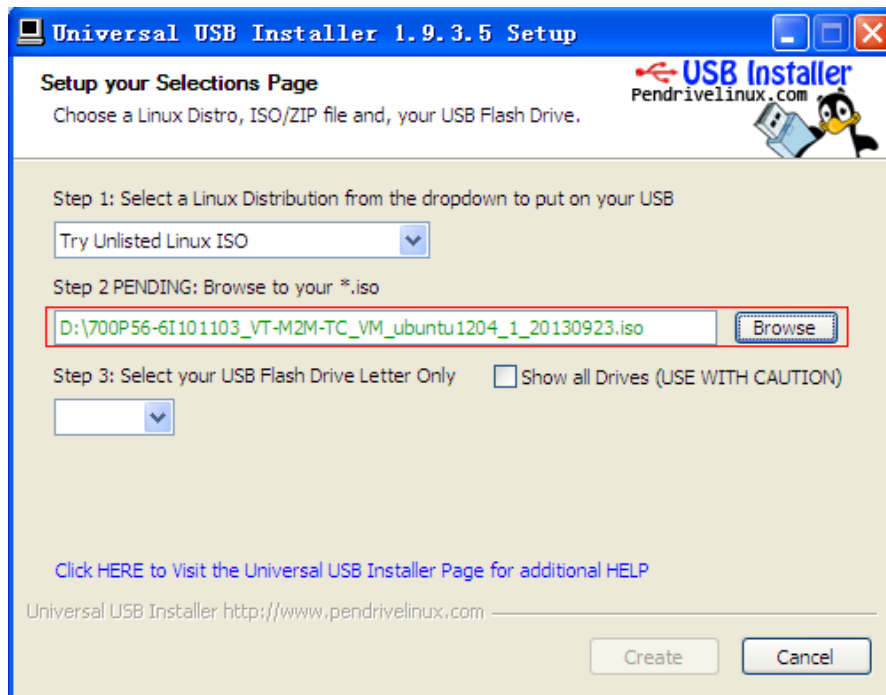

d. Choose the USB drive and click '**Create**'.

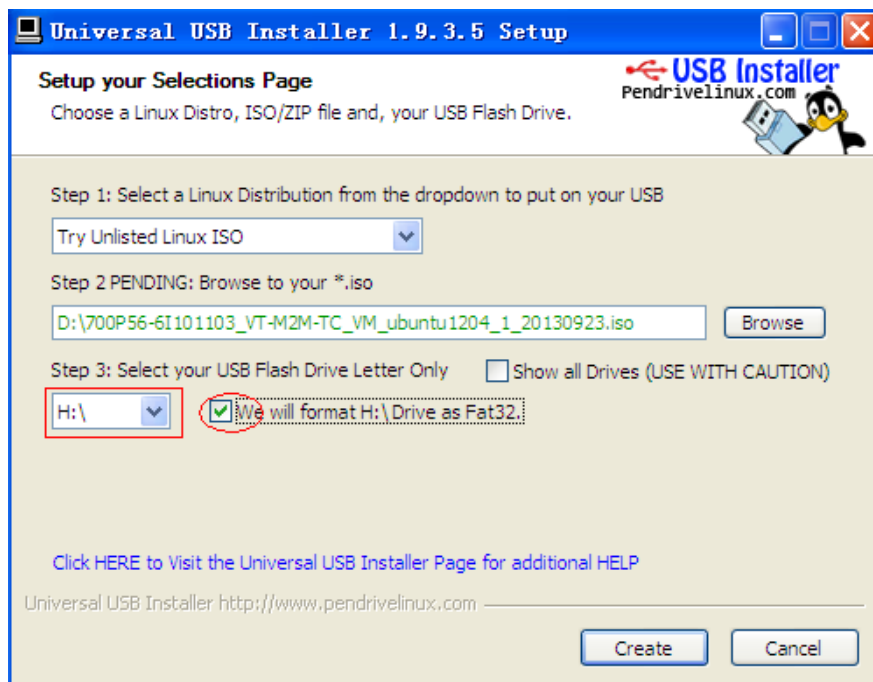

5.2 Update steps

- a. When the bootable USB stick create over, insert the USB stick into VT-M2M-TC. And connect a USB keyboard on the M2M-TC.
- b. Power ON the VT-M2M-TC, and step into BIOS by press the “Delete” key on the keyboard.

In the BIOS, set the first boot option for boot up by USB stick. The user guidance of the BIOS is in the package of **HW/ 700N16-6Bxxxxxx_VT-M2M-TC_VM_xxx.zip**.



- c. Select the first option “clonezilla live with img 700Pxxxxxx”.

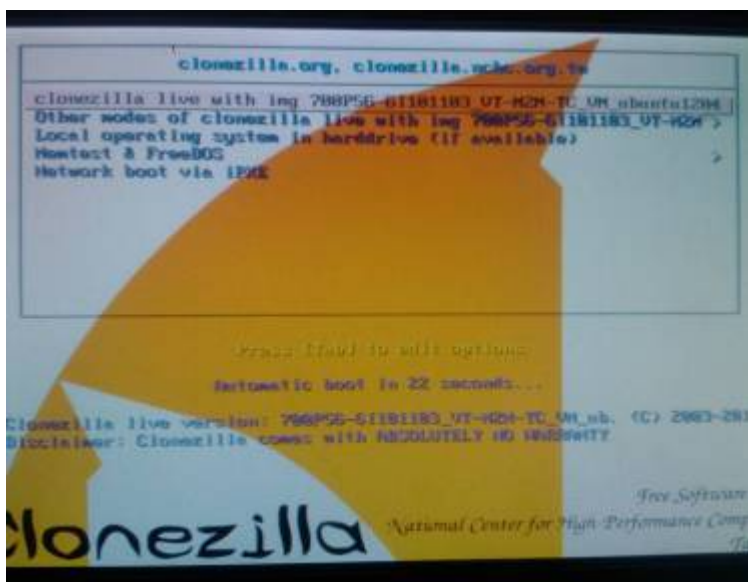

- d. When ask “Are you sure want to continue??” or “Let me ask you again, Are you sure you want to continue??” , please input ‘y’ all.

```

WARNING!!! WARNING!!! WARNING!!!
WARNING! THE EXISTING DATA IN THIS HAR
BE LOST:
*****
Machine: Tunnel Creek VT-M2M-TC VM
sda (8012MB_InnoLite_SATA_S1_ata-InnoL
sda1 (3670MB_ext4(In_InnoLite_SATA_S1)
sda2 (315MB_ext4(In_InnoLite_SATA_S1)
*****
Are you sure you want to continue? ?
[y/n] y_
    
```

- e. The system is updating.

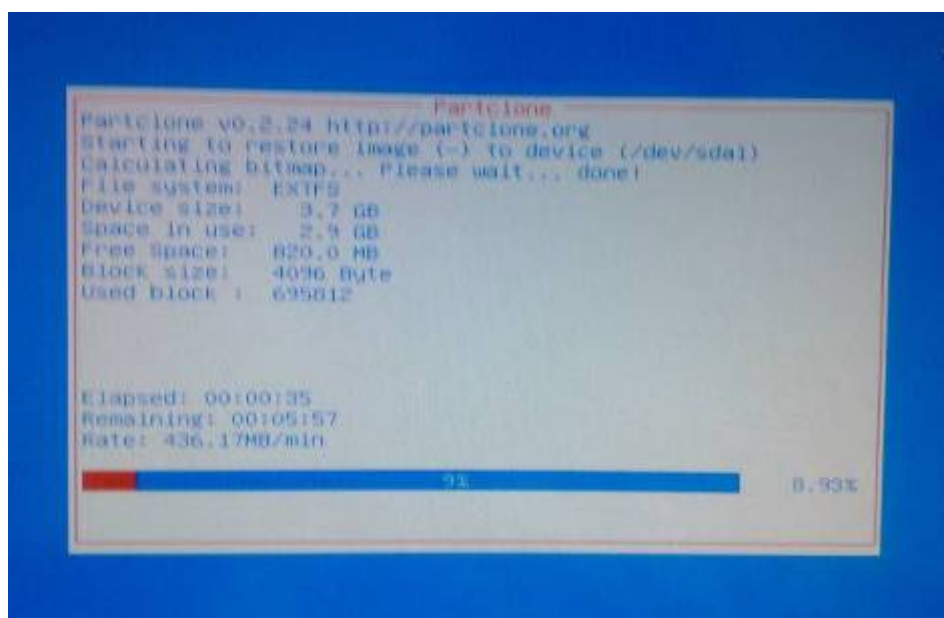

- f. When update over, the system will power off.

Re-power VT-M2M-TC, and step into the BIOS, and restore the first boot option to hard disk.

Vantron

US Office: Vantron Technology, Inc.

Address: 1292 Kifer Road #807,
Sunnyvale, CA 94086

Tel: 510-304-7666

Email: sales@vantrontech.com

China Office: Chengdu Vantron Technology, Ltd.

Address: 3rd floor, 3rd building, No.9, 3rd WuKe East Street, WuHou District,
Chengdu, P.R. China 610045

Tel: 86-28-8512-3930/3931, 8515-7572/6320

Email: sales@vantrontech.com.cn