



中认信通
CHINA CERTIFICATION ICT CO., LTD (DONGGUAN)



TEST REPORT

Applicant: Chengdu Vantron Technology Co., Ltd.

Address: No.5 GaoPeng Road, Hi-Tech Zone, Chengdu, SiChuan, P.R. China

FCC ID: 2AAGEVTC335L

IC: 11152A-VTC335L

HVIN: VT-M2M-C335L

Product Name: M2M Gateway

Model Number: VT-M2M-C335L

Standard(s): 47 CFR Part 15, Subpart E(15.407)

RSS-247 Issue 2, February 2017

RSS-Gen, Issue 5, February 2021 Amendment 2

ANSI C63.10-2013

KDB 789033 D02 General U-NII Test Procedures New Rules v02r01

The above equipment has been tested and found compliant with the requirement of the relative standards by China Certification ICT Co., Ltd (Dongguan)

Report Number: CR22070077-00C

Date Of Issue: 2022-11-05

Reviewed By: Sun Zhong

Sun Zhong

Title: Manager

Test Laboratory: China Certification ICT Co., Ltd (Dongguan)

No. 113, Pingkang Road, Dalang Town, Dongguan,

Guangdong, China

Tel: +86-769-82016888

Test Facility

The Test site used by China Certification ICT Co., Ltd (Dongguan) to collect test data is located on the No. 113, Pingkang Road, Dalang Town, Dongguan, Guangdong, China.

The lab has been recognized as the FCC accredited lab under the KDB 974614 D01 and is listed in the FCC Public Access Link (PAL) database, FCC Registration No. : 442868, the FCC Designation No. : CN1314.

The lab has been recognized by Innovation, Science and Economic Development Canada to test to Canadian radio equipment requirements, the CAB identifier: CN0123.

Declarations

China Certification ICT Co., Ltd (Dongguan) is not responsible for the authenticity of any test data provided by the applicant. Data included from the applicant that may affect test results are marked with a triangle symbol “▲”. Customer model name, addresses, names, trademarks etc. are not considered data.

Unless otherwise stated the results shown in this test report refer only to the sample(s) tested.

This report cannot be reproduced except in full, without prior written approval of the Company.

This report is valid only with a valid digital signature. The digital signature may be available only under the Adobe software above version 7.0.

This report may contain data that are not covered by the accreditation scope and shall be marked with an asterisk “★”.

CONTENTS

TEST FACILITY	2
DECLARATIONS.....	2
1. GENERAL INFORMATION	5
1.1 PRODUCT DESCRIPTION FOR EQUIPMENT UNDER TEST (EUT)	5
1.2 DESCRIPTION OF TEST CONFIGURATION.....	8
1.2.2 Support Equipment List and Details	8
1.2.3 Support Cable List and Details	8
1.2.4 Block Diagram of Test Setup.....	9
1.3 MEASUREMENT UNCERTAINTY	10
2. SUMMARY OF TEST RESULTS	11
3. REQUIREMENTS AND TEST PROCEDURES	12
3.1 AC LINE CONDUCTED EMISSIONS.....	12
3.1.1 Applicable Standard.....	12
3.1.2 EUT Setup.....	13
3.1.3 EMI Test Receiver Setup	13
3.1.4 Test Procedure	14
3.1.5 Corrected Amplitude & Margin Calculation.....	14
3.2 RADIATION SPURIOUS EMISSIONS	15
3.2.1 Applicable Standard.....	15
3.2.2 EUT Setup.....	16
3.2.3 EMI Test Receiver & Spectrum Analyzer Setup	18
3.2.4 Test Procedure	18
3.2.5 Corrected Amplitude & Margin Calculation.....	18
3.3 26DB ATTENUATED BELOW THE CHANNEL POWER:	19
3.3.1 Applicable Standard.....	19
3.3.2 EUT Setup.....	19
3.3.3 Test Procedure	19
3.4 EMISSION BANDWIDTH:	20
3.4.1 Applicable Standard.....	20
3.4.2 EUT Setup.....	20
3.4.3 Test Procedure	20
3.5 MAXIMUM CONDUCTED OUTPUT POWER:.....	22
3.5.1 Applicable Standard.....	22
3.5.2 EUT Setup.....	22
3.5.3 Test Procedure	23
3.6 MAXIMUM POWER SPECTRAL DENSITY:	23
3.6.1 Applicable Standard.....	23
3.6.2 EUT Setup.....	24
3.6.3 Test Procedure	24
3.7 DUTY CYCLE:.....	25
3.7.1 EUT Setup.....	25

3.7.2 Test Procedure25

3.8 ANTENNA REQUIREMENT.....26

3.8.1 Applicable Standard.....26

3.8.2 Judgment.....26

3.9 ADDITIONAL REQUIREMENT27

3.9.1 Applicable Standard.....27

3.9.2 Judgment.....28

4. Test DATA AND RESULTS 29

4.1 AC LINE CONDUCTED EMISSIONS.....29

4.2 RADIATION SPURIOUS EMISSIONS32

4.3 26dB ATTENUATED BELOW THE CHANNEL POWER:44

4.4 EMISSION BANDWIDTH:49

4.5 MAXIMUM CONDUCTED OUTPUT POWER:63

4.6 MAXIMUM POWER SPECTRAL DENSITY:65

4.7 DUTY CYCLE:73

1. GENERAL INFORMATION

1.1 Product Description for Equipment under Test (EUT)

EUT Name:	M2M Gateway
EUT Model:	VT-M2M-C335L
Operation Frequency:	5180-5240 MHz (802.11a/n ht20/ac vht20) 5190-5230 MHz(802.11n ht40/ac vht40) 5210 MHz(802.11ac vht80) 5745-5825 MHz (802.11a/n ht20/ac vht20) 5755-5795 MHz(802.11n ht40/ac vht40) 5775 MHz(802.11ac vht80)
Maximum Average Output Power (Conducted):	11.86 dBm (5150-5250 MHz) 12.56 dBm (5725-5850 MHz)
Modulation Type:	OFDM
Rated Input Voltage:	DC 9-36V
Serial Number:	CR22070077-RF-S1
EUT Received Date:	2022.8.3
EUT Received Status:	Good

1.1.2 Operation Frequency Detail:**For 802.11a/n ht20/ac vht20:**

5150-5250MHz Band		5725-5850MHz Band	
Channel	Frequency (MHz)	Channel	Frequency (MHz)
36	5180	149	5745
40	5200	153	5765
44	5220	157	5785
48	5240	161	5805
/	/	165	5825
Per section 15.31(m)/RSS-Gen, the below frequencies were performed the test as below:			
36	5180	149	5745
40	5200	157	5785
48	5240	165	5825

For 802.11n ht40/ac vht40:

5150-5250MHz Band		5725-5850MHz Band	
Channel	Frequency (MHz)	Channel	Frequency (MHz)
38	5190	151	5755
46	5230	159	5795
Per section 15.31(m)/RSS-Gen, the below frequencies were performed the test as below:			
38	5190	151	5755
46	5230	159	5795

For 802.11ac vht80:

5150-5250MHz Band		5725-5850MHz Band	
Channel	Frequency (MHz)	Channel	Frequency (MHz)
42	5210	155	5775
Per section 15.31(m)/RSS-Gen, the below frequencies were performed the test as below:			
42	5210	155	5775

1.1.3 Antenna Information Detail ▲ :

For Bluetooth/WiFi Antenna:

Antenna Type	input impedance (Ohm)	Antenna Gain /Frequency Range	§15.203& RSS-Gen Requirement
Monopole	50	3.12dBi/5.15-5.25GHz 4.03dBi/5.7-5.85GHz	Compliance

The Method of §15.203 Compliance:

- Antenna must be permanently attached to the unit.
 Antenna must use a unique type of connector to attach to the EUT.
 Unit must be professionally installed, and installer shall be responsible for verifying that the correct antenna is employed with the unit.

1.1.4 Accessory Information:

Accessory Description	Manufacturer	Model	Parameters
Adapter	Unknow	SAW12-120-1000UD	Input: 100-240V~50/60Hz 0.3A Output: 12V, 1000mA

1.2 Description of Test Configuration

1.2.1 EUT Operation Condition:

EUT Operation Mode:		The system was configured for testing in Engineering Mode, which was provided by the manufacturer.			
Equipment Modifications:		No			
EUT Exercise Software:		VantronOS-Web			
The software " VantronOS-Web "was provided by manufacturer. The maximum power was configured as below, that was provided by the manufacturer▲:					
Frequency Band	Test Modes	Data Rate	Power Level Setting		
			Lowest Channel	Middle Channel	Highest Channel
5150-5250 MHz	802.11a	6Mbps	-1	-1	-1
	802.11n ht20	MCS0	-1	-1	-1
	802.11n ht40	MCS0	-1	/	-1
	802.11ac vht80	MCS0	/	-1	/
5725-5850 MHz	802.11a	6Mbps	-1	-1	-1
	802.11n ht20	MCS0	-1	-1	-1
	802.11n ht40	MCS0	-1	/	-1
	802.11ac vht80	MCS0	/	-1	/
Note:					
The system support 802.11a/n ht20/n ht40, the vht20/vht40 were reduced since the identical parameters with 802.11n ht20 and ht40.					
The above are the worst-case data rates, which are determined for each mode based upon investigations by measuring the average power and PSD across all data rates, bandwidths, and modulations.					

1.2.2 Support Equipment List and Details

Manufacturer	Description	Model	Serial Number
SanDisk	TF Card	16 GB	1183DRECV11N
Unknown	SIM Card	Unknown	SIM05
Lenovo	Laptop	T460S	60PDTEK8

1.2.3 Support Cable List and Details

Cable Description	Shielding Type	Ferrite Core	Length (m)	From Port	To
RJ45 Cable	Yes	No	2	EUT	Laptop
Cable*3	No	No	2	EUT	Laptop

1.2.4 Block Diagram of Test Setup

AC line conducted emissions:

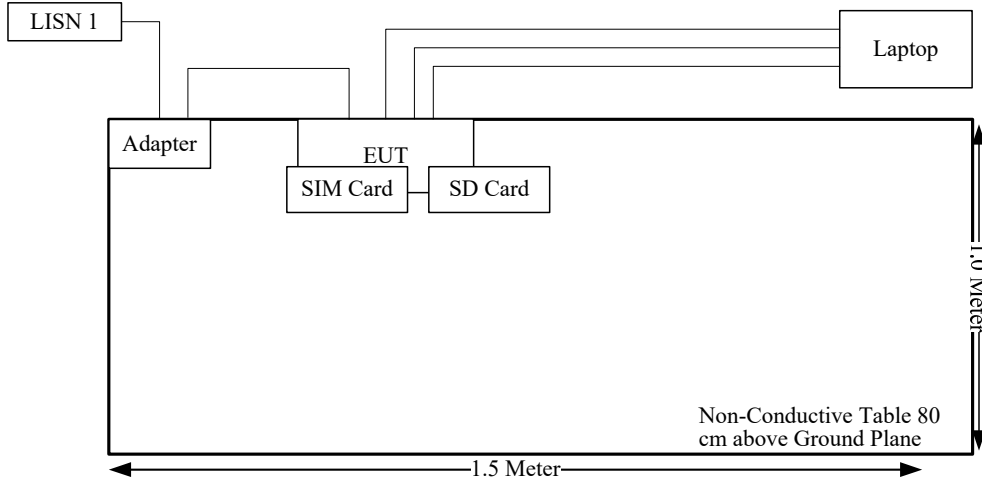

Spurious Emissions:

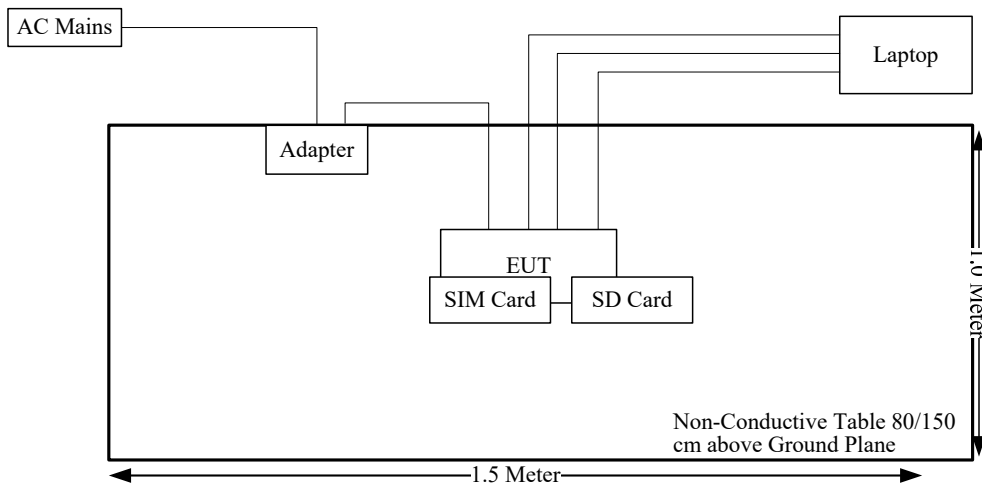

1.3 Measurement Uncertainty

Otherwise required by the applicant or Product Regulations, Decision Rule in this report did not consider the uncertainty. The extended uncertainty given in this report is obtained by combining the standard uncertainty times the coverage factor K with the 95% confidence interval.

Parameter	Measurement Uncertainty
Occupied Channel Bandwidth	±5 %
RF output power, conducted	±0.61dB
Power Spectral Density, conducted	±0.61 dB
Unwanted Emissions, radiated	30M~200MHz: 4.15 dB,200M~1GHz: 5.61 dB,1G~6GHz: 5.14 dB, 6G~18GHz: 5.93 dB,18G~26.5G:5.47 dB,26.5G~40G:5.63 dB
Unwanted Emissions, conducted	±1.26 dB
Temperature	±1 °C
Humidity	±5%
DC and low frequency voltages	±0.4%
Duty Cycle	1%
AC Power Lines Conducted Emission	2.8 dB (150 kHz to 30 MHz)

2. SUMMARY OF TEST RESULTS

Standard(s) Section	Test Items	Result
§15.207(a) RSS-Gen Clause 8.8	AC line conducted emissions	Compliant
FCC§15.205& §15.209 &§15.407(b) RSS-247 Clause 6.2	Undesirable Emission& Restricted Bands	Compliant
FCC§15.407(a) (e) RSS-247 Clause 6.2 RSS-Gen Clause 6.7	Emission Bandwidth	Compliant
FCC§15.407(a) RSS-247 Clause 6.2	Conducted Transmitter Output Power	Compliant
FCC§15.407 (a) RSS-247 Clause 6.2	Power Spectral Density	Compliant
§15.203 RSS-GEN Clause 6.8	Antenna Requirement	Compliant
RSS-247 Clause 6.4	Additional requirements	Compliant

3. REQUIREMENTS AND TEST PROCEDURES

3.1 AC Line Conducted Emissions

3.1.1 Applicable Standard

FCC§15.207(a).

(a) Except as shown in paragraphs (b) and (c) of this section, for an intentional radiator that is designed to be connected to the public utility (AC) power line, the radio frequency voltage that is conducted back onto the AC power line on any frequency or frequencies, within the band 150 kHz to 30 MHz, shall not exceed the limits in the following table, as measured using a 50 μ H/50 ohms line impedance stabilization network (LISN). Compliance with the provisions of this paragraph shall be based on the measurement of the radio frequency voltage between each power line and ground at the power terminal. The lower limit applies at the boundary between the frequency ranges.

Frequency of emission (MHz)	Conducted limit (dB μ V)	
	Quasi-peak	Average
0.15-0.5	66 to 56*	56 to 46*
0.5-5	56	46
5-30	60	50

*Decreases with the logarithm of the frequency.

(b) The limit shown in paragraph (a) of this section shall not apply to carrier current systems operating as intentional radiators on frequencies below 30 MHz. In lieu thereof, these carrier current systems shall be subject to the following standards:

(1) For carrier current system containing their fundamental emission within the frequency band 535-1705 kHz and intended to be received using a standard AM broadcast receiver: no limit on conducted emissions.

(2) For all other carrier current systems: 1000 μ V within the frequency band 535-1705 kHz, as measured using a 50 μ H/50 ohms LISN.

(3) Carrier current systems operating below 30 MHz are also subject to the radiated emission limits in §15.205, §15.209, §15.221, §15.223, or §15.227, as appropriate.

(c) Measurements to demonstrate compliance with the conducted limits are not required for devices which only employ battery power for operation and which do not operate from the AC power lines or contain provisions for operation while connected to the AC power lines. Devices that include, or make provisions for, the use of battery chargers which permit operating while charging, AC adapters or battery eliminators or that connect to the AC power lines indirectly, obtaining their power through another device which is connected to the AC power lines, shall be tested to demonstrate compliance with the conducted limits.

3.1.2 EUT Setup



- Note: 1. Support units were connected to second LISN.
 2. Both of LISNs (AMN) 80 cm from EUT and at the least 80 cm from other units and other metal planes support units.

The setup of EUT is according with per ANSI C63.10-2013 measurement procedure. The specification used was with the FCC Part 15.207 limits.

The spacing between the peripherals was 10 cm.

The adapter or EUT was connected to the main LISN with a 120 V/60 Hz AC power source.

3.1.3 EMI Test Receiver Setup

The EMI test receiver was set to investigate the spectrum from 150 kHz to 30 MHz.

During the conducted emission test, the EMI test receiver was set with the following configurations:

Frequency Range	IF B/W
150 kHz – 30 MHz	9 kHz

3.1.4 Test Procedure

The frequency and amplitude of the six highest ac power-line conducted emissions relative to the limit, measured over all the current-carrying conductors of the EUT power cords, and the operating frequency or frequency to which the EUT is tuned (if appropriate), should be reported, unless such emissions are more than 20 dB below the limit. AC power-line conducted emissions measurements are to be separately carried out only on each of the phase (“hot”) line(s) and (if used) on the neutral line(s), but not on the ground [protective earth] line(s). If less than six emission frequencies are within 20 dB of the limit, then the noise level of the measuring instrument at representative frequencies should be reported. The specific conductor of the power-line cord for each of the reported emissions should be identified. Measure the six highest emissions with respect to the limit on each current-carrying conductor of each power cord associated with the EUT (but not the power cords of associated or peripheral equipment that are part of the test configuration). Then, report the six highest emissions with respect to the limit from among all the measurements identifying the frequency and specific current-carrying conductor identified with the emission. The six highest emissions should be reported for each of the current-carrying conductors, or the six highest emissions may be reported over all the current-carrying conductors.

3.1.5 Corrected Amplitude & Margin Calculation

The basic equation is as follows:

Result = Reading + Factor

Factor = attenuation caused by cable loss + voltage division factor of AMN

The “**Margin**” column of the following data tables indicates the degree of compliance within the applicable limit. The equation for margin calculation is as follows:

Margin = Limit – Result

3.2 Radiation Spurious Emissions

3.2.1 Applicable Standard

FCC §15.407 (b);

Undesirable emission limits. Except as shown in paragraph (b)(7) of this section, the maximum emissions outside of the frequency bands of operation shall be attenuated in accordance with the following limits:

(1) For transmitters operating in the 5.15-5.25 GHz band: All emissions outside of the 5.15-5.35 GHz band shall not exceed an e.i.r.p. of - 27 dBm/MHz.

(2) For transmitters operating in the 5.25-5.35 GHz band: All emissions outside of the 5.15-5.35 GHz band shall not exceed an e.i.r.p. of - 27 dBm/MHz.

(3) For transmitters operating in the 5.47-5.725 GHz band: All emissions outside of the 5.47-5.725 GHz band shall not exceed an e.i.r.p. of - 27 dBm/MHz.

(4) For transmitters operating solely in the 5.725-5.850 GHz band:

(i) All emissions shall be limited to a level of - 27 dBm/MHz at 75 MHz or more above or below the band edge increasing linearly to 10 dBm/MHz at 25 MHz above or below the band edge, and from 25 MHz above or below the band edge increasing linearly to a level of 15.6 dBm/MHz at 5 MHz above or below the band edge, and from 5 MHz above or below the band edge increasing linearly to a level of 27 dBm/MHz at the band edge.

(ii) Devices certified before March 2, 2017 with antenna gain greater than 10 dBi may demonstrate compliance with the emission limits in § 15.247(d), but manufacturing, marketing and importing of devices certified under this alternative must cease by March 2, 2018. Devices certified before March 2, 2018 with antenna gain of 10 dBi or less may demonstrate compliance with the emission limits in § 15.247(d), but manufacturing, marketing and importing of devices certified under this alternative must cease before March 2, 2020.

(8) The emission measurements shall be performed using a minimum resolution bandwidth of 1 MHz. A lower resolution bandwidth may be employed near the band edge, when necessary, provided the measured energy is integrated to show the total power over 1 MHz.

(9) Unwanted emissions below 1 GHz must comply with the general field strength limits set forth in § 15.209. Further, any U-NII devices using an AC power line are required to comply also with the conducted limits set forth in § 15.207.

(10) The provisions of § 15.205 apply to intentional radiators operating under this section.

(11) When measuring the emission limits, the nominal carrier frequency shall be adjusted as close to the upper and lower frequency band edges as the design of the equipment permits.

(c) The device shall automatically discontinue transmission in case of either absence of information to transmit or operational failure. These provisions are not intended to preclude the transmission of control or signalling information or the use of repetitive codes used by certain digital technologies to complete frame or burst intervals. Applicants shall include in their application for equipment authorization a description of how this requirement is met.

RSS-247 Clause 6.2

Frequency band 5150-5250 MHz

6.2.1.2 Unwanted emission limits

For transmitters with operating frequencies in the band 5150-5250 MHz, all emissions outside the band 5150-5350 MHz shall not exceed -27 dBm/MHz e.i.r.p. Any unwanted emissions that fall into the band 5250-5350 MHz shall be attenuated below the channel power by at least 26 dB, when measured using a resolution bandwidth between 1 and 5% of the occupied bandwidth (i.e. 99% bandwidth), above 5250 MHz. The 26 dB bandwidth may fall into the 5250-5350 MHz band; however, if the occupied bandwidth also falls within the 5250-5350 MHz band, the transmission is considered as intentional and the devices shall comply with all requirements in the band 5250-5350 MHz including implementing dynamic frequency selection (DFS) and TPC, on the portion of the emission that resides in the 5250-5350 MHz band.

Frequency band 5725-5850 MHz

6.2.4.2 Unwanted emission limits

Devices operating in the band 5725-5850 MHz with antenna gain greater than 10 dBi can have unwanted emissions that comply with either the limits in this section or in section 5.5 until six (6) months after the publication date of this standard for certification. Certified devices that do not comply with emission limits in this section shall not be manufactured, imported, distributed, leased, offered for sale or sold after April 1, 2018.

Devices operating in the band 5725-5850 MHz with antenna gain of 10 dBi or less can have unwanted emissions that comply with either the limits in this section or in section 5.5 until April 1, 2018 for certification. Certified devices that do not comply with emission limits in this section shall not be manufactured, imported, distributed, leased, offered for sale or sold after April 1, 2020.

Devices operating in the band 5725-5850 MHz shall have e.i.r.p. of unwanted emissions comply with the following:

- 27 dBm/MHz at frequencies from the band edges decreasing linearly to 15.6 dBm/MHz at 5 MHz above or below the band edges;
- 15.6 dBm/MHz at 5 MHz above or below the band edges decreasing linearly to 10 dBm/MHz at 25 MHz above or below the band edges;
- 10 dBm/MHz at 25 MHz above or below the band edges decreasing linearly to -27 dBm/MHz at 75 MHz above or below the band edges; and
- 27 dBm/MHz at frequencies more than 75 MHz above or below the band edges.

3.2.2 EUT Setup

Below 1GHz:

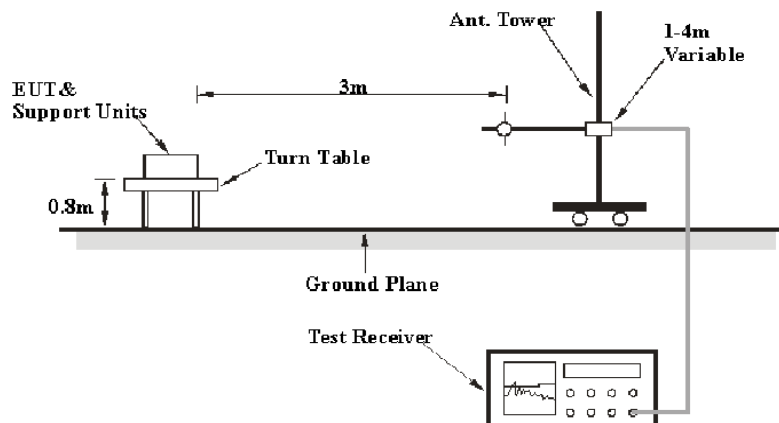

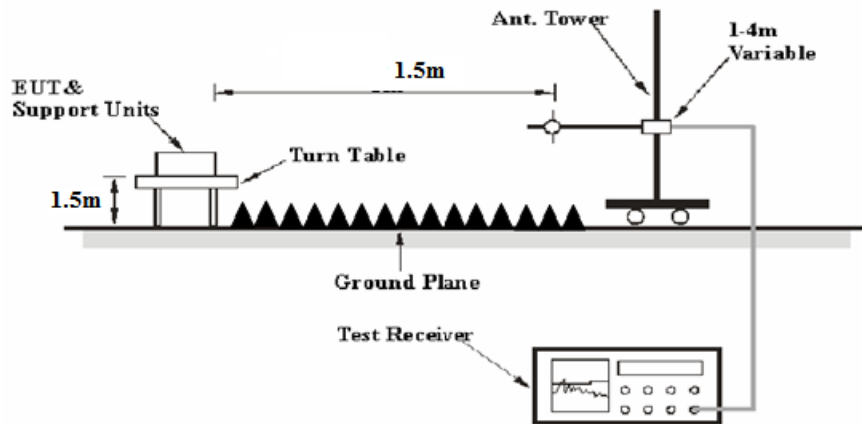
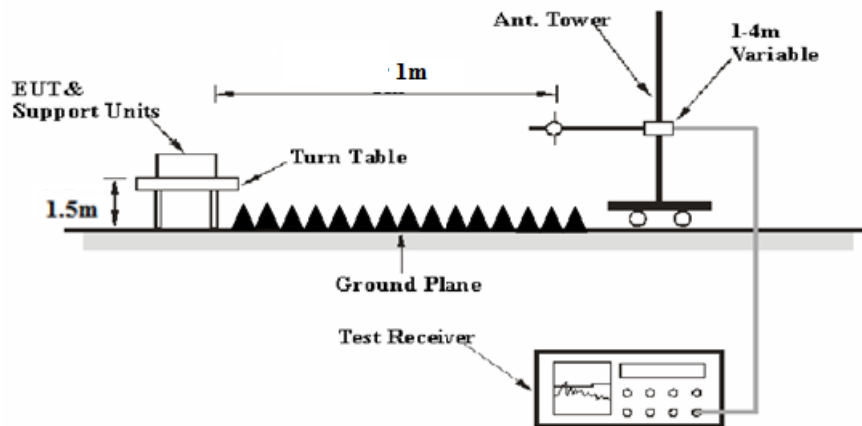
1-26.5 GHz:**26.5-40 GHz:**

The radiated emission tests were performed in the 3 meters chamber test site, using the setup accordance with the ANSI C63.10-2013. The specification used was FCC 15.209, FCC 15.407, RSS-247, RSS-Gen limits.

The external I/O cables were draped along the test table and formed a bundle 30 to 40 cm long in the middle.

The spacing between the peripherals was 10 cm.

3.2.3 EMI Test Receiver & Spectrum Analyzer Setup

The system was investigated from 30 MHz to 40 GHz.

During the radiated emission test, the EMI test receiver & Spectrum Analyzer Setup were set with the following configurations:

30-1000MHz:

Detector	RBW	Video B/W	IF B/W
QP	120 kHz	300 kHz	120kHz

1GHz- 40GHz:

Detector	RBW	Video B/W
PK	1MHz	3 MHz
Ave.	1MHz	3 MHz

If the maximized peak measured value complies with under the QP/Average limit more than 6dB, then it is unnecessary to perform an QP/Average measurement.

3.2.4 Test Procedure

During the radiated emission test, the adapter was connected to the first AC floor outlet.

Data was recorded in Quasi-peak detection mode for frequency range of 30 MHz-1GHz, peak and Average detection modes for frequencies above 1GHz.

According to KDB 789033 D02 General UNII Test Procedures New Rules v02r01, emission shall be computed as: $E [dB\mu V/m] = EIRP[dBm] + 95.2$, for $d = 3$ meters.

According to C63.10, the above 1G test result shall be extrapolated to the specified distance using an extrapolation Factor of 20dB/decade from 3m to 1.5m or 1m

Distance extrapolation Factor = $20 \log (\text{specific distance [3m]}/\text{test distance [1.5m]})$ dB= 6.02 dB

or

Distance extrapolation Factor = $20 \log (\text{specific distance [3m]}/\text{test distance [1m]})$ dB= 9.54 dB

All emissions under the average limit and under the noise floor have not recorded in the report.

3.2.5 Corrected Amplitude & Margin Calculation

The basic equation is as follows:

Factor = Antenna Factor + Cable Loss- Amplifier Gain

For 30MHz-1GHz:

Result = Reading + Factor

For 1GHz-40GHz

Result = Reading + Factor- Distance extrapolation Factor

The “**Margin**” column of the following data tables indicates the degree of compliance within the applicable limit. The equation for margin calculation is as follows:

Margin = Limit – Result

3.3 26dB attenuated below the channel power:

3.3.1 Applicable Standard

RSS-247 Clause 6.2.1.2

For transmitters with operating frequencies in the band 5150-5250 MHz, all emissions outside the band 5150-5350 MHz shall not exceed -27 dBm/MHz e.i.r.p. Any unwanted emissions that fall into the band 5250-5350 MHz shall be attenuated below the channel power by at least 26 dB, when measured using a resolution bandwidth between 1 and 5% of the occupied bandwidth (i.e. 99% bandwidth), above 5250 MHz. The 26 dB bandwidth may fall into the 5250-5350 MHz band; however, if the occupied bandwidth also falls within the 5250-5350 MHz band, the transmission is considered as intentional and the devices shall comply with all requirements in the band 5250-5350 MHz including implementing dynamic frequency selection (DFS) and TPC, on the portion of the emission that resides in the 5250-5350 MHz band.

3.3.2 EUT Setup

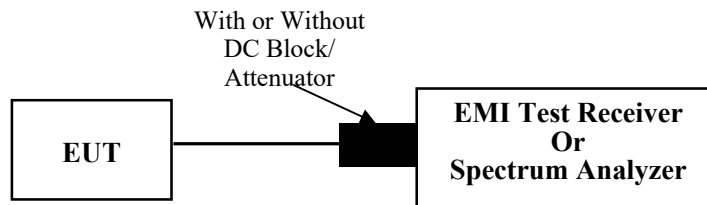

3.3.3 Test Procedure

- Set RBW = 1%~5% of the emission bandwidth.
- Set the VBW > RBW.
- Detector = peak.
- Trace mode = max hold
- Measure the emission attenuated below the channel power

3.4 Emission Bandwidth:

3.4.1 Applicable Standard

FCC §15.407 (a),(h)

(h)(2) Radar Detection Function of Dynamic Frequency Selection (DFS). U-NII devices operating with any part of its 26 dB emission bandwidth in the 5.25-5.35 GHz and 5.47-5.725 GHz bands shall employ a DFS radar detection mechanism to detect the presence of radar systems and to avoid co-channel operation with radar systems.

FCC §15.407 (e)

Within the 5.725-5.850 GHz and 5.850-5.895 GHz bands, the minimum 6 dB bandwidth of U-NII devices shall be at least 500 kHz.

RSS-247 Clause 6.2.1.2

For transmitters with operating frequencies in the band 5150-5250 MHz, all emissions outside the band 5150-5350 MHz shall not exceed -27 dBm/MHz e.i.r.p. Any unwanted emissions that fall into the band 5250-5350 MHz shall be attenuated below the channel power by at least 26 dB, when measured using a resolution bandwidth between 1 and 5% of the occupied bandwidth (i.e. 99% bandwidth), above 5250 MHz. The 26 dB bandwidth may fall into the 5250-5350 MHz band; however, if the occupied bandwidth also falls within the 5250-5350 MHz band, the transmission is considered as intentional and the devices shall comply with all requirements in the band 5250-5350 MHz including implementing dynamic frequency selection (DFS) and TPC, on the portion of the emission that resides in the 5250-5350 MHz band.

RSS-247 Clause 6.2.4.1

For equipment operating in the band 5725-5850 MHz, the minimum 6 dB bandwidth shall be at least 500 kHz.

3.4.2 EUT Setup

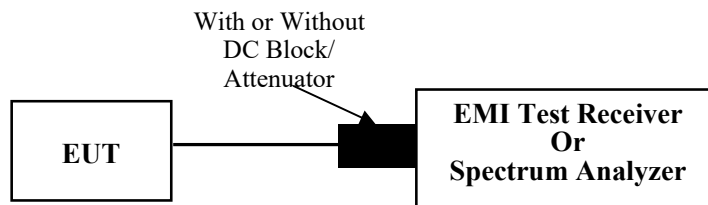

3.4.3 Test Procedure

26dB Emission Bandwidth:

According to ANSI C63.10-2013 Section 12.4.1

- a) Set RBW = approximately 1% of the emission bandwidth.
- b) Set the VBW > RBW.
- c) Detector = peak.
- d) Trace mode = max hold
- e) Measure the maximum width of the emission that is 26 dB down from the peak of the emission. Compare this with the RBW setting of the instrument. Readjust RBW and repeat measurement as needed until the RBW/EBW ratio is approximately 1%.

99% Occupied Bandwidth:

According to ANSI C63.10-2013 Section 12.4.2&6.9.3

The occupied bandwidth is the frequency bandwidth such that, below its lower and above its upper frequency limits, the mean powers are each equal to 0.5% of the total mean power of the given emission. The following procedure shall be used for measuring 99% power bandwidth:

- a) The instrument center frequency is set to the nominal EUT channel center frequency. The frequency span for the spectrum analyzer shall be between 1.5 times and 5.0 times the OBW.
- b) The nominal IF filter bandwidth (3 dB RBW) shall be in the range of 1% to 5% of the OBW, and VBW shall be approximately three times the RBW, unless otherwise specified by the applicable requirement.
- c) Set the reference level of the instrument as required, keeping the signal from exceeding the maximum input mixer level for linear operation. In general, the peak of the spectral envelope shall be more than $[10 \log (OBW/RBW)]$ below the reference level. Specific guidance is given in 4.1.5.2.
- d) Step a) through step c) might require iteration to adjust within the specified range.
- e) Video averaging is not permitted. Where practical, a sample detection and single sweep mode shall be used. Otherwise, peak detection and max hold mode (until the trace stabilizes) shall be used.
- f) Use the 99% power bandwidth function of the instrument (if available) and report the measured bandwidth.
- g) If the instrument does not have a 99% power bandwidth function, then the trace data points are recovered and directly summed in linear power terms. The recovered amplitude data points, beginning at the lowest frequency, are placed in a running sum until 0.5% of the total is reached; that frequency is recorded as the lower frequency. The process is repeated until 99.5% of the total is reached; that frequency is recorded as the upper frequency. The 99% power bandwidth is the difference between these two frequencies.
- h) The occupied bandwidth shall be reported by providing plot(s) of the measuring instrument display; the plot axes and the scale units per division shall be clearly labeled. Tabular data may be reported in addition to the plot(s).

6 dB emission bandwidth:

According to KDB 789033 D02 General UNII Test Procedures New Rules v02r01

- a) Set RBW = 100 kHz.
- b) Set the video bandwidth (VBW) ≥ 3 RBW.
- c) Detector = Peak.
- d) Trace mode = max hold.
- e) Sweep = auto couple.
- f) Allow the trace to stabilize.
- g) Measure the maximum width of the emission that is constrained by the frequencies associated with the two outermost amplitude points (upper and lower frequencies) that are attenuated by 6 dB relative to the maximum level measured in the fundamental emission.

Note: The automatic bandwidth measurement capability of a spectrum analyzer or EMI receiver may be employed if it implements the functionality described in this section. For devices that use channel aggregation refer to III.A and III.C for determining emission bandwidth.

3.5 Maximum conducted output power:

3.5.1 Applicable Standard

FCC §15.407(a) (1)(iv)

For client devices in the 5.15-5.25 GHz band, the maximum conducted output power over the frequency band of operation shall not exceed 250 mW provided the maximum antenna gain does not exceed 6 dBi. In addition, the maximum power spectral density shall not exceed 11 dBm in any 1 megahertz band. If transmitting antennas of directional gain greater than 6 dBi are used, both the maximum conducted output power and the maximum power spectral density shall be reduced by the amount in dB that the directional gain of the antenna exceeds 6 dBi.

FCC §15.407(a) (3)(i)

For the band 5.725-5.850 GHz, the maximum conducted output power over the frequency band of operation shall not exceed 1 W. In addition, the maximum power spectral density shall not exceed 30 dBm in any 500-kHz band. If transmitting antennas of directional gain greater than 6 dBi are used, both the maximum conducted output power and the maximum power spectral density shall be reduced by the amount in dB that the directional gain of the antenna exceeds 6 dBi. However, fixed point-to-point U-NII devices operating in this band may employ transmitting antennas with directional gain greater than 6 dBi without any corresponding reduction in transmitter conducted power. Fixed, point-to-point operations exclude the use of point-to-multipoint systems, omnidirectional applications, and multiple collocated transmitters transmitting the same information. The operator of the U-NII device, or if the equipment is professionally installed, the installer, is responsible for ensuring that systems employing high gain directional antennas are used exclusively for fixed, point-to-point operations.

RSS-247 Clause 6.2.1.1

For OEM devices installed in vehicles, the maximum e.i.r.p. shall not exceed 30 mW or $1.76 + 10 \log_{10}B$, dBm, whichever is less stringent. Devices shall implement transmitter power control (TPC) in order to have the capability to operate at least 3 dB below the maximum permitted e.i.r.p. of 30 mW.

For other devices, the maximum e.i.r.p. shall not exceed 200 mW or $10 + 10 \log_{10}B$, dBm, whichever power is less. B is the 99% emission bandwidth in megahertz. The e.i.r.p. spectral density shall not exceed 10 dBm in any 1.0 MHz band.

RSS-247 Clause 6.2.4.1

The maximum conducted output power shall not exceed 1 W. The output power spectral density shall not exceed 30 dBm in any 500 kHz band. If transmitting antennas of directional gain greater than 6 dBi are used, both the maximum conducted output power and the output power spectral density shall be reduced by the amount in dB that the directional gain of the antenna exceeds 6 dBi. However, fixed point-to-point devices operating in this band may employ transmitting antennas with directional gain greater than 6 dBi without any corresponding reduction in transmitter conducted power. Fixed point-to-point operations exclude the use of point-to-multipoint systems, omnidirectional applications and multiple collocated transmitters transmitting the same information.

3.5.2 EUT Setup

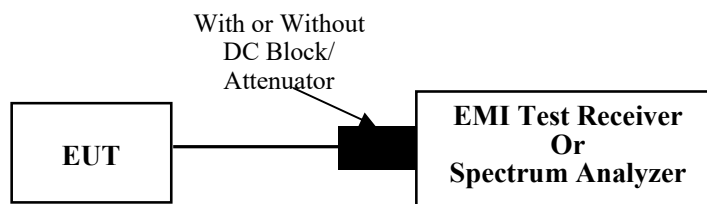

3.5.3 Test Procedure

According to ANSI C63.10-2013 Section 11.9.1.3

Method PM-G is measurement using a gated RF average power meter. Measurements may be performed using a wideband gated RF power meter provided that the gate parameters are adjusted such that the power is measured only when the EUT is transmitting at its maximum power control level. Because the measurement is made only during the ON time of the transmitter, no duty cycle correction factor is required.

3.6 Maximum power spectral density:

3.6.1 Applicable Standard

FCC §15.407(a) (1)(iv)

For client devices in the 5.15-5.25 GHz band, the maximum conducted output power over the frequency band of operation shall not exceed 250 mW provided the maximum antenna gain does not exceed 6 dBi. In addition, the maximum power spectral density shall not exceed 11 dBm in any 1 megahertz band. If transmitting antennas of directional gain greater than 6 dBi are used, both the maximum conducted output power and the maximum power spectral density shall be reduced by the amount in dB that the directional gain of the antenna exceeds 6 dBi.

FCC §15.407(a) (3)(i)

For the band 5.725-5.850 GHz, the maximum conducted output power over the frequency band of operation shall not exceed 1 W. In addition, the maximum power spectral density shall not exceed 30 dBm in any 500-kHz band. If transmitting antennas of directional gain greater than 6 dBi are used, both the maximum conducted output power and the maximum power spectral density shall be reduced by the amount in dB that the directional gain of the antenna exceeds 6 dBi. However, fixed point-to-point U-NII devices operating in this band may employ transmitting antennas with directional gain greater than 6 dBi without any corresponding reduction in transmitter conducted power. Fixed, point-to-point operations exclude the use of point-to-multipoint systems, omnidirectional applications, and multiple collocated transmitters transmitting the same information. The operator of the U-NII device, or if the equipment is professionally installed, the installer, is responsible for ensuring that systems employing high gain directional antennas are used exclusively for fixed, point-to-point operations.

RSS-247 Clause 6.2.1.1

For OEM devices installed in vehicles, the maximum e.i.r.p. shall not exceed 30 mW or $1.76 + 10 \log_{10}B$, dBm, whichever is less stringent. Devices shall implement transmitter power control (TPC) in order to have the capability to operate at least 3 dB below the maximum permitted e.i.r.p. of 30 mW.

For other devices, the maximum e.i.r.p. shall not exceed 200 mW or $10 + 10 \log_{10}B$, dBm, whichever power is less. B is the 99% emission bandwidth in megahertz. The e.i.r.p. spectral density shall not exceed 10 dBm in any 1.0 MHz band.

RSS-247 Clause 6.2.4.1

The maximum conducted output power shall not exceed 1 W. The output power spectral density shall not exceed 30 dBm in any 500 kHz band. If transmitting antennas of directional gain greater than 6 dBi are used, both the maximum conducted output power and the output power spectral density shall be reduced by the amount in dB that the directional gain of the antenna exceeds 6 dBi. However, fixed point-to-point devices operating in this band may employ transmitting antennas with directional gain greater than 6 dBi without any corresponding reduction in transmitter conducted power. Fixed point-to-point operations exclude the use of point-to-multipoint systems, omnidirectional applications and multiple collocated transmitters transmitting the same information.

3.6.2 EUT Setup

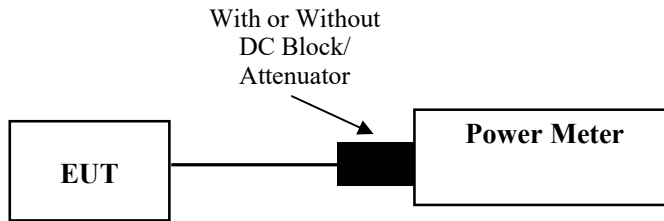

3.6.3 Test Procedure

According to KDB 789033 D02 General UNII Test Procedures New Rules v02r01

Method SA-3 (power averaging (rms) detection with max hold):

(i) Set span to encompass the entire EBW (or, alternatively, the entire 99% occupied bandwidth) of the signal.

(ii) Set sweep trigger to “free run.”

(iii) Set RBW = 1 MHz.

(iv) Set VBW \geq 3 MHz

(v) Number of points in sweep $\geq 2 \times \text{span} / \text{RBW}$. (This ensures that bin-to-bin spacing is $\leq \text{RBW}/2$, so that narrowband signals are not lost between frequency bins.)

(vi) Sweep time $\leq (\text{number of points in sweep}) \times T$, where T is defined in II.B.1.a).

Note: If this results in a sweep time less than the auto sweep time of the analyzer, Method SA-3 Alternative shall not be used. (The purpose of this step is to ensure that averaging time in each bin is less than or equal to the minimum time of a transmission.)

(vii) Detector = power averaging (rms).

(viii) Trace mode = max hold.

(ix) Allow max hold to run for at least 60 seconds, or longer as needed to allow the trace to stabilize.

For devices operating in the band 5.725–5.85 GHz, the rules specify a measurement bandwidth of 500 kHz. Many spectrum analyzers do not have 500 kHz RBW, thus a narrower RBW may need to be used.

3.7 Duty Cycle:

3.7.1 EUT Setup

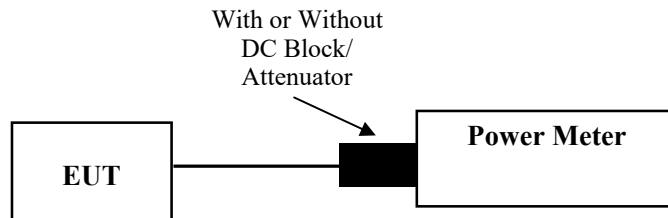

3.7.2 Test Procedure

According to ANSI C63.10-2013 Section 12.2

The zero-span mode on a spectrum analyzer or EMI receiver if the response time and spacing between bins on the sweep are sufficient to permit accurate measurements of the ON and OFF times of the transmitted signal:

- 1) Set the center frequency of the instrument to the center frequency of the transmission.
- 2) Set $RBW \geq OBW$ if possible; otherwise, set RBW to the largest available value.
- 3) Set $VBW \geq RBW$. Set detector = peak or average.
- 4) The zero-span measurement method shall not be used unless both RBW and VBW are $> 50/T$ and the number of sweep points across duration T exceeds 100. (For example, if VBW and/or RBW are limited to 3 MHz, then the zero-span method of measuring the duty cycle shall not be used if $T \leq 16.7 \mu s$.)

3.8 Antenna Requirement

3.8.1 Applicable Standard

FCC §15.203

An intentional radiator shall be designed to ensure that no antenna other than that furnished by the responsible party shall be used with the device. The use of a permanently attached antenna or of an antenna that uses a unique coupling to the intentional radiator shall be considered sufficient to comply with the provisions of this section. The manufacturer may design the unit so that a broken antenna can be replaced by the user, but the use of a standard antenna jack or electrical connector is prohibited. This requirement does not apply to carrier current devices or to devices operated under the provisions of §§15.211, 15.213, 15.217, 15.219, 15.221, or §15.236. Further, this requirement does not apply to intentional radiators that must be professionally installed, such as perimeter protection systems and some field disturbance sensors, or to other intentional radiators which, in accordance with §15.31(d), must be measured at the installation site. However, the installer shall be responsible for ensuring that the proper antenna is employed so that the limits in this part are not exceeded.

RSS-GEN Clause 6.8

The applicant for equipment certification shall provide a list of all antenna types that may be used with the transmitter, where applicable (i.e. for transmitters with detachable antenna), indicating the maximum permissible antenna gain (in dBi) and the required impedance for each antenna. The test report shall demonstrate the compliance of the transmitter with the limit for maximum equivalent isotropically radiated power (e.i.r.p.) specified in the applicable RSS, when the transmitter is equipped with any antenna type, selected from this list.

For expediting the testing, measurements may be performed using only the antenna with highest gain of each combination of transmitter and antenna type, with the transmitter output power set at the maximum level. However, the transmitter shall comply with the applicable requirements under all operational conditions and when in combination with any type of antenna from the list provided in the test report (and in the notice to be included in the user manual, provided below).

When measurements at the antenna port are used to determine the RF output power, the effective gain of the device's antenna shall be stated, based on a measurement or on data from the antenna's manufacturer.

The test report shall state the RF power, output power setting and spurious emission measurements with each antenna type that is used with the transmitter being tested.

For licence-exempt equipment with detachable antennas, the user manual shall also contain the following notice in a conspicuous location:

This radio transmitter [enter the device's ISED certification number] has been approved by Innovation, Science and Economic Development Canada to operate with the antenna types listed below, with the maximum permissible gain indicated. Antenna types not included in this list that have a gain greater than the maximum gain indicated for any type listed are strictly prohibited for use with this device.

Immediately following the above notice, the manufacturer shall provide a list of all antenna types which can be used with the transmitter, indicating the maximum permissible antenna gain (in dBi) and the required impedance for each antenna type.

3.8.2 Judgment

Please refer to the Antenna Information detail in Section 1.

3.9 Additional requirement

3.9.1 Applicable Standard

According to RSS-247 Clause 6.4 Additional requirement

The following requirements shall apply:

- a) The device shall automatically discontinue transmission in cases of absence of information to transmit, or operational failure. A description on how this is done shall accompany the application for equipment certification. Note that this is not intended to prohibit transmission of control or signalling information or the use of repetitive codes where required by the technology.
- b) All LE-LAN devices must contain security features to protect against modification of software by unauthorized parties.

Manufacturers must implement security features in any digitally modulated devices capable of operating in any of the frequency ranges within the 5 GHz band, so that third parties are not able to reprogram the device to operate outside the parameters for which the device was certified. The software must prevent the user from operating the transmitter with operating frequencies, output power, modulation types or other radio frequency parameters outside those that were approved for the device. Manufacturers may use various means, including the use of a private network that allows only authenticated users to download software, electronic signatures in software or coding in hardware that is decoded by software to verify that new software can be legally loaded into a device to meet these requirements and must describe the methods in their application for equipment certification.

Manufacturers must take steps to ensure that DFS functionality cannot be disabled by the operator of the LE-LAN device.

- c) The user manual for LE-LAN devices shall contain instructions related to the restrictions mentioned in the above sections, namely that:
 - i. the device for operation in the band 5150–5250 MHz is only for indoor use to reduce the potential for harmful interference to co-channel mobile satellite systems;⁴
 - ii. for devices with detachable antenna(s), the maximum antenna gain permitted for devices in the bands 5250-5350 MHz and 5470-5725 MHz shall be such that the equipment still complies with the e.i.r.p. limit;
 - iii. for devices with detachable antenna(s), the maximum antenna gain permitted for devices in the band 5725-5850 MHz shall be such that the equipment still complies with the e.i.r.p. limits as appropriate; and
 - iv. where applicable, antenna type(s), antenna models(s), and worst-case tilt angle(s) necessary to remain compliant with the e.i.r.p. elevation mask requirement set forth in section 6.2.2.3 shall be clearly indicated.

3.9.2 Judgment

RSS-247 Clause 6.4 a):

The device shall automatically discontinue transmission in cases of absence of information to transmit, or operational failure. Please refer to the declaration

RSS-247 Clause 6.4 b):

The devices must contain security features to protect against modification of software by unauthorized parties. Please refer to the declaration

RSS-247 Clause 6.4 c):

This device is restricted to indoor use when operating in the 5150 to 5250 MHz frequency range, please refer to the user manual.

The device operates on 5150-5250MHz and 5725-5850MHz, all the EIPR compliance with RSS-247 requirement. Please refer to the conducted output power test result.

4. Test DATA AND RESULTS

4.1 AC Line Conducted Emissions

Serial Number:	CR22070077-RF-S1	Test Date:	2022-08-11
Test Site:	CE	Test Mode:	Transmitting(802.11a 5745MHz was the worst)
Tester:	Vic Du	Test Result:	Pass

Environmental Conditions:

Temperature: (°C)	26.8	Relative Humidity: (%)	69	ATM Pressure: (kPa)	100.2
----------------------	------	---------------------------	----	------------------------	-------

Test Equipment List and Details:

Manufacturer	Description	Model	Serial Number	Calibration Date	Calibration Due Date
R&S	LISN	ENV216	101134	2022-04-01	2023-03-31
R&S	EMI Test Receiver	ESR3	102726	2022-07-15	2023-07-14
MICRO-COAX	Coaxial Cable	UTIFLEX	C-0200-01	2022-08-07	2023-08-06
Audix	Test Software	E3	190306 (V9)	N/A	N/A

* Statement of Traceability: China Certification ICT Co., Ltd (Dongguan) attests that all calibrations have been performed, traceable to National Primary Standards and International System of Units (SI).

Line:

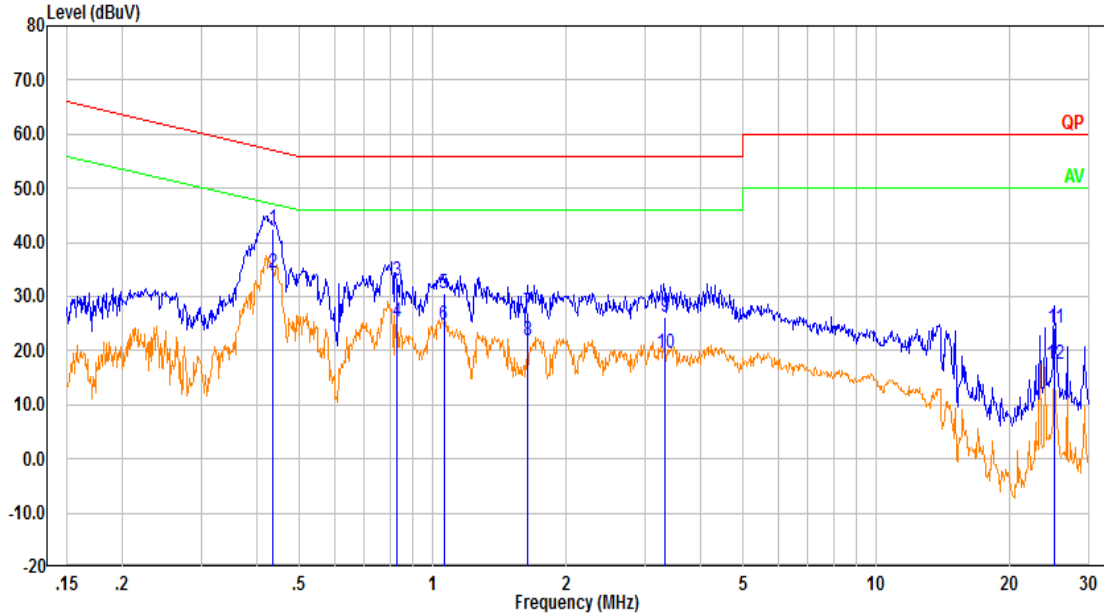

No.	Frequency (MHz)	Reading (dBμV)	Factor (dB)	Result (dBμV)	Limit (dBμV)	Margin (dB)	Detector
1	0.435	32.85	9.61	42.46	57.15	14.69	QP
2	0.435	24.82	9.61	34.43	47.15	12.72	Average
3	0.832	23.31	9.62	32.93	56.00	23.07	QP
4	0.832	15.69	9.62	25.31	46.00	20.69	Average
5	1.058	21.09	9.62	30.71	56.00	25.29	QP
6	1.058	15.24	9.62	24.86	46.00	21.14	Average
7	1.637	17.45	9.63	27.08	56.00	28.92	QP
8	1.637	12.17	9.63	21.79	46.00	24.21	Average
9	3.327	16.50	9.65	26.15	56.00	29.85	QP
10	3.327	9.79	9.65	19.44	46.00	26.56	Average
11	25.223	14.36	9.81	24.17	60.00	35.83	QP
12	25.223	7.56	9.81	17.38	50.00	32.62	Average

Neutral:

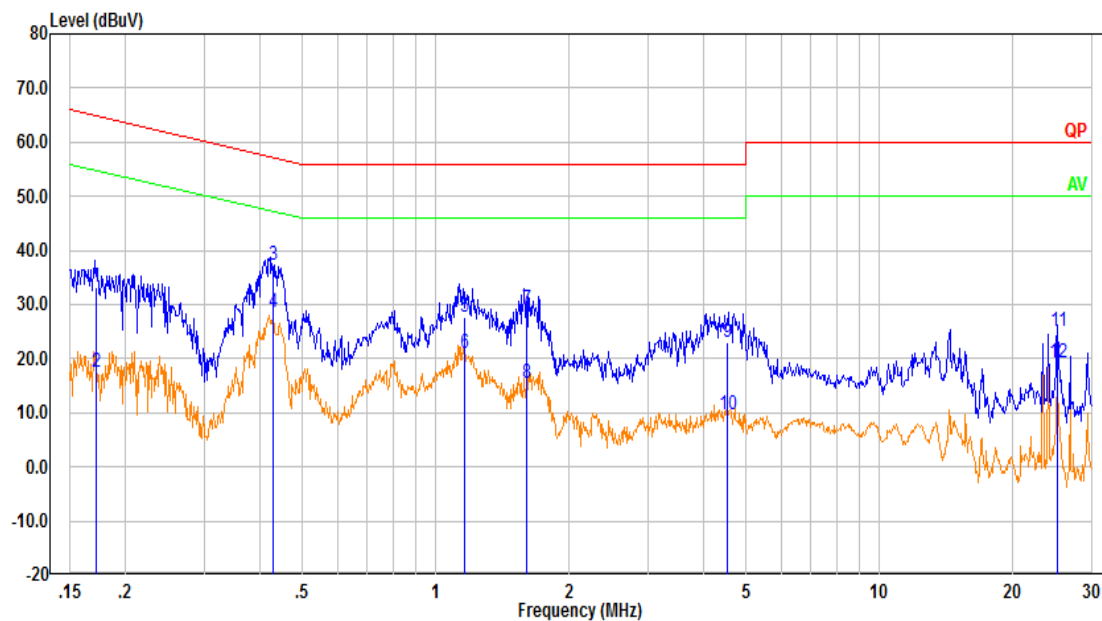

No.	Frequency (MHz)	Reading (dB μ V)	Factor (dB)	Result (dB μ V)	Limit (dB μ V)	Margin (dB)	Detector
1	0.171	23.46	9.61	33.07	64.90	31.83	QP
2	0.171	7.74	9.61	17.35	54.90	37.55	Average
3	0.431	27.55	9.61	37.16	57.24	20.08	QP
4	0.431	18.95	9.61	28.56	47.24	18.68	Average
5	1.161	18.00	9.62	27.62	56.00	28.38	QP
6	1.161	11.32	9.62	20.94	46.00	25.06	Average
7	1.602	19.55	9.63	29.18	56.00	26.82	QP
8	1.602	5.84	9.63	15.47	46.00	30.53	Average
9	4.535	13.48	9.66	23.13	56.00	32.87	QP
10	4.535	-0.07	9.66	9.59	46.00	36.41	Average
11	25.222	15.28	9.76	25.05	60.00	34.95	QP
12	25.222	9.47	9.76	19.23	50.00	30.77	Average

4.2 Radiation Spurious Emissions

Serial Number:	CR22070077-RF-S1	Test Date:	2022-08-22~2022-08-24
Test Site:	966-1,966-2	Test Mode:	Transmitting
Tester:	Carl Xue, Mark Huang	Test Result:	Pass

Environmental Conditions:

Temperature: (°C)	27.1~27.2	Relative Humidity: (%)	59~63	ATM Pressure: (kPa)	99.8~100.1
----------------------	-----------	------------------------------	-------	------------------------	------------

Test Equipment List and Details:

Manufacturer	Description	Model	Serial Number	Calibration Date	Calibration Due Date
Sunol Sciences	Antenna	JB6	A082520-5	2020-10-19	2023-10-18
R&S	EMI Test Receiver	ESR3	102724	2022-07-15	2023-07-14
TIMES MICROWAVE	Coaxial Cable	LMR-600-UltraFlex	C-0470-02	2022-07-17	2023-07-16
TIMES MICROWAVE	Coaxial Cable	LMR-600-UltraFlex	C-0780-01	2022-07-17	2023-07-16
Sonoma	Amplifier	310N	186165	2022-07-17	2023-07-16
ETS-Lindgren	Horn Antenna	3115	9912-5985	2020-10-13	2023-10-12
R&S	Spectrum Analyzer	FSV40	101591	2022-07-15	2023-07-14
MICRO-COAX	Coaxial Cable	UFA210A-1-1200-70U300	217423-008	2022-08-07	2023-08-06
MICRO-COAX	Coaxial Cable	UFA210A-1-2362-300300	235780-001	2022-08-07	2023-08-06
Mini	Pre-amplifier	ZVA-183-S+	5969001149	2021-11-10	2022-11-09
Audix	Test Software	E3	201021 (V9)	N/A	N/A
PASTERNAK	Horn Antenna	PE9852/2F-20	112002	2021-02-05	2024-02-04
AH	Preamplifier	PAM-1840VH	190	2021-11-19	2022-11-18
MICRO-COAX	Coaxial Cable	UFB142A-1-2362-200200	235772-001	2022-08-07	2023-08-06
E-Microwave	Band Rejection Filter	5150-5850MHz	OE01902423	2022-08-07	2023-08-06
Mini Circuits	High Pass Filter	VHF-6010+	31119	2022-08-07	2023-08-06
PASTERNAK	Horn Antenna	PE9850/2F-20	072001	2021-02-05	2024-02-04

* Statement of Traceability: China Certification ICT Co., Ltd (Dongguan) attests that all calibrations have been performed, traceable to National Primary Standards and International System of Units (SI).

Test Data:

1) 30MHz-1GHz(802.11a 5745MHz was the worst)

Horizontal:

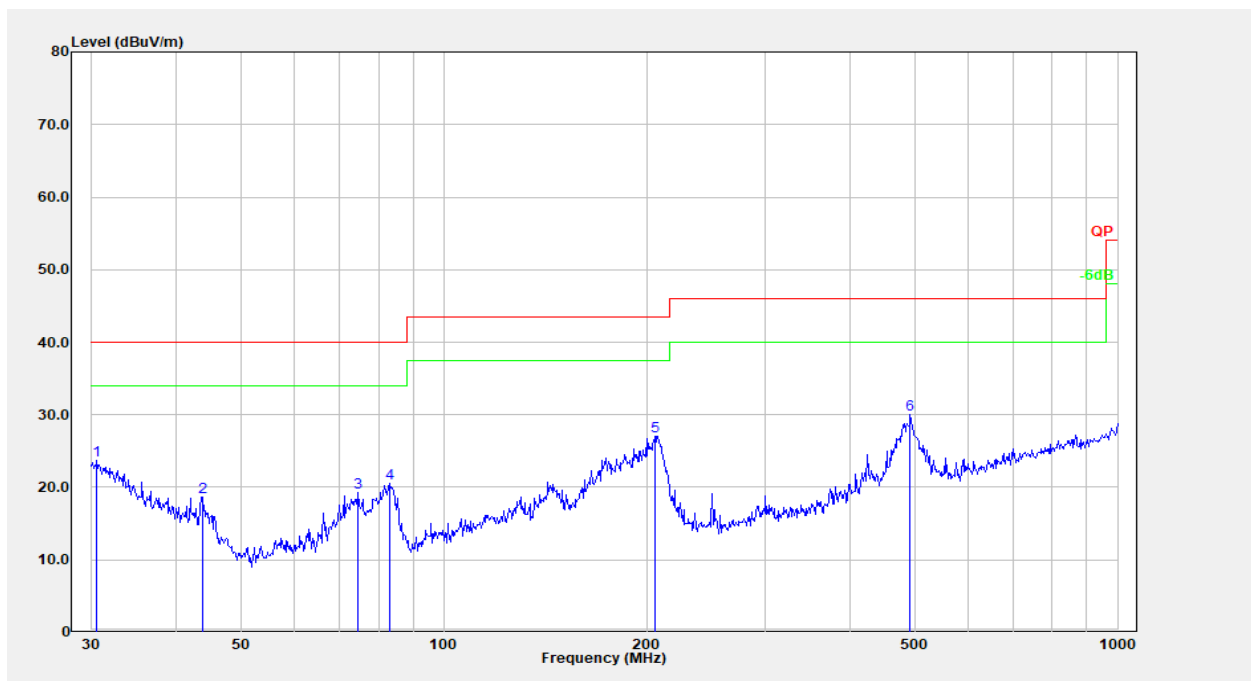

No.	Frequency (MHz)	Reading (dBμV)	Factor (dB/m)	Result (dBμV/m)	Limit (dBμV/m)	Margin (dB)	Detector
1	30.531	27.94	-4.20	23.74	40.00	16.26	Peak
2	43.812	32.50	-13.80	18.70	40.00	21.30	Peak
3	74.657	36.37	-17.16	19.21	40.00	20.79	Peak
4	82.938	38.04	-17.50	20.54	40.00	19.46	Peak
5	205.675	39.60	-12.54	27.06	43.50	16.44	Peak
6	492.469	36.52	-6.44	30.08	46.00	15.92	Peak

Vertical:

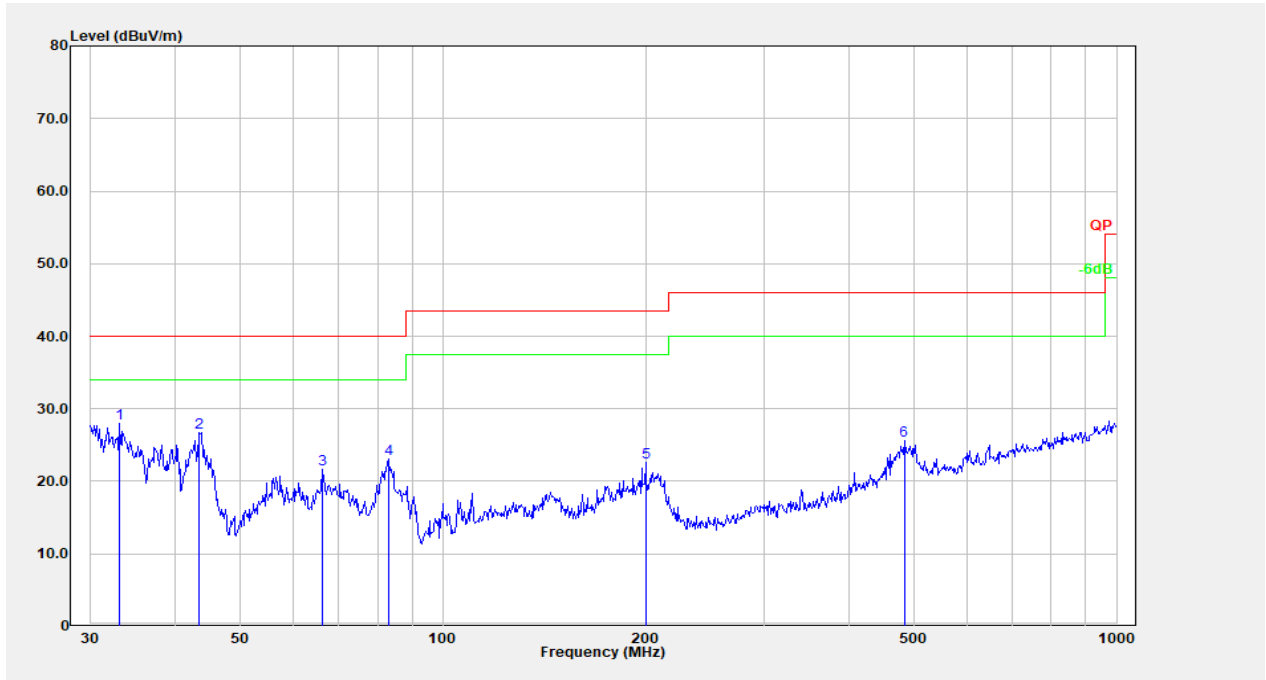

No.	Frequency (MHz)	Reading (dBμV)	Factor (dB/m)	Result (dBμV/m)	Limit (dBμV/m)	Margin (dB)	Detector
1	33.095	34.10	-6.19	27.91	40.00	12.09	Peak
2	43.506	40.33	-13.61	26.72	40.00	13.28	Peak
3	66.266	38.77	-17.07	21.70	40.00	18.30	Peak
4	82.938	40.57	-17.50	23.08	40.00	16.92	Peak
5	199.986	34.94	-12.37	22.57	43.50	20.93	Peak
6	483.910	32.20	-6.54	25.66	46.00	20.34	Peak

2) 1GHz-40GHz:

5150-5250 MHz:

802.11a:

Frequency (MHz)	Receiver		Polar (H/V)	Factor (dB/m)	Result (dB μ V/m)	Limit (dB μ V/m)	Margin (dB)
	Reading (dB μ V)	Detector					
Low Channel: 5180MHz							
5180.00	69.76	PK	H	38.68	102.42	N/A	N/A
5180.00	59.37	AV	H	38.68	92.03	N/A	N/A
5180.00	71.29	PK	V	38.68	103.95	N/A	N/A
5180.00	61.47	AV	V	38.68	94.13	N/A	N/A
5150.00	32.33	PK	V	38.64	64.95	74.00	9.05
5150.00	17.73	AV	V	38.64	50.35	54.00	3.65
10360.00	34.11	PK	V	19.18	47.27	68.20	20.93
15540.00	35.21	PK	V	22.44	51.63	74.00	22.37
15540.00	23.10	AV	V	22.44	39.52	54.00	14.48
Middle Channel: 5200 MHz							
5200.00	69.36	PK	H	38.70	102.04	N/A	N/A
5200.00	59.47	AV	H	38.70	92.15	N/A	N/A
5200.00	72.13	PK	V	38.70	104.81	N/A	N/A
5200.00	62.02	AV	V	38.70	94.70	N/A	N/A
10400.00	33.54	PK	V	19.16	46.68	68.20	21.52
15600.00	36.69	PK	V	22.41	53.08	74.00	20.92
15600.00	24.34	AV	V	22.41	40.73	54.00	13.27
High Channel: 5240 MHz							
5240.00	69.57	PK	H	38.85	102.40	N/A	N/A
5240.00	58.87	AV	H	38.85	91.70	N/A	N/A
5240.00	71.55	PK	V	38.85	104.38	N/A	N/A
5240.00	61.12	AV	V	38.85	93.95	N/A	N/A
5350.00	29.01	PK	V	39.03	62.02	74.00	11.98
5350.00	16.51	AV	V	39.03	49.52	54.00	4.48
10480.00	34.15	PK	V	18.86	46.99	68.20	21.21
15720.00	38.60	PK	V	22.28	54.86	74.00	19.14
15720.00	26.30	AV	V	22.28	42.56	54.00	11.44

802.11n ht20:

Frequency (MHz)	Receiver		Polar (H/V)	Factor (dB/m)	Result (dB μ V/m)	Limit (dB μ V/m)	Margin (dB)
	Reading (dB μ V)	Detector					
Low Channel: 5180MHz							
5180.00	69.72	PK	H	38.68	102.38	N/A	N/A
5180.00	59.47	AV	H	38.68	92.13	N/A	N/A
5180.00	72.44	PK	V	38.68	105.10	N/A	N/A
5180.00	62.13	AV	V	38.68	94.79	N/A	N/A
5150.00	31.61	PK	V	38.64	64.23	74.00	9.77
5150.00	17.30	AV	V	38.64	49.92	54.00	4.08
10360.00	33.53	PK	V	19.18	46.69	68.20	21.51
15540.00	34.11	PK	V	22.44	50.53	74.00	23.47
15540.00	22.05	AV	V	22.44	38.47	54.00	15.53
Middle Channel: 5200 MHz							
5200.00	68.82	PK	H	38.70	101.50	N/A	N/A
5200.00	58.28	AV	H	38.70	90.96	N/A	N/A
5200.00	70.01	PK	V	38.70	102.69	N/A	N/A
5200.00	60.58	AV	V	38.70	93.26	N/A	N/A
10400.00	35.55	PK	V	19.16	48.69	68.20	19.51
15600.00	36.63	PK	V	22.41	53.02	74.00	20.98
15600.00	24.31	AV	V	22.41	40.70	54.00	13.30
High Channel: 5240 MHz							
5240.00	68.79	PK	H	38.85	101.62	N/A	N/A
5240.00	58.63	AV	H	38.85	91.46	N/A	N/A
5240.00	71.87	PK	V	38.85	104.70	N/A	N/A
5240.00	61.41	AV	V	38.85	94.24	N/A	N/A
5350.00	29.01	PK	V	39.03	62.02	74.00	11.98
5350.00	16.50	AV	V	39.03	49.51	54.00	4.49
10480.00	34.54	PK	V	18.86	47.38	68.20	20.82
15720.00	38.50	PK	V	22.28	54.76	74.00	19.24
15720.00	26.25	AV	V	22.28	42.51	54.00	11.49

802.11n ht40:

Frequency (MHz)	Receiver		Polar (H/V)	Factor (dB/m)	Result (dB μ V/m)	Limit (dB μ V/m)	Margin (dB)
	Reading (dB μ V)	Detector					
Low Channel: 5190 MHz							
5190.00	66.56	PK	H	38.69	99.23	N/A	N/A
5190.00	55.40	AV	H	38.69	88.07	N/A	N/A
5190.00	69.09	PK	V	38.69	101.76	N/A	N/A
5190.00	57.40	AV	V	38.69	90.07	N/A	N/A
5150.00	33.90	PK	V	38.64	66.52	74.00	7.48
5150.00	18.36	AV	V	38.64	50.98	54.00	3.02
10380.00	33.15	PK	V	19.17	46.30	68.20	21.90
15570.00	35.28	PK	V	22.43	51.69	74.00	22.31
15570.00	23.14	AV	V	22.43	39.55	54.00	14.45
High Channel: 5230 MHz							
5230.00	65.58	PK	H	38.81	98.37	N/A	N/A
5230.00	55.74	AV	H	38.81	88.53	N/A	N/A
5230.00	68.94	PK	V	38.81	101.73	N/A	N/A
5230.00	58.20	AV	V	38.81	90.99	N/A	N/A
5350.00	29.18	PK	V	39.03	62.19	74.00	11.81
5350.00	16.53	AV	V	39.03	49.54	54.00	4.46
10460.00	33.12	PK	V	18.94	46.04	68.20	22.16
15690.00	38.57	PK	V	22.29	54.84	74.00	19.16
15690.00	26.34	AV	V	22.29	42.61	54.00	11.39

802.11ac vht80:

Frequency (MHz)	Receiver		Polar (H/V)	Factor (dB/m)	Result (dB μ V/m)	Limit (dB μ V/m)	Margin (dB)
	Reading (dB μ V)	Detector					
5210.00	56.82	PK	H	38.74	89.54	N/A	N/A
5210.00	44.38	AV	H	38.74	77.10	N/A	N/A
5210.00	63.08	PK	V	38.74	95.80	N/A	N/A
5210.00	50.44	AV	V	38.74	83.16	N/A	N/A
5150.00	30.00	PK	V	38.64	62.62	74.00	11.38
5150.00	16.94	AV	V	38.64	49.56	54.00	4.44
5350.00	29.37	PK	V	39.03	62.38	74.00	11.62
5350.00	16.52	AV	V	39.03	49.53	54.00	4.47
10420.00	35.02	PK	V	19.09	48.09	68.20	20.11
15630.00	38.58	PK	V	22.37	54.93	74.00	19.07
15630.00	26.34	AV	V	22.37	42.69	54.00	11.31

5725-5850 MHz

802.11a:

Frequency (MHz)	Receiver		Polar (H/V)	Factor (dB/m)	Result (dB μ V/m)	Limit (dB μ V/m)	Margin (dB)
	Reading (dB μ V)	Detector					
Low Channel: 5745MHz							
5745.00	66.33	PK	H	39.46	99.77	N/A	N/A
5745.00	55.74	AV	H	39.46	89.18	N/A	N/A
5745.00	74.08	PK	V	39.46	107.52	N/A	N/A
5745.00	63.76	AV	V	39.46	97.20	N/A	N/A
5725.00	38.43	PK	V	39.48	71.89	122.20	50.31
5720.00	37.25	PK	V	39.49	70.72	110.80	40.08
5700.00	30.97	PK	V	39.51	64.46	105.20	40.74
5650.00	29.90	PK	V	39.49	63.37	68.20	4.83
11490.00	34.12	PK	V	20.67	48.77	74.00	25.23
11490.00	22.06	AV	V	20.67	36.71	54.00	17.29
17235.00	33.23	PK	V	26.76	53.97	68.20	14.23
Middle Channel: 5785 MHz							
5785.00	66.19	PK	H	39.44	99.61	N/A	N/A
5785.00	54.36	AV	H	39.44	87.78	N/A	N/A
5785.00	74.01	PK	V	39.44	107.43	N/A	N/A
5785.00	63.47	AV	V	39.44	96.89	N/A	N/A
11570.00	33.65	PK	V	20.83	48.46	74.00	25.54
11570.00	21.32	AV	V	20.83	36.13	54.00	17.87
17355.00	33.50	PK	V	27.74	55.22	68.20	12.98
High Channel: 5825 MHz							
5825.00	65.53	PK	H	39.46	98.97	N/A	N/A
5825.00	55.19	AV	H	39.46	88.63	N/A	N/A
5825.00	73.64	PK	V	39.46	107.08	N/A	N/A
5825.00	63.37	AV	V	39.46	96.81	N/A	N/A
5850.00	37.12	PK	V	39.49	70.59	122.20	51.61
5855.00	36.14	PK	V	39.51	69.63	110.80	41.17
5875.00	31.72	PK	V	39.60	65.30	105.20	39.90
5925.00	31.15	PK	V	39.68	64.81	68.20	3.39
11650.00	34.87	PK	V	21.07	49.92	74.00	24.08
11650.00	22.43	AV	V	21.07	37.48	54.00	16.52
17475.00	34.56	PK	V	28.61	57.15	68.20	11.05

802.11n ht20:

Frequency (MHz)	Receiver		Polar (H/V)	Factor (dB/m)	Result (dB μ V/m)	Limit (dB μ V/m)	Margin (dB)
	Reading (dB μ V)	Detector					
Low Channel: 5745MHz							
5745.00	65.38	PK	H	39.46	98.82	N/A	N/A
5745.00	55.36	AV	H	39.46	88.80	N/A	N/A
5745.00	73.36	PK	V	39.46	106.80	N/A	N/A
5745.00	63.01	AV	V	39.46	96.45	N/A	N/A
5725.00	39.59	PK	V	39.48	73.05	122.20	49.15
5720.00	36.46	PK	V	39.49	69.93	110.80	40.87
5700.00	30.89	PK	V	39.51	64.38	105.20	40.82
5650.00	29.78	PK	V	39.49	63.25	68.20	4.95
11490.00	34.16	PK	V	20.67	48.81	74.00	25.19
11490.00	22.08	AV	V	20.67	36.73	54.00	17.27
17235.00	33.80	PK	V	26.76	54.54	68.20	13.66
Middle Channel: 5785 MHz							
5785.00	65.47	PK	H	39.44	98.89	N/A	N/A
5785.00	55.23	AV	H	39.44	88.65	N/A	N/A
5785.00	71.41	PK	V	39.44	104.83	N/A	N/A
5785.00	61.43	AV	V	39.44	94.85	N/A	N/A
11570.00	34.37	PK	V	20.83	49.18	74.00	24.82
11570.00	22.13	AV	V	20.83	36.94	54.00	17.06
17355.00	34.13	PK	V	27.74	55.85	68.20	12.35
High Channel: 5825 MHz							
5825.00	64.12	PK	H	39.46	97.56	N/A	N/A
5825.00	54.78	AV	H	39.46	88.22	N/A	N/A
5825.00	72.03	PK	V	39.46	105.47	N/A	N/A
5825.00	61.33	AV	V	39.46	94.77	N/A	N/A
5850.00	38.83	PK	V	39.49	72.30	122.20	49.90
5855.00	36.44	PK	V	39.51	69.93	110.80	40.87
5875.00	32.17	PK	V	39.60	65.75	105.20	39.45
5925.00	31.74	PK	V	39.68	65.40	68.20	2.80
11650.00	35.04	PK	V	21.07	50.09	74.00	23.91
11650.00	23.02	AV	V	21.07	38.07	54.00	15.93
17475.00	34.36	PK	V	28.61	56.95	68.20	11.25

802.11n ht40:

Frequency (MHz)	Receiver		Polar (H/V)	Factor (dB/m)	Result (dB μ V/m)	Limit (dB μ V/m)	Margin (dB)
	Reading (dB μ V)	Detector					
Low Channel: 5755 MHz							
5755.00	61.92	PK	H	39.45	95.35	N/A	N/A
5755.00	59.58	AV	H	39.45	93.01	N/A	N/A
5755.00	69.76	PK	V	39.45	103.19	N/A	N/A
5755.00	57.12	AV	V	39.45	90.55	N/A	N/A
5725.00	38.75	PK	V	39.48	72.21	122.20	49.99
5720.00	34.59	PK	V	39.49	68.06	110.80	42.74
5700.00	31.40	PK	V	39.51	64.89	105.20	40.31
5650.00	29.82	PK	V	39.49	63.29	68.20	4.91
11510.00	34.25	PK	V	20.67	48.90	74.00	25.10
11510.00	22.13	AV	V	20.67	36.78	54.00	17.22
17265.00	35.67	PK	V	26.94	56.59	68.20	11.61
High Channel: 5795 MHz							
5795.00	60.46	PK	H	39.43	93.87	N/A	N/A
5795.00	50.47	AV	H	39.43	83.88	N/A	N/A
5795.00	68.80	PK	V	39.43	102.21	N/A	N/A
5795.00	58.01	AV	V	39.43	91.42	N/A	N/A
5850.00	34.78	PK	V	39.49	68.25	122.20	53.95
5855.00	33.06	PK	V	39.51	66.55	110.80	44.25
5875.00	31.25	PK	V	39.60	64.83	105.20	40.37
5925.00	32.09	PK	V	39.68	65.75	68.20	2.45
11590.00	34.76	PK	V	20.88	49.62	74.00	24.38
11590.00	22.33	AV	V	20.88	37.19	54.00	16.81
17385.00	33.51	PK	V	28.07	55.56	68.20	12.64

802.11ac vht80:

Frequency (MHz)	Receiver		Polar (H/V)	Factor (dB/m)	Result (dB μ V/m)	Limit (dB μ V/m)	Margin (dB)
	Reading (dB μ V)	Detector					
5775.00	55.10	PK	H	39.44	88.52	N/A	N/A
5775.00	43.75	AV	H	39.44	77.17	N/A	N/A
5775.00	64.70	PK	V	39.44	98.12	N/A	N/A
5775.00	52.36	AV	V	39.44	85.78	N/A	N/A
5725.00	33.51	PK	V	39.48	66.97	122.20	55.23
5720.00	32.86	PK	V	39.49	66.33	110.80	44.47
5700.00	32.45	PK	V	39.51	65.94	105.20	39.26
5650.00	33.07	PK	V	39.49	66.54	68.20	1.66
5850.00	32.49	PK	V	39.49	65.96	122.20	56.24
5855.00	31.33	PK	V	39.51	64.82	110.80	45.98
5875.00	31.33	PK	V	39.60	64.91	105.20	40.29
5925.00	31.83	PK	V	39.68	65.49	68.20	2.71
11550.00	33.72	PK	V	20.78	48.48	74.00	25.52
11550.00	21.41	AV	V	20.78	36.17	54.00	17.83
17325.00	33.41	PK	V	27.41	54.80	68.20	13.40

Note:

Result = Reading + Factor- Distance extrapolation Factor

For 1-26.5GHz:

Distance extrapolation Factor = $20 \log(\text{specific distance [3m]}/\text{test distance [1.5m]})$ dB= 6.02 dB

For 26.5-40GHz:

Distance extrapolation Factor = $20 \log(\text{specific distance [3m]}/\text{test distance [1m]})$ dB= 9.54 dB

Worst Test plots(802.11a 5825 MHz was the worst)

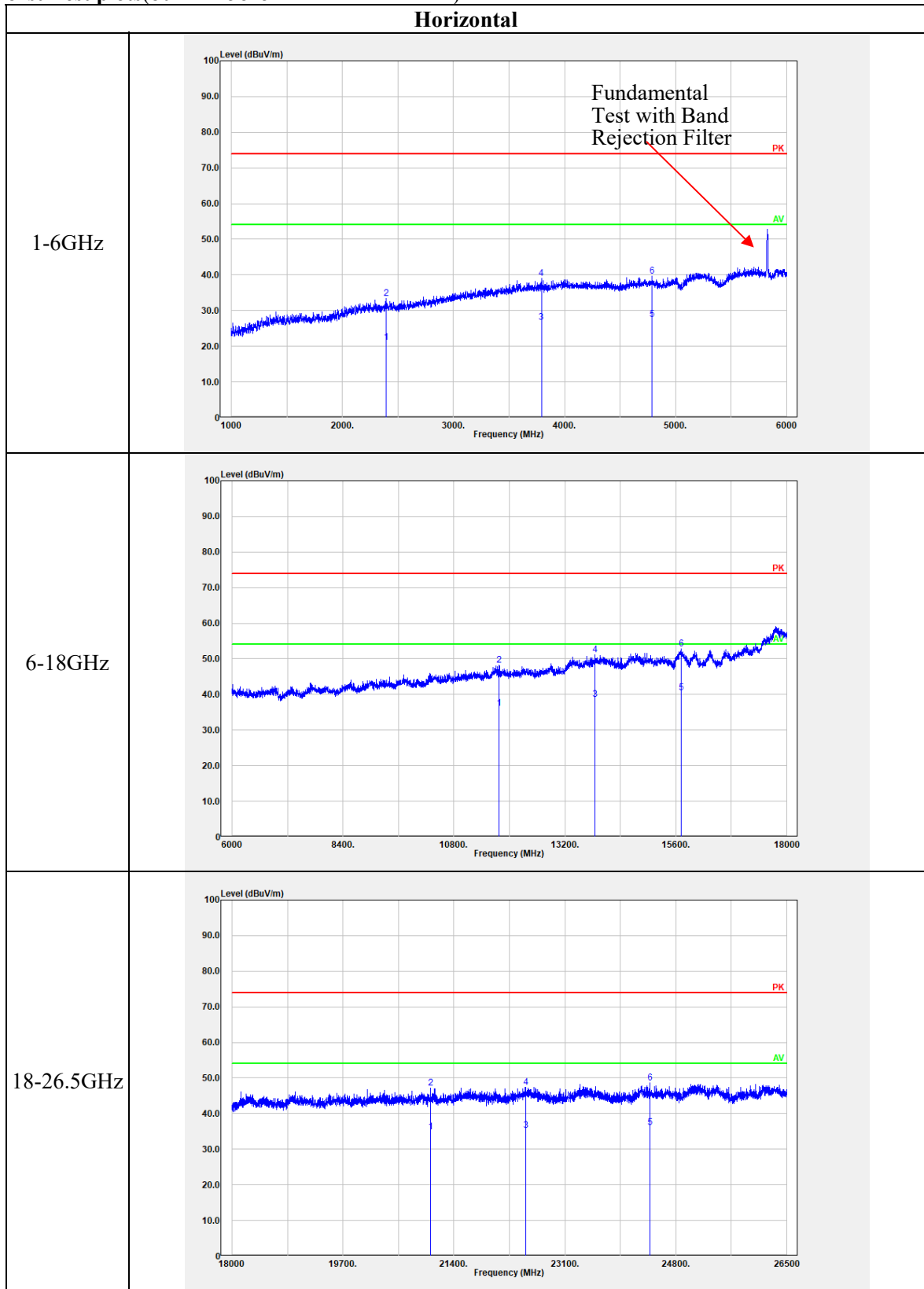

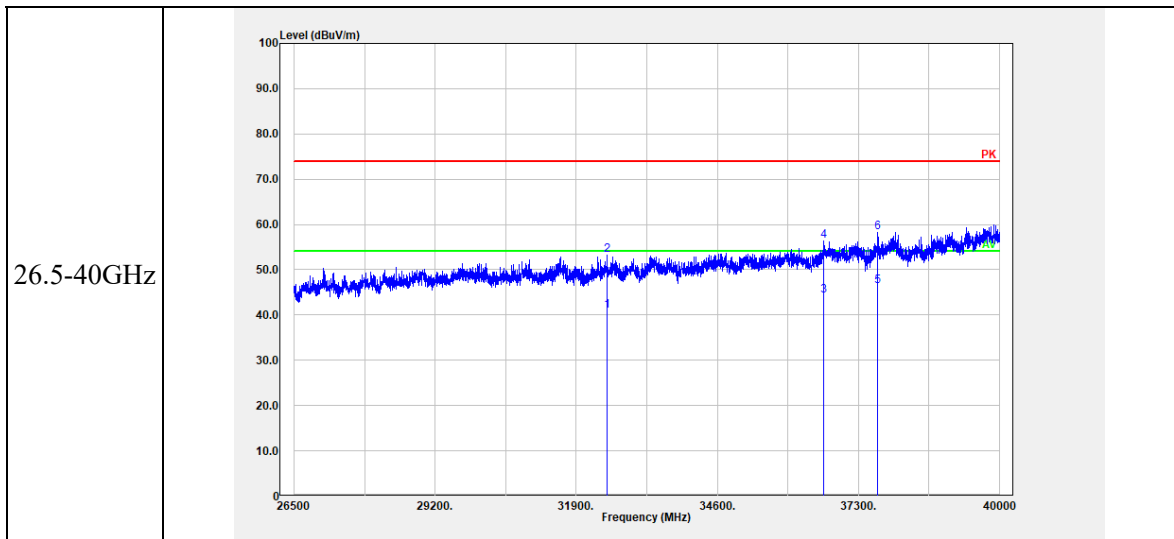

Vertical

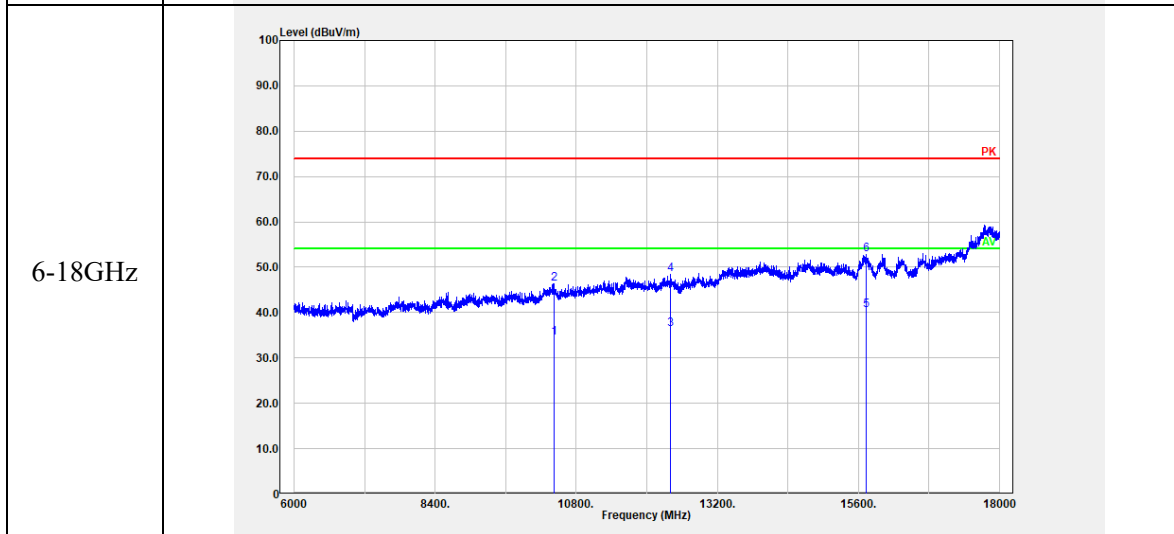
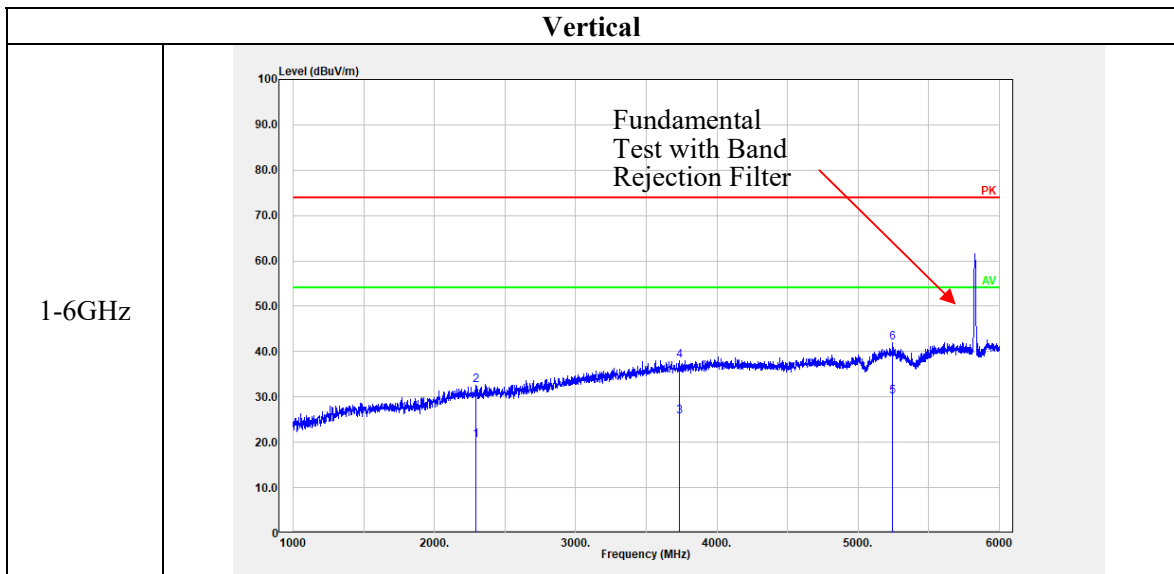

18-26.5GHz

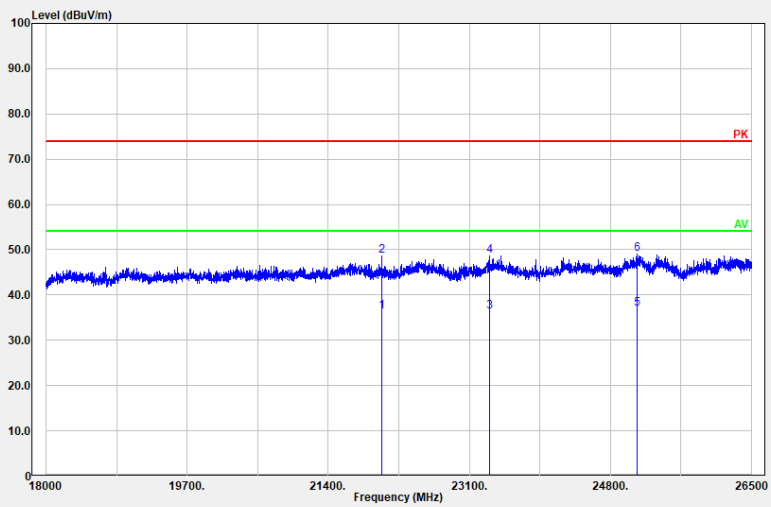

26.5-40GHz

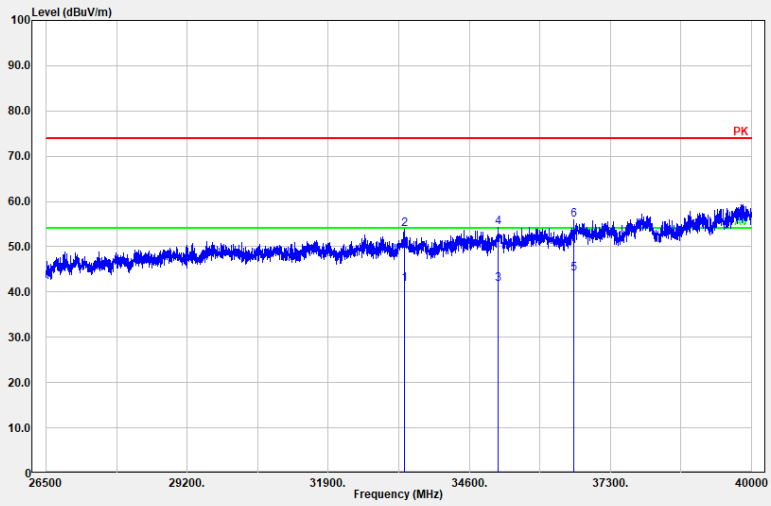

4.3 26dB attenuated below the channel power:

Serial Number:	CR22070077-RF-S1	Test Date:	2022-08-09~2022-11-04
Test Site:	RF	Test Mode:	Transmitting
Tester:	Ada Yan	Test Result:	Pass

Environmental Conditions:

Temperature: (°C)	25.3~26.1	Relative Humidity: (%)	60~65	ATM Pressure: (kPa)	100.2~101
----------------------	-----------	------------------------------	-------	------------------------	-----------

Test Equipment List and Details:

Manufacturer	Description	Model	Serial Number	Calibration Date	Calibration Due Date
R&S	Spectrum Analyzer	FSU26	200256	2022-07-15	2023-07-14
zhuoxiang	Coaxial Cable	SMA-178	211002	Each time	N/A

* Statement of Traceability: China Certification ICT Co., Ltd (Dongguan) attests that all calibrations have been performed, traceable to National Primary Standards and International System of Units (SI).

Test Data:

Note: the requirement is for 5150-5250 MHz band. The channel power please refer to the power test result in section 4.5.

5150-5250MHz:

26dB attenuated below the channel power

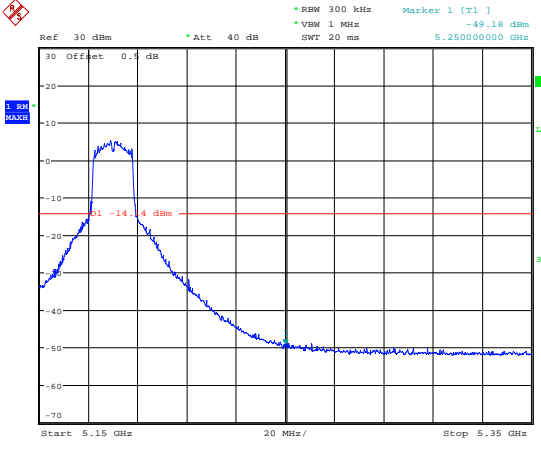
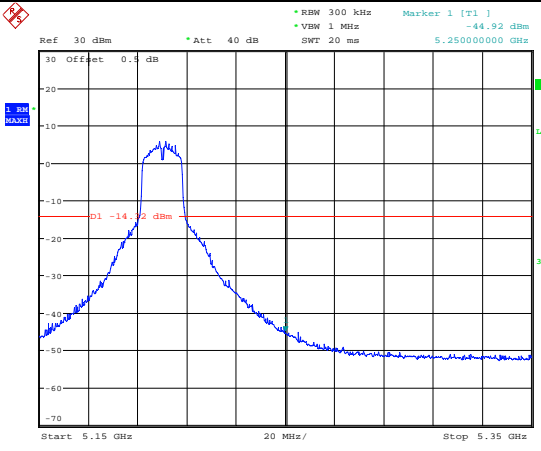
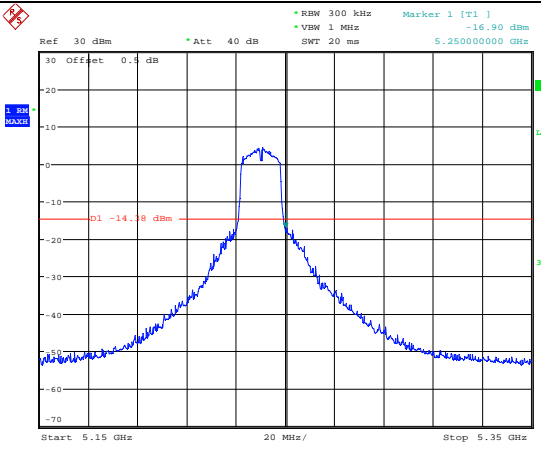
<p>802.11a Lowest Channel</p>	 <p>Ref 30 dBm * Att 40 dB RBW 300 kHz Marker 1 [T1] -49.18 dBm * VSW 1 MHz 5.250000000 GHz SWT 20 ms</p> <p>30 Offset 0.4 dB -20 -10 0 -10 -20 -30 -40 -50 -60 -70</p> <p>Start 5.15 GHz 20 MHz/ Stop 5.35 GHz</p> <p>Date: 4.NOV.2022 17:03:42</p>
<p>802.11a Middle Channel</p>	 <p>Ref 30 dBm * Att 40 dB RBW 300 kHz Marker 1 [T1] -44.92 dBm * VSW 1 MHz 5.250000000 GHz SWT 20 ms</p> <p>30 Offset 0.4 dB -20 -10 0 -10 -20 -30 -40 -50 -60 -70</p> <p>Start 5.15 GHz 20 MHz/ Stop 5.35 GHz</p> <p>Date: 4.NOV.2022 17:08:07</p>
<p>802.11a Highest Channel</p>	 <p>Ref 30 dBm * Att 40 dB RBW 300 kHz Marker 1 [T1] -16.90 dBm * VSW 1 MHz 5.250000000 GHz SWT 20 ms</p> <p>30 Offset 0.4 dB -20 -10 0 -10 -20 -30 -40 -50 -60 -70</p> <p>Start 5.15 GHz 20 MHz/ Stop 5.35 GHz</p> <p>Date: 4.NOV.2022 17:10:12</p>

26dB attenuated below the channel power

802.11n ht20
Lowest Channel

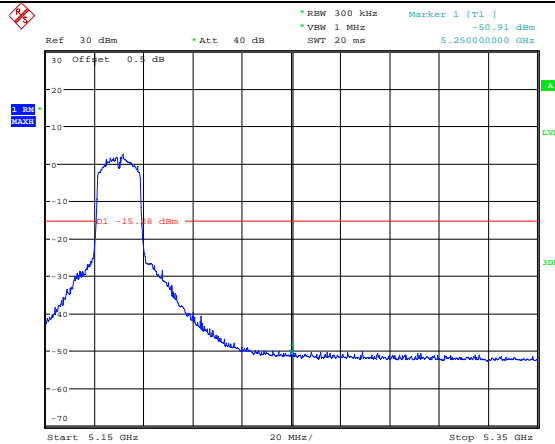

Date: 4.NOV.2022 17:15:19

802.11n ht20
Middle Channel

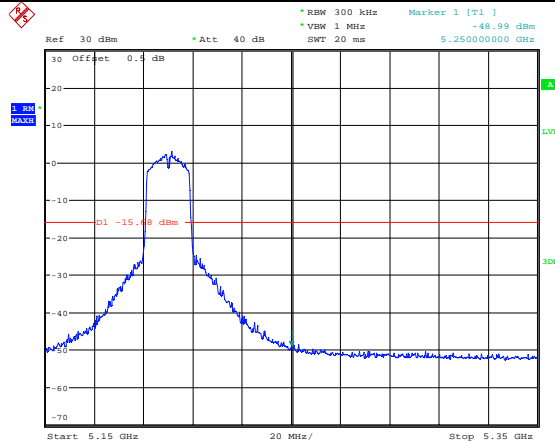

Date: 4.NOV.2022 17:14:16

802.11n ht20
Highest Channel

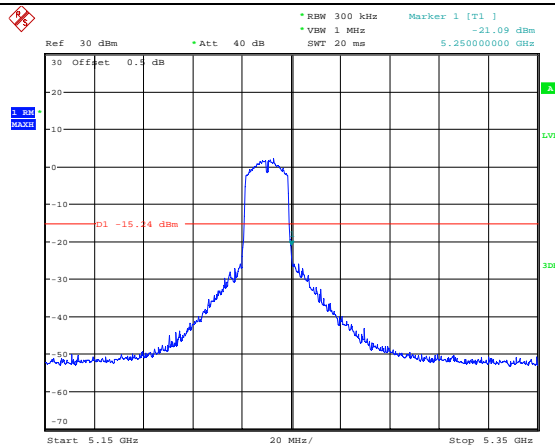

Date: 4.NOV.2022 17:13:08

26dB attenuated below the channel power

802.11n ht40
Lowest Channel

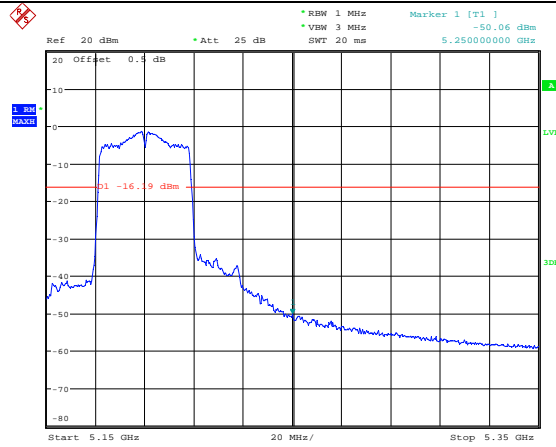

Date: 9.AUG.2022 16:53:48

802.11n ht40
Highest Channel

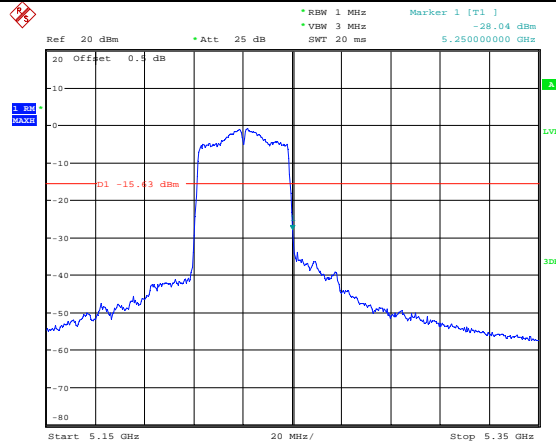

Date: 9.AUG.2022 16:55:03

26dB attenuated below the channel power

802.11ac vht80
Highest Channel

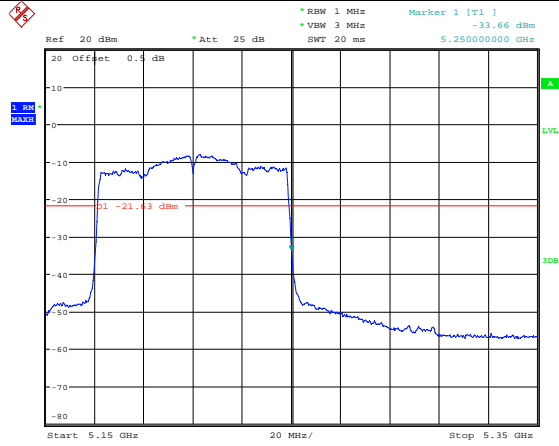

4.4 Emission Bandwidth:

Serial Number:	CR22070077-RF-S1	Test Date:	2022-08-09
Test Site:	RF	Test Mode:	Transmitting
Tester:	Ada Yan	Test Result:	Pass

Environmental Conditions:

Temperature: (°C)	26.1	Relative Humidity: (%)	60	ATM Pressure: (kPa)	100.2
----------------------	------	------------------------------	----	------------------------	-------

Test Equipment List and Details:

Manufacturer	Description	Model	Serial Number	Calibration Date	Calibration Due Date
R&S	Spectrum Analyzer	FSU26	200256	2022-07-15	2023-07-14
zhuoxiang	Coaxial Cable	SMA-178	211002	Each time	N/A

** Statement of Traceability: China Certification ICT Co., Ltd (Dongguan) attests that all calibrations have been performed, traceable to National Primary Standards and International System of Units (SI).*

Test Data:

5150-5250 MHz:

Test Modes	Test Frequency (MHz)	26 dB Bandwidth (MHz)	99% Occupied Bandwidth (MHz)
802.11a	5180	20.80	16.56
	5200	20.96	16.64
	5240	20.72	16.56
802.11n ht20	5180	21.36	17.84
	5200	21.36	17.92
	5240	21.44	17.92
802.11n ht40	5190	39.04	36.32
	5230	39.04	36.32
802.11ac vht80	5210	81.60	75.84
Note: The 99% Occupied Bandwidth have not fall into the band 5150-5250MHz			

5725-5850 MHz:

Test Modes	Test Frequency (MHz)	6 dB Bandwidth (MHz)	99% Occupied Bandwidth (MHz)
802.11a	5745	15.60	16.56
	5785	15.76	16.64
	5825	15.76	16.72
802.11n ht20	5745	16.96	17.92
	5785	17.68	18.00
	5825	17.68	18.00
802.11n ht40	5755	35.68	36.32
	5795	36.16	36.32
802.11ac vht80	5775	76.16	75.52
Note:6dB Emission Bandwidth Limit: ≥ 0.5 MHz The 99% Occupied Bandwidth have not fall into the band 5470-5725MHz			

5150-5250MHz:

26dB Emission Bandwidth	
802.11a Lowest Channel	<p>Ref: 20 dBm, Att: 25 dB, RBW: 300 kHz, VSW: 1 MHz, SWT: 20 ms, Delta 1 [T1]: 0.33 dB, Marker 1 [T1]: -21.11 dBm, 5.169680000 GHz</p> <p>D1: 4.89 dBm, D2: -11.77 dBm</p> <p>Center: 5.18 GHz, Span: 40 MHz</p> <p>Date: 9.AUG.2022 15:40:37</p>
802.11a Middle Channel	<p>Ref: 20 dBm, Att: 25 dB, RBW: 300 kHz, VSW: 1 MHz, SWT: 20 ms, Delta 1 [T1]: -0.05 dB, Marker 1 [T1]: -21.59 dBm, 5.189680000 GHz</p> <p>D1: 4.4 dBm, D2: -11.77 dBm</p> <p>Center: 5.2 GHz, Span: 40 MHz</p> <p>Date: 9.AUG.2022 15:46:49</p>
802.11a Highest Channel	<p>Ref: 20 dBm, Att: 25 dB, RBW: 300 kHz, VSW: 1 MHz, SWT: 20 ms, Delta 1 [T1]: 0.17 dB, Marker 1 [T1]: -21.64 dBm, 5.229760000 GHz</p> <p>D1: 5.23 dBm, D2: -10.77 dBm</p> <p>Center: 5.24 GHz, Span: 40 MHz</p> <p>Date: 9.AUG.2022 15:49:42</p>

6dB Emission Bandwidth

<p>802.11n ht20 Lowest Channel</p>	<p>Date: 9.AUG.2022 16:24:23</p>
<p>802.11n ht20 Middle Channel</p>	<p>Date: 9.AUG.2022 16:25:29</p>
<p>802.11n ht20 Highest Channel</p>	<p>Date: 9.AUG.2022 16:26:36</p>

6dB Emission Bandwidth	
802.11n ht40 Lowest Channel	<p> * RBW 300 kHz Delta 1 [T1] 1.00 dB * VBW 1 MHz * Att 25 dB 39.040000000 MHz * SWT 20 ms Ref 20 dBm Offset 0.4 dB Marker 1 [T1] -24.74 dBm D1 3.54 dBm 5.17048000 GHz D2 -34.47 dBm Center 5.19 GHz 8 MHz/ Span 80 MHz </p> <p>Date: 9.AUG.2022 16:30:49</p>
802.11n ht40 Highest Channel	<p> * RBW 300 kHz Delta 1 [T1] 0.62 dB * VBW 1 MHz * Att 25 dB 39.040000000 MHz * SWT 20 ms Ref 20 dBm Offset 0.4 dB Marker 1 [T1] -24.65 dBm D1 1.86 dBm 5.21048000 GHz D2 -34.17 dBm Center 5.23 GHz 8 MHz/ Span 80 MHz </p> <p>Date: 9.AUG.2022 16:35:17</p>
802.11ac vht80 Middle Channel	<p> * RBW 1 MHz Delta 1 [T1] -0.75 dB * VBW 3 MHz * Att 25 dB 81.600000000 MHz * SWT 20 ms Ref 20 dBm Offset 0.4 dB Marker 1 [T1] -24.25 dBm D1 0.04 dBm 5.16936000 GHz D2 -36.09 dBm Center 5.21 GHz 16 MHz/ Span 160 MHz </p> <p>Date: 9.AUG.2022 16:37:40</p>

5150-5250MHz:

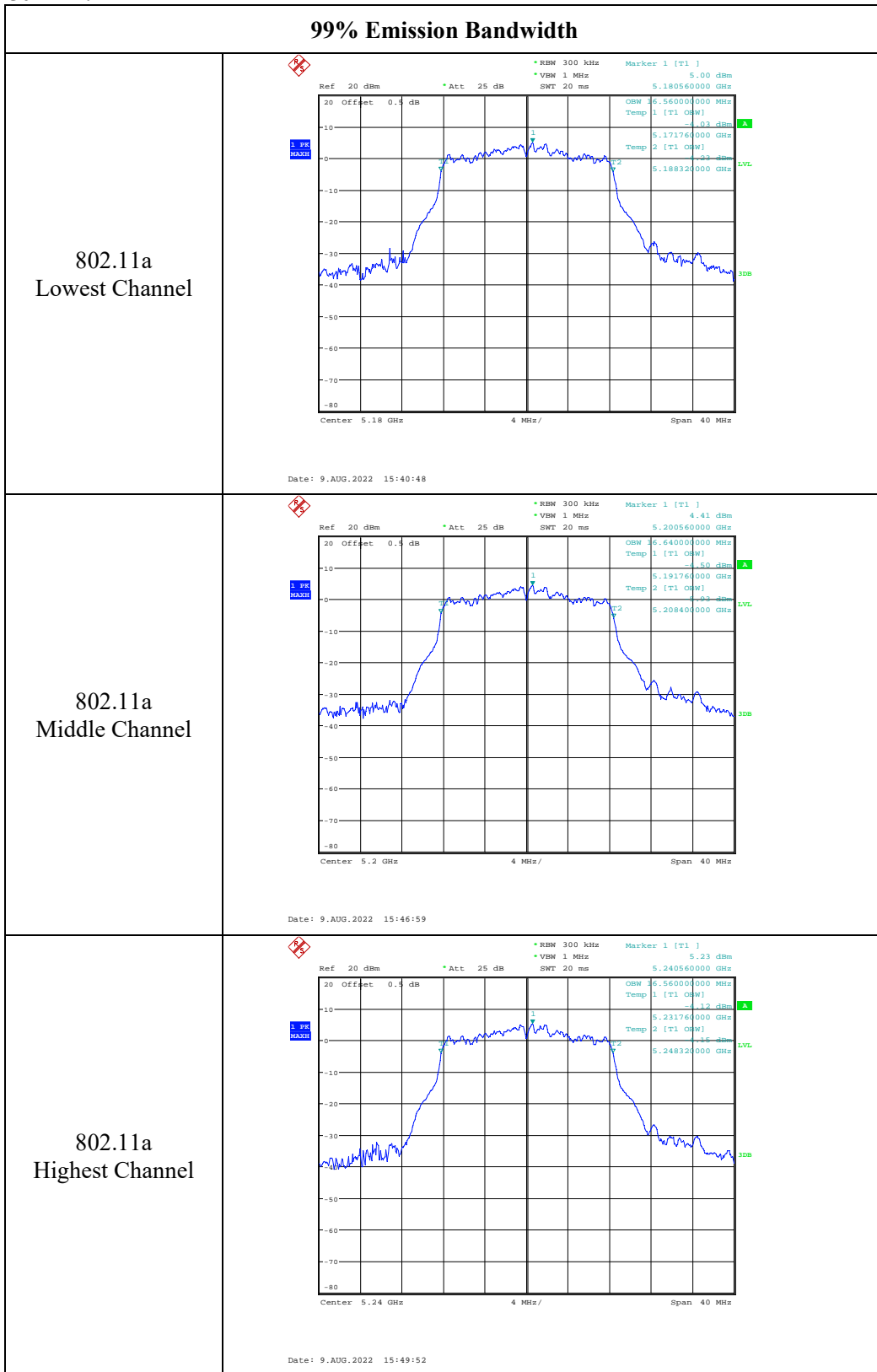

99% Emission Bandwidth

<p>802.11n ht20 Lowest Channel</p>	<p>Ref 20 dBm * Att 25 dB * RBW 300 kHz Marker 1 [T1] 4.97 dBm * VBW 1 MHz 5.179520000 GHz SWT 20 ms</p> <p>20 Offset 0.4 dB</p> <p>OSW 7.84000000 MHz Temp 1 [T1] OSW] -55.5 dBm 5.171120000 GHz Temp 2 [T1] OSW] -42.3 dBm 5.188960000 GHz</p> <p>Center 5.18 GHz 4 MHz/ Span 40 MHz</p> <p>Date: 9.AUG.2022 16:24:41</p>
<p>802.11n ht20 Middle Channel</p>	<p>Ref 20 dBm * Att 25 dB * RBW 300 kHz Marker 1 [T1] 3.89 dBm * VBW 1 MHz 5.199280000 GHz SWT 20 ms</p> <p>20 Offset 0.4 dB</p> <p>OSW 7.92000000 MHz Temp 1 [T1] OSW] -24.24 dBm 5.191120000 GHz Temp 2 [T1] OSW] -24.4 dBm 5.209040000 GHz</p> <p>Center 5.2 GHz 4 MHz/ Span 40 MHz</p> <p>Date: 9.AUG.2022 16:25:45</p>
<p>802.11n ht20 Highest Channel</p>	<p>Ref 20 dBm * Att 25 dB * RBW 300 kHz Marker 1 [T1] 4.68 dBm * VBW 1 MHz 5.241360000 GHz SWT 20 ms</p> <p>20 Offset 0.4 dB</p> <p>OSW 7.92000000 MHz Temp 1 [T1] OSW] -12.12 dBm 5.231120000 GHz Temp 2 [T1] OSW] -28.3 dBm 5.249040000 GHz</p> <p>Center 5.24 GHz 4 MHz/ Span 40 MHz</p> <p>Date: 9.AUG.2022 16:26:52</p>

99% Emission Bandwidth

<p>802.11n ht40 Lowest Channel</p>	<p>Date: 9.AUG.2022 16:31:06</p>
<p>802.11n ht40 Highest Channel</p>	<p>Date: 9.AUG.2022 16:35:33</p>
<p>802.11ac vht80 Middle Channel</p>	<p>Date: 9.AUG.2022 16:37:56</p>

5725-5850MHz:

6dB Emission Bandwidth	
802.11a Lowest Channel	<p>Date: 9.AUG.2022 19:26:36</p>
802.11a Middle Channel	<p>Date: 9.AUG.2022 19:26:00</p>
802.11a Highest Channel	<p>Date: 9.AUG.2022 19:25:15</p>

6dB Emission Bandwidth	
802.11n ht20 Lowest Channel	<p style="text-align: center;">Date: 9.AUG.2022 19:27:00</p>
802.11n ht20 Middle Channel	<p style="text-align: center;">Date: 9.AUG.2022 19:27:28</p>
802.11n ht20 Highest Channel	<p style="text-align: center;">Date: 9.AUG.2022 19:27:51</p>

6dB Emission Bandwidth	
802.11n ht40 Lowest Channel	<p style="text-align: center;">Date: 9.AUG.2022 19:24:42</p>
802.11n ht40 Highest Channel	<p style="text-align: center;">Date: 9.AUG.2022 19:24:10</p>
802.11ac vht80 Middle Channel	<p style="text-align: center;">Date: 9.AUG.2022 19:23:22</p>

5725-5850MHz:

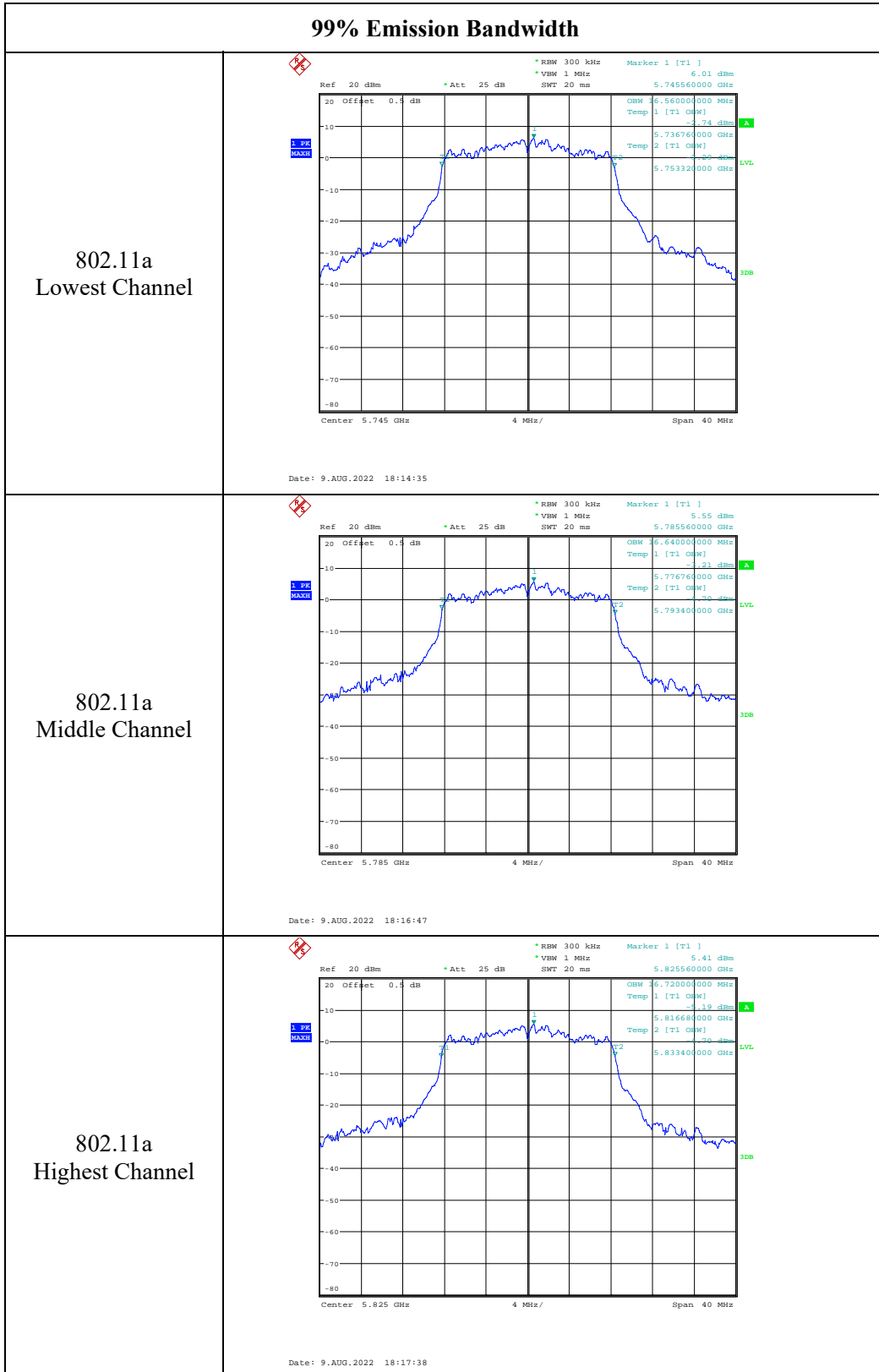

99% Emission Bandwidth

<p>802.11n ht20 Lowest Channel</p>	<p>Ref 20 dBm *Att 25 dB *RBW 300 kHz Marker 1 [T1] 5.95 dBm *VBW 1 MHz 5.744440000 GHz *SWT 20 ms</p> <p>20 Offset 0.4 dB</p> <p>1. Pk MAX</p> <p>OSW 17.920000000 MHz Temp 1 [T1] OSW] -1.86 dBm 5.736120000 GHz Temp 2 [T1 OSW] -1.35 dBm 5.754040000 GHz</p> <p>Center 5.745 GHz 4 MHz/ Span 40 MHz</p> <p>Date: 9.AUG.2022 18:20:12</p>
<p>802.11n ht20 Middle Channel</p>	<p>Ref 20 dBm *Att 25 dB *RBW 300 kHz Marker 1 [T1] 5.24 dBm *VBW 1 MHz 5.784520000 GHz *SWT 20 ms</p> <p>20 Offset 0.4 dB</p> <p>1. Pk MAX</p> <p>OSW 18.000000000 MHz Temp 1 [T1 OSW] -1.73 dBm 5.776040000 GHz Temp 2 [T1 OSW] -1.24 dBm 5.794040000 GHz</p> <p>Center 5.785 GHz 4 MHz/ Span 40 MHz</p> <p>Date: 9.AUG.2022 18:19:21</p>
<p>802.11n ht20 Highest Channel</p>	<p>Ref 20 dBm *Att 25 dB *RBW 300 kHz Marker 1 [T1] 5.01 dBm *VBW 1 MHz 5.823320000 GHz *SWT 20 ms</p> <p>20 Offset 0.4 dB</p> <p>1. Pk MAX</p> <p>OSW 18.000000000 MHz Temp 1 [T1 OSW] -1.64 dBm 5.816040000 GHz Temp 2 [T1 OSW] -1.88 dBm 5.834040000 GHz</p> <p>Center 5.825 GHz 4 MHz/ Span 40 MHz</p> <p>Date: 9.AUG.2022 18:18:32</p>

99% Emission Bandwidth

802.11n ht40
Lowest Channel

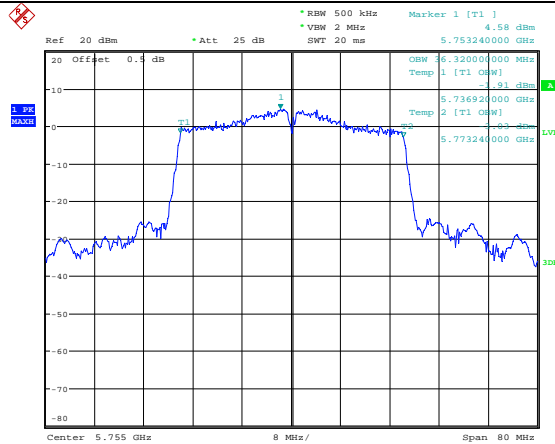

Date: 9.AUG.2022 18:22:27

802.11n ht40
Highest Channel

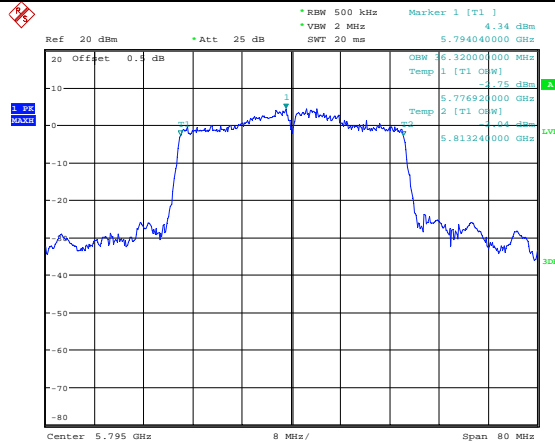

Date: 9.AUG.2022 18:23:08

802.11ac vht80
Middle Channel

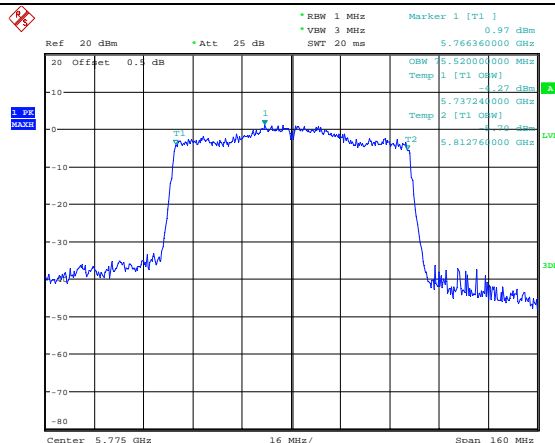

Date: 9.AUG.2022 18:24:36

4.5 Maximum Conducted Output Power:

Serial Number:	CR22070077-RF-S1	Test Date:	2022-08-09
Test Site:	RF	Test Mode:	Transmitting
Tester:	Ada Yan	Test Result:	Pass

Environmental Conditions:

Temperature: (°C)	26.1	Relative Humidity: (%)	60	ATM Pressure: (kPa)	100.2
----------------------	------	------------------------------	----	------------------------	-------

Test Equipment List and Details:

Manufacturer	Description	Model	Serial Number	Calibration Date	Calibration Due Date
eastsheep	Coaxial Attenuator	2W-SMA-JK-18G	21060301	2022-08-07	2023-08-06
zhuoxiang	Coaxial Cable	SMA-178	211002	Each time	N/A
Agilent	USB Wideband Power Sensor	U2021XA	MY54080015	2022-07-15	2023-07-14

* Statement of Traceability: China Certification ICT Co., Ltd (Dongguan) attests that all calibrations have been performed, traceable to National Primary Standards and International System of Units (SI).

Test Data:

5150-5250 MHz:

Test Modes	Test Frequency (MHz)	Max. Conducted Average Output Power(dBm)		EIRP (dBm)	
		Result	FCC Limit	Result	RSS-247 Limit
802.11a	5180	11.86	30	14.98	22.19
	5200	11.68	30	14.80	22.21
	5240	11.62	30	14.74	22.19
802.11n ht20	5180	10.72	30	13.84	22.51
	5200	10.32	30	13.44	22.53
	5240	10.76	30	13.88	22.53
802.11n ht40	5190	9.81	30	12.93	23.00
	5230	10.37	30	13.49	23.00
802.11ac vht80	5210	4.37	30	7.49	23.00
Antenna Gain:	3.12	dB _i	Maximum EIRP:	14.98	dB _m

Note:

The device is a indoor AP.

The duty cycle factor has been calculated into the test data.

5725-5850 MHz:

Test Modes	Test Frequency (MHz)	Max. Conducted Average Output Power(dBm)	
		Result	Limit
802.11a	5745	12.56	30
	5785	12.15	30
	5825	12.49	30
802.11n ht20	5745	11.90	30
	5785	11.25	30
	5825	11.47	30
802.11n ht40	5755	11.57	30
	5795	11.52	30
802.11ac vht80	5775	5.81	30
Antenna Gain:	4.03	dBi	
Note: The duty cycle factor has been calculated into the test data.			

4.6 Maximum power spectral density:

Serial Number:	CR22070077-RF-S1	Test Date:	2022-08-09
Test Site:	RF	Test Mode:	Transmitting
Tester:	Ada Yan	Test Result:	Pass

Environmental Conditions:

Temperature: (°C)	26.1	Relative Humidity: (%)	60	ATM Pressure: (kPa)	100.2
----------------------	------	------------------------------	----	------------------------	-------

Test Equipment List and Details:

Manufacturer	Description	Model	Serial Number	Calibration Date	Calibration Due Date
R&S	Spectrum Analyzer	FSU26	200256	2022-07-15	2023-07-14
zhuoxiang	Coaxial Cable	SMA-178	211002	Each time	N/A

* Statement of Traceability: China Certification ICT Co., Ltd (Dongguan) attests that all calibrations have been performed, traceable to National Primary Standards and International System of Units (SI).

Test Data:

5150-5250 MHz:

Test Modes	Test Frequency (MHz)	Maximum Power Spectral Density(dBm/MHz)		Maximum EIRP Power Spectral Density(dBm/MHz)	
		Result	FCC Limit	Result	RSS-247 Limit
802.11a	5180	2.86	17	5.98	10
	5200	2.30	17	5.42	10
	5240	3.08	17	6.2	10
802.11n ht20	5180	2.26	17	5.38	10
	5200	1.49	17	4.61	10
	5240	1.89	17	5.01	10
802.11n ht40	5190	-1.51	17	1.61	10
	5230	-0.92	17	2.2	10
802.11ac vht80	5210	-8.36	17	-5.24	10

Note:

The device is a indoor AP.

Method SA-3 in KDB 789033 D02 General UNII Test Procedures New Rules v02r01 was used for PSD test.

5725-5850 MHz:

Test Modes	Test Frequency (MHz)	Reading (dBm/300kHz)	Maximum Power Spectral Density (dBm/500kHz)	
			Result	Limit
802.11a	5745	0.14	2.36	30
	5785	-0.31	1.91	30
	5825	-0.44	1.78	30
802.11n ht20	5745	-0.92	1.30	30
	5785	-1.63	0.59	30
	5825	-1.57	0.65	30
802.11n ht40	5755	-4.32	-2.10	30
	5795	-5.09	-2.87	30
802.11ac vht80	5775	-11.57	-9.35	30

Note:
Method SA-3 in KDB 789033 D02 General UNII Test Procedures New Rules v02r01 was used for PSD test.
If measurement bandwidth of Maximum PSD is specified in 500 kHz, add $10\log(500\text{kHz}/\text{RBW})$ to the measured result, whereas RBW (< 500 kHz) is the reduced resolution bandwidth of the spectrum analyzer set during measurement

5150-5250MHz

Maximum power spectral density

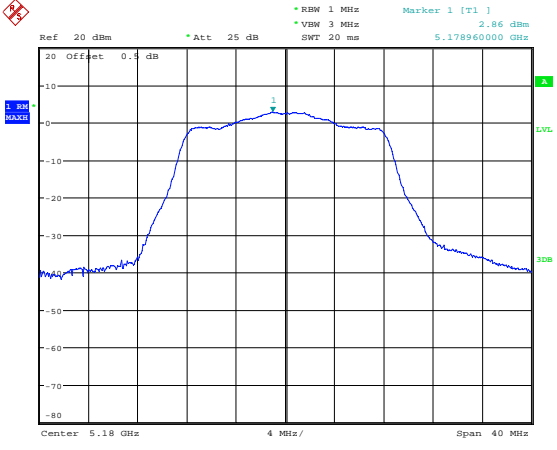
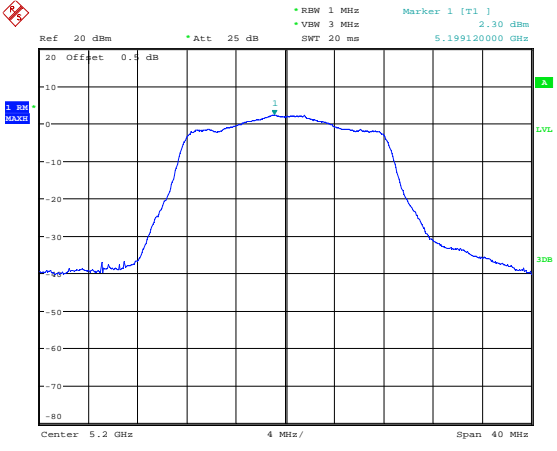
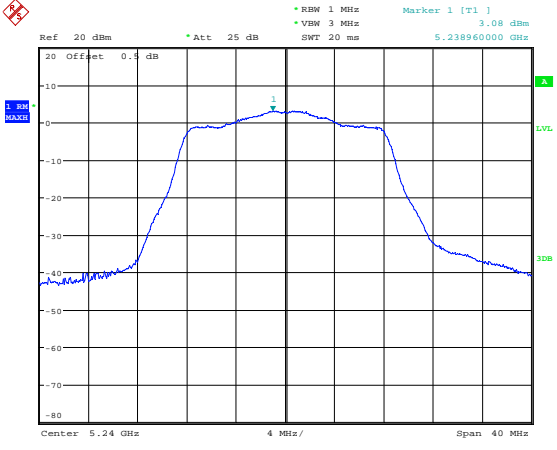
<p>802.11a Lowest Channel</p>	 <p>Ref 20 dBm * Att 25 dB * RBW 1 MHz * VBW 3 MHz * SWT 20 ms * Marker 1 [T1] 2.86 dBm 5.178960000 GHz</p> <p>20 Offset 0.4 dB</p> <p>Center 5.18 GHz 4 MHz/ Span 40 MHz</p> <p>Date: 9.AUG.2022 15:41:00</p>
<p>802.11a Middle Channel</p>	 <p>Ref 20 dBm * Att 25 dB * RBW 1 MHz * VBW 3 MHz * SWT 20 ms * Marker 1 [T1] 2.30 dBm 5.199120000 GHz</p> <p>20 Offset 0.4 dB</p> <p>Center 5.2 GHz 4 MHz/ Span 40 MHz</p> <p>Date: 9.AUG.2022 15:47:07</p>
<p>802.11a Highest Channel</p>	 <p>Ref 20 dBm * Att 25 dB * RBW 1 MHz * VBW 3 MHz * SWT 20 ms * Marker 1 [T1] 3.08 dBm 5.228960000 GHz</p> <p>20 Offset 0.4 dB</p> <p>Center 5.24 GHz 4 MHz/ Span 40 MHz</p> <p>Date: 9.AUG.2022 15:50:01</p>

Maximum power spectral density

<p>802.11n ht20 Lowest Channel</p>	<p>Ref 20 dBm * Att 25 dB * RBW 1 MHz * VBW 3 MHz * Marker 1 [T1] 2.26 dBm SWT 20 ms 5.179840000 GHz</p> <p>20 Offset 0.4 dB</p> <p>1.99360000</p> <p>Center 5.18 GHz 4 MHz/ Span 40 MHz</p> <p>Date: 9.AUG.2022 16:24:53</p>
<p>802.11n ht20 Middle Channel</p>	<p>Ref 20 dBm * Att 25 dB * RBW 1 MHz * VBW 3 MHz * Marker 1 [T1] 1.49 dBm SWT 20 ms 5.199360000 GHz</p> <p>20 Offset 0.4 dB</p> <p>1.99360000</p> <p>Center 5.2 GHz 4 MHz/ Span 40 MHz</p> <p>Date: 9.AUG.2022 16:25:57</p>
<p>802.11n ht20 Highest Channel</p>	<p>Ref 20 dBm * Att 25 dB * RBW 1 MHz * VBW 3 MHz * Marker 1 [T1] 1.89 dBm SWT 20 ms 5.239040000 GHz</p> <p>20 Offset 0.4 dB</p> <p>1.99040000</p> <p>Center 5.24 GHz 4 MHz/ Span 40 MHz</p> <p>Date: 9.AUG.2022 16:27:00</p>

Maximum power spectral density

<p>802.11n ht40 Lowest Channel</p>	<p>Ref: 20 dBm *Att: 25 dB *RBW: 1 MHz Marker 1 [T1] -1.51 dBm *VBW: 3 MHz *SWT: 20 ms 5.198000000 GHz</p> <p>Center: 5.19 GHz 8 MHz/ Span: 80 MHz</p> <p>Date: 9.AUG.2022 16:31:14</p>
<p>802.11n ht40 Highest Channel</p>	<p>Ref: 20 dBm *Att: 25 dB *RBW: 1 MHz Marker 1 [T1] -0.92 dBm *VBW: 3 MHz *SWT: 20 ms 5.231440000 GHz</p> <p>Center: 5.23 GHz 8 MHz/ Span: 80 MHz</p> <p>Date: 9.AUG.2022 16:35:45</p>
<p>802.11 ac 80 Middle Channel</p>	<p>Ref: 20 dBm *Att: 25 dB *RBW: 1 MHz Marker 1 [T1] -8.36 dBm *VBW: 3 MHz *SWT: 20 ms 5.212560000 GHz</p> <p>Center: 5.21 GHz 16 MHz/ Span: 160 MHz</p> <p>Date: 9.AUG.2022 16:38:04</p>

5725-5850MHz

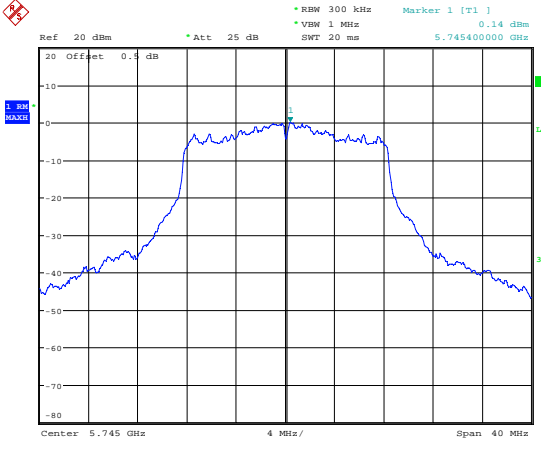
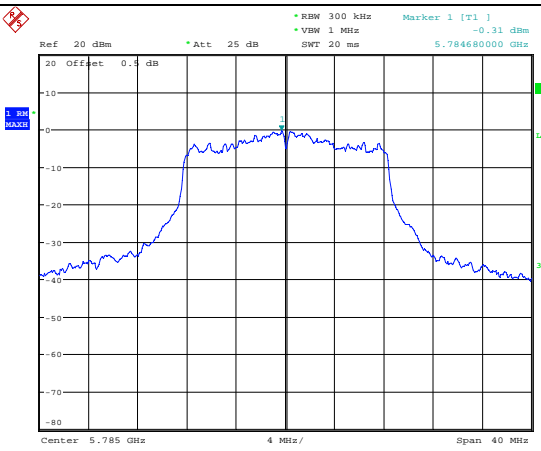
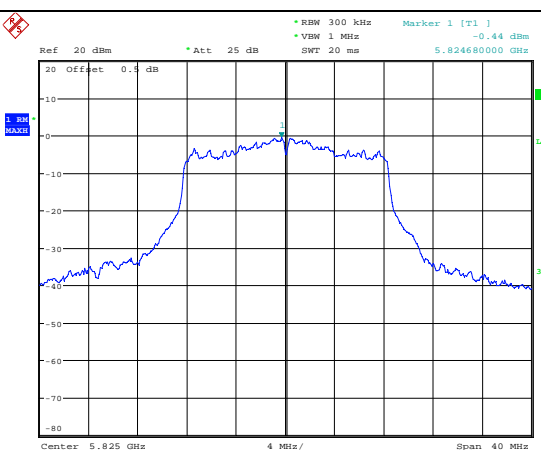
Maximum power spectral density	
802.11a Lowest Channel	 <p>Ref: 20 dBm, Att: 25 dB, RBW: 300 kHz, VSW: 1 MHz, SWT: 20 ms, Marker 1 [T1]: 5.745400000 GHz, 0.14 dBm</p> <p>Center: 5.745 GHz, 4 MHz/, Span: 40 MHz</p> <p>Date: 9.AUG.2022 18:14:45</p>
802.11a Middle Channel	 <p>Ref: 20 dBm, Att: 25 dB, RBW: 300 kHz, VSW: 1 MHz, SWT: 20 ms, Marker 1 [T1]: 5.784680000 GHz, -0.31 dBm</p> <p>Center: 5.785 GHz, 4 MHz/, Span: 40 MHz</p> <p>Date: 9.AUG.2022 18:16:58</p>
802.11a Highest Channel	 <p>Ref: 20 dBm, Att: 25 dB, RBW: 300 kHz, VSW: 1 MHz, SWT: 20 ms, Marker 1 [T1]: 5.824680000 GHz, -0.44 dBm</p> <p>Center: 5.825 GHz, 4 MHz/, Span: 40 MHz</p> <p>Date: 9.AUG.2022 18:17:48</p>

Maximum power spectral density

<p>802.11n ht20 Lowest Channel</p>	<p>Ref: 20 dBm *Att: 25 dB *RBW: 300 kHz Marker 1 [T1] -0.92 dBm *VBW: 1 MHz *SWT: 20 ms 5.744580000 GHz</p> <p>Center: 5.745 GHz 4 MHz/ Span: 40 MHz</p> <p>Date: 9.AUG.2022 18:20:25</p>
<p>802.11n ht20 Middle Channel</p>	<p>Ref: 20 dBm *Att: 25 dB *RBW: 300 kHz Marker 1 [T1] -1.63 dBm *VBW: 1 MHz *SWT: 20 ms 5.784360000 GHz</p> <p>Center: 5.785 GHz 4 MHz/ Span: 40 MHz</p> <p>Date: 9.AUG.2022 18:19:34</p>
<p>802.11n ht20 Highest Channel</p>	<p>Ref: 20 dBm *Att: 25 dB *RBW: 300 kHz Marker 1 [T1] -1.57 dBm *VBW: 1 MHz *SWT: 20 ms 5.825960000 GHz</p> <p>Center: 5.825 GHz 4 MHz/ Span: 40 MHz</p> <p>Date: 9.AUG.2022 18:18:45</p>

Maximum power spectral density

<p>802.11n ht40 Lowest Channel</p>	<p>Ref 20 dBm * Att 25 dB * RBW 300 kHz Marker 1 [T1] -4.32 dBm * VBW 1 MHz * SWT 20 ms 5.755560000 GHz</p> <p>Center 5.755 GHz 8 MHz/ Span 80 MHz</p> <p>Date: 9.AUG.2022 18:22:37</p>
<p>802.11n ht40 Highest Channel</p>	<p>Ref 20 dBm * Att 25 dB * RBW 300 kHz Marker 1 [T1] -5.09 dBm * VBW 1 MHz * SWT 20 ms 5.796920000 GHz</p> <p>Center 5.795 GHz 8 MHz/ Span 80 MHz</p> <p>Date: 9.AUG.2022 18:23:21</p>
<p>802.11 ac 80 Middle Channel</p>	<p>Ref 20 dBm * Att 25 dB * RBW 300 kHz Marker 1 [T1] -11.57 dBm * VBW 1 MHz * SWT 20 ms 5.767640000 GHz</p> <p>Center 5.775 GHz 16 MHz/ Span 160 MHz</p> <p>Date: 9.AUG.2022 18:24:49</p>

4.7 Duty Cycle:

Serial Number:	CR22070077-RF-S1	Test Date:	2022-08-09
Test Site:	RF	Test Mode:	Transmitting
Tester:	Ada Yan	Test Result:	N/A

Environmental Conditions:

Temperature: (°C)	26.1	Relative Humidity: (%)	60	ATM Pressure: (kPa)	100.2
----------------------	------	---------------------------	----	------------------------	-------

Test Equipment List and Details:

Manufacturer	Description	Model	Serial Number	Calibration Date	Calibration Due Date
R&S	Spectrum Analyzer	FSU26	200256	2022-07-15	2023-07-14
zhuoxiang	Coaxial Cable	SMA-178	211002	Each time	N/A

* Statement of Traceability: China Certification ICT Co., Ltd (Dongguan) attests that all calibrations have been performed, traceable to National Primary Standards and International System of Units (SI).

Test Data:

Test Modes	Ton (ms)	Ton+off (ms)	Duty cycle (%)
802.11a	0.187	0.221	84.62
802.11n ht20	0.169	0.205	82.44
802.11n ht40	0.108	0.143	75.52
802.11ac vht80	0.068	0.105	64.76

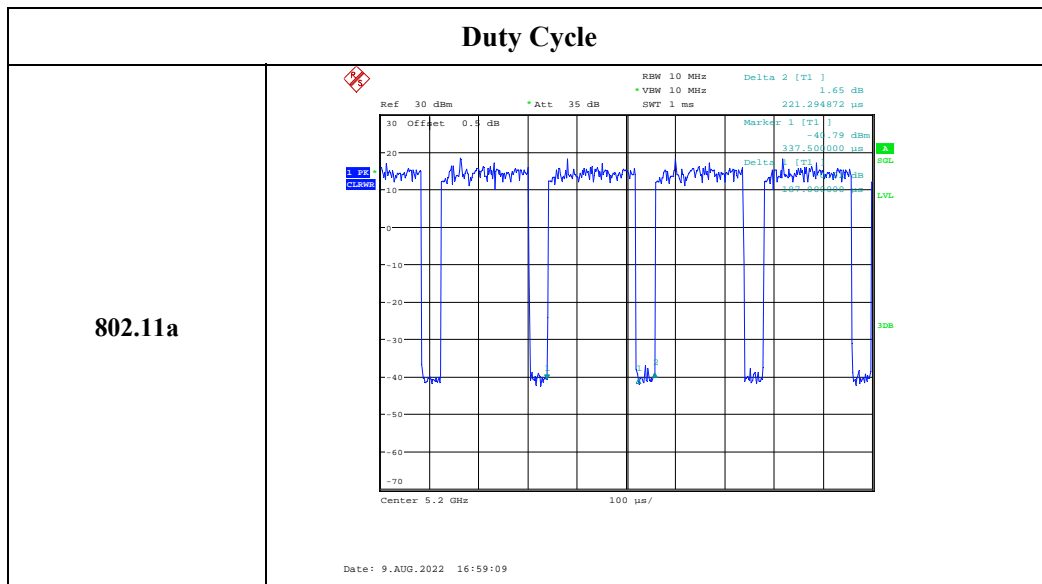

Duty Cycle

802.11n ht20

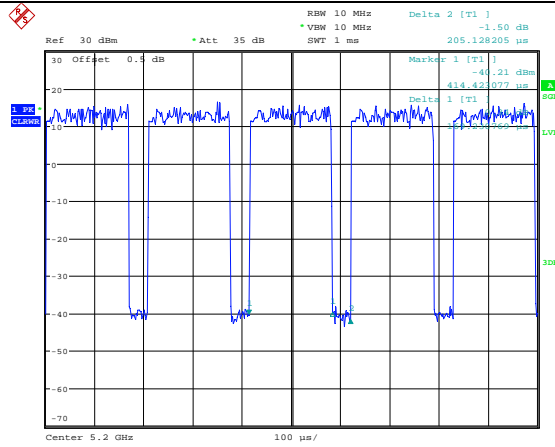

Date: 9.AUG.2022 17:09:53

802.11n ht40

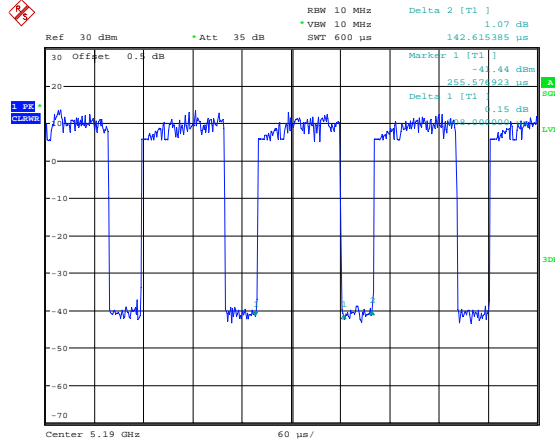

Date: 9.AUG.2022 17:15:32

802.11ac vht80

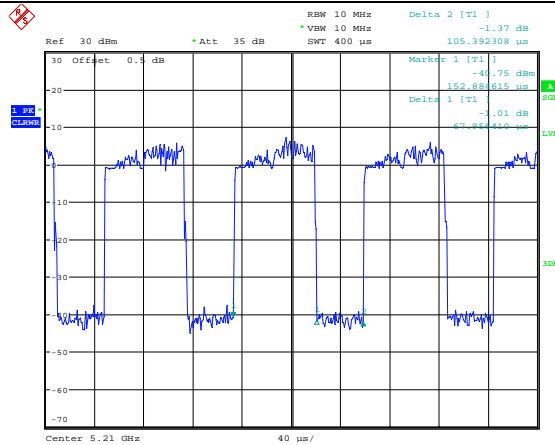

Date: 9.AUG.2022 17:18:07

==== END OF REPORT ====