



**CFR 47 FCC PART 15 SUBPART C
CERTIFICATION TEST REPORT**

For

Tablet

MODEL NUMBER: VT-TAB07-RK68H

FCC ID: 2AAGE-TAB07RK68HL

REPORT NUMBER: 4789722180-1

ISSUE DATE: December 07, 2020

Prepared for

**Chengdu Vantron Technology, Ltd.
No.5 GaoPeng Road, Hi-Tech Zone, Chengdu, SiChuan, P.R. China**

Prepared by

UL Verification Services (Guangzhou) Co., Ltd, Song Shan Lake Branch

Building 10, Innovation Technology Park, No. 1, Li Bin Road, Song Shan Lake Hi-Tech Development Zone Dongguan, 523808, People's Republic of China

Tel: +86 769 22038881

Fax: +86 769 33244054

Website: www.ul.com



Revision History

<u>Rev.</u>	<u>Issue Date</u>	<u>Revisions</u>	<u>Revised By</u>
V0	12/07/2020	Initial Issue	



Summary of Test Results			
Clause	Test Items	FCC Rules	Test Results
1	6dB Bandwidth and 99% Occupied Bandwidth	FCC Part 15.247 (a) (2)	Pass
2	Conducted Output Power	FCC Part 15.247 (b) (3)	Pass
3	Power Spectral Density	FCC Part 15.247 (e)	Pass
4	Conducted Bandedge and Spurious Emission	FCC Part 15.247 (d)	Pass
5	Radiated Bandedge and Spurious Emission	FCC Part 15.247 (d) FCC Part 15.209 FCC Part 15.205	Pass
6	Conducted Emission Test for AC Power Port	FCC Part 15.207	Pass
7	Antenna Requirement	FCC Part 15.203	Pass
Note: 1. This test report is only published to and used by the applicant, and it is not for evidence purpose in China. 2. The measurement result for the sample received is <Pass> according to < CFR 47 FCC PART 15 SUBPART C >when <Accuracy Method> decision rule is applied.			



TABLE OF CONTENTS

1. ATTESTATION OF TEST RESULTS	6
2. TEST METHODOLOGY	7
3. FACILITIES AND ACCREDITATION	7
4. CALIBRATION AND UNCERTAINTY	8
4.1. <i>MEASURING INSTRUMENT CALIBRATION</i>	<i>8</i>
4.2. <i>MEASUREMENT UNCERTAINTY</i>	<i>8</i>
5. EQUIPMENT UNDER TEST	9
5.1. <i>DESCRIPTION OF EUT</i>	<i>9</i>
5.2. <i>CHANNEL LIST</i>	<i>9</i>
5.3. <i>THE WORSE CASE POWER SETTING PARAMETER</i>	<i>9</i>
5.4. <i>MAXIMUM OUTPUT POWER</i>	<i>10</i>
5.5. <i>TEST CHANNEL CONFIGURATION</i>	<i>10</i>
5.6. <i>THE WORSE CASE CONFIGURATIONS</i>	<i>11</i>
5.7. <i>DESCRIPTION OF AVAILABLE ANTENNAS</i>	<i>12</i>
5.8. <i>DESCRIPTION OF TEST SETUP</i>	<i>13</i>
6. MEASURING INSTRUMENT AND SOFTWARE USED	14
7. ANTENNA PORT TEST RESULTS	16
7.1. <i>ON TIME AND DUTY CYCLE</i>	<i>16</i>
7.2. <i>6 dB DTS BANDWIDTH AND 99 % OCCUPIED BANDWIDTH</i>	<i>17</i>
7.3. <i>CONDUCTED OUTPUT POWER</i>	<i>19</i>
7.4. <i>POWER SPECTRAL DENSITY</i>	<i>20</i>
7.5. <i>CONDUCTED BANDEDGE AND SPURIOUS EMISSIONS</i>	<i>22</i>
8. RADIATED TEST RESULTS	24
8.1. <i>RESTRICTED BANDEDGE</i>	<i>30</i>
8.1.1. <i>802.11b SISO MODE</i>	<i>30</i>
8.1.2. <i>802.11g SISO MODE</i>	<i>33</i>
8.1.3. <i>802.11n HT20 SISO MODE</i>	<i>37</i>
8.2. <i>SPURIOUS EMISSIONS (1 GHz ~ 3 GHz)</i>	<i>41</i>
8.2.1. <i>802.11g SISO MODE</i>	<i>41</i>
8.3. <i>SPURIOUS EMISSIONS (3 GHz ~ 18 GHz)</i>	<i>47</i>
8.3.1. <i>802.11b SISO MODE</i>	<i>47</i>
8.3.2. <i>802.11g SISO MODE</i>	<i>53</i>
8.3.3. <i>802.11n HT20 SISO MODE</i>	<i>59</i>
8.4. <i>SPURIOUS EMISSIONS (18 GHz ~ 26 GHz)</i>	<i>65</i>



8.4.1.	802.11n HT20 SISO MODE	65
8.5.	<i>SPURIOUS EMISSIONS (30 MHz ~ 1 GHz)</i>	67
8.5.1.	802.11b SISO MODE.....	67
8.6.	<i>SPURIOUS EMISSIONS BELOW 30 MHz</i>	69
8.6.1.	802.11b SISO MODE.....	69
9.	AC POWER LINE CONDUCTED EMISSIONS	72
9.1.	802.11b SISO MODE.....	73
10.	ANTENNA REQUIREMENTS	75
11.	Appendix.....	76
11.1.	<i>Appendix A: DTS Bandwidth</i>	76
11.1.1.	Test Result.....	76
11.1.2.	Test Graphs	77
11.2.	<i>Appendix B: Occupied Channel Bandwidth</i>	80
11.2.1.	Test Result.....	80
11.2.2.	Test Graphs	81
11.3.	<i>Appendix C: Maximum AVG conducted output power</i>	84
11.3.1.	Test Result.....	84
11.4.	<i>Appendix D: Maximum power spectral density</i>	85
11.4.1.	Test Result.....	85
11.4.2.	Test Graphs	86
11.5.	<i>Appendix E: Band edge measurements</i>	89
11.5.1.	Test Result.....	89
11.5.2.	Test Graphs	90
11.6.	<i>Appendix F: Conducted Spurious Emission</i>	92
11.6.1.	Test Result.....	92
11.6.2.	Test Graphs	93
11.7.	<i>Appendix G: Duty Cycle</i>	102
11.7.1.	Test Result.....	102
11.7.2.	Test Graphs	103



1. ATTESTATION OF TEST RESULTS

Applicant Information

Company Name: Chengdu Vantron Technology, Ltd.
Address: No.5 GaoPeng Road, Hi-Tech Zone, Chengdu, SiChuan, P.R. China

Manufacturer Information

Company Name: Chengdu Vantron Technology, Ltd.
Address: No.5 GaoPeng Road, Hi-Tech Zone, Chengdu, SiChuan, P.R. China

EUT Information

EUT Name: Tablet
Model: VT-TAB07-RK68H
Brand: VANTRON
Sample Received Date: November 20, 2020
Sample Status: Normal
Sample ID: 3474021
Date of Tested: November 20, 2020~ November 27, 2020

APPLICABLE STANDARDS	
STANDARD	TEST RESULTS
CFR 47 FCC PART 15 SUBPART C	PASS

Prepared By:

Jacky Jiang
Engineer Project Associate

Checked By:

Shawn Wen
Laboratory Leader

Approved By:

Stephen Guo
Laboratory Manager



2. TEST METHODOLOGY

The tests documented in this report were performed in accordance with KDB 558074 D01 15.247 Meas Guidance v05r02, KDB 414788 D01 Radiated Test Site v01r01, CFR 47 FCC Part 2, CFR 47 FCC Part 15, ANSI C63.10-2013.

3. FACILITIES AND ACCREDITATION

Accreditation Certificate	<p>A2LA (Certificate No.: 4102.01) UL Verification Services (Guangzhou) Co., Ltd. Song Shan Lake Branch. has been assessed and proved to be in compliance with A2LA.</p> <p>FCC (FCC Designation No.: CN1187) UL Verification Services (Guangzhou) Co., Ltd. Song Shan Lake Branch. Has been recognized to perform compliance testing on equipment subject to the Commission's Declaration of Conformity (DoC) and Certification rules</p> <p>ISED (Company No.: 21320) UL Verification Services (Guangzhou) Co., Ltd. Song Shan Lake Branch. has been registered and fully described in a report filed with ISED. The Company Number is 21320.</p> <p>VCCI (Registration No.: G-20019, R-20004, C-20012 and T-20011) UL Verification Services (Guangzhou) Co., Ltd. Song Shan Lake Branch. has been assessed and proved to be in compliance with VCCI, the Membership No. is 3793. Facility Name: Chamber D, the VCCI registration No. is G-20019 and R-20004 Shielding Room B , the VCCI registration No. is C-20012 and T-20011</p>
---------------------------	--

Note 1: All tests measurement facilities use to collect the measurement data are located at Building 10, Innovation Technology Park, Song Shan Lake Hi tech Development Zone, Dongguan, 523808, China

Note 2: The test anechoic chamber in UL Verification Services (Guangzhou) Co., Ltd. Song Shan Lake Branch had been calibrated and compared to the open field sites and the test anechoic chamber is shown to be equivalent to or worst case from the open field site.

Note 3: For below 30 MHz, lab had performed measurements at test anechoic chamber and comparing to measurements obtained on an open field site. And these measurements below 30 MHz had been correlated to measurements performed on an OFS.



4. CALIBRATION AND UNCERTAINTY

4.1. MEASURING INSTRUMENT CALIBRATION

The measuring equipment utilized to perform the tests documented in this report has been calibrated in accordance with the manufacturer's recommendations and is traceable to recognize national standards.

4.2. MEASUREMENT UNCERTAINTY

Where relevant, the following measurement uncertainty levels have been estimated for tests performed on the apparatus:

Test Item	Uncertainty
Conduction emission	3.62 dB
Radiated Emission (Included Fundamental Emission) (9 kHz ~ 30 MHz)	2.2 dB
Radiated Emission (Included Fundamental Emission) (30 MHz ~ 1 GHz)	4.00 dB
Radiated Emission (Included Fundamental Emission) (1 GHz to 26 GHz)	5.78 dB (1 GHz ~ 18 GHz)
	5.23 dB (18 GHz ~ 26 GHz)
Note: This uncertainty represents an expanded uncertainty expressed at approximately the 95% confidence level using a coverage factor of k=2.	



5. EQUIPMENT UNDER TEST

5.1. DESCRIPTION OF EUT

EUT Name	Tablet		
Model	VT-TAB07-RK68H		
Radio Technology	WLAN (IEEE 802.11b/g/n HT20)		
Operation frequency	IEEE 802.11b: 2412MHz ~ 2462MHz IEEE 802.11g: 2412MHz ~ 2462MHz IEEE 802.11n HT20: 2412MHz ~ 2462MHz		
Modulation	IEEE 802.11b: DSSS (CCK, DQPSK, DBPSK) IEEE 802.11g: OFDM (64QAM, 16QAM, QPSK, BPSK) IEEE 802.11n HT20: OFDM (256QAM, 64QAM, 16QAM, QPSK, BPSK)		
Power Supply	Power Adapter	Input	100-240 V~50/60Hz 0.5A
		Output	5V/2A
	Battery	3.8V, 4000 mAh	

5.2. CHANNEL LIST

Channel List for 802.11b/g/n (20 MHz)							
Channel	Frequency (MHz)	Channel	Frequency (MHz)	Channel	Frequency (MHz)	Channel	Frequency (MHz)
1	2412	4	2427	7	2442	10	2457
2	2417	5	2432	8	2447	11	2462
3	2422	6	2437	9	2452	/	/

5.3. THE WORSE CASE POWER SETTING PARAMETER

The Worst Case Power Setting Parameter under 2400 ~ 2483.5MHz Band							
Test Software		RFTesttool					
Modulation Mode	Transmit Antenna Number	Test Channel					
		NCB: 20MHz			NCB: 40MHz		
		CH 1	CH 6	CH 11	CH 3	CH 6	CH 9
802.11b	1	default	default	default	/		
802.11g	1	default	default	default			
802.11n HT20	1	default	default	default			



5.4. MAXIMUM OUTPUT POWER

IEEE Std. 802.11	Frequency (MHz)	Channel Number	Maximum Conducted AVG Output Power (dBm)	Maximum AVG EIRP (dBm)
b	2412 ~ 2462	1-11[11]	13.05	15.21
g	2412 ~ 2462	1-11[11]	12.44	14.60
n HT20	2412 ~ 2462	1-11[11]	12.65	14.81

5.5. TEST CHANNEL CONFIGURATION

IEEE Std. 802.11	Test Channel Number	Frequency
b	CH 1(Low Channel), CH 6(MID Channel), CH 11(High Channel)	2412 MHz, 2437 MHz, 2462 MHz
g	CH 1(Low Channel), CH 6(MID Channel), CH 11(High Channel)	2412 MHz, 2437 MHz, 2462 MHz
n HT20	CH 1(Low Channel), CH 6(MID Channel), CH 11(High Channel)	2412 MHz, 2437 MHz, 2462 MHz



5.6. THE WORSE CASE CONFIGURATIONS

The EUT was tested in the following configuration(s):
Controlled in test mode using a software application on the EUT supplied by customer. The application was used to enable a continuous transmission and to select the mode, test channels, bandwidth, data rates as required.

Test channels referring to section 5.2.

Maximum power setting referring to section 5.3.

Worst case Data Rates declared by the customer:

- IEEE 802.11b / SISO – DBPSK / 1 Mbps
- IEEE 802.11g / SISO – BPSK / 6 Mbps
- IEEE 802.11n HT20 / SISO – BPSK / MCS0



5.7. DESCRIPTION OF AVAILABLE ANTENNAS

Antenna	Frequency (MHz)	Antenna Type	MAX Antenna Gain (dBi)
1	2412-2462	Internal Antenna	2.16

Test Mode	Transmit and Receive Mode	Description
IEEE 802.11b	<input checked="" type="checkbox"/> 1TX, 1RX	ANT 1 can be used as transmitting/receiving antenna.
IEEE 802.11g	<input checked="" type="checkbox"/> 1TX, 1RX	ANT 1 can be used as transmitting/receiving antenna.
IEEE 802.11n HT20	<input checked="" type="checkbox"/> 1TX, 1RX	ANT 1 can be used as transmitting/receiving antenna.
Note: 1.BT, BLE, WLAN 2.4G and WLAN 5G can't transmit simultaneously. (declared by client)		

Note: The value of the antenna gain was declared by customer.

5.8. DESCRIPTION OF TEST SETUP

SUPPORT EQUIPMENT

Item	Equipment	Brand Name	Model Name	P/N
/	/	/	/	

I/O CABLES

Cable No	Port	Connector Type	Cable Type	Cable Length(m)	Remarks
1	USB	Type C	/	1.0	/

ACCESSORIES

Item	Accessory	Brand Name	Model Name	Description
1	Power supply	/	NA010050020	OUTPUT 5V, 2A
2	Earphone	/	/	/
3	TF Card	/	/	/

TEST SETUP

The EUT can work in engineering mode with a software installed.

SETUP DIAGRAM FOR TESTS

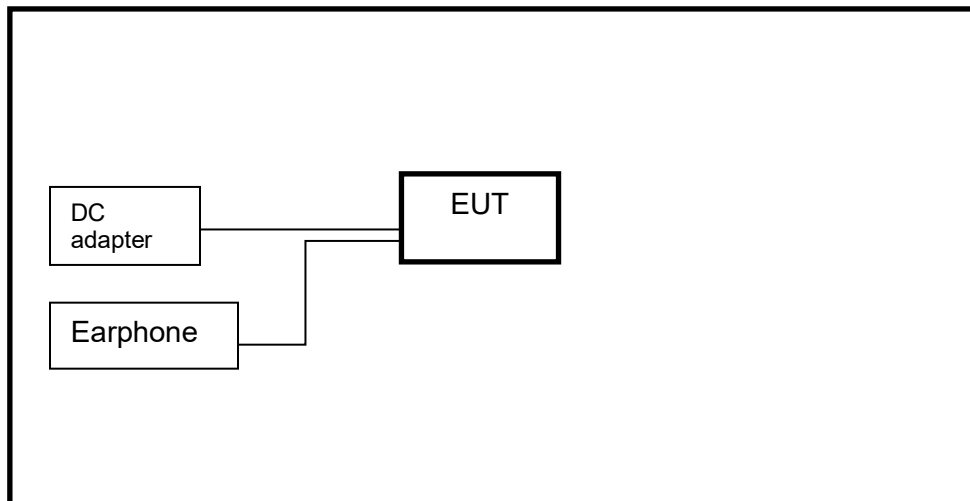

**6. MEASURING INSTRUMENT AND SOFTWARE USED**

Conducted Emissions						
Instrument						
Used	Equipment	Manufacturer	Model No.	Serial No.	Last Cal.	Next Cal.
<input checked="" type="checkbox"/>	EMI Test Receiver	R&S	ESR3	101961	Dec.05,2019	Dec.05,2020
<input checked="" type="checkbox"/>	Two-Line V-Network	R&S	ENV216	101983	Dec.05,2019	Dec.05,2020
Software						
Used	Description			Manufacturer	Name	Version
<input checked="" type="checkbox"/>	Test Software for Conducted disturbance			Farad	EZ-EMC	Ver. UL-3A1
Radiated Emissions						
Instrument						
Used	Equipment	Manufacturer	Model No.	Serial No.	Last Cal.	Next Cal.
<input checked="" type="checkbox"/>	MXE EMI Receiver	KESIGHT	N9038A	MY56400036	Dec.06,2019	Dec.05,2020
<input checked="" type="checkbox"/>	Hybrid Log Periodic Antenna	TDK	HLP-3003C	130960	Sep.17,2018	Sep.17,2021
<input checked="" type="checkbox"/>	Preamplifier	HP	8447D	2944A09099	Dec.05,2019	Dec.05,2020
<input checked="" type="checkbox"/>	EMI Measurement Receiver	R&S	ESR26	101377	Dec.05,2019	Dec.05,2020
<input checked="" type="checkbox"/>	Horn Antenna	TDK	HRN-0118	130939	Sep.17,2018	Sep.17,2021
<input checked="" type="checkbox"/>	High Gain Horn Antenna	Schwarzbeck	BBHA-9170	691	Aug.11,2018	Aug.11,2021
<input checked="" type="checkbox"/>	Preamplifier	TDK	PA-02-0118	TRS-305-00067	Dec.05,2019	Dec.05,2020
<input checked="" type="checkbox"/>	Preamplifier	TDK	PA-02-2	TRS-307-00003	Dec.05,2019	Dec.05,2020
<input checked="" type="checkbox"/>	Loop antenna	Schwarzbeck	1519B	00008	Jan.07,2019	Jan.07,2022
<input checked="" type="checkbox"/>	High Pass Filter	Wi	WHKX10-2700-3000-18000-40SS	23	Dec.05,2019	Dec.05,2020
Software						
Used	Description			Manufacturer	Name	Version
<input checked="" type="checkbox"/>	Test Software for Radiated disturbance			Farad	EZ-EMC	Ver. UL-3A1
Other instruments						
Used	Equipment	Manufacturer	Model No.	Serial No.	Last Cal.	Next Cal.



<input checked="" type="checkbox"/>	Spectrum Analyzer	Keysight	N9030A	MY55410512	Dec.06,2019	Dec.05,2020
<input checked="" type="checkbox"/>	Power sensor, Power Meter	R&S	OSP120	100921	Dec.06,2019	Dec.06,2020

7. ANTENNA PORT TEST RESULTS

7.1. ON TIME AND DUTY CYCLE

LIMITS

None; for reporting purposes only

PROCEDURE

Refer to ANSI C63.10-2013 clause 11.6 Zero – Span Spectrum Analyzer method.

TEST SETUP

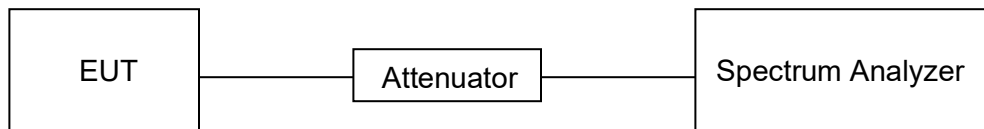

TEST ENVIRONMENT

Temperature	24.4 °C	Relative Humidity	50.3 %
Atmosphere Pressure	101 kPa	Test Voltage	DC 5 V

RESULTS

Please refer to appendix G.

7.2. 6 dB DTS BANDWIDTH AND 99 % OCCUPIED BANDWIDTH

LIMITS

CFR 47 FCC Part15 (15.247) Subpart C			
Section	Test Item	Limit	Frequency Range (MHz)
CFR 47 FCC 15.247(a)(2)	6 dB Bandwidth	≥ 500 kHz	2400-2483.5
ISED RSS-Gen Clause 6.7	99 % Occupied Bandwidth	For reporting purposes only.	2400-2483.5

TEST PROCEDURE

Refer to ANSI C63.10-2013 clause 11.8 for DTS bandwidth and clause 6.9 for Occupied Bandwidth.

Connect the EUT to the spectrum analyzer and use the following settings:

Center Frequency	The center frequency of the channel under test
Frequency Span	Between 1.5 times and 5.0 times the OBW
Detector	Peak
RBW	For 6 dB Bandwidth: 100 kHz For 99 % Occupied Bandwidth: 1 % to 5 % of the occupied bandwidth
VBW	For 6 dB Bandwidth: $\geq 3 \times$ RBW For 99 % Occupied Bandwidth: $\geq 3 \times$ RBW
Trace	Max hold
Sweep	Auto couple

- a) Use the 99 % power bandwidth function of the instrument, allow the trace to stabilize and report the measured bandwidth.
- b) Allow the trace to stabilize and measure the maximum width of the emission that is constrained by the frequencies associated with the two outermost amplitude points (upper and lower frequencies) that are attenuated by 6 dB relative to the maximum level measured in the fundamental emission.



TEST SETUP

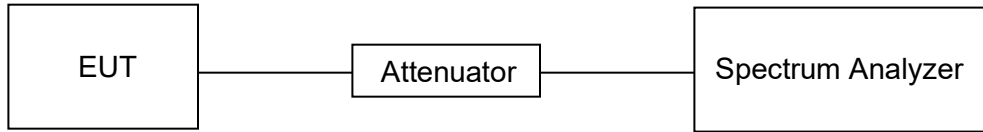

TEST ENVIRONMENT

Temperature	24.4 °C	Relative Humidity	50.3 %
Atmosphere Pressure	101 kPa	Test Voltage	DC 5 V

RESULTS

Please refer to appendix A & B.

7.3. CONDUCTED OUTPUT POWER

LIMITS

CFR 47 FCC Part15 (15.247) Subpart C			
Section	Test Item	Limit	Frequency Range (MHz)
CFR 47 FCC 15.247(b)(3)	Conducted Output Power	1 watt or 30 dBm	2400-2483.5

TEST PROCEDURE

Refer to ANSI C63.10-2013 clause 11.9.

Connect the EUT to a low loss RF cable from the antenna port to the power sensor (video bandwidth is greater than the occupied bandwidth). Measure peak emission level, the indicated level is the average output power, after any corrections for external attenuators and cables.

TEST SETUP

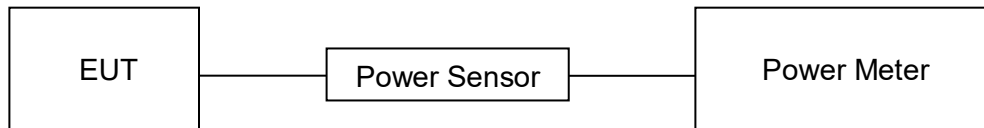

TEST ENVIRONMENT

Temperature	24.4 °C	Relative Humidity	50.3 %
Atmosphere Pressure	101 kPa	Test Voltage	DC 5 V

RESULTS

Please refer to appendix C.

7.4. POWER SPECTRAL DENSITY

LIMITS

CFR 47 FCC Part15 (15.247) Subpart C			
Section	Test Item	Limit	Frequency Range (MHz)
CFR 47 FCC §15.247 (e)	Power Spectral Density	8 dBm/3 kHz	2400-2483.5

TEST PROCEDURE

Refer to ANSI C63.10-2013 clause 11.10.

Connect the EUT to the spectrum analyzer and use the following settings:

Center Frequency	The center frequency of the channel under test
Detector	Peak
RBW	$3 \text{ kHz} \leq \text{RBW} \leq 100 \text{ kHz}$
VBW	$\geq 3 \times \text{RBW}$
Span	1.5 x DTS bandwidth
Trace	Max hold
Sweep time	Auto couple

Allow trace to fully stabilize and use the peak marker function to determine the maximum amplitude level within the RBW.

If measured value exceeds limit, reduce RBW (no less than 3 kHz) and repeat.

TEST SETUP

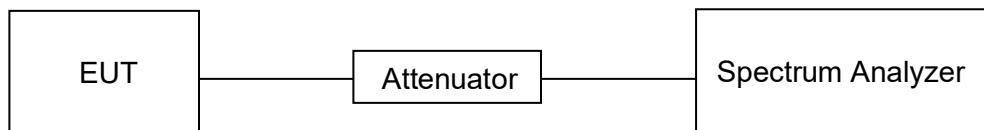

TEST ENVIRONMENT

Temperature	24.4 °C	Relative Humidity	50.3 %
Atmosphere Pressure	101 kPa	Test Voltage	DC 5 V



RESULTS

Please refer to appendix D.



7.5. CONDUCTED BANDEGE AND SPURIOUS EMISSIONS

LIMITS

CFR 47 FCC Part15 (15.247) Subpart C		
Section	Test Item	Limit
CFR 47 FCC §15.247 (d)	Conducted Bandedge and Spurious Emissions	at least 30 dB below that in the 100 kHz bandwidth within the band that contains the highest level of the desired power

TEST PROCEDURE

Refer to ANSI C63.10-2013 clause 11.11 and 11.13.

Connect the EUT to the spectrum analyzer and use the following settings for reference level measurement:

Center Frequency	The center frequency of the channel under test
Detector	Peak
RBW	100 kHz
VBW	$\geq 3 \times \text{RBW}$
Span	1.5 x DTS bandwidth
Trace	Max hold
Sweep time	Auto couple.

Allow trace to fully stabilize and use the peak marker function to determine the maximum PSD level.

Change the settings for emission level measurement:

Span	Set the center frequency and span to encompass frequency range to be measured
Detector	Peak
RBW	100 kHz
VBW	$\geq 3 \times \text{RBW}$
measurement points	$\geq \text{span}/\text{RBW}$
Trace	Max hold
Sweep time	Auto couple.

Allow trace to fully stabilize and use the peak marker function to determine the maximum PSD level. Ensure that the amplitude of all unwanted emissions outside of the authorized frequency band (excluding restricted frequency bands) is attenuated by at least the minimum requirements specified in 11.11.

TEST SETUP

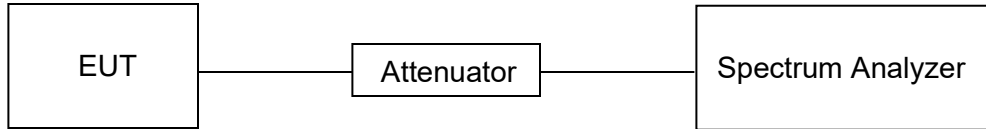

TEST ENVIRONMENT

Temperature	24.4 °C	Relative Humidity	50.3 %
Atmosphere Pressure	101 kPa	Test Voltage	DC 5 V

RESULTS

Please refer to appendix E & F.



8. RADIATED TEST RESULTS

LIMITS

Please refer to CFR 47 FCC §15.205 and §15.209.

Radiation Disturbance Test Limit for FCC (Class B) (9 kHz ~ 1 GHz)

Emissions radiated outside of the specified frequency bands above 30 MHz			
Frequency Range (MHz)	Field Strength Limit (uV/m) at 3 m	Field Strength Limit (dBuV/m) at 3 m	
		Quasi-Peak	
30 - 88	100	40	
88 - 216	150	43.5	
216 - 960	200	46	
Above 960	500	54	
Above 1000	500	Peak	Average
		74	54

FCC Emissions radiated outside of the specified frequency bands below 30 MHz		
Frequency (MHz)	Field strength (microvolts/meter)	Measurement distance (meters)
0.009-0.490	2400/F(kHz)	300
0.490-1.705	24000/F(kHz)	30
1.705-30.0	30	30

FCC Restricted bands of operation refer to FCC §15.205 (a):

MHz	MHz	MHz	GHz
0.090-0.110	16.42-16.423	399.9-410	4.5-5.15
¹ 0.495-0.505	16.69475-16.69525	608-614	5.35-5.46
2.1735-2.1905	16.80425-16.80475	960-1240	7.25-7.75
4.125-4.128	25.5-25.67	1300-1427	8.025-8.5
4.17725-4.17775	37.5-38.25	1435-1626.5	9.0-9.2
4.20725-4.20775	73-74.6	1645.5-1646.5	9.3-9.5
6.215-6.218	74.8-75.2	1660-1710	10.6-12.7
6.26775-6.26825	108-121.94	1718.8-1722.2	13.25-13.4
6.31175-6.31225	123-138	2200-2300	14.47-14.5
8.291-8.294	149.9-150.05	2310-2390	15.35-16.2
8.362-8.366	156.52475-156.52525	2483.5-2500	17.7-21.4
8.37625-8.38675	156.7-156.9	2690-2900	22.01-23.12
8.41425-8.41475	162.0125-167.17	3260-3267	23.6-24.0
12.29-12.293	167.72-173.2	3332-3339	31.2-31.8
12.51975-12.52025	240-285	3345.8-3358	36.43-36.5
12.57675-12.57725	322-335.4	3600-4400	(²)
13.36-13.41			

Note: ¹Until February 1, 1999, this restricted band shall be 0.490-0.510 MHz.
²Above 38.6c

TEST SETUP AND PROCEDURE

Below 30 MHz

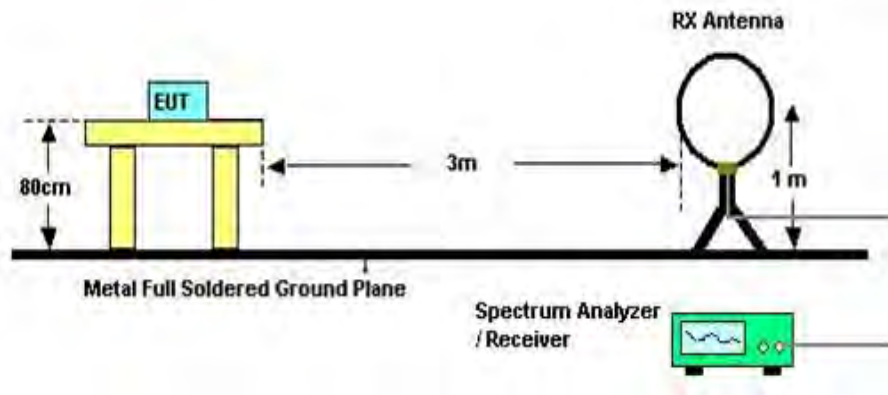

The setting of the spectrum analyzer

RBW	200 Hz (From 9 kHz to 0.15 MHz) / 9 kHz (From 0.15 MHz to 30 MHz)
VBW	200 Hz (From 9 kHz to 0.15 MHz) / 9 kHz (From 0.15 MHz to 30 MHz)
Sweep	Auto
Trace	Max hold

1. The testing follows the guidelines in ANSI C63.10-2013 clause 6.4.
2. The EUT was arranged to its worst case and then turntable (from 0 degree to 360 degrees) to find the maximum reading. A pre-amp and a high pass filter are used for the test in order to get better signal level. Both Horizontal, Face-on and Face-off polarizations of the antenna are set to make the measurement.
3. The EUT was placed on a turntable with 80cm above ground.
4. The EUT was set 3 meters from the interference receiving antenna, which was mounted on the top of a 1 m height antenna tower.



5. The radiated emission limits are based on measurements employing a CISPR quasi-peak detector except for the frequency bands 9-90 kHz, 110-490 kHz and above 1000 MHz. Radiated emission limits in these three bands are based on measurements employing an average detector.
6. For measurement below 1 GHz, the initial step in collecting conducted emission data is a spectrum analyzer peak detector mode pre-scanning the measurement frequency range. Significant peaks are then marked and then Quasi Peak and average detector mode re-measured. If the emission level of the EUT measured by the peak detector is 3 dB lower than the applicable limit, the peak emission level will be reported. Otherwise, the emission measurement will be repeated using the quasi-peak and average detector and reported.
7. Although these tests were performed other than open field site, adequate comparison measurements were confirmed against 30 m open field site. Therefore sufficient tests were made to demonstrate that the alternative site produces results that correlate with the ones of tests made in an open field site based on KDB 414788.

Below 1 GHz and above 30 MHz

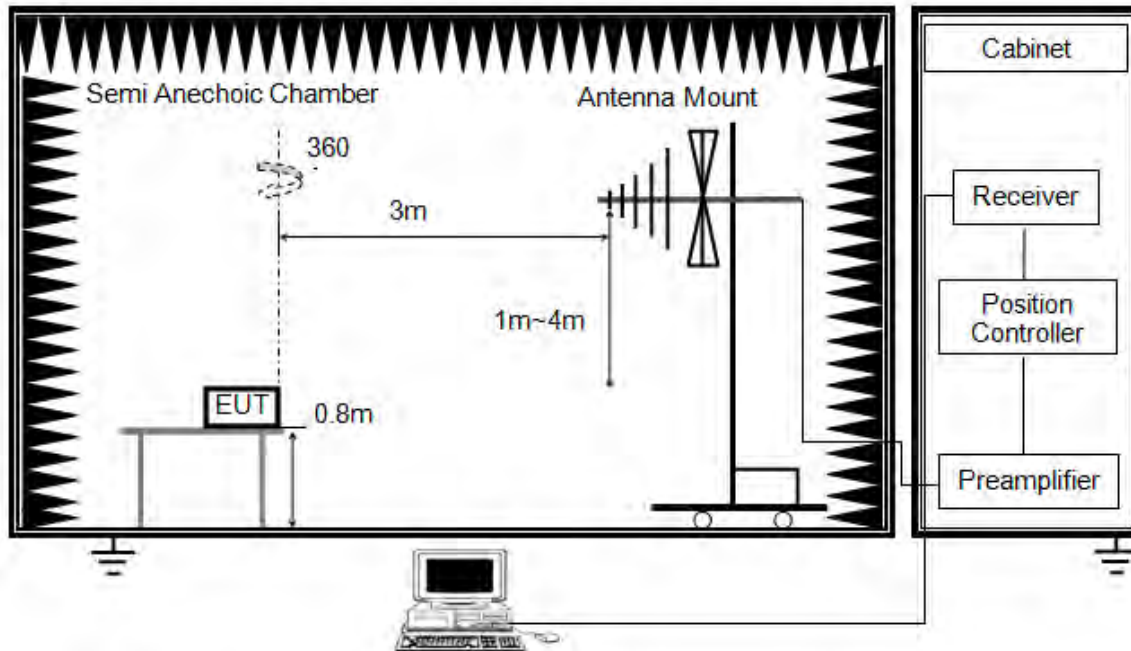

The setting of the spectrum analyzer

RBW	120 kHz
VBW	300 kHz
Sweep	Auto
Detector	Peak/QP
Trace	Max hold

1. The testing follows the guidelines in ANSI C63.10-2013 clause 6.5.
2. The EUT was arranged to its worst case and then tune the antenna tower (from 1 m to 4 m) and turntable (from 0 degree to 360 degrees) to find the maximum reading. A pre-amp and a high pass filter are used for the test in order to get better signal level. Both horizontal and vertical polarizations of the antenna are set to make the measurement.
3. The EUT was placed on a turntable with 80 cm above ground.
4. The EUT was set 3 meters from the interference receiving antenna, which was mounted on the top of a variable height antenna tower.
5. For measurement below 1 GHz, the initial step in collecting conducted emission data is a spectrum analyzer peak detector mode pre-scanning the measurement frequency range. Significant peaks are then marked and then Quasi Peak detector mode re-measured. If the emission level of the EUT measured by the peak detector is 3 dB lower than the applicable limit, the peak emission level will be reported. Otherwise, the emission measurement will be repeated using the quasi-peak detector and reported.

Above 1 GHz

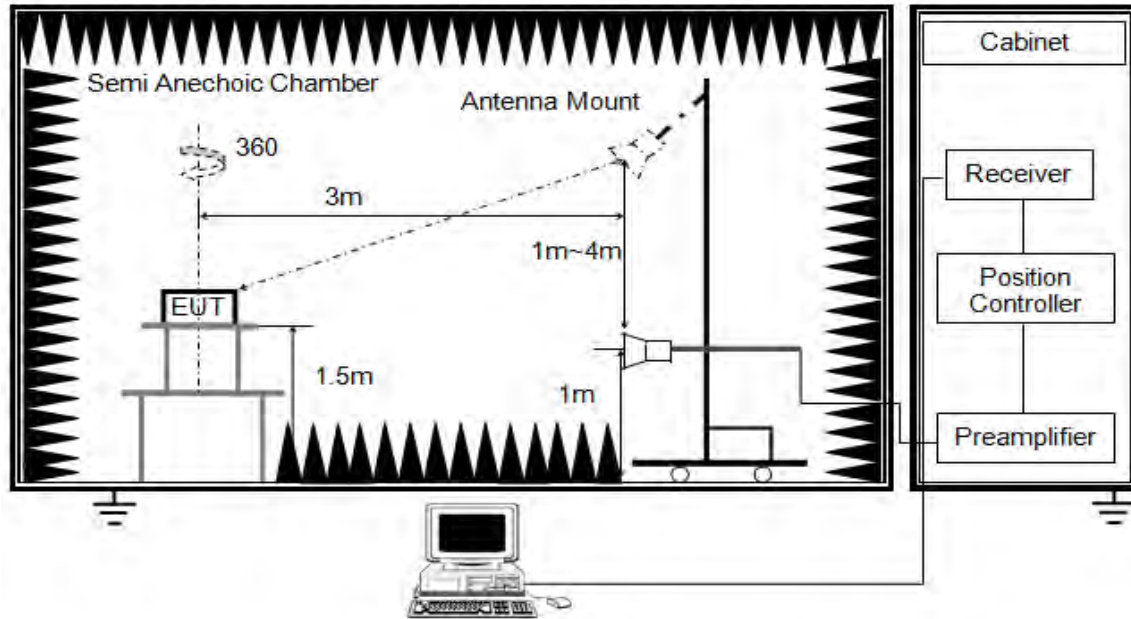

The setting of the spectrum analyzer

RBW	1 MHz
VBW	PEAK: 3 MHz AVG: see note 6
Sweep	Auto
Detector	Peak
Trace	Max hold

1. The testing follows the guidelines in ANSI C63.10-2013 clause 6.6.
2. The EUT was arranged to its worst case and then tune the antenna tower (1- s4 m) and turntable (from 0 degree to 360 degrees) to find the maximum reading. A pre-amp and a high pass filter are used for the test in order to get better signal level. Both horizontal and vertical polarizations of the antenna are set to make the measurement.
3. The EUT was placed on a turntable with 1.5 m above ground.
4. The EUT was set 3 meters from the interference receiving antenna, which was mounted on the top of a variable height antenna tower.
5. For measurement above 1 GHz, the emission measurement will be measured by the peak detector. This peak level, once corrected, must comply with the limit specified in Section 15.209.
6. For measurements above 1 GHz the resolution bandwidth is set to 1 MHz, then the video bandwidth is set to 3 MHz for peak measurements and 1 MHz resolution bandwidth with 1/T video bandwidth with peak detector for average measurements. For the Duty Cycle please refer to clause 7.1.ON TIME AND DUTY CYCLE.

X axis, Y axis, Z axis positions:

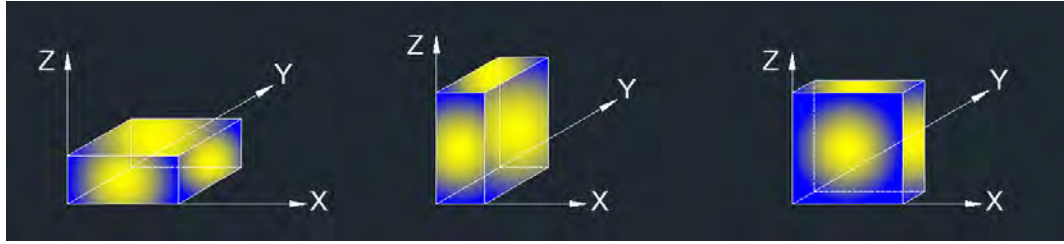

Note 1: For all radiated test, EUT in each of three orthogonal axis emissions had been tested, but only the worst case (X axis) data recorded in the report.

Note 2: Simultaneous transmission was not evaluated with the 2.4 GHz WiFi, 5 GHz WiFi and BT transmitter due they couldn't transmit in simultaneous.

Note 3: The EUT was fully exercised with external accessories during the test. In the case of multiple accessory external ports, an external accessory shall be connected to one of each type of port.

TEST ENVIRONMENT

Temperature	24.2 °C	Relative Humidity	63 %
Atmosphere Pressure	101 kPa	Test Voltage	DC 5 V

RESULTS

8.1. RESTRICTED BANDEDGE

8.1.1. 802.11b SISO MODE

RESTRICTED BANDEDGE (LOW CHANNEL, HORIZONTAL)

PEAK

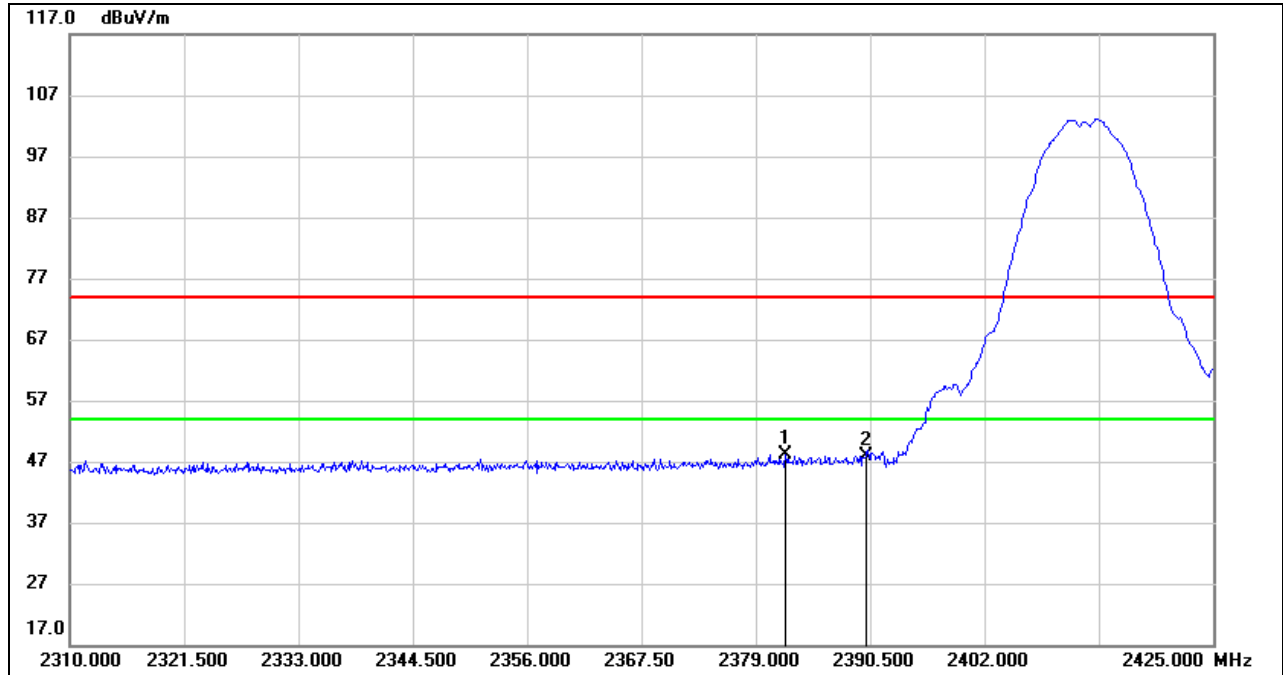

No.	Frequency (MHz)	Reading (dBuV)	Correct (dB/m)	Result (dBuV/m)	Limit (dBuV/m)	Margin (dB)	Remark
1	2381.990	36.29	11.90	48.19	74.00	-25.81	peak
2	2390.000	36.01	11.96	47.97	74.00	-26.03	peak

Note: 1. Measurement = Reading Level + Correct Factor.
 2. If Peak Result complies with AV limit, AV Result is deemed to comply with AV limit.
 3. Peak: Peak detector.
 4. Only the worst data was recorded, if it complies with the limit, the other emissions deemed to comply with the limit.

RESTRICTED BANDEDGE (HIGH CHANNEL, HORIZONTAL)

PEAK

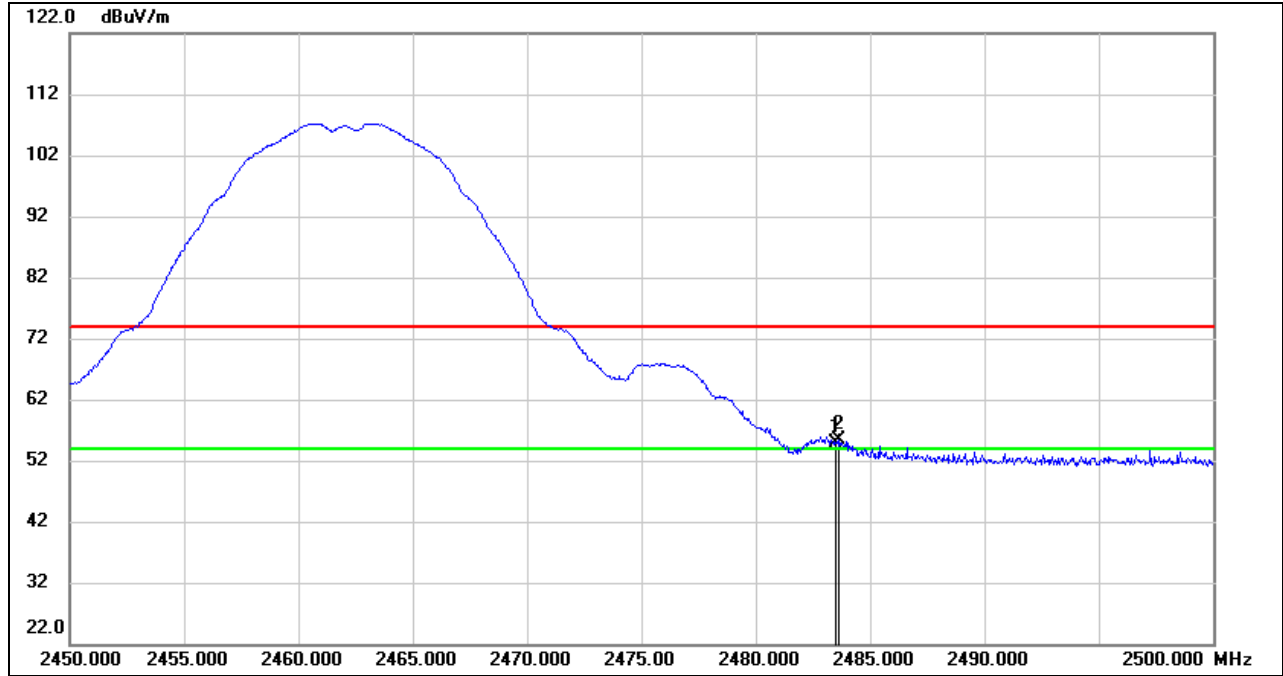

No.	Frequency (MHz)	Reading (dBuV)	Correct (dB/m)	Result (dBuV/m)	Limit (dBuV/m)	Margin (dB)	Remark
1	2483.500	42.42	12.38	54.80	74.00	-19.20	peak
2	2483.650	42.98	12.38	55.36	74.00	-18.64	peak

- Note: 1. Measurement = Reading Level + Correct Factor.
 2. If Peak Result complies with AV limit, AV Result is deemed to comply with AV limit.
 3. Peak: Peak detector.
 4. Only the worst data was recorded, if it complies with the limit, the other emissions deemed to comply with the limit.

AVG

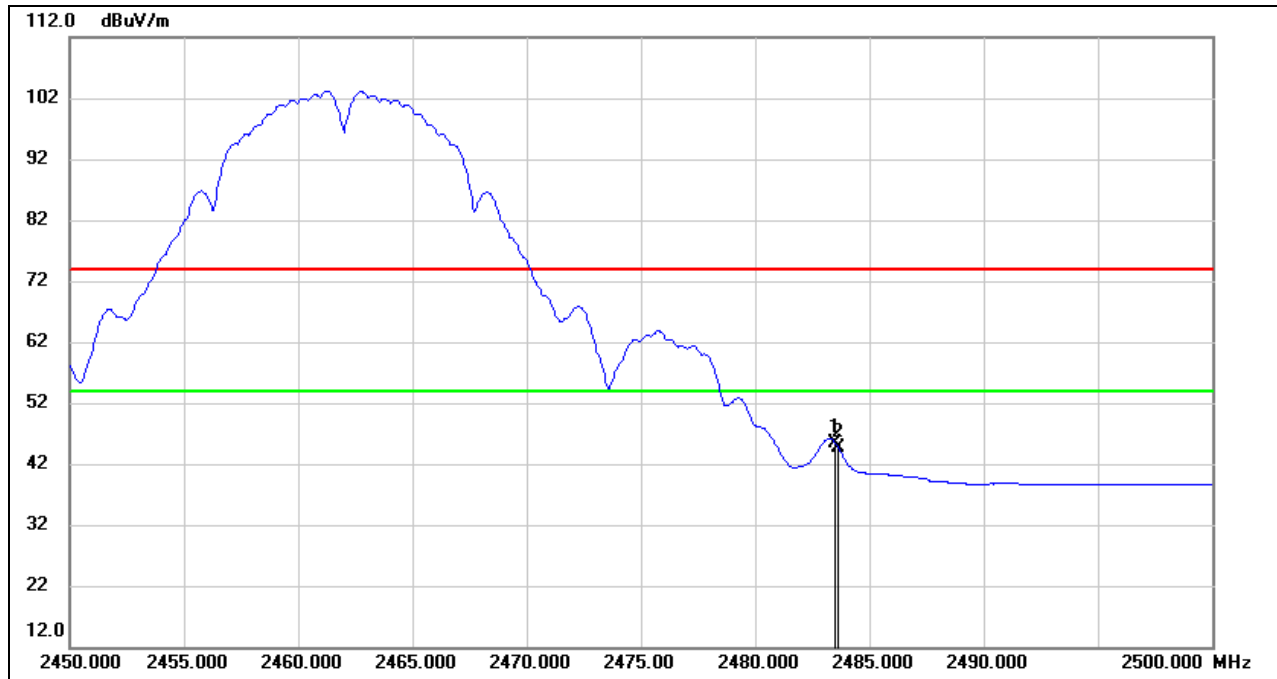

No.	Frequency (MHz)	Reading (dBuV)	Correct (dB/m)	Result (dBuV/m)	Limit (dBuV/m)	Margin (dB)	Remark
1	2483.500	33.11	12.38	45.49	54.00	-8.51	AVG
2	2483.650	32.28	12.38	44.66	54.00	-9.34	AVG

- Note: 1. Measurement = Reading Level + Correct Factor.
 2. If Peak Result complies with AV limit, AV Result is deemed to comply with AV limit.
 3. AVG: $VBW=1/Ton$, where: Ton is the transmitting duration.
 4. For the transmitting duration, please refer to clause 7.1.
 5. Only the worst data was recorded, if it complies with the limit, the other emissions deemed to comply with the limit.

8.1.2. 802.11g SISO MODE

RESTRICTED BANDEDGE (LOW CHANNEL, HORIZONTAL)

PEAK

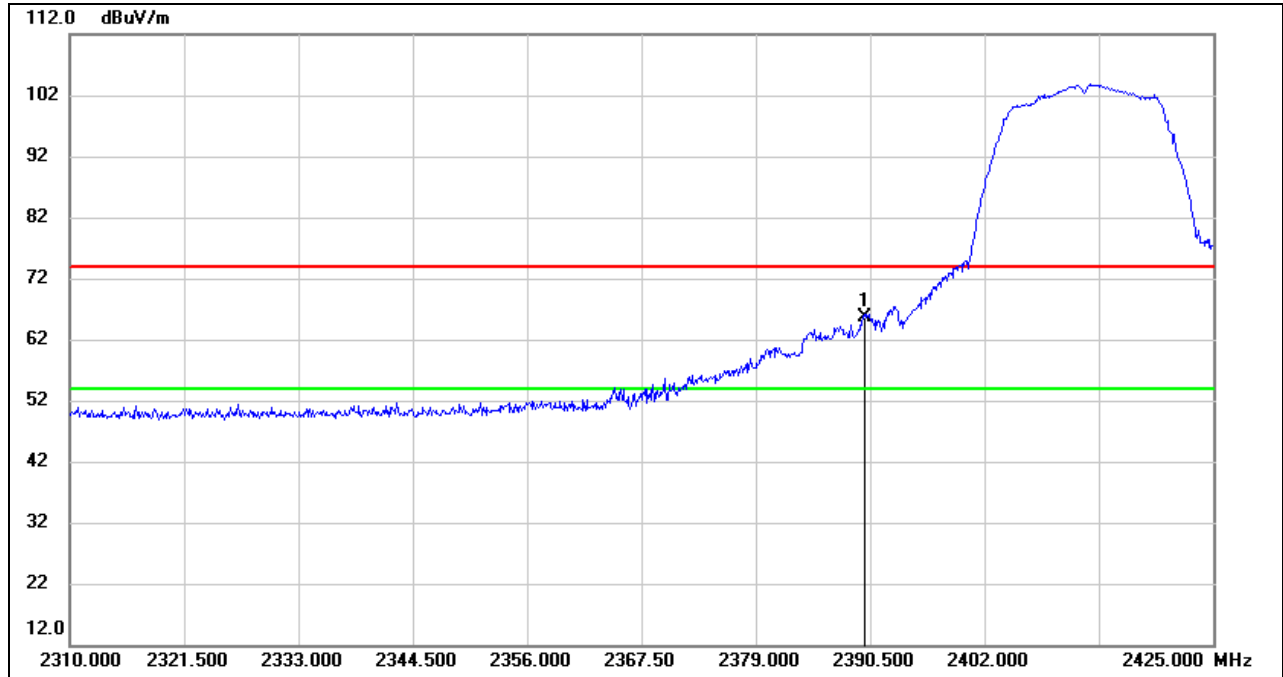

No.	Frequency (MHz)	Reading (dBuV)	Correct (dB/m)	Result (dBuV/m)	Limit (dBuV/m)	Margin (dB)	Remark
1	2390.000	53.69	11.96	65.65	74.00	-8.35	peak

- Note:
1. Measurement = Reading Level + Correct Factor.
 2. If Peak Result complies with AV limit, AV Result is deemed to comply with AV limit.
 3. Peak: Peak detector.
 4. Only the worst data was recorded, if it complies with the limit, the other emissions deemed to comply with the limit.

AVG

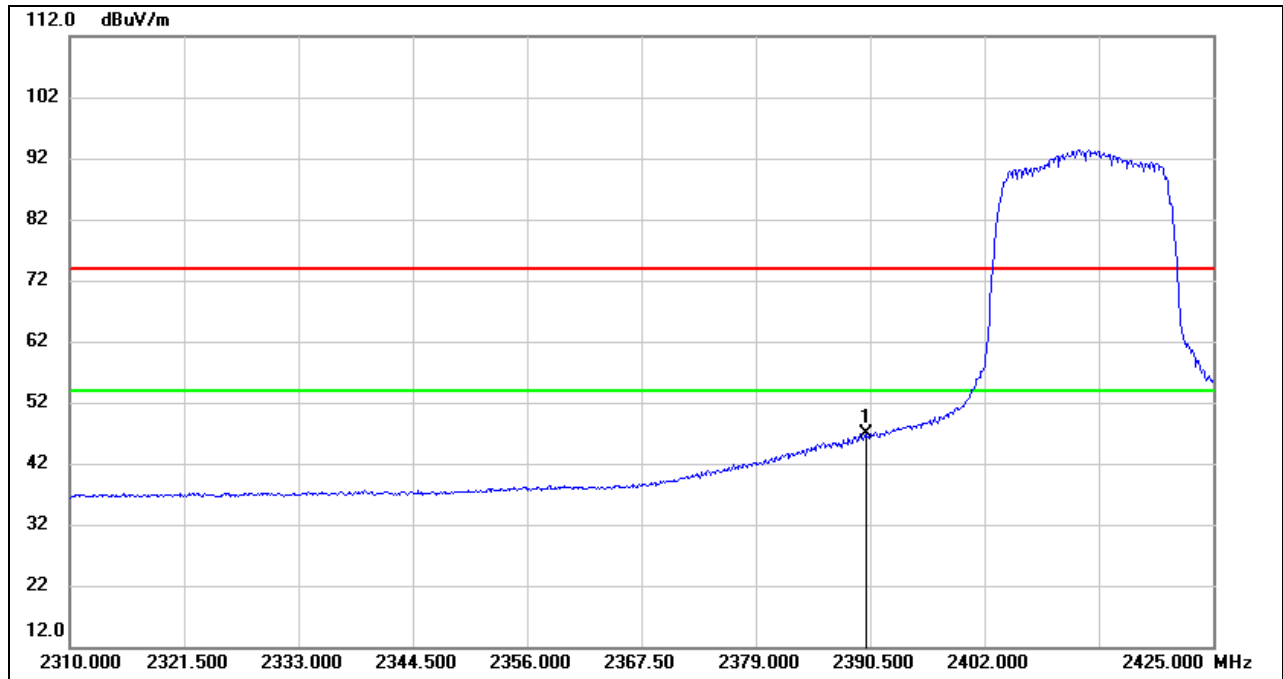

No.	Frequency (MHz)	Reading (dBuV)	Correct (dB/m)	Result (dBuV/m)	Limit (dBuV/m)	Margin (dB)	Remark
1	2390.000	34.95	11.96	46.91	54.00	-7.09	AVG

- Note: 1. Measurement = Reading Level + Correct Factor.
 2. If Peak Result complies with AV limit, AV Result is deemed to comply with AV limit.
 3. AVG: $VBW=1/Ton$, where: Ton is the transmitting duration.
 4. For the transmitting duration, please refer to clause 7.1.
 5. Only the worst data was recorded, if it complies with the limit, the other emissions deemed to comply with the limit.

RESTRICTED BANDEDGE (HIGH CHANNEL, HORIZONTAL)

PEAK

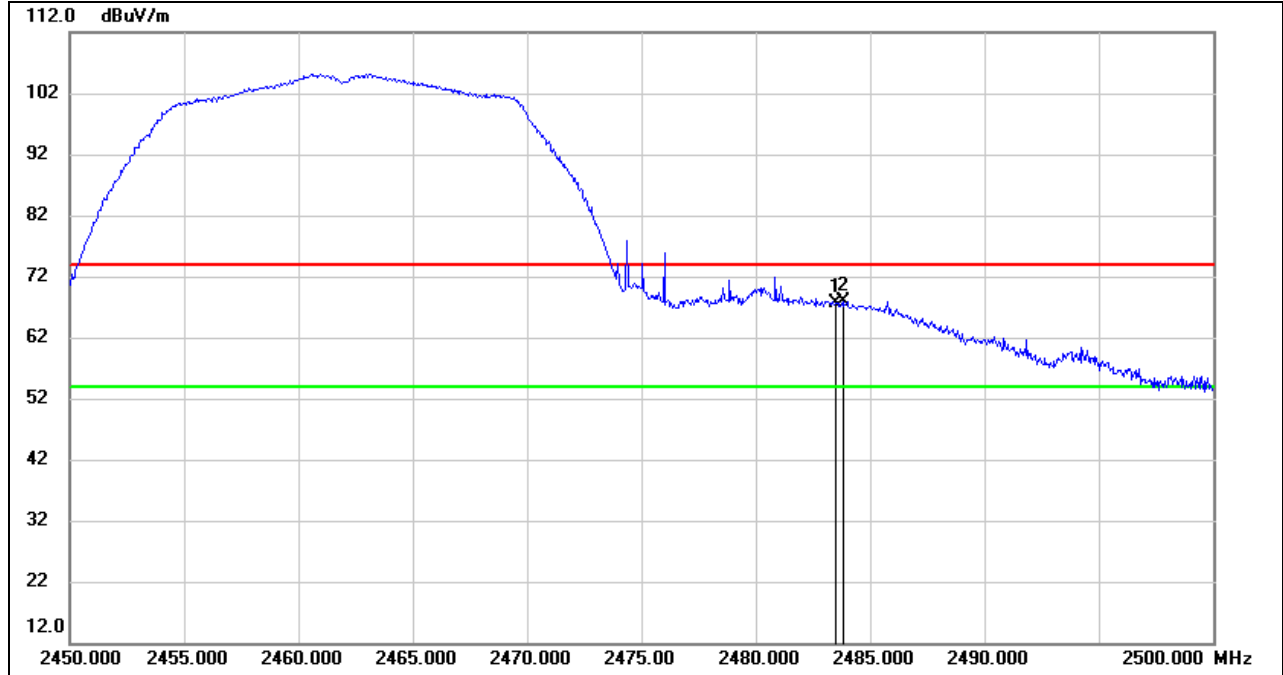

No.	Frequency (MHz)	Reading (dBuV)	Correct (dB/m)	Result (dBuV/m)	Limit (dBuV/m)	Margin (dB)	Remark
1	2483.500	55.63	11.97	67.60	74.00	-6.40	peak
2	2483.800	55.88	11.97	67.85	74.00	-6.15	peak

- Note: 1. Measurement = Reading Level + Correct Factor.
 2. If Peak Result complies with AV limit, AV Result is deemed to comply with AV limit.
 3. Peak: Peak detector.
 4. Only the worst data was recorded, if it complies with the limit, the other emissions deemed to comply with the limit.



AVG

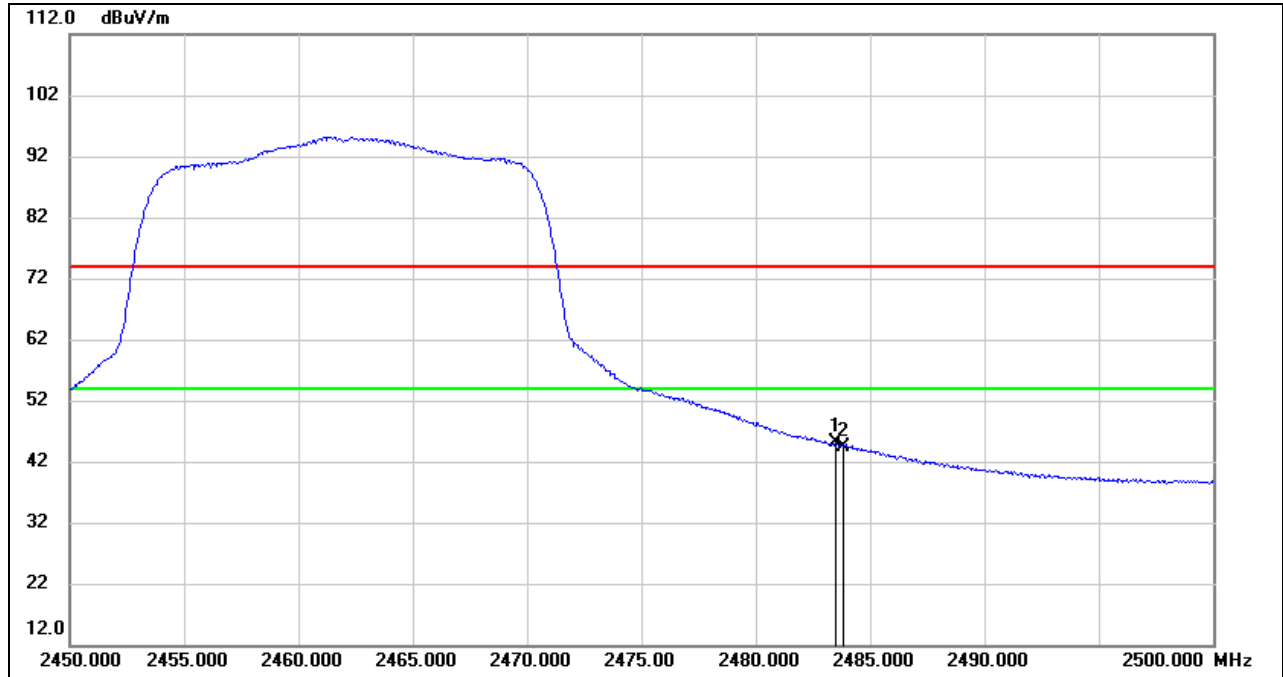

No.	Frequency (MHz)	Reading (dBuV)	Correct (dB/m)	Result (dBuV/m)	Limit (dBuV/m)	Margin (dB)	Remark
1	2483.500	33.04	11.97	45.01	54.00	-8.99	AVG
2	2483.800	32.51	11.97	44.48	54.00	-9.52	AVG

- Note: 1. Measurement = Reading Level + Correct Factor.
 2. If Peak Result complies with AV limit, AV Result is deemed to comply with AV limit.
 3. AVG: VBW=1/Ton, where: Ton is the transmitting duration.
 4. For the transmitting duration, please refer to clause 7.1.
 5. Only the worst data was recorded, if it complies with the limit, the other emissions deemed to comply with the limit.



8.1.3. 802.11n HT20 SISO MODE

RESTRICTED BANDEDGE (LOW CHANNEL, HORIZONTAL)

PEAK

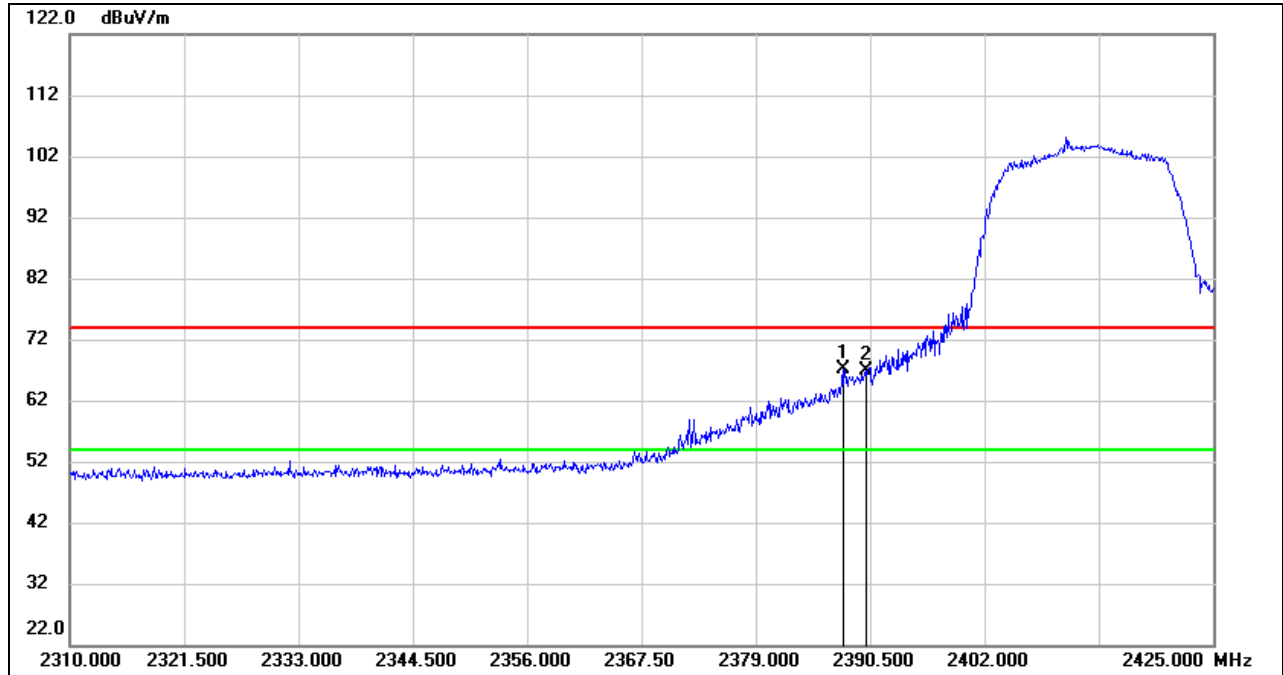

No.	Frequency (MHz)	Reading (dBuV)	Correct (dB/m)	Result (dBuV/m)	Limit (dBuV/m)	Margin (dB)	Remark
1	2387.740	55.29	11.95	67.24	74.00	-6.76	peak
2	2390.000	54.87	11.96	66.83	74.00	-7.17	peak

- Note: 1. Measurement = Reading Level + Correct Factor.
 2. If Peak Result complies with AV limit, AV Result is deemed to comply with AV limit.
 3. Peak: Peak detector.
 4. Only the worst data was recorded, if it complies with the limit, the other emissions deemed to comply with the limit.



AVG

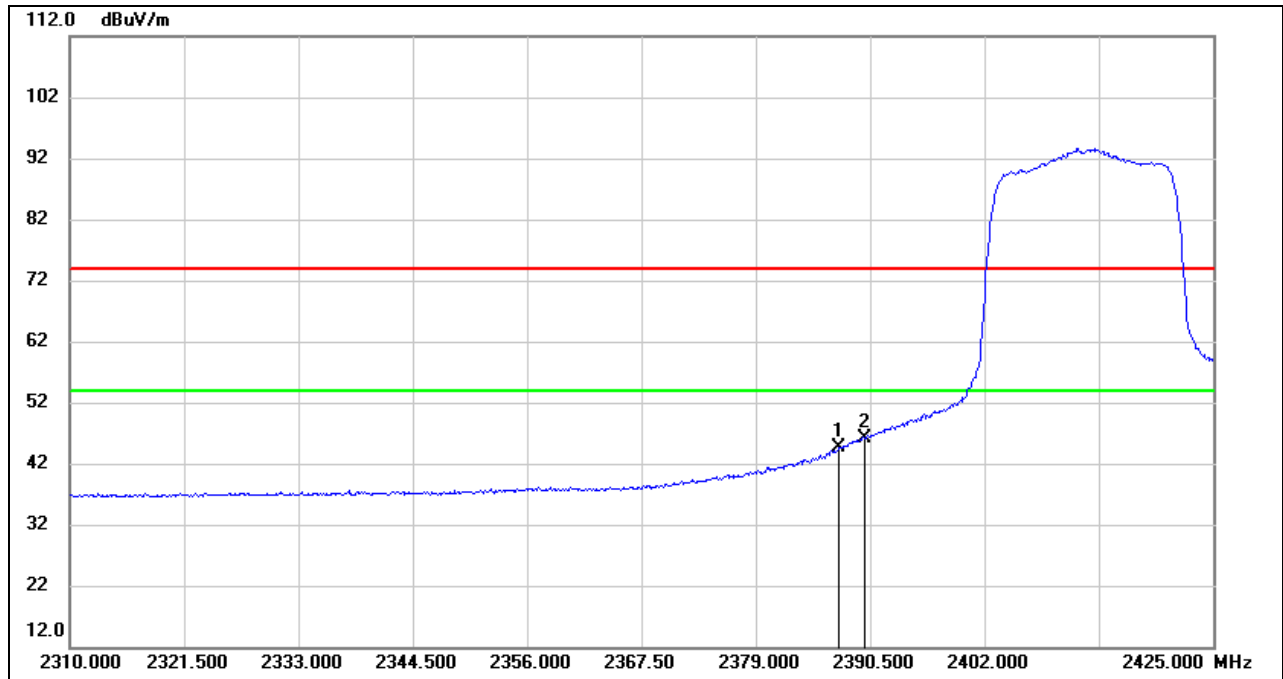

No.	Frequency (MHz)	Reading (dBuV)	Correct (dB/m)	Result (dBuV/m)	Limit (dBuV/m)	Margin (dB)	Remark
1	2387.740	32.62	11.95	44.57	54.00	-9.43	AVG
2	2390.000	34.05	11.96	46.01	54.00	-7.99	AVG

- Note: 1. Measurement = Reading Level + Correct Factor.
 2. If Peak Result complies with AV limit, AV Result is deemed to comply with AV limit.
 3. AVG: $VBW=1/Ton$, where: Ton is the transmitting duration.
 4. For the transmitting duration, please refer to clause 7.1.
 5. Only the worst data was recorded, if it complies with the limit, the other emissions deemed to comply with the limit.



RESTRICTED BANDEDGE (HIGH CHANNEL, HORIZONTAL)

PEAK

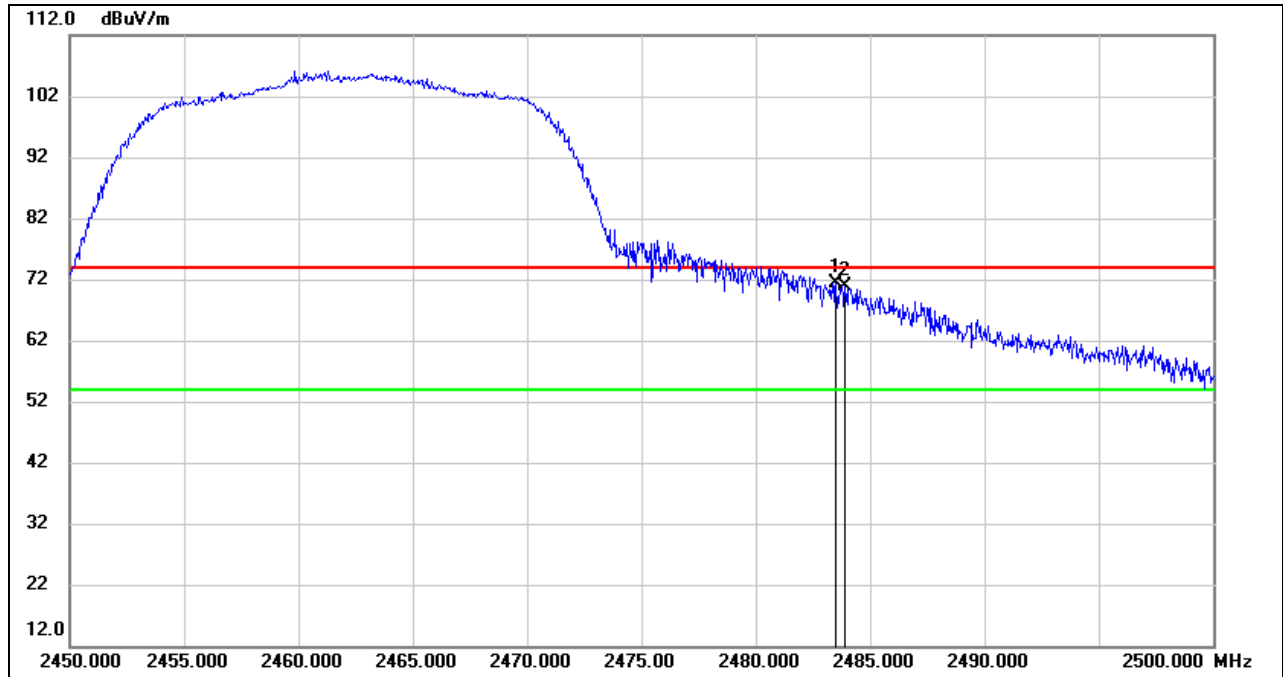

No.	Frequency (MHz)	Reading (dBuV)	Correct (dB/m)	Result (dBuV/m)	Limit (dBuV/m)	Margin (dB)	Remark
1	2483.500	59.44	11.97	71.41	74.00	-2.59	peak
2	2483.900	58.99	11.97	70.96	74.00	-3.04	peak

- Note: 1. Measurement = Reading Level + Correct Factor.
 2. If Peak Result complies with AV limit, AV Result is deemed to comply with AV limit.
 3. Peak: Peak detector.
 4. Only the worst data was recorded, if it complies with the limit, the other emissions deemed to comply with the limit.

AVG

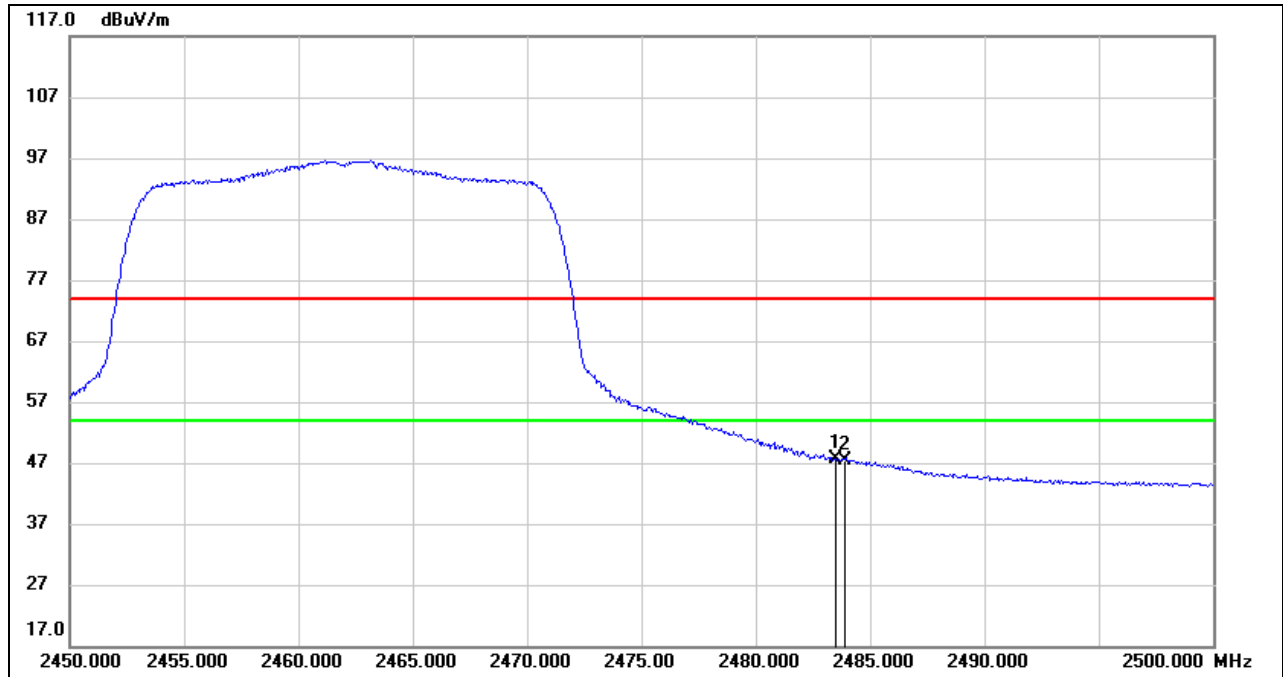

No.	Frequency (MHz)	Reading (dBuV)	Correct (dB/m)	Result (dBuV/m)	Limit (dBuV/m)	Margin (dB)	Remark
1	2483.500	35.70	11.97	47.67	54.00	-6.33	AVG
2	2483.900	35.53	11.97	47.50	54.00	-6.50	AVG

- Note: 1. Measurement = Reading Level + Correct Factor.
 2. If Peak Result complies with AV limit, AV Result is deemed to comply with AV limit.
 3. AVG: $VBW=1/Ton$, where: Ton is the transmitting duration.
 4. For the transmitting duration, please refer to clause 7.1.
 5. Only the worst data was recorded, if it complies with the limit, the other emissions deemed to comply with the limit.

Note: All the polarities (vertical and horizontal) had been tested, only the worst data was recorded in the report.

8.2. SPURIOUS EMISSIONS (1 GHz ~ 3 GHz)

8.2.1. 802.11g SISO MODE

HARMONICS AND SPURIOUS EMISSIONS (LOW CHANNEL, HORIZONTAL)

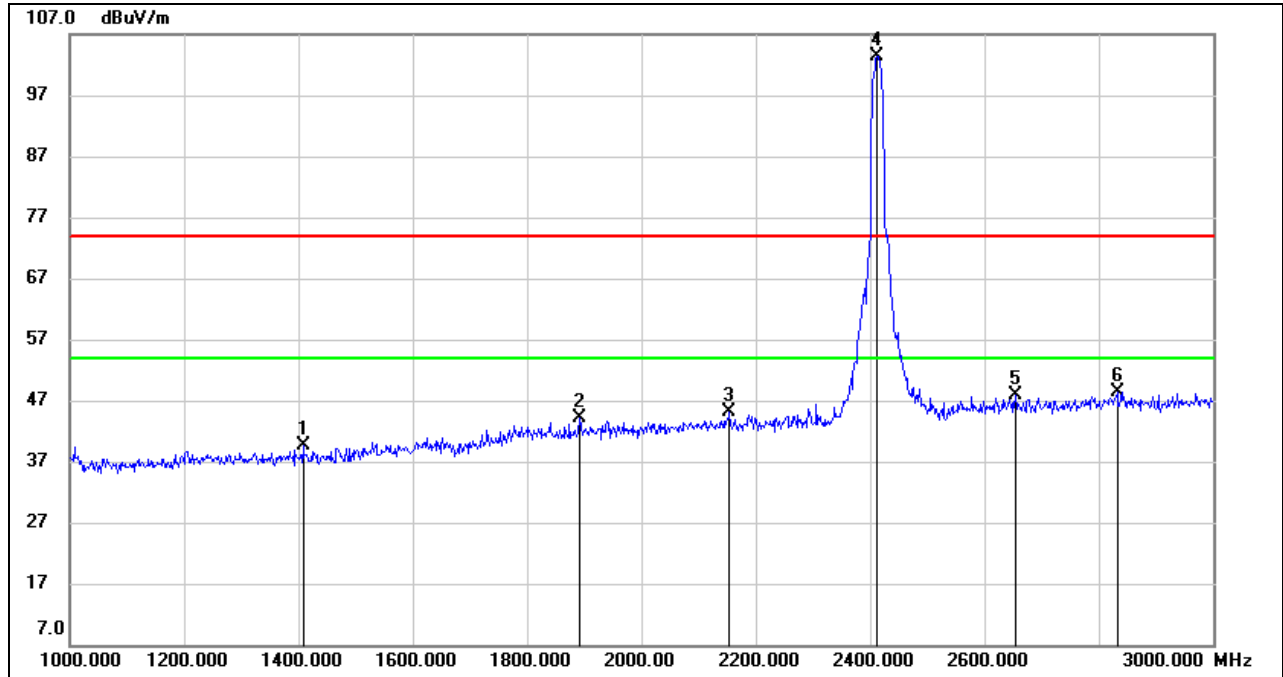

No.	Frequency (MHz)	Reading (dBuV)	Correct (dB/m)	Result (dBuV/m)	Limit (dBuV/m)	Margin (dB)	Remark
1	1408.000	32.92	6.71	39.63	74.00	-34.37	peak
2	1892.000	34.18	9.95	44.13	74.00	-29.87	peak
3	2154.000	33.95	11.19	45.14	74.00	-28.86	peak
4	2412.000	91.34	12.08	103.42	/	/	fundamental
5	2654.000	35.06	12.72	47.78	74.00	-26.22	peak
6	2832.000	34.46	13.85	48.31	74.00	-25.69	peak

- Note: 1. Measurement = Reading Level + Correct Factor.
 2. If Peak Result complies with AV limit, AV Result is deemed to comply with AV limit.
 3. Peak: Peak detector.



HARMONICS AND SPURIOUS EMISSIONS (LOW CHANNEL, VERTICAL)

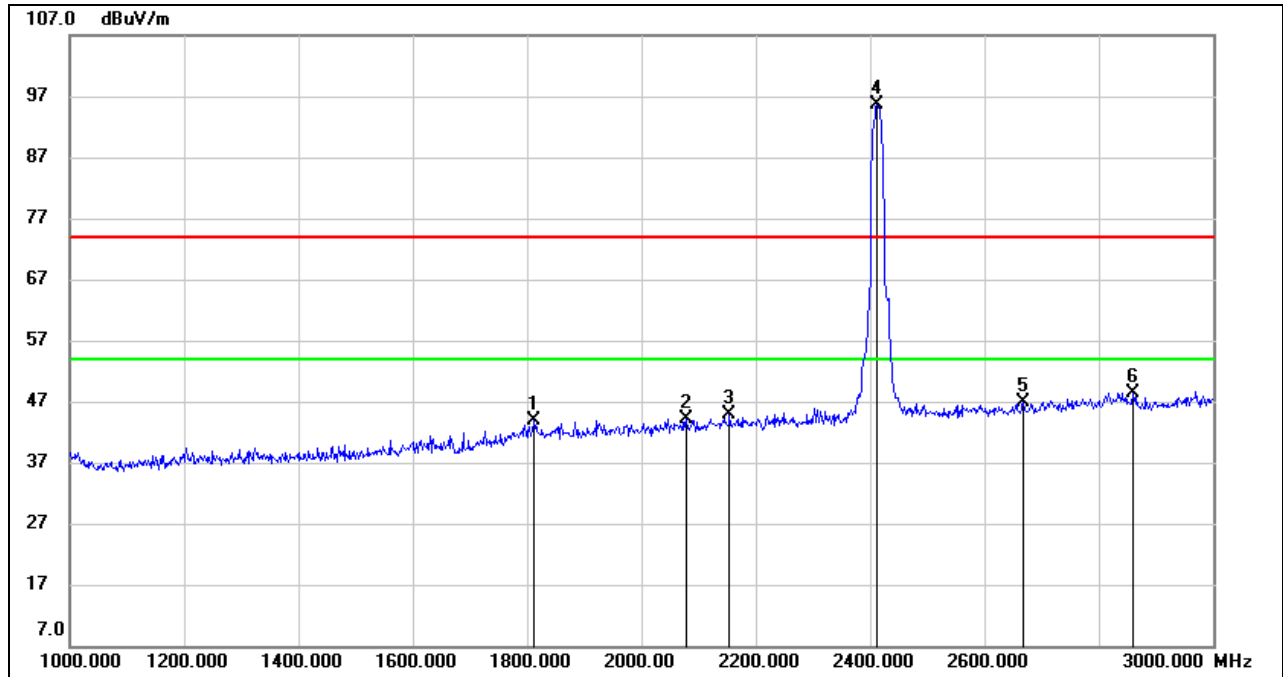

No.	Frequency (MHz)	Reading (dBuV)	Correct (dB/m)	Result (dBuV/m)	Limit (dBuV/m)	Margin (dB)	Remark
1	1812.000	34.06	9.82	43.88	74.00	-30.12	peak
2	2078.000	33.36	10.86	44.22	74.00	-29.78	peak
3	2154.000	33.67	11.19	44.86	74.00	-29.14	peak
4	2412.000	83.57	12.08	95.65	/	/	fundamental
5	2668.000	34.02	12.80	46.82	74.00	-27.18	peak
6	2860.000	34.54	13.93	48.47	74.00	-25.53	peak

Note: 1. Measurement = Reading Level + Correct Factor.
 2. If Peak Result complies with AV limit, AV Result is deemed to comply with AV limit.
 3. Peak: Peak detector.

HARMONICS AND SPURIOUS EMISSIONS (MID CHANNEL, HORIZONTAL)

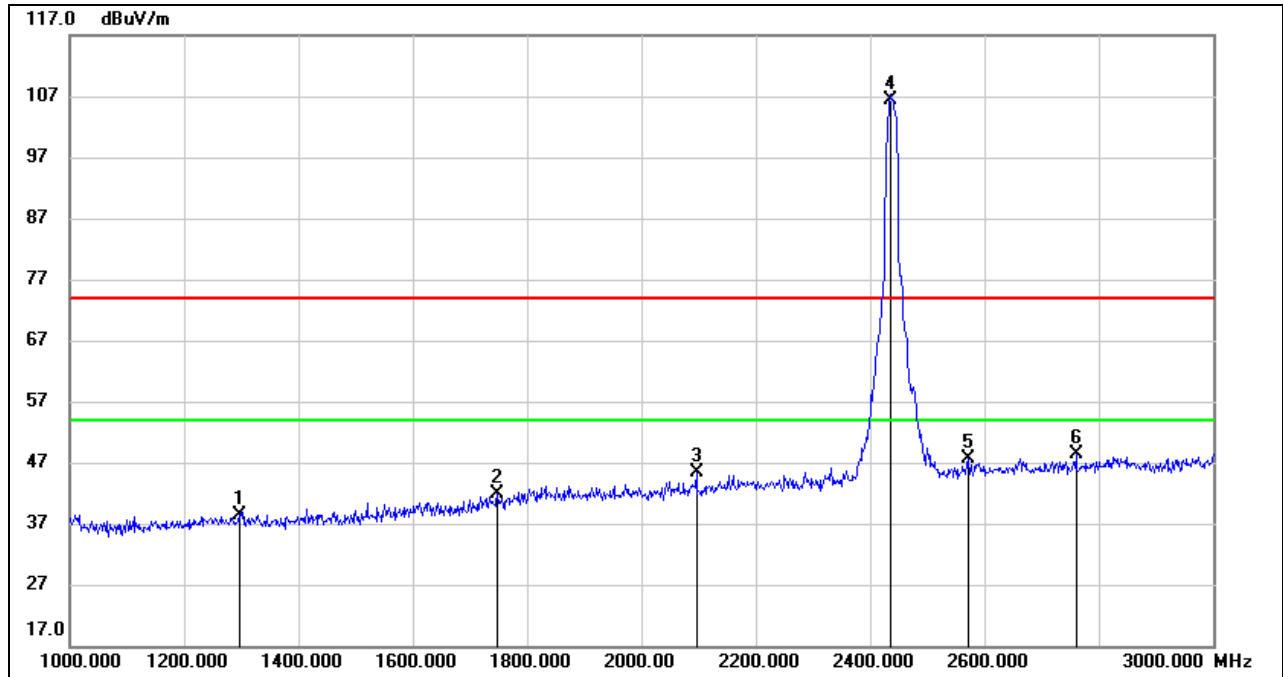

No.	Frequency (MHz)	Reading (dBuV)	Correct (dB/m)	Result (dBuV/m)	Limit (dBuV/m)	Margin (dB)	Remark
1	1296.000	31.74	6.60	38.34	74.00	-35.66	peak
2	1748.000	32.88	8.97	41.85	74.00	-32.15	peak
3	2096.000	34.26	11.00	45.26	74.00	-28.74	peak
4	2437.000	94.15	12.19	106.34	/	/	fundamental
5	2572.000	35.25	12.42	47.67	74.00	-26.33	peak
6	2760.000	34.85	13.46	48.31	74.00	-25.69	peak

Note: 1. Measurement = Reading Level + Correct Factor.
 2. If Peak Result complies with AV limit, AV Result is deemed to comply with AV limit.
 3. Peak: Peak detector.

HARMONICS AND SPURIOUS EMISSIONS (MID CHANNEL, VERTICAL)

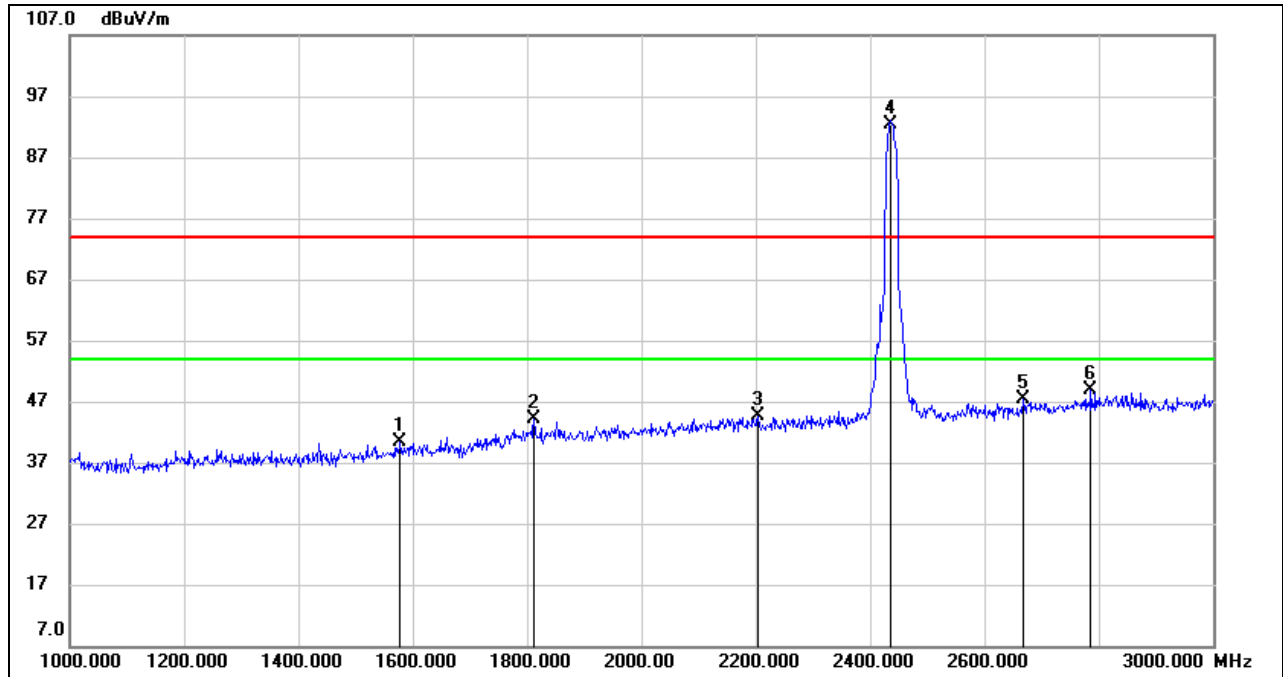

No.	Frequency (MHz)	Reading (dBuV)	Correct (dB/m)	Result (dBuV/m)	Limit (dBuV/m)	Margin (dB)	Remark
1	1578.000	32.67	7.76	40.43	74.00	-33.57	peak
2	1812.000	34.35	9.82	44.17	74.00	-29.83	peak
3	2204.000	33.29	11.32	44.61	74.00	-29.39	peak
4	2437.000	80.13	12.19	92.32	/	/	fundamental
5	2668.000	34.55	12.80	47.35	74.00	-26.65	peak
6	2786.000	35.18	13.66	48.84	74.00	-25.16	peak

Note: 1. Measurement = Reading Level + Correct Factor.
 2. If Peak Result complies with AV limit, AV Result is deemed to comply with AV limit.
 3. Peak: Peak detector.

HARMONICS AND SPURIOUS EMISSIONS (HIGH CHANNEL, HORIZONTAL)

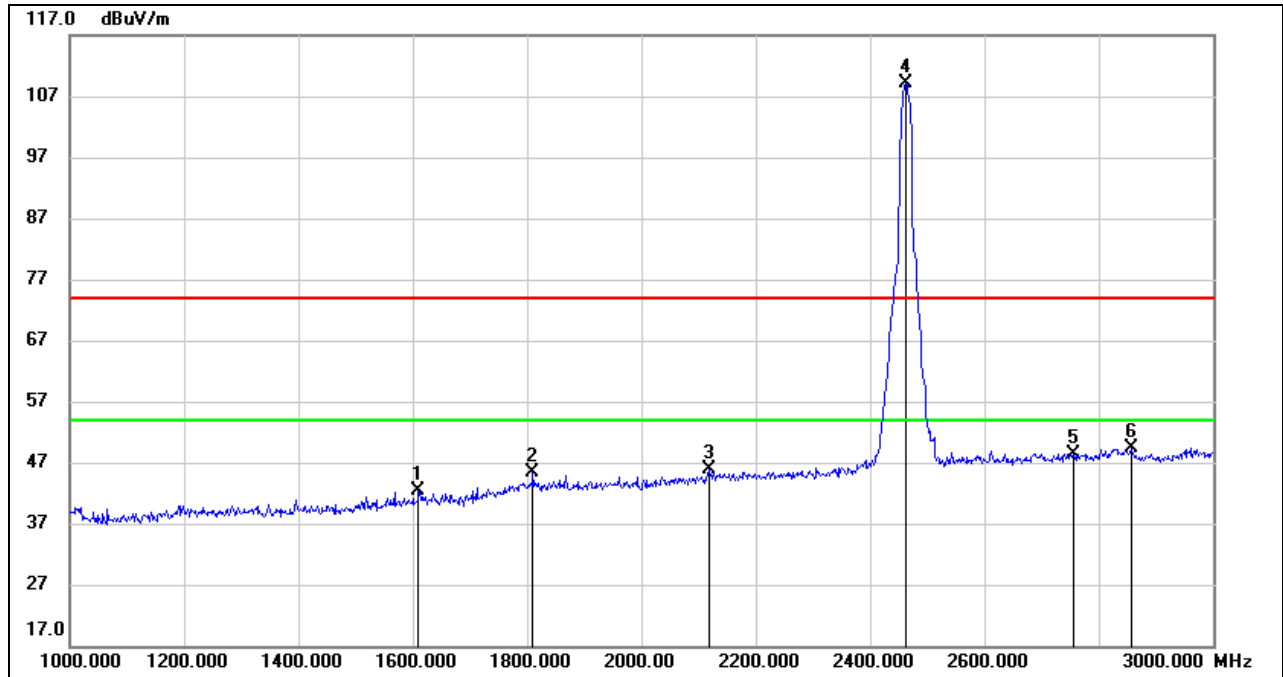

No.	Frequency (MHz)	Reading (dBuV)	Correct (dB/m)	Result (dBuV/m)	Limit (dBuV/m)	Margin (dB)	Remark
1	1610.000	34.44	8.00	42.44	74.00	-31.56	peak
2	1810.000	35.46	9.81	45.27	74.00	-28.73	peak
3	2118.000	34.85	11.08	45.93	74.00	-28.07	peak
4	2462.000	96.79	12.29	109.08	/	/	fundamental
5	2756.000	35.05	13.42	48.47	74.00	-25.53	peak
6	2856.000	35.35	13.91	49.26	74.00	-24.74	peak

Note: 1. Measurement = Reading Level + Correct Factor.
 2. If Peak Result complies with AV limit, AV Result is deemed to comply with AV limit.
 3. Peak: Peak detector.

HARMONICS AND SPURIOUS EMISSIONS (HIGH CHANNEL, VERTICAL)

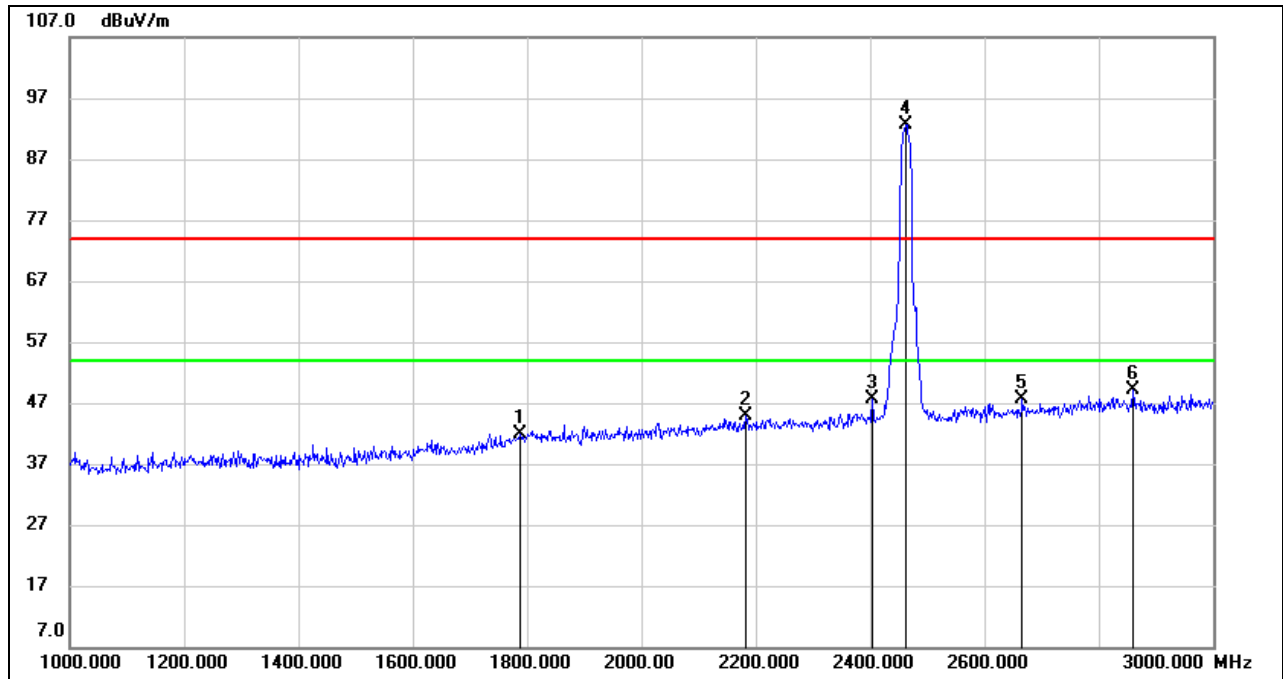

No.	Frequency (MHz)	Reading (dBuV)	Correct (dB/m)	Result (dBuV/m)	Limit (dBuV/m)	Margin (dB)	Remark
1	1788.000	32.37	9.60	41.97	74.00	-32.03	peak
2	2182.000	33.55	11.27	44.82	74.00	-29.18	peak
3	2404.000	35.55	12.05	47.60	74.00	-26.40	peak
4	2462.000	80.31	12.29	92.60	/	/	fundamental
5	2666.000	34.80	12.80	47.60	74.00	-26.40	peak
6	2860.000	35.28	13.93	49.21	74.00	-24.79	peak

Note: 1. Measurement = Reading Level + Correct Factor.
 2. If Peak Result complies with AV limit, AV Result is deemed to comply with AV limit.
 3. Peak: Peak detector.

Note: All the modes and channels had been tested, but only the worst data was recorded in the report.

8.3. SPURIOUS EMISSIONS (3 GHz ~ 18 GHz)

8.3.1. 802.11b SISO MODE

HARMONICS AND SPURIOUS EMISSIONS (LOW CHANNEL, HORIZONTAL)

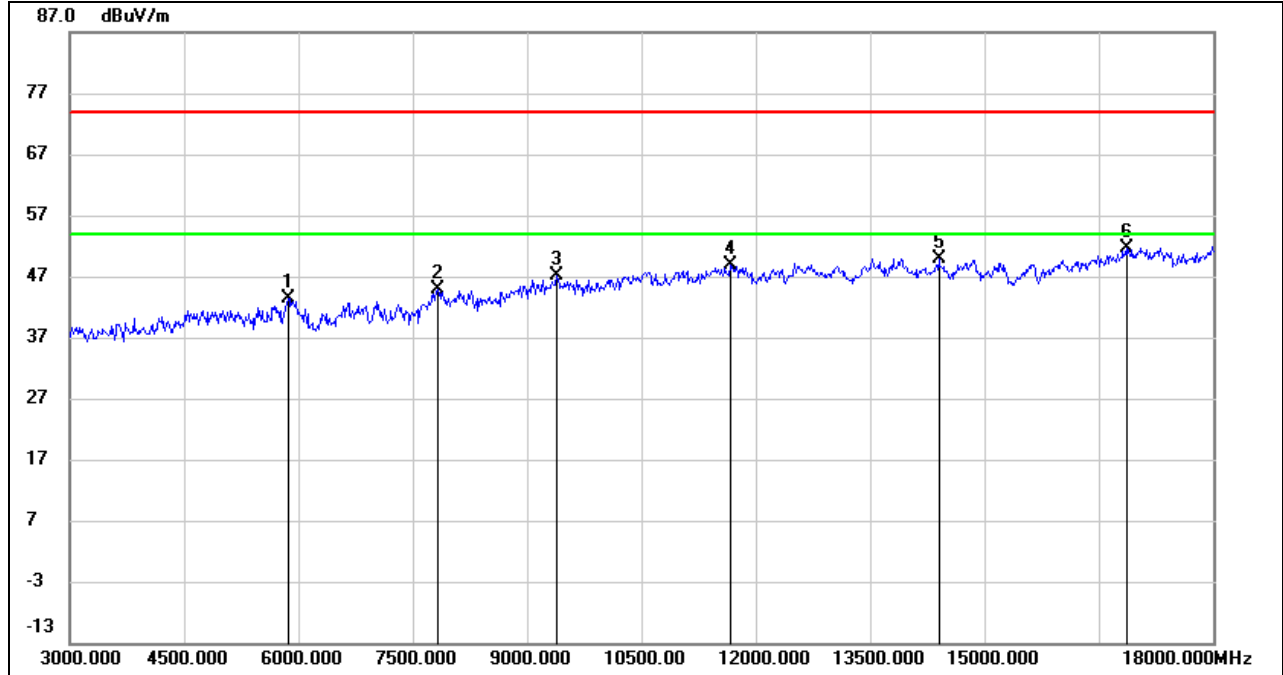

No.	Frequency (MHz)	Reading (dBuV)	Correct (dB/m)	Result (dBuV/m)	Limit (dBuV/m)	Margin (dB)	Remark
1	5865.000	39.11	4.30	43.41	74.00	-30.59	peak
2	7830.000	37.26	7.72	44.98	74.00	-29.02	peak
3	9390.000	37.63	9.53	47.16	74.00	-26.84	peak
4	11670.000	35.96	13.01	48.97	74.00	-25.03	peak
5	14400.000	33.45	16.35	49.80	74.00	-24.20	peak
6	16860.000	31.74	19.95	51.69	74.00	-22.31	peak

- Note: 1. Peak Result = Reading Level + Correct Factor.
 2. If Peak Result complies with AV limit, AV Result is deemed to comply with AV limit.
 3. Peak: Peak detector.
 4. Filter losses were only considered in the spurious frequency bands and the authorized band was not corrected for High Pass Filter losses.
 5. Proper operation of the transmitter prior to adding the filter to the measurement chain.

HARMONICS AND SPURIOUS EMISSIONS (LOW CHANNEL, VERTICAL)

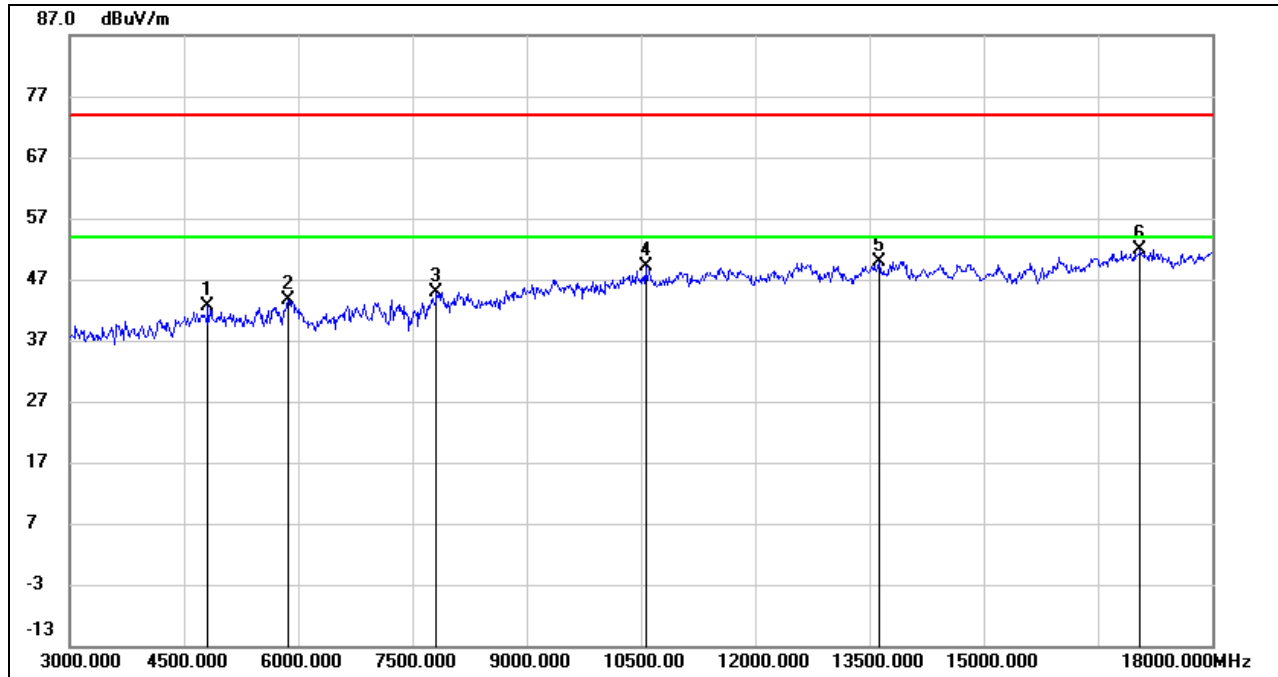

No.	Frequency (MHz)	Reading (dBuV)	Correct (dB/m)	Result (dBuV/m)	Limit (dBuV/m)	Margin (dB)	Remark
1	4815.000	42.03	0.51	42.54	74.00	-31.46	peak
2	5865.000	39.32	4.30	43.62	74.00	-30.38	peak
3	7815.000	37.08	7.83	44.91	74.00	-29.09	peak
4	10560.000	37.47	11.73	49.20	74.00	-24.80	peak
5	13620.000	33.97	15.99	49.96	74.00	-24.04	peak
6	17055.000	31.33	20.53	51.86	74.00	-22.14	peak

- Note: 1. Peak Result = Reading Level + Correct Factor.
 2. If Peak Result complies with AV limit, AV Result is deemed to comply with AV limit.
 3. Peak: Peak detector.
 4. Filter losses were only considered in the spurious frequency bands and the authorized band was not corrected for High Pass Filter losses.
 5. Proper operation of the transmitter prior to adding the filter to the measurement chain.



HARMONICS AND SPURIOUS EMISSIONS (MID CHANNEL, HORIZONTAL)

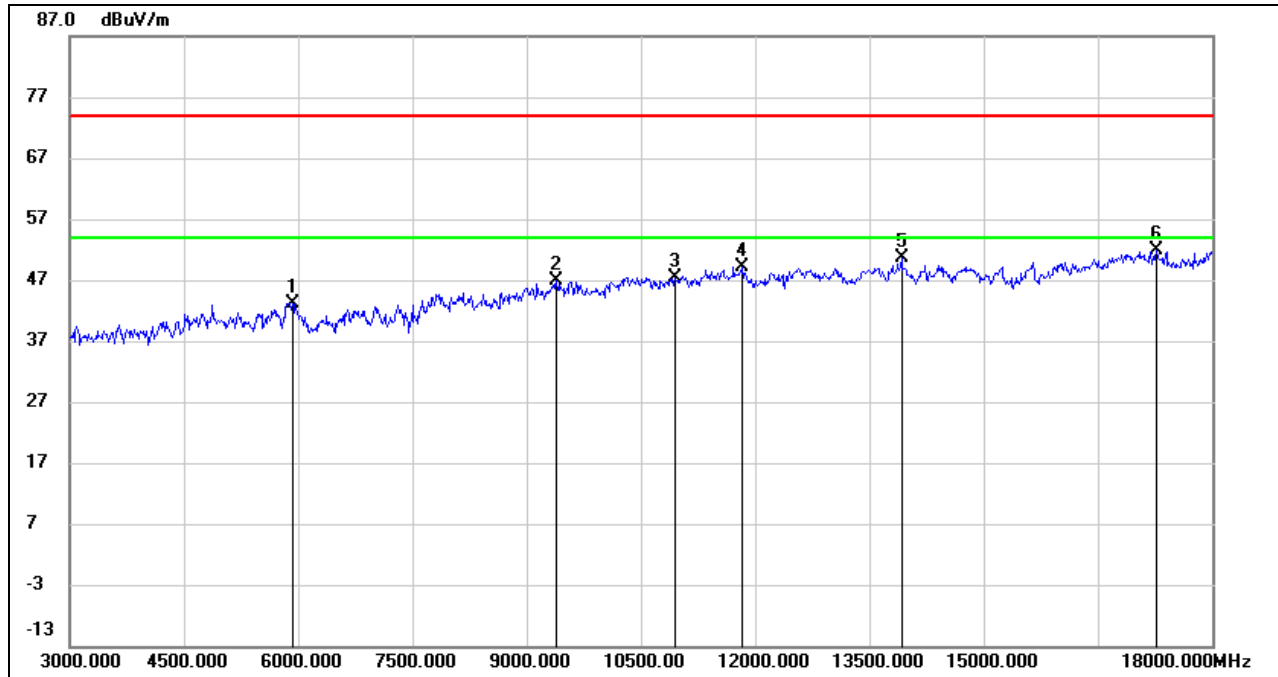

No.	Frequency (MHz)	Reading (dBuV)	Correct (dB/m)	Result (dBuV/m)	Limit (dBuV/m)	Margin (dB)	Remark
1	5925.000	38.57	4.54	43.11	74.00	-30.89	peak
2	9390.000	37.30	9.53	46.83	74.00	-27.17	peak
3	10950.000	35.32	12.18	47.50	74.00	-26.50	peak
4	11835.000	35.99	13.21	49.20	74.00	-24.80	peak
5	13920.000	34.36	16.17	50.53	74.00	-23.47	peak
6	17265.000	30.42	21.46	51.88	74.00	-22.12	peak

- Note: 1. Peak Result = Reading Level + Correct Factor.
 2. If Peak Result complies with AV limit, AV Result is deemed to comply with AV limit.
 3. Peak: Peak detector.
 4. Filter losses were only considered in the spurious frequency bands and the authorized band was not corrected for High Pass Filter losses.
 5. Proper operation of the transmitter prior to adding the filter to the measurement chain.



HARMONICS AND SPURIOUS EMISSIONS (MID CHANNEL, VERTICAL)

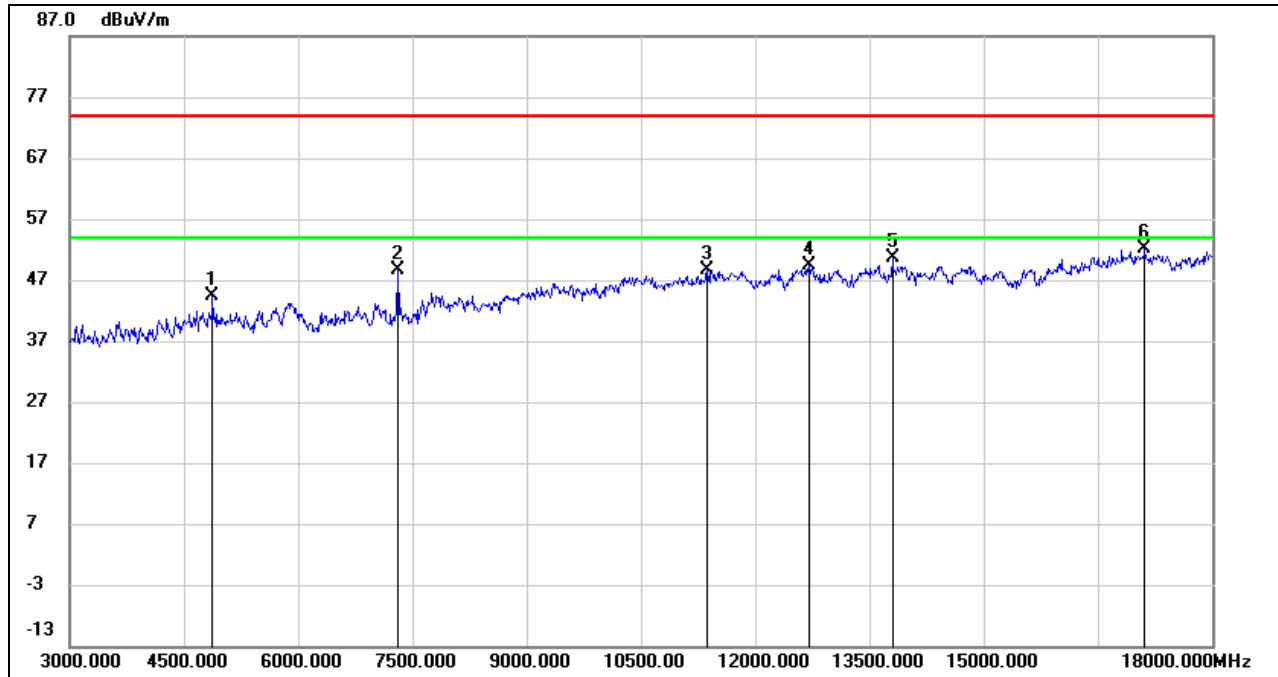

No.	Frequency (MHz)	Reading (dBuV)	Correct (dB/m)	Result (dBuV/m)	Limit (dBuV/m)	Margin (dB)	Remark
1	4875.000	43.68	0.76	44.44	74.00	-29.56	peak
2	7305.000	42.57	6.08	48.65	74.00	-25.35	peak
3	11370.000	36.04	12.54	48.58	74.00	-25.42	peak
4	12705.000	35.01	14.35	49.36	74.00	-24.64	peak
5	13800.000	33.51	17.10	50.61	74.00	-23.39	peak
6	17115.000	31.37	20.68	52.05	74.00	-21.95	peak

- Note: 1. Peak Result = Reading Level + Correct Factor.
 2. If Peak Result complies with AV limit, AV Result is deemed to comply with AV limit.
 3. Peak: Peak detector.
 4. Filter losses were only considered in the spurious frequency bands and the authorized band was not corrected for High Pass Filter losses.
 5. Proper operation of the transmitter prior to adding the filter to the measurement chain.

HARMONICS AND SPURIOUS EMISSIONS (HIGH CHANNEL, HORIZONTAL)

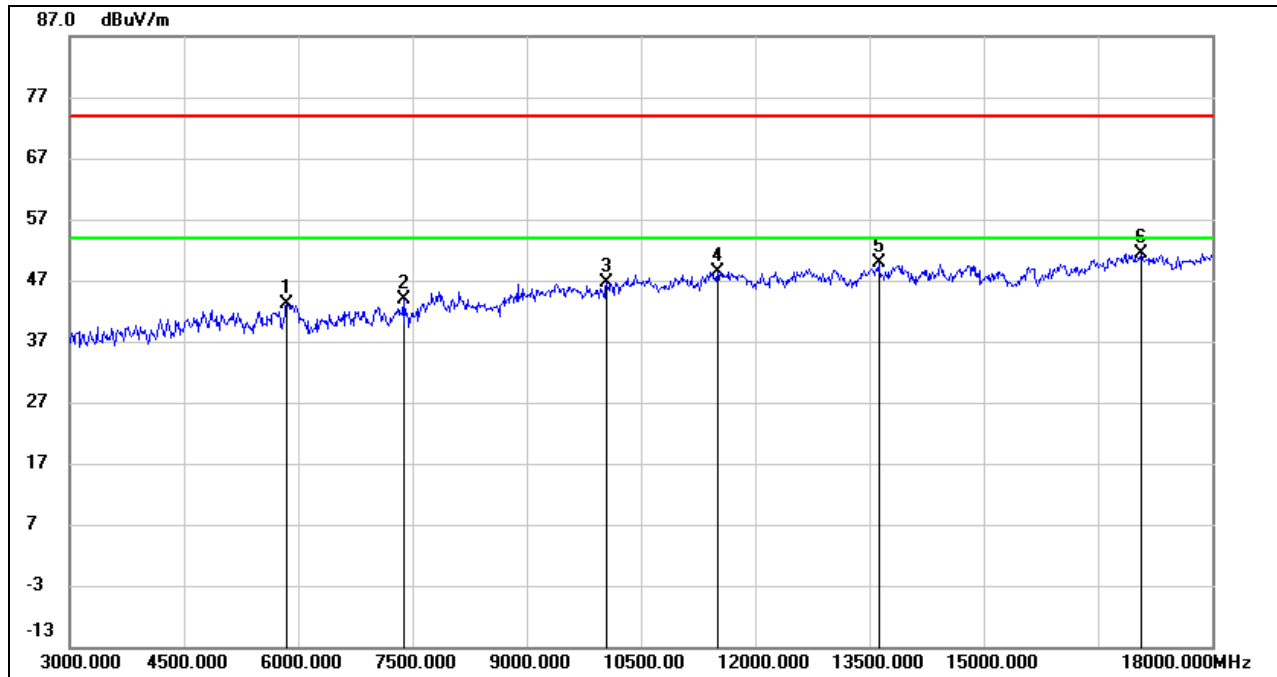

No.	Frequency (MHz)	Reading (dBuV)	Correct (dB/m)	Result (dBuV/m)	Limit (dBuV/m)	Margin (dB)	Remark
1	5850.000	39.10	4.02	43.12	74.00	-30.88	peak
2	7380.000	37.41	6.41	43.82	74.00	-30.18	peak
3	10050.000	36.34	10.33	46.67	74.00	-27.33	peak
4	11505.000	35.02	13.42	48.44	74.00	-25.56	peak
5	13620.000	33.88	15.99	49.87	74.00	-24.13	peak
6	17070.000	30.89	20.57	51.46	74.00	-22.54	peak

- Note: 1. Peak Result = Reading Level + Correct Factor.
 2. If Peak Result complies with AV limit, AV Result is deemed to comply with AV limit.
 3. Peak: Peak detector.
 4. Filter losses were only considered in the spurious frequency bands and the authorized band was not corrected for High Pass Filter losses.
 5. Proper operation of the transmitter prior to adding the filter to the measurement chain.

HARMONICS AND SPURIOUS EMISSIONS (HIGH CHANNEL, VERTICAL)

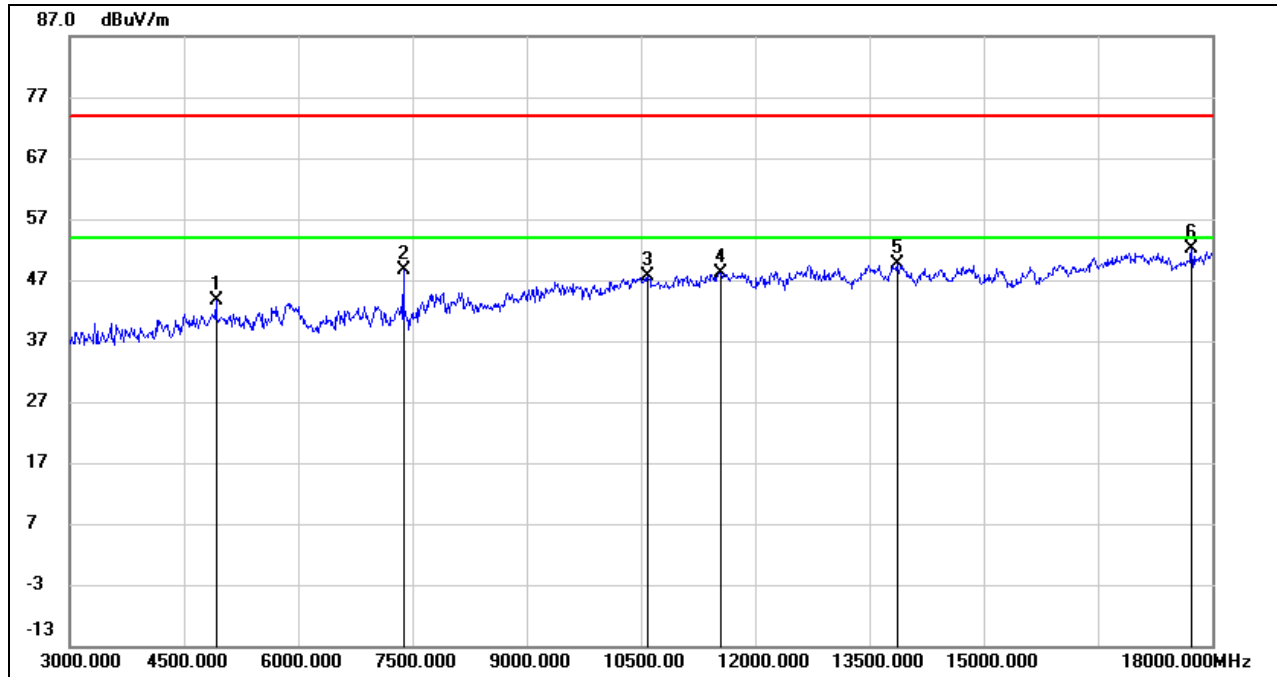

No.	Frequency (MHz)	Reading (dBuV)	Correct (dB/m)	Result (dBuV/m)	Limit (dBuV/m)	Margin (dB)	Remark
1	4920.000	42.64	0.96	43.60	74.00	-30.40	peak
2	7380.000	42.11	6.41	48.52	74.00	-25.48	peak
3	10590.000	35.73	11.88	47.61	74.00	-26.39	peak
4	11550.000	34.90	13.30	48.20	74.00	-25.80	peak
5	13860.000	33.03	16.56	49.59	74.00	-24.41	peak
6	17730.000	29.35	22.70	52.05	74.00	-21.95	peak

- Note: 1. Peak Result = Reading Level + Correct Factor.
 2. If Peak Result complies with AV limit, AV Result is deemed to comply with AV limit.
 3. Peak: Peak detector.
 4. Filter losses were only considered in the spurious frequency bands and the authorized band was not corrected for High Pass Filter losses.
 5. Proper operation of the transmitter prior to adding the filter to the measurement chain.

8.3.2. 802.11g SISO MODE

HARMONICS AND SPURIOUS EMISSIONS (LOW CHANNEL, HORIZONTAL)

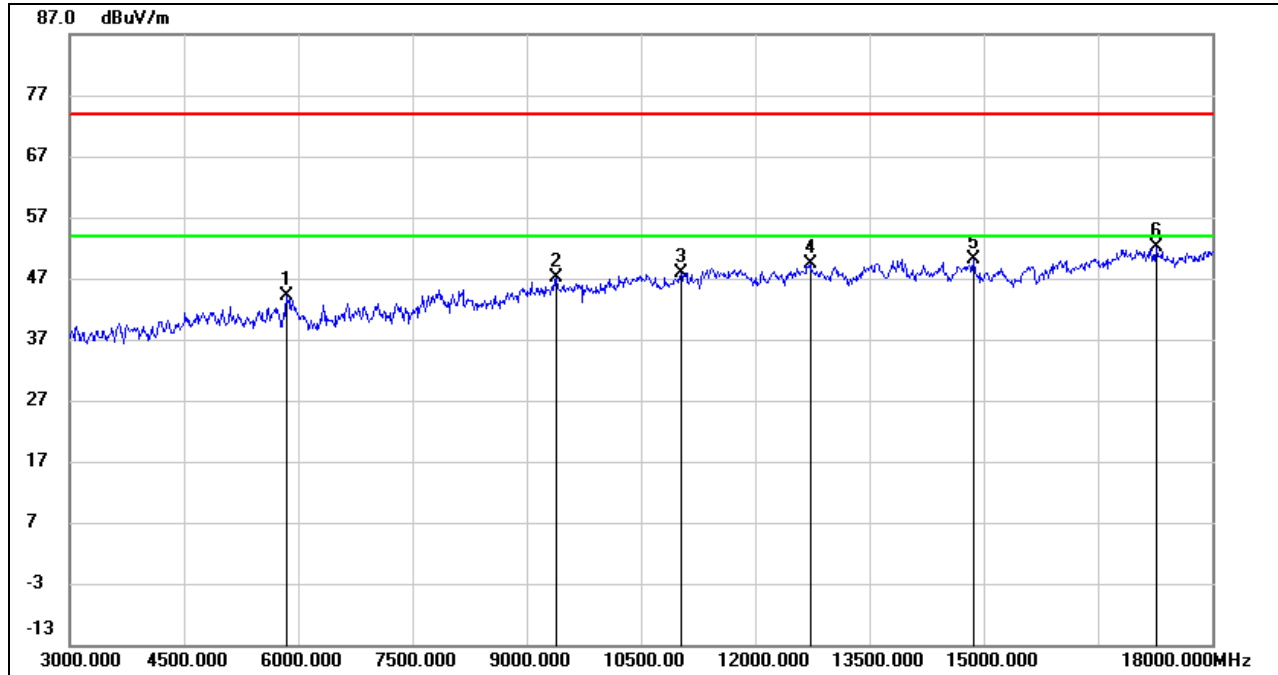

No.	Frequency (MHz)	Reading (dBuV)	Correct (dB/m)	Result (dBuV/m)	Limit (dBuV/m)	Margin (dB)	Remark
1	5850.000	39.99	4.02	44.01	74.00	-29.99	peak
2	9390.000	37.52	9.53	47.05	74.00	-26.95	peak
3	11025.000	35.28	12.61	47.89	74.00	-26.11	peak
4	12720.000	34.69	14.57	49.26	74.00	-24.74	peak
5	14865.000	34.14	15.98	50.12	74.00	-23.88	peak
6	17265.000	30.73	21.46	52.19	74.00	-21.81	peak

- Note: 1. Peak Result = Reading Level + Correct Factor.
 2. If Peak Result complies with AV limit, AV Result is deemed to comply with AV limit.
 3. Peak: Peak detector.
 4. Filter losses were only considered in the spurious frequency bands and the authorized band was not corrected for High Pass Filter losses.
 5. Proper operation of the transmitter prior to adding the filter to the measurement chain.



HARMONICS AND SPURIOUS EMISSIONS (LOW CHANNEL, VERTICAL)

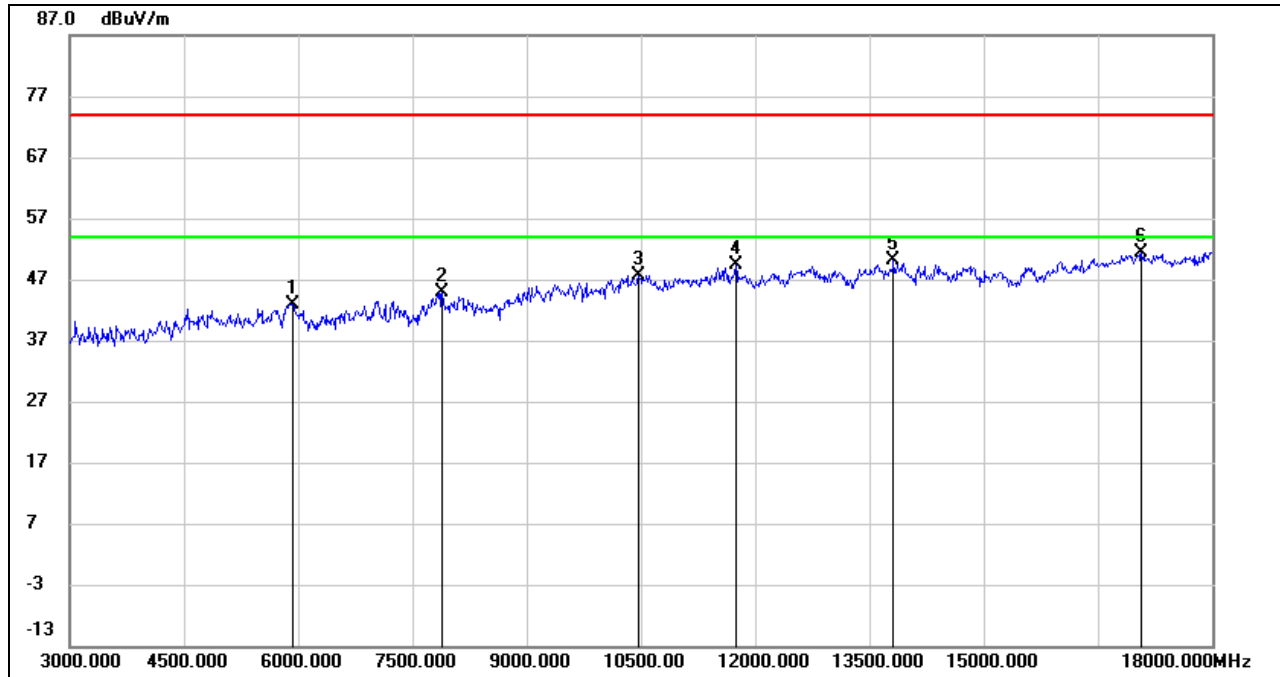

No.	Frequency (MHz)	Reading (dBuV)	Correct (dB/m)	Result (dBuV/m)	Limit (dBuV/m)	Margin (dB)	Remark
1	5925.000	38.45	4.54	42.99	74.00	-31.01	peak
2	7890.000	37.61	7.30	44.91	74.00	-29.09	peak
3	10470.000	36.44	11.25	47.69	74.00	-26.31	peak
4	11745.000	36.38	13.05	49.43	74.00	-24.57	peak
5	13815.000	33.22	16.97	50.19	74.00	-23.81	peak
6	17070.000	30.70	20.57	51.27	74.00	-22.73	peak

- Note: 1. Peak Result = Reading Level + Correct Factor.
 2. If Peak Result complies with AV limit, AV Result is deemed to comply with AV limit.
 3. Peak: Peak detector.
 4. Filter losses were only considered in the spurious frequency bands and the authorized band was not corrected for High Pass Filter losses.
 5. Proper operation of the transmitter prior to adding the filter to the measurement chain.

HARMONICS AND SPURIOUS EMISSIONS (MID CHANNEL, HORIZONTAL)

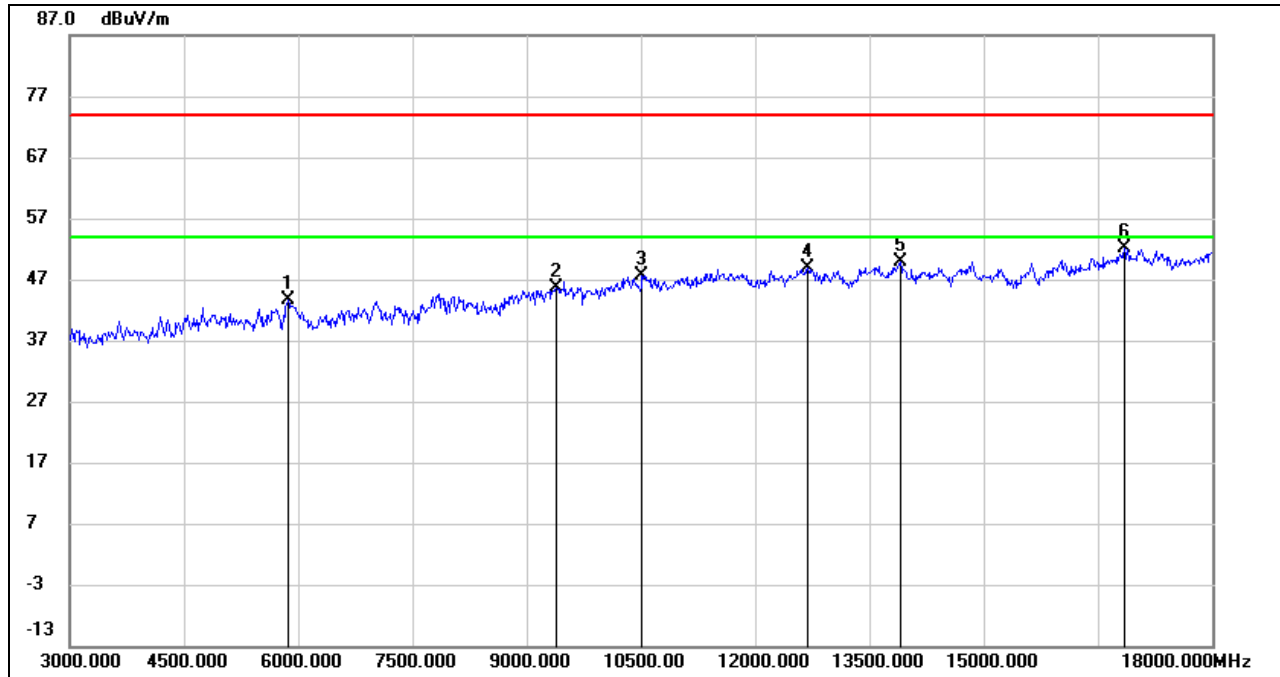

No.	Frequency (MHz)	Reading (dBuV)	Correct (dB/m)	Result (dBuV/m)	Limit (dBuV/m)	Margin (dB)	Remark
1	5865.000	39.22	4.30	43.52	74.00	-30.48	peak
2	9390.000	36.00	9.53	45.53	74.00	-28.47	peak
3	10515.000	36.20	11.47	47.67	74.00	-26.33	peak
4	12690.000	34.71	14.25	48.96	74.00	-25.04	peak
5	13905.000	33.76	16.20	49.96	74.00	-24.04	peak
6	16845.000	32.21	19.96	52.17	74.00	-21.83	peak

- Note: 1. Peak Result = Reading Level + Correct Factor.
 2. If Peak Result complies with AV limit, AV Result is deemed to comply with AV limit.
 3. Peak: Peak detector.
 4. Filter losses were only considered in the spurious frequency bands and the authorized band was not corrected for High Pass Filter losses.
 5. Proper operation of the transmitter prior to adding the filter to the measurement chain.

HARMONICS AND SPURIOUS EMISSIONS (MID CHANNEL, VERTICAL)

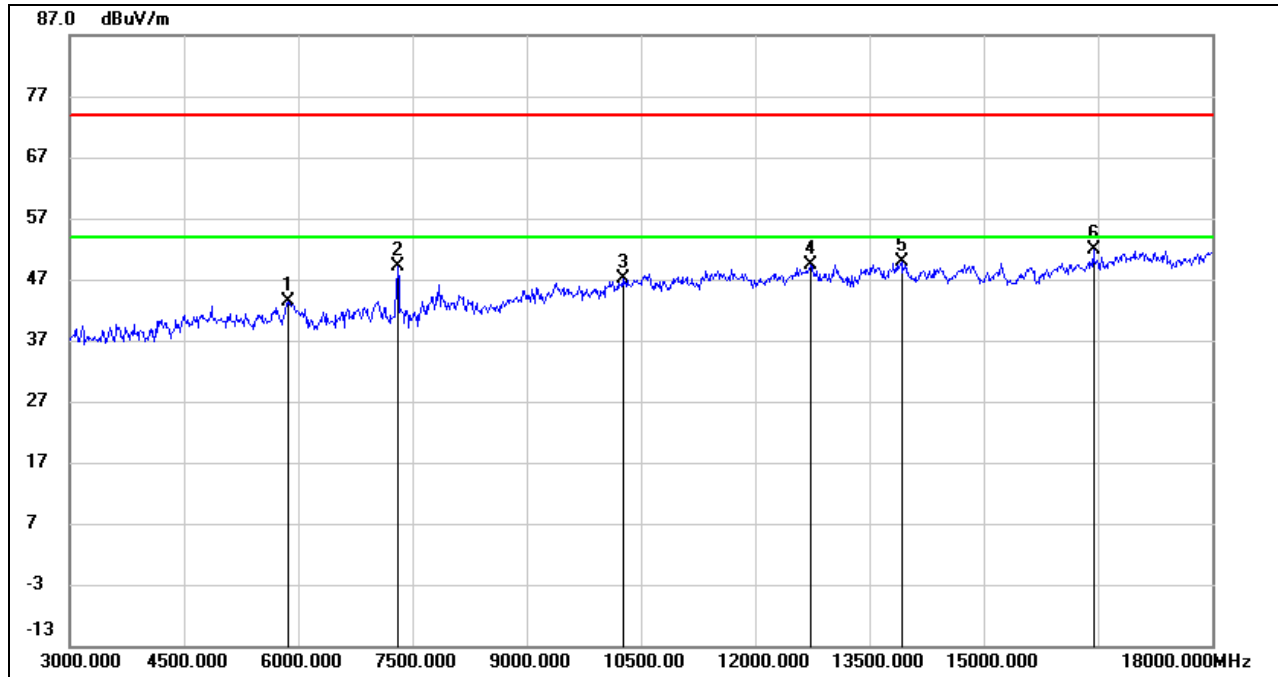

No.	Frequency (MHz)	Reading (dBuV)	Correct (dB/m)	Result (dBuV/m)	Limit (dBuV/m)	Margin (dB)	Remark
1	5865.000	39.14	4.30	43.44	74.00	-30.56	peak
2	7305.000	43.05	6.08	49.13	74.00	-24.87	peak
3	10260.000	36.48	10.71	47.19	74.00	-26.81	peak
4	12735.000	34.60	14.77	49.37	74.00	-24.63	peak
5	13920.000	33.71	16.17	49.88	74.00	-24.12	peak
6	16440.000	33.00	18.94	51.94	74.00	-22.06	peak

- Note: 1. Peak Result = Reading Level + Correct Factor.
 2. If Peak Result complies with AV limit, AV Result is deemed to comply with AV limit.
 3. Peak: Peak detector.
 4. Filter losses were only considered in the spurious frequency bands and the authorized band was not corrected for High Pass Filter losses.
 5. Proper operation of the transmitter prior to adding the filter to the measurement chain.

HARMONICS AND SPURIOUS EMISSIONS (HIGH CHANNEL, HORIZONTAL)

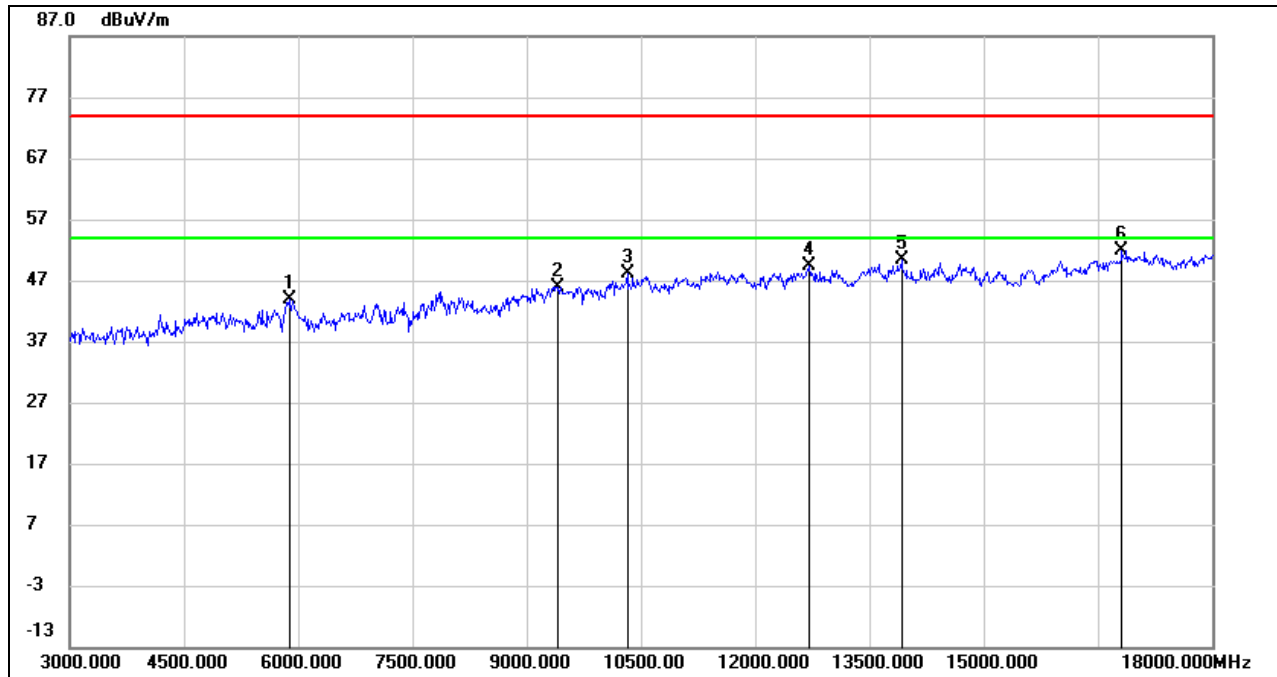

No.	Frequency (MHz)	Reading (dBuV)	Correct (dB/m)	Result (dBuV/m)	Limit (dBuV/m)	Margin (dB)	Remark
1	5880.000	39.36	4.59	43.95	74.00	-30.05	peak
2	9405.000	36.22	9.59	45.81	74.00	-28.19	peak
3	10320.000	36.97	11.05	48.02	74.00	-25.98	peak
4	12705.000	35.01	14.35	49.36	74.00	-24.64	peak
5	13920.000	34.10	16.17	50.27	74.00	-23.73	peak
6	16815.000	31.82	19.96	51.78	74.00	-22.22	peak

Note: 1. Peak Result = Reading Level + Correct Factor.

2. If Peak Result complies with AV limit, AV Result is deemed to comply with AV limit.

3. Peak: Peak detector.

4. Filter losses were only considered in the spurious frequency bands and the authorized band was not corrected for High Pass Filter losses.

5. Proper operation of the transmitter prior to adding the filter to the measurement chain.



HARMONICS AND SPURIOUS EMISSIONS (HIGH CHANNEL, VERTICAL)

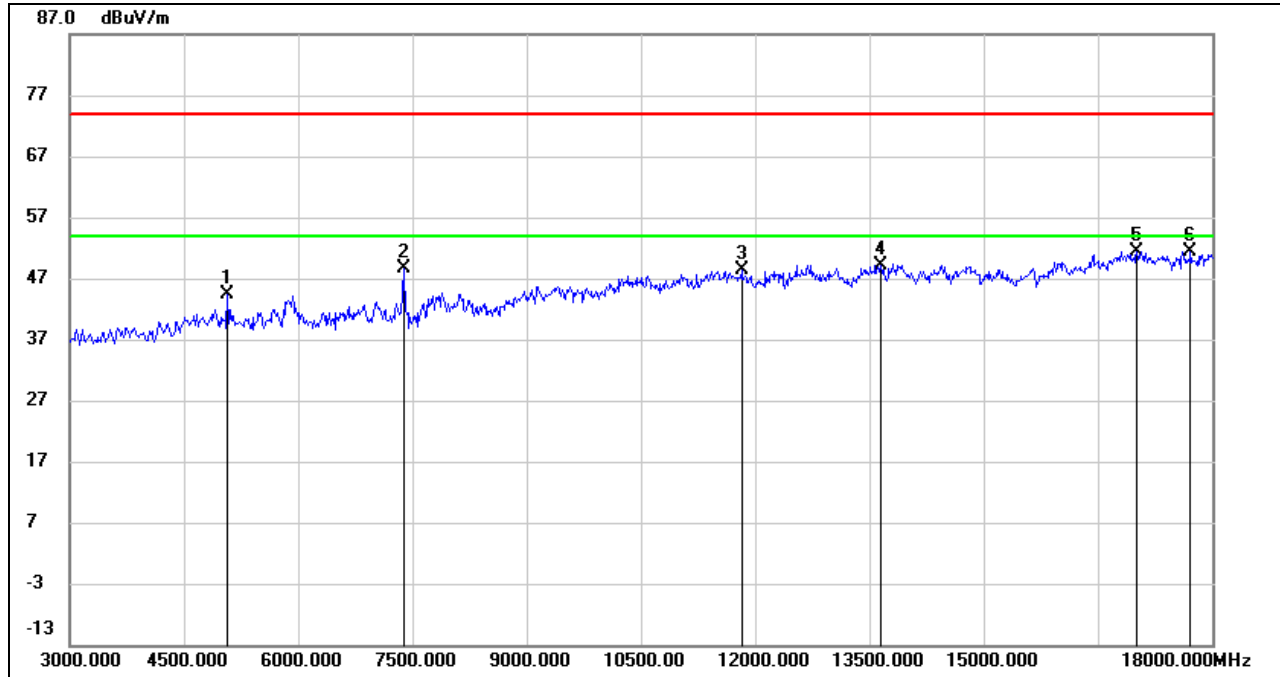

No.	Frequency (MHz)	Reading (dBuV)	Correct (dB/m)	Result (dBuV/m)	Limit (dBuV/m)	Margin (dB)	Remark
1	5070.000	42.87	1.50	44.37	74.00	-29.63	peak
2	7380.000	42.10	6.41	48.51	74.00	-25.49	peak
3	11820.000	35.23	13.19	48.42	74.00	-25.58	peak
4	13650.000	33.20	15.94	49.14	74.00	-24.86	peak
5	17010.000	30.89	20.43	51.32	74.00	-22.68	peak
6	17715.000	28.92	22.56	51.48	74.00	-22.52	peak

- Note: 1. Peak Result = Reading Level + Correct Factor.
 2. If Peak Result complies with AV limit, AV Result is deemed to comply with AV limit.
 3. Peak: Peak detector.
 4. Filter losses were only considered in the spurious frequency bands and the authorized band was not corrected for High Pass Filter losses.
 5. Proper operation of the transmitter prior to adding the filter to the measurement chain.

8.3.3. 802.11n HT20 SISO MODE

HARMONICS AND SPURIOUS EMISSIONS (LOW CHANNEL, HORIZONTAL)

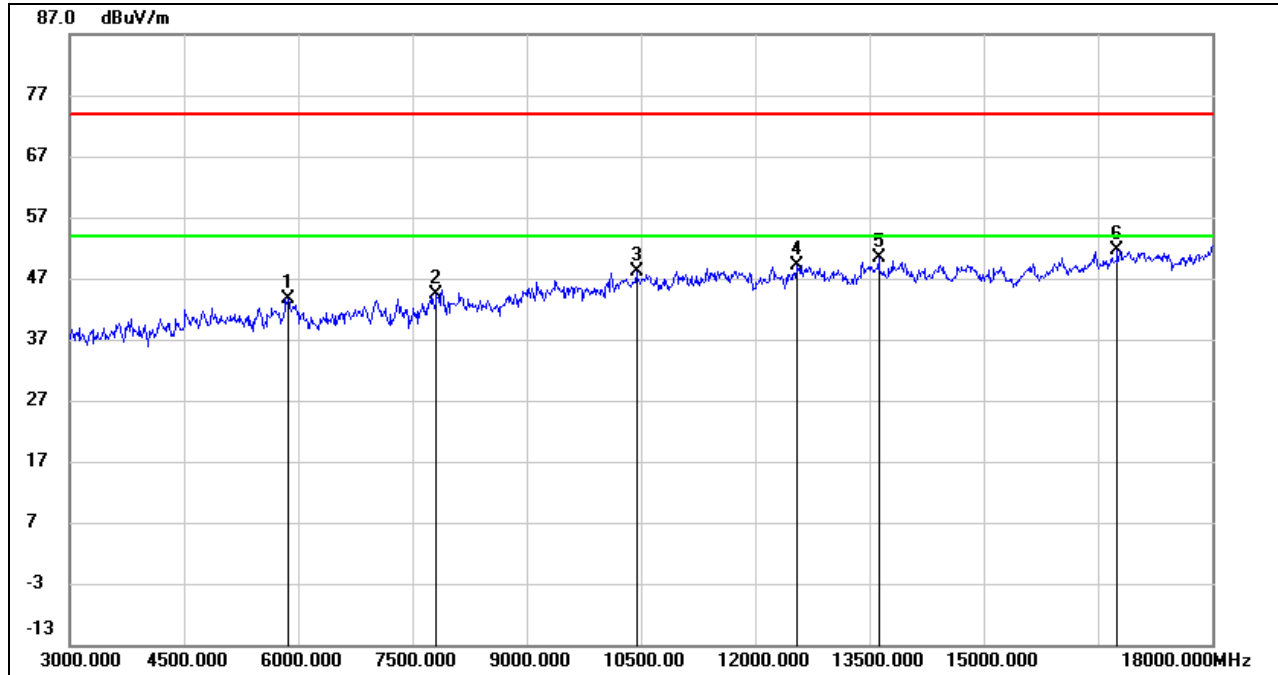

No.	Frequency (MHz)	Reading (dBuV)	Correct (dB/m)	Result (dBuV/m)	Limit (dBuV/m)	Margin (dB)	Remark
1	5865.000	39.44	4.30	43.74	74.00	-30.26	peak
2	7815.000	36.45	7.83	44.28	74.00	-29.72	peak
3	10440.000	37.03	11.13	48.16	74.00	-25.84	peak
4	12555.000	34.84	14.24	49.08	74.00	-24.92	peak
5	13620.000	34.35	15.99	50.34	74.00	-23.66	peak
6	16755.000	31.61	19.94	51.55	74.00	-22.45	peak

- Note: 1. Peak Result = Reading Level + Correct Factor.
 2. If Peak Result complies with AV limit, AV Result is deemed to comply with AV limit.
 3. Peak: Peak detector.
 4. Filter losses were only considered in the spurious frequency bands and the authorized band was not corrected for High Pass Filter losses.
 5. Proper operation of the transmitter prior to adding the filter to the measurement chain.



HARMONICS AND SPURIOUS EMISSIONS (LOW CHANNEL, VERTICAL)

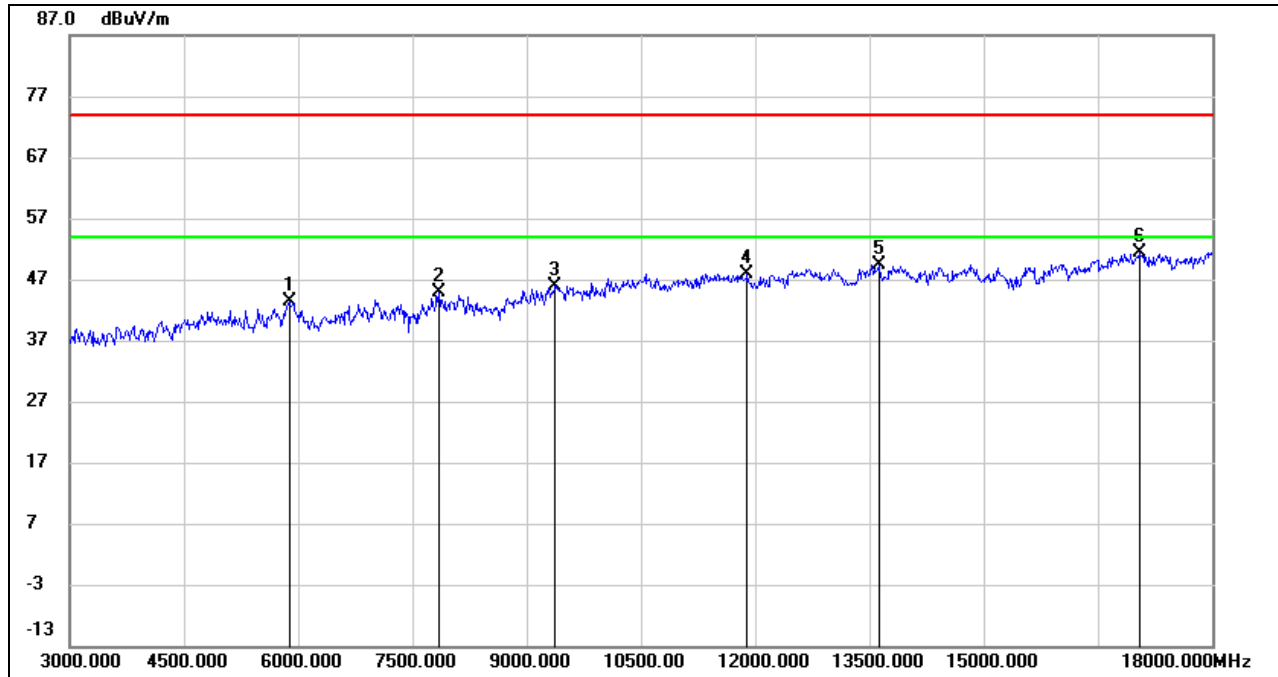

No.	Frequency (MHz)	Reading (dBuV)	Correct (dB/m)	Result (dBuV/m)	Limit (dBuV/m)	Margin (dB)	Remark
1	5880.000	38.83	4.59	43.42	74.00	-30.58	peak
2	7845.000	37.33	7.62	44.95	74.00	-29.05	peak
3	9375.000	36.41	9.45	45.86	74.00	-28.14	peak
4	11895.000	34.62	13.21	47.83	74.00	-26.17	peak
5	13620.000	33.46	15.99	49.45	74.00	-24.55	peak
6	17040.000	31.00	20.49	51.49	74.00	-22.51	peak

- Note: 1. Peak Result = Reading Level + Correct Factor.
 2. If Peak Result complies with AV limit, AV Result is deemed to comply with AV limit.
 3. Peak: Peak detector.
 4. Filter losses were only considered in the spurious frequency bands and the authorized band was not corrected for High Pass Filter losses.
 5. Proper operation of the transmitter prior to adding the filter to the measurement chain.

HARMONICS AND SPURIOUS EMISSIONS (MID CHANNEL, HORIZONTAL)

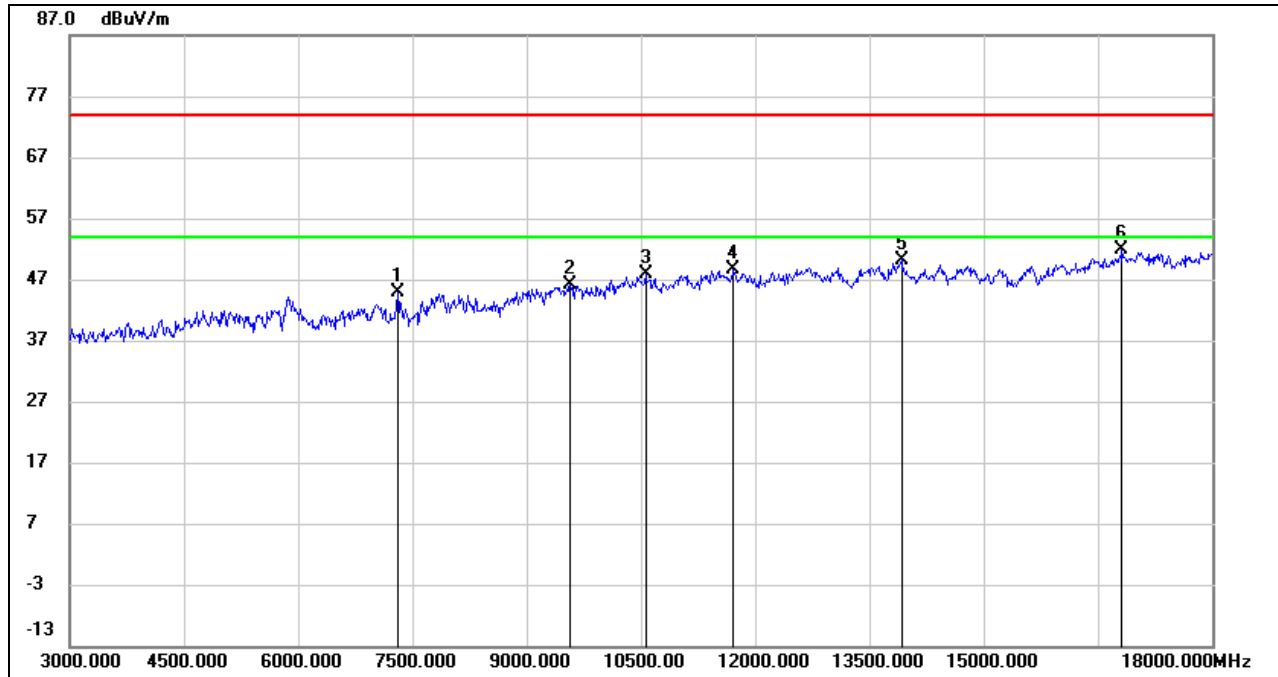

No.	Frequency (MHz)	Reading (dBuV)	Correct (dB/m)	Result (dBuV/m)	Limit (dBuV/m)	Margin (dB)	Remark
1	7305.000	38.80	6.08	44.88	74.00	-29.12	peak
2	9570.000	36.39	9.64	46.03	74.00	-27.97	peak
3	10560.000	36.16	11.73	47.89	74.00	-26.11	peak
4	11715.000	35.53	12.99	48.52	74.00	-25.48	peak
5	13920.000	34.08	16.17	50.25	74.00	-23.75	peak
6	16815.000	31.84	19.96	51.80	74.00	-22.20	peak

- Note: 1. Peak Result = Reading Level + Correct Factor.
 2. If Peak Result complies with AV limit, AV Result is deemed to comply with AV limit.
 3. Peak: Peak detector.
 4. Filter losses were only considered in the spurious frequency bands and the authorized band was not corrected for High Pass Filter losses.
 5. Proper operation of the transmitter prior to adding the filter to the measurement chain.



HARMONICS AND SPURIOUS EMISSIONS (MID CHANNEL, VERTICAL)

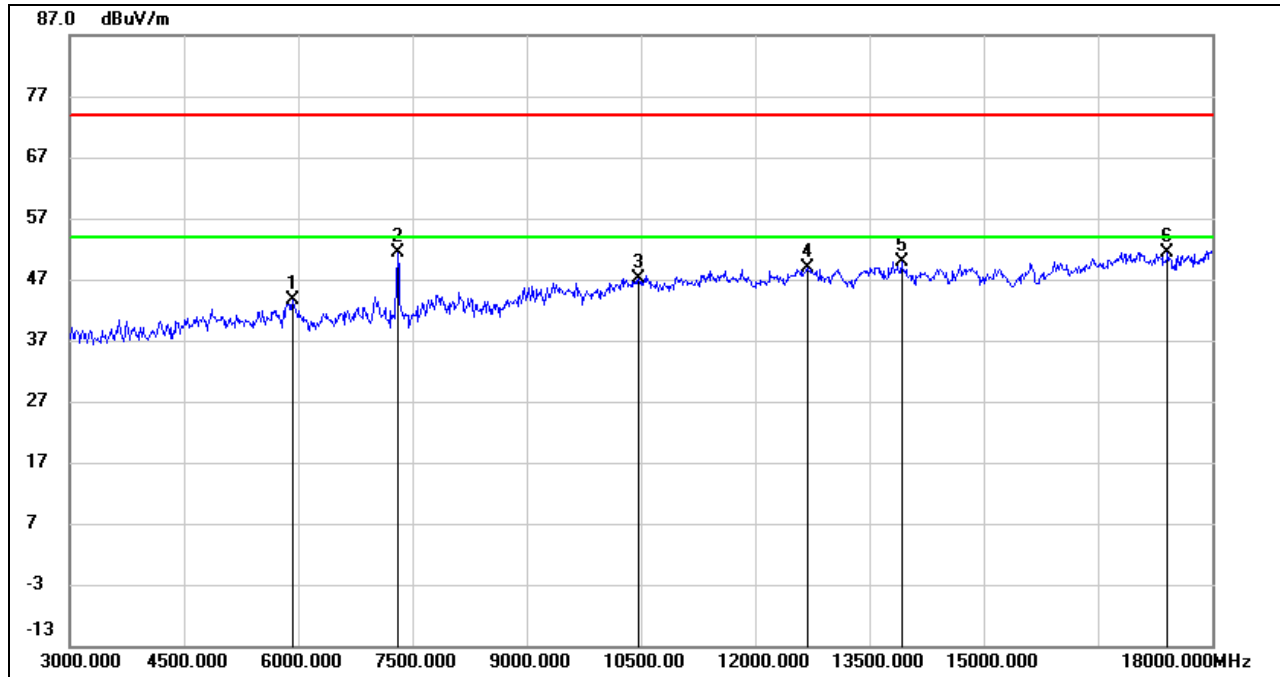

No.	Frequency (MHz)	Reading (dBuV)	Correct (dB/m)	Result (dBuV/m)	Limit (dBuV/m)	Margin (dB)	Remark
1	5925.000	39.11	4.54	43.65	74.00	-30.35	peak
2	7305.000	45.32	6.08	51.40	74.00	-22.60	peak
3	10470.000	35.86	11.25	47.11	74.00	-26.89	peak
4	12690.000	34.68	14.25	48.93	74.00	-25.07	peak
5	13920.000	33.82	16.17	49.99	74.00	-24.01	peak
6	17415.000	30.11	21.39	51.50	74.00	-22.50	peak

- Note: 1. Peak Result = Reading Level + Correct Factor.
 2. If Peak Result complies with AV limit, AV Result is deemed to comply with AV limit.
 3. Peak: Peak detector.
 4. Filter losses were only considered in the spurious frequency bands and the authorized band was not corrected for High Pass Filter losses.
 5. Proper operation of the transmitter prior to adding the filter to the measurement chain.



HARMONICS AND SPURIOUS EMISSIONS (HIGH CHANNEL, HORIZONTAL)

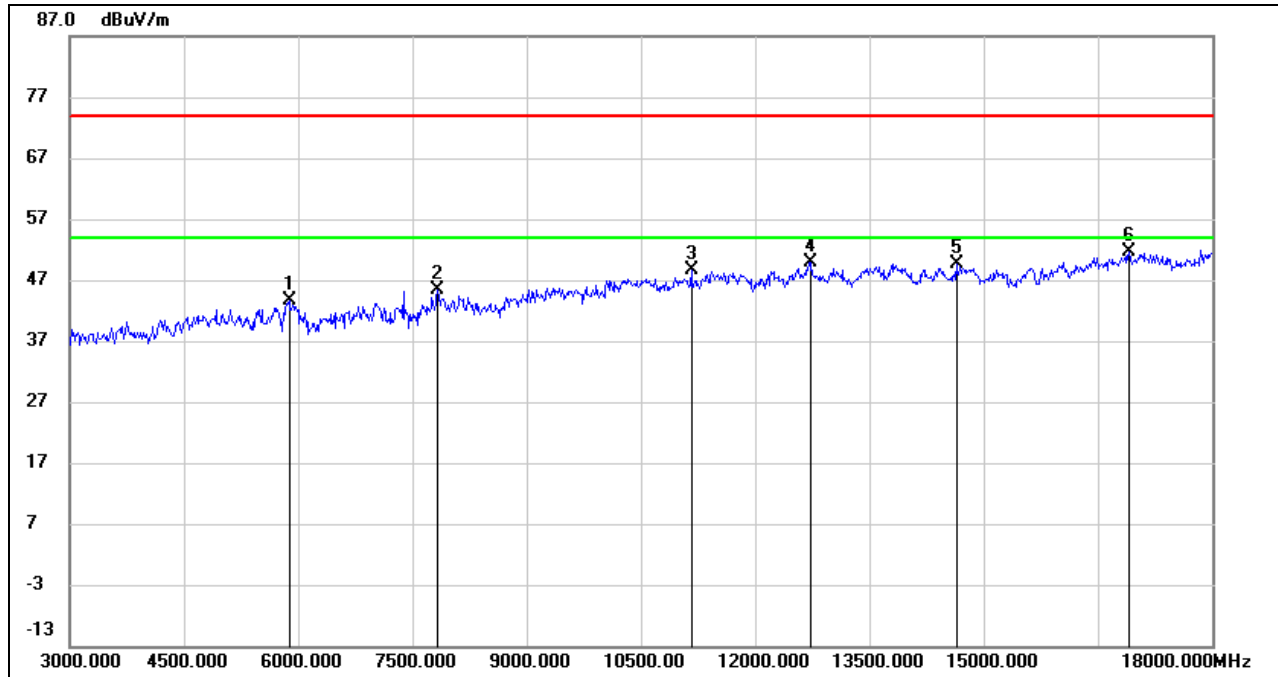

No.	Frequency (MHz)	Reading (dBuV)	Correct (dB/m)	Result (dBuV/m)	Limit (dBuV/m)	Margin (dB)	Remark
1	5880.000	39.00	4.59	43.59	74.00	-30.41	peak
2	7830.000	37.63	7.72	45.35	74.00	-28.65	peak
3	11160.000	36.14	12.53	48.67	74.00	-25.33	peak
4	12735.000	35.15	14.77	49.92	74.00	-24.08	peak
5	14640.000	33.76	15.96	49.72	74.00	-24.28	peak
6	16905.000	31.62	19.99	51.61	74.00	-22.39	peak

- Note: 1. Peak Result = Reading Level + Correct Factor.
 2. If Peak Result complies with AV limit, AV Result is deemed to comply with AV limit.
 3. Peak: Peak detector.
 4. Filter losses were only considered in the spurious frequency bands and the authorized band was not corrected for High Pass Filter losses.
 5. Proper operation of the transmitter prior to adding the filter to the measurement chain.



HARMONICS AND SPURIOUS EMISSIONS (HIGH CHANNEL, VERTICAL)

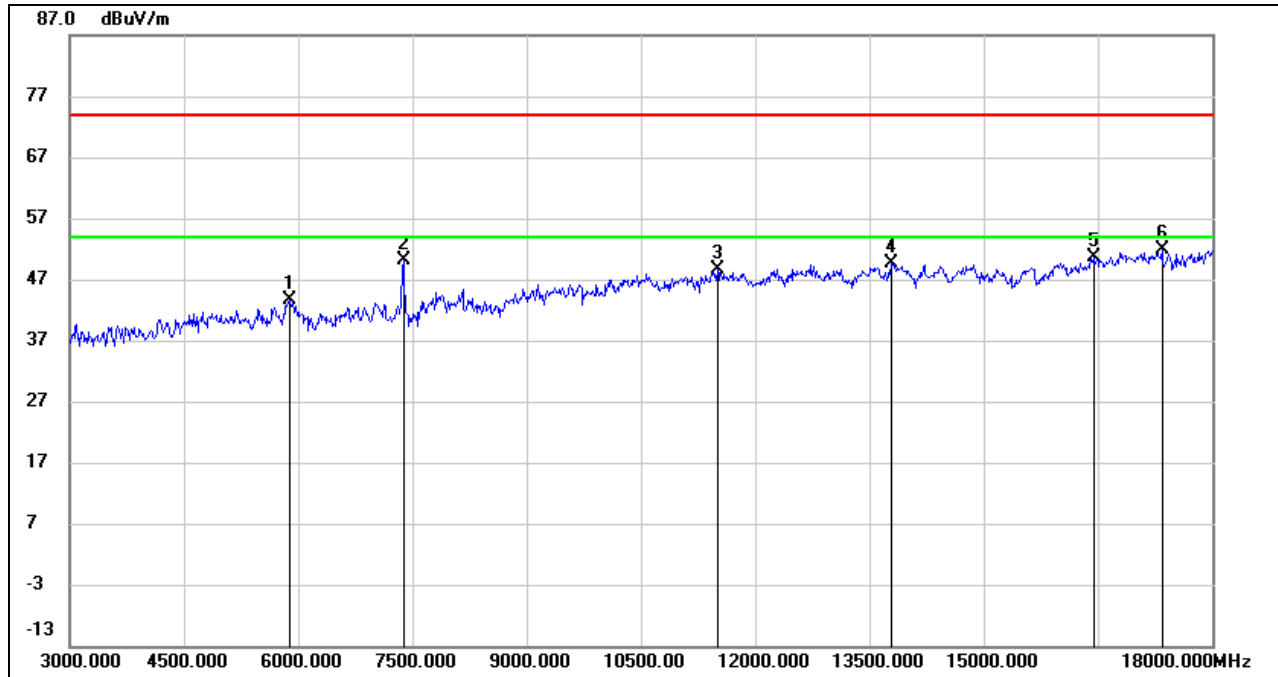

No.	Frequency (MHz)	Reading (dBuV)	Correct (dB/m)	Result (dBuV/m)	Limit (dBuV/m)	Margin (dB)	Remark
1	5880.000	39.10	4.59	43.69	74.00	-30.31	peak
2	7380.000	43.63	6.41	50.04	74.00	-23.96	peak
3	11505.000	35.30	13.42	48.72	74.00	-25.28	peak
4	13785.000	32.69	16.91	49.60	74.00	-24.40	peak
5	16440.000	31.78	18.94	50.72	74.00	-23.28	peak
6	17340.000	30.27	21.61	51.88	74.00	-22.12	peak

- Note: 1. Peak Result = Reading Level + Correct Factor.
 2. If Peak Result complies with AV limit, AV Result is deemed to comply with AV limit.
 3. Peak: Peak detector.
 4. Filter losses were only considered in the spurious frequency bands and the authorized band was not corrected for High Pass Filter losses.
 5. Proper operation of the transmitter prior to adding the filter to the measurement chain.

8.4. SPURIOUS EMISSIONS (18 GHz ~ 26 GHz)

8.4.1. 802.11n HT20 SISO MODE

SPURIOUS EMISSIONS (LOW CHANNEL, WORST-CASE CONFIGURATION, HORIZONTAL)

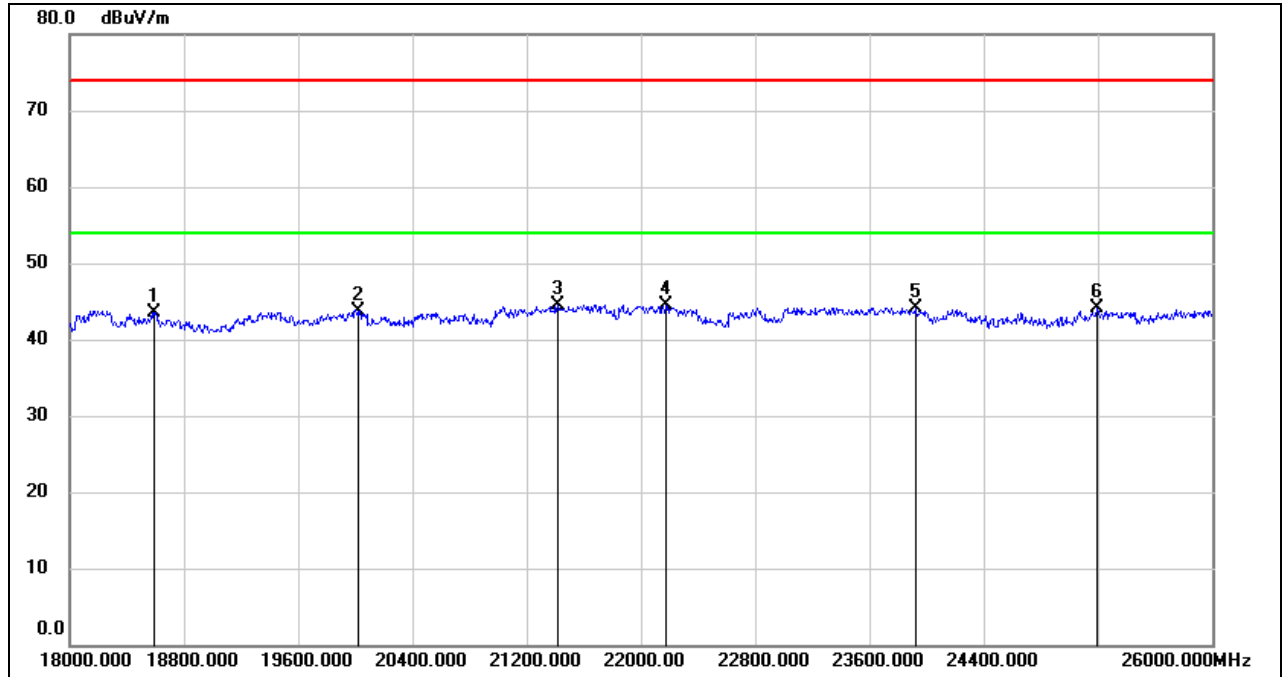

No.	Frequency (MHz)	Reading (dBuV)	Correct (dB/m)	Result (dBuV/m)	Limit (dBuV/m)	Margin (dB)	Remark
1	18592.000	48.75	-5.31	43.44	74.00	-30.56	peak
2	20024.000	49.25	-5.47	43.78	74.00	-30.22	peak
3	21416.000	49.19	-4.72	44.47	74.00	-29.53	peak
4	22176.000	48.76	-4.29	44.47	74.00	-29.53	peak
5	23920.000	47.07	-2.89	44.18	74.00	-29.82	peak
6	25192.000	45.80	-1.78	44.02	74.00	-29.98	peak

Note: 1. Measurement = Reading Level + Correct Factor.
 2. If Peak Result complies with AV limit, AV Result is deemed to comply with AV limit.
 3. Peak: Peak detector.
 4. The preamplifier only effect to the above 18GHz signal and no filter added to the measurement chain.

SPURIOUS EMISSIONS (LOW CHANNEL, WORST-CASE CONFIGURATION, VERTICAL)

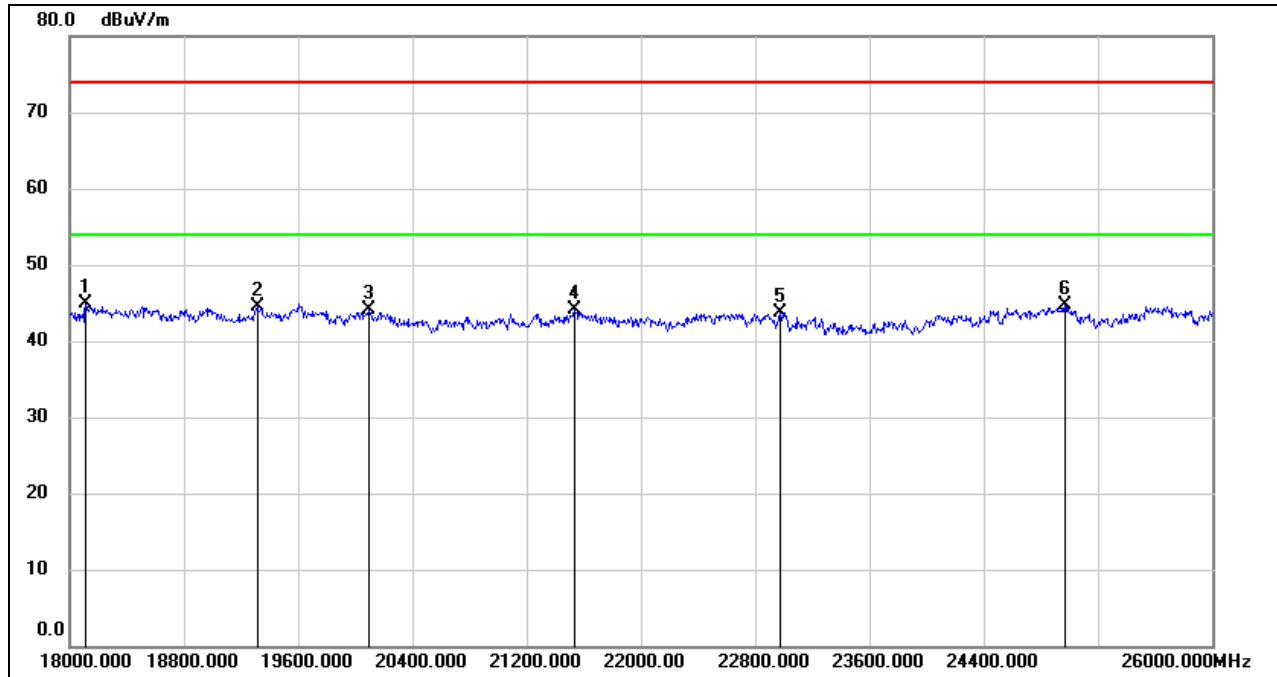

No.	Frequency (MHz)	Reading (dBuV)	Correct (dB/m)	Result (dBuV/m)	Limit (dBuV/m)	Margin (dB)	Remark
1	18112.000	50.46	-5.47	44.99	74.00	-29.01	peak
2	19312.000	50.05	-5.57	44.48	74.00	-29.52	peak
3	20096.000	49.60	-5.51	44.09	74.00	-29.91	peak
4	21536.000	48.68	-4.64	44.04	74.00	-29.96	peak
5	22976.000	47.26	-3.46	43.80	74.00	-30.20	peak
6	24968.000	46.76	-2.14	44.62	74.00	-29.38	peak

Note: 1. Measurement = Reading Level + Correct Factor.
 2. If Peak Result complies with AV limit, AV Result is deemed to comply with AV limit.
 3. Peak: Peak detector.
 4. The preamplifier only effect to the above 18GHz signal and no filter added to the measurement chain.

Note: All the modes and channels had been tested, but only the worst data was recorded in the report.

8.5. SPURIOUS EMISSIONS (30 MHz ~ 1 GHz)

8.5.1. 802.11b SISO MODE

SPURIOUS EMISSIONS (HIGH CHANNEL, WORST-CASE CONFIGURATION, HORIZONTAL)

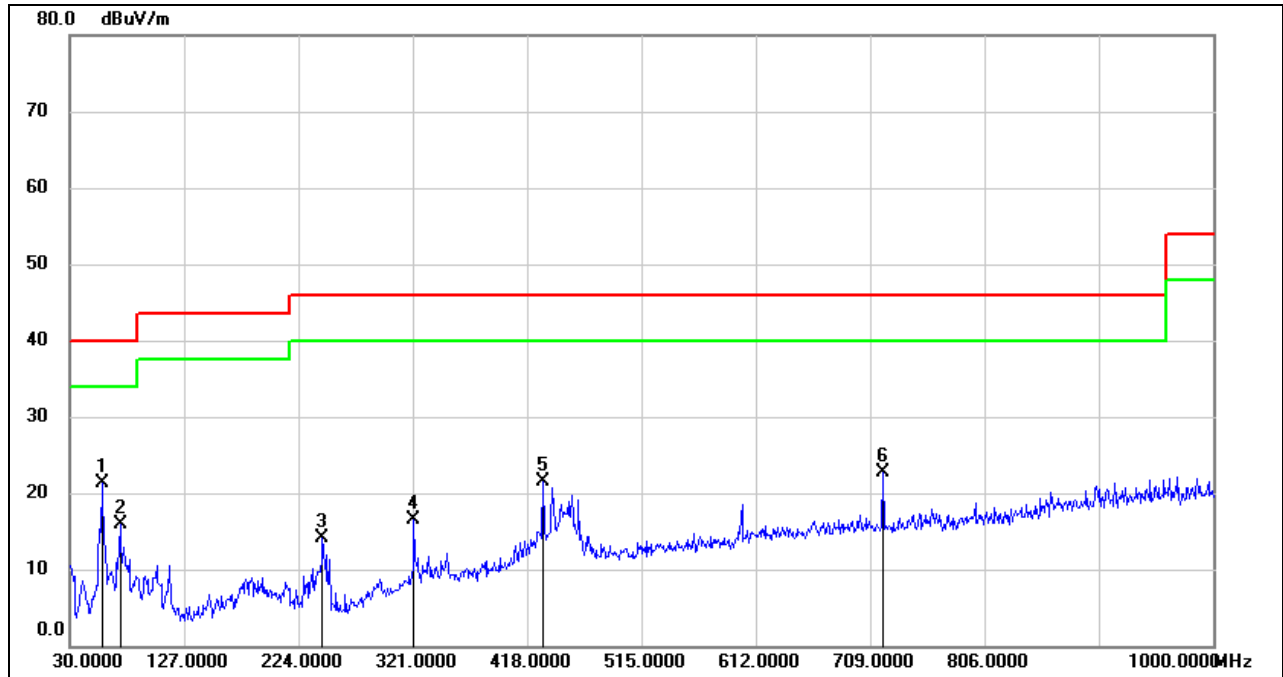

No.	Frequency (MHz)	Reading (dBuV)	Correct (dB/m)	Result (dBuV/m)	Limit (dBuV/m)	Margin (dB)	Remark
1	57.1600	41.85	-20.58	21.27	40.00	-18.73	QP
2	72.6800	36.61	-20.76	15.85	40.00	-24.15	QP
3	244.3700	33.27	-19.07	14.20	46.00	-31.80	QP
4	321.9700	31.22	-14.75	16.47	46.00	-29.53	QP
5	431.5800	34.27	-12.70	21.57	46.00	-24.43	QP
6	719.6700	30.78	-8.08	22.70	46.00	-23.30	QP

- Note: 1. Result Level = Read Level + Correct Factor.
 2. If Peak Result complies with QP limit, QP Result is deemed to comply with QP limit.
 3. Test setup: RBW: 120 kHz, VBW: 300 kHz, Sweep time: auto.



SPURIOUS EMISSIONS (HIGH CHANNEL, WORST-CASE CONFIGURATION, VERTICAL)

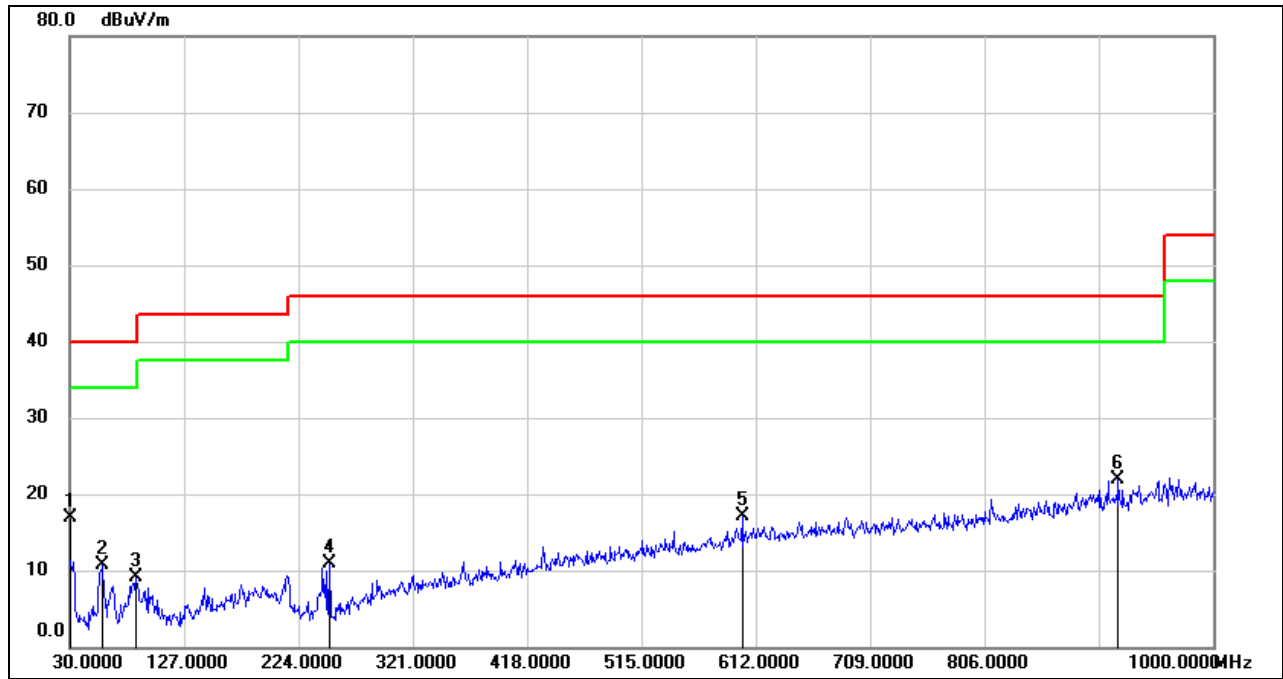

No.	Frequency (MHz)	Reading (dBuV)	Correct (dB/m)	Result (dBuV/m)	Limit (dBuV/m)	Margin (dB)	Remark
1	30.0000	35.77	-18.94	16.83	40.00	-23.17	QP
2	58.1300	31.26	-20.55	10.71	40.00	-29.29	QP
3	86.2600	30.77	-21.75	9.02	40.00	-30.98	QP
4	250.1900	29.87	-18.91	10.96	46.00	-35.04	QP
5	600.3600	26.59	-9.54	17.05	46.00	-28.95	QP
6	919.4900	26.75	-4.76	21.99	46.00	-24.01	QP

- Note: 1. Result Level = Read Level + Correct Factor.
 2. If Peak Result complies with QP limit, QP Result is deemed to comply with QP limit.
 3. Test setup: RBW: 120 kHz, VBW: 300 kHz, Sweep time: auto

Note: All the modes and channels had been tested, but only the worst data was recorded in the report.

8.6. SPURIOUS EMISSIONS BELOW 30 MHz

8.6.1. 802.11b SISO MODE

SPURIOUS EMISSIONS (HIGH CHANNEL, LOOP ANTENNA FACE ON TO THE EUT, WORST-CASE CONFIGURATION)

9 kHz~ 150 kHz

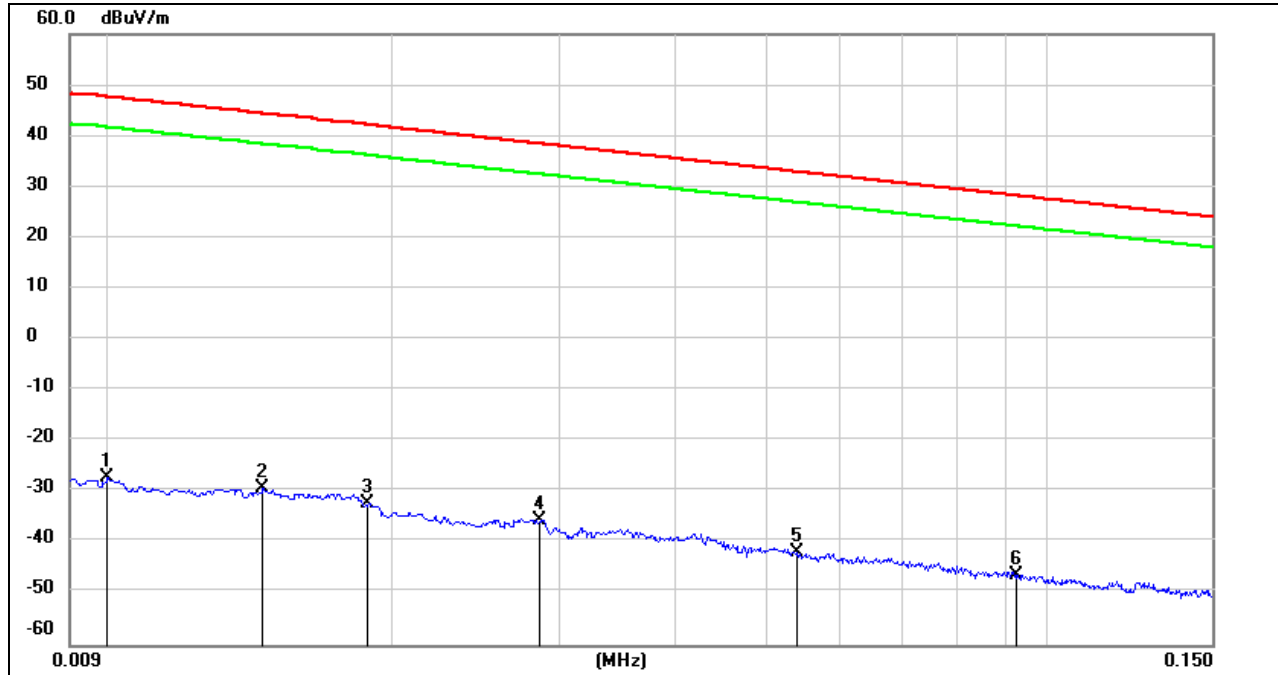

No.	Frequency (MHz)	Reading (dBuV)	Correct (dB/m)	FCC Result (dBuV/m)	FCC Limit (dBuV/m)	Margin (dB)	Remark
1	0.0100	74.22	-101.40	-27.18	47.6	-74.78	peak
2	0.0145	72.05	-101.38	-29.33	44.37	-73.70	peak
3	0.0188	69.14	-101.35	-32.21	42.12	-74.33	peak
4	0.0286	65.96	-101.38	-35.42	38.47	-73.89	peak
5	0.0539	59.76	-101.50	-41.74	32.97	-74.71	peak
6	0.0926	55.48	-101.74	-46.26	28.27	-74.53	peak

Note: 1. Measurement = Reading Level + Correct Factor (dBuV/m- 20Log10[120π] = dBuV/m- 51.5).

2. If Peak Result complies with AV and QP limit, AV and QP Result are deemed to comply with AV limit.

3. All 3 polarizations (Horizontal, Face-on and Face-off) of the loop antenna had been tested, but only the worst data recorded in the report.

150 kHz ~ 490 kHz

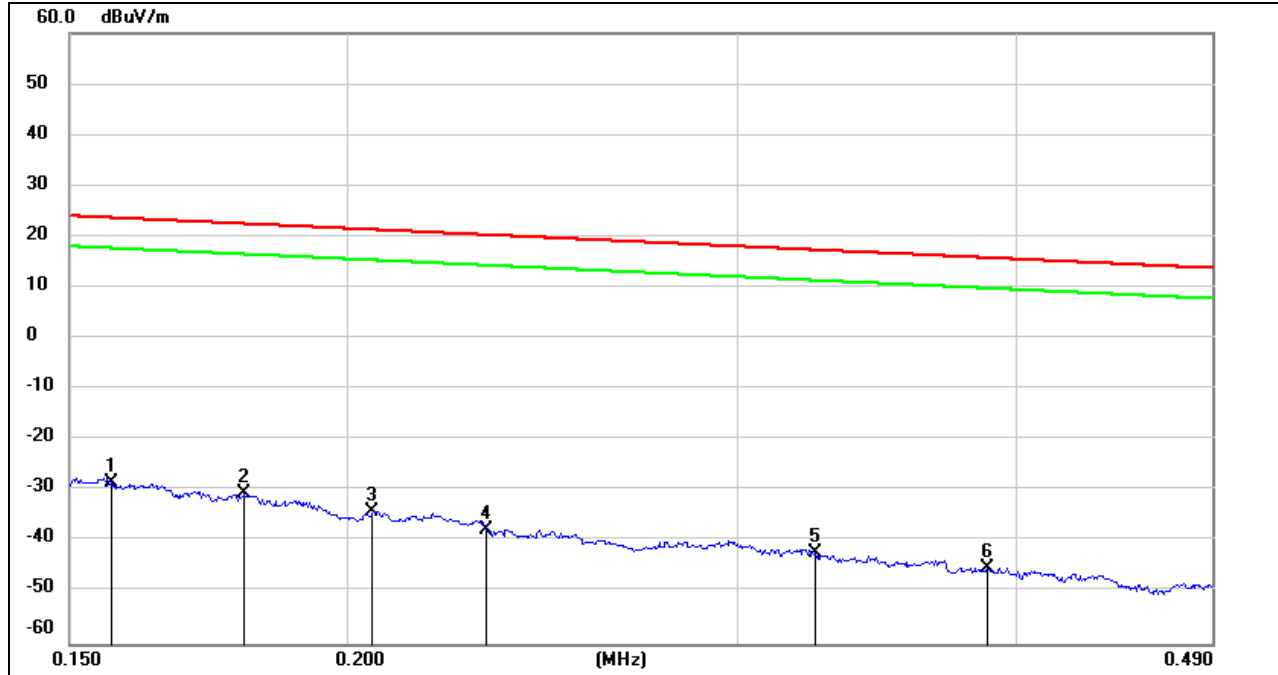

No.	Frequency (MHz)	Reading (dBuV)	Correct (dB/m)	FCC Result (dBuV/m)	FCC Limit (dBuV/m)	Margin (dB)	Remark
1	0.1567	73.45	-101.65	-28.2	23.7	-51.90	peak
2	0.1800	71.15	-101.68	-30.53	22.5	-53.03	peak
3	0.2053	67.79	-101.73	-33.94	21.35	-55.29	peak
4	0.2310	64.19	-101.77	-37.58	20.33	-57.91	peak
5	0.3251	59.71	-101.88	-42.17	17.36	-59.53	peak
6	0.3881	56.90	-101.95	-45.05	15.82	-60.87	peak

Note: 1. Measurement = Reading Level + Correct Factor (dBuV/m- 20Log10[120π] = dBuV/m- 51.5).

2. If Peak Result complies with AV and QP limit, AV and QP Result are deemed to comply with AV limit.

3. All 3 polarizations (Horizontal, Face-on and Face-off) of the loop antenna had been tested, but only the worst data recorded in the report.

490 kHz ~ 30 MHz

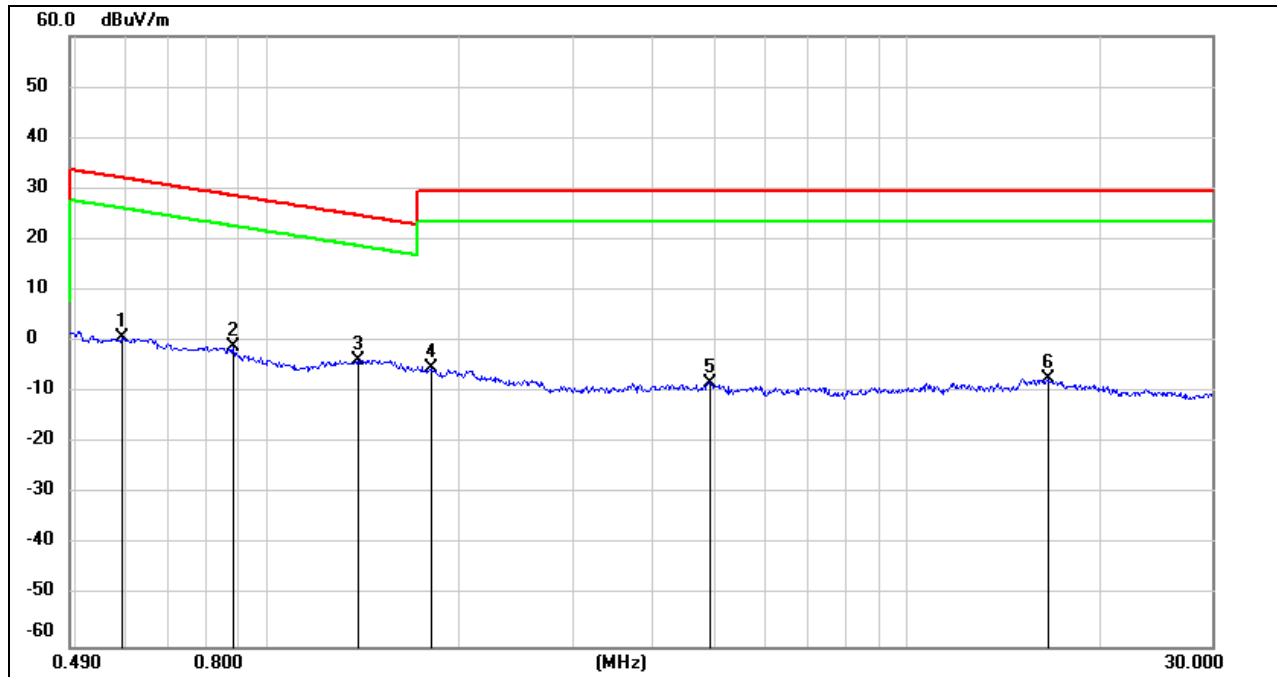

No.	Frequency (MHz)	Reading (dBuV)	Correct (dB/m)	FCC Result (dBuV/m)	FCC Limit (dBuV/m)	Margin (dB)	Remark
1	0.5917	62.74	-62.08	0.66	32.16	-31.50	peak
2	0.8820	61.18	-62.19	-1.01	28.69	-29.70	peak
3	1.3810	58.47	-62.10	-3.63	24.8	-28.43	peak
4	1.7983	56.61	-61.91	-5.3	29.54	-34.84	peak
5	4.9165	53.38	-61.48	-8.1	29.54	-37.64	peak
6	16.7205	53.54	-60.95	-7.41	29.54	-36.95	peak

Note: 1. Measurement = Reading Level + Correct Factor (dBuV/m- 20Log10[120π] = dBuV/m- 51.5).

2. If Peak Result complies with AV and QP limit, AV and QP Result are deemed to comply with AV limit.

3. All 3 polarizations (Horizontal, Face-on and Face-off) of the loop antenna had been tested, but only the worst data recorded in the report.

Note: All the modes and channels had been tested, but only the worst data was recorded in the report.

9. AC POWER LINE CONDUCTED EMISSIONS

LIMITS

Please refer to CFR 47 FCC §15.207 (a)

FREQUENCY (MHz)	Quasi-peak	Average
0.15 -0.5	66 - 56 *	56 - 46 *
0.50 -5.0	56.00	46.00
5.0 -30.0	60.00	50.00

TEST SETUP AND PROCEDURE

Refer to ANSI C63.10-2013 clause 6.2.

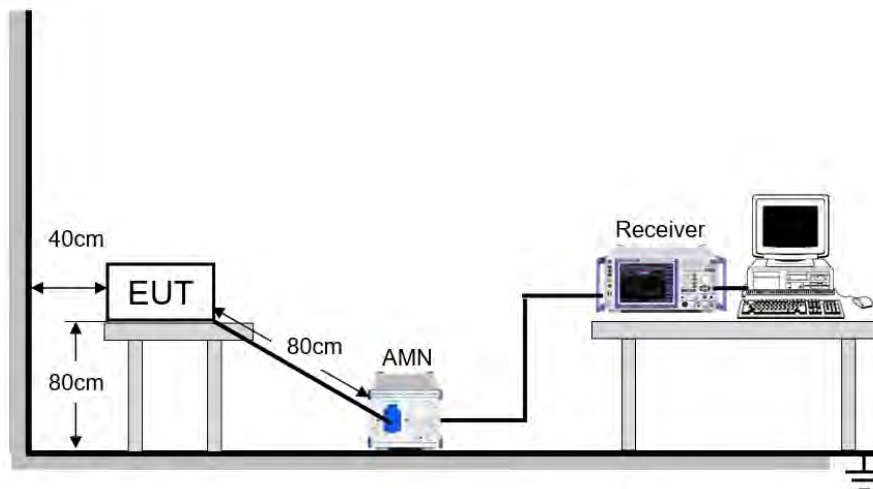

The EUT is put on a table of non-conducting material that is 80 cm high. The vertical conducting wall of shielding is located 40 cm to the rear of the EUT. The power line of the EUT is connected to the AC mains through a Artificial Mains Network (A.M.N.). A EMI Measurement Receiver (R&S Test Receiver ESR3) is used to test the emissions from both sides of AC line. According to the requirements in Section 6.2 of ANSI C63.10-2013. Conducted emissions from the EUT measured in the frequency range between 0.15 MHz and 30 MHz using CISPR Quasi-Peak and average detector mode. The bandwidth of EMI test receiver is set at 9 kHz.

The arrangement of the equipment is installed to meet the standards and operating in a manner, which tends to maximize its emission characteristics in a normal application.

TEST ENVIRONMENT

Temperature	23.1 °C	Relative Humidity	56 %
Atmosphere Pressure	101 kPa	Test Voltage	DC 5 V

RESULTS

9.1. 802.11b SISO MODE

LINE N RESULTS (HIGH CHANNEL, WORST-CASE CONFIGURATION)

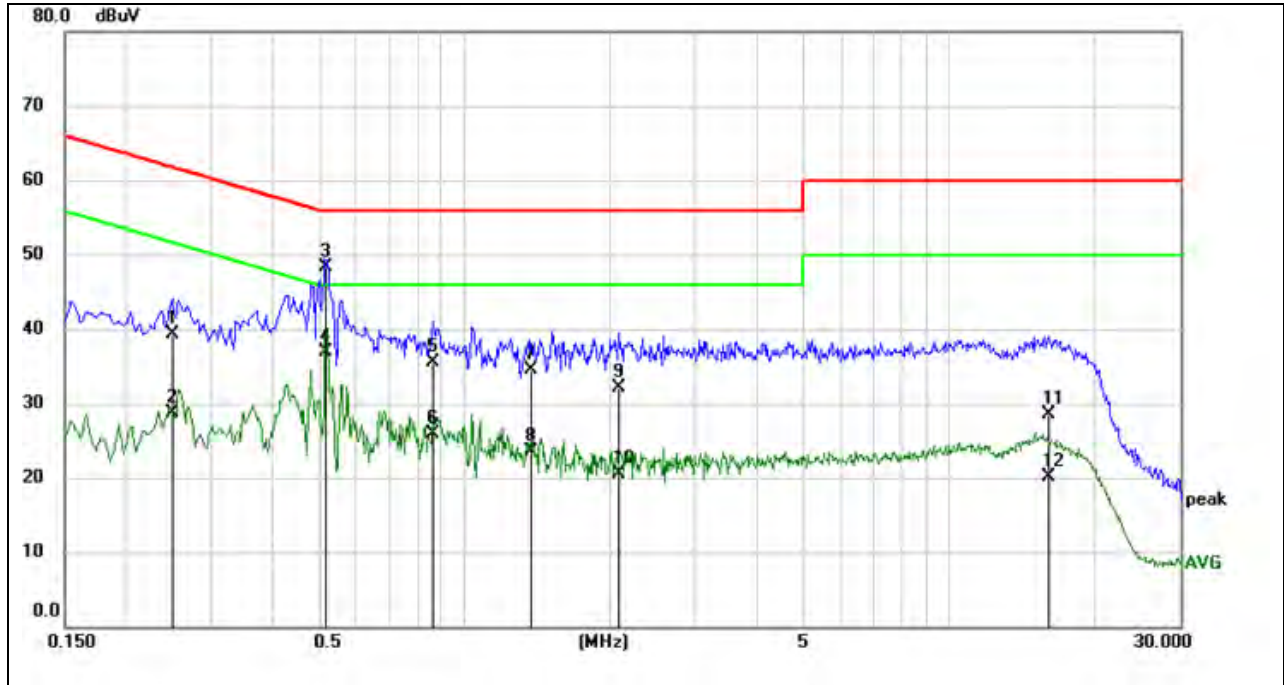

No.	Frequency (MHz)	Reading (dBuV)	Correct (dB)	Result (dBuV)	Limit (dBuV)	Margin (dB)	Remark
1	0.2512	29.78	9.60	39.38	61.72	-22.34	QP
2	0.2512	19.05	9.60	28.65	51.72	-23.07	AVG
3	0.5185	38.66	9.60	48.26	56.00	-7.74	QP
4	0.5185	27.24	9.60	36.84	46.00	-9.16	AVG
5	0.8646	25.93	9.60	35.53	56.00	-20.47	QP
6	0.8646	16.38	9.60	25.98	46.00	-20.02	AVG
7	1.3714	24.89	9.61	34.50	56.00	-21.50	QP
8	1.3714	13.87	9.61	23.48	46.00	-22.52	AVG
9	2.1092	22.52	9.63	32.15	56.00	-23.85	QP
10	2.1092	10.85	9.63	20.48	46.00	-25.52	AVG
11	16.0951	18.47	9.97	28.44	60.00	-31.56	QP
12	16.0951	10.07	9.97	20.04	50.00	-29.96	AVG

Note: 1. Result = Reading +Correct Factor.

2. If QP Result complies with AV limit, AV Result is deemed to comply with AV limit.

3. Test setup: RBW: 200 Hz (9 kHz ~ 150 kHz), 9 kHz (150 kHz ~ 30 MHz).

4. Step size: 80 Hz (0.009 MHz ~ 0.15 MHz), 4 kHz (0.15 MHz ~ 30 MHz), Scan time: auto.

LINE L RESULTS (HIGH CHANNEL, WORST-CASE CONFIGURATION)

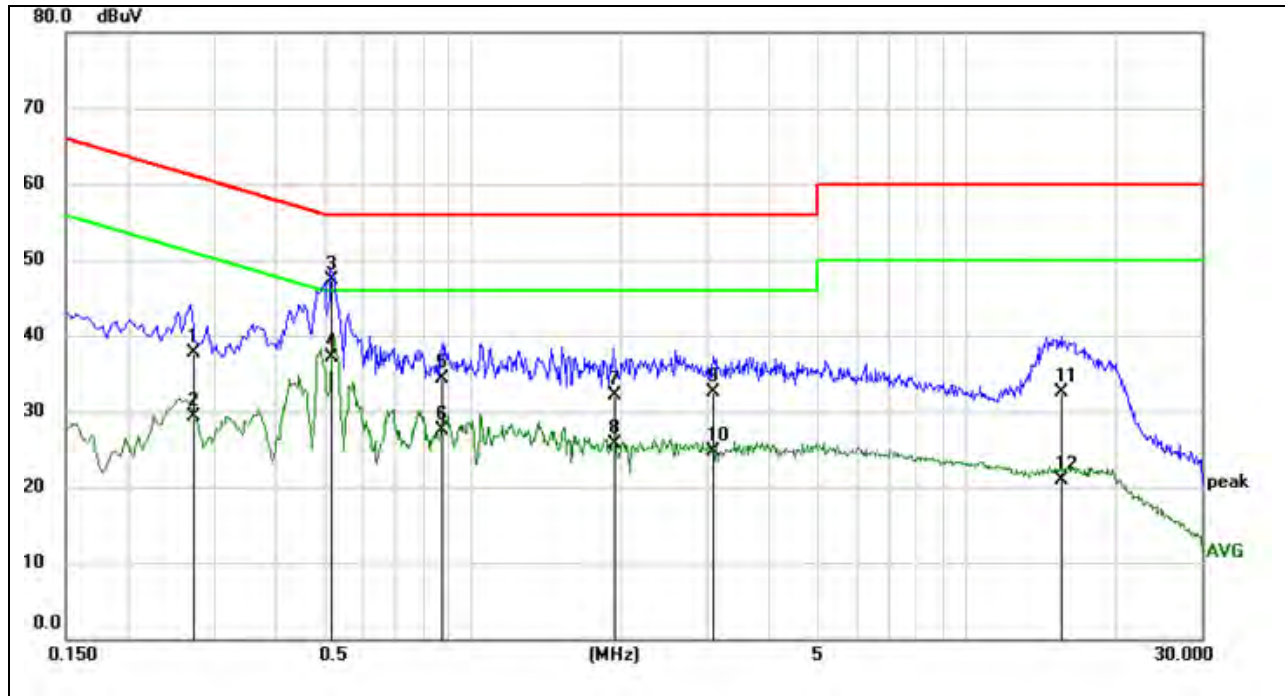

No.	Frequency (MHz)	Reading (dBuV)	Correct (dB)	Result (dBuV)	Limit (dBuV)	Margin (dB)	Remark
1	0.2719	28.07	9.60	37.67	61.06	-23.39	QP
2	0.2719	19.68	9.60	29.28	51.06	-21.78	AVG
3	0.5197	37.62	9.60	47.22	56.00	-8.78	QP
4	0.5197	27.60	9.60	37.20	46.00	-8.80	AVG
5	0.8668	24.76	9.60	34.36	56.00	-21.64	QP
6	0.8668	17.95	9.60	27.55	46.00	-18.45	AVG
7	1.9432	22.42	9.62	32.04	56.00	-23.96	QP
8	1.9432	16.14	9.62	25.76	46.00	-20.24	AVG
9	3.0789	22.82	9.64	32.46	56.00	-23.54	QP
10	3.0789	15.10	9.64	24.74	46.00	-21.26	AVG
11	15.6371	22.58	9.88	32.46	60.00	-27.54	QP
12	15.6371	11.11	9.88	20.99	50.00	-29.01	AVG

Note: 1. Result = Reading +Correct Factor.
 2. If QP Result complies with AV limit, AV Result is deemed to comply with AV limit.
 3. Test setup: RBW: 200 Hz (9 kHz ~ 150 kHz), 9 kHz (150 kHz ~ 30 MHz).
 4. Step size: 80 Hz (0.009 MHz ~ 0.15 MHz), 4 kHz (0.15 MHz ~ 30 MHz), Scan time: auto.

Note: All the modes had been tested, but only the worst data was recorded in the report.



10. ANTENNA REQUIREMENTS

APPLICABLE REQUIREMENTS

Please refer to FCC §15.203

An intentional radiator shall be designed to ensure that no antenna other than that furnished by the responsible party shall be used with the device. The use of a permanently attached antenna or of an antenna that uses a unique coupling to the intentional radiator shall be considered sufficient to comply with the provisions of this section. The manufacturer may design the unit so that a broken antenna can be replaced by the user, but the use of a standard antenna jack or electrical connector is prohibited.

Please refer to FCC §15.247(b)(4)

The conducted output power limit specified in paragraph (b) of this section is based on the use of antennas with directional gains that do not exceed 6 dBi. Except as shown in paragraph (c) of this section, if transmitting antennas of directional gain greater than 6 dBi are used, the conducted output power from the intentional radiator shall be reduced below the stated values in paragraphs (b)(1), (b)(2), and (b)(3) of this section, as appropriate, by the amount in dB that the directional gain of the antenna exceeds 6 dBi.

RESULTS

Complies



11. Appendix

11.1. Appendix A: DTS Bandwidth

11.1.1. Test Result

Test Mode	Antenna	Channel	DTS BW [MHz]	FL[MHz]	FH[MHz]	Limit[MHz]	Verdict
11B	Ant1	2412	7.600	2408.440	2416.040	0.5	PASS
		2437	7.600	2433.440	2441.040	0.5	PASS
		2462	7.160	2458.440	2465.600	0.5	PASS
11G	Ant1	2412	16.360	2403.840	2420.200	0.5	PASS
		2437	16.360	2428.840	2445.200	0.5	PASS
		2462	16.040	2454.120	2470.160	0.5	PASS
11N20SISO	Ant1	2412	17.120	2403.480	2420.600	0.5	PASS
		2437	16.760	2429.080	2445.840	0.5	PASS
		2462	17.240	2453.600	2470.840	0.5	PASS

11.1.2. Test Graphs



11B Ant1 2412



11B Ant1 2437



11B Ant1 2462



11G Ant1 2412



11G Ant1 2437



11G Ant1 2462



11N20SISO Ant1 2412



11N20SISO Ant1 2437

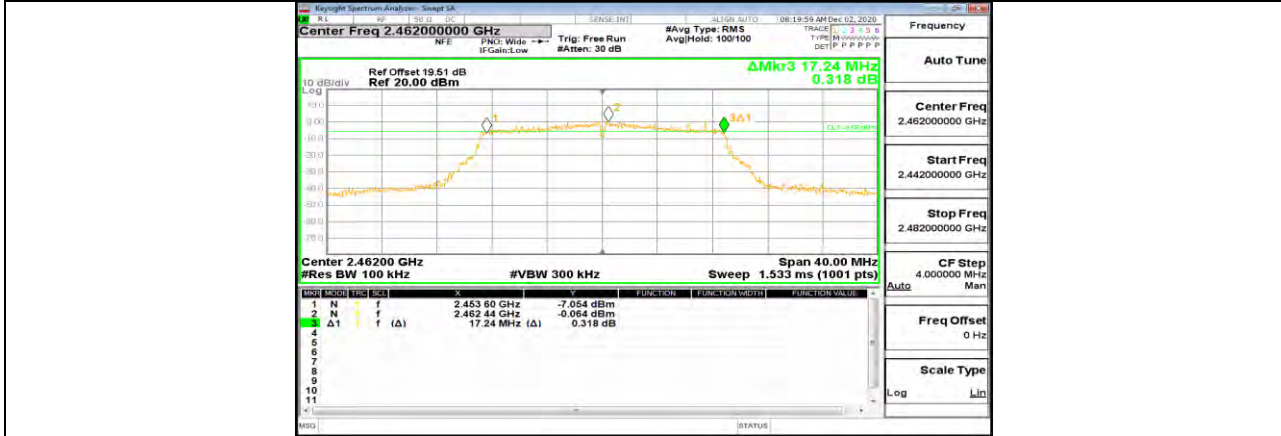

11N20SISO Ant1 2462



11.2. Appendix B: Occupied Channel Bandwidth

11.2.1. Test Result

Test Mode	Antenna	Channel	OCB [MHz]	FL[MHz]	FH[MHz]	Verdict
11B	Ant1	2412	11.268	2406.455	2417.723	PASS
		2437	11.260	2431.439	2442.699	PASS
		2462	11.373	2456.425	2467.798	PASS
11G	Ant1	2412	17.148	2403.470	2420.618	PASS
		2437	17.088	2428.503	2445.591	PASS
		2462	17.009	2453.503	2470.512	PASS
11N20SISO	Ant1	2412	18.154	2403.031	2421.185	PASS
		2437	18.175	2428.024	2446.199	PASS
		2462	17.977	2453.101	2471.078	PASS



11.2.2. Test Graphs



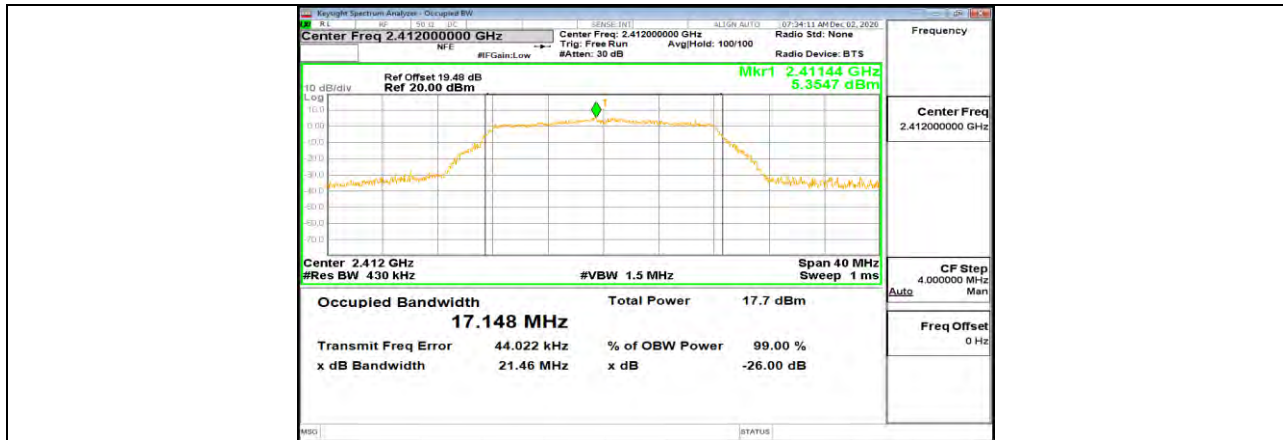

11G Ant1 2412

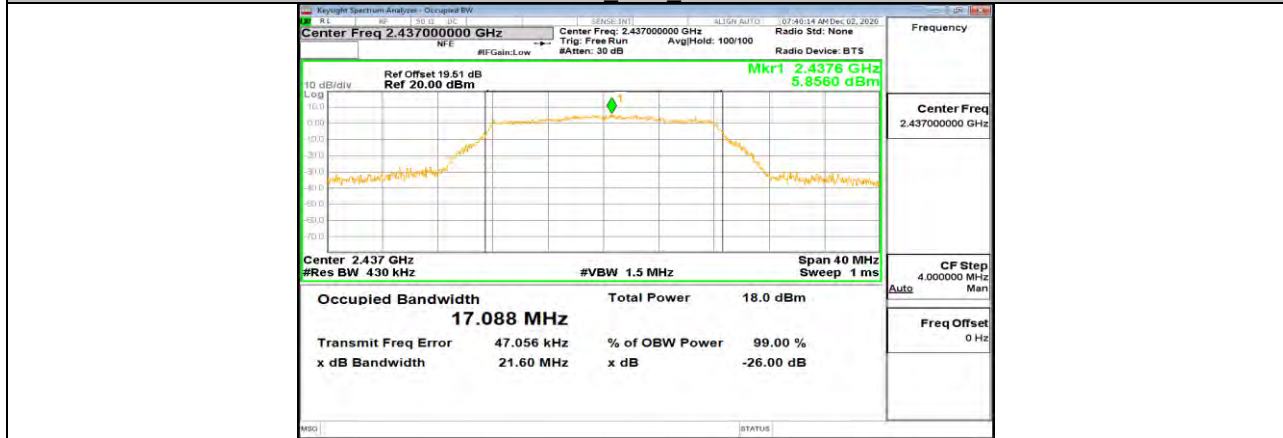

11G Ant1 2437

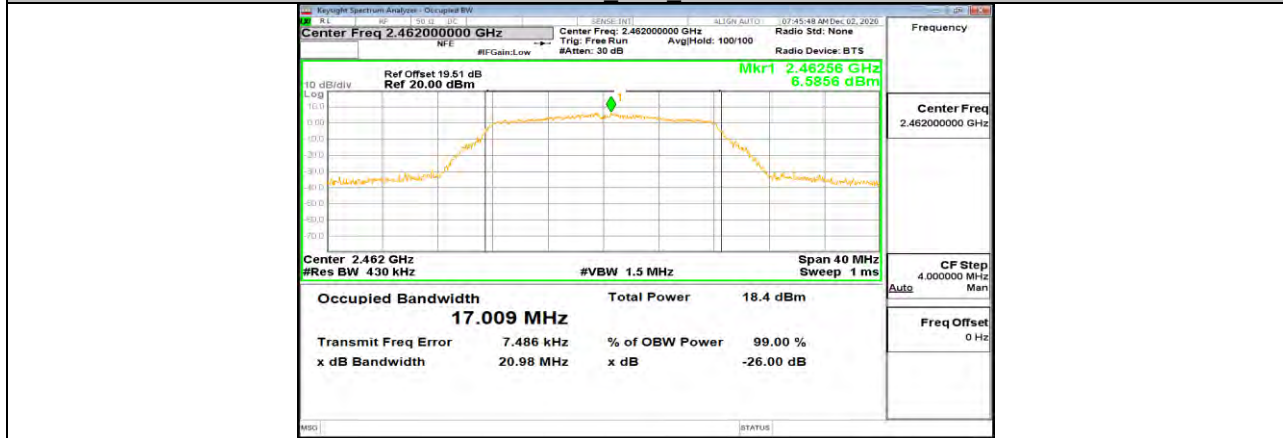

11G Ant1 2462

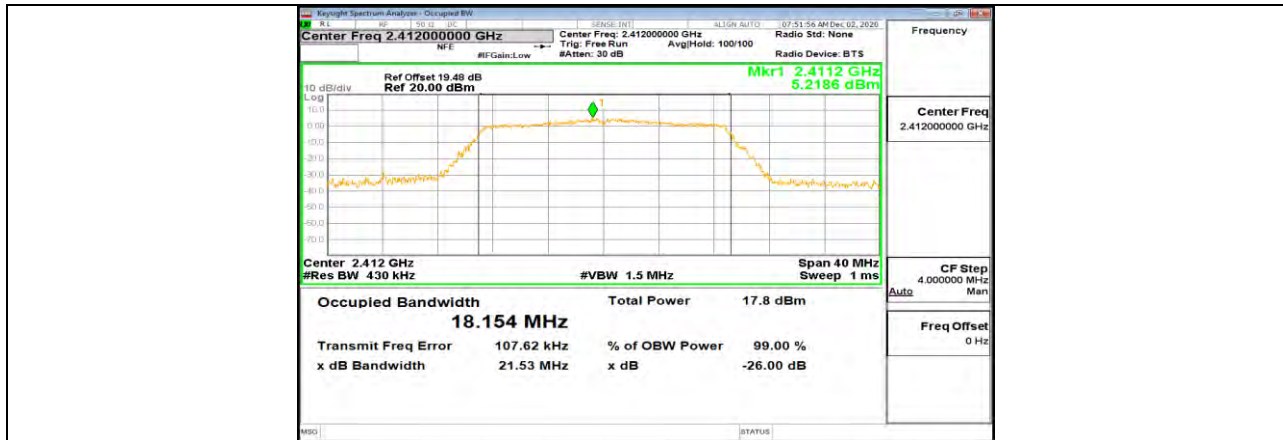

11N20SISO Ant1 2412

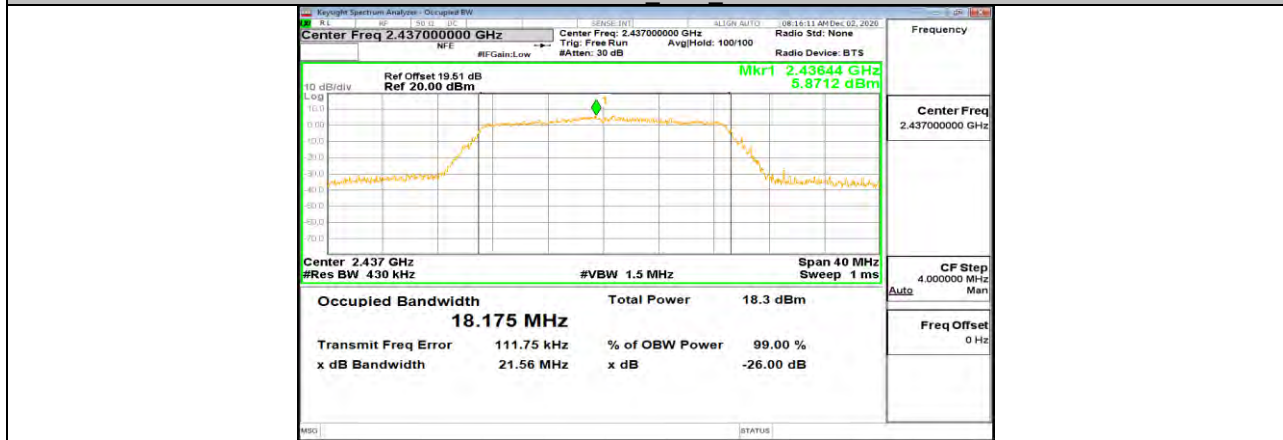

11N20SISO Ant1 2437

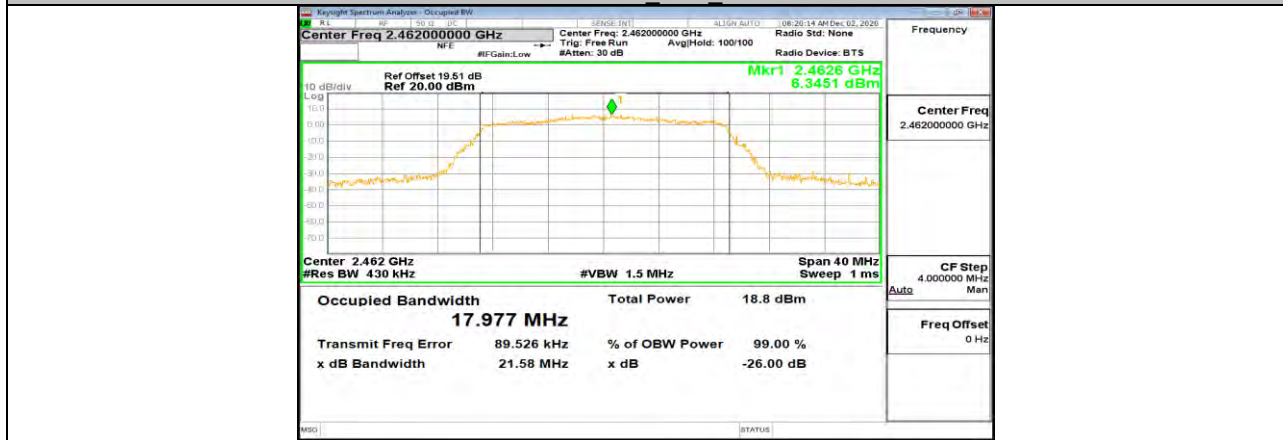

11N20SISO Ant1 2462



11.3. Appendix C: Maximum AVG conducted output power
11.3.1. Test Result

Test Mode	Antenna	Channel	Result[dBm]	Limit[dBm]	Verdict
11B	Ant1	2412	12.12	<=30	PASS
		2437	12.73	<=30	PASS
		2462	13.05	<=30	PASS
11G	Ant1	2412	11.63	<=30	PASS
		2437	11.90	<=30	PASS
		2462	12.44	<=30	PASS
11N20SISO	Ant1	2412	11.67	<=30	PASS
		2437	12.19	<=30	PASS
		2462	12.65	<=30	PASS



11.4. Appendix D: Maximum power spectral density

11.4.1. Test Result

Test Mode	Antenna	Channel	Result[dBm/3kHz]	Limit[dBm/3kHz]	Verdict
11B	Ant1	2412	-8.66	<=8	PASS
		2437	-9.09	<=8	PASS
		2462	-8.57	<=8	PASS
11G	Ant1	2412	-11.63	<=8	PASS
		2437	-11.29	<=8	PASS
		2462	-10.51	<=8	PASS
11N20SISO	Ant1	2412	-11.34	<=8	PASS
		2437	-11.82	<=8	PASS
		2462	-10.65	<=8	PASS

11.4.2. Test Graphs

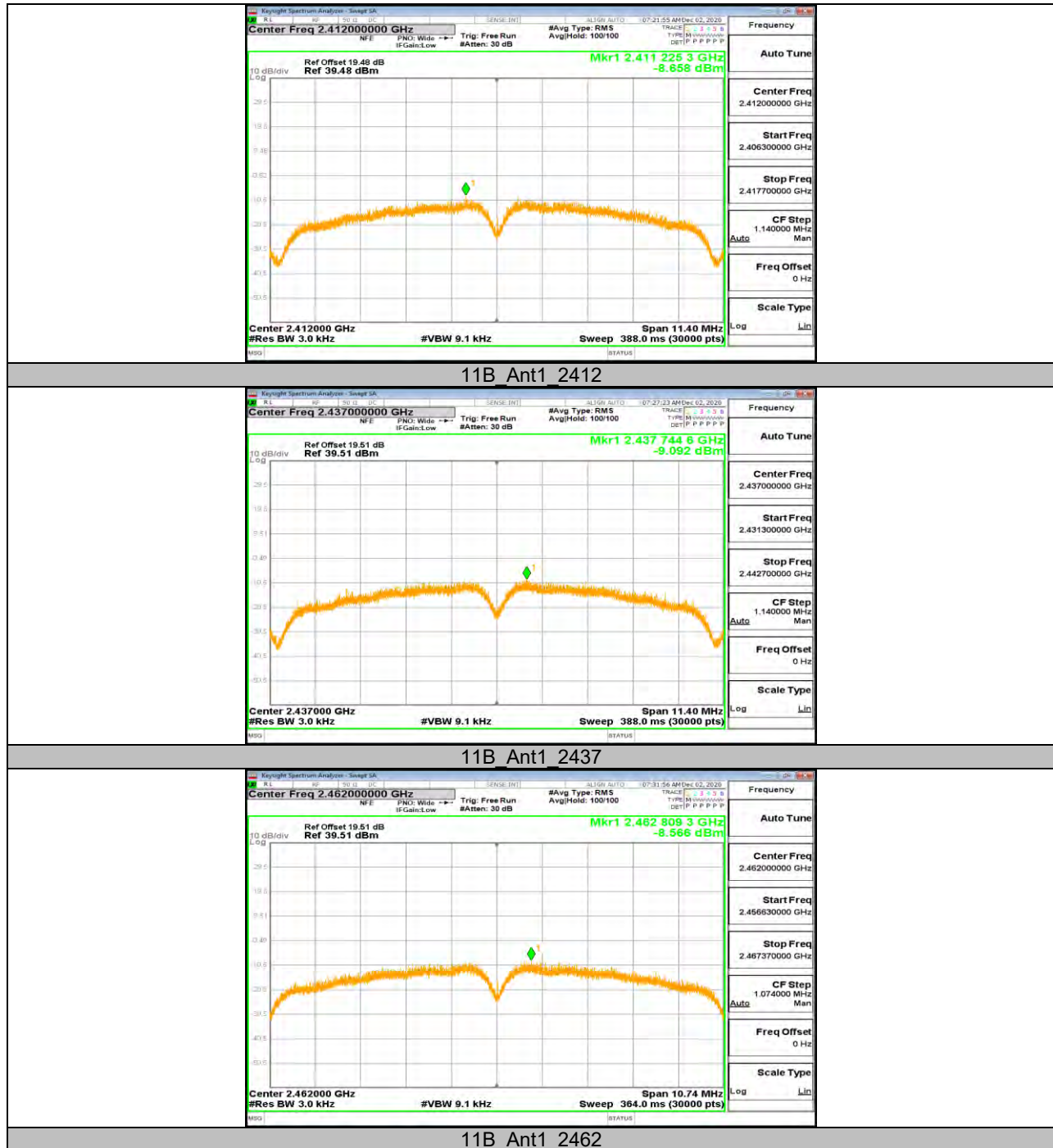



11G Ant1 2412



11G Ant1 2437



11G Ant1 2462



11N20SISO Ant1 2412



11N20SISO Ant1 2437

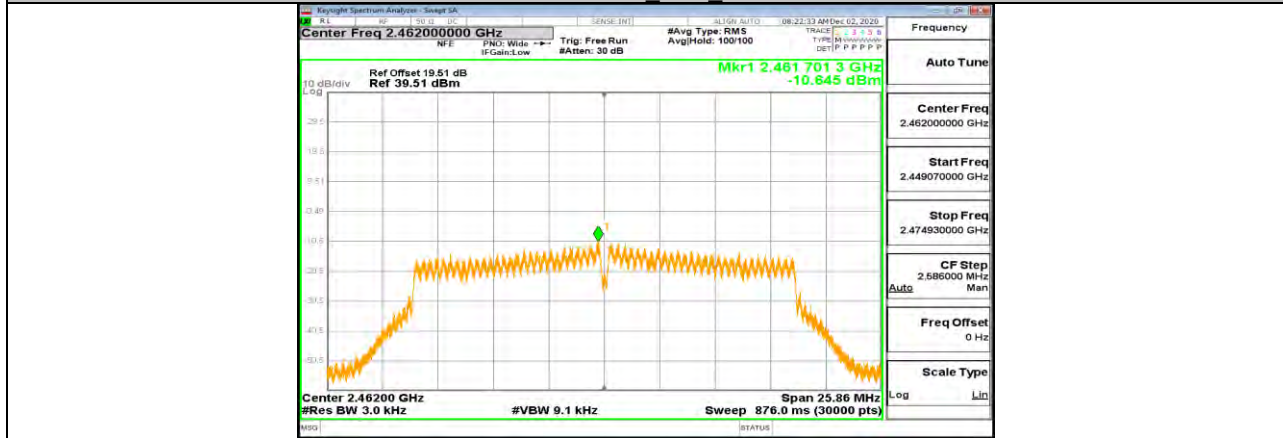

11N20SISO Ant1 2462



11.5. Appendix E: Band edge measurements

11.5.1. Test Result

Test Mode	Antenna	ChName	Channel	RefLevel[dBm]	Result[dBm]	Limit[dBm]	Verdict
11B	Ant1	Low	2412	3.69	-39.68	<=-26.31	PASS
		High	2462	4.90	-41.26	<=-25.1	PASS
11G	Ant1	Low	2412	-0.61	-35.18	<=-30.61	PASS
		High	2462	0.69	-40.71	<=-29.32	PASS
11N20SISO	Ant1	Low	2412	0.65	-35.67	<=-29.35	PASS
		High	2462	0.77	-39.73	<=-29.24	PASS

11.5.2. Test Graphs



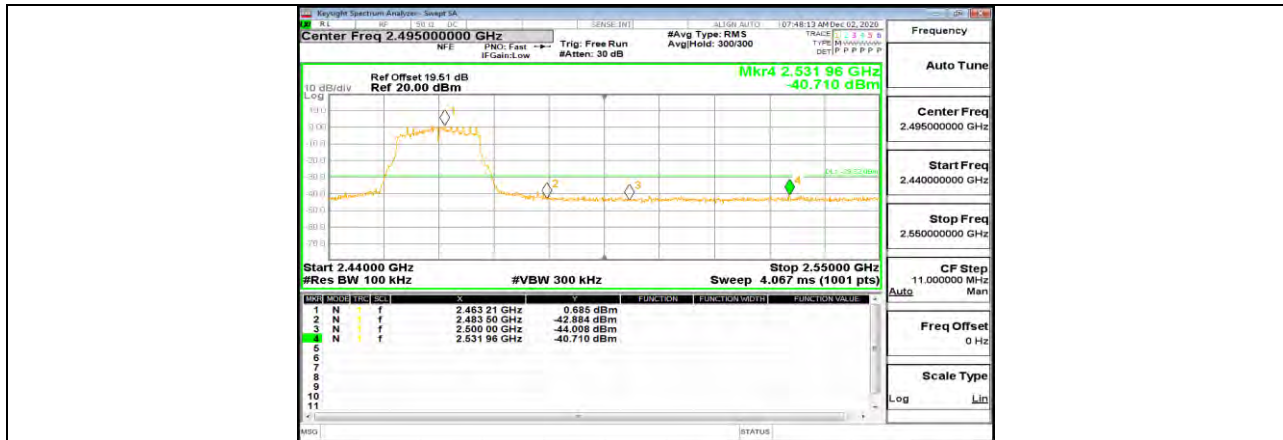

11G Ant1 High 2462

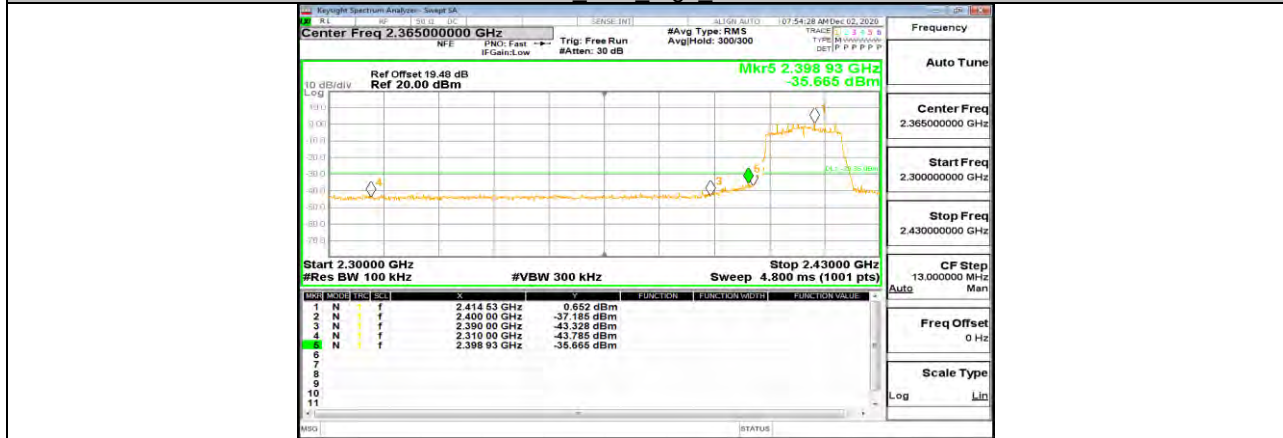

11N20SISO Ant1 Low 2412



11N20SISO Ant1 High 2462

**11.6. Appendix F: Conducted Spurious Emission****11.6.1. Test Result**

Test Mode	Antenna	Channel	FreqRange [Mhz]	RefLevel [dBm]	Result [dBm]	Limit [dBm]	Verdict
11B	Ant1	2412	Reference	4.01	4.01	---	PASS
			30~1000	---	-52.87	<=-25.99	PASS
			1000~26500	---	-45.12	<=-25.99	PASS
		2437	Reference	3.81	3.81	---	PASS
			30~1000	---	-52.92	<=-26.19	PASS
			1000~26500	---	-45.08	<=-26.19	PASS
		2462	Reference	4.80	4.80	---	PASS
			30~1000	---	-53.48	<=-25.2	PASS
			1000~26500	---	-44.75	<=-25.2	PASS
11G	Ant1	2412	Reference	-0.38	-0.38	---	PASS
			30~1000	---	-52.81	<=-30.38	PASS
			1000~26500	---	-44.6	<=-30.38	PASS
		2437	Reference	0.32	0.32	---	PASS
			30~1000	---	-53.6	<=-29.68	PASS
			1000~26500	---	-44.16	<=-29.68	PASS
		2462	Reference	0.43	0.43	---	PASS
			30~1000	---	-52.82	<=-29.57	PASS
			1000~26500	---	-44.61	<=-29.57	PASS
11N20SISO	Ant1	2412	Reference	0.62	0.62	---	PASS
			30~1000	---	-53.79	<=-29.38	PASS
			1000~26500	---	-44.07	<=-29.38	PASS
		2437	Reference	0.91	0.91	---	PASS
			30~1000	---	-53.41	<=-29.09	PASS
			1000~26500	---	-44.72	<=-29.09	PASS
		2462	Reference	0.80	0.80	---	PASS
			30~1000	---	-52.87	<=-29.2	PASS
			1000~26500	---	-44.9	<=-29.2	PASS

11.6.2. Test Graphs





11B Ant1 2437 0-Reference



11B Ant1 2437 30-1000

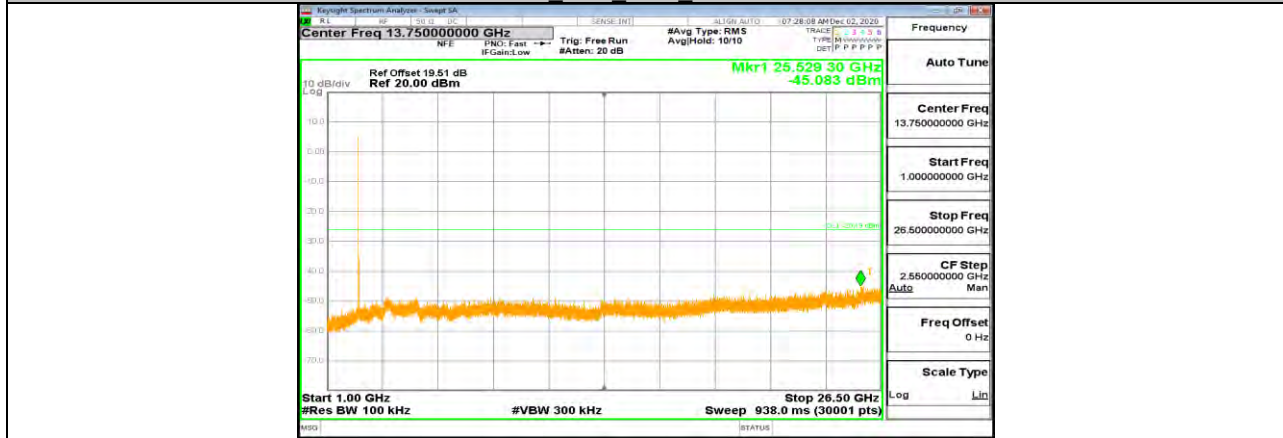

11B Ant1 2437 1000-26500



11B Ant1 2462 0-Reference

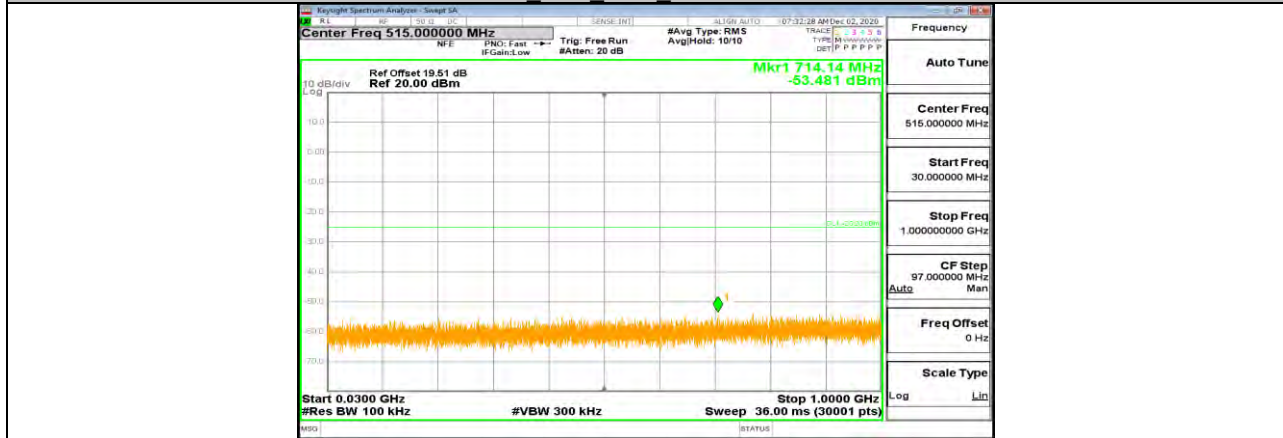

11B Ant1 2462 30~1000

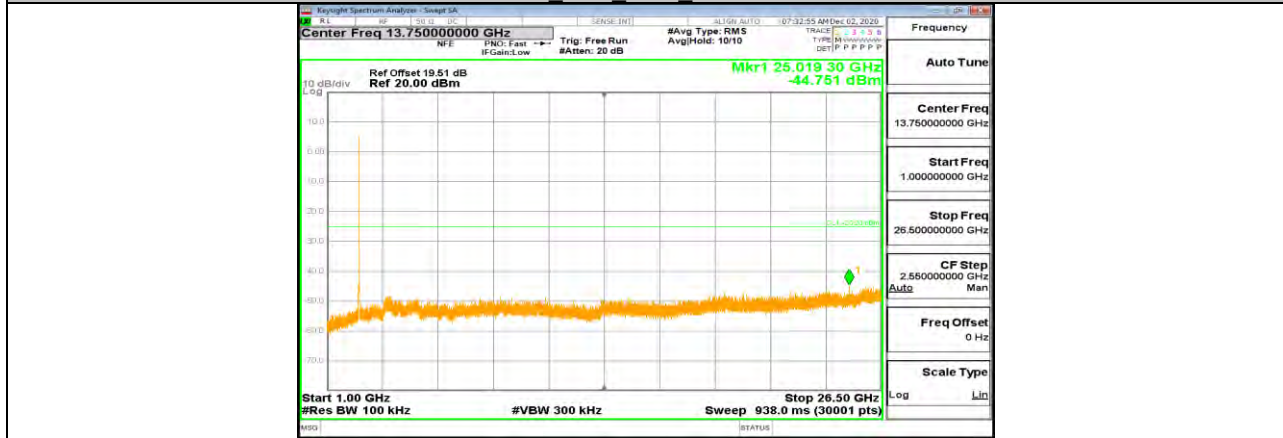

11B Ant1 2462 1000~26500



11G Ant1 2412 0~Reference

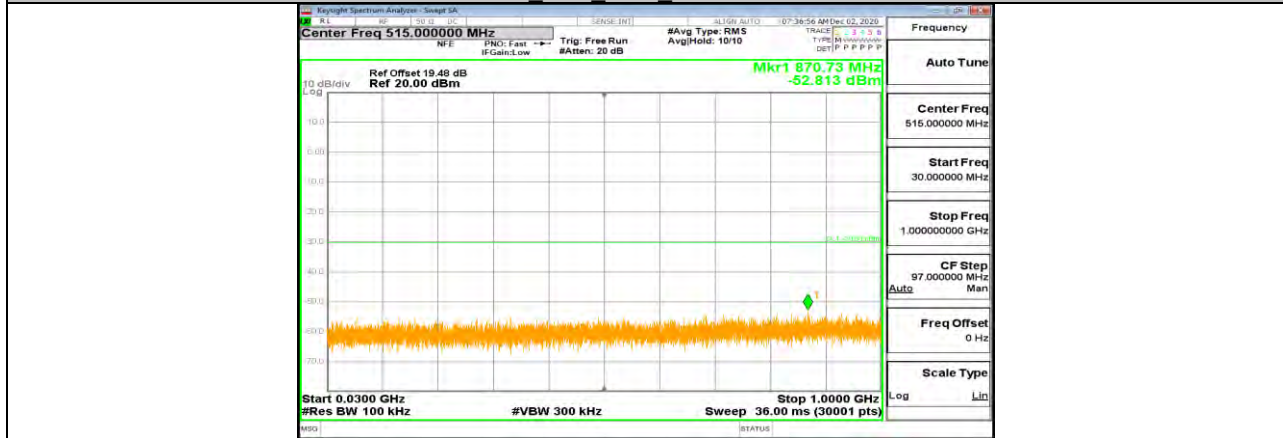

11G Ant1 2412 30~1000

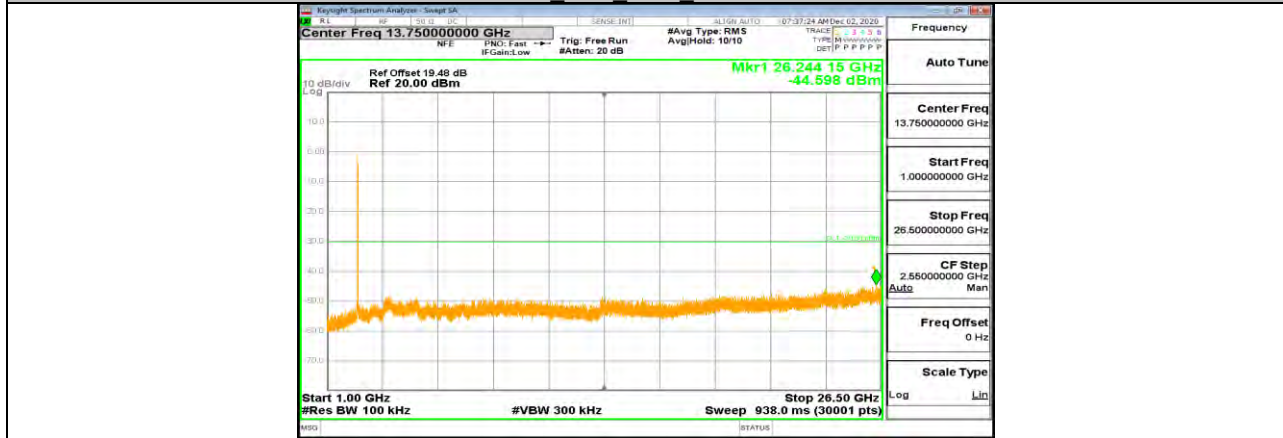

11G Ant1 2412 1000~26500



11G Ant1 2437 0~Reference

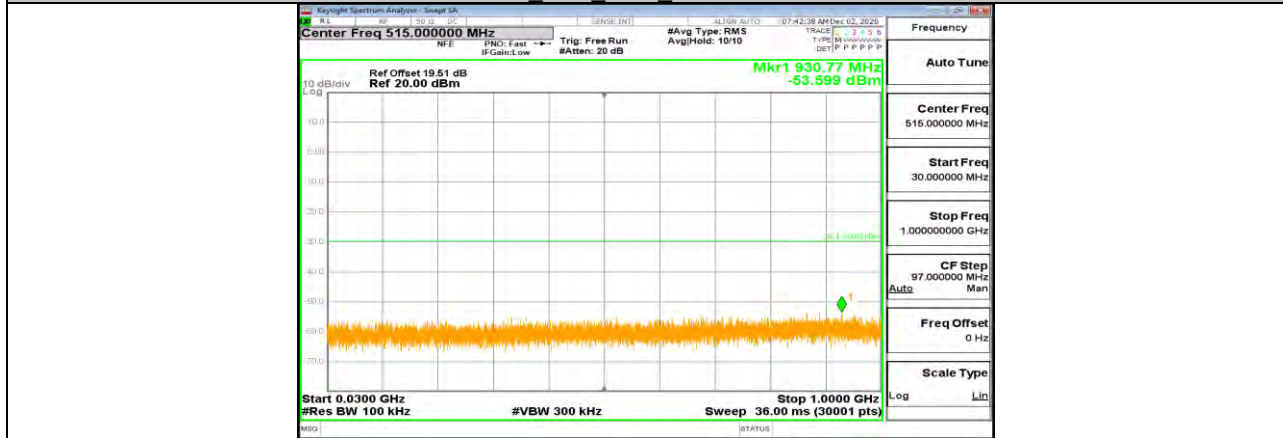

11G Ant1 2437 30~1000

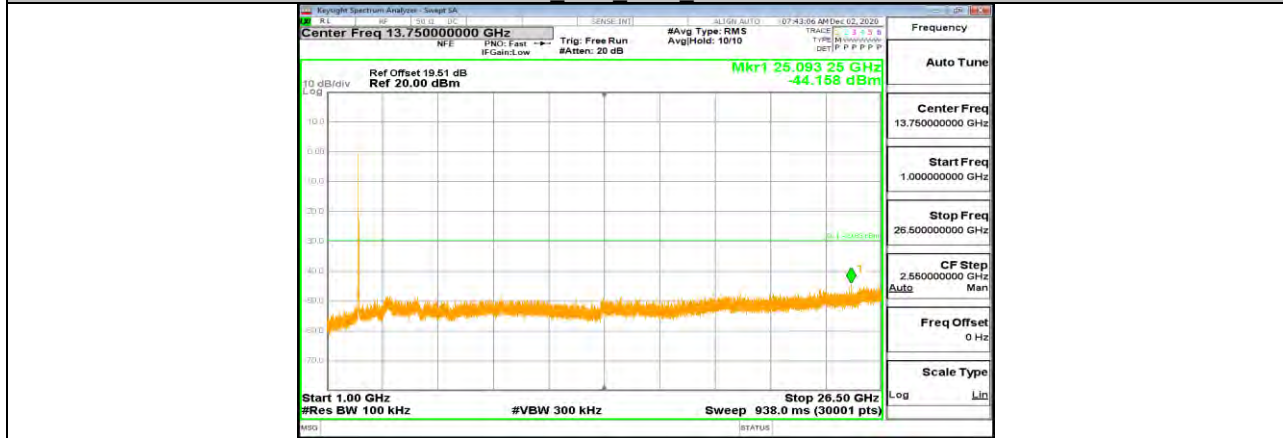

11G Ant1 2437 1000~26500



11G Ant1 2462 0~Reference

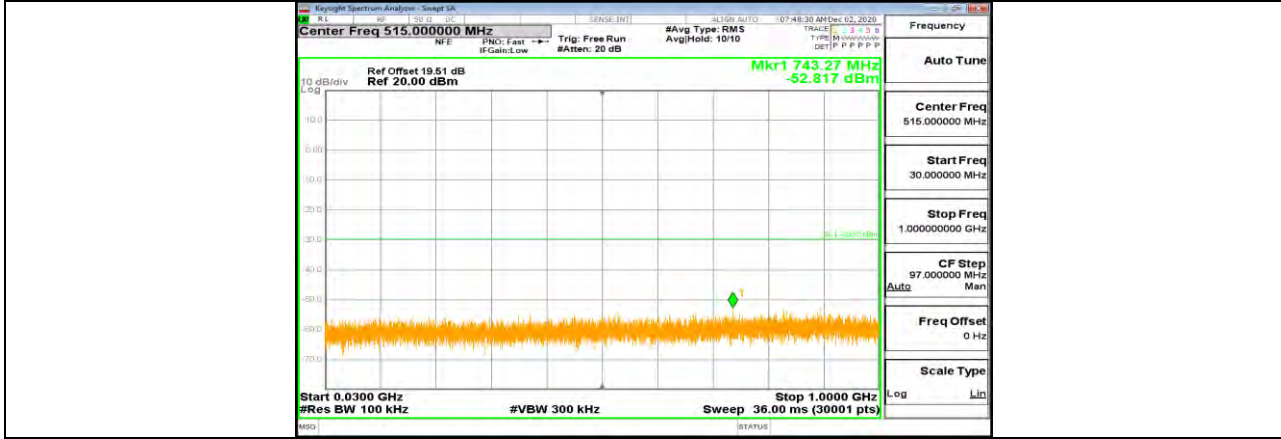

11G Ant1 2462 30~1000

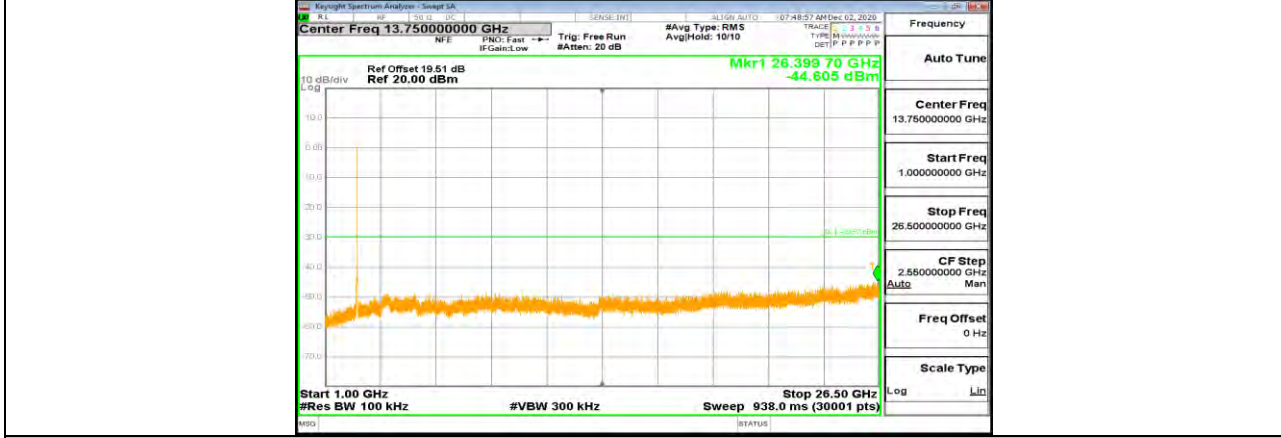

11G Ant1 2462 1000~26500



11N20SISO Ant1 2412 0~Reference

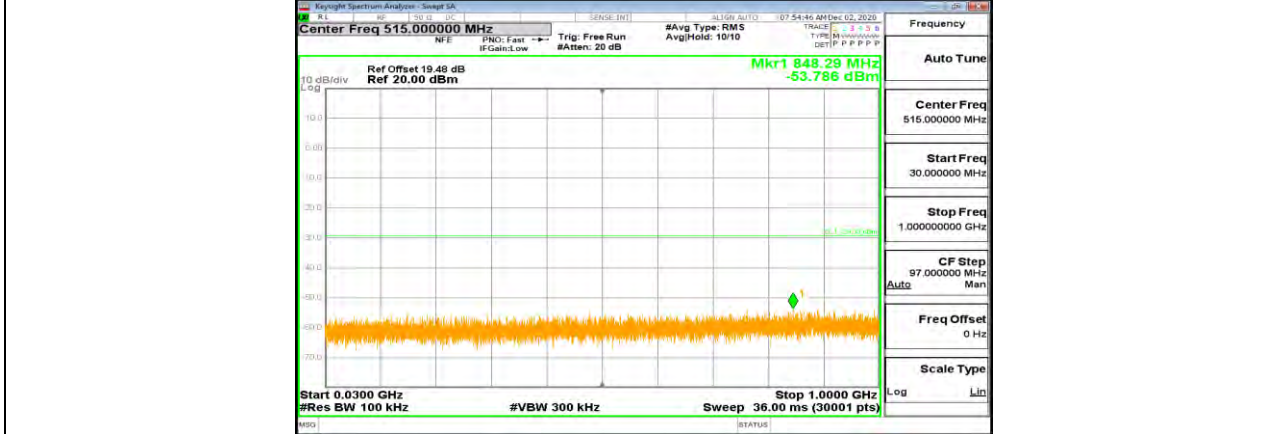

11N20SISO Ant1 2412 30~1000

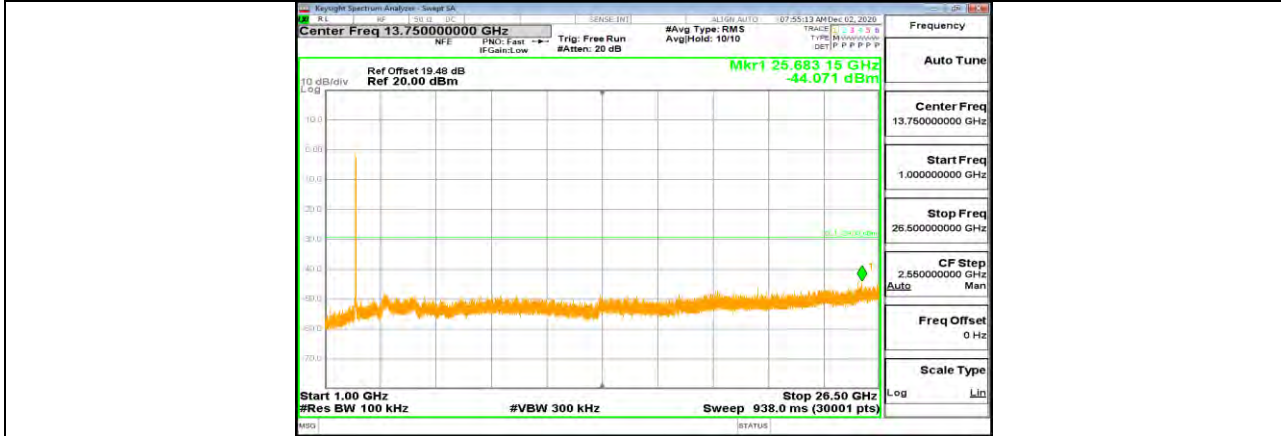

11N20SISO Ant1 2412 1000~26500



11N20SISO Ant1 2437 0~Reference

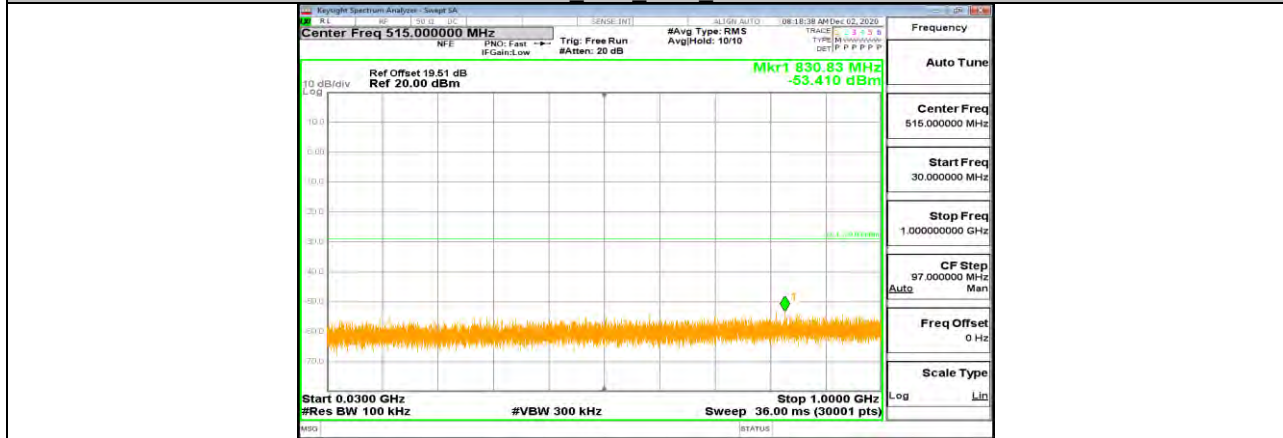

11N20SISO Ant1 2437 30~1000

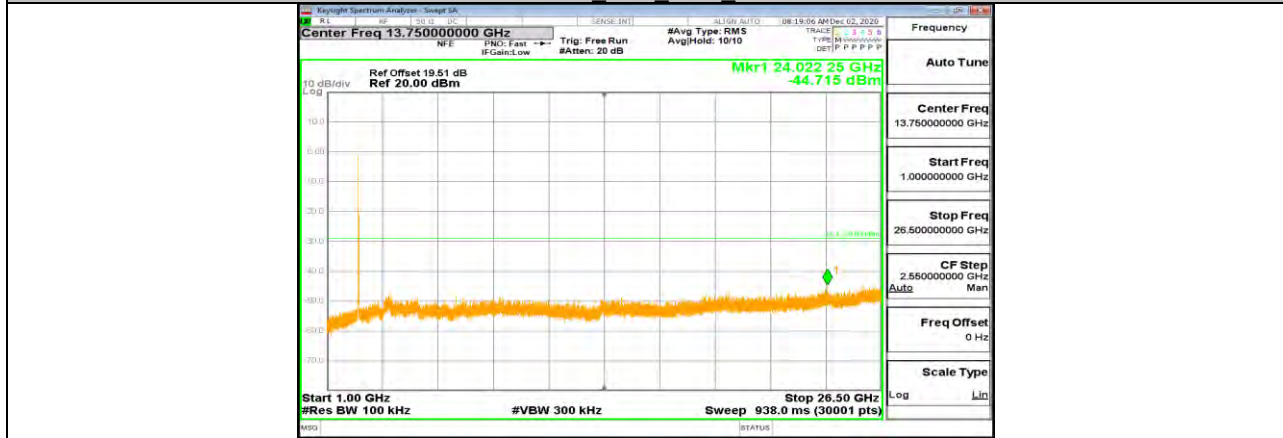

11N20SISO Ant1 2437 1000~26500



11N20SISO Ant1 2462 0~Reference

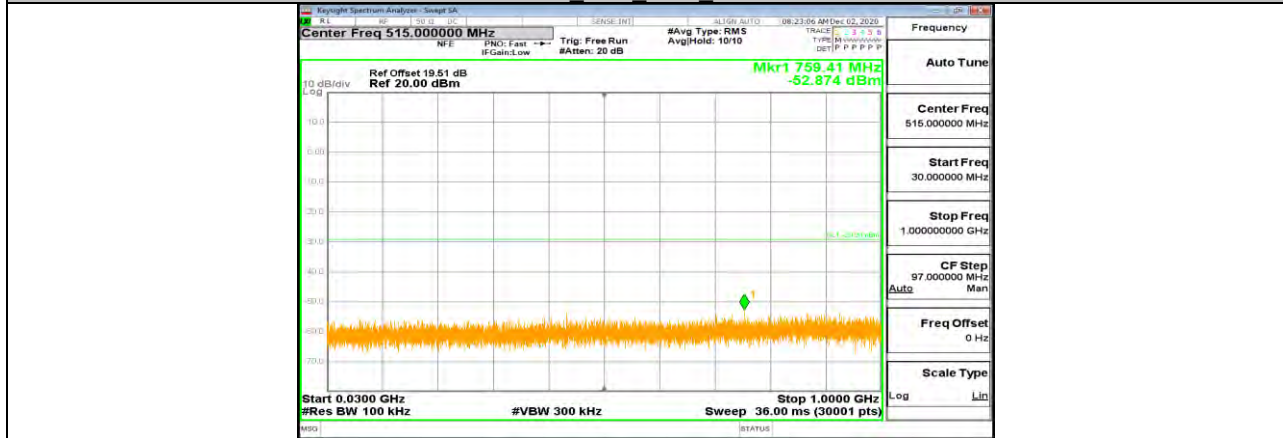

11N20SISO Ant1 2462 30~1000

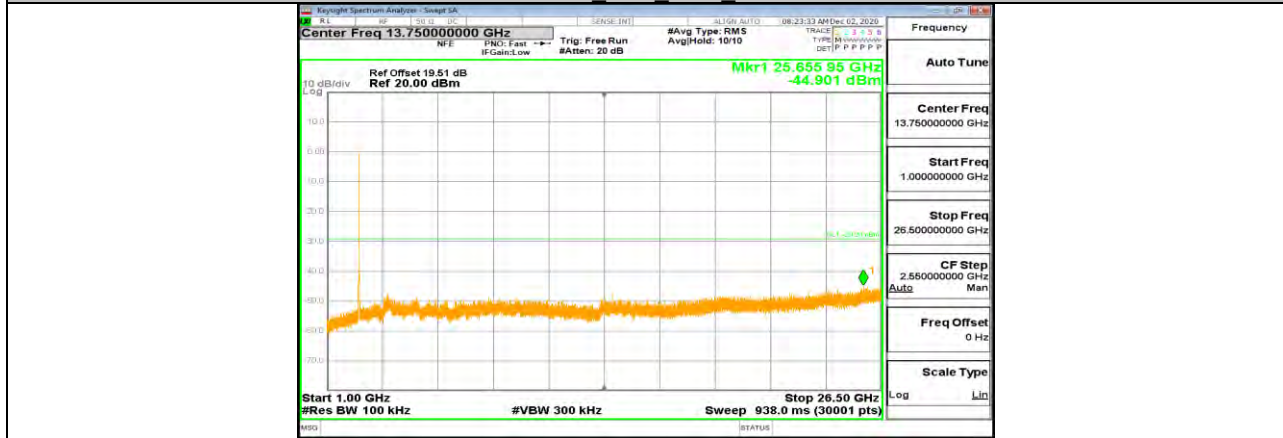

11N20SISO Ant1 2462 1000~26500



11.7. Appendix G: Duty Cycle

11.7.1. Test Result

Mode	On Time (msec)	Period (msec)	Duty Cycle x (Linear)	Duty Cycle (%)	Duty Cycle Correction Factor (dB)	1/T Minimum VBW (kHz)	Final setting For VBW (kHz)
11B	8.41	8.45	0.9953	99.53	0.02	0.12	0.01
11G	1.39	1.44	0.9653	96.53	0.15	0.72	1
11N20SISO	1.31	1.35	0.9704	97.04	0.13	0.76	1

Note:

Duty Cycle Correction Factor=10log (1/x).

Where: x is Duty Cycle (Linear)

Where: T is On Time

The final setting for 802.11b is 0.01 kHz due to duty cycle of it is above 98%.

If that calculated VBW is not available on the analyzer then the next higher value should be used.



11.7.2. Test Graphs

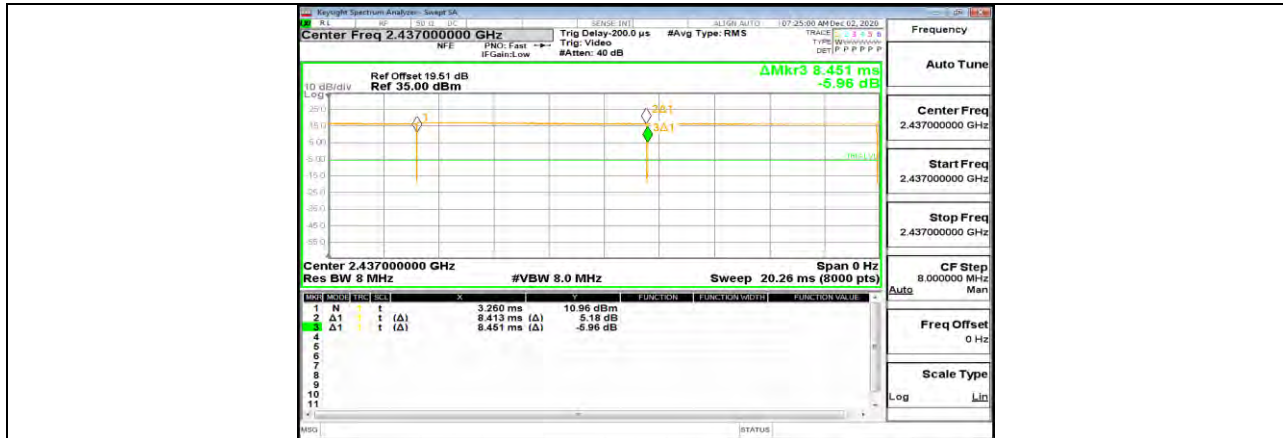

11B Ant1 2437

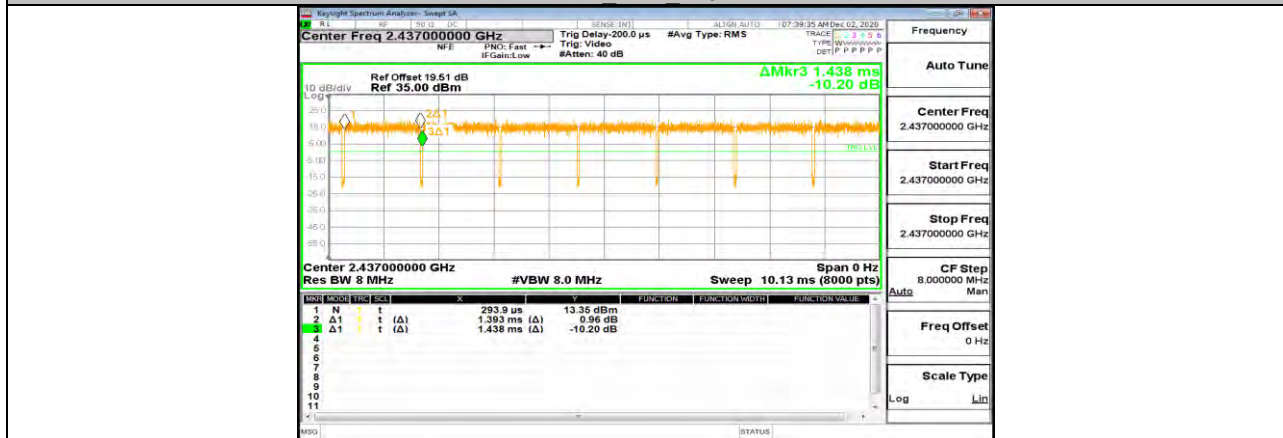

11G Ant1 2437



11N20SISO Ant1 2437

END OF REPORT