

TEST REPORT

Product Name : **Media Player**
Model Number : **9401-2HDT-V01, 9401-3HDT-V01**
Contains FCC ID : **2AAGE9260NG**

Prepared for : Chengdu Vantron Technology Co., Ltd.
Address : No.5 GaoPeng Road, Hi-Tech Zone, Chengdu, SiChuan, P.R.
China

Prepared by : EMTEK (SHENZHEN) CO., LTD.
Address : Building 69, Majialong Industry Zone, Nanshan District,
Shenzhen, Guangdong, China

Tel: (0755) 26954280
Fax: (0755) 26954282

Report Number : ENS2310310032W00104R
Date(s) of Tests : October 31, 2023 to December 4, 2023
Date of issue : December 4, 2023

1 TEST RESULT CERTIFICATION

Applicant : Chengdu Vantron Technology Co., Ltd.
 Address : No.5 GaoPeng Road, Hi-Tech Zone, Chengdu, SiChuan, P.R. China
 Manufacturer : Chengdu Vantron Technology Co., Ltd.
 Address : No.5 GaoPeng Road, Hi-Tech Zone, Chengdu, SiChuan, P.R. China
 EUT : Media Player
 Model Name : 9401-2HDT-V01, 9401-3HDT-V01
 Trademark : Vantron

Measurement Procedure Used:

APPLICABLE STANDARDS	
STANDARD	TEST RESULT
FCC 47 CFR Part 2, Subpart J FCC 47 CFR Part 15, Subpart E	PASS
IC RSS-GEN, Issue 5(04-2018)+A1(03-2019)+A2(02-2021) IC RSS-247 Issue 2(02-2017)	PASS

The above equipment was tested by EMTEK (SHENZHEN) CO., LTD. The test data, data evaluation, test procedures, and equipment configurations shown in this report were made in accordance with the procedures given in ANSI C63.10 (2013) and the energy emitted by the sample EUT tested as described in this report is in compliance with the requirements of FCC Rules Part 2, Part 15.407, IC RSS-247 Issue 2 and IC RSS-GEN, Issue 5.

The test results of this report relate only to the tested sample identified in this report.

Date of Test : October 31, 2023 to December 4, 2023

Prepared by : 
 Una Yu/Editor

Reviewer : 
 Joe Xia/Supervisor

Approve & Authorized Signer : 
 Lisa Wang/Manager

Modified History

Version	Report No.	Revision Date	Summary
Ver.1.0	ENS2310310032W00104R	/	Original Report
<p>Note: This change is to request approval for mobile category specific host product, Antenna Type is external antenna, At the same time we used the software to shutdown other BANDS(U-NII-2AandU-NII-2C), According to the requirements for antenna Change in KDB178919 D01 Permissive Change Policy v06, the antenna types are different and the gain value is smaller than the original, Radiated Spurious Emission tests were performed to verify RF compliance,and the results of other test items remained unchanged based on the original report:170524-01.TR01,170524-01.TR02, 170524-01.TR03.</p>			



TABLE OF CONTENTS

1	TEST RESULT CERTIFICATION	2
2	EUT TECHNICAL DESCRIPTION	5
3	SUMMARY OF TEST RESULT	6
4	TEST METHODOLOGY	7
4.1	GENERAL DESCRIPTION OF APPLIED STANDARDS	7
4.2	MEASUREMENT EQUIPMENT USED	7
4.3	DESCRIPTION OF TEST MODES	9
5	FACILITIES AND ACCREDITATIONS	12
5.1	FACILITIES	12
5.2	EQUIPMENT	12
5.3	LABORATORY ACCREDITATIONS AND LISTINGS	12
6	TEST SYSTEM UNCERTAINTY	13
7	SETUP OF EQUIPMENT UNDER TEST	14
7.1	RADIO FREQUENCY TEST SETUP	14
7.2	RADIO FREQUENCY TEST SETUP	14
7.3	CONDUCTED EMISSION TEST SETUP	17
7.4	BLOCK DIAGRAM CONFIGURATION OF TEST SYSTEM	18
7.5	SUPPORT EQUIPMENT	18
7.6	UNDESIRABLE RADIATED SPURIOUS EMISSION	19

2 EUT TECHNICAL DESCRIPTION

Characteristics	Description
Product:	Media Player
Model Number:	9401-2HDT-V01, 9401-3HDT-V01 (The 9401-3HDT-V01 has three HDBase-T ports, and the 9401-2HDT-V01 has two HDBase-T ports. Product schematic, PCB Layout, appearance are consistent)
Sample Number:	2#
Wifi Type:	Wifi 5G with 5150MHz-5250MHz Band Wifi 5G with 5725MHz-5850MHz Band
WLAN Supported:	802.11a/n/ac
Data Rate :	802.11a: 54/48/36/24/18/12/9/6Mbps 802.11n: MCS0-MCS15 802.11ac: MCS0-MCS9
Modulation:	OFDM with BPSK/QPSK/16QAM/64QAM for 802.11a/n OFDM with BPSK/QPSK/16QAM/64QAM/256QAM for 802.11ac
Frequency Range:	UNII-1: 5150MHz-5250MHz Band 5180-5240MHz for 802.11a/n(HT20)/ac(VHT20); 5190-5230MHz for 802.11n(HT40)/ac(VHT40); 5210MHz for 802.11ac(VHT80) 5250MHz for 802.11ac(VHT160)
	UNII-3 with 5725MHz-5850MHz Band 5745-5825MHz for 802.11a/n(HT20)/ac(VHT20); 5755-5795MHz for 802.11n(HT40)/ac(VHT40); 5775MHz for 802.11ac(VHT80);
TPC Function:	Not Applicable
Antenna Type:	External Antenna
Antenna Gain:	Antenna 1:3.5 dBi Antenna 2:3.5 dBi
Power Supply:	DC 19V from adapter
Adapter:	MODEL:FJ-SW20171903420 INPUT:AC 100-240V~50/60Hz 1.5A Max OUTPUT:19V, 3.42A 64.98W
Test voltage:	AC 120V/60Hz
Date of Received:	October 31, 2023
Temperature Range:	0-35℃

Note: For more details, please refer to the User's manual of the EUT.

3 SUMMARY OF TEST RESULT

FCC PartClause	IC Part Clause	Test Parameter	Verdict	Remark
15.407 (b) 15.209 15.205	RSS-247, 6.2 RSS-Gen 8.9 RSS-Gen 8.10 RSS-Gen 6.13	RadiatedSpurious Emission	PASS	
NOTE1:N/A (Not Applicable) NOTE2:According to FCC OET KDB 789033, the report use radiated measurements in the restricted frequency bands. In addition, the radiated test is also performed to ensure the emissions emanating from the device cabinet also comply with the applicable limits.				

RELATED SUBMITTAL(S) / GRANT(S):

This submittal(s) (test report) is intended for **ContainsFCC ID:2AAGE9260NG** filing to comply with Section 15.407 of the FCC Part 15, Subpart C Rules.

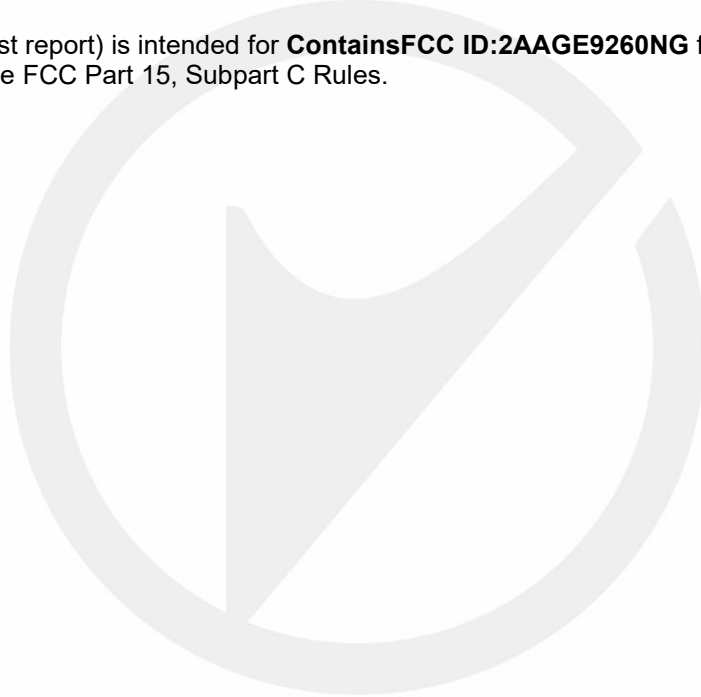

4 TEST METHODOLOGY

4.1 GENERAL DESCRIPTION OF APPLIED STANDARDS

According to its specifications, the EUT must comply with the requirements of the following standards:

FCC 47 CFR Part 2, Subpart J

FCC 47 CFR Part 15, Subpart E

IC RSS-GEN, Issue 5(04-2018)+A1(03-2019)+A2(02-2021)

IC RSS-247 Issue 2(02-2017)

FCC KDB 662911 D01 Multiple Transmitter Output v02r01

FCC KDB 789033 D2 General UNII Test Procedures New Rules v02r01

4.2 MEASUREMENT EQUIPMENT USED

Conducted Emission Test Equipment

Equipment	Manufacturer	Model No.	Serial No.	Last Cal.	Cal. Interval
EMI Test Receiver	Rohde & Schwarz	ESCI	101384	2023/5/13	1Year
AMN	Rohde & Schwarz	ENV216	101161	2023/5/13	1Year
AMN	Kyoritsu	KNW-407	8-1492-9	2023/5/11	1Year

For Spurious Emissions Test

Equipment	Manufacturer	Model No.	Serial No.	Last Cal.	Cal. Interval
Pre-Amplifier	HP	8447F	2944A07999	2023/5/13	1Year
EMI Test Receiver	Rohde & Schwarz	ESCI	101414	2023/5/13	1Year
Bilog Antenna	Schwarzbeck	VULB9163	712	2023/7/2	2 Year
Horn antenna	Schwarzbeck	BBHA9120D	9120D-1178	2023/6/2	2 Year
Pre-Amplifie	Lunar EM	LNA1G18-48	J101113101000 1	2023/5/10	1Year
Spectrum Analyzer	Rohde & Schwarz	FSV40	100967	2023/5/10	1Year
Horn antenna	Schwarzbeck	BBHA9170	9170-399	2023/5/12	2 Year
Cable	H+B	NmSm-05-C15052	N/A	2023/5/13	1 Year
Cable	H+B	NmSm-2-C15201	N/A	2023/5/13	1 Year
Cable	H+B	NmNm-7-C15702	N/A	2023/5/13	1 Year
Cable	H+B	SAC-40G-1	414	2023/5/13	1 Year
Cable	H+B	SUCOFLEX104	MY14871/4	2023/5/13	1 Year
Cable	H+B	BLU18A-NmSm-650 0	D8501	2023/5/13	1 Year
Band reject Filter(50dB)	WI/DE	WRCGV-2400(2400- 2485MHz)	2	2023/5/13	1 Year

For other test items:

Equipment	Manufacturer	Model No.	Serial No.	Last Cal.	Cal. Interval
Signal Analyzer	Agilent	N9010A	MY53470879	2023/5/10	1Year
Vector Signal Generator	Agilent	N5182B	MY53050878	2023/5/10	1Year
Analog Signal Generator	Agilent	N5171B	MY53050553	2023/5/10	1Year
Power Meter	Agilent	PS-X10-100	\	2023/5/13	1Year
Temperature&Humidity Chamber	ESPEC	EL-02KA	12107166	2023/5/10	1Year



4.3 DESCRIPTION OF TEST MODES

The EUT has been tested under its typical operating condition.

The EUT configuration for testing is installed on RF field strength measurement to meet the Commissions requirement and operating in a manner which intends to maximize its emission characteristics in a continuous normal application.

The Transmitter was operated in the normal operating mode. The TX frequency was fixed which was for the purpose of the measurements.

Test of channel included the lowest and middle and highest frequency to perform the test, then record on this report.

Those data rates (802.11a: 54 Mbps; 802.11n(HT20): MCS0; 802.11ac(VHT20): MCS0; 802.11n(HT40): MCS0; 802.11ac(VHT40): MCS0; 802.11ac(VHT80): MCS0;) were used for all test.

Pre-defined engineering program for regulatory testing used to control the EUT for staying in continuous transmitting and receiving mode is programmed.

Wifi 5G with U-NII - 1

Frequency and Channel list for 802.11a, 802.11n (HT20), 802.11ac (VHT20):

Channel	Frequency (MHz)	Channel	Frequency (MHz)	Channel	Frequency (MHz)
36	5180	44	5220		
40	5200	48	5240		

Frequency and Channel list for 802.11n (HT40), 802.11ac (VHT40):

Channel	Frequency (MHz)	Channel	Frequency (MHz)	Channel	Frequency (MHz)
38	5190	46	5230		

Frequency and Channel list for 802.11ac (VHT80):

Channel	Frequency (MHz)	Channel	Frequency (MHz)	Channel	Frequency (MHz)
42	5210				

Frequency and Channel list for 802.11ac (VHT160):

Channel	Frequency (MHz)	Channel	Frequency (MHz)	Channel	Frequency (MHz)
50	5250				

Test Frequency and Channel for 802.11a, 802.11n (HT20), 802.11ac (VHT20):

Lowest Frequency		Middle Frequency		Highest Frequency	
Channel	Frequency (MHz)	Channel	Frequency (MHz)	Channel	Frequency (MHz)
36	5180	40	5200	48	5240

Test Frequency and channel for 802.11n (HT40), 802.11ac (VHT40):

Lowest Frequency		Middle Frequency		Highest Frequency	
Channel	Frequency (MHz)	Channel	Frequency (MHz)	Channel	Frequency (MHz)
38	5190	N/A	N/A	46	5230

Test Frequency and channel for 802.11ac (VHT80) :

Lowest Frequency		Middle Frequency		Highest Frequency	
Channel	Frequency (MHz)	Channel	Frequency (MHz)	Channel	Frequency (MHz)
42	5210	N/A	N/A	N/A	N/A

Test Frequency and channel for 802.11ac (VHT160) :

Lowest Frequency		Middle Frequency		Highest Frequency	
Channel	Frequency (MHz)	Channel	Frequency (MHz)	Channel	Frequency (MHz)
50	5250	N/A	N/A	N/A	N/A



Wifi 5G with U-NII -3

Frequency and Channel list for 802.11a, 802.11n (HT20), 802.11ac (VHT20):

Channel	Frequency (MHz)	Channel	Frequency (MHz)	Channel	Frequency (MHz)
149	5745	157	5785	165	5825
153	5765	161	5805		

Frequency and Channel list for 802.11n (HT40), 802.11ac (VHT40):

Channel	Frequency (MHz)	Channel	Frequency (MHz)	Channel	Frequency (MHz)
151	5755	159	5795		

Frequency and Channel list for 802.11ac (VHT80):

Channel	Frequency (MHz)	Channel	Frequency (MHz)	Channel	Frequency (MHz)
155	5775				

Test Frequency and Channel for 802.11a, 802.11n (HT20), 802.11ac (VHT20):

Lowest Frequency		Middle Frequency		Highest Frequency	
Channel	Frequency (MHz)	Channel	Frequency (MHz)	Channel	Frequency (MHz)
149	5745	157	5785	165	5825

Test Frequency and channel for 802.11n (HT40), 802.11ac (VHT40):

Lowest Frequency		Middle Frequency		Highest Frequency	
Channel	Frequency (MHz)	Channel	Frequency (MHz)	Channel	Frequency (MHz)
151	5755	N/A	N/A	159	5795

Test Frequency and channel for 802.11ac (VHT80):

Lowest Frequency		Middle Frequency		Highest Frequency	
Channel	Frequency (MHz)	Channel	Frequency (MHz)	Channel	Frequency (MHz)
155	5775				

5 FACILITIES AND ACCREDITATIONS

5.1 FACILITIES

All measurement facilities used to collect the measurement data are located at:

EMTEK (Shenzhen) Co., Ltd.

Building 69, Majialong Industry Zone District, Nanshan District, Shenzhen, China

The sites are constructed in conformance with the requirements of ANSI C63.7, ANSI C63.4 and CISPR Publication 22.

5.2 EQUIPMENT

Radiated emissions are measured with one or more of the following types of linearly polarized antennas: tuned dipole, biconical, log periodic, bi-log, and/or ridged waveguide, horn. Spectrum analyzers with preselectors and quasi-peak detectors are used to perform radiated measurements.

Conducted emissions are measured with Line Impedance Stabilization Networks and EMI Test Receivers.

Calibrated wideband preamplifiers, coaxial cables, and coaxial attenuators are also used for making measurements.

All receiving equipment conforms to CISPR Publication 16-1, "Radio Interference Measuring Apparatus and Measurement Methods."

5.3 LABORATORY ACCREDITATIONS AND LISTINGS

Site Description	
EMC Lab.	<p>Accredited by CNAS The Certificate Registration Number is L2291. The Laboratory has been assessed and proved to be in compliance with CNAS-CL01 (identical to ISO/IEC 17025:2017)</p> <p>Accredited by FCC Designation Number: CN1204 Test Firm Registration Number: 882943</p> <p>Accredited by A2LA The Certificate Number is 4321.01.</p> <p>Accredited by Industry Canada The Conformity Assessment Body Identifier is CN0008</p>
Name of Firm	: EMTEK (SHENZHEN) CO., LTD.
Site Location	: Building 69, Majialong Industry Zone, Nanshan District, Shenzhen, Guangdong, China

6 TEST SYSTEM UNCERTAINTY

The following measurement uncertainty levels have been estimated for tests performed on the apparatus:

Test Parameter	Measurement Uncertainty
Radio Frequency	$\pm 1 \times 10^{-5}$
Maximum Peak Output Power Test	$\pm 1.0\text{dB}$
Conducted Emissions Test	$\pm 2.0\text{dB}$
Radiated Emission Test	$\pm 2.0\text{dB}$
Power Density	$\pm 2.0\text{dB}$
Occupied Bandwidth Test	$\pm 1.0\text{dB}$
Band Edge Test	$\pm 3\text{dB}$
All emission, radiated	$\pm 3\text{dB}$
Antenna Port Emission	$\pm 3\text{dB}$
Temperature	$\pm 0.5^\circ\text{C}$
Humidity	$\pm 3\%$

Measurement Uncertainty for a level of Confidence of 95%

7 SETUP OF EQUIPMENT UNDER TEST

7.1 RADIO FREQUENCY TEST SETUP

The WLAN component's antenna ports(s) of the EUT are connected to the measurement instrument per an appropriate attenuator. The EUT is controlled by PC/software to emit the specified signals for the purpose of measurements.

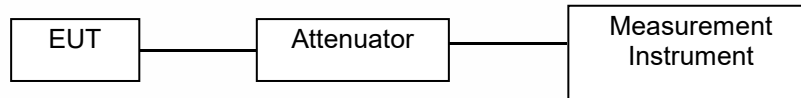

7.2 RADIO FREQUENCY TEST SETUP

The test site semi-anechoic chamber has met the requirement of NSA tolerance 4 dB according to the standards: ANSI C63.10. The test distance is 3m. The setup is according to the requirements in Section 13.1.4.1 of ANSI C63.10-2013 and CAN/CSA-CEI/IEC CISPR 22.

Below 30MHz:

The EUT is placed on a turntable 0.8 meters above the ground in the chamber, 3 meter away from the antenna (loop antenna). The Antenna should be positioned with its plane vertical at the specified distance from the EUT and rotated about its vertical axis for maximum response at each azimuth about the EUT. The center of the loop shall be 1 m above the ground. For certain applications, the loop antenna plane may also need to be positioned horizontally at the specified distance from the EUT.

Above 30MHz:

The EUT is placed on a turntable 0.8 meters above the ground in the chamber, 3 meter away from the antenna. The maximal emission value is acquired by adjusting the antenna height, polarisation and turntable azimuth. Normally, the height range of antenna is 1 m to 4 m, the azimuth range of turntable is 0° to 360°, and the receive antenna has two polarizations Vertical (V) and Horizontal (H).

Above 1GHz:

(Note: the FCC's permission to use 1.5m as an alternative per TCBC Conf call of Dec. 2, 2014.)

The EUT is placed on a turntable 1.5 meters above the ground in the chamber, 3 meter away from the antenna. The maximal emission value is acquired by adjusting the antenna height, polarisation and turntable azimuth. Normally, the height range of antenna is 1 m to 4 m, the azimuth range of turntable is 0° to 360°, and the receive antenna has two polarizations Vertical (V) and Horizontal (H).

Measurements shall be taken, using the following steps, at a test site that has been validated using the procedures of ANSI C63.4 or the latest CISPR 16-1-4 for measurements above 1 GHz, so as to simulate a near free-space environment (see RSS-Gen for applicable versions of ANSI and CISPR standards).

(1) Line the ground plane with absorbers between the transmitter and the receive antenna to minimize reflections. The absorbers used should have a minimum-rated attenuation of 20 dB through the measurement frequency range of interest. The absorbers shall be positioned to replicate the layout used when compliance with the applicable acceptability criterion was achieved, as set forth in the aforementioned standards on site validation.

(2) Set the height of the receive antenna to 1.5 m. The receive antenna must be one that was designed and fabricated to operate over the entire frequency range of interest, for example, an appropriate standard gain horn.

(3) The distance between the receive antenna and the radiating source shall be sufficient in order to ensure far-field conditions.

(4) Mount the transmitter at a height of 1.5 m.

(5) Configure the device under test (DUT) to produce the maximum power spectral density as measured while assessing compliance with Section 6.2.2 (i.e. channel frequency, modulation type and data rate). If the DUT is equipped with a detachable antenna and the antenna is intended for remote installation (i.e. tower-mounted), the DUT may be substituted with a suitable signal generator. The level and frequency settings on the generator shall be set so as to reproduce the maximum power spectral density, measured within a 1 MHz bandwidth, obtained while assessing compliance to Section 6.2.2.

- (6) Position the transmitter or the radiating antenna so that elevation pattern measurements can be taken.
- (7) Find the 0° reference point in the horizontal plane.
- (8) Care should be taken when positioning the receive antenna to avoid cross-polarization. Antennas of known mounting polarization should be assessed with the receive antenna oriented in the same polarity. If the polarization of the transmit antenna is unknown or the transmit antenna can be mounted in either polarization, e.i.r.p. measurements should be performed to find which mounting polarity provides the highest e.i.r.p. value. Testing shall be carried out with the receive antenna and the DUT mounted in each polarity.
- (9) The emission shall be centred on the display of the spectrum analyzer with the following settings:
- If the power spectral density of the DUT was assessed with a peak detector and the antenna cannot be detached from the DUT, the spectrum analyzer shall be set to a peak detector with a resolution bandwidth and video bandwidth of 1 MHz.
 - If the power spectral density of the DUT was assessed using a sample detector with power averaging and the antenna cannot be detached from the DUT, the spectrum analyzer shall be set to a sample detector, configured to produce 100 power averages and set with a resolution bandwidth, as well as a video bandwidth of 1 MHz.
 - If the antenna can be detached from the DUT, a continuous wave (CW) signal equal to that of the power spectral density measurement may be used, the spectrum analyzer shall be set to peak detector with a resolution bandwidth and video bandwidth of 1 MHz.
- (10) Rotate the turntable 360° recording the field strength at each step. Throughout the main beam of the antenna, the step size shall be kept to a maximum of 1°. Once outside the main beam of the antenna, the maximum step size shall be as follows, when compared to the requirements of Section 6.2.2:
- Between 0° and 8°, maximum step size of 2°;
 - Between 8° and 40°, maximum step size of 4°;
 - Between 40° and 45°, maximum step size of 1°;
 - Between 45° and 90°, maximum step size of 5°.
- Once the mask reaches 90°, the mask will be inverted and the step size will follow in the same manner as above.
- For the purpose of this procedure, the main beam of the antenna is defined as the 3 dB beamwidth.
- (11) Convert the measured field strength values in terms of e.i.r.p. density (dBW/1 MHz) using the following equation:
- $$\text{e.i.r.p. density (dBW/MHz)} = 10 \log((E \cdot r)^2 / 30)$$
- E = field strength in V/m
r = measurement distance in metres
- (12) Plot the results against the emission mask with reference to the horizontal plane.
- (13) Using the plot, the 0° can be rotated to determine the worst-case installation tilt angle.
- (14) Testing shall be performed using the highest gain antenna for every antenna type, if applicable.
- (15) Antenna type(s), antenna model number(s), and worst-case tilt angle(s) necessary to remain compliant with the elevation mask requirement set forth in Section 6.2.2(3) of RSS-247 shall be clearly indicated in the user manual.
- The following figure is an example of a polar elevation mask measured using the Method 1 reference to dBμV/m at 3 m.

(a) Radiated Emission Test Set-Up, Frequency Below 30MHz

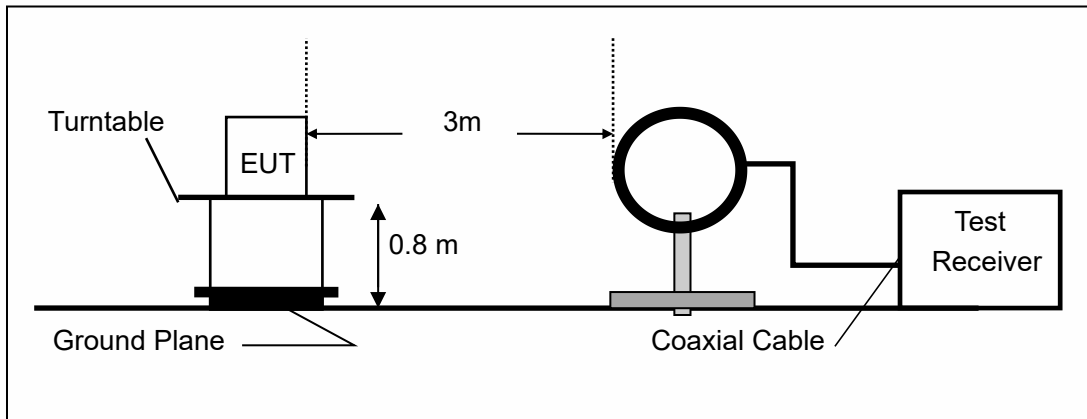

(b) Radiated Emission Test Set-Up, Frequency Below 1000MHz

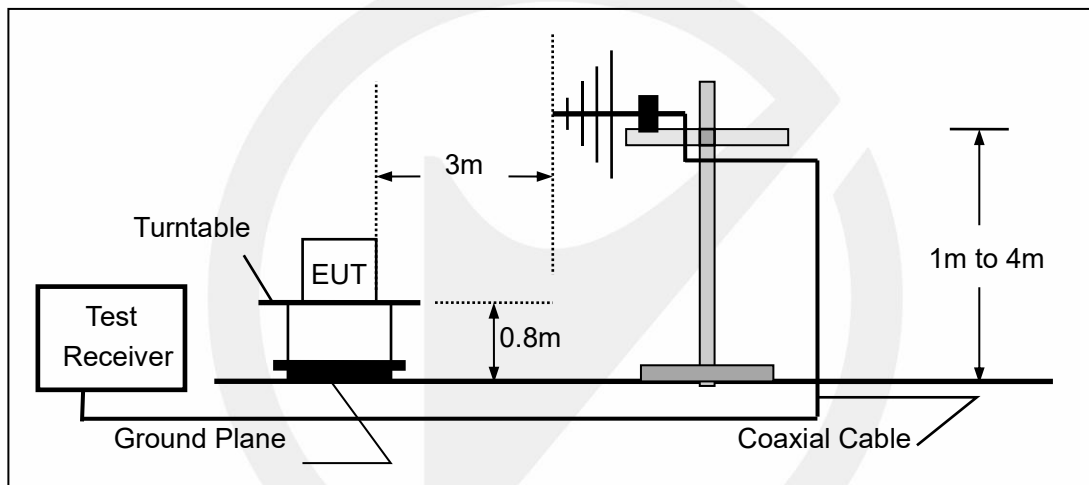

(c) Radiated Emission Test Set-Up, Frequency above 1000MHz

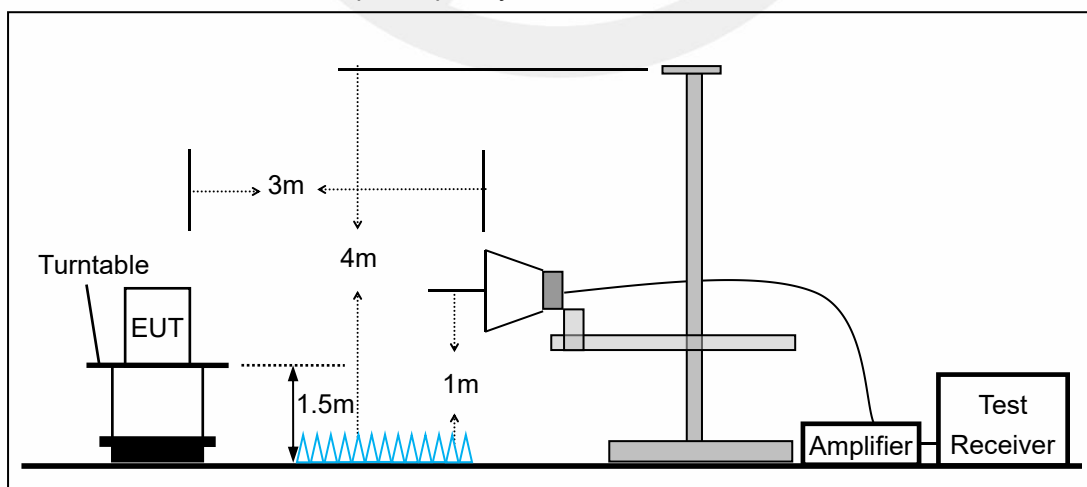

7.3 CONDUCTED EMISSION TEST SETUP

The mains cable of the EUT (maybe per AC/DC Adapter) must be connected to LISN. The LISN shall be placed 0.8 m from the boundary of EUT and bonded to a ground reference plane for LISN mounted on top of the ground reference plane. This distance is between the closest points of the LISN and the EUT. All other units of the EUT and associated equipment shall be at least 0.8m from the LISN.

Ground connections, where required for safety purposes, shall be connected to the reference ground point of the LISN and, where not otherwise provided or specified by the manufacturer, shall be of same length as the mains cable and run parallel to the mains connection at a separation distance of not more than 0.1 m.

According to the requirements in Section 13.1.4.1 of ANSI C63.10-2013 Conducted emissions from the EUT measured in the frequency range between 0.15 MHz and 30 MHz using CISPR Quasi-Peak and average detector mode.

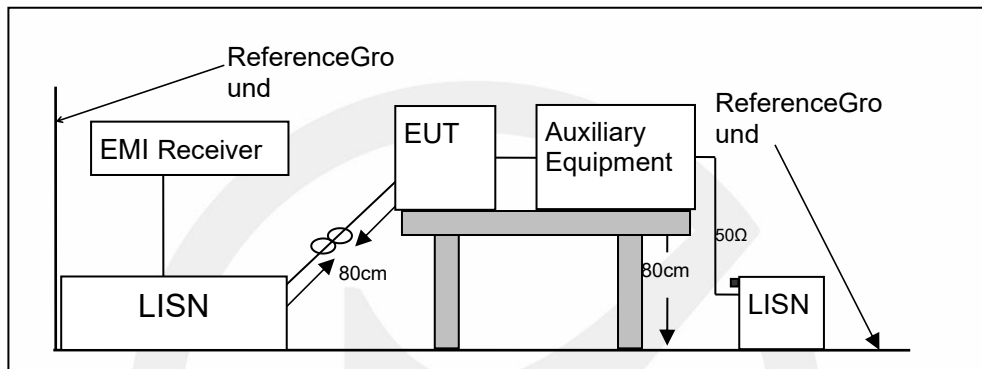

7.4 BLOCK DIAGRAM CONFIGURATION OF TEST SYSTEM

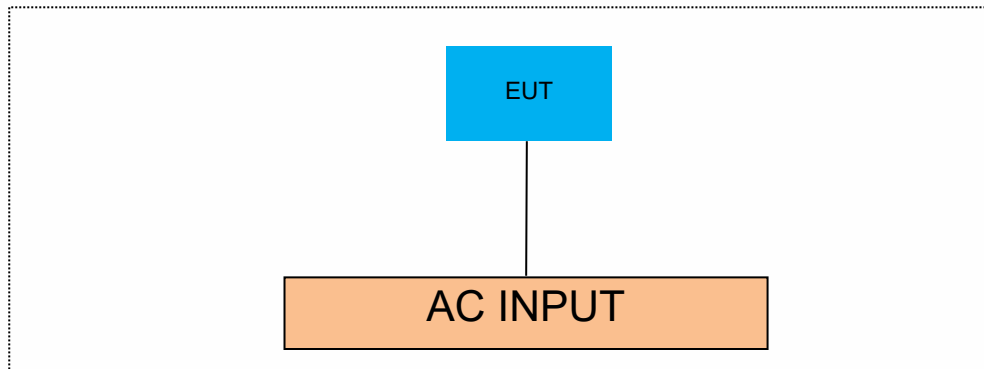

7.5 SUPPORT EQUIPMENT

EUT Cable List and Details			
Cable Description	Length (m)	Shielded/Unshielded	With / Without Ferrite
/	/	/	/

Auxiliary Cable List and Details			
Cable Description	Length (m)	Shielded/Unshielded	With / Without Ferrite
/	/	/	/

Auxiliary Equipment List and Details			
Description	Manufacturer	Model	Serial Number
/	/	/	/

Notes:

1. All the equipment/cables were placed in the worst-case configuration to maximize the emission during the test.
2. Grounding was established in accordance with the manufacturer's requirements and conditions for the intended use.

7.6 UNDESIRABLE RADIATED SPURIOUS EMISSION

7.6.1 Applicable Standard

According to FCC Part 15.407 (b), 15.209, 15.205

According to 789033 D02 SectionII(G)

According to RSS-GEN 8.9, 8.10 and 6.13

7.6.2 Conformance Limit

For transmitters operating in the 5.15-5.25 GHz band: All emissions outside of the 5.15-5.35 GHz band shall not exceed an e.i.r.p. of -27 dBm/MHz.

For transmitters operating in the 5.25-5.35 GHz band: All emissions outside of the 5.15-5.35 GHz band shall not exceed an e.i.r.p. of -27 dBm/MHz.

For transmitters operating in the 5.47-5.725 GHz band: All emissions outside of the 5.47-5.725 GHz band shall not exceed an e.i.r.p. of -27 dBm/MHz.

For transmitters operating in the 5.725-5.85 GHz band: All emissions shall be limited to a level of -27 dBm/MHz at 75 MHz or more above or below the band edge increasing linearly to 10 dBm/MHz at 25 MHz above or below the band edge, and from 25 MHz above or below the band edge increasing linearly to a level of 15.6 dBm/MHz at 5 MHz above or below the band edge, and from 5 MHz above or below the band edge increasing linearly to a level of 27 dBm/MHz at the band edge.

The emission measurements shall be performed using a minimum resolution bandwidth of 1 MHz. A lower resolution bandwidth may be employed near the band edge, when necessary, provided the measured energy is integrated to show the total power over 1 MHz.

Unwanted emissions below 1 GHz must comply with the general field strength limits set forth in §15.209

The emissions from an intentional radiator shall not exceed the field strength levels specified in the following table 15.209(a):

Restricted Frequency(MHz)	Field Strength (µV/m)	Field Strength (dBµV/m)	Measurement Distance
0.009-0.490	2400/F(KHz)	20 log (uV/m)	300
0.490-1.705	24000/F(KHz)	20 log (uV/m)	30
1.705-30	30	29.5	30
30-88	100	40	3
88-216	150	43.5	3
216-960	200	46	3
Above 960	500	54	3

The provisions of §15.205 apply to intentional radiators operating under this section, 15.205 Restricted bands of operation

MHz	MHz	MHz	GHz
0.090-0.110	16.42-16.423	399.9-410	4.5-5.15
10.495-0.505	16.69475-16.69525	608-614	5.35-5.46
2.1735-2.1905	16.80425-16.80475	960-1240	7.25-7.75
4.125-4.128	25.5-25.67	1300-1427	8.025-8.5
4.17725-4.17775	37.5-38.25	1435-1626.5	9.0-9.2
4.20725-4.20775	73-74.6	1645.5-1646.5	9.3-9.5
6.215-6.218	74.8-75.2	1660-1710	10.6-12.7
6.26775-6.26825	123-138	2200-2300	14.47-14.5
8.291-8.294	149.9-150.05	2310-2390	15.35-16.2
8.362-8.366	156.52475-156.52525	2483.5-2500	17.7-21.4
8.37625-8.38675	156.7-156.9	2690-2900	22.01-23.12
8.41425-8.41475	162.0125-167.17	3260-3267	23.6-24.0
12.29-12.293	167.72-173.2	3332-3339	31.2-31.8
12.51975-12.52025	240-285	3345.8-3358	36.43-36.5
12.57675-12.57725	322-335.4	3600-4400	(2)
13.36-13.41			

- Remark:
1. Emission level in $\text{dBuV/m} = 20 \log (\mu\text{V/m})$
 2. Measurement was performed at an antenna to the closed point of EUT distance of meters.
 3. Only spurious frequency is permitted to locate within the Restricted Bands specified in provision of 15.205, and the emissions located in restricted bands also comply with 15.209 limit.

7.6.3 Test Configuration

Test according to clause 6.2 radio frequency test setup

7.6.4 Test Procedure

■ Unwanted Emissions Measurements below 1000 MHz

Compliance shall be demonstrated using CISPR quasi-peak detection; however, peak detection is permitted as an alternative to quasi-peak detection.

The EUT was placed on a turn table which is 0.8m above ground plane.

And also, each emission was to be maximized by changing the polarization of receiving antenna both horizontal and vertical.

Repeat above procedures until all frequency measured was complete.

We use software control the EUT, Let EUT hopping on and transmit with highest power, All the modes have been tested and the worst result was reported.

Use the following spectrum analyzer settings:

Set RBW=120kHz for $f < 1 \text{ GHz}$ (30MHz to 1GHz), 200Hz for $f < 150\text{kHz}$ (9kHz to 150kHz), 9kHz for $< 30\text{MHz}$ (150kHz to 30kHz).

Set the VBW > RBW.

Detector = Peak.

Trace mode = max hold.

Follow the guidelines in ANSI C63.10-2013 with respect to maximizing the emission by rotating the EUT, measuring the emission while the EUT is situated in three orthogonal planes (if appropriate), adjusting the measurement antenna height and polarization, etc. A pre-amp and a high pass filter are required for this test, in order to provide the measuring system with sufficient sensitivity. Allow the trace to stabilize. The peak reading of the emission, after being corrected by the antenna factor, cable loss, pre-amp gain, etc., is the peak field strength, which must comply with the limit specified in Section 15.35(b). Submit this data.

Repeat above procedures until all frequency measured was complete.

■ Unwanted Maximumpeak Emissions Measurements above 1000 MHz

Maximum emission levels are measured by setting the analyzer as follows:

RBW = 1 MHz.

VBW \geq 3 MHz.

Detector = Peak.

Sweep time = auto.

Trace mode = max hold.

Allow sweeps to continue until the trace stabilizes. Note that if the transmission is not continuous, the time required for the trace to stabilize will increase by a factor of approximately $1/x$, where x is the duty cycle. For example, at 50 percent duty cycle, the measurement time will increase by a factor of two relative to measurement time for continuous transmission.

■ Unwanted Average Emissions Measurements above 1000 MHz

Method VB (Averaging using reduced video bandwidth): Alternative method.

RBW = 1 MHz.

Video bandwidth. • If the EUT is configured to transmit with duty cycle \geq 98 percent, set $\text{VBW} \leq \text{RBW}/100$ (i.e., 10 kHz) but not less than 10 Hz.

• If the EUT duty cycle is $<$ 98 percent, set $\text{VBW} \geq 1/T$, where T is defined in section II.B.1.a).

Video bandwidth mode or display mode • The instrument shall be set to ensure that video filtering is applied in the power domain. Typically, this requires setting the detector mode to RMS and setting the Average-VBW Type to Power (RMS).

• As an alternative, the analyzer may be set to linear detector mode. Ensure that video filtering is applied in linear voltage domain (rather than in a log or dB domain). Some analyzers require linear display mode in order to accomplish this. Others have a setting for Average-VBW Type, which can be set to "Voltage" regardless of the display mode.

Detector = Peak.

Sweep time = auto.

Trace mode = max hold.

Allow max hold to run for at least 50 traces if the transmitted signal is continuous or has at least 98 percent duty cycle. For lower duty cycles, increase the minimum number of traces by a factor of 1/x, where x is the duty cycle. For example, use at least 200 traces if the duty cycle is 25 percent. (If a specific emission is demonstrated to be continuous—i.e., 100 percent duty cycle—rather than turning on and off with the transmit cycle, at least 50 traces shall be averaged.)

■ Band edge measurements.

Unwanted band-edge emissions may be measured using either of the special band-edge measurement techniques (the marker-delta or integration methods) described below. Note that the marker-delta method is primarily a radiated measurement technique that requires the 99% occupied bandwidth edge to be within 2 MHz of the authorized band edge, whereas the integration method can be used in either a radiated or conducted measurement without any special requirement with regards to the displacement of the unwanted emission(s) relative to the authorized bandwidth.

Marker-Delta Method.

The marker-delta method, as described in ANSI C63.10, can be used to perform measurements of the radiated unwanted emissions level of emissions provided that the 99% occupied bandwidth of the fundamental is within 2 MHz of the authorized band-edge.

7.6.5 Test Results

Temperature:	22° C
Relative Humidity:	43%
ATM Pressure:	1011 mbar

■ Spurious Emission below 30MHz(9KHz to 30MHz)

Freq. (MHz)	Ant.Pol. H/V	Emission Level(dBuV/m)		Limit 3m(dBuV/m)		Over(dB)	
		PK	AV	PK	AV	PK	AV
--	--	--	--	--	--	--	--

Note: the amplitude of spurious emission that is attenuated by more than 20dB below the permissible limit has no need to be reported.

Distance extrapolation factor =40log(Specific distance/ test distance)(dB);

Limit line=Specific limits(dBuV) + distance extrapolation factor

■ **For Undesirable radiated Spurious Emission in U-NII - 1**

● Undesirable radiated Spurious Emission Above 1GHz(1GHz to 40GHz)

All the antenna(Antenna 1&2) and modes(802.11a/n/ac) has been tested and the worst(Antenna 1,802.11ac(VHT20)) result recorded was report as below:

Test mode: 802.11ac(VHT20) Frequency: Channel 36: 5180MHz

Freq. (MHz)	Ant.Pol.	Field Strength (dBuV/m)	E.I.R.P (dBm)	Limit (dBm)	Over(dB)
10669.33	V	46.73	-48.50	-27	-21.50
15176.58	V	43.23	-52.00	-27	-25.00
17506.75	V	44.55	-50.68	-27	-23.68
10737.36	H	46.62	-48.61	-27	-21.61
13220.61	H	42.52	-52.71	-27	-25.71
17498.24	H	44.65	-50.58	-27	-23.58

Test mode: 802.11ac(VHT20) Frequency: Channel 40: 5200MHz

Freq. (MHz)	Ant.Pol.	Field Strength (dBuV/m)	E.I.R.P (dBm)	Limit (dBm)	Over(dB)
11519.75	V	46.55	-48.68	-27	-21.68
14640.82	V	44.44	-50.79	-27	-23.79
17532.26	V	43.95	-51.28	-27	-24.28
11902.45	H	46.45	-48.78	-27	-21.78
15516.75	H	42.94	-52.29	-27	-25.29
17498.24	H	45.06	-50.17	-27	-23.17

Test mode: 802.11ac(VHT20) Frequency: Channel 48: 5240MHz

Freq. (MHz)	Ant.Pol.	Field Strength (dBuV/m)	E.I.R.P (dBm)	Limit (dBm)	Over(dB)
11706.85	V	46.05	-49.18	-27	-22.18
15593.29	V	43.37	-51.86	-27	-24.86
17515.25	V	44.57	-50.66	-27	-23.66
11468.73	H	46.35	-48.88	-27	-21.88
14581.29	H	45.03	-50.20	-27	-23.20
17506.75	H	44.87	-50.36	-27	-23.36

Note: (1) All Readings are Peak Value (VBW=3MHz) and Average Value(VBW=10Hz).
 (2) Emission Level= Reading Level+Probe Factor +Cable Loss.
 (3) EIRP[dBm] = E[dBμV/m] + 20 log(d[meters]) - 104.77
 d is the measurement distance in 3 meters

Test mode: 802.11ac(VHT20) Frequency: Channel 36: 5180MHz

Freq. (MHz)	Ant.Pol.	Emission Level(dBuV/m)		Limit 3m(dBuV/m)		Over(dB)	
	H/V	PK	AV	PK	AV	PK	AV
10669.33	V	58.54	46.73	74	54	15.46	-7.27
15176.58	V	61.31	43.23	74	54	-12.69	-10.77
17506.75	V	65.18	44.55	74	54	-8.82	-9.45
10737.36	H	58.66	46.62	74	54	-15.34	-7.38
13220.61	H	60.98	42.52	74	54	-13.02	-11.48
17498.24	H	66.35	44.65	74	54	-7.65	-9.35

Test mode: 802.11ac(VHT20) Frequency: Channel 40: 5200MHz

Freq. (MHz)	Ant.Pol.	Emission Level(dBuV/m)		Limit 3m(dBuV/m)		Over(dB)	
	H/V	PK	AV	PK	AV	PK	AV
11519.75	V	60.46	46.55	74	54	-13.54	-7.45
14640.82	V	61.30	44.44	74	54	-12.70	-9.56
17532.26	V	65.70	43.95	74	54	-8.30	-10.05
11902.45	H	58.72	46.45	74	54	-15.28	-7.55
15516.75	H	62.34	42.94	74	54	-11.66	-11.06
17498.24	H	65.21	45.06	74	54	-8.79	-8.94

Test mode: 802.11ac(VHT20) Frequency: Channel 48: 5240MHz

Freq. (MHz)	Ant.Pol.	Emission Level(dBuV/m)		Limit 3m(dBuV/m)		Over(dB)	
	H/V	PK	AV	PK	AV	PK	AV
11706.85	V	59.23	46.05	74	54	-14.77	-7.95
15593.29	V	61.47	43.37	74	54	-12.53	-10.63
17515.25	V	65.65	44.57	74	54	-8.35	-9.43
11468.73	H	58.81	46.35	74	54	-15.19	-7.65
14581.29	H	61.76	45.03	74	54	-12.24	-8.97
17506.75	H	65.33	44.87	74	54	-8.67	-9.13

- Note:**
- (1) All Readings are Peak Value (VBW=3MHz) and Average Value (VBW=10Hz).
 - (2) Emission Level= Reading Level+Correct Factor.
 - (3) Correct Factor= Ant_F + Cab_L - Preamp
 - (4) The reading of emissions are attenuated more than 20dB below the permissible limits or the field strength is too small to be measured.

●Undesirable radiated Undesirable radiatedSpurious Emission in Band Edge

All the antenna(Antenna 1&2) and modes(802.11a/n/ac) has been tested and the worst(Antenna 1,802.11ac(VHT20)) result recorded was report as below:

Test mode: 802.11ac(VHT20) Frequency: Channel 36: 5180MHz					
Freq. (MHz)	Ant.Pol.	Field Strength (RBW=100KHz) (dBuV/m)	E.I.R.P (dBm)	Limit (dBm)	Verdict
5040.15	H	49.70	-45.53	-27	Pass
5021.13	V	49.33	-45.90	-27	Pass

Test mode: 802.11ac(VHT20) Frequency: Channel 48: 5240MHz					
Freq. (MHz)	Ant.Pol.	Field Strength (RBW=100KHz) (dBuV/m)	E.I.R.P (dBm)	Limit (dBm)	Verdict
5364.83	H	50.44	-44.79	-27	Pass
5368.56	V	50.32	-44.91	-27	Pass

Note: (1) All Readings are Peak Value (VBW=3MHz) and Average Value(VBW=10Hz).
 (2) Emission Level= Reading Level+Probe Factor +Cable Loss.
 (3)EIRP[dBm] = E[dBμV/m] + 20 log(d[meters]) - 104.77
 d is the measurement distance in 3 meters

Test mode: 802.11ac(VHT20) Frequency: Channel 36: 5180MHz					
Frequency (MHz)	Polarity	PK(dBuV/m) (VBW=3MHz)	Limit 3m (dBuV/m)	AV(dBuV/m) (VBW=10Hz)	Limit 3m (dBuV/m)
5040.15	H	55.25	74	49.70	54
5021.13	V	56.18	74	49.33	54

Test mode: 802.11ac(VHT20) Frequency: Channel 48: 5240MHz					
Frequency (MHz)	Polarity	PK(dBuV/m) (VBW=3MHz)	Limit 3m (dBuV/m)	AV(dBuV/m) (VBW=10Hz)	Limit 3m (dBuV/m)
5364.83	H	54.44	74	50.44	54
5368.56	V	54.34	74	50.32	54

Note: (1) All Readings are Peak Value (VBW=3MHz) and Average Value (VBW=10Hz).
 (2) Emission Level= Reading Level+Correct Factor.
 (3) Correct Factor= Ant_F + Cab_L - Preamp
 (4) The reading of emissions are attenuated more than 20dB below the permissible limits or the field strength is too small to be measured.

U-NII - 1

Test Model	Undesirable radiated 802.11ac(VHT20)	Undesirable radiated Channel 36: 5180MHz	Spurious Emission in Band Edge	Ant.Pol	H
------------	--------------------------------------	--	--------------------------------	---------	---

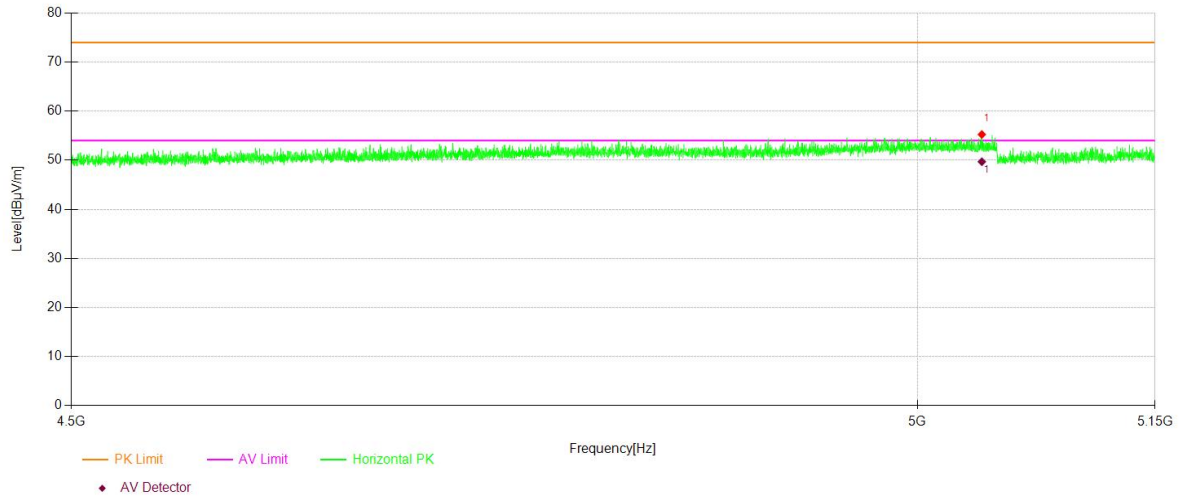

U-NII - 1

Test Model	Undesirable radiated 802.11ac(VHT20)	Undesirable radiated Channel 36: 5180MHz	Spurious Emission in Band Edge	Ant.Pol	V
------------	--------------------------------------	--	--------------------------------	---------	---

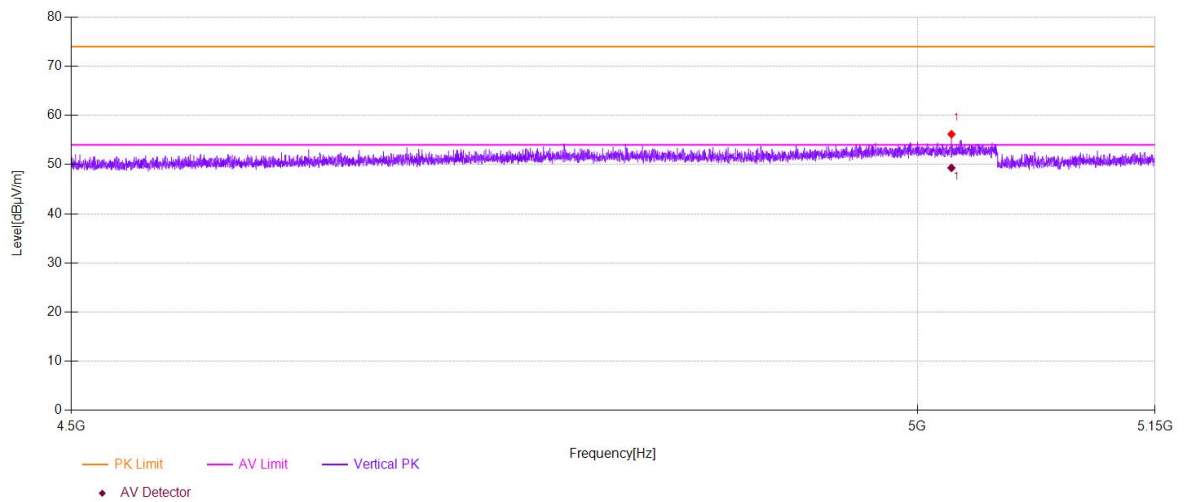

U-NII - 1

Test Model	Undesirable radiated 802.11ac(VHT20)	Undesirable radiated Channel 48: 5240MHz	Spurious Emission in Band Edge	Ant.Pol	H
------------	--------------------------------------	--	--------------------------------	---------	---

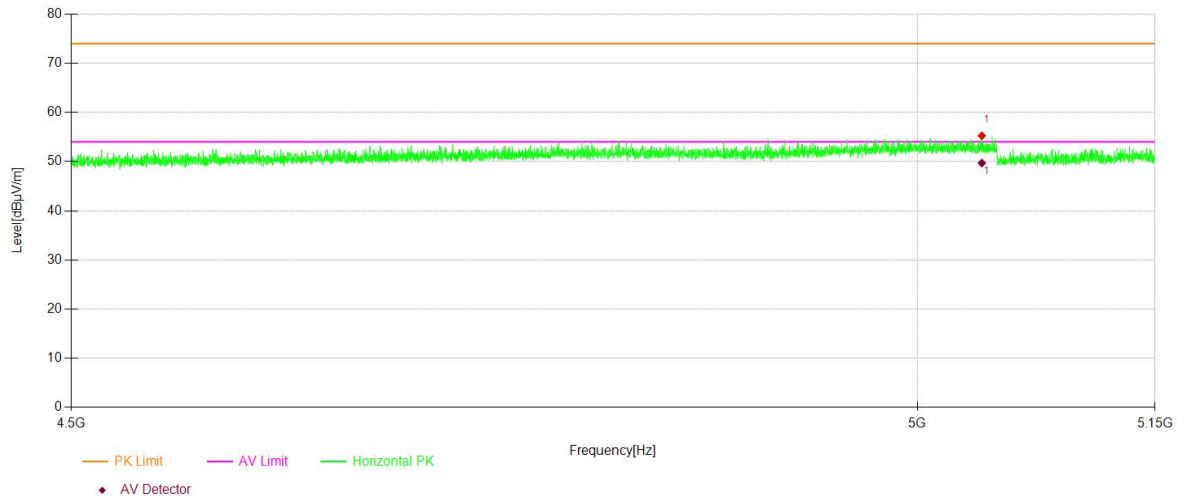

U-NII - 1

Test Model	Undesirable radiated 802.11ac(VHT20)	Undesirable radiated Channel 48: 5240MHz	Spurious Emission in Band Edge	Ant.Pol	V
------------	--------------------------------------	--	--------------------------------	---------	---

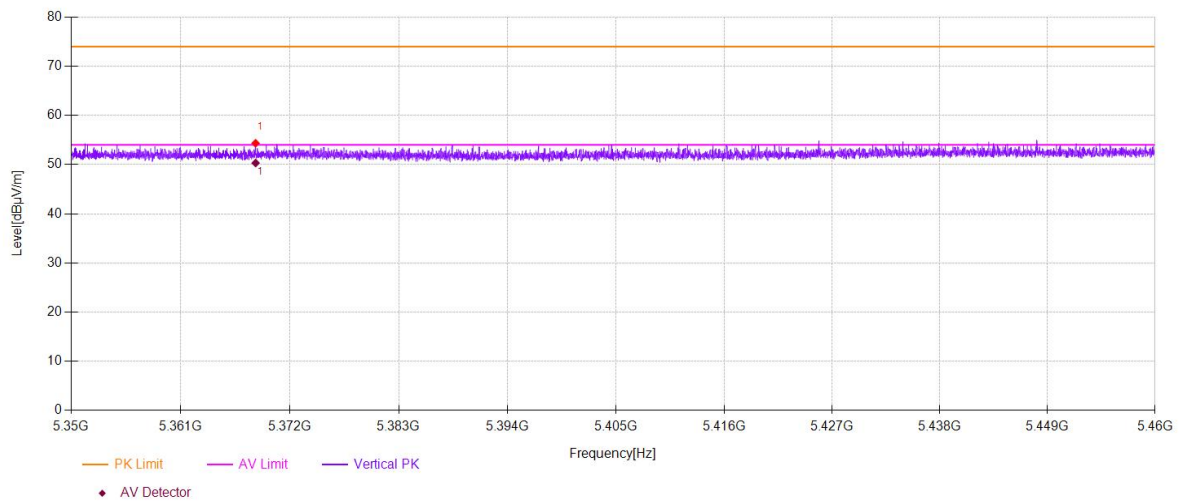

■ For Undesirable radiated Spurious Emission in U-NII -3

● Undesirable radiated Spurious Emission Above 1GHz(1GHz to 40GHz)

All the antenna(Antenna 1&2) and modes(802.11a/n/ac) has been tested and the worst(Antenna 1,802.11ac(VHT20)) result recorded was report as below:

Test mode: 802.11ac(VHT20) Frequency: Channel 149: 5745MHz

Freq. (MHz)	Ant.Pol.	Field Strength (dBuV/m)	E.I.R.P (dBm)	Limit (dBm)	Over(dB)
11553.77	V	46.37	-48.86	-27	-21.86
14581.29	V	45.32	-49.91	-27	-22.91
17498.24	V	45.10	-50.13	-27	-23.13
11502.75	H	46.64	-48.59	-27	-21.59
15457.22	H	43.06	-52.17	-27	-25.17
17498.24	H	45.10	-50.13	-27	-23.13

Test mode: 802.11ac(VHT20) Frequency: Channel 157: 5785MHz

Freq. (MHz)	Ant.Pol.	Field Strength (dBuV/m)	E.I.R.P (dBm)	Limit (dBm)	Over(dB)
10737.36	V	46.84	-48.39	-27	-21.39
14632.31	V	45.34	-49.89	-27	-22.89
17489.74	V	44.87	-50.36	-27	-23.36
11519.75	H	46.55	-48.68	-27	-21.68
15559.27	H	43.58	-51.65	-27	-24.65
17506.75	H	44.91	-50.32	-27	-23.32

Test mode: 802.11ac(VHT20) Frequency: Channel 165: 5825MHz

Freq. (MHz)	Ant.Pol.	Field Strength (dBuV/m)	E.I.R.P (dBm)	Limit (dBm)	Over(dB)
11502.75	V	46.64	-48.59	-27	-21.59
15270.13	V	42.97	-52.26	-27	-25.26
17498.24	V	45.06	-50.17	-27	-23.17
13781.89	H	48.54	-46.69	-27	-19.69
14564.28	H	45.23	-50.00	-27	-23.00
17498.24	H	45.06	-50.17	-27	-23.17

- Note:**
- (1) All Readings are Peak Value (VBW=3MHz) and Average Value(VBW=10Hz).
 - (2) Emission Level= Reading Level+Probe Factor +Cable Loss.
 - (3) EIRP[dBm] = E[dBuV/m] + 20 log(d[meters]) - 104.77
d is the measurement distance in 3 meters

Test mode: 802.11ac(VHT20) Frequency: Channel 149: 5745MHz

Freq. (MHz)	Ant.Pol.	Emission Level(dBuV/m)		Limit 3m(dBuV/m)		Over(dB)	
	H/V	PK	AV	PK	AV	PK	AV
11553.77	V	58.70	46.37	74.00	54.00	-15.30	-7.63
14581.29	V	62.02	45.32	74.00	54.00	-11.98	-8.68
17498.24	V	65.91	45.10	74.00	54.00	-8.09	-8.90
11502.75	H	59.01	46.64	74.00	54.00	-14.99	-7.36
15457.22	H	61.54	43.06	74.00	54.00	-12.46	-10.94
17498.24	H	67.36	45.10	74.00	54.00	-6.64	-8.90

Test mode: 802.11ac(VHT20) Frequency: Channel 157: 5785MHz

Freq. (MHz)	Ant.Pol.	Emission Level(dBuV/m)		Limit 3m(dBuV/m)		Over(dB)	
	H/V	PK	AV	PK	AV	PK	AV
10737.36	V	59.44	46.84	74.00	54.00	-14.56	-7.16
14632.31	V	61.57	45.34	74.00	54.00	-12.43	-8.66
17489.74	V	66.34	44.87	74.00	54.00	-7.66	-9.13
11519.75	H	59.26	46.55	74.00	54.00	-14.74	-7.45
15559.27	H	61.42	43.58	74.00	54.00	-12.58	-10.42
17506.75	H	65.43	44.91	74.00	54.00	-8.57	-9.09

Test mode:: 802.11ac(VHT20) Frequency: Channel 165: 5825MHz

Freq. (MHz)	Ant.Pol.	Emission Level(dBuV/m)		Limit 3m(dBuV/m)		Over(dB)	
	H/V	PK	AV	PK	AV	PK	AV
11502.75	V	59.42	46.64	74.00	54.00	-14.58	-7.36
15270.13	V	62.37	42.97	74.00	54.00	-11.63	-11.03
17498.24	V	66.15	45.06	74.00	54.00	-7.85	-8.94
13781.89	H	60.76	48.54	74.00	54.00	-13.24	-5.46
14564.28	H	61.63	45.23	74.00	54.00	-12.37	-8.77
17498.24	H	65.63	45.06	74.00	54.00	-8.37	-8.94

- Note:**
- (1) All Readings are Peak Value (VBW=3MHz) and Average Value (VBW=10Hz).
 - (2) Emission Level= Reading Level+Correct Factor.
 - (3) Correct Factor= Ant_F + Cab_L - Preamp
 - (4) The reading of emissions are attenuated more than 20dB below the permissible limits or the field strength is too small to be measured.

●Undesirable radiated Undesirable radiatedSpurious Emission in Band Edge

All the antenna(Antenna 1&2) and modes(802.11a/n/ac) has been tested and the worst(Antenna 1,802.11ac(VHT20)) result recorded was report as below:

Test mode: 802.11ac(VHT20) Frequency: Channel 149: 5745MHz

Freq. (MHz)	Ant.Pol.	Field Strength (RBW=100KHz) (dBuV/m)	E.I.R.P (dBm)	Limit (dBm)	Verdict
5622.01	H	54.86	-40.37	-27	Pass
5623.26	V	54.45	-40.78	-27	Pass

Test mode: 802.11ac(VHT20) Frequency: Channel 165: 5825MHz

Freq. (MHz)	Ant.Pol.	Field Strength (RBW=100KHz) (dBuV/m)	E.I.R.P (dBm)	Limit (dBm)	Verdict
5874.88	H	54.95	-40.28	10.03	Pass
5872.32	V	55.19	-40.04	10.75	Pass

- Note:**
- (1) All Readings are Peak Value (VBW=3MHz) and Average Value(VBW=10Hz).
 - (2) Emission Level= Reading Level+Probe Factor +Cable Loss.
 - (3)EIRP[dBm] = E[dBμV/m] + 20 log(d[meters]) - 104.77
d is the measurement distance in 3 meters

U-NII-3				
Test Model	Undesirable radiated	Undesirable radiated	Spurious Emission in Band Edge	
	802.11ac(VHT20)	Channel 149: 5745MHz	Ant.Pol	H

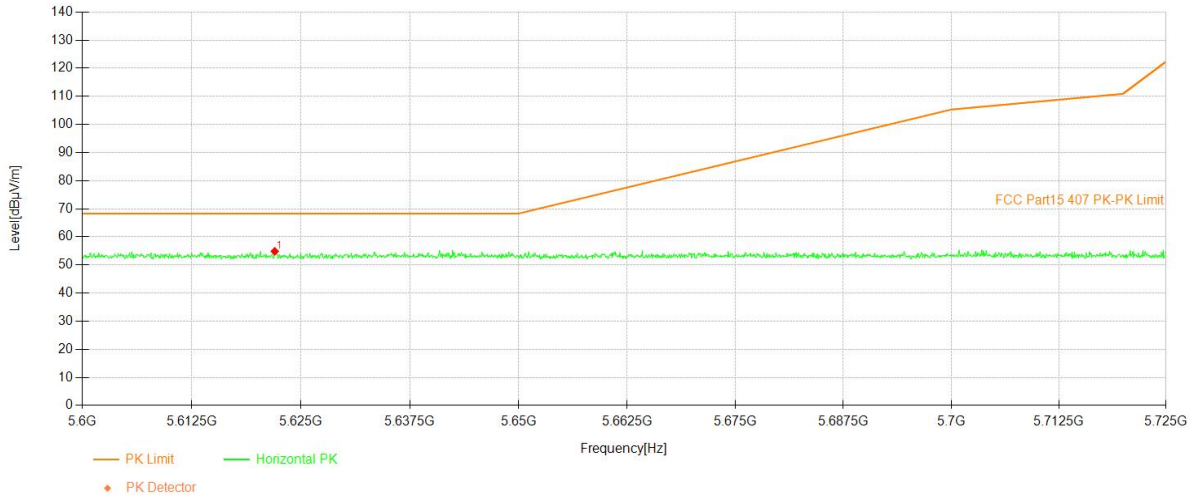

U-NII-3				
Test Model	Undesirable radiated	Undesirable radiated	Spurious Emission in Band Edge	
	802.11ac(VHT20)	Channel 149: 5745MHz	Ant.Pol	V

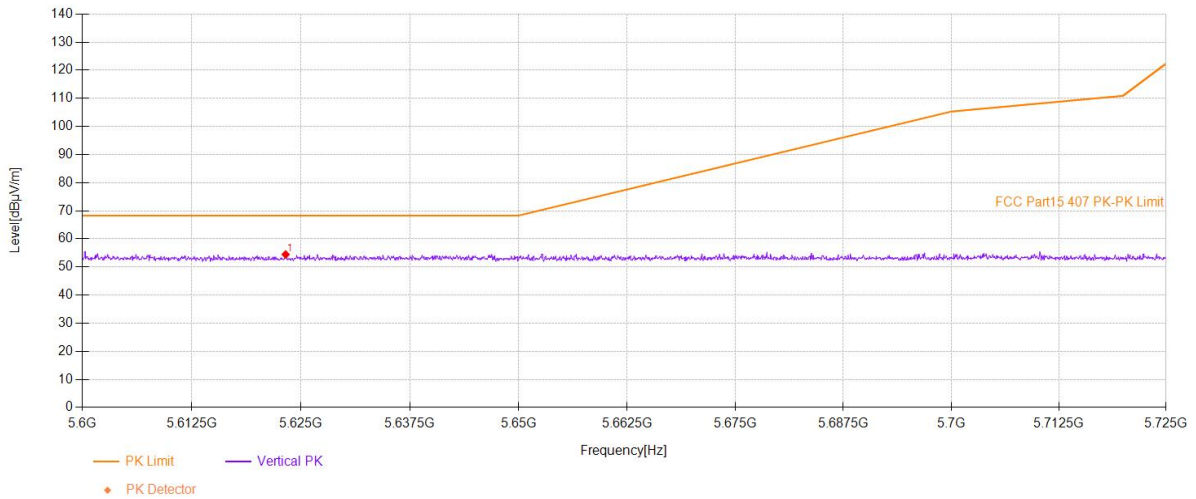

U-NII-3

Test Model	Undesirable radiated 802.11ac(VHT20)	Undesirable radiated Channel 165: 5825MHz	Spurious Emission in Band Edge	Ant.Pol	H
------------	--------------------------------------	---	--------------------------------	---------	---

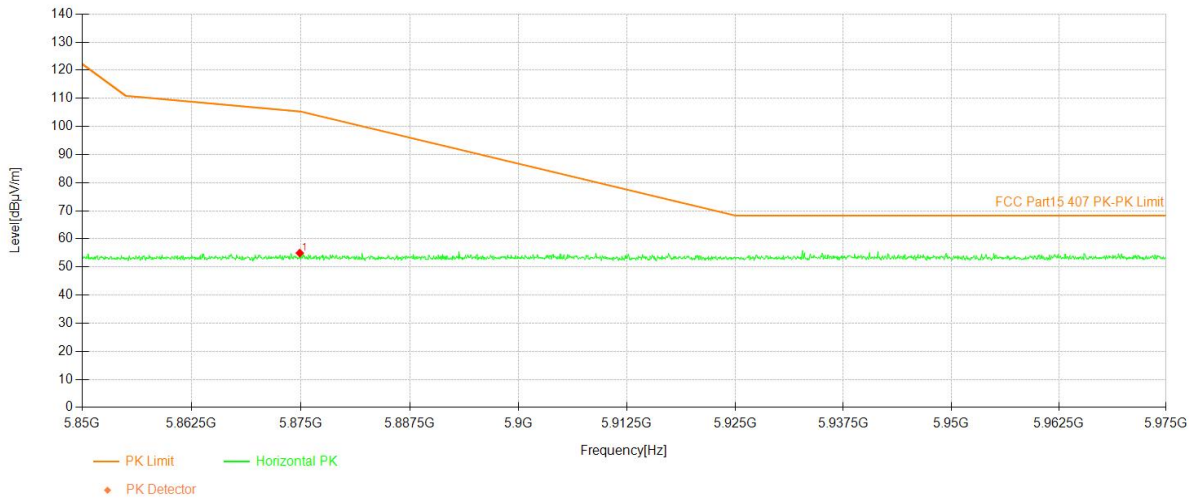

U-NII-3

Test Model	Undesirable radiated 802.11ac(VHT20)	Undesirable radiated Channel 165: 5825MHz	Spurious Emission in Band Edge	Ant.Pol	V
------------	--------------------------------------	---	--------------------------------	---------	---

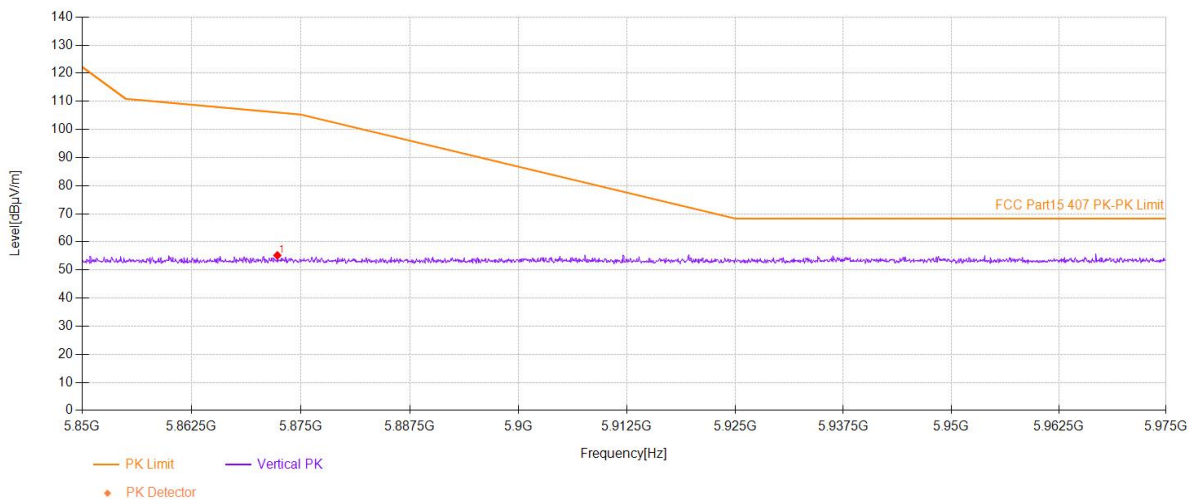

- Undesirable radiated Spurious Emission below 1GHz (30MHz to 1GHz)
 All the antenna(Antenna 1&2) and modes(802.11a/n/ac) has been tested and the worst(Antenna 1,802.11ac(VHT20)) result recorded was report as below:

Mode:	11AC20 5180
-------	-------------

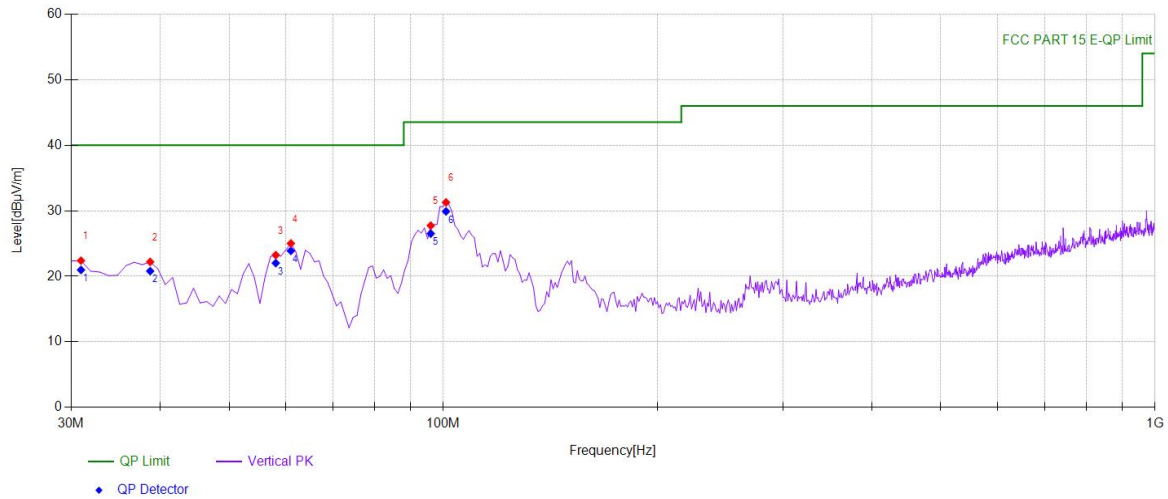

Suspected Data List								
NO.	Freq. [MHz]	Reading [dBµV]	Factor [dB/m]	Level [dBµV/m]	Detector	Limit [dBµV/m]	Margin [dB]	Polarity
1	30.971	40.86	-18.47	22.39	PK	40.00	17.61	Vertical
2	38.7387	40.20	-17.99	22.21	PK	40.00	17.79	Vertical
3	58.1582	41.54	-18.30	23.24	PK	40.00	16.76	Vertical
4	61.0711	43.72	-18.70	25.02	PK	40.00	14.98	Vertical
5	96.026	45.47	-17.73	27.74	PK	43.50	15.76	Vertical
6	100.8809	48.12	-16.84	31.28	PK	43.50	12.22	Vertical

Mode:	11AC20 5180
-------	-------------

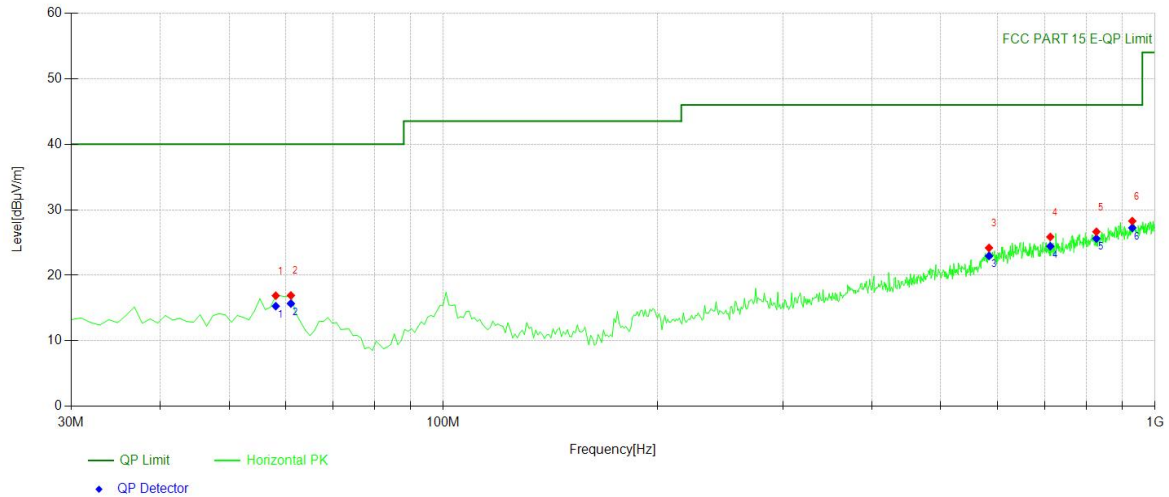

Suspected Data List								
NO.	Freq. [MHz]	Reading [dBµV]	Factor [dB/m]	Level [dBµV/m]	Detector	Limit [dBµV/m]	Margin [dB]	Polarity
1	58.1582	35.20	-18.30	16.90	PK	40.00	23.10	Horizontal
2	61.0711	35.63	-18.70	16.93	PK	40.00	23.07	Horizontal
3	584.4244	31.33	-7.14	24.19	PK	46.00	21.81	Horizontal
4	712.5926	31.69	-5.83	25.86	PK	46.00	20.14	Horizontal
5	827.1672	30.82	-4.17	26.65	PK	46.00	19.35	Horizontal
6	929.1191	30.92	-2.64	28.28	PK	46.00	17.72	Horizontal

Mode: 11AC20 5200

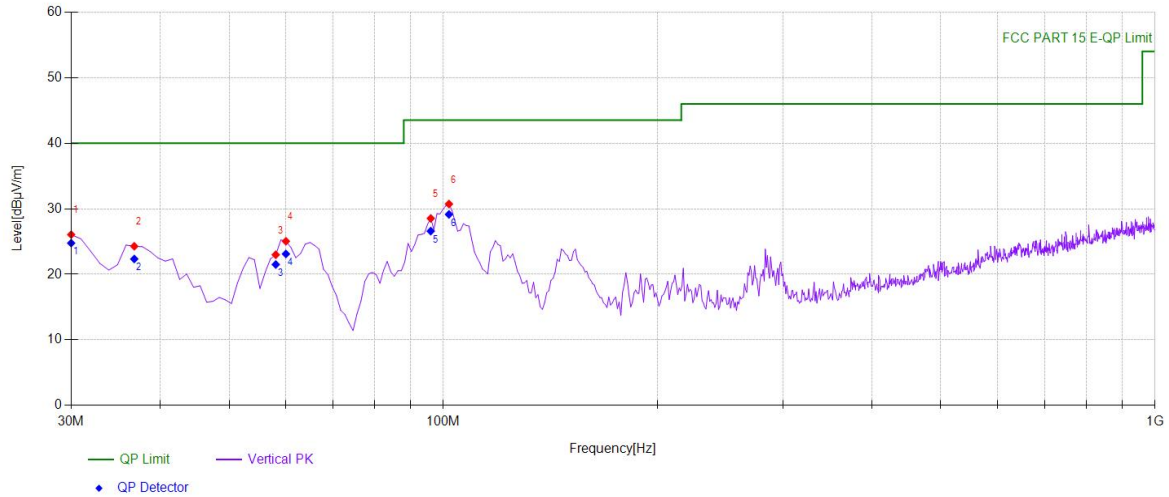

Suspected Data List								
NO.	Freq. [MHz]	Reading [dBµV]	Factor [dB/m]	Level [dBµV/m]	Detector	Limit [dBµV/m]	Margin [dB]	Polarity
1	30	44.59	-18.53	26.06	PK	40.00	13.94	Vertical
2	36.7968	42.39	-18.11	24.28	PK	40.00	15.72	Vertical
3	58.1582	41.29	-18.30	22.99	PK	40.00	17.01	Vertical
4	60.1001	43.61	-18.56	25.05	PK	40.00	14.95	Vertical
5	96.026	46.26	-17.73	28.53	PK	43.50	14.97	Vertical
6	101.8519	47.62	-16.90	30.72	PK	43.50	12.78	Vertical

Mode:	11AC20 5200
-------	-------------

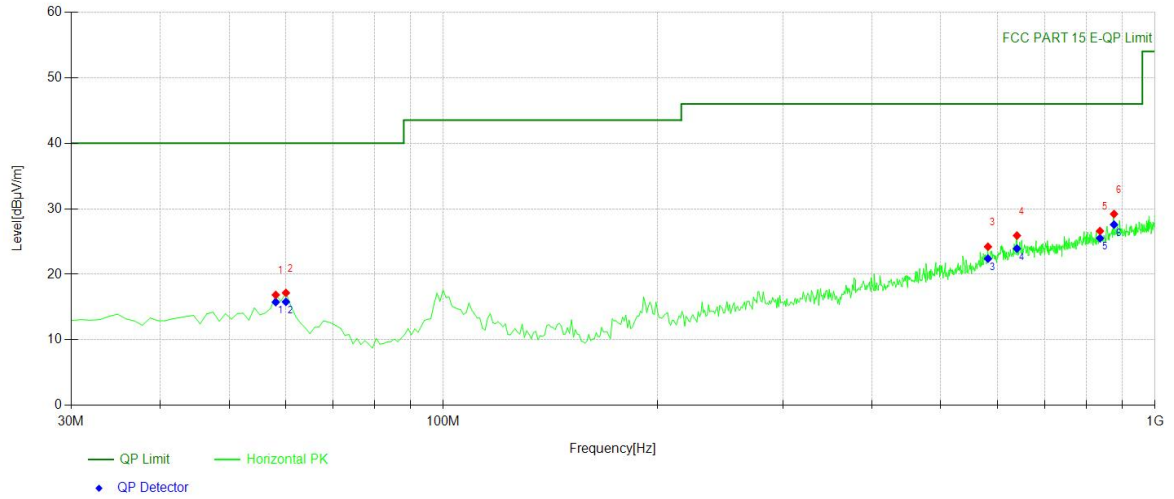

Suspected Data List								
NO.	Freq. [MHz]	Reading [dBµV]	Factor [dB/m]	Level [dBµV/m]	Detector	Limit [dBµV/m]	Margin [dB]	Polarity
1	58.1582	35.16	-18.30	16.86	PK	40.00	23.14	Horizontal
2	60.1001	35.73	-18.56	17.17	PK	40.00	22.83	Horizontal
3	582.4825	31.35	-7.14	24.21	PK	46.00	21.79	Horizontal
4	639.7698	32.17	-6.26	25.91	PK	46.00	20.09	Horizontal
5	836.8769	30.54	-3.94	26.60	PK	46.00	19.40	Horizontal
6	875.7157	32.39	-3.19	29.20	PK	46.00	16.80	Horizontal

Mode:	11AC20 5240
-------	-------------

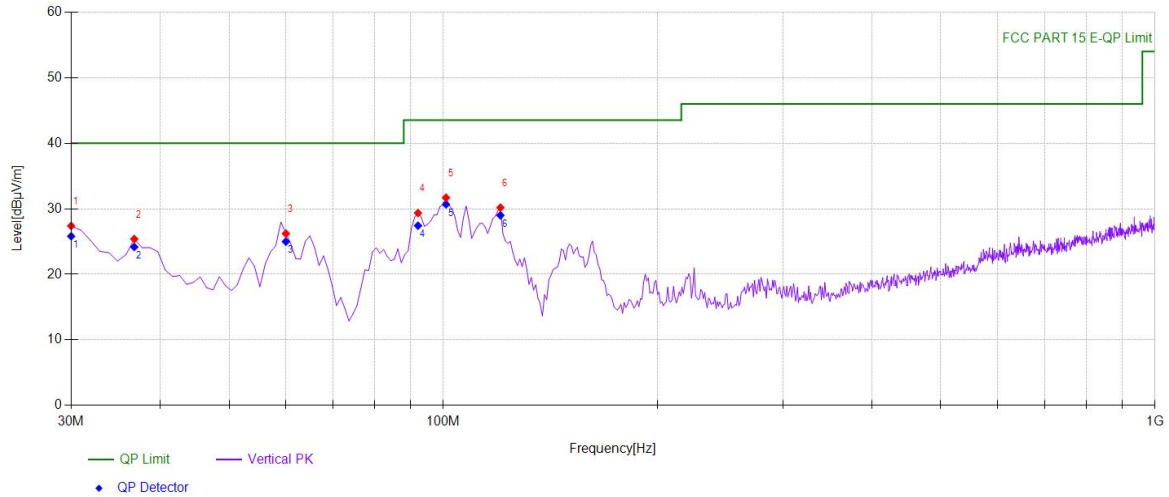

Suspected Data List								
NO.	Freq. [MHz]	Reading [dBµV]	Factor [dB/m]	Level [dBµV/m]	Detector	Limit [dBµV/m]	Margin [dB]	Polarity
1	30	45.91	-18.53	27.38	PK	40.00	12.62	Vertical
2	36.7968	43.50	-18.11	25.39	PK	40.00	14.61	Vertical
3	60.1001	44.77	-18.56	26.21	PK	40.00	13.79	Vertical
4	92.1421	48.01	-18.66	29.35	PK	43.50	14.15	Vertical
5	100.8809	48.53	-16.84	31.69	PK	43.50	11.81	Vertical
6	120.3003	48.13	-17.95	30.18	PK	43.50	13.32	Vertical

Mode:	11AC20 5240
-------	-------------

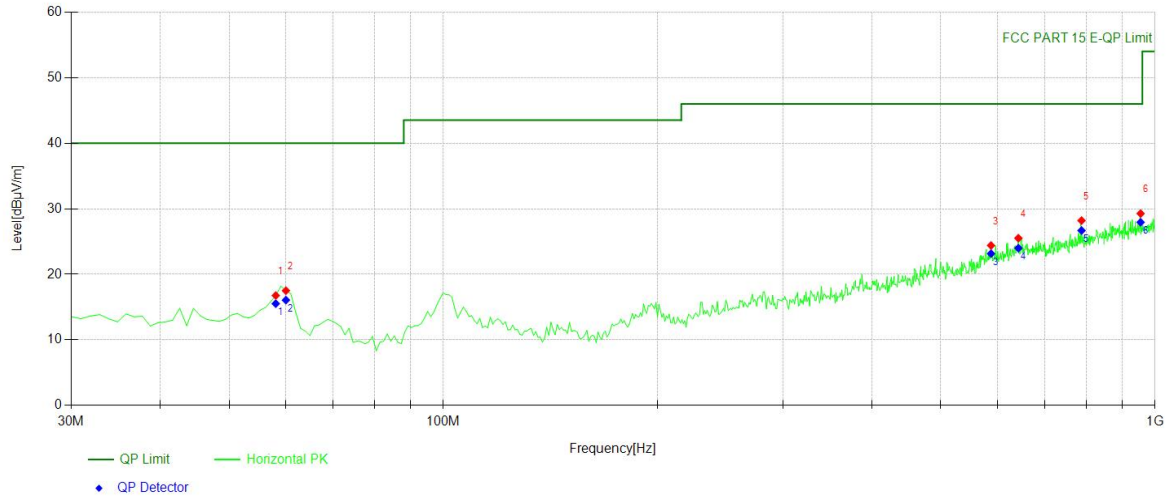

Suspected Data List								
NO.	Freq. [MHz]	Reading [dBµV]	Factor [dB/m]	Level [dBµV/m]	Detector	Limit [dBµV/m]	Margin [dB]	Polarity
1	58.1582	35.07	-18.30	16.77	PK	40.00	23.23	Horizontal
2	60.1001	36.07	-18.56	17.51	PK	40.00	22.49	Horizontal
3	588.3083	31.54	-7.14	24.40	PK	46.00	21.60	Horizontal
4	642.6827	31.75	-6.24	25.51	PK	46.00	20.49	Horizontal
5	788.3283	32.74	-4.54	28.20	PK	46.00	17.80	Horizontal
6	954.3644	31.58	-2.31	29.27	PK	46.00	16.73	Horizontal

----- END OF REPORT -----