



**CFR 47 FCC PART 15 SUBPART E
CERTIFICATION TEST REPORT**

For

Tablet

MODEL NUMBER: VT-TABLET-5081G

FCC ID: 2AAGE5081GB48

REPORT NUMBER: 4789823272-4

ISSUE DATE: March 15, 2021

Prepared for

**Chengdu Vantron Technology Co., Ltd.
No.5 GaoPeng Road, Hi-Tech Zone, Chengdu, SiChuan, P.R. China**

Prepared by

UL Verification Services (Guangzhou) Co., Ltd, Song Shan Lake Branch

Building 10, Innovation Technology Park, No. 1, Li Bin Road, Song Shan Lake Hi-Tech Development Zone Dongguan, 523808, People's Republic of China

Tel: +86 769 22038881

Fax: +86 769 33244054

Website: www.ul.com



Revision History

<u>Rev.</u>	<u>Issue Date</u>	<u>Revisions</u>	<u>Revised By</u>
V0	03/15/2021	Initial Issue	



Summary of Test Results			
Clause	Test Items	FCC Rules	Test Results
1	6dB/26dB Bandwidth	FCC 15.407 (a)&(e)	PASS
2	99% Occupied Bandwidth	RSS-Gen Clause 6.7	PASS
3	Conducted Output Power	FCC 15.407 (a)	PASS
4	Power Spectral Density	FCC 15.407 (a)	PASS
5	Radiated Bandedge and Spurious Emission	FCC 15.407 (b) FCC 15.209 FCC 15.205	PASS
6	Conducted Emission Test for AC Power Port	FCC 15.207	PASS
7	Frequency Stability	FCC 15.407 (g)	PASS
8	Antenna Requirement	FCC 15.203	PASS

Note:
1. This test report is only published to and used by the applicant, and it is not for evidence purpose in China.
2. The measurement result for the sample received is <Pass> according to < CFR 47 FCC PART 15 SUBPART C >when <Accuracy Method> decision rule is applied.

TABLE OF CONTENTS

1. ATTESTATION OF TEST RESULTS	7
2. TEST METHODOLOGY	8
3. FACILITIES AND ACCREDITATION	8
4. CALIBRATION AND UNCERTAINTY	9
4.1. <i>MEASURING INSTRUMENT CALIBRATION</i>	9
4.2. <i>MEASUREMENT UNCERTAINTY</i>	9
5. EQUIPMENT UNDER TEST	10
5.1. <i>DESCRIPTION OF EUT</i>	10
5.2. <i>MAXIMUM OUTPUT POWER</i>	11
5.3. <i>CHANNEL LIST</i>	11
<i>TEST CHANNEL CONFIGURATION</i>	12
5.4. <i>DESCRIPTION OF AVAILABLE ANTENNAS</i>	13
5.5. <i>THE WORSE CASE POWER SETTING PARAMETER</i>	14
5.6. <i>THE WORSE CASE CONFIGURATIONS</i>	15
5.7. <i>DESCRIPTION OF TEST SETUP</i>	16
6. MEASURING INSTRUMENT AND SOFTWARE USED	17
7. ANTENNA PORT TEST RESULTS	19
7.1. <i>ON TIME AND DUTY CYCLE</i>	19
7.2. <i>6/26 dB EMISSION BANDWIDTH AND 99 % OCCUPIED BANDWIDTH</i>	20
7.3. <i>CONDUCTED OUTPUT POWER</i>	22
7.4. <i>POWER SPECTRAL DENSITY</i>	25
8. RADIATED TEST RESULTS	27
8.1. <i>RESTRICTED BANDEDGE</i>	33
8.1.1. 802.11a SISO MODE	33
UNII-1 BAND	33
UNII-3 BAND	35
8.1.2. 802.11n HT20 MIMO MODE	37
UNII-1 BAND	37
UNII-3 BAND	39
8.1.3. 802.11n HT40 MIMO MODE	41
UNII-1 BAND	41
UNII-3 BAND	43
8.1.4. 802.11ac VHT80 MIMO MODE	45
UNII-1 BAND	45
UNII-3 BAND	47



8.2.	SPURIOUS EMISSIONS (1 GHz ~ 7 GHz)	48
8.2.1.	802.11a SISO MODE	48
	UNII-1 BAND	48
	UNII-3 BAND	54
8.3.	SPURIOUS EMISSIONS (7 GHz ~ 18 GHz)	60
8.3.1.	802.11a SISO MODE	60
	UNII-1 BAND	60
	UNII-3 BAND	66
8.3.2.	802.11n HT20 MIMO MODE	72
	UNII-1 BAND	72
	UNII-3 BAND	78
8.3.3.	802.11n HT40 MIMO MODE	84
	UNII-1 BAND	84
	UNII-3 BAND	88
8.3.4.	802.11ac VHT80 MIMO MODE	92
	UNII-1 BAND	92
	UNII-3 BAND	94
8.4.	SPURIOUS EMISSIONS (18 GHz ~ 26 GHz)	96
8.4.1.	802.11n HT40 MIMO MODE	96
8.5.	SPURIOUS EMISSIONS (26 GHz ~ 40 GHz)	98
8.5.1.	802.11n HT40 MIMO MODE	98
8.6.	SPURIOUS EMISSIONS (30 MHz ~ 1 GHz)	100
8.6.1.	802.11n HT40 MIMO MODE	100
8.7.	SPURIOUS EMISSIONS BELOW 30 MHz	102
8.7.1.	802.11n HT40 MIMO MODE	102
9.	AC POWER LINE CONDUCTED EMISSIONS	105
9.1.	802.11n HT40 MIMO MODE	106
10.	FREQUENCY STABILITY	108
11.	ANTENNA REQUIREMENTS	110
12.	Appendix	111
12.1.	Appendix A1: Emission Bandwidth	111
12.1.1.	Test Result	111
12.1.2.	Test Graphs	113
12.2.	Appendix A2: Occupied channel bandwidth	132
12.2.1.	Test Result	132
12.2.2.	Test Graphs	134
12.3.	Appendix A3: Min emission bandwidth	153
12.3.1.	Test Result	153
12.3.2.	Test Graphs	154
12.4.	Appendix B: Maximum AVG conducted output power	164
12.4.1.	Test Result	164
12.5.	Appendix C: Maximum power spectral density	166
12.5.1.	Test Result	166



12.5.2.	Test Graphs	168
12.6.	<i>Appendix G: Frequency Stability</i>	187
12.6.1.	Test Result.....	187
12.7.	<i>Appendix H: Duty Cycle</i>	188
12.7.1.	Test Result.....	188
12.7.2.	Test Graphs	189



1. ATTESTATION OF TEST RESULTS

Applicant Information

Company Name: Chengdu Vantron Technology Co., Ltd.
Address: No.5 GaoPeng Road, Hi-Tech Zone, Chengdu, SiChuan, P.R. China

Manufacturer Information

Company Name: Chengdu Vantron Technology Co., Ltd.
Address: No.5 GaoPeng Road, Hi-Tech Zone, Chengdu, SiChuan, P.R. China

EUT Information

EUT Name: Tablet
Model: VT-TABLET-5081G
Brand: VANTRON
Sample Received Date: January 20, 2021
Sample Status: Normal
Sample ID: /
Date of Tested: January 20, 2021~ March 05,2021

APPLICABLE STANDARDS	
STANDARD	TEST RESULTS
CFR 47 FCC PART 15 SUBPART E	PASS

Prepared By:

Jacky Jiang
Engineer Project Associate

Checked By:

Shawn Wen
Laboratory Leader

Approved By:

Stephen Guo
Laboratory Manager



2. TEST METHODOLOGY

The tests documented in this report were performed in accordance with ANSI C63.10-2013, CFR 47 FCC Part 2, CFR 47 FCC Part 15, KDB 789033 D02 v02r01, KDB414788 D01 Radiated Test Site v01r01.

3. FACILITIES AND ACCREDITATION

Accreditation Certificate	<p>A2LA (Certificate No.: 4102.01) UL Verification Services (Guangzhou) Co., Ltd. Song Shan Lake Branch. has been assessed and proved to be in compliance with A2LA.</p> <p>FCC (FCC Designation No.: CN1187) UL Verification Services (Guangzhou) Co., Ltd. Song Shan Lake Branch. Has been recognized to perform compliance testing on equipment subject to the Commission's Declaration of Conformity (DoC) and Certification rules</p> <p>ISED (Company No.: 21320) UL Verification Services (Guangzhou) Co., Ltd. Song Shan Lake Branch. has been registered and fully described in a report filed with ISED. The Company Number is 21320.</p> <p>VCCI (Registration No.: G-20019, R-20004, C-20012 and T-20011) UL Verification Services (Guangzhou) Co., Ltd. Song Shan Lake Branch. has been assessed and proved to be in compliance with VCCI, the Membership No. is 3793. Facility Name: Chamber D, the VCCI registration No. is G-20019 and R-20004 Shielding Room B, the VCCI registration No. is C-20012 and T-20011</p>
---------------------------	---

Note 1: All tests measurement facilities use to collect the measurement data are located at Building 10, Innovation Technology Park, Song Shan Lake Hi tech Development Zone, Dongguan, 523808, China

Note 2: The test anechoic chamber in UL Verification Services (Guangzhou) Co., Ltd. Song Shan Lake Branch had been calibrated and compared to the open field sites and the test anechoic chamber is shown to be equivalent to or worst case from the open field site.

Note 3: For below 30 MHz, lab had performed measurements at test anechoic chamber and comparing to measurements obtained on an open field site. And these measurements below 30 MHz had been correlated to measurements performed on an OFS.

4. CALIBRATION AND UNCERTAINTY

4.1. MEASURING INSTRUMENT CALIBRATION

The measuring equipment utilized to perform the tests documented in this report has been calibrated in accordance with the manufacturer's recommendations and is traceable to recognize national standards.

4.2. MEASUREMENT UNCERTAINTY

Where relevant, the following measurement uncertainty levels have been estimated for tests performed on the apparatus:

Test Item	Uncertainty
Conduction emission	3.62 dB
Radiated Emission (Included Fundamental Emission) (9 kHz ~ 30 MHz)	2.2 dB
Radiated Emission (Included Fundamental Emission) (30 MHz ~ 1 GHz)	4.00 dB
Radiated Emission (Included Fundamental Emission) (1 GHz to 26 GHz)	5.78 dB (1 GHz ~ 18 GHz)
	5.23 dB (18 GHz ~ 26 GHz)
Note: This uncertainty represents an expanded uncertainty expressed at approximately the 95 % confidence level using a coverage factor of k=2.	



5. EQUIPMENT UNDER TEST

5.1. DESCRIPTION OF EUT

EUT Name	Tablet	
Model	VT-TABLET-5081G	
Radio Technology	WLAN (IEEE 802.11a20/n HT20/n HT40/ac VHT20/VHT 40/VHT 80)	
Operation frequency	UNII-1: 5150 ~ 5250 MHz UNII-3: 5725 ~ 5850 MHz	
Modulation	IEEE 802.11a20: OFDM (64QAM, 16QAM, QPSK, BPSK) IEEE 802.11n HT20: OFDM (64QAM, 16QAM, QPSK, BPSK) IEEE 802.11n HT40: OFDM (64QAM, 16QAM, QPSK, BPSK) IEEE 802.11ac VHT20: OFDM (256QAM, 64QAM, 16QAM, QPSK, BPSK) IEEE 802.11ac VHT40: OFDM (256QAM, 64QAM, 16QAM, QPSK, BPSK) IEEE 802.11ac VHT80: OFDM (256QAM, 64QAM, 16QAM, QPSK, BPSK)	
Power Supply	Li-ion Battery	3.8 V, 8000 mAh, 30.4Wh

5.2. MAXIMUM OUTPUT POWER

UNII-1 BAND

IEEE Std. 802.11	Frequency (MHz)	Maximum Average Conducted Power (dBm)	Max Average EIRP (dBm)
a 20	5150 ~ 5250	11.45	13.85
n HT20		11.60	16.52
n HT40		8.68	13.60
ac VHT20		11.09	16.01
ac VHT40		11.84	16.76
ac VHT80		10.81	15.73

UNII-3 BAND

IEEE Std. 802.11	Frequency (MHz)	Max Power (dBm)
a 20	5725 ~ 5850	9.83
n HT20		10.63
n HT40		12.09
ac VHT20		11.31
ac VHT40		12.19
ac VHT80		11.27

5.3. CHANNEL LIST

UNII-1 (For Bandwidth = 20 MHz)		UNII-1 (For Bandwidth = 40 MHz)		UNII-1 (For Bandwidth = 80 MHz)	
Channel	Frequency (MHz)	Channel	Frequency (MHz)	Channel	Frequency (MHz)
36	5180	38	5190	42	5210
40	5200	46	5230		
44	5220				
48	5240				

UNII-3 (For Bandwidth = 20 MHz)		UNII-3 (For Bandwidth = 40 MHz)		UNII-3 (For Bandwidth = 80 MHz)	
Channel	Frequency (MHz)	Channel	Frequency (MHz)	Channel	Frequency (MHz)
149	5745	151	5755	155	5775
153	5765	159	5795		
157	5785				
161	5805				
165	5825				

**TEST CHANNEL CONFIGURATION**

UNII-1 Test Channel Configuration		
IEEE Std.	Test Channel Number	Frequency
802.11a	CH 36(Low Channel), CH 40(MID Channel), CH 48(High Channel)	5180 MHz, 5200 MHz, 5240 MHz
802.11n HT20	CH 36(Low Channel), CH 40(MID Channel), CH 48(High Channel)	5180 MHz, 5200 MHz, 5240 MHz
802.11n HT40	CH 38(Low Channel), CH 46(High Channel)	5190 MHz, 5230 MHz
802.11ac VHT20	CH 36(Low Channel), CH 40(MID Channel), CH 48(High Channel)	5180 MHz, 5200 MHz, 5240 MHz
802.11ac VHT40	CH 38(Low Channel), CH 46(High Channel)	5190 MHz, 5230 MHz
802.11ac VHT80	CH 42(Low Channel)	5210 MHz

UNII-3 Test Channel Configuration		
IEEE Std.	Test Channel Number	Frequency
802.11a	CH 149(Low Channel), CH 157(MID Channel), CH 165(High Channel)	5745 MHz, 5785 MHz, 5825 MHz
802.11n HT20	CH 149(Low Channel), CH 157(MID Channel), CH 165(High Channel)	5745 MHz, 5785 MHz, 5825 MHz
802.11n HT40	CH 151(Low Channel), CH 159(High Channel)	5755MHz, 5795MHz
802.11ac VHT20	CH 149(Low Channel), CH 157(MID Channel), CH 165(High Channel)	5745 MHz, 5785 MHz, 5825 MHz
802.11ac VHT40	CH 151(Low Channel), CH 159(High Channel)	5755 MHz, 5795 MHz
802.11ac VHT80	CH 155(Low Channel)	5775 MHz

5.4. DESCRIPTION OF AVAILABLE ANTENNAS

Antenna No.	Frequency Band	Antenna Type	Max Antenna Gain (dBi)
1	UNII1& UNII3	Internal PIFA antenna	1.4
2	UNII1& UNII3	Internal PIFA antenna	2.4

Note: Directional gain= $10 \log[(10^{G1/20} + 10^{G2/20})^2 / N_{ANT}]$ dBi=4.92 dBi.

N_{ANT} : Antenna numbers

Note: The value of the antenna gain was declared by customer.

IEE Std. 802.11	Transmit and Receive Mode	Description
802.11a	<input checked="" type="checkbox"/> 2TX, 2RX	ANT 1 or ANT 2 can be used as transmitting/receiving antenna.
802.11n HT20	<input checked="" type="checkbox"/> 2TX, 2RX	ANT 1 and ANT 2 can be used as transmitting/receiving antenna.
802.11n HT40	<input checked="" type="checkbox"/> 2TX, 2RX	ANT 1 and ANT 2 can be used as transmitting/receiving antenna.
802.11ac VHT20	<input checked="" type="checkbox"/> 2TX, 2RX	ANT 1 and ANT 2 can be used as transmitting/receiving antenna.
802.11ac VHT40	<input checked="" type="checkbox"/> 2TX, 2RX	ANT 1 and ANT 2 can be used as transmitting/receiving antenna.
802.11ac VHT80	<input checked="" type="checkbox"/> 2TX, 2RX	ANT 1 and ANT 2 can be used as transmitting/receiving antenna.
Note:		
2. BT&WLAN 2.4G & WLAN 5G can't transmit simultaneously. (declared by client)		

Note : The value of the antenna gain was declared by customer.

5.5. THE WORSE CASE POWER SETTING PARAMETER

The Worst Case Power Setting Parameter	
Test Software	RFTestTool

UNII-1

Mode	Rate	Channel	Soft set value
			ANT1
11a	6M	36	default
		40	default
		48	default
11n HT20	MCS0	36	default
		40	default
		48	default
11n HT40	MCS0	38	default
		46	default
11ac VHT20	MCS0	36	default
		40	default
		48	default
11ac VHT40	MCS0	38	default
		46	default
11ac VHT80	MCS0	42	default

UNII-3

Mode	Rate	Channel	Soft set value
			ANT1
11a	6M	149	default
		157	default
		165	default
11n HT20	MCS0	149	default
		157	default
		165	default
11n HT20	MCS0	151	default
		159	default
11ac VHT20	MCS0	149	default
		157	default
		165	default
11ac VHT40	MCS0	151	default
		159	default
11ac VHT80	MCS0	155	default

5.6. THE WORSE CASE CONFIGURATIONS

The EUT was tested in the following configuration(s):

Controlled in test mode using a software application on the EUT supplied by customer. The application was used to enable a continuous transmission and to select the mode, test channels, bandwidth, data rates as required.

Test channels referring to section 5.4.

Maximum power setting referring to section 5.6.

Worst case Data Rates declared by the customer:

- IEEE 802.11a / SISO – BPSK / 6 Mbps
- IEEE 802.11n HT20 / SISO – BPSK / MCS0
- IEEE 802.11n HT40 / SISO – BPSK / MCS0
- IEEE 802.11ac VHT20 / SISO – BPSK / MCS0
- IEEE 802.11ac VHT40 / SISO – BPSK / MCS0
- IEEE 802.11ac VHT80 / SISO – BPSK / MCS0

For Radiated test of 802.11a the antenna with higher output power was selected to be test.

Since 802.11ac VHT20/VHT40 mode are different from 802.11n HT20/HT40 only in control messages, so all the tests (except conducted output power and power spectral density) were performed on the worst case (802.11ac VHT20/802.11ac VHT40) mode between these 4 modes and only the worst data was recorded in this report.

The EUT support Cyclic Shift Diversity(CDD), Space Time Coding(STBC), Spatial Division Multiplexing(SDM) modes. They use the same conducted power per chain in any given mode, so we only chose the worst case mode CDD for final testing.

5.7. DESCRIPTION OF TEST SETUP

SUPPORT EQUIPMENT

Item	Equipment	Brand Name	Model Name	P/N
/	/	/	/	

I/O CABLES

Cable No	Port	Connector Type	Cable Type	Cable Length(m)	Remarks
1	USB	Type C	/	1.0	/

ACCESSORIES

Item	Accessory	Brand Name	Model Name	Description
/	/	/	/	/

TEST SETUP

The EUT can work in engineering mode with a software installed.

SETUP DIAGRAM FOR TESTS

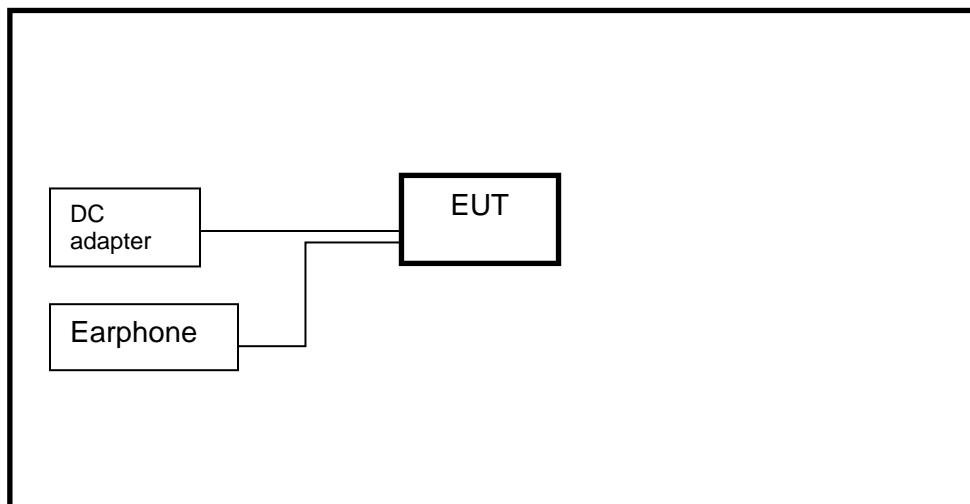

**6. MEASURING INSTRUMENT AND SOFTWARE USED**

Conducted Emissions					
Equipment	Manufacturer	Model No.	Serial No.	Last Cal.	Due Date
EMI Test Receiver	R&S	ESR3	101961	Nov. 12, 2020	Nov. 11, 2021
Two-Line V-Network	R&S	ENV216	101983	Nov. 12, 2020	Nov. 11, 2021
Software					
Description			Manufacturer	Name	Version
Test Software for Conducted Emissions			Farad	EZ-EMC	Ver. UL-3A1
Radiated Emissions					
Equipment	Manufacturer	Model No.	Serial No.	Last Cal.	Due Date
MXE EMI Receiver	KESIGHT	N9038A	MY56400036	Nov. 12, 2020	Nov. 11, 2021
Hybrid Log Periodic Antenna	TDK	HLP-3003C	130960	Aug. 11, 2018	Aug. 10, 2021
Preamplifier	HP	8447D	2944A09099	Nov. 12, 2020	Nov. 11, 2021
EMI Measurement Receiver	R&S	ESR26	101377	Nov. 12, 2020	Nov. 11, 2021
Horn Antenna	TDK	HRN-0118	130939	Sept. 17, 2018	Sept. 17, 2021
Preamplifier	TDK	PA-02-0118	TRS-305-00067	Nov. 20, 2020	Nov. 19, 2021
Horn Antenna	Schwarzbeck	BBHA9170	#691	Aug. 11, 2018	Aug. 11, 2021
Preamplifier	TDK	PA-02-2	TRS-307-00003	Nov. 12, 2020	Nov. 11, 2021
Preamplifier	TDK	PA-02-3	TRS-308-00002	Nov. 12, 2020	Nov. 11, 2021
Loop antenna	Schwarzbeck	1519B	00008	Jan.17, 2019	Jan.17,2022
Preamplifier	TDK	PA-02-001-3000	TRS-302-00050	Nov. 12, 2020	Nov. 11, 2021
Preamplifier	Mini-Circuits	ZX60-83LN-S+	SUP01201941	Nov. 20, 2020	Nov. 19, 2021
Highpass Filter	Wainwright	WHKX10-5850-6500-1800-40SS	4	Nov. 12, 2020	Nov. 11, 2021
Band Reject Filter	Wainwright	WRCJV12-5695-5725-5850-5880-40SS	4	Nov. 12, 2020	Nov. 11, 2021
Band Reject Filter	Wainwright	WRCJV20-5120-5150-5350-5380-60SS	2	Nov. 12, 2020	Nov. 11, 2021
Band Reject	Wainwright	WRCJV20-	1	Nov. 12, 2020	Nov. 11, 2021



Filter		5440-5470-5725-5755-60SS			
Software					
Description		Manufacturer	Name	Version	
Test Software for Radiated Emissions		Farad	EZ-EMC	Ver. UL-3A1	
Tonsend RF Test System					
Equipment	Manufacturer	Model No.	Serial No.	Last Cal.	Due. Date
Wideband Radio Communication Tester	R&S	CMW500	155523	Nov.20,2020	Nov.19,2021
PXA Signal Analyzer	Keysight	N9030A	MY55410512	Nov.20,2020	Nov.19,2021
MXG Vector Signal Generator	Keysight	N5182B	MY56200284	Nov.20,2020	Nov.19,2021
MXG Vector Signal Generator	Keysight	N5172B	MY56200301	Nov.20,2020	Nov.19,2021
DC power supply	Keysight	E3642A	MY55159130	Nov.24,2020	Nov.23,2021
Temperature & Humidity Chamber	SANMOOD	SG-80-CC-2	2088	Nov.20,2020	Nov.19,2021
Software					
Description		Manufacturer	Name	Version	
Tonsend SRD Test System		Tonsend	JS1120-3 RF Test System	2.6.77.0518	
Other Instruments					
Equipment	Manufacturer	Model No.	Serial No.	Last Cal.	Next Cal.
Dual Channel Power Meter	Keysight	N1912A	MY55416024	Nov. 20, 2020	Nov. 19, 2021
Power Sensor	Keysight	USB Wideband Power Sensor	MY5100022	Nov. 20, 2020	Nov. 19, 2021

7. ANTENNA PORT TEST RESULTS

7.1. ON TIME AND DUTY CYCLE

LIMITS

None; for reporting purposes only.

PROCEDURE

Refer to KDB 789033 D02 General U-NII Test Procedures New Rules v02r01 section II.B.

The zero-span mode on a spectrum analyzer or EMI receiver, if the response time and spacing between bins on the sweep are sufficient to permit accurate measurements of the on and off times of the transmitted signal. Set the center frequency of the instrument to the center frequency of the transmission. Set $RBW \geq EBW$ if possible; otherwise, set RBW to the largest available value. Set $VBW \geq RBW$. Set detector = peak or average. The zero-span measurement method shall not be used unless both RBW and VBW are $> 50/T$, where T is defined in II.B.1.a), and the number of sweep points across duration T exceeds 100. (For example, if VBW and/or RBW are limited to 3 MHz, then the zero-span method of measuring duty cycle shall not be used if $T \leq 16.7$ microseconds.)

TEST SETUP

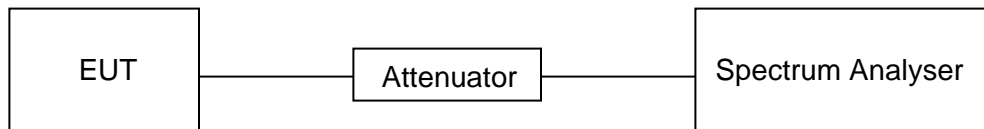

TEST ENVIRONMENT

Temperature	26.3 °C	Relative Humidity	67.5 %
Atmosphere Pressure	101 kPa	Test Voltage	DC 5 V

RESULTS

Please refer to appendix D.



7.2. 6/26 dB EMISSION BANDWIDTH AND 99 % OCCUPIED BANDWIDTH

LIMITS

CFR 47 FCC Part15, Subpart E		
Test Item	Limit	Frequency Range (MHz)
26 dB Emission Bandwidth	For reporting purposes only.	5150 ~ 5250
26 dB Emission Bandwidth	For reporting purposes only.	5250 ~ 5350
26 dB Emission Bandwidth	For reporting purposes only.	5470 ~ 5725 (For FCC) 5470 ~ 5600 (For ISED) 5650 ~ 5725 (For ISED)
6 dB Emission Bandwidth	The minimum 6 dB emission bandwidth shall be 500 kHz.	5725 ~ 5850
99 % Occupied Bandwidth	For reporting purposes only.	5150 ~ 5825 (For ISED)

TEST PROCEDURE

ISED RSS-247 6.2.1.2 clause unwanted emission limits

For transmitters with operating frequencies in the band 5150-5250 MHz, all emissions outside the band 5150-5350 MHz shall not exceed -27 dBm/MHz e.i.r.p. Any unwanted emissions that fall into the band 5250-5350 MHz shall be attenuated below the channel power by at least 26 dB, when measured using a resolution bandwidth between 1 and 5% of the occupied bandwidth (i.e. 99% bandwidth), above 5250 MHz.

TEST PROCEDURE

Refer to KDB 789033 D02 General U-NII Test Procedures New Rules v02r01 section II.C1. for 26 dB Emission Bandwidth; section II.C2. for 6 dB Emission Bandwidth; section II.D. for 99 % Occupied Bandwidth.

Connect the EUT to the spectrum analyser and use the following settings:

Center Frequency	The center frequency of the channel under test
Detector	Peak
RBW	For 6 dB Emission Bandwidth: RBW=100 kHz For 26 dB Emission bandwidth: approximately 1 % of the EBW. For 99 % Occupied Bandwidth: approximately 1 % ~ 5 % of the OBW.
VBW	For 6 dB Bandwidth: $\geq 3 \times \text{RBW}$ For 26 dB Bandwidth: $> 3 \times \text{RBW}$ For 99 % Bandwidth: $> 3 \times \text{RBW}$
Trace	Max hold
Sweep	Auto couple

a) Use the 99 % power bandwidth function of the instrument, allow the trace to stabilize and report the measured bandwidth.

b) Allow the trace to stabilize and measure the maximum width of the emission that is constrained by the frequencies associated with the two outermost amplitude points (upper and lower frequencies) that are attenuated by 6/26 dB relative to the maximum level measured in the fundamental emission.

TEST SETUP

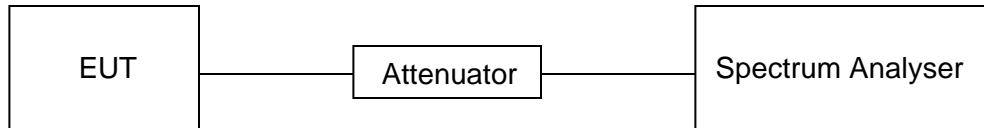

TEST ENVIRONMENT

Temperature	26.3 °C	Relative Humidity	67.5 %
Atmosphere Pressure	101 kPa	Test Voltage	DC 5 V

RESULTS

Please refer to Appendix A1&A2&A3.



7.3. CONDUCTED OUTPUT POWER

LIMITS

CFR 47 FCC Part15, Subpart E		
Test Item	Limit	Frequency Range (MHz)
Conducted Output Power	<input type="checkbox"/> Outdoor Access Point: 1 W (30 dBm) <input type="checkbox"/> Indoor Access Point: 1 W (30 dBm) <input type="checkbox"/> Fixed Point-To-Point Access Points: 1 W (30 dBm) <input checked="" type="checkbox"/> Client Devices: 250 mW (24 dBm)	5150 ~ 5250
	Shall not exceed the lesser of 250 mW (24dBm) or 11 dBm + 10 log B, where B is the 26 dB emission bandwidth in megahertz.	5250 ~ 5350 5470 ~ 5725
	Shall not exceed 1 Watt (30 dBm).	5725 ~ 5850

Note:

The above limits are based upon the maximum antenna gain does not exceed 6 dBi. If transmitting antennas of directional gain greater than 6 dBi are used, the maximum conducted output power shall be reduced by the amount in dB that the directional gain of the antenna exceeds 6 dBi.

TEST PROCEDURE

Refer to KDB 789033 D02 General U-NII Test Procedures New Rules v02r01 section II.E.

Method SA-1 (trace averaging with the EUT transmitting at full power throughout each sweep):

- (i) Set span to encompass the entire emission bandwidth (EBW) (or, alternatively, the entire 99% occupied bandwidth) of the signal.
- (ii) Set RBW = 1 MHz.
- (iii) Set VBW \geq 3 MHz.
- (iv) Number of points in sweep $\geq 2 \times$ span / RBW. (This ensures that bin-to-bin spacing is \leq RBW/2, so that narrowband signals are not lost between frequency bins.)
- (v) Sweep time = auto.
- (vi) Detector = power averaging (rms), if available. Otherwise, use sample detector mode.
- (vii) If transmit duty cycle $<$ 98 %, use a video trigger with the trigger level set to enable triggering only on full power pulses. Transmitter must operate at maximum power control level for the entire duration of every sweep. If the EUT transmits continuously (i.e., with no off intervals) or at duty cycle \geq 98 %, and if each transmission is entirely at the maximum power control level, then the trigger shall be set to “free run.”
- (viii) Trace average at least 100 traces in power averaging (rms) mode.
- (ix) Compute power by integrating the spectrum across the EBW (or, alternatively, the entire 99% occupied bandwidth) of the signal using the instrument’s band power measurement function with band limits set equal to the EBW (or occupied bandwidth) band edges. If the instrument does not have a band power function, sum the spectrum levels (in power units) at 1 MHz intervals extending across the EBW (or, alternatively, the entire 99% occupied bandwidth) of the spectrum.

Method PM (Measurement using an RF average power meter):

- (i) Measurements may be performed using a wideband RF power meter with a thermocouple detector or equivalent if all of the following conditions are satisfied:
 - a. The EUT is configured to transmit continuously or to transmit with a constant duty cycle.
 - b. At all times when the EUT is transmitting, it must be transmitting at its maximum power control level.
 - c. The integration period of the power meter exceeds the repetition period of the transmitted signal by at least a factor of five.
- (ii) If the transmitter does not transmit continuously, measure the duty cycle, x , of the transmitter output signal as described in II.B.
- (iii) Measure the average power of the transmitter. This measurement is an average over both the on and off periods of the transmitter.
- (iv) Adjust the measurement in dBm by adding $10 \log (1/x)$ where x is the duty cycle (e.g., $10 \log (1/0.25)$ if the duty cycle is 25 %).

Method PM-G (Measurement using a gated RF average power meter):

Measurements may be performed using a wideband gated RF power meter provided that the gate parameters are adjusted such that the power is measured only when the EUT is transmitting at its maximum power control level. Since the measurement is made only during the ON time of the transmitter, no duty cycle correction factor is required.



TEST SETUP

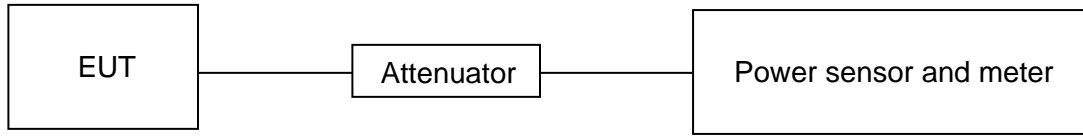

TEST ENVIRONMENT

Temperature	26.3 °C	Relative Humidity	67.5 %
Atmosphere Pressure	101 kPa	Test Voltage	DC 5 V

RESULTS

Please refer to Appendix B.



7.4. POWER SPECTRAL DENSITY

LIMITS

CFR 47 FCC Part15, Subpart E		
Test Item	Limit	Frequency Range (MHz)
Power Spectral Density	<input type="checkbox"/> Outdoor Access Point: 17 dBm/MHz <input type="checkbox"/> Indoor Access Point: 17 dBm/MHz <input type="checkbox"/> Fixed Point-To-Point Access Points: 17 dBm/MHz <input checked="" type="checkbox"/> Client Devices: 11 dBm/MHz	5150 ~ 5250
	11 dBm/MHz	5250 ~ 5350 5470 ~ 5725
	30 dBm/500kHz	5725 ~ 5850

Note:

The above limits are based upon the maximum antenna gain does not exceed 6 dBi. If transmitting antennas of directional gain greater than 6 dBi are used, maximum power spectral density shall be reduced by the amount in dB that the directional gain of the antenna exceeds 6 dBi.

TEST PROCEDURE

Refer to KDB 789033 D02 General U-NII Test Procedures New Rules v02r01 section II.F.

Connect the EUT to the spectrum analyser and use the following settings:

For U-NII-1, U-NII-2A and U-NII-2C band:

Center Frequency	The center frequency of the channel under test
Detector	RMS
RBW	1 MHz
VBW	$\geq 3 \times \text{RBW}$
Span	Encompass the entire emissions bandwidth (EBW) of the signal
Trace	Max hold
Sweep time	Auto

For U-NII-3:

Center Frequency	The center frequency of the channel under test
Detector	RMS
RBW	500 kHz
VBW	$\geq 3 \times \text{RBW}$
Span	Encompass the entire emissions bandwidth (EBW) of the signal
Trace	Max hold
Sweep time	Auto

Allow trace to fully stabilize and Use the peak search function on the instrument to find the peak of the spectrum and record its value.

Add $10 \log(1/x)$, where x is the duty cycle, to the peak of the spectrum, the result is the Maximum PSD over 1 MHz / 500 kHz reference bandwidth.

TEST SETUP

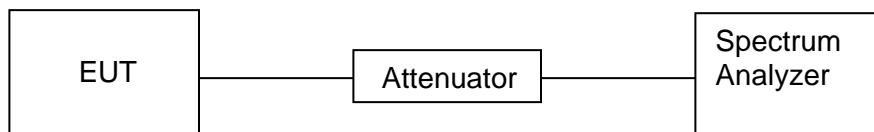

TEST ENVIRONMENT

Temperature	26.3 °C	Relative Humidity	67.5 %
Atmosphere Pressure	101 kPa	Test Voltage	DC 5 V

RESULTS

Please refer to Appendix C.



8. RADIATED TEST RESULTS

LIMITS

Refer to CFR 47 FCC §15.205, §15.209 and §15.407 (b).

Radiation Disturbance Test Limit for FCC (Class B) (9 kHz ~ 1 GHz)

Emissions radiated outside of the specified frequency bands above 30 MHz			
Frequency Range (MHz)	Field Strength Limit (uV/m) at 3 m	Field Strength Limit (dBuV/m) at 3 m	
		Quasi-Peak	
30 - 88	100	40	
88 - 216	150	43.5	
216 - 960	200	46	
Above 960	500	54	
Above 1000	500	Peak	Average
		74	54

FCC Emissions radiated outside of the specified frequency bands below 30 MHz		
Frequency (MHz)	Field strength (microvolts/meter)	Measurement distance (meters)
0.009-0.490	2400/F(kHz)	300
0.490-1.705	24000/F(kHz)	30
1.705-30.0	30	30



FCC Restricted bands of operation refer to FCC §15.205 (a):

MHz	MHz	MHz	GHz
0.090-0.110	16.42-16.423	399.9-410	4.5-5.15
¹ 0.495-0.505	16.69475-16.69525	608-614	5.35-5.46
2.1735-2.1905	16.80425-16.80475	960-1240	7.25-7.75
4.125-4.128	25.5-25.67	1300-1427	8.025-8.5
4.17725-4.17775	37.5-38.25	1435-1626.5	9.0-9.2
4.20725-4.20775	73-74.6	1645.5-1646.5	9.3-9.5
6.215-6.218	74.8-75.2	1660-1710	10.6-12.7
6.26775-6.26825	108-121.94	1718.8-1722.2	13.25-13.4
6.31175-6.31225	123-138	2200-2300	14.47-14.5
8.291-8.294	149.9-150.05	2310-2390	15.35-16.2
8.362-8.366	156.52475-156.52525	2483.5-2500	17.7-21.4
8.37625-8.38675	156.7-156.9	2690-2900	22.01-23.12
8.41425-8.41475	162.0125-167.17	3260-3267	23.6-24.0
12.29-12.293	167.72-173.2	3332-3339	31.2-31.8
12.51975-12.52025	240-285	3345.8-3358	36.43-36.5
12.57675-12.57725	322-335.4	3600-4400	(²)
13.36-13.41			

Note: ¹Until February 1, 1999, this restricted band shall be 0.490-0.510 MHz.

²Above 38.6c

Limits of unwanted/undesirable emission out of the restricted bands refer to CFR 47 FCC §15.407 (b) and ISSED RSS-247 6.2.

LIMITS OF RADIATED EMISSION MEASUREMENT (Above 1GHz)		
Frequency Range (MHz)	EIRP Limit	Field Strength Limit (dBuV/m) at 3 m
5150~5250 MHz	PK: -27 (dBm/MHz)	PK:68.2(dBμV/m)
5250~5350 MHz		
5470~5725 MHz		
5725~5850 MHz	PK: -27 (dBm/MHz) *1 PK: 10 (dBm/MHz) *2 PK: 15.6 (dBm/MHz) *3 PK: 27 (dBm/MHz) *4	PK: 68.2(dBμV/m) *1 PK: 105.2 (dBμV/m) *2 PK: 110.8(dBμV/m) *3 PK: 122.2 (dBμV/m) *4

Note:

*1 beyond 75 MHz or more above of the band edge.

*2 below the band edge increasing linearly to 10 dBm/MHz at 25 MHz above.

*3 below the band edge increasing linearly to a level of 15.6 dBm/MHz at 5 MHz above.

*4 from 5 MHz above or below the band edge increasing linearly to a level of 27 dBm/MHz at the band edge.

TEST SETUP AND PROCEDURE

Below 30 MHz

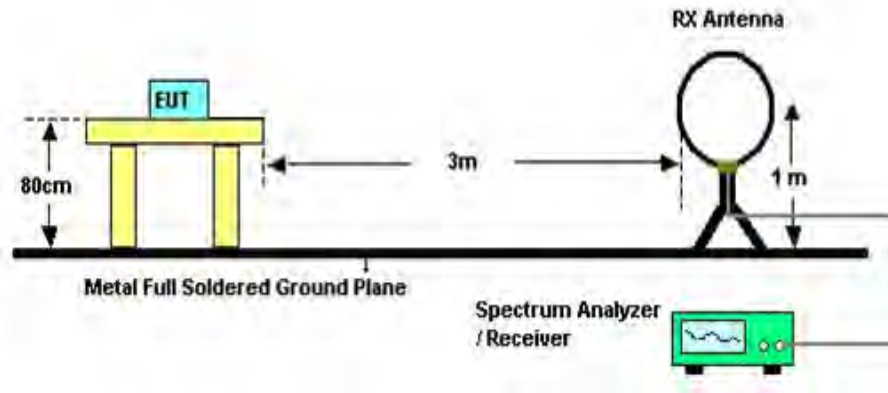

The setting of the spectrum analyser

RBW	200 Hz (From 9 kHz to 0.15 MHz)/ 9 kHz (From 0.15 MHz to 30 MHz)
VBW	200 Hz (From 9 kHz to 0.15 MHz)/ 9 kHz (From 0.15 MHz to 30 MHz)
Sweep	Auto
Trace	Max hold

1. The testing follows the guidelines in ANSI C63.10-2013 clause 6.4.
2. The EUT was arranged to its worst case and then turntable (from 0 degree to 360 degrees) to find the maximum reading. A pre-amp and a high pass filter are used for the test in order to get better signal level. Both Horizontal, Face-on and Face-off polarizations of the antenna are set to make the measurement.
3. The EUT was placed on a turntable with 80 cm above ground.
4. The EUT was set 3 meters from the interference receiving antenna, which was mounted on the top of a 1 m height antenna tower.
5. The radiated emission limits are based on measurements employing a CISPR quasi-peak detector except for the frequency bands 9-90 kHz, 110-490 kHz and above 1000 MHz. Radiated emission limits in these three bands are based on measurements employing an average detector.
6. For measurement below 1 GHz, the initial step in collecting conducted emission data is a spectrum analyzer peak detector mode pre-scanning the measurement frequency range. Significant peaks are then marked and then Quasi Peak and average detector mode re-measured. If the emission level of the EUT measured by the peak detector is 3 dB lower than the applicable limit, the peak emission level will be reported. Otherwise, the emission measurement will be repeated using the quasi-peak and average detector and reported.
7. Although these tests were performed other than open field site, adequate comparison measurements were confirmed against 30 m open field site. Therefore sufficient tests were made to demonstrate that the alternative site produces results that correlate with the ones of tests made in an open field site based on KDB 414788.

Below 1 GHz and above 30 MHz

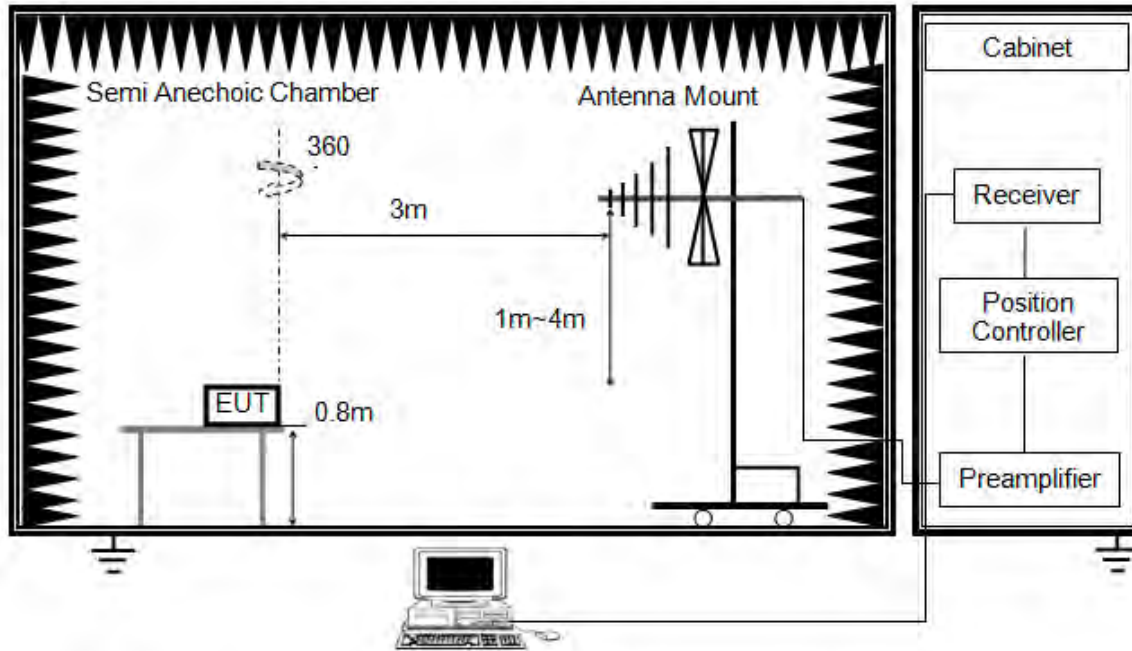

The setting of the spectrum analyser

RBW	120 kHz
VBW	300 kHz
Sweep	Auto
Detector	Peak/QP
Trace	Max hold

1. The testing follows the guidelines in ANSI C63.10-2013 clause 6.5.
2. The EUT was arranged to its worst case and then tune the antenna tower (from 1 m to 4 m) and turntable (from 0 degree to 360 degrees) to find the maximum reading. A pre-amp and a high pass filter are used for the test in order to get better signal level. Both horizontal and vertical polarizations of the antenna are set to make the measurement.
3. The EUT was placed on a turntable with 80 cm above ground.
4. The EUT was set 3 meters from the interference receiving antenna, which was mounted on the top of a variable height antenna tower.
5. For measurement below 1 GHz, the initial step in collecting conducted emission data is a spectrum analyzer peak detector mode pre-scanning the measurement frequency range. Significant peaks are then marked and then Quasi Peak detector mode re-measured. If the emission level of the EUT measured by the peak detector is 3 dB lower than the applicable limit, the peak emission level will be reported. Otherwise, the emission measurement will be repeated using the quasi-peak detector and reported.

Above 1 GHz

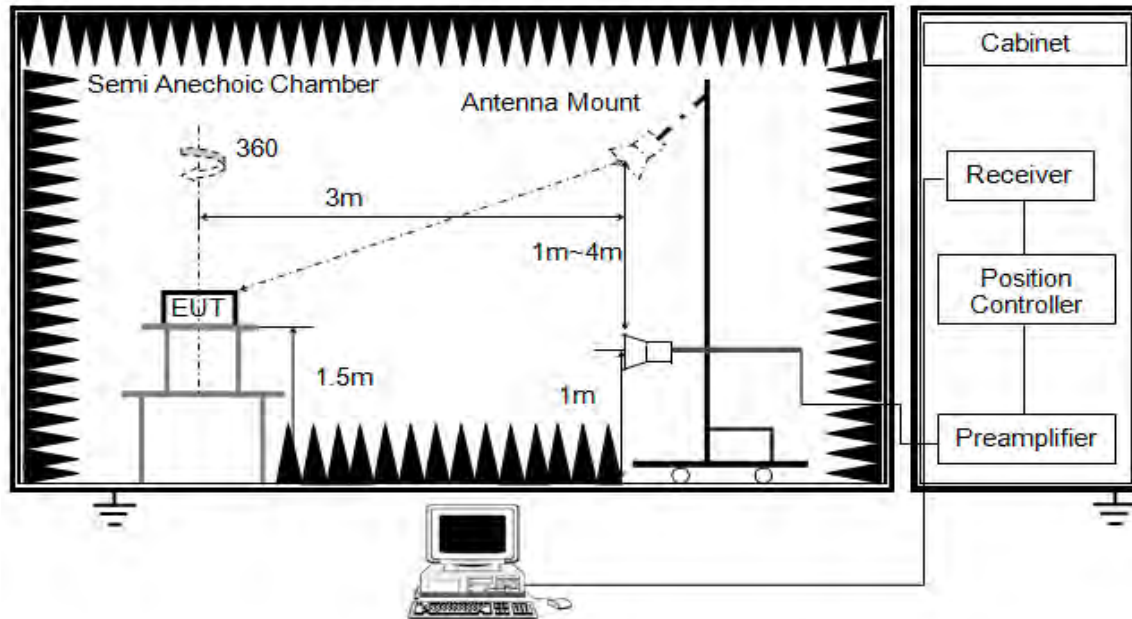

The setting of the spectrum analyser

RBW	1 MHz
VBW	PEAK: 3 MHz AVG: see note 6
Sweep	Auto
Detector	Peak
Trace	Max hold

1. The testing follows the guidelines in KDB 789033 D02 General U-NII Test Procedures New Rules v02r01 section II.G.3 ~ II.G.6.
2. The EUT was arranged to its worst case and then tune the antenna tower (1-4 m) and turntable (from 0 degree to 360 degrees) to find the maximum reading. A pre-amp and a high pass filter are used for the test in order to get better signal level. Both horizontal and vertical polarizations of the antenna are set to make the measurement.
3. The EUT was placed on a turntable with 1.5 m above ground.
4. The EUT was set 3 meters from the interference receiving antenna, which was mounted on the top of a variable height antenna tower.
5. For measurement above 1 GHz, the emission measurement will be measured by the peak detector. This peak level, once corrected, must comply with the limit specified in Section 15.209.
6. For measurements above 1 GHz the resolution bandwidth is set to 1 MHz, then the video bandwidth is set to 3 MHz for peak measurements and 1 MHz resolution bandwidth with 1/T video bandwidth with peak detector for average measurements. For the Duty Cycle please refer to clause 7.1.ON TIME AND DUTY CYCLE.

X axis, Y axis, Z axis positions:

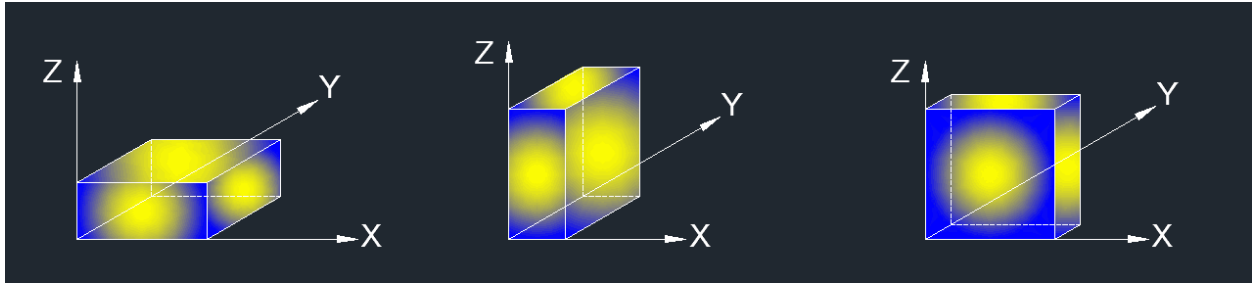

Note 1: For all radiated test, EUT in each of three orthogonal axis emissions had been tested, but only the worst case (X axis) data recorded in the report.

Note 2: The EUT was fully exercised with external accessories during the test. In the case of multiple accessory external ports, an external accessory shall be connected to one of each type of port.

Note 3: BT, BLE and WIFI can not transmit in simultaneous.

TEST ENVIRONMENT

Temperature	22.6 °C	Relative Humidity	64.4 %
Atmosphere Pressure	101 kPa	Test Voltage	DC 5 V

RESULTS



8.1. RESTRICTED BANDEDGE

8.1.1. 802.11a SISO MODE

UNII-1 BAND

RESTRICTED BANDEDGE (LOW CHANNEL, VERTICAL)

PEAK

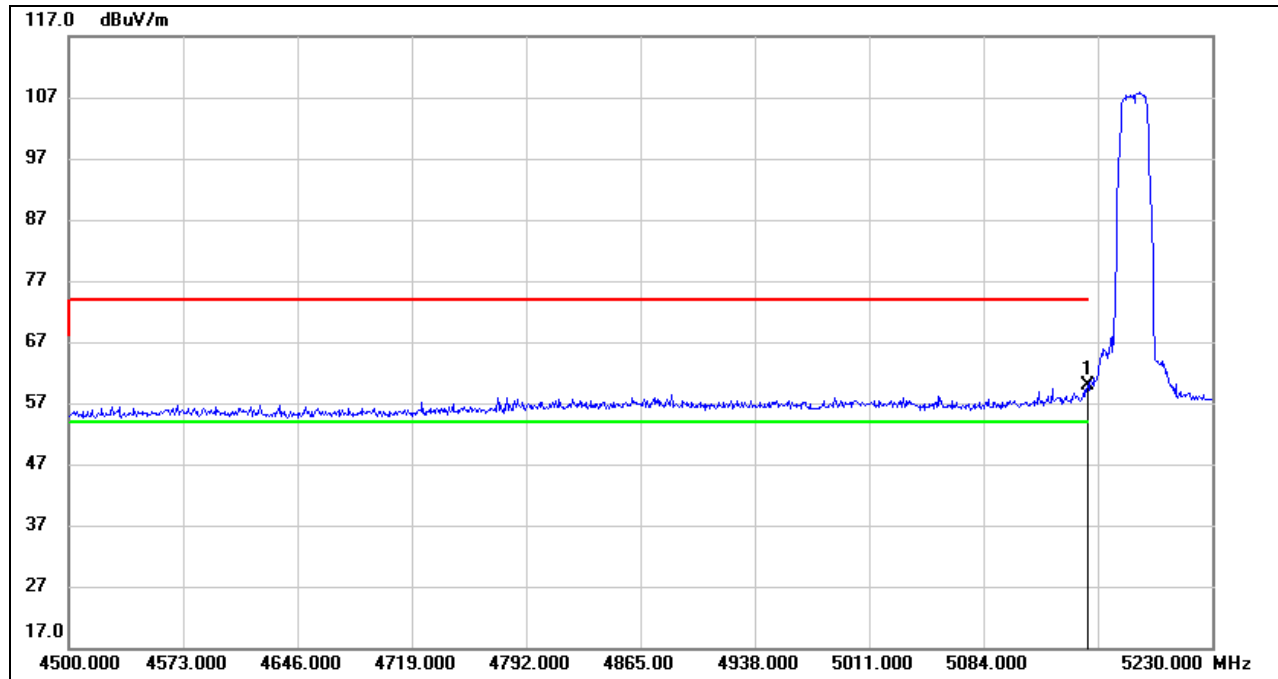

No.	Frequency (MHz)	Reading (dBuV)	Correct (dB/m)	Result (dBuV/m)	Limit (dBuV/m)	Margin (dB)	Remark
1	5150.000	18.62	41.19	59.81	74.00	-14.19	peak

- Note:
1. Measurement = Reading Level + Correct Factor.
 2. If Peak Result complies with AV limit, AV Result is deemed to comply with AV limit.
 3. Peak: Peak detector.
 4. Only the worst data was recorded, if it complies with the limit, the other emissions deemed to comply with the limit.
 5. All the polarities (vertical and horizontal) had been tested, only the worst data was recorded in the report.



AVG

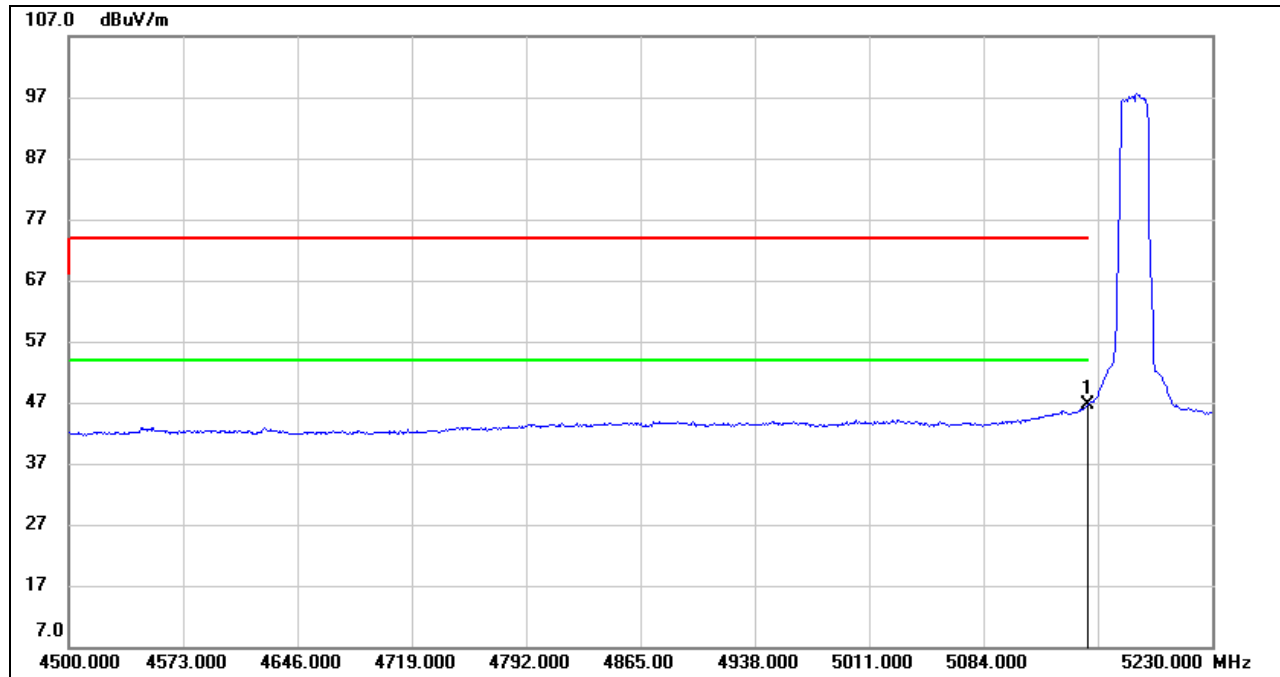

No.	Frequency (MHz)	Reading (dBuV)	Correct (dB/m)	Result (dBuV/m)	Limit (dBuV/m)	Margin (dB)	Remark
1	5150.000	5.41	41.19	46.60	54.00	-7.40	AVG

- Note:
1. Measurement = Reading Level + Correct Factor.
 2. If Peak Result complies with AV limit, AV Result is deemed to comply with AV limit.
 3. AVG: $VBW=1/T_{on}$, where: T_{on} is the transmitting duration.
 4. For the transmitting duration, please refer to clause 7.1.
 5. Only the worst data was recorded, if it complies with the limit, the other emissions deemed to comply with the limit.

UNII-3 BAND

RESTRICTED BANDEDGE (LOW CHANNEL, VERTICAL)

PEAK

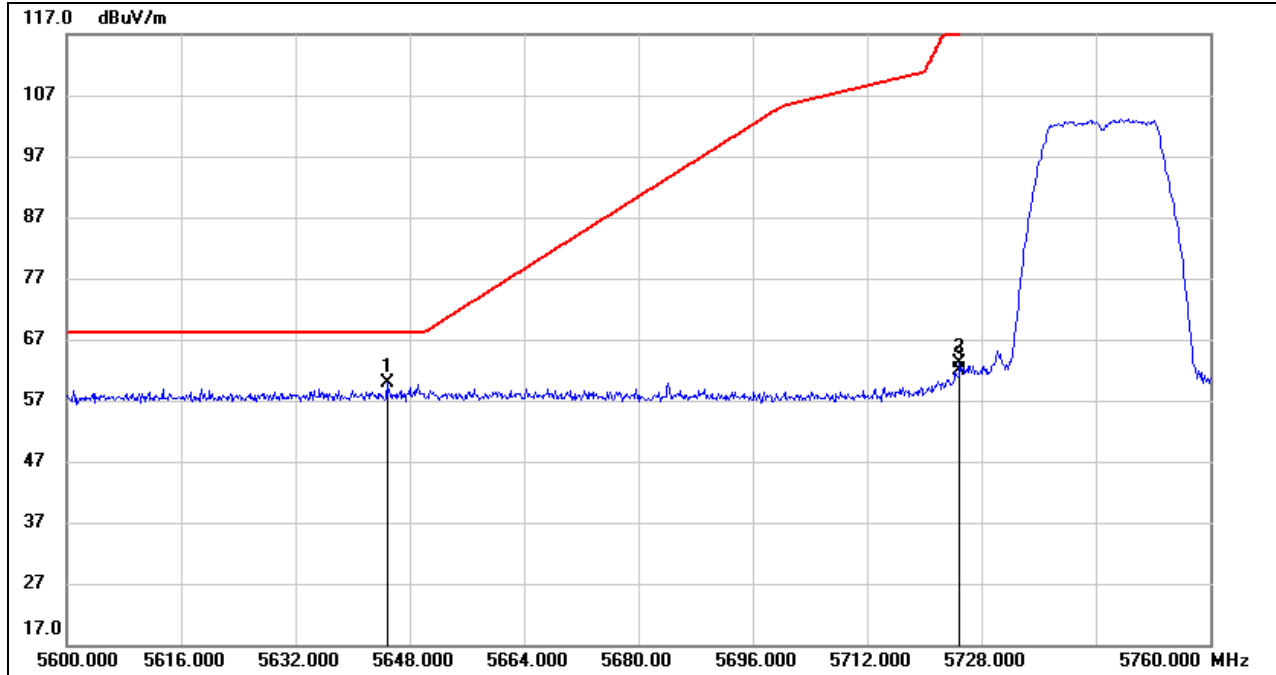

No.	Frequency (MHz)	Reading (dBuV)	Correct (dB/m)	Result (dBuV/m)	Limit (dBuV/m)	Margin (dB)	Remark
1	5644.800	18.17	41.65	59.82	68.20	-8.38	peak
2	5724.960	21.56	41.67	63.23	122.11	-58.88	peak
3	5725.000	20.13	41.67	61.80	122.20	-60.40	peak

- Note: 1. Measurement = Reading Level + Correct Factor.
 2. If Peak Result complies with AV limit, AV Result is deemed to comply with AV limit.
 3. Peak: Peak detector.
 4. Only the worst data was recorded, if it complies with the limit, the other emissions deemed to comply with the limit.
 5. All the polarities (vertical and horizontal) had been tested, only the worst data was recorded in the report.

RESTRICTED BANDEDGE (HIGH CHANNEL, VERTICAL)

PEAK

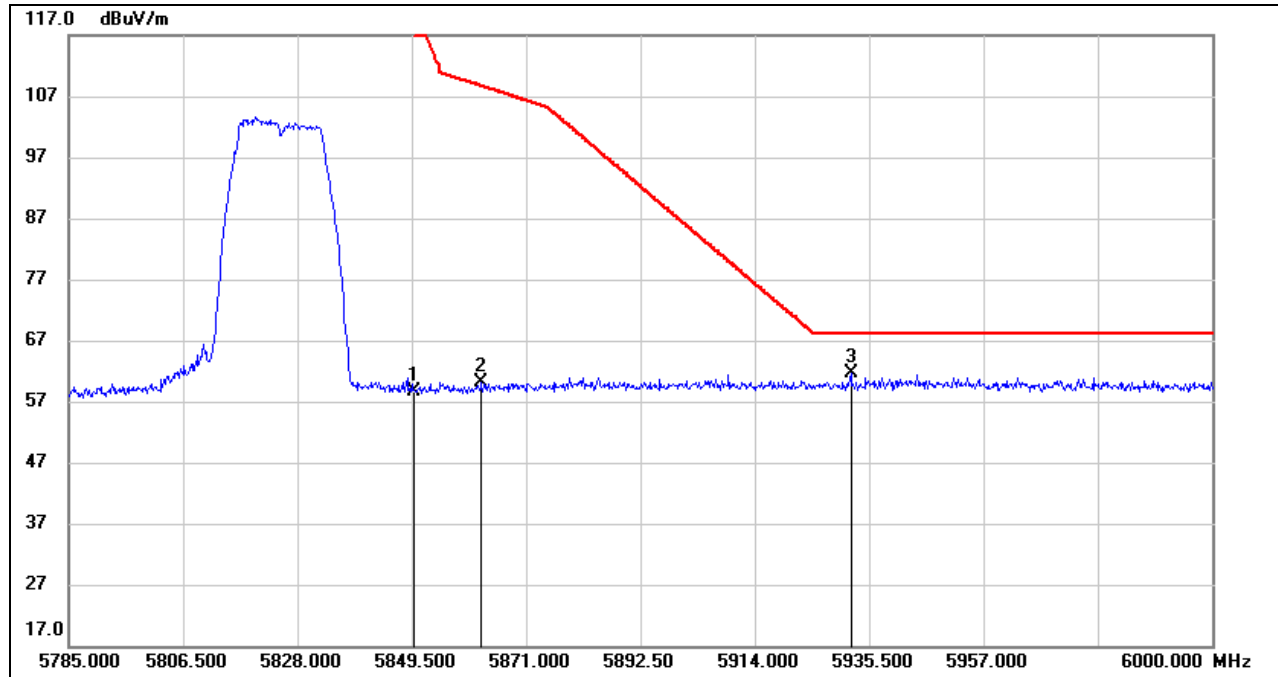

No.	Frequency (MHz)	Reading (dBuV)	Correct (dB/m)	Result (dBuV/m)	Limit (dBuV/m)	Margin (dB)	Remark
1	5850.000	16.08	42.52	58.60	122.20	-63.60	peak
2	5862.615	17.40	42.66	60.06	108.67	-48.61	peak
3	5932.060	18.79	42.88	61.67	68.20	-6.53	peak

- Note: 1. Measurement = Reading Level + Correct Factor.
 2. If Peak Result complies with AV limit, AV Result is deemed to comply with AV limit.
 3. Peak: Peak detector.
 4. Only the worst data was recorded, if it complies with the limit, the other emissions deemed to comply with the limit.
 5. All the polarities (vertical and horizontal) had been tested, only the worst data was recorded in the report.

8.1.2. 802.11n HT20 MIMO MODE

UNII-1 BAND

RESTRICTED BANDEDGE (LOW CHANNEL, VERTICAL)

PEAK

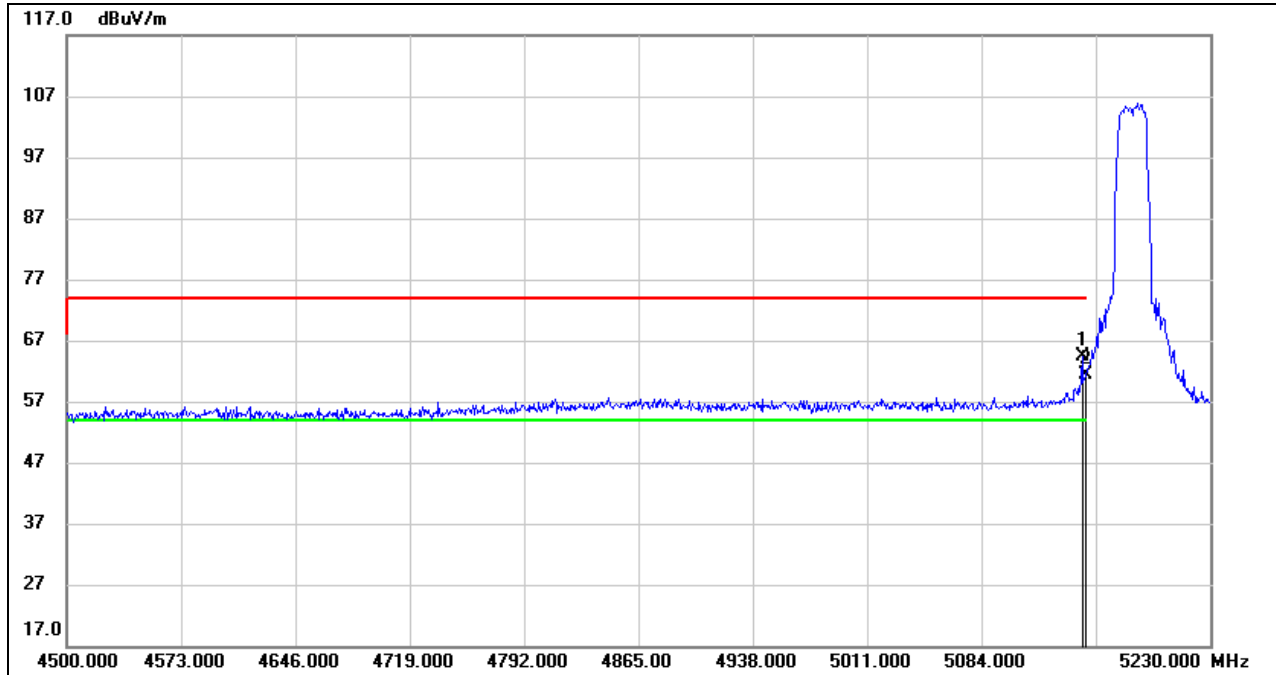

No.	Frequency (MHz)	Reading (dBuV)	Correct (dB/m)	Result (dBuV/m)	Limit (dBuV/m)	Margin (dB)	Remark
1	5148.240	23.10	41.17	64.27	74.00	-9.73	peak
2	5150.000	20.15	41.19	61.34	74.00	-12.66	peak

- Note: 1. Measurement = Reading Level + Correct Factor.
 2. If Peak Result complies with AV limit, AV Result is deemed to comply with AV limit.
 3. Peak: Peak detector.
 4. Only the worst data was recorded, if it complies with the limit, the other emissions deemed to comply with the limit.
 5. All the polarities (vertical and horizontal) had been tested, only the worst data was recorded in the report.

AVG

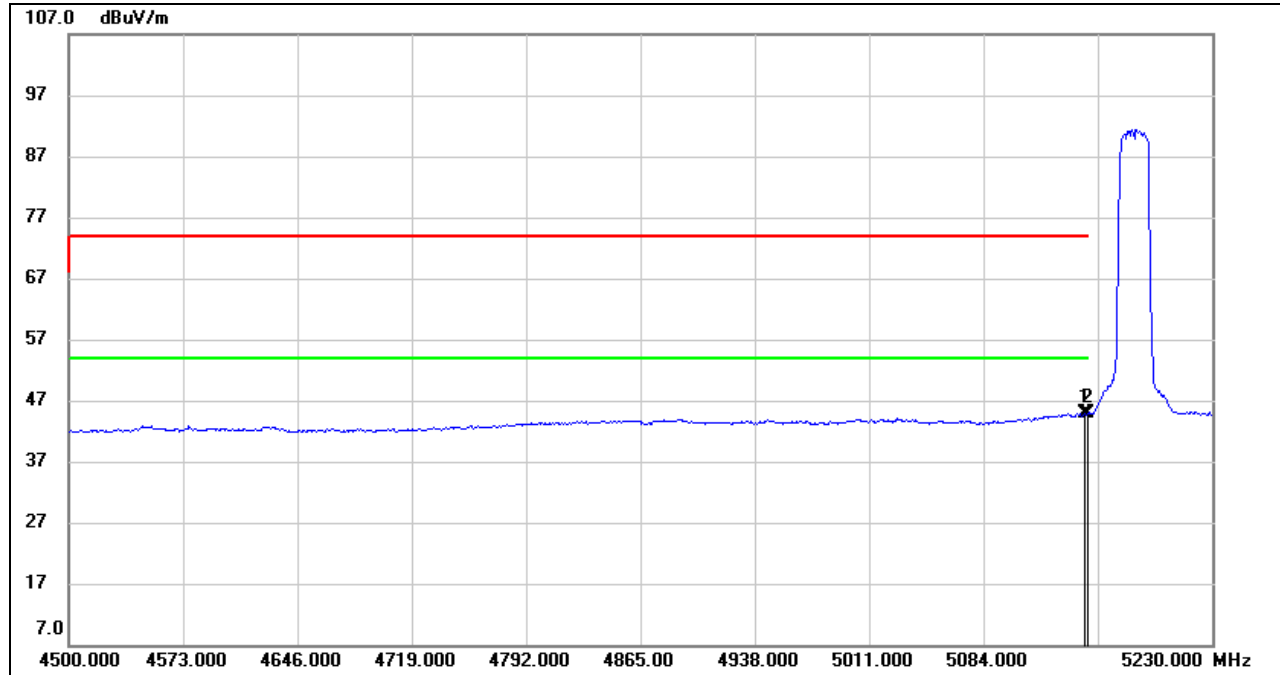

No.	Frequency (MHz)	Reading (dBuV)	Correct (dB/m)	Result (dBuV/m)	Limit (dBuV/m)	Margin (dB)	Remark
1	5148.240	3.72	41.17	44.89	54.00	-9.11	AVG
2	5150.000	3.65	41.19	44.84	54.00	-9.16	AVG

- Note:
1. Measurement = Reading Level + Correct Factor.
 2. If Peak Result complies with AV limit, AV Result is deemed to comply with AV limit.
 3. AVG: $VBW=1/Ton$, where: Ton is the transmitting duration.
 4. For the transmitting duration, please refer to clause 7.1.
 5. Only the worst data was recorded, if it complies with the limit, the other emissions deemed to comply with the limit.

UNII-3 BAND

RESTRICTED BANDEDGE (LOW CHANNEL, VERTICAL)

PEAK

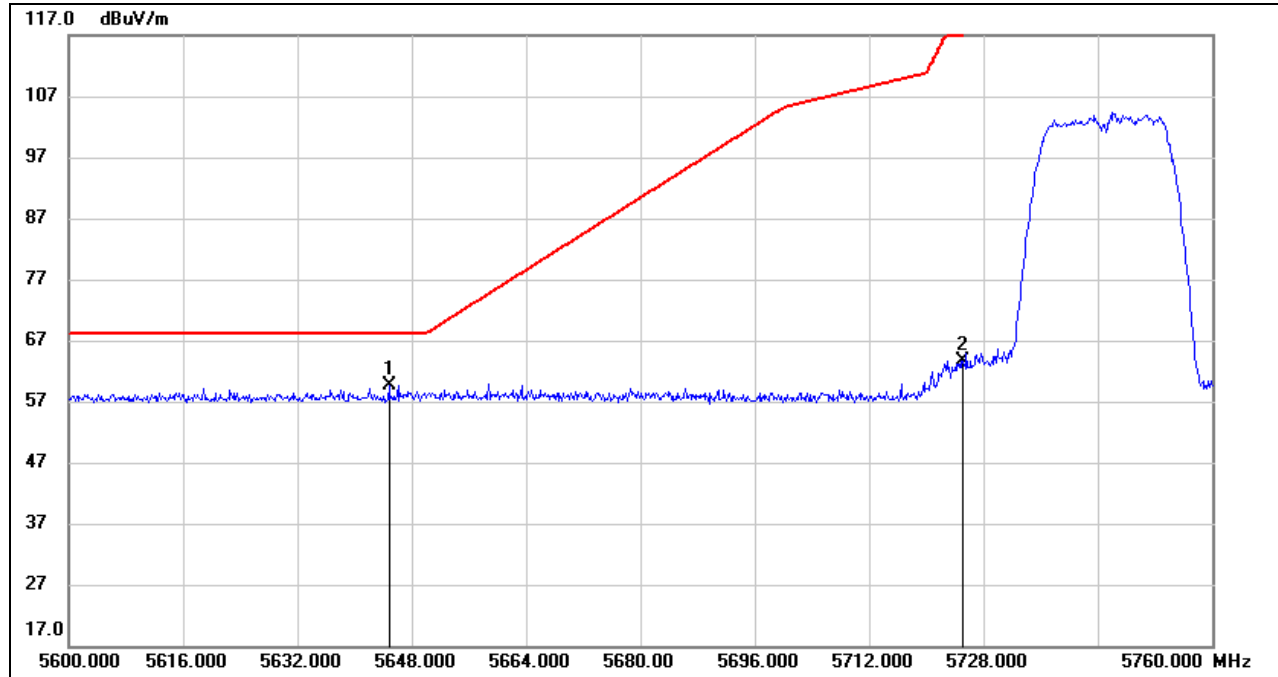

No.	Frequency (MHz)	Reading (dBuV)	Correct (dB/m)	Result (dBuV/m)	Limit (dBuV/m)	Margin (dB)	Remark
1	5644.800	18.08	41.65	59.73	68.20	-8.47	peak
2	5725.000	21.96	41.67	63.63	122.20	-58.57	peak

- Note: 1. Measurement = Reading Level + Correct Factor.
 2. If Peak Result complies with AV limit, AV Result is deemed to comply with AV limit.
 3. Peak: Peak detector.
 4. Only the worst data was recorded, if it complies with the limit, the other emissions deemed to comply with the limit.
 5. All the polarities (vertical and horizontal) had been tested, only the worst data was recorded in the report.

RESTRICTED BANDEDGE (HIGH CHANNEL, VERTICAL)

PEAK

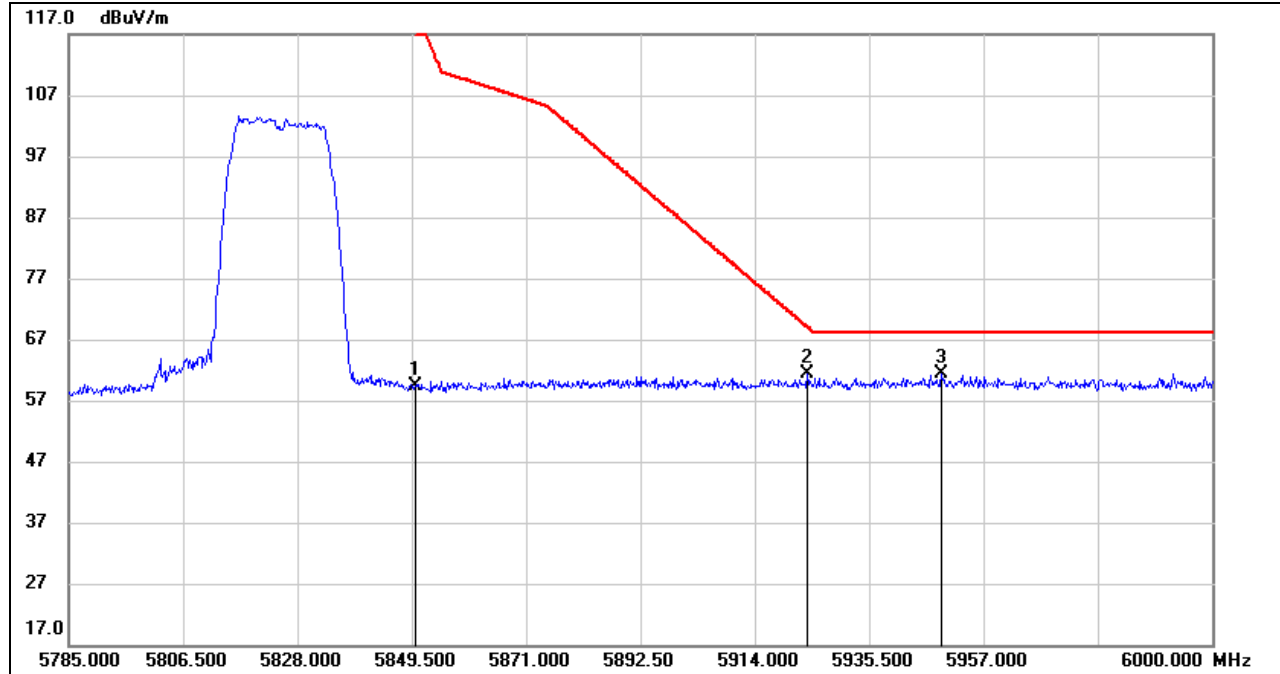

No.	Frequency (MHz)	Reading (dBuV)	Correct (dB/m)	Result (dBuV/m)	Limit (dBuV/m)	Margin (dB)	Remark
1	5850.000	16.81	42.52	59.33	122.20	-62.87	peak
2	5923.890	18.42	42.92	61.34	69.02	-7.68	peak
3	5949.045	18.57	42.80	61.37	68.20	-6.83	peak

- Note:
1. Measurement = Reading Level + Correct Factor.
 2. If Peak Result complies with AV limit, AV Result is deemed to comply with AV limit.
 3. Peak: Peak detector.
 4. Only the worst data was recorded, if it complies with the limit, the other emissions deemed to comply with the limit.
 5. All the polarities (vertical and horizontal) had been tested, only the worst data was recorded in the report.



8.1.3. 802.11n HT40 MIMO MODE

UNII-1 BAND

RESTRICTED BANDEDGE (LOW CHANNEL, VERTICAL)

PEAK

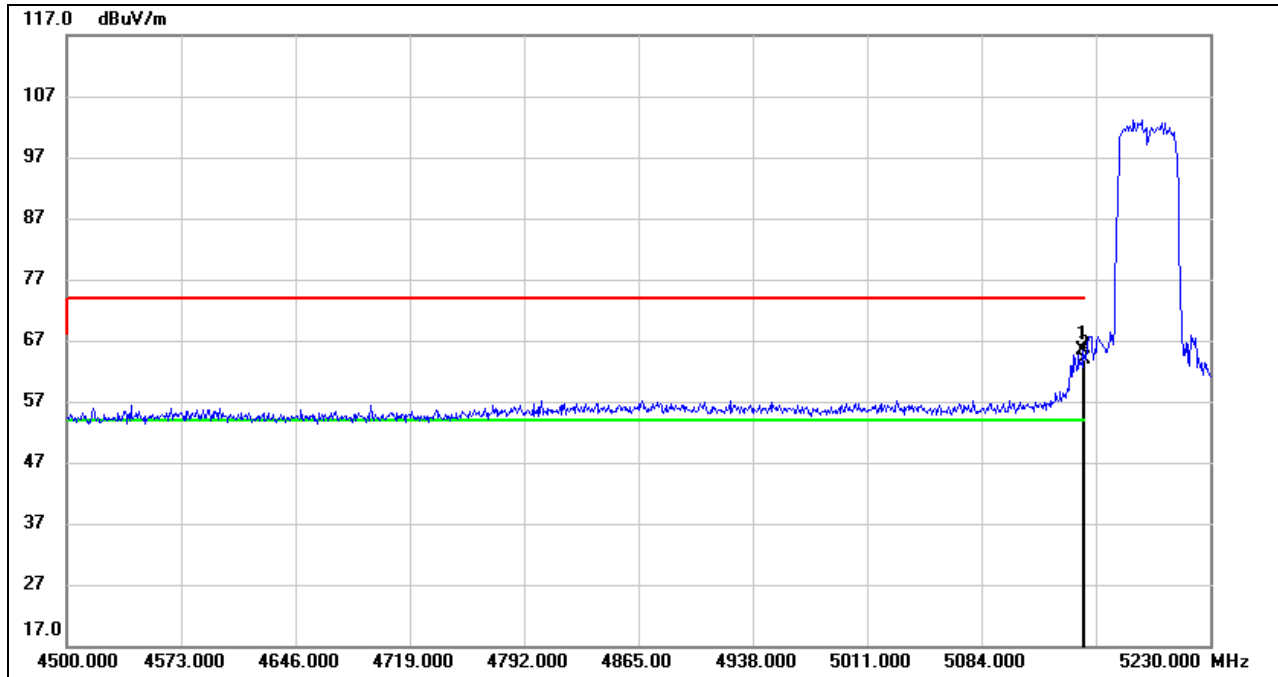

No.	Frequency (MHz)	Reading (dBuV)	Correct (dB/m)	Result (dBuV/m)	Limit (dBuV/m)	Margin (dB)	Remark
1	5148.970	24.28	41.18	65.46	74.00	-8.54	peak
2	5150.000	22.61	41.19	63.80	74.00	-10.20	peak

- Note:
1. Measurement = Reading Level + Correct Factor.
 2. If Peak Result complies with AV limit, AV Result is deemed to comply with AV limit.
 3. Peak: Peak detector.
 4. Only the worst data was recorded, if it complies with the limit, the other emissions deemed to comply with the limit.
 5. All the polarities (vertical and horizontal) had been tested, only the worst data was recorded in the report.

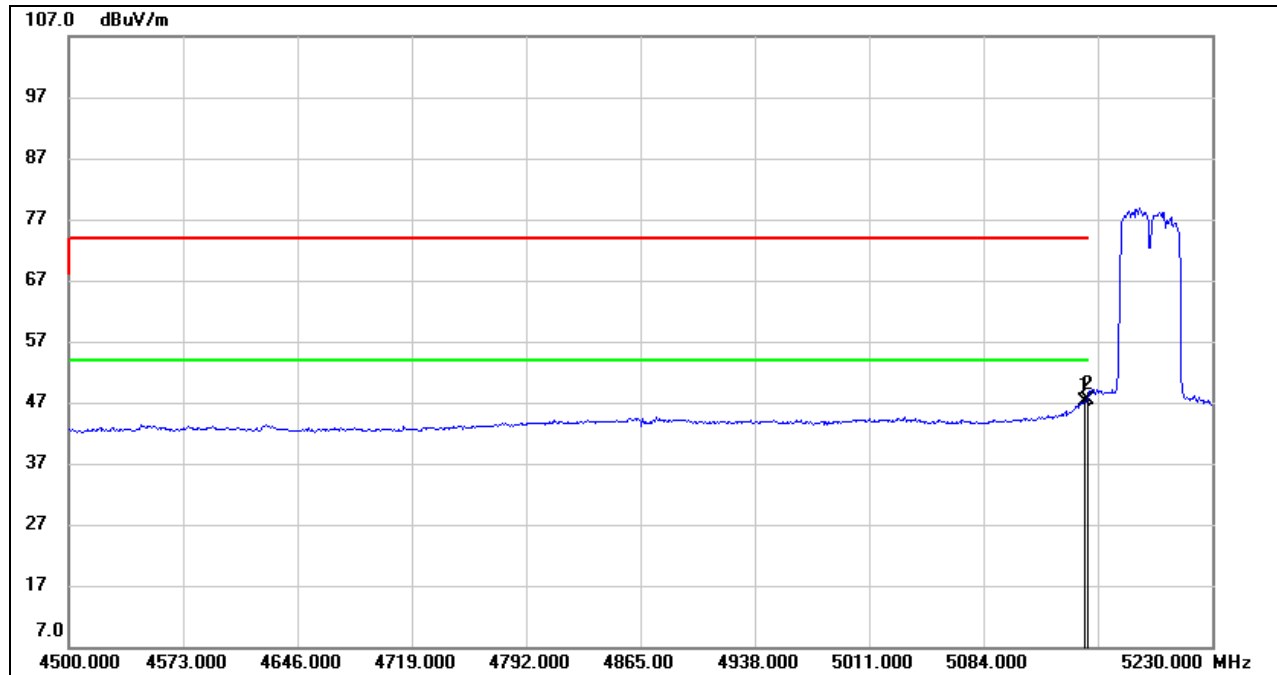
**AVG**

No.	Frequency (MHz)	Reading (dBuV)	Correct (dB/m)	Result (dBuV/m)	Limit (dBuV/m)	Margin (dB)	Remark
1	5148.970	6.02	41.18	47.20	54.00	-6.80	AVG
2	5150.000	6.17	41.19	47.36	54.00	-6.64	AVG

- Note:
1. Measurement = Reading Level + Correct Factor.
 2. If Peak Result complies with AV limit, AV Result is deemed to comply with AV limit.
 3. AVG: $VBW=1/T_{on}$, where: T_{on} is the transmitting duration.
 4. For the transmitting duration, please refer to clause 7.1.
 5. Only the worst data was recorded, if it complies with the limit, the other emissions deemed to comply with the limit.

UNII-3 BAND

RESTRICTED BANDEDGE (LOW CHANNEL, VERTICAL)

PEAK

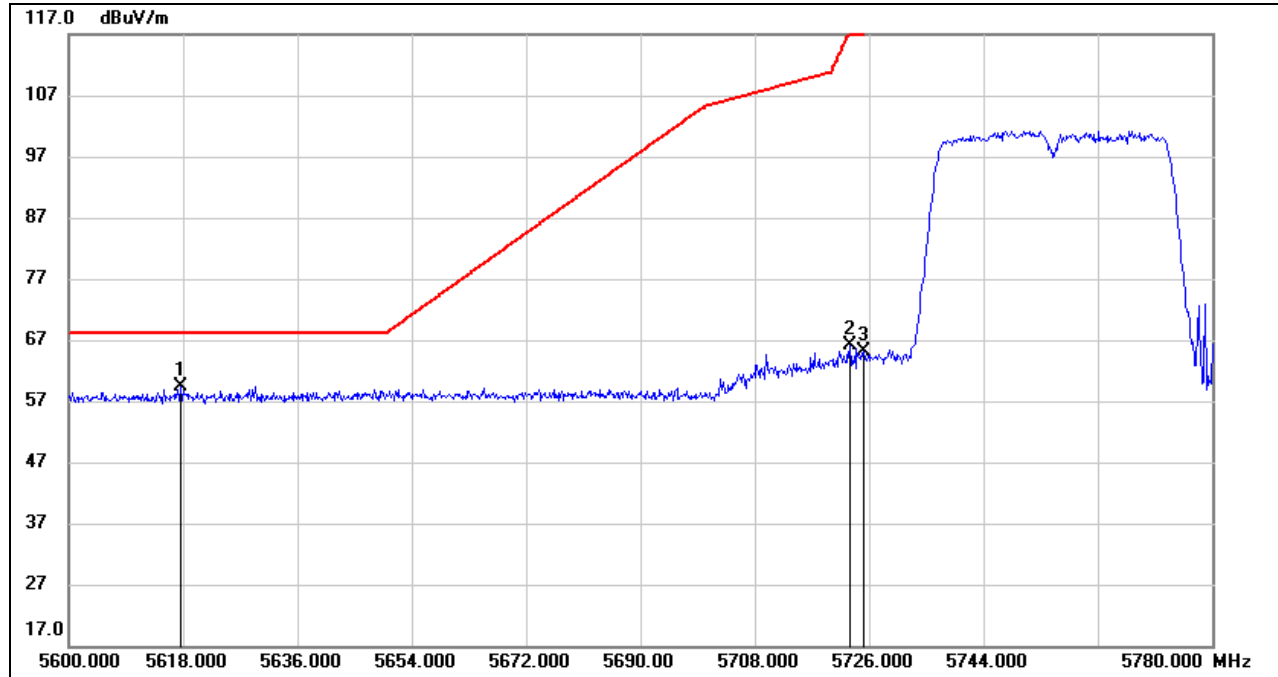

No.	Frequency (MHz)	Reading (dBuV)	Correct (dB/m)	Result (dBuV/m)	Limit (dBuV/m)	Margin (dB)	Remark
1	5617.640	17.76	41.70	59.46	68.20	-8.74	peak
2	5722.940	24.49	41.66	66.15	117.50	-51.35	peak
3	5725.000	23.38	41.67	65.05	122.20	-57.15	peak

- Note:
1. Measurement = Reading Level + Correct Factor.
 2. If Peak Result complies with AV limit, AV Result is deemed to comply with AV limit.
 3. Peak: Peak detector.
 4. Only the worst data was recorded, if it complies with the limit, the other emissions deemed to comply with the limit.
 5. All the polarities (vertical and horizontal) had been tested, only the worst data was recorded in the report.



RESTRICTED BANDEDGE (HIGH CHANNEL, VERTICAL)

PEAK

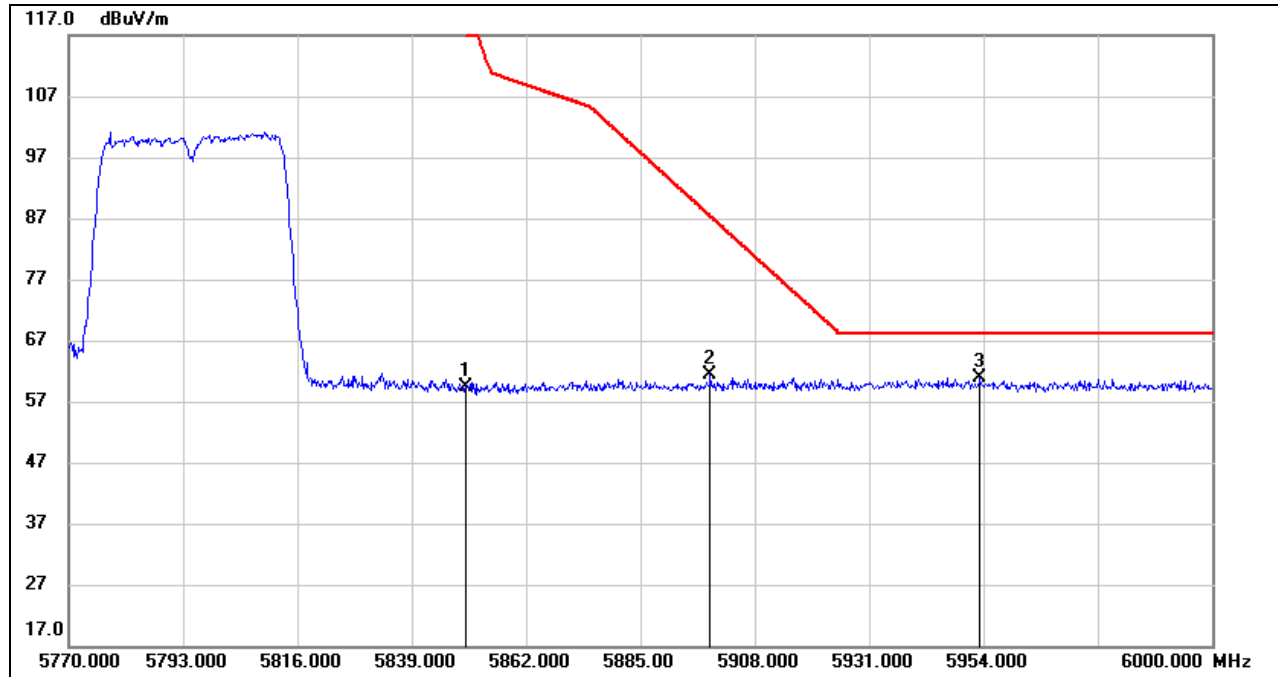

No.	Frequency (MHz)	Reading (dBuV)	Correct (dB/m)	Result (dBuV/m)	Limit (dBuV/m)	Margin (dB)	Remark
1	5850.000	16.78	42.52	59.30	122.20	-62.90	peak
2	5899.030	18.47	43.02	61.49	87.38	-25.89	peak
3	5953.310	18.05	42.78	60.83	68.20	-7.37	peak

- Note: 1. Measurement = Reading Level + Correct Factor.
 2. If Peak Result complies with AV limit, AV Result is deemed to comply with AV limit.
 3. Peak: Peak detector.
 4. Only the worst data was recorded, if it complies with the limit, the other emissions deemed to comply with the limit.
 5. All the polarities (vertical and horizontal) had been tested, only the worst data was recorded in the report.

8.1.4. 802.11ac VHT80 MIMO MODE

UNII-1 BAND

RESTRICTED BANDEDGE (LOW CHANNEL, VERTICAL)

PEAK

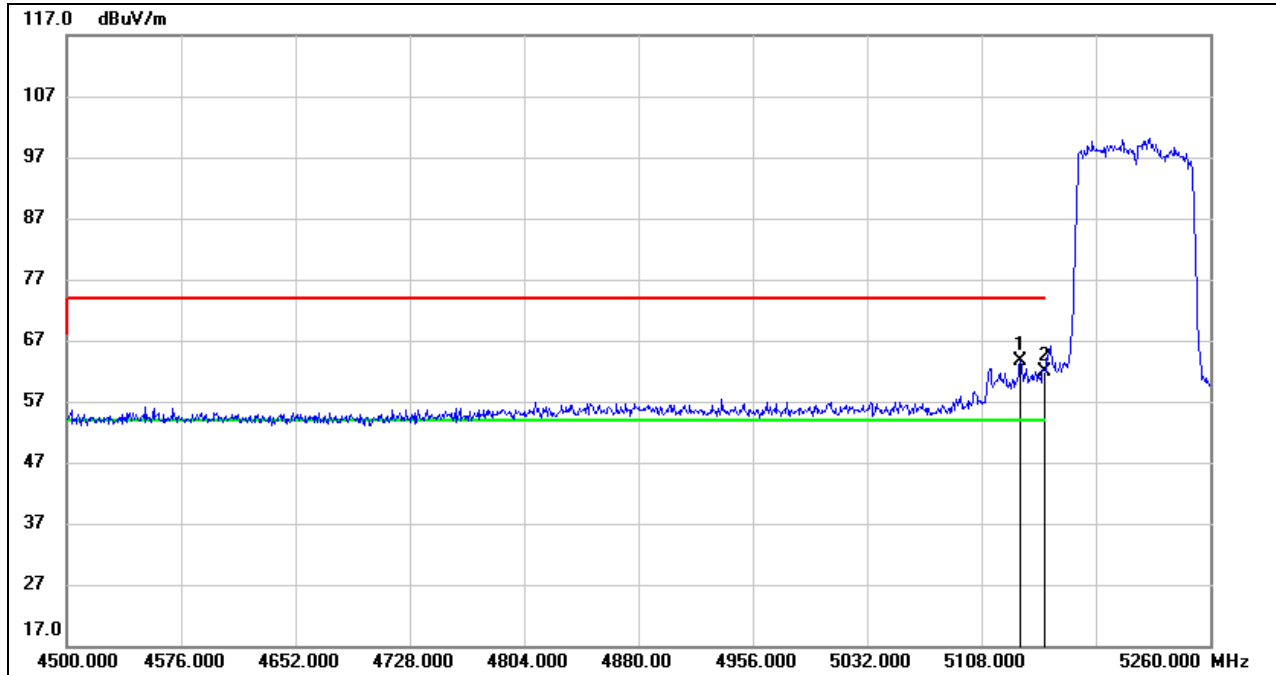

No.	Frequency (MHz)	Reading (dBuV)	Correct (dB/m)	Result (dBuV/m)	Limit (dBuV/m)	Margin (dB)	Remark
1	5133.840	22.63	41.04	63.67	74.00	-10.33	peak
2	5150.000	20.72	41.19	61.91	74.00	-12.09	peak

- Note:
1. Measurement = Reading Level + Correct Factor.
 2. If Peak Result complies with AV limit, AV Result is deemed to comply with AV limit.
 3. Peak: Peak detector.
 4. Only the worst data was recorded, if it complies with the limit, the other emissions deemed to comply with the limit.
 5. All the polarities (vertical and horizontal) had been tested, only the worst data was recorded in the report.



AVG

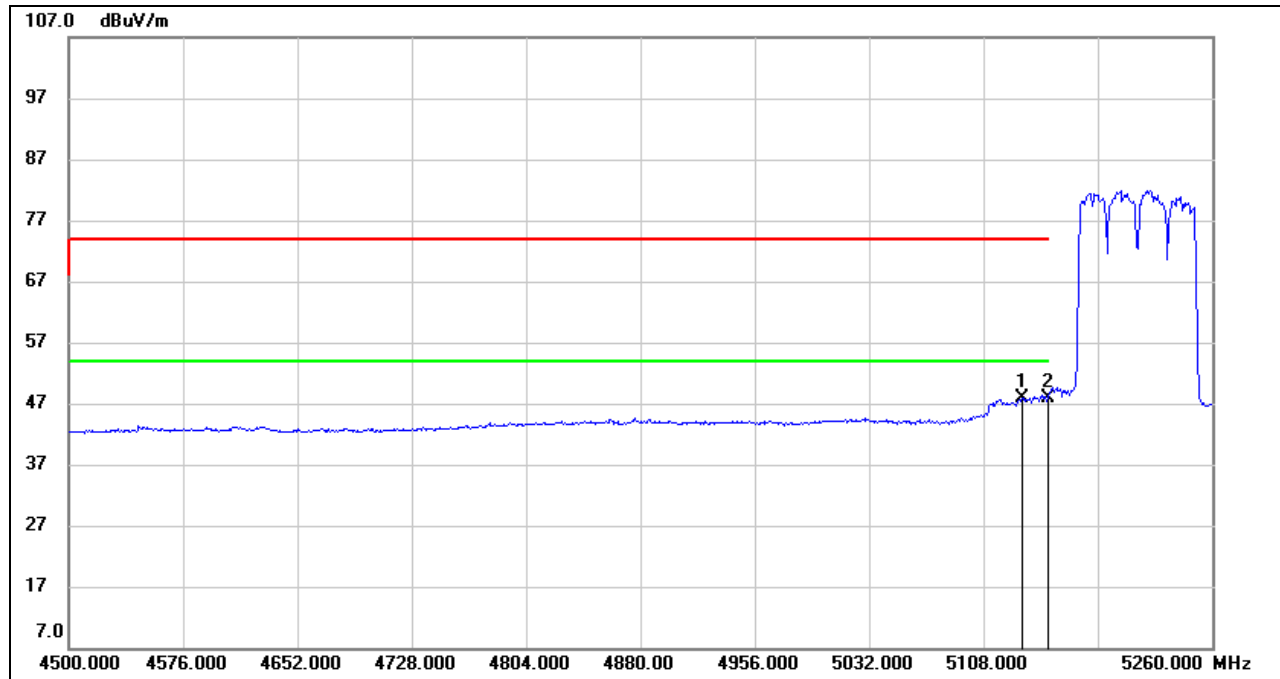

No.	Frequency (MHz)	Reading (dBuV)	Correct (dB/m)	Result (dBuV/m)	Limit (dBuV/m)	Margin (dB)	Remark
1	5133.840	6.89	41.04	47.93	54.00	-6.07	AVG
2	5150.000	6.63	41.19	47.82	54.00	-6.18	AVG

- Note:
1. Measurement = Reading Level + Correct Factor.
 2. If Peak Result complies with AV limit, AV Result is deemed to comply with AV limit.
 3. AVG: $VBW=1/Ton$, where: Ton is the transmitting duration.
 4. For the transmitting duration, please refer to clause 7.1.
 5. Only the worst data was recorded, if it complies with the limit, the other emissions deemed to comply with the limit.

UNII-3 BAND

RESTRICTED BANDEDGE (LOW CHANNEL, VERTICAL)

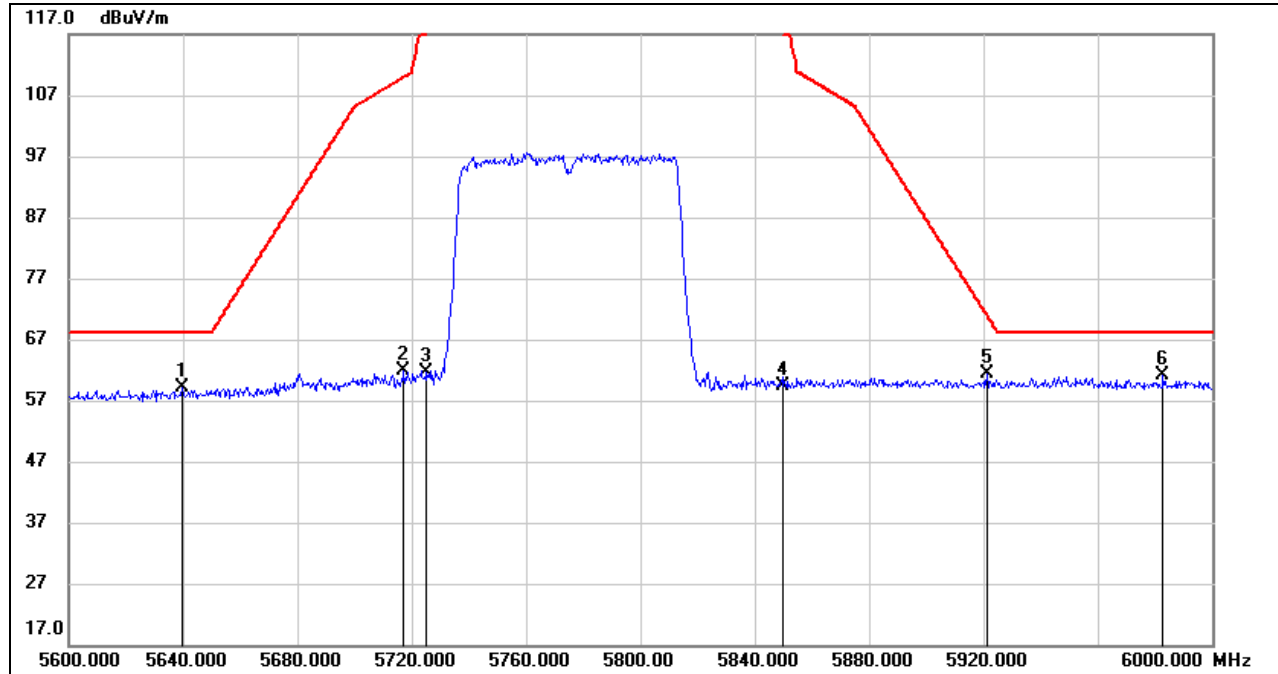

No.	Frequency (MHz)	Reading (dBuV)	Correct (dB/m)	Result (dBuV/m)	Limit (dBuV/m)	Margin (dB)	Remark
1	5639.600	17.38	41.66	59.04	68.20	-9.16	peak
2	5717.200	20.20	41.63	61.83	110.02	-48.19	peak
3	5725.000	19.87	41.67	61.54	122.20	-60.66	peak
4	5850.000	16.79	42.52	59.31	122.20	-62.89	peak
5	5921.200	18.34	42.93	61.27	71.00	-9.73	peak
6	5982.800	18.55	42.64	61.19	68.20	-7.01	peak

Note: 1. Measurement = Reading Level + Correct Factor.
 2. If Peak Result complies with AV limit, AV Result is deemed to comply with AV limit.
 3. Peak: Peak detector.
 4. Only the worst data was recorded, if it complies with the limit, the other emissions deemed to comply with the limit.
 5. All the polarities (vertical and horizontal) had been tested, only the worst data was recorded in the report.

8.2. SPURIOUS EMISSIONS (1 GHz ~ 7 GHz)

8.2.1. 802.11a SISO MODE

UNII-1 BAND

HARMONICS AND SPURIOUS EMISSIONS (LOW CHANNEL, HORIZONTAL)

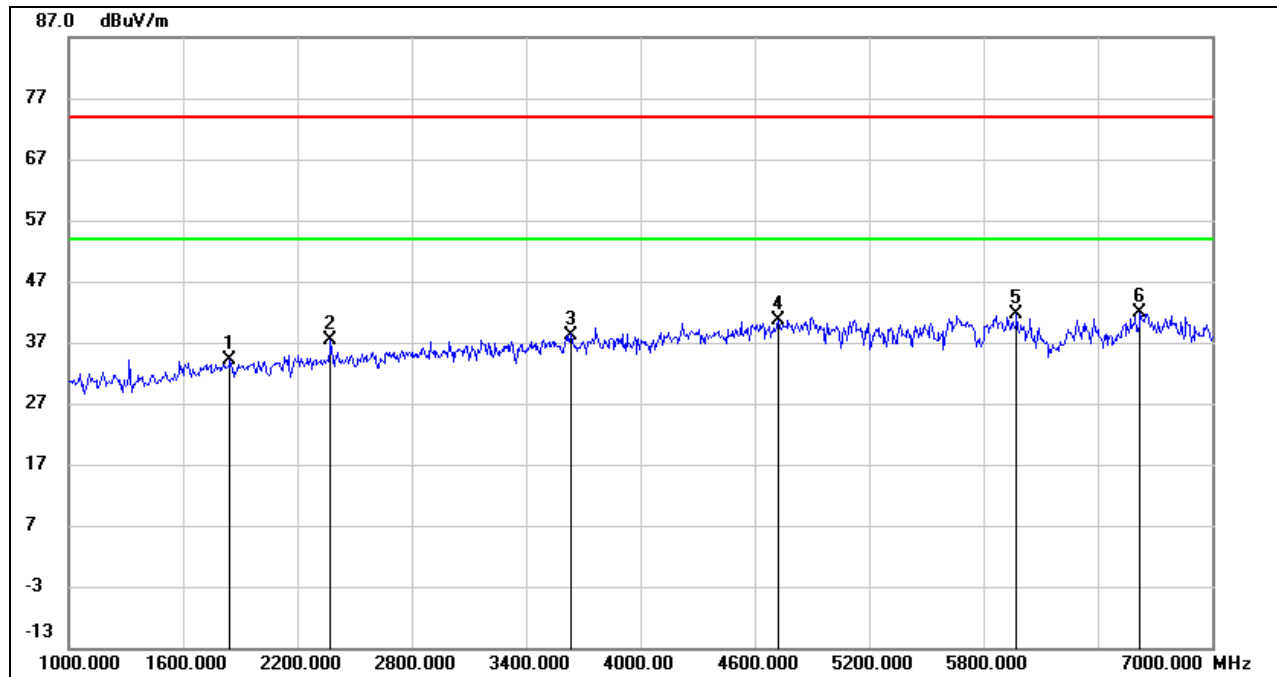

No.	Frequency (MHz)	Reading (dBuV)	Correct (dB/m)	Result (dBuV/m)	Limit (dBuV/m)	Margin (dB)	Remark
1	1846.000	44.24	-10.09	34.15	74.00	-39.85	peak
2	2374.000	45.77	-8.48	37.29	74.00	-36.71	peak
3	3634.000	42.28	-4.03	38.25	74.00	-35.75	peak
4	4720.000	40.48	0.12	40.60	74.00	-33.40	peak
5	5974.000	38.41	3.20	41.61	74.00	-32.39	peak
6	6622.000	36.28	5.51	41.79	74.00	-32.21	peak

Note: 1. Measurement = Reading Level + Correct Factor.

2. If Peak Result complies with AV limit, AV Result is deemed to comply with AV limit.

3. Peak: Peak detector.

4. AVG: $VBW=1/Ton$, where: Ton is the transmitting duration.

5. For the transmitting duration, please refer to clause 7.1.

6. Filter losses were only considered in the spurious frequency bands and the authorized band was not corrected for Band reject filter losses.

7. Proper operation of the transmitter prior to adding the filter to the measurement chain.

8. Owing to the highest peak level of unwanted emission out of the restricted bands complies with the lowest limit(54dBuV/m), so all the test point was deemed to comply with the limits list in the standard.

HARMONICS AND SPURIOUS EMISSIONS (LOW CHANNEL, VERTICAL)

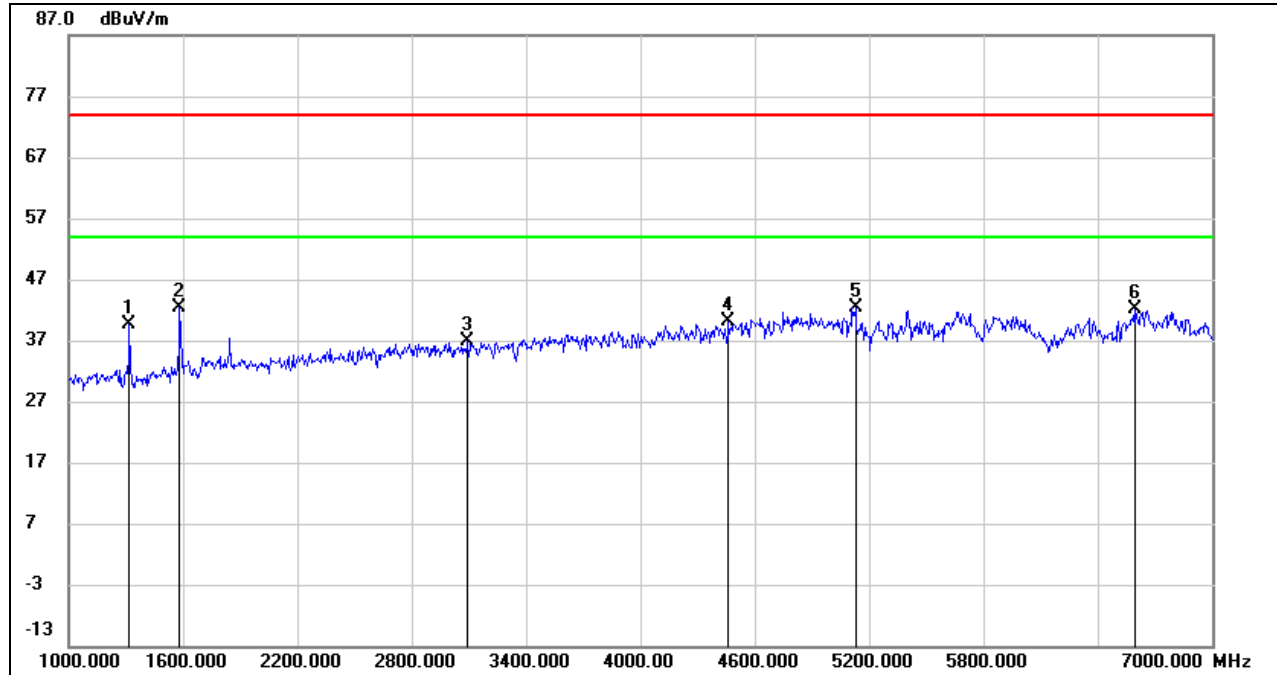

No.	Frequency (MHz)	Reading (dBuV)	Correct (dB/m)	Result (dBuV/m)	Limit (dBuV/m)	Margin (dB)	Remark
1	1318.000	52.36	-12.83	39.53	74.00	-34.47	peak
2	1582.000	54.15	-11.68	42.47	74.00	-31.53	peak
3	3094.000	42.19	-5.43	36.76	74.00	-37.24	peak
4	4462.000	41.57	-1.47	40.10	74.00	-33.90	peak
5	5128.000	40.66	1.67	42.33	74.00	-31.67	peak
6	6592.000	36.68	5.45	42.13	74.00	-31.87	peak

- Note:
1. Measurement = Reading Level + Correct Factor.
 2. If Peak Result complies with AV limit, AV Result is deemed to comply with AV limit.
 3. Peak: Peak detector.
 4. AVG: $VBW=1/Ton$, where: Ton is the transmitting duration.
 5. For the transmitting duration, please refer to clause 7.1.
 6. Filter losses were only considered in the spurious frequency bands and the authorized band was not corrected for Band reject filter losses.
 7. Proper operation of the transmitter prior to adding the filter to the measurement chain.
 8. Owing to the highest peak level of unwanted emission out of the restricted bands complies with the lowest limit(54dBuV/m), so all the test point was deemed to comply with the limits list in the standard.

HARMONICS AND SPURIOUS EMISSIONS (MID CHANNEL, HORIZONTAL)

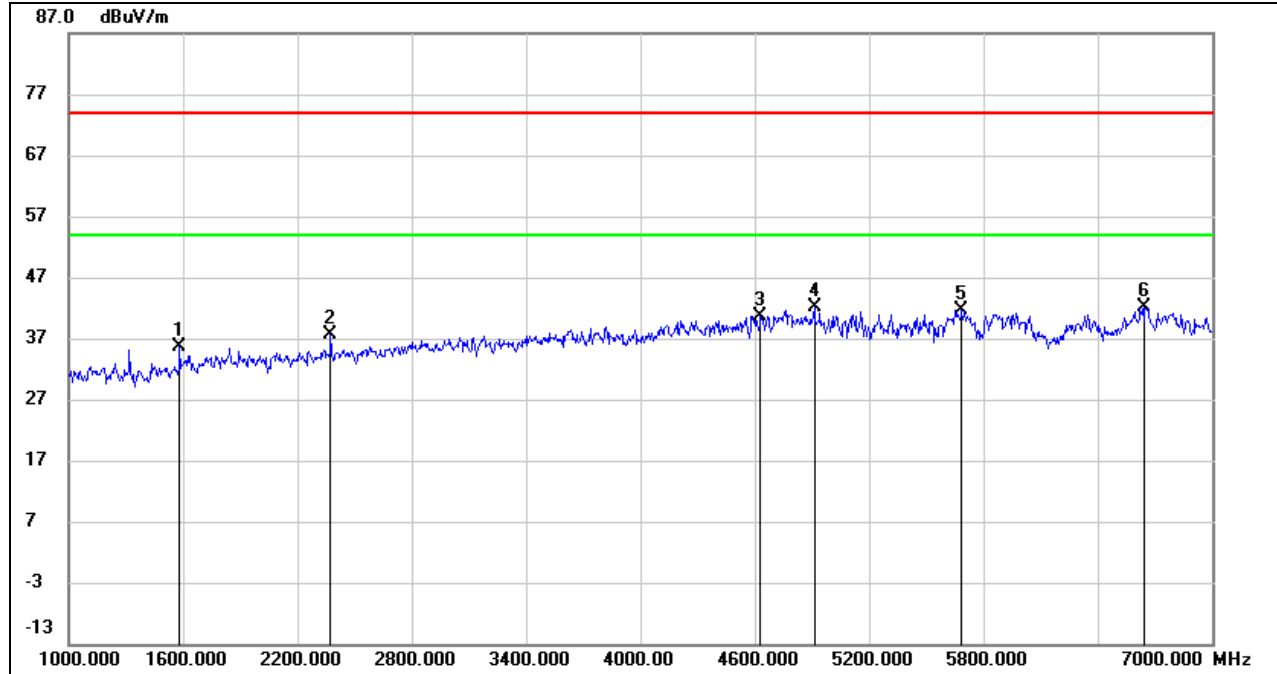

No.	Frequency (MHz)	Reading (dBuV)	Correct (dB/m)	Result (dBuV/m)	Limit (dBuV/m)	Margin (dB)	Remark
1	1582.000	47.34	-11.68	35.66	74.00	-38.34	peak
2	2374.000	46.17	-8.48	37.69	74.00	-36.31	peak
3	4630.000	41.07	-0.38	40.69	74.00	-33.31	peak
4	4912.000	41.33	0.77	42.10	74.00	-31.90	peak
5	5686.000	39.21	2.47	41.68	74.00	-32.32	peak
6	6646.000	36.69	5.51	42.20	74.00	-31.80	peak

- Note: 1. Measurement = Reading Level + Correct Factor.
 2. If Peak Result complies with AV limit, AV Result is deemed to comply with AV limit.
 3. Peak: Peak detector.
 4. AVG: $VBW=1/Ton$, where: Ton is the transmitting duration.
 5. For the transmitting duration, please refer to clause 7.1.
 6. Filter losses were only considered in the spurious frequency bands and the authorized band was not corrected for Band reject filter losses.
 7. Proper operation of the transmitter prior to adding the filter to the measurement chain.
 8. Owing to the highest peak level of unwanted emission out of the restricted bands complies with the lowest limit(54dBuV/m), so all the test point was deemed to comply with the limits list in the standard.

HARMONICS AND SPURIOUS EMISSIONS (MID CHANNEL, VERTICAL)

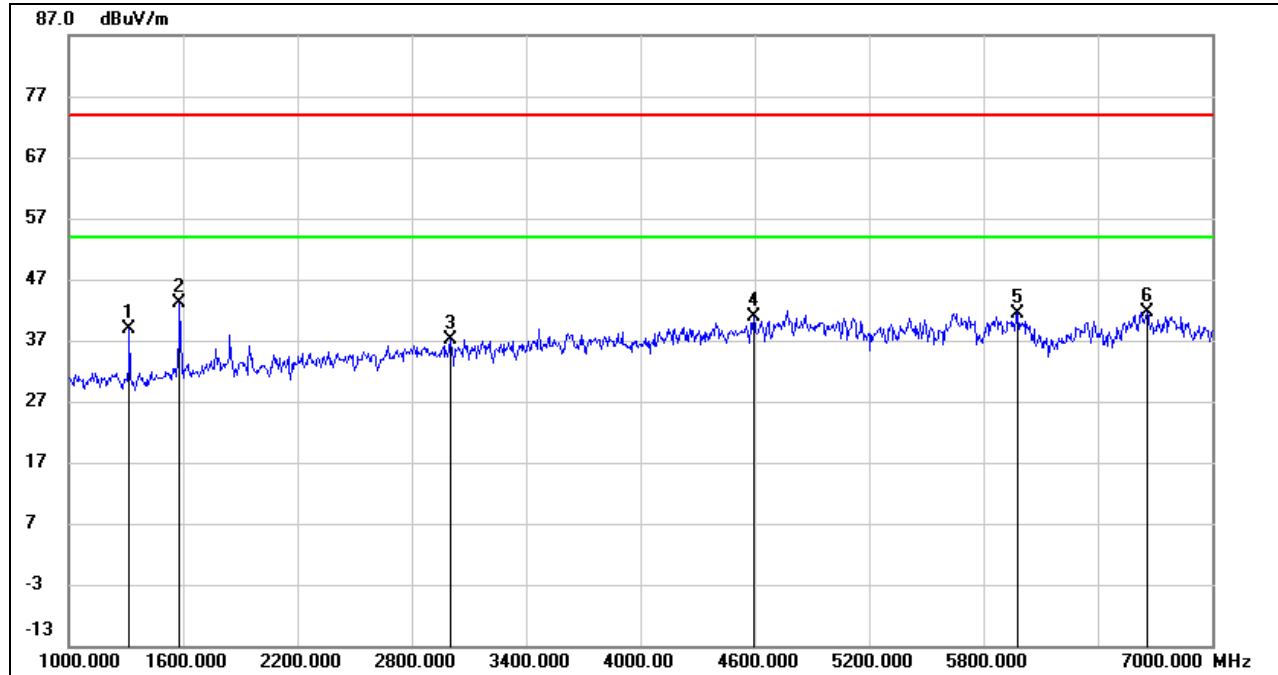

No.	Frequency (MHz)	Reading (dBuV)	Correct (dB/m)	Result (dBuV/m)	Limit (dBuV/m)	Margin (dB)	Remark
1	1318.000	51.70	-12.83	38.87	74.00	-35.13	peak
2	1582.000	54.72	-11.68	43.04	74.00	-30.96	peak
3	3004.000	42.73	-5.59	37.14	74.00	-36.86	peak
4	4594.000	41.51	-0.60	40.91	74.00	-33.09	peak
5	5980.000	38.23	3.22	41.45	74.00	-32.55	peak
6	6658.000	36.15	5.51	41.66	74.00	-32.34	peak

- Note:
1. Measurement = Reading Level + Correct Factor.
 2. If Peak Result complies with AV limit, AV Result is deemed to comply with AV limit.
 3. Peak: Peak detector.
 4. AVG: $VBW=1/Ton$, where: Ton is the transmitting duration.
 5. For the transmitting duration, please refer to clause 7.1.
 6. Filter losses were only considered in the spurious frequency bands and the authorized band was not corrected for Band reject filter losses.
 7. Proper operation of the transmitter prior to adding the filter to the measurement chain.
 8. Owing to the highest peak level of unwanted emission out of the restricted bands complies with the lowest limit(54dBuV/m), so all the test point was deemed to comply with the limits list in the standard.

HARMONICS AND SPURIOUS EMISSIONS (HIGH CHANNEL, HORIZONTAL)

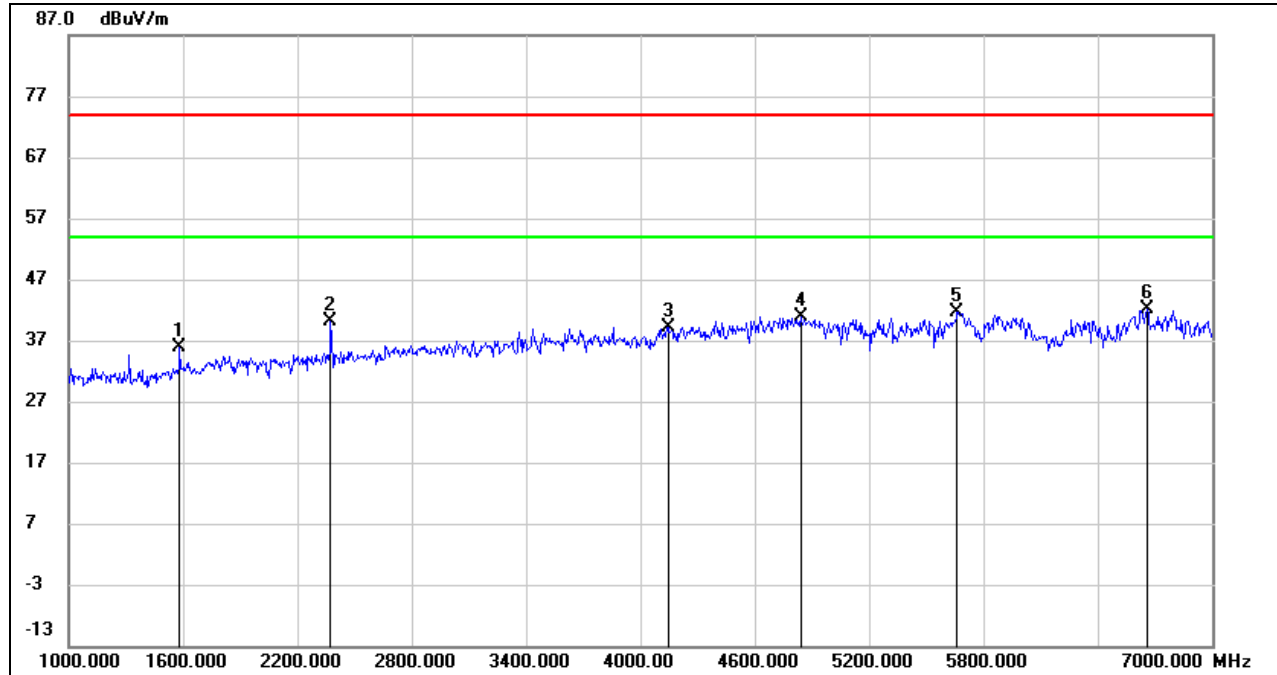

No.	Frequency (MHz)	Reading (dBuV)	Correct (dB/m)	Result (dBuV/m)	Limit (dBuV/m)	Margin (dB)	Remark
1	1582.000	47.59	-11.68	35.91	74.00	-38.09	peak
2	2374.000	48.64	-8.48	40.16	74.00	-33.84	peak
3	4144.000	41.46	-2.21	39.25	74.00	-34.75	peak
4	4840.000	40.15	0.65	40.80	74.00	-33.20	peak
5	5662.000	39.17	2.47	41.64	74.00	-32.36	peak
6	6658.000	36.51	5.51	42.02	74.00	-31.98	peak

- Note:
1. Measurement = Reading Level + Correct Factor.
 2. If Peak Result complies with AV limit, AV Result is deemed to comply with AV limit.
 3. Peak: Peak detector.
 4. AVG: $VBW=1/Ton$, where: Ton is the transmitting duration.
 5. For the transmitting duration, please refer to clause 7.1.
 6. Filter losses were only considered in the spurious frequency bands and the authorized band was not corrected for Band reject filter losses.
 7. Proper operation of the transmitter prior to adding the filter to the measurement chain.
 8. Owing to the highest peak level of unwanted emission out of the restricted bands complies with the lowest limit(54dBuV/m), so all the test point was deemed to comply with the limits list in the standard.

HARMONICS AND SPURIOUS EMISSIONS (HIGH CHANNEL, VERTICAL)

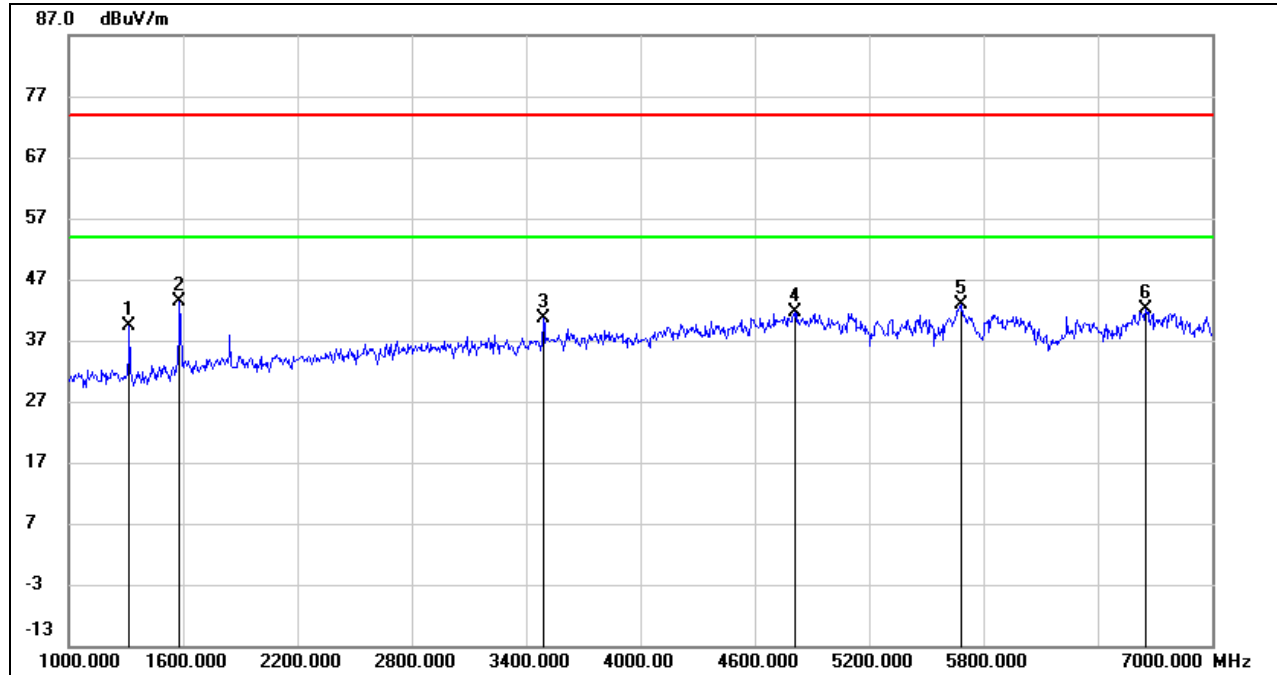

No.	Frequency (MHz)	Reading (dBuV)	Correct (dB/m)	Result (dBuV/m)	Limit (dBuV/m)	Margin (dB)	Remark
1	1318.000	52.09	-12.83	39.26	74.00	-34.74	peak
2	1582.000	54.97	-11.68	43.29	74.00	-30.71	peak
3	3490.000	45.30	-4.75	40.55	74.00	-33.45	peak
4	4810.000	40.93	0.60	41.53	74.00	-32.47	peak
5	5686.000	40.50	2.47	42.97	74.00	-31.03	peak
6	6652.000	36.49	5.52	42.01	74.00	-31.99	peak

Note: 1. Measurement = Reading Level + Correct Factor.

2. If Peak Result complies with AV limit, AV Result is deemed to comply with AV limit.

3. Peak: Peak detector.

4. AVG: $VBW=1/Ton$, where: Ton is the transmitting duration.

5. For the transmitting duration, please refer to clause 7.1.

6. Filter losses were only considered in the spurious frequency bands and the authorized band was not corrected for Band reject filter losses.

7. Proper operation of the transmitter prior to adding the filter to the measurement chain.

8. Owing to the highest peak level of unwanted emission out of the restricted bands complies with the lowest limit(54dBuV/m), so all the test point was deemed to comply with the limits list in the standard.

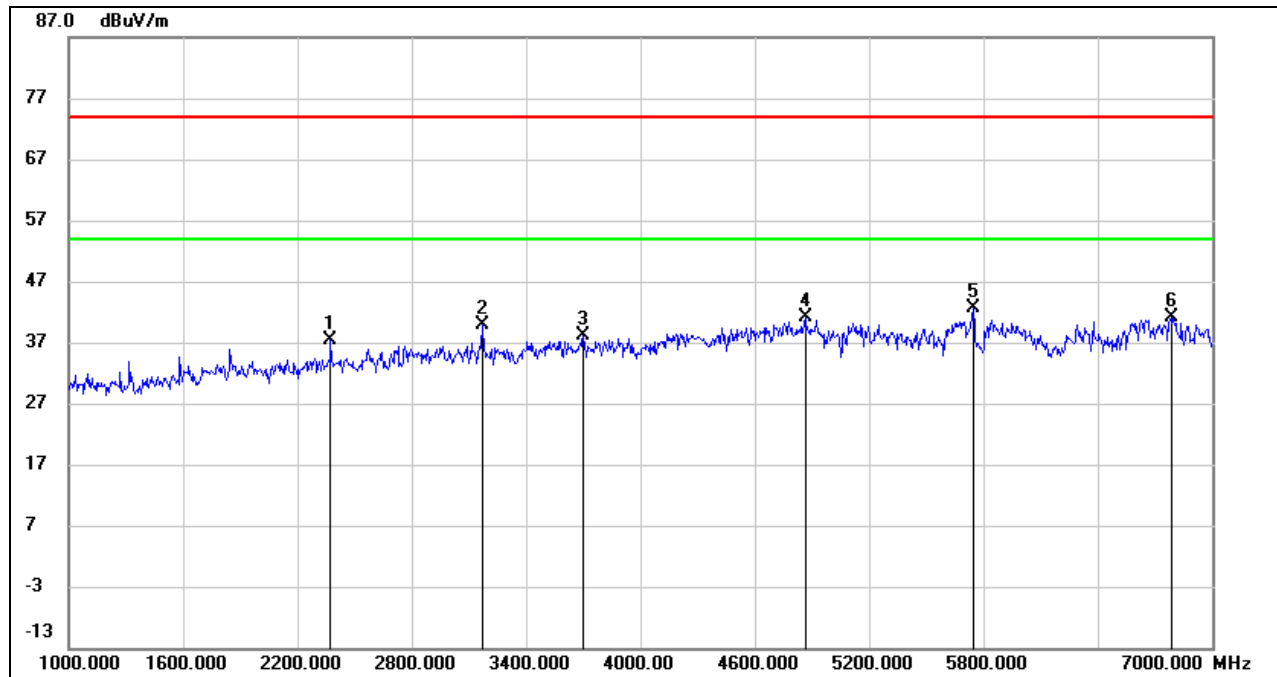
**UNII-3 BAND****HARMONICS AND SPURIOUS EMISSIONS (LOW CHANNEL, HORIZONTAL)**

No.	Frequency (MHz)	Reading (dBuV)	Correct (dB/m)	Result (dBuV/m)	Limit (dBuV/m)	Margin (dB)	Remark
1	2374.000	45.82	-8.48	37.34	74.00	-36.66	peak
2	3172.000	45.14	-5.30	39.84	74.00	-34.16	peak
3	3700.000	41.89	-3.72	38.17	74.00	-35.83	peak
4	4864.000	40.34	0.69	41.03	74.00	-32.97	peak
5	5745.000	40.11	2.49	42.60	74.00	-31.40	peak
6	6784.000	35.69	5.56	41.25	74.00	-32.75	peak

Note: 1. Measurement = Reading Level + Correct Factor.

2. If Peak Result complies with AV limit, AV Result is deemed to comply with AV limit.

3. Peak: Peak detector.

4. AVG: $VBW=1/Ton$, where: Ton is the transmitting duration.

5. For the transmitting duration, please refer to clause 7.1.

6. Filter losses were only considered in the spurious frequency bands and the authorized band was not corrected for Band reject filter losses.

7. Proper operation of the transmitter prior to adding the filter to the measurement chain.

8. Owing to the highest peak level of unwanted emission out of the restricted bands complies with the lowest limit(54dBuV/m), so all the test point was deemed to comply with the limits list in the standard.

HARMONICS AND SPURIOUS EMISSIONS (LOW CHANNEL, VERTICAL)

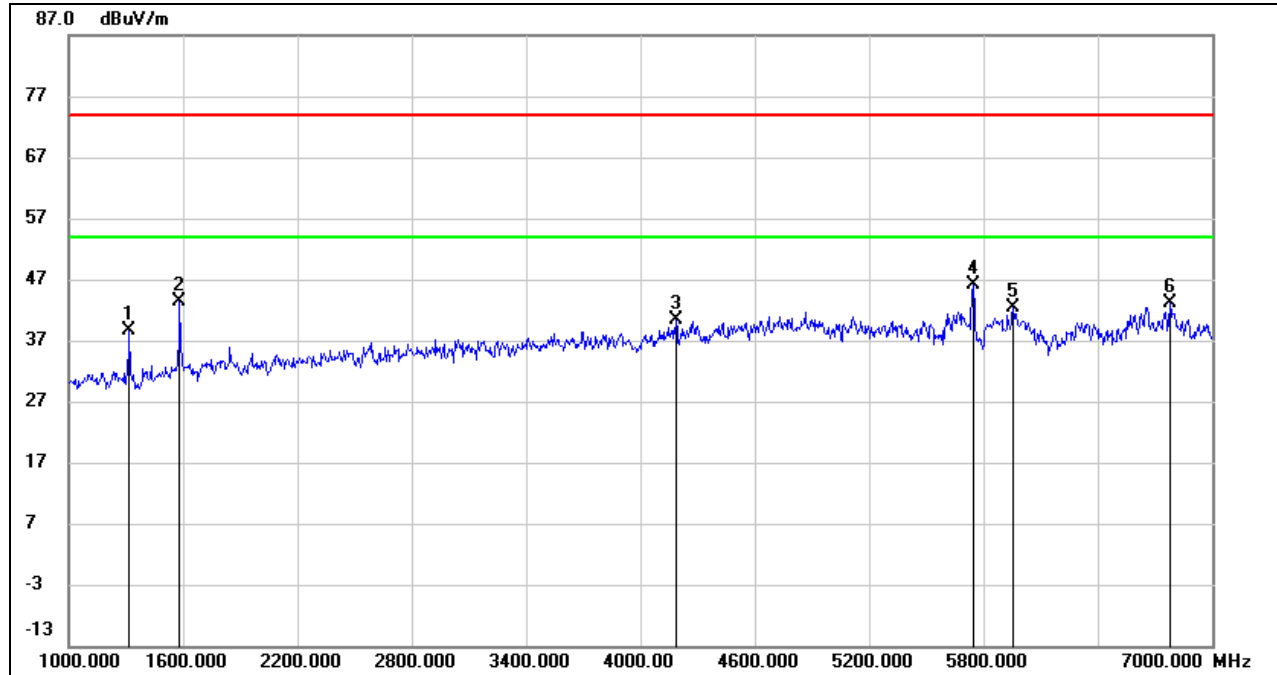

No.	Frequency (MHz)	Reading (dBuV)	Correct (dB/m)	Result (dBuV/m)	Limit (dBuV/m)	Margin (dB)	Remark
1	1318.000	51.57	-12.83	38.74	74.00	-35.26	peak
2	1582.000	55.05	-11.68	43.37	74.00	-30.63	peak
3	4186.000	42.08	-1.81	40.27	74.00	-33.73	peak
4	5745.000	43.60	2.49	46.09	74.00	-27.91	peak
5	5956.000	39.30	3.13	42.43	74.00	-31.57	peak
6	6778.000	37.62	5.56	43.18	74.00	-30.82	peak

Note: 1. Measurement = Reading Level + Correct Factor.

2. If Peak Result complies with AV limit, AV Result is deemed to comply with AV limit.

3. Peak: Peak detector.

4. AVG: $VBW=1/Ton$, where: Ton is the transmitting duration.

5. For the transmitting duration, please refer to clause 7.1.

6. Filter losses were only considered in the spurious frequency bands and the authorized band was not corrected for Band reject filter losses.

7. Proper operation of the transmitter prior to adding the filter to the measurement chain.

8. Owing to the highest peak level of unwanted emission out of the restricted bands complies with the lowest limit(54dBuV/m), so all the test point was deemed to comply with the limits list in the standard.

HARMONICS AND SPURIOUS EMISSIONS (MID CHANNEL, HORIZONTAL)

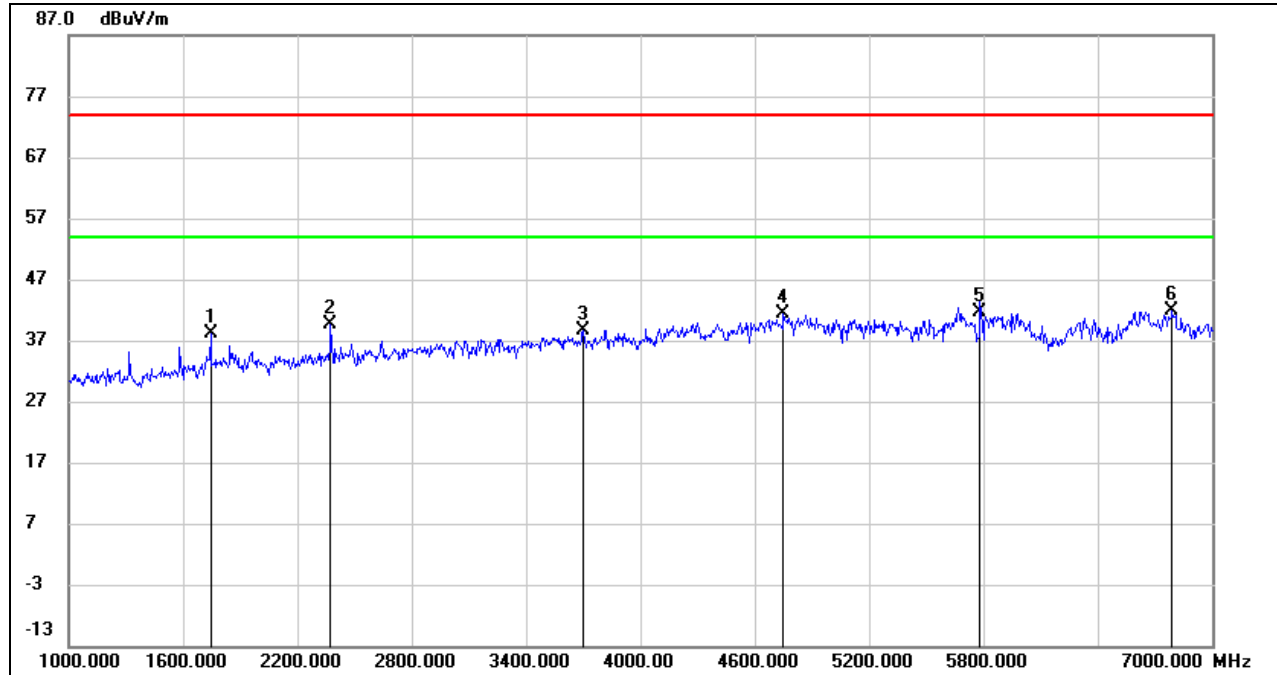

No.	Frequency (MHz)	Reading (dBuV)	Correct (dB/m)	Result (dBuV/m)	Limit (dBuV/m)	Margin (dB)	Remark
1	1744.000	48.68	-10.47	38.21	74.00	-35.79	peak
2	2374.000	48.06	-8.48	39.58	74.00	-34.42	peak
3	3700.000	42.47	-3.72	38.75	74.00	-35.25	peak
4	4750.000	40.98	0.30	41.28	74.00	-32.72	peak
5	5785.000	39.22	2.50	41.72	74.00	-32.28	peak
6	6790.000	36.35	5.57	41.92	74.00	-32.08	peak

Note: 1. Measurement = Reading Level + Correct Factor.

2. If Peak Result complies with AV limit, AV Result is deemed to comply with AV limit.

3. Peak: Peak detector.

4. AVG: $VBW=1/Ton$, where: Ton is the transmitting duration.

5. For the transmitting duration, please refer to clause 7.1.

6. Filter losses were only considered in the spurious frequency bands and the authorized band was not corrected for Band reject filter losses.

7. Proper operation of the transmitter prior to adding the filter to the measurement chain.

8. Owing to the highest peak level of unwanted emission out of the restricted bands complies with the lowest limit(54dBuV/m), so all the test point was deemed to comply with the limits list in the standard.



HARMONICS AND SPURIOUS EMISSIONS (MID CHANNEL, VERTICAL)

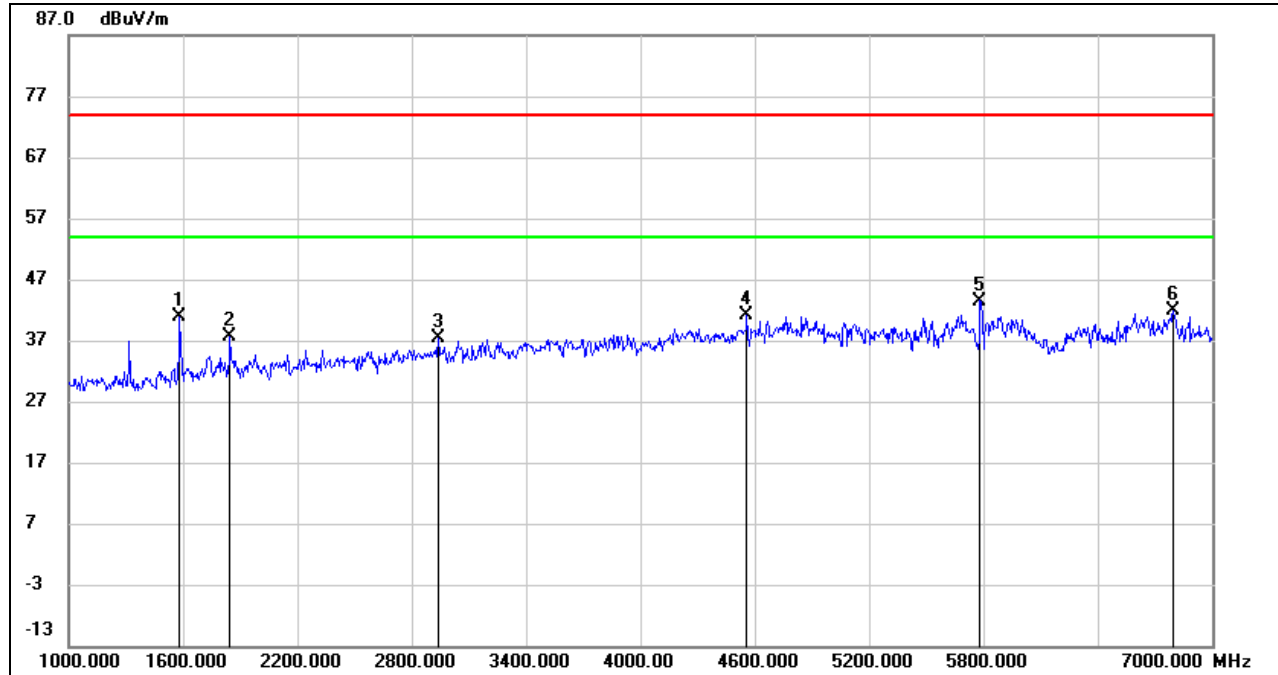

No.	Frequency (MHz)	Reading (dBuV)	Correct (dB/m)	Result (dBuV/m)	Limit (dBuV/m)	Margin (dB)	Remark
1	1582.000	52.65	-11.68	40.97	74.00	-33.03	peak
2	1846.000	47.82	-10.09	37.73	74.00	-36.27	peak
3	2938.000	43.23	-5.89	37.34	74.00	-36.66	peak
4	4558.000	41.87	-0.84	41.03	74.00	-32.97	peak
5	5785.000	40.90	2.50	43.40	74.00	-30.60	peak
6	6796.000	36.37	5.57	41.94	74.00	-32.06	peak

- Note:
1. Measurement = Reading Level + Correct Factor.
 2. If Peak Result complies with AV limit, AV Result is deemed to comply with AV limit.
 3. Peak: Peak detector.
 4. AVG: $VBW=1/Ton$, where: Ton is the transmitting duration.
 5. For the transmitting duration, please refer to clause 7.1.
 6. Filter losses were only considered in the spurious frequency bands and the authorized band was not corrected for Band reject filter losses.
 7. Proper operation of the transmitter prior to adding the filter to the measurement chain.
 8. Owing to the highest peak level of unwanted emission out of the restricted bands complies with the lowest limit(54dBuV/m), so all the test point was deemed to comply with the limits list in the standard.

HARMONICS AND SPURIOUS EMISSIONS (HIGH CHANNEL, HORIZONTAL)

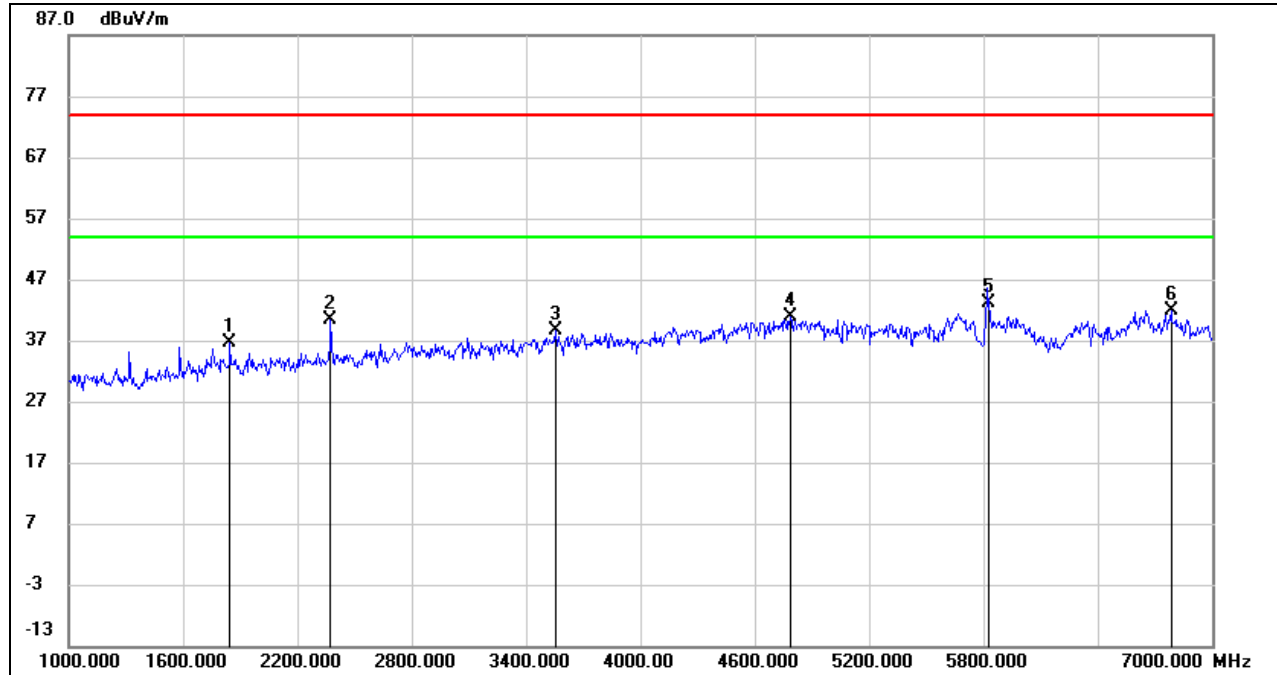

No.	Frequency (MHz)	Reading (dBuV)	Correct (dB/m)	Result (dBuV/m)	Limit (dBuV/m)	Margin (dB)	Remark
1	1846.000	46.79	-10.09	36.70	74.00	-37.30	peak
2	2374.000	48.82	-8.48	40.34	74.00	-33.66	peak
3	3556.000	43.11	-4.42	38.69	74.00	-35.31	peak
4	4786.000	40.29	0.51	40.80	74.00	-33.20	peak
5	5825.000	40.60	2.61	43.21	74.00	-30.79	peak
6	6784.000	36.25	5.56	41.81	74.00	-32.19	peak

Note: 1. Measurement = Reading Level + Correct Factor.

2. If Peak Result complies with AV limit, AV Result is deemed to comply with AV limit.

3. Peak: Peak detector.

4. AVG: $VBW=1/Ton$, where: Ton is the transmitting duration.

5. For the transmitting duration, please refer to clause 7.1.

6. Filter losses were only considered in the spurious frequency bands and the authorized band was not corrected for Band reject filter losses.

7. Proper operation of the transmitter prior to adding the filter to the measurement chain.

8. Owing to the highest peak level of unwanted emission out of the restricted bands complies with the lowest limit(54dBuV/m), so all the test point was deemed to comply with the limits list in the standard.

HARMONICS AND SPURIOUS EMISSIONS (HIGH CHANNEL, VERTICAL)

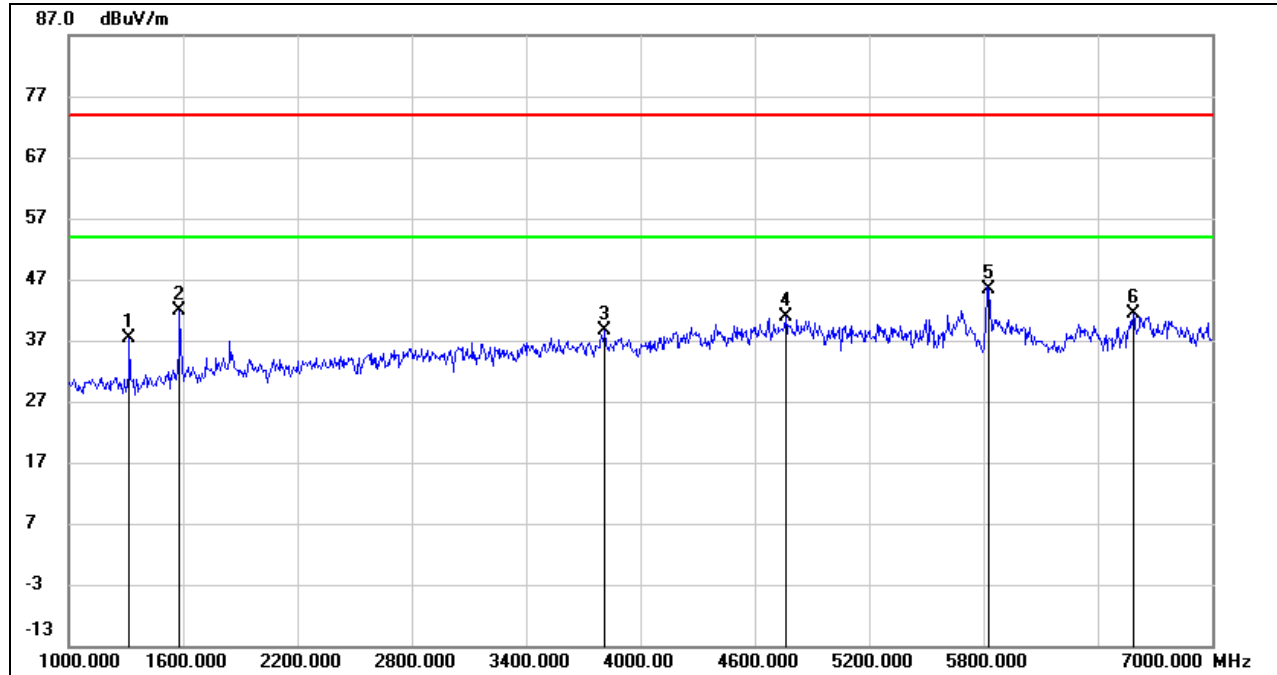

No.	Frequency (MHz)	Reading (dBuV)	Correct (dB/m)	Result (dBuV/m)	Limit (dBuV/m)	Margin (dB)	Remark
1	1318.000	50.20	-12.83	37.37	74.00	-36.63	peak
2	1582.000	53.60	-11.68	41.92	74.00	-32.08	peak
3	3814.000	42.02	-3.28	38.74	74.00	-35.26	peak
4	4762.000	40.45	0.38	40.83	74.00	-33.17	peak
5	5825.000	42.79	2.61	45.40	74.00	-28.60	peak
6	6586.000	36.03	5.41	41.44	74.00	-32.56	peak

Note: 1. Measurement = Reading Level + Correct Factor.

2. If Peak Result complies with AV limit, AV Result is deemed to comply with AV limit.

3. Peak: Peak detector.

4. AVG: $VBW=1/Ton$, where: Ton is the transmitting duration.

5. For the transmitting duration, please refer to clause 7.1.

6. Filter losses were only considered in the spurious frequency bands and the authorized band was not corrected for Band reject filter losses.

7. Proper operation of the transmitter prior to adding the filter to the measurement chain.

8. Owing to the highest peak level of unwanted emission out of the restricted bands complies with the lowest limit(54dBuV/m), so all the test point was deemed to comply with the limits list in the standard.

Note: All the channels and modes had been tested, but only the worst data was recorded in the report.

8.3. SPURIOUS EMISSIONS (7 GHz ~ 18 GHz)

8.3.1. 802.11a SISO MODE

UNII-1 BAND

HARMONICS AND SPURIOUS EMISSIONS (LOW CHANNEL, HORIZONTAL)

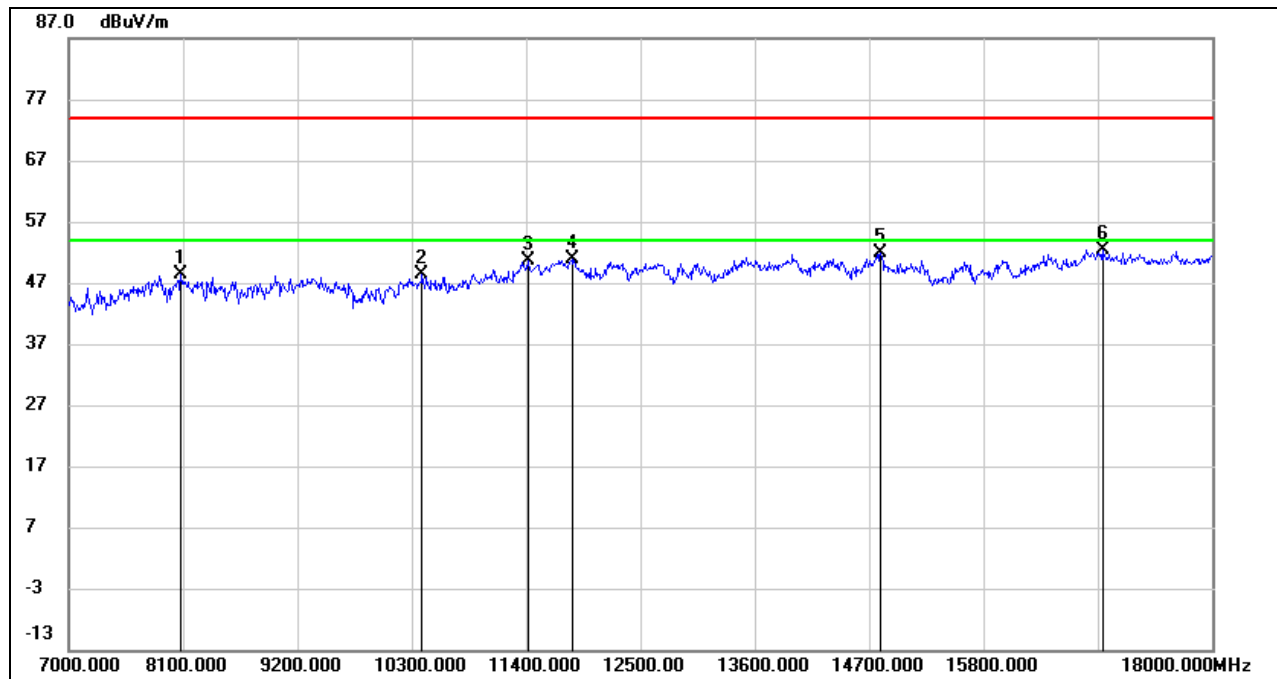

No.	Frequency (MHz)	Reading (dBuV)	Correct (dB/m)	Result (dBuV/m)	Limit (dBuV/m)	Margin (dB)	Remark
1	8078.000	38.63	9.83	48.46	74.00	-25.54	peak
2	10399.000	36.26	12.23	48.49	74.00	-25.51	peak
3	11422.000	35.90	14.73	50.63	74.00	-23.37	peak
4	11840.000	35.57	15.35	50.92	74.00	-23.08	peak
5	14810.000	33.90	17.97	51.87	74.00	-22.13	peak
6	16944.000	30.95	21.43	52.38	74.00	-21.62	peak

Note: 1. Measurement = Reading Level + Correct Factor.
 2. If Peak Result complies with AV limit, AV Result is deemed to comply with AV limit.
 3. Peak: Peak detector.
 4. AVG: $VBW=1/Ton$, where: Ton is the transmitting duration.
 5. For the transmitting duration, please refer to clause 7.1.
 6. Filter losses were only considered in the spurious frequency bands and the authorized band was not corrected for High Pass Filter losses.
 7. Proper operation of the transmitter prior to adding the filter to the measurement chain.
 8. Owing to the highest peak level of unwanted emission out of the restricted bands complies with the lowest limit(54dBuV/m), so all the test point was deemed to comply with the limits list in the standard.



HARMONICS AND SPURIOUS EMISSIONS (LOW CHANNEL, VERTICAL)

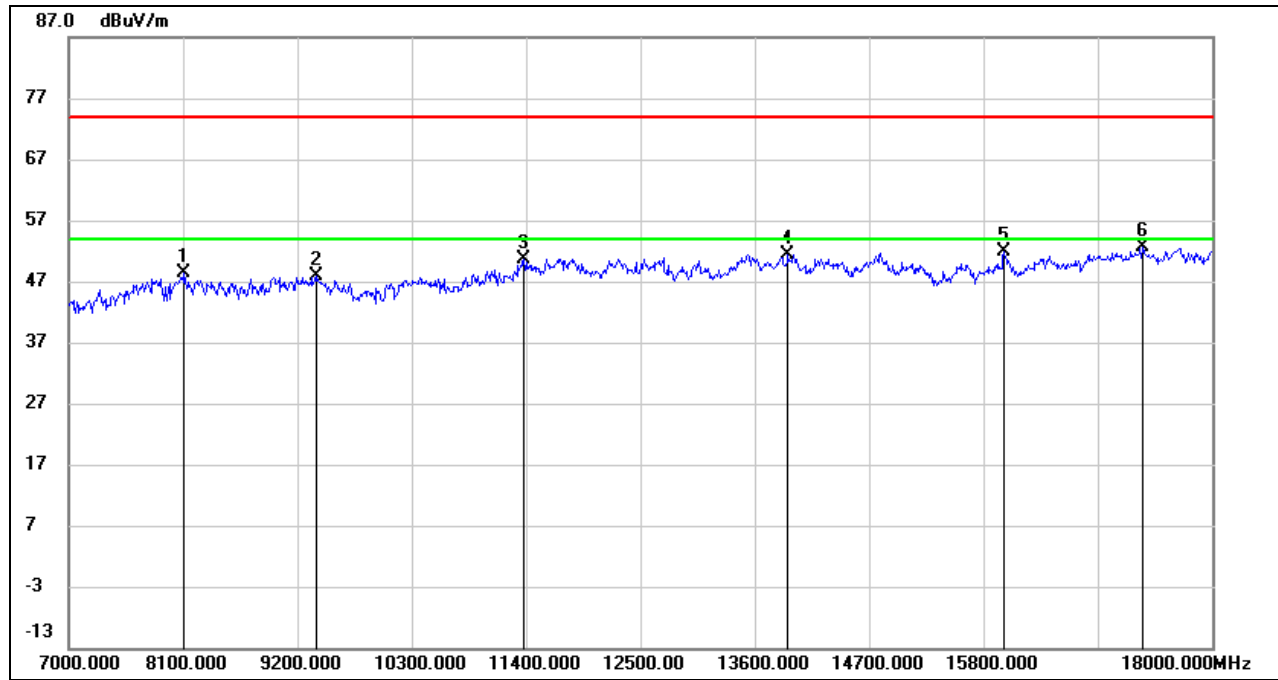

No.	Frequency (MHz)	Reading (dBuV)	Correct (dB/m)	Result (dBuV/m)	Limit (dBuV/m)	Margin (dB)	Remark
1	8111.000	38.31	10.14	48.45	74.00	-25.55	peak
2	9376.000	36.95	10.84	47.79	74.00	-26.21	peak
3	11378.000	36.13	14.55	50.68	74.00	-23.32	peak
4	13919.000	33.85	17.55	51.40	74.00	-22.60	peak
5	15998.000	33.45	18.42	51.87	74.00	-22.13	peak
6	17329.000	30.29	22.39	52.68	74.00	-21.32	peak

- Note: 1. Measurement = Reading Level + Correct Factor.
 2. If Peak Result complies with AV limit, AV Result is deemed to comply with AV limit.
 3. Peak: Peak detector.
 4. AVG: $VBW=1/Ton$, where: Ton is the transmitting duration.
 5. For the transmitting duration, please refer to clause 7.1.
 6. Filter losses were only considered in the spurious frequency bands and the authorized band was not corrected for High Pass Filter losses.
 7. Proper operation of the transmitter prior to adding the filter to the measurement chain.
 8. Owing to the highest peak level of unwanted emission out of the restricted bands complies with the lowest limit(54dBuV/m), so all the test point was deemed to comply with the limits list in the standard.

HARMONICS AND SPURIOUS EMISSIONS (MID CHANNEL, HORIZONTAL)

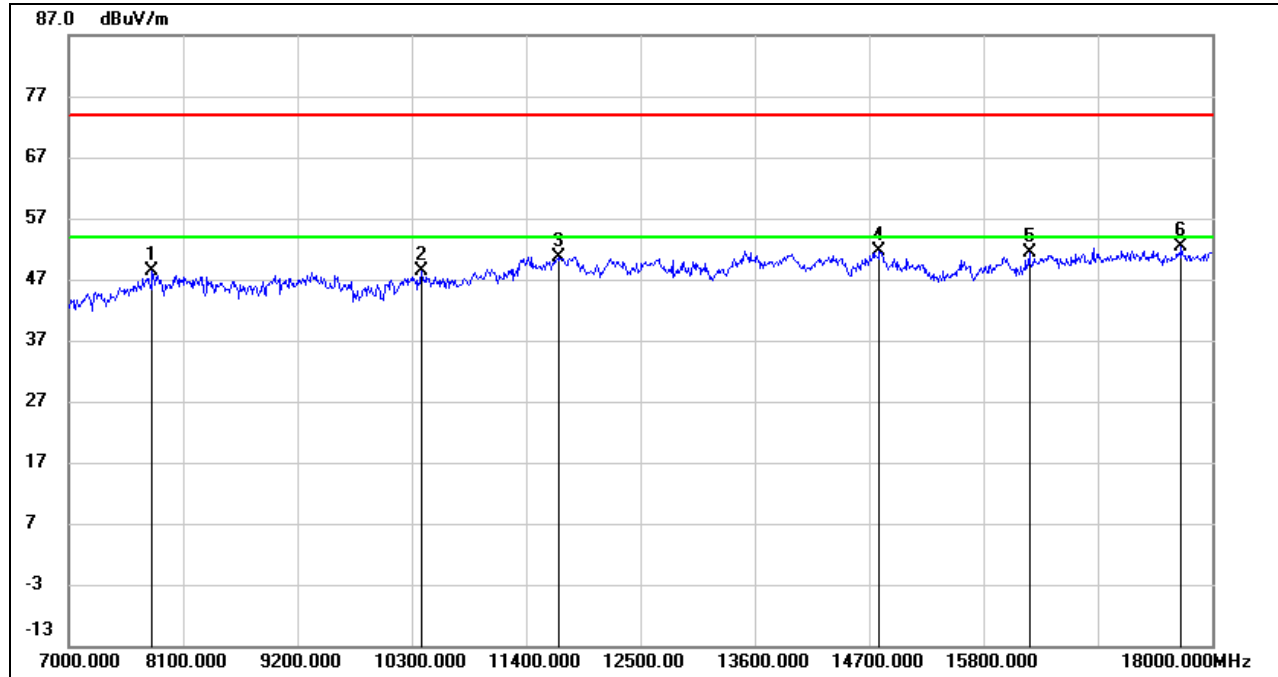

No.	Frequency (MHz)	Reading (dBuV)	Correct (dB/m)	Result (dBuV/m)	Limit (dBuV/m)	Margin (dB)	Remark
1	7803.000	39.02	9.33	48.35	74.00	-25.65	peak
2	10388.000	36.08	12.18	48.26	74.00	-25.74	peak
3	11719.000	35.36	15.33	50.69	74.00	-23.31	peak
4	14799.000	33.62	18.04	51.66	74.00	-22.34	peak
5	16240.000	32.23	19.04	51.27	74.00	-22.73	peak
6	17703.000	28.95	23.49	52.44	74.00	-21.56	peak

- Note:
1. Measurement = Reading Level + Correct Factor.
 2. If Peak Result complies with AV limit, AV Result is deemed to comply with AV limit.
 3. Peak: Peak detector.
 4. AVG: $VBW=1/Ton$, where: Ton is the transmitting duration.
 5. For the transmitting duration, please refer to clause 7.1.
 6. Filter losses were only considered in the spurious frequency bands and the authorized band was not corrected for High Pass Filter losses.
 7. Proper operation of the transmitter prior to adding the filter to the measurement chain.
 8. Owing to the highest peak level of unwanted emission out of the restricted bands complies with the lowest limit(54dBuV/m), so all the test point was deemed to comply with the limits list in the standard.

HARMONICS AND SPURIOUS EMISSIONS (MID CHANNEL, VERTICAL)

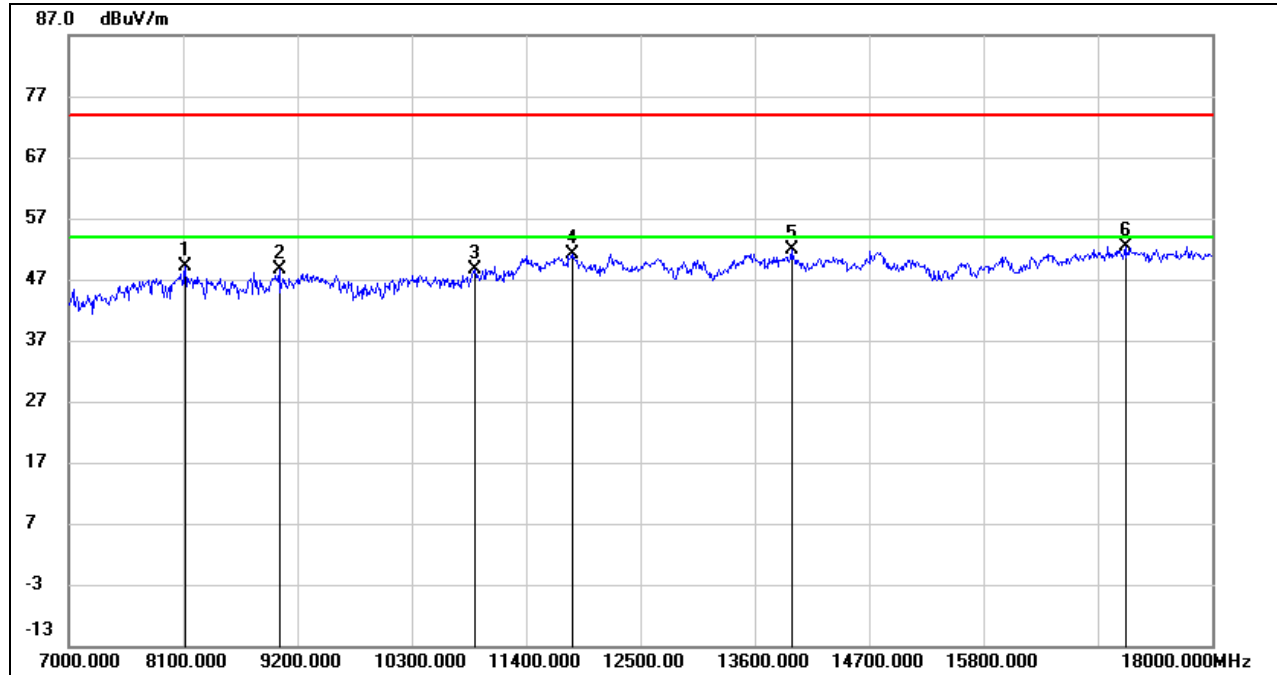

No.	Frequency (MHz)	Reading (dBuV)	Correct (dB/m)	Result (dBuV/m)	Limit (dBuV/m)	Margin (dB)	Remark
1	8122.000	38.99	10.10	49.09	74.00	-24.91	peak
2	9024.000	37.54	11.01	48.55	74.00	-25.45	peak
3	10905.000	35.18	13.35	48.53	74.00	-25.47	peak
4	11840.000	35.89	15.35	51.24	74.00	-22.76	peak
5	13952.000	34.23	17.60	51.83	74.00	-22.17	peak
6	17164.000	30.36	21.96	52.32	74.00	-21.68	peak

- Note:
1. Measurement = Reading Level + Correct Factor.
 2. If Peak Result complies with AV limit, AV Result is deemed to comply with AV limit.
 3. Peak: Peak detector.
 4. AVG: $VBW=1/Ton$, where: Ton is the transmitting duration.
 5. For the transmitting duration, please refer to clause 7.1.
 6. Filter losses were only considered in the spurious frequency bands and the authorized band was not corrected for High Pass Filter losses.
 7. Proper operation of the transmitter prior to adding the filter to the measurement chain.
 8. Owing to the highest peak level of unwanted emission out of the restricted bands complies with the lowest limit(54dBuV/m), so all the test point was deemed to comply with the limits list in the standard.

HARMONICS AND SPURIOUS EMISSIONS (HIGH CHANNEL, HORIZONTAL)

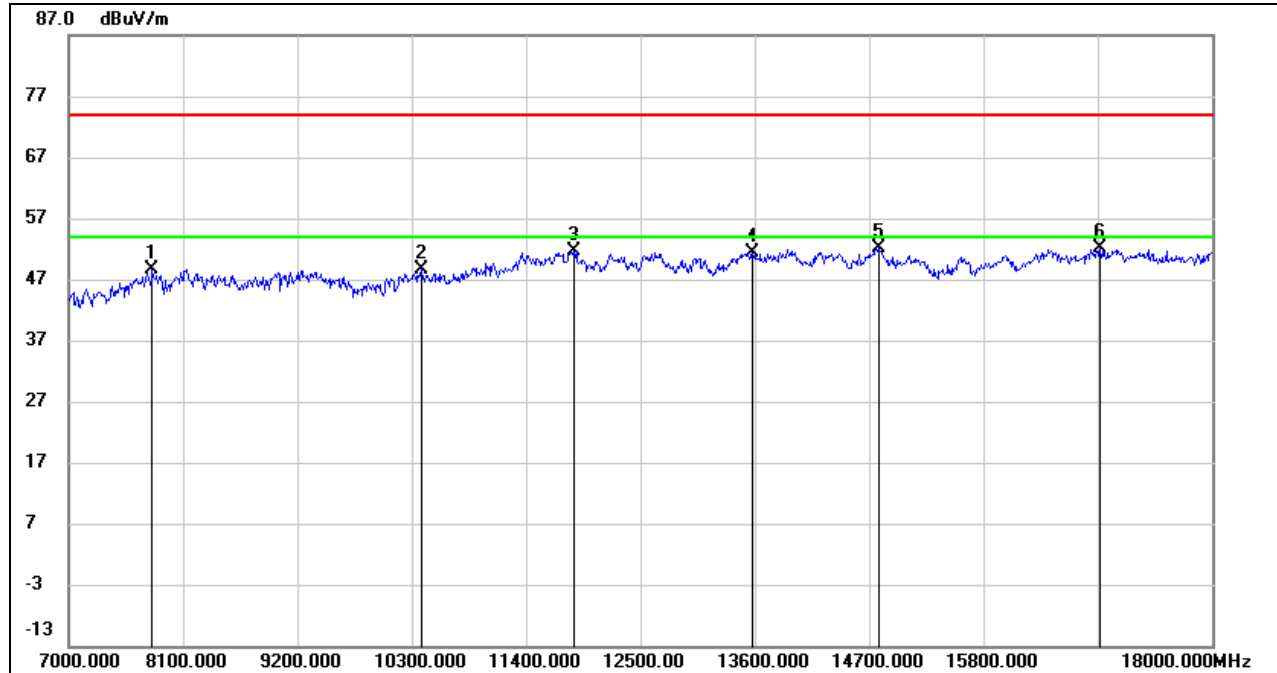

No.	Frequency (MHz)	Reading (dBuV)	Correct (dB/m)	Result (dBuV/m)	Limit (dBuV/m)	Margin (dB)	Remark
1	7803.000	39.36	9.33	48.69	74.00	-25.31	peak
2	10388.000	36.40	12.18	48.58	74.00	-25.42	peak
3	11862.000	36.25	15.41	51.66	74.00	-22.34	peak
4	13578.000	34.14	17.13	51.27	74.00	-22.73	peak
5	14799.000	33.98	18.04	52.02	74.00	-21.98	peak
6	16922.000	30.56	21.49	52.05	74.00	-21.95	peak

Note: 1. Measurement = Reading Level + Correct Factor.

2. If Peak Result complies with AV limit, AV Result is deemed to comply with AV limit.

3. Peak: Peak detector.

4. AVG: $VBW=1/Ton$, where: Ton is the transmitting duration.

5. For the transmitting duration, please refer to clause 7.1.

6. Filter losses were only considered in the spurious frequency bands and the authorized band was not corrected for High Pass Filter losses.

7. Proper operation of the transmitter prior to adding the filter to the measurement chain.

8. Owing to the highest peak level of unwanted emission out of the restricted bands complies with the lowest limit(54dBuV/m), so all the test point was deemed to comply with the limits list in the standard.

HARMONICS AND SPURIOUS EMISSIONS (HIGH CHANNEL, VERTICAL)

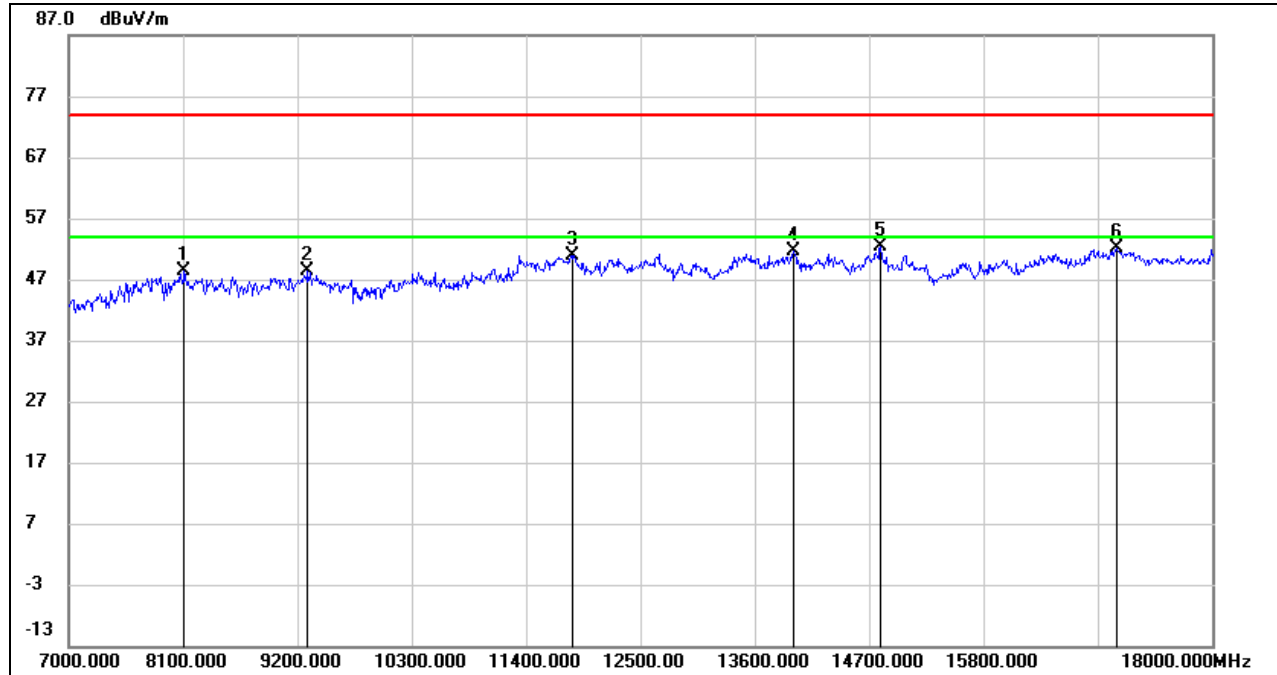

No.	Frequency (MHz)	Reading (dBuV)	Correct (dB/m)	Result (dBuV/m)	Limit (dBuV/m)	Margin (dB)	Remark
1	8111.000	38.17	10.14	48.31	74.00	-25.69	peak
2	9299.000	37.94	10.40	48.34	74.00	-25.66	peak
3	11840.000	35.62	15.35	50.97	74.00	-23.03	peak
4	13974.000	34.07	17.62	51.69	74.00	-22.31	peak
5	14810.000	34.52	17.97	52.49	74.00	-21.51	peak
6	17076.000	30.40	21.74	52.14	74.00	-21.86	peak

- Note:
1. Measurement = Reading Level + Correct Factor.
 2. If Peak Result complies with AV limit, AV Result is deemed to comply with AV limit.
 3. Peak: Peak detector.
 4. AVG: $VBW=1/Ton$, where: Ton is the transmitting duration.
 5. For the transmitting duration, please refer to clause 7.1.
 6. Filter losses were only considered in the spurious frequency bands and the authorized band was not corrected for High Pass Filter losses.
 7. Proper operation of the transmitter prior to adding the filter to the measurement chain.
 8. Owing to the highest peak level of unwanted emission out of the restricted bands complies with the lowest limit(54dBuV/m), so all the test point was deemed to comply with the limits list in the standard.

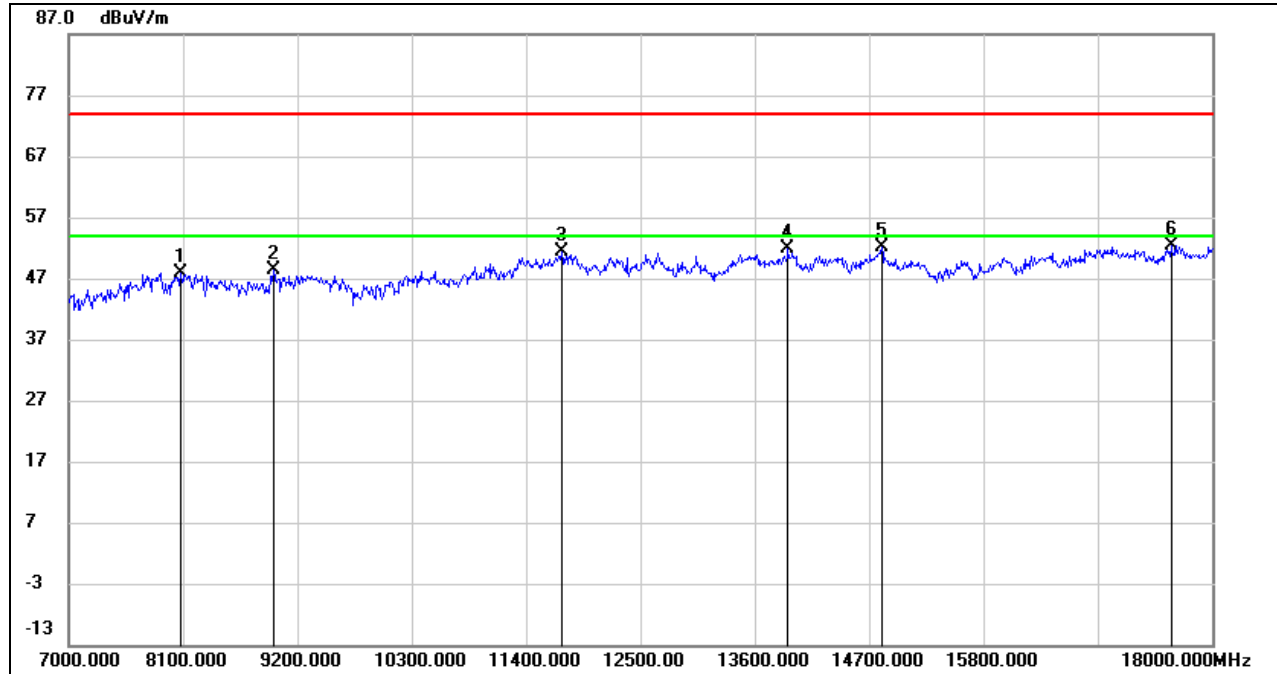
UNII-3 BAND
HARMONICS AND SPURIOUS EMISSIONS (LOW CHANNEL, HORIZONTAL)

No.	Frequency (MHz)	Reading (dBuV)	Correct (dB/m)	Result (dBuV/m)	Limit (dBuV/m)	Margin (dB)	Remark
1	8078.000	38.13	9.83	47.96	74.00	-26.04	peak
2	8969.000	37.70	10.69	48.39	74.00	-25.61	peak
3	11741.000	35.97	15.30	51.27	74.00	-22.73	peak
4	13919.000	34.41	17.55	51.96	74.00	-22.04	peak
5	14821.000	34.31	17.90	52.21	74.00	-21.79	peak
6	17604.000	29.60	22.76	52.36	74.00	-21.64	peak

Note: 1. Measurement = Reading Level + Correct Factor.

2. If Peak Result complies with AV limit, AV Result is deemed to comply with AV limit.

3. Peak: Peak detector.

4. AVG: $VBW=1/Ton$, where: Ton is the transmitting duration.

5. For the transmitting duration, please refer to clause 7.1.

6. Filter losses were only considered in the spurious frequency bands and the authorized band was not corrected for High Pass Filter losses.

7. Proper operation of the transmitter prior to adding the filter to the measurement chain.

8. Owing to the highest peak level of unwanted emission out of the restricted bands complies with the lowest limit(54dBuV/m), so all the test point was deemed to comply with the limits list in the standard.

HARMONICS AND SPURIOUS EMISSIONS (LOW CHANNEL, VERTICAL)

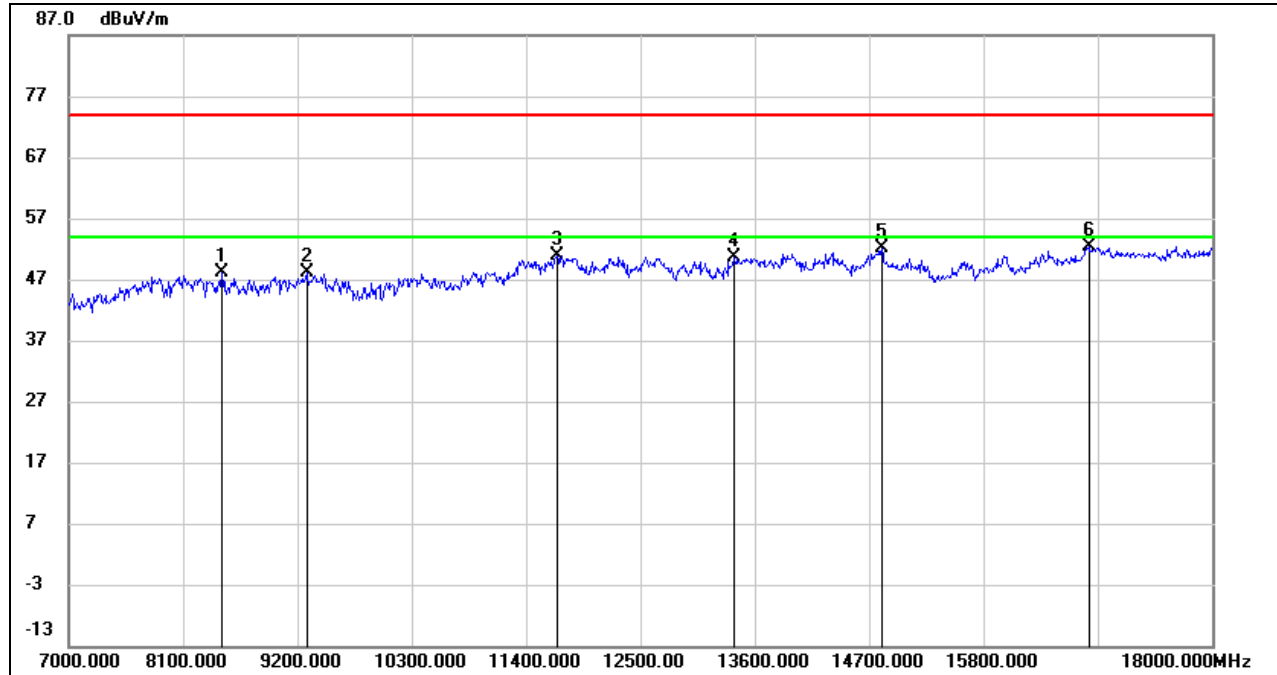

No.	Frequency (MHz)	Reading (dBuV)	Correct (dB/m)	Result (dBuV/m)	Limit (dBuV/m)	Margin (dB)	Remark
1	8474.000	39.02	9.18	48.20	74.00	-25.80	peak
2	9288.000	37.90	10.34	48.24	74.00	-25.76	peak
3	11697.000	35.64	15.34	50.98	74.00	-23.02	peak
4	13402.000	33.64	17.02	50.66	74.00	-23.34	peak
5	14821.000	34.31	17.90	52.21	74.00	-21.79	peak
6	16812.000	31.64	20.81	52.45	74.00	-21.55	peak

Note: 1. Measurement = Reading Level + Correct Factor.

2. If Peak Result complies with AV limit, AV Result is deemed to comply with AV limit.

3. Peak: Peak detector.

4. AVG: $VBW=1/Ton$, where: Ton is the transmitting duration.

5. For the transmitting duration, please refer to clause 7.1.

6. Filter losses were only considered in the spurious frequency bands and the authorized band was not corrected for High Pass Filter losses.

7. Proper operation of the transmitter prior to adding the filter to the measurement chain.

8. Owing to the highest peak level of unwanted emission out of the restricted bands complies with the lowest limit(54dBuV/m), so all the test point was deemed to comply with the limits list in the standard.

HARMONICS AND SPURIOUS EMISSIONS (MID CHANNEL, HORIZONTAL)

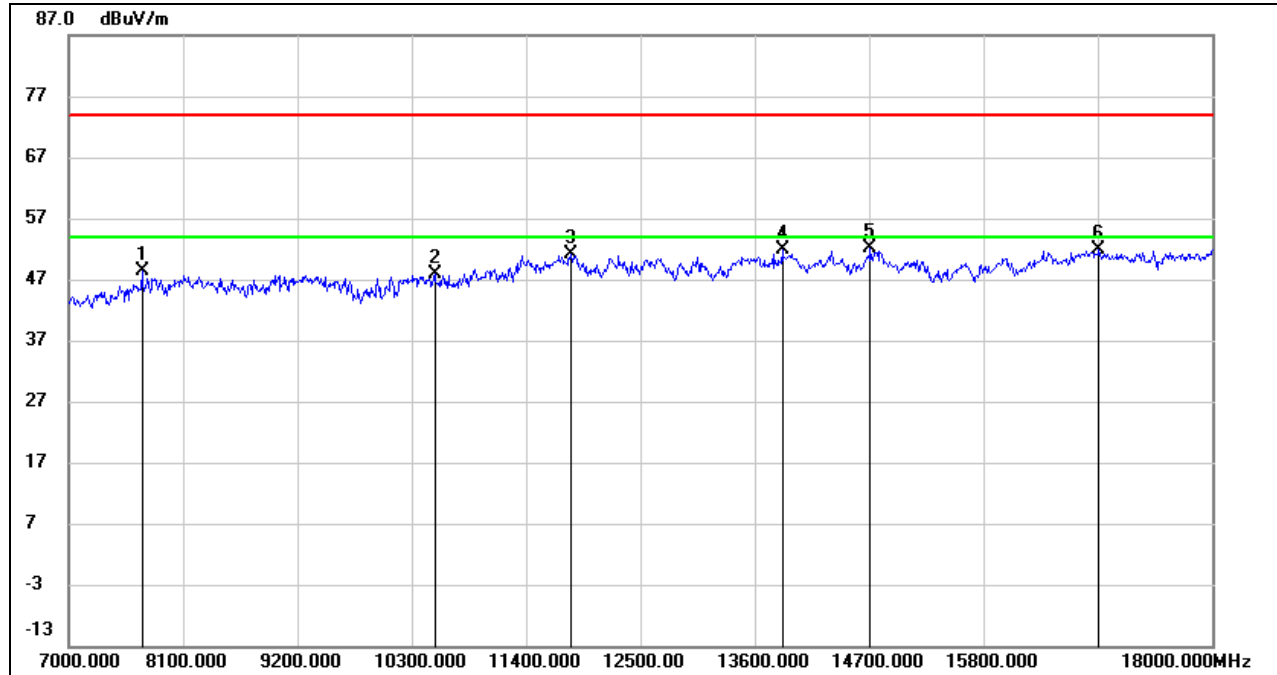

No.	Frequency (MHz)	Reading (dBuV)	Correct (dB/m)	Result (dBuV/m)	Limit (dBuV/m)	Margin (dB)	Remark
1	7704.000	39.78	8.48	48.26	74.00	-25.74	peak
2	10520.000	35.55	12.43	47.98	74.00	-26.02	peak
3	11829.000	35.78	15.32	51.10	74.00	-22.90	peak
4	13864.000	34.36	17.55	51.91	74.00	-22.09	peak
5	14711.000	34.41	17.73	52.14	74.00	-21.86	peak
6	16911.000	30.38	21.54	51.92	74.00	-22.08	peak

Note: 1. Measurement = Reading Level + Correct Factor.

2. If Peak Result complies with AV limit, AV Result is deemed to comply with AV limit.

3. Peak: Peak detector.

4. AVG: $VBW=1/Ton$, where: Ton is the transmitting duration.

5. For the transmitting duration, please refer to clause 7.1.

6. Filter losses were only considered in the spurious frequency bands and the authorized band was not corrected for High Pass Filter losses.

7. Proper operation of the transmitter prior to adding the filter to the measurement chain.

8. Owing to the highest peak level of unwanted emission out of the restricted bands complies with the lowest limit(54dBuV/m), so all the test point was deemed to comply with the limits list in the standard.

HARMONICS AND SPURIOUS EMISSIONS (MID CHANNEL, VERTICAL)

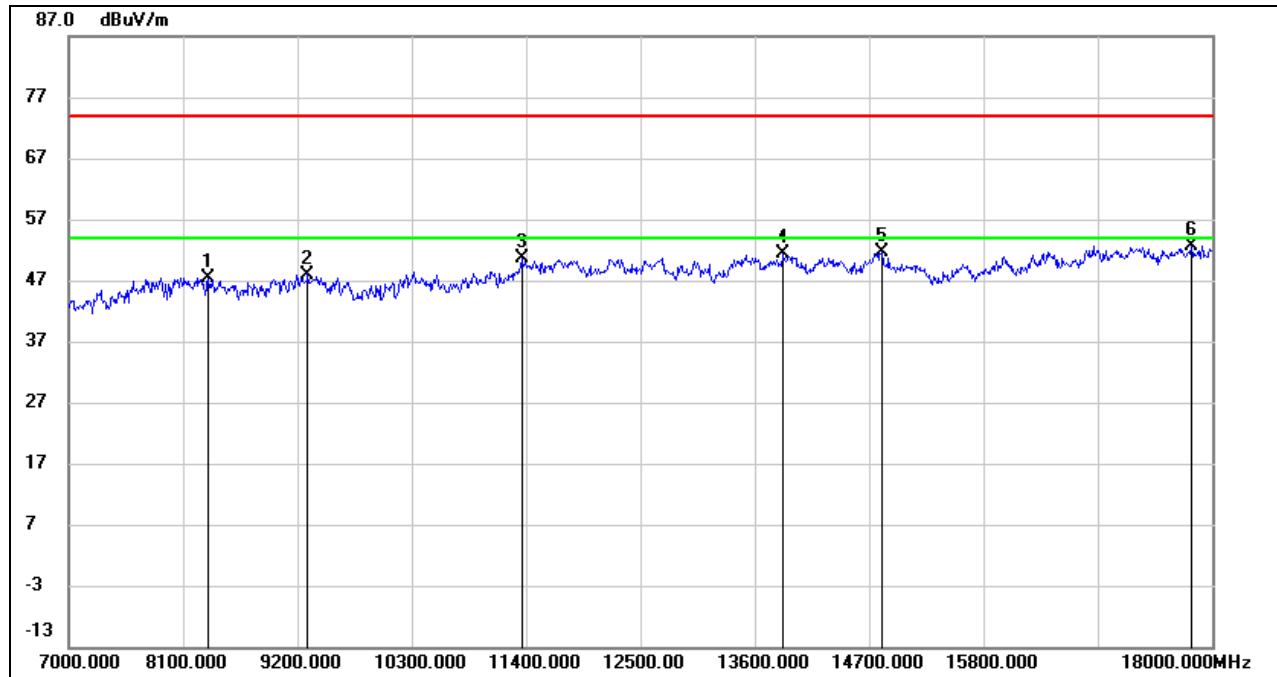

No.	Frequency (MHz)	Reading (dBuV)	Correct (dB/m)	Result (dBuV/m)	Limit (dBuV/m)	Margin (dB)	Remark
1	8342.000	37.78	9.54	47.32	74.00	-26.68	peak
2	9299.000	37.60	10.40	48.00	74.00	-26.00	peak
3	11356.000	36.26	14.35	50.61	74.00	-23.39	peak
4	13875.000	33.79	17.55	51.34	74.00	-22.66	peak
5	14821.000	33.84	17.90	51.74	74.00	-22.26	peak
6	17802.000	28.69	24.05	52.74	74.00	-21.26	peak

Note: 1. Measurement = Reading Level + Correct Factor.

2. If Peak Result complies with AV limit, AV Result is deemed to comply with AV limit.

3. Peak: Peak detector.

4. AVG: $VBW=1/Ton$, where: Ton is the transmitting duration.

5. For the transmitting duration, please refer to clause 7.1.

6. Filter losses were only considered in the spurious frequency bands and the authorized band was not corrected for High Pass Filter losses.

7. Proper operation of the transmitter prior to adding the filter to the measurement chain.

8. Owing to the highest peak level of unwanted emission out of the restricted bands complies with the lowest limit(54dBuV/m), so all the test point was deemed to comply with the limits list in the standard.

HARMONICS AND SPURIOUS EMISSIONS (HIGH CHANNEL, HORIZONTAL)

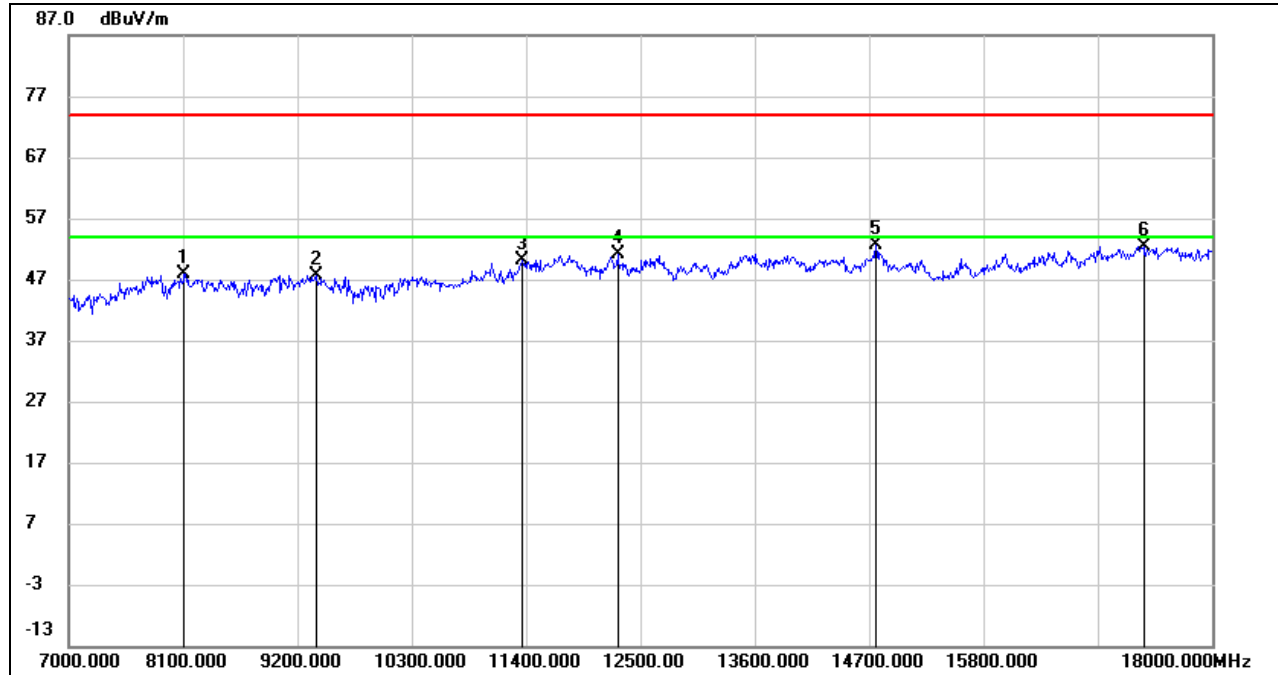

No.	Frequency (MHz)	Reading (dBuV)	Correct (dB/m)	Result (dBuV/m)	Limit (dBuV/m)	Margin (dB)	Remark
1	8111.000	37.77	10.14	47.91	74.00	-26.09	peak
2	9376.000	36.87	10.84	47.71	74.00	-26.29	peak
3	11356.000	35.89	14.35	50.24	74.00	-23.76	peak
4	12280.000	35.09	16.07	51.16	74.00	-22.84	peak
5	14766.000	34.62	17.92	52.54	74.00	-21.46	peak
6	17340.000	30.19	22.31	52.50	74.00	-21.50	peak

- Note:
1. Measurement = Reading Level + Correct Factor.
 2. If Peak Result complies with AV limit, AV Result is deemed to comply with AV limit.
 3. Peak: Peak detector.
 4. AVG: $VBW=1/Ton$, where: Ton is the transmitting duration.
 5. For the transmitting duration, please refer to clause 7.1.
 6. Filter losses were only considered in the spurious frequency bands and the authorized band was not corrected for High Pass Filter losses.
 7. Proper operation of the transmitter prior to adding the filter to the measurement chain.
 8. Owing to the highest peak level of unwanted emission out of the restricted bands complies with the lowest limit(54dBuV/m), so all the test point was deemed to comply with the limits list in the standard.

HARMONICS AND SPURIOUS EMISSIONS (HIGH CHANNEL, VERTICAL)

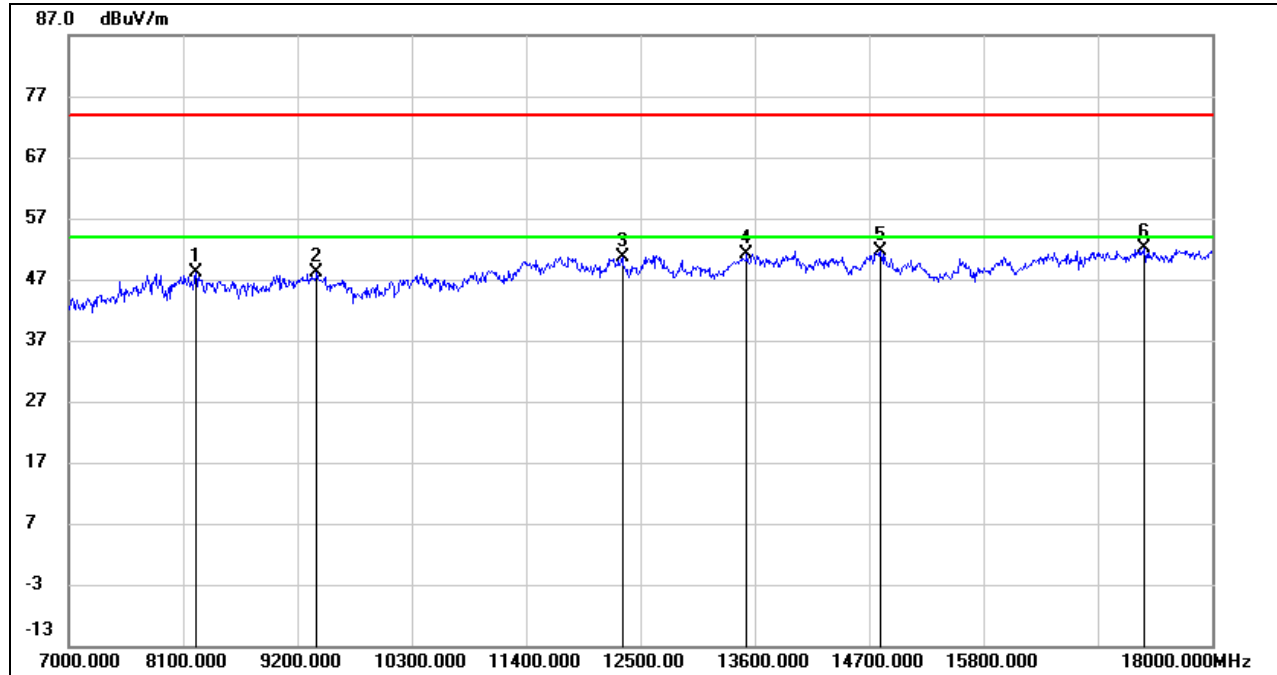

No.	Frequency (MHz)	Reading (dBuV)	Correct (dB/m)	Result (dBuV/m)	Limit (dBuV/m)	Margin (dB)	Remark
1	8221.000	38.27	9.79	48.06	74.00	-25.94	peak
2	9387.000	37.21	10.89	48.10	74.00	-25.90	peak
3	12324.000	34.65	16.05	50.70	74.00	-23.30	peak
4	13523.000	33.96	17.19	51.15	74.00	-22.85	peak
5	14810.000	33.65	17.97	51.62	74.00	-22.38	peak
6	17351.000	29.78	22.23	52.01	74.00	-21.99	peak

Note: 1. Measurement = Reading Level + Correct Factor.

2. If Peak Result complies with AV limit, AV Result is deemed to comply with AV limit.

3. Peak: Peak detector.

4. AVG: $VBW=1/Ton$, where: Ton is the transmitting duration.

5. For the transmitting duration, please refer to clause 7.1.

6. Filter losses were only considered in the spurious frequency bands and the authorized band was not corrected for High Pass Filter losses.

7. Proper operation of the transmitter prior to adding the filter to the measurement chain.

8. Owing to the highest peak level of unwanted emission out of the restricted bands complies with the lowest limit(54dBuV/m), so all the test point was deemed to comply with the limits list in the standard.

8.3.2. 802.11n HT20 MIMO MODE

UNII-1 BAND

HARMONICS AND SPURIOUS EMISSIONS (LOW CHANNEL, HORIZONTAL)

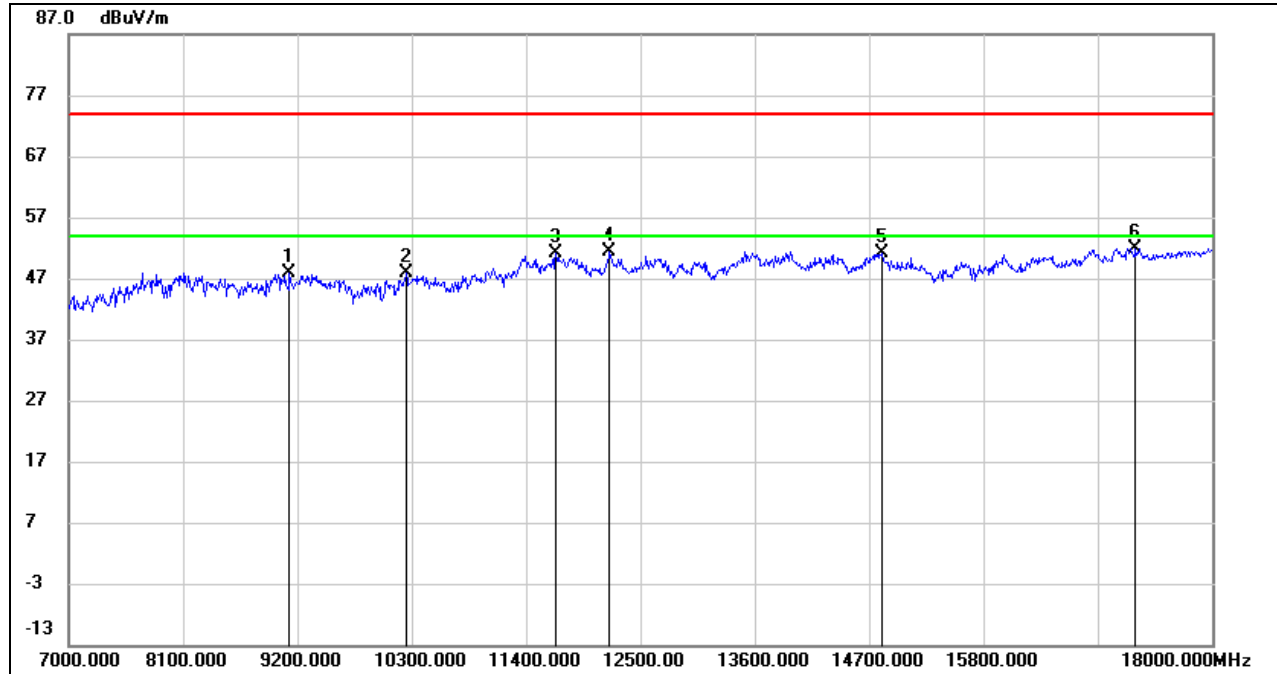

No.	Frequency (MHz)	Reading (dBuV)	Correct (dB/m)	Result (dBuV/m)	Limit (dBuV/m)	Margin (dB)	Remark
1	9123.000	37.84	10.09	47.93	74.00	-26.07	peak
2	10245.000	36.21	11.63	47.84	74.00	-26.16	peak
3	11686.000	35.87	15.27	51.14	74.00	-22.86	peak
4	12203.000	35.36	15.95	51.31	74.00	-22.69	peak
5	14821.000	33.32	17.90	51.22	74.00	-22.78	peak
6	17263.000	29.59	22.38	51.97	74.00	-22.03	peak

Note: 1. Measurement = Reading Level + Correct Factor.

2. If Peak Result complies with AV limit, AV Result is deemed to comply with AV limit.

3. Peak: Peak detector.

4. AVG: $VBW=1/T_{on}$, where: T_{on} is the transmitting duration.

5. For the transmitting duration, please refer to clause 7.1.

6. Filter losses were only considered in the spurious frequency bands and the authorized band was not corrected for High Pass Filter losses.

7. Proper operation of the transmitter prior to adding the filter to the measurement chain.

8. Owing to the highest peak level of unwanted emission out of the restricted bands complies with the lowest limit(54dBuV/m), so all the test point was deemed to comply with the limits list in the standard.

HARMONICS AND SPURIOUS EMISSIONS (LOW CHANNEL, VERTICAL)

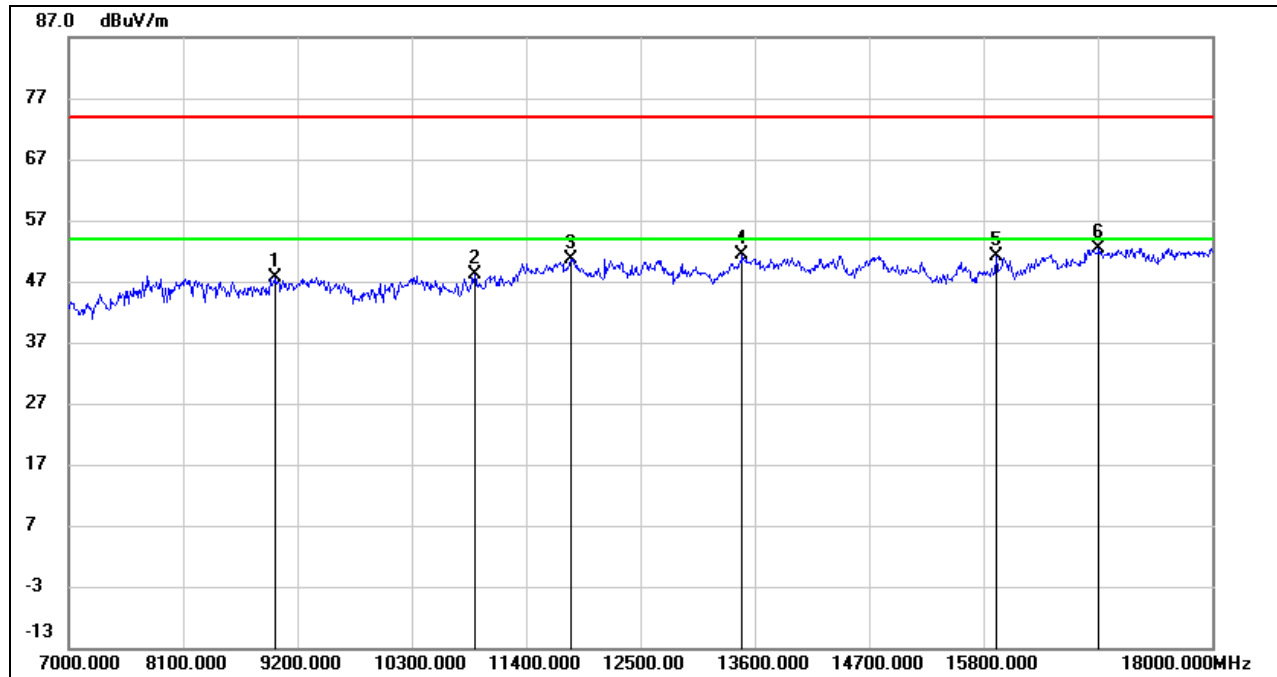

No.	Frequency (MHz)	Reading (dBuV)	Correct (dB/m)	Result (dBuV/m)	Limit (dBuV/m)	Margin (dB)	Remark
1	8991.000	36.64	11.10	47.74	74.00	-26.26	peak
2	10905.000	34.76	13.35	48.11	74.00	-25.89	peak
3	11829.000	35.40	15.32	50.72	74.00	-23.28	peak
4	13479.000	34.13	17.17	51.30	74.00	-22.70	peak
5	15921.000	33.08	18.14	51.22	74.00	-22.78	peak
6	16911.000	30.93	21.54	52.47	74.00	-21.53	peak

- Note:
1. Measurement = Reading Level + Correct Factor.
 2. If Peak Result complies with AV limit, AV Result is deemed to comply with AV limit.
 3. Peak: Peak detector.
 4. AVG: $VBW=1/T_{on}$, where: T_{on} is the transmitting duration.
 5. For the transmitting duration, please refer to clause 7.1.
 6. Filter losses were only considered in the spurious frequency bands and the authorized band was not corrected for High Pass Filter losses.
 7. Proper operation of the transmitter prior to adding the filter to the measurement chain.
 8. Owing to the highest peak level of unwanted emission out of the restricted bands complies with the lowest limit(54dBuV/m), so all the test point was deemed to comply with the limits list in the standard.

HARMONICS AND SPURIOUS EMISSIONS (MID CHANNEL, HORIZONTAL)

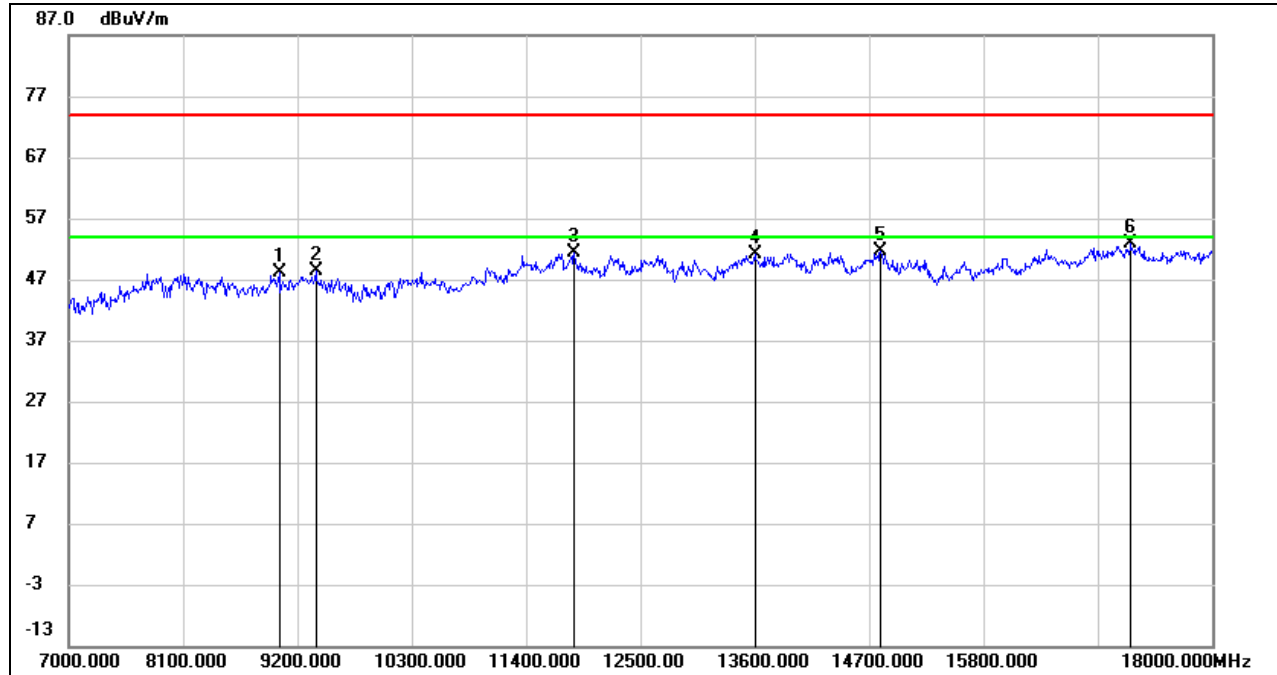

No.	Frequency (MHz)	Reading (dBuV)	Correct (dB/m)	Result (dBuV/m)	Limit (dBuV/m)	Margin (dB)	Remark
1	9024.000	37.06	11.01	48.07	74.00	-25.93	peak
2	9376.000	37.64	10.84	48.48	74.00	-25.52	peak
3	11862.000	35.93	15.41	51.34	74.00	-22.66	peak
4	13600.000	34.01	17.10	51.11	74.00	-22.89	peak
5	14810.000	33.58	17.97	51.55	74.00	-22.45	peak
6	17219.000	30.76	22.11	52.87	74.00	-21.13	peak

Note: 1. Measurement = Reading Level + Correct Factor.

2. If Peak Result complies with AV limit, AV Result is deemed to comply with AV limit.

3. Peak: Peak detector.

4. AVG: $VBW=1/Ton$, where: Ton is the transmitting duration.

5. For the transmitting duration, please refer to clause 7.1.

6. Filter losses were only considered in the spurious frequency bands and the authorized band was not corrected for High Pass Filter losses.

7. Proper operation of the transmitter prior to adding the filter to the measurement chain.

8. Owing to the highest peak level of unwanted emission out of the restricted bands complies with the lowest limit(54dBuV/m), so all the test point was deemed to comply with the limits list in the standard.

HARMONICS AND SPURIOUS EMISSIONS (MID CHANNEL, VERTICAL)

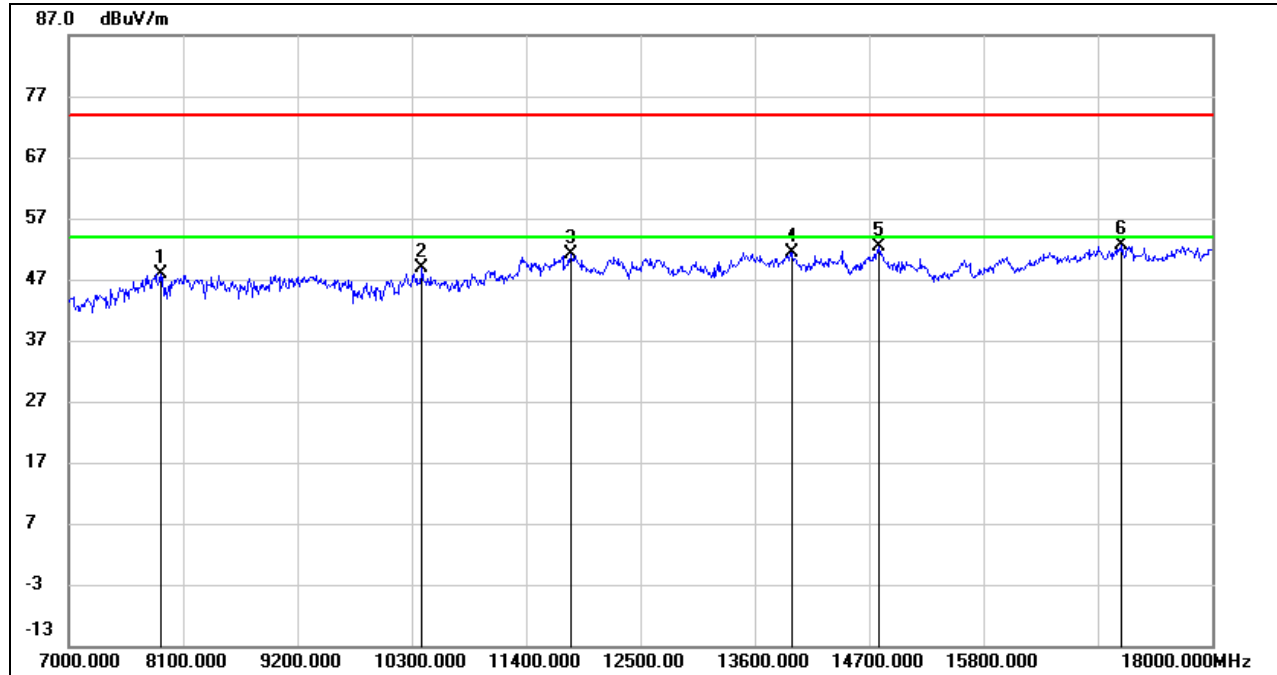

No.	Frequency (MHz)	Reading (dBuV)	Correct (dB/m)	Result (dBuV/m)	Limit (dBuV/m)	Margin (dB)	Remark
1	7880.000	38.98	8.95	47.93	74.00	-26.07	peak
2	10399.000	36.62	12.23	48.85	74.00	-25.15	peak
3	11829.000	35.81	15.32	51.13	74.00	-22.87	peak
4	13952.000	33.73	17.60	51.33	74.00	-22.67	peak
5	14799.000	34.35	18.04	52.39	74.00	-21.61	peak
6	17131.000	30.68	21.92	52.60	74.00	-21.40	peak

Note: 1. Measurement = Reading Level + Correct Factor.

2. If Peak Result complies with AV limit, AV Result is deemed to comply with AV limit.

3. Peak: Peak detector.

4. AVG: $VBW=1/Ton$, where: Ton is the transmitting duration.

5. For the transmitting duration, please refer to clause 7.1.

6. Filter losses were only considered in the spurious frequency bands and the authorized band was not corrected for High Pass Filter losses.

7. Proper operation of the transmitter prior to adding the filter to the measurement chain.

8. Owing to the highest peak level of unwanted emission out of the restricted bands complies with the lowest limit(54dBuV/m), so all the test point was deemed to comply with the limits list in the standard.

HARMONICS AND SPURIOUS EMISSIONS (HIGH CHANNEL, HORIZONTAL)

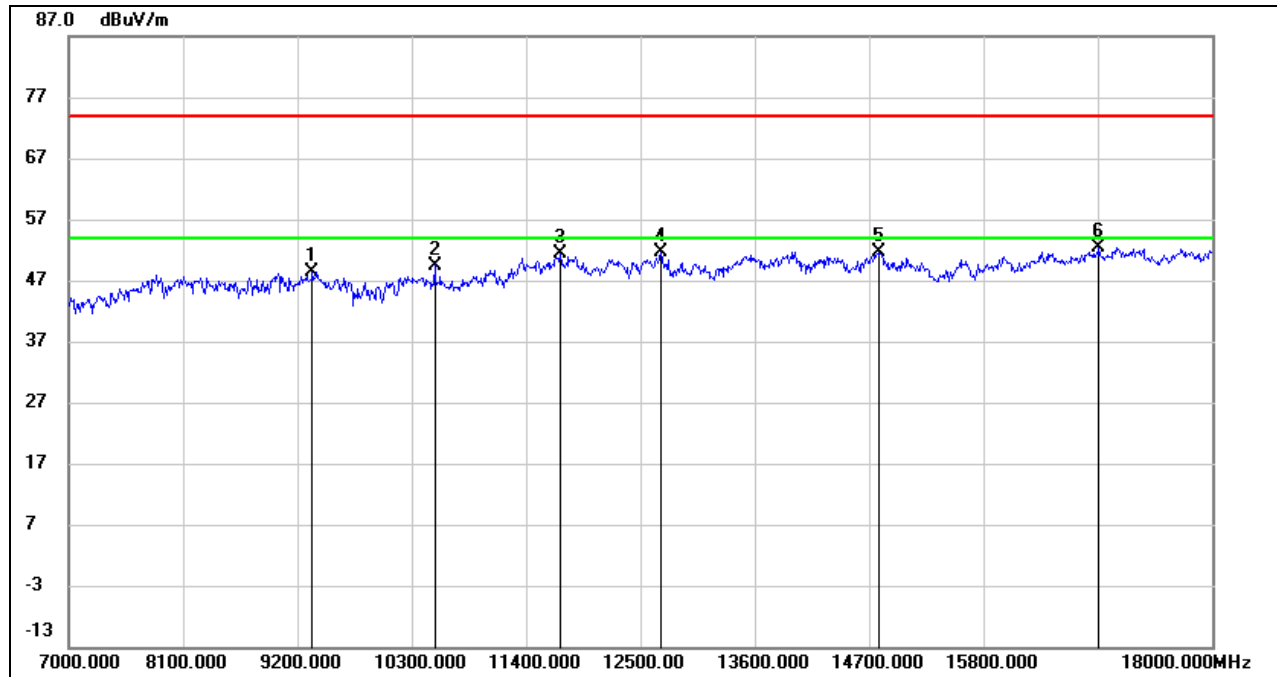

No.	Frequency (MHz)	Reading (dBuV)	Correct (dB/m)	Result (dBuV/m)	Limit (dBuV/m)	Margin (dB)	Remark
1	9343.000	37.69	10.64	48.33	74.00	-25.67	peak
2	10520.000	37.07	12.43	49.50	74.00	-24.50	peak
3	11730.000	36.07	15.32	51.39	74.00	-22.61	peak
4	12698.000	35.97	15.62	51.59	74.00	-22.41	peak
5	14799.000	33.59	18.04	51.63	74.00	-22.37	peak
6	16911.000	30.80	21.54	52.34	74.00	-21.66	peak

- Note:
1. Measurement = Reading Level + Correct Factor.
 2. If Peak Result complies with AV limit, AV Result is deemed to comply with AV limit.
 3. Peak: Peak detector.
 4. AVG: $VBW=1/Ton$, where: Ton is the transmitting duration.
 5. For the transmitting duration, please refer to clause 7.1.
 6. Filter losses were only considered in the spurious frequency bands and the authorized band was not corrected for High Pass Filter losses.
 7. Proper operation of the transmitter prior to adding the filter to the measurement chain.
 8. Owing to the highest peak level of unwanted emission out of the restricted bands complies with the lowest limit(54dBuV/m), so all the test point was deemed to comply with the limits list in the standard.

HARMONICS AND SPURIOUS EMISSIONS (HIGH CHANNEL, VERTICAL)

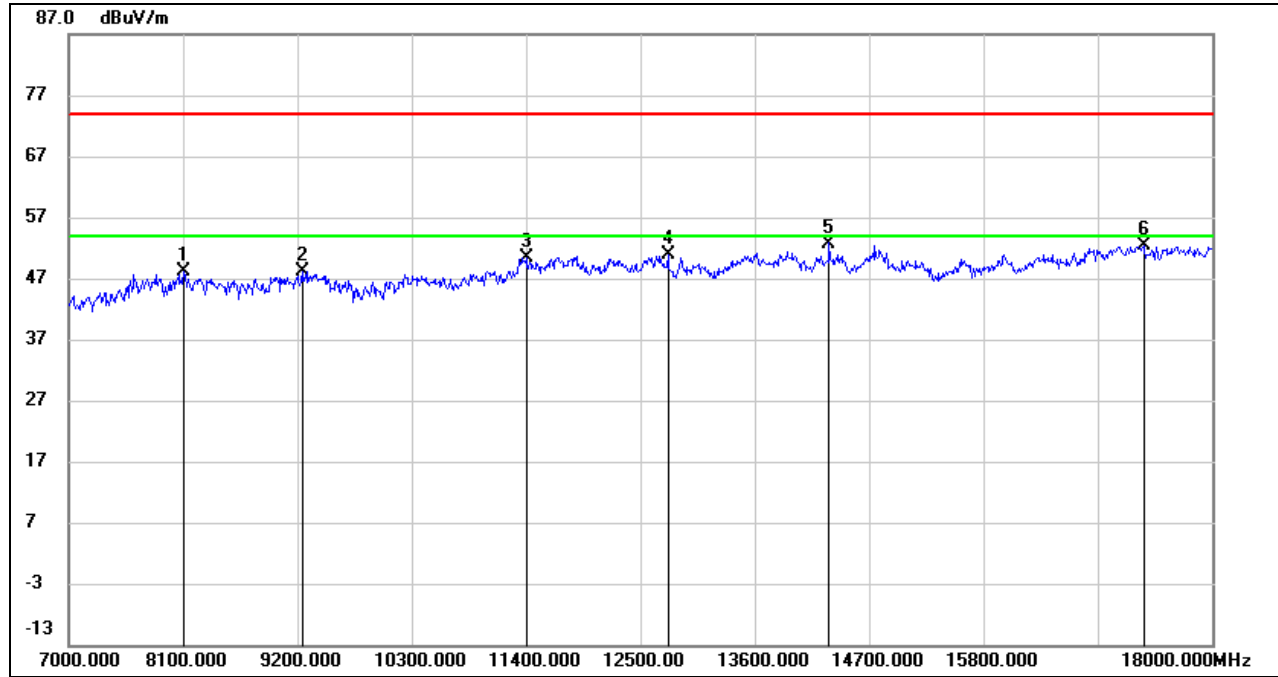

No.	Frequency (MHz)	Reading (dBuV)	Correct (dB/m)	Result (dBuV/m)	Limit (dBuV/m)	Margin (dB)	Remark
1	8100.000	37.91	10.18	48.09	74.00	-25.91	peak
2	9244.000	37.92	10.12	48.04	74.00	-25.96	peak
3	11400.000	35.65	14.76	50.41	74.00	-23.59	peak
4	12764.000	35.05	15.86	50.91	74.00	-23.09	peak
5	14315.000	34.73	18.02	52.75	74.00	-21.25	peak
6	17340.000	29.99	22.31	52.30	74.00	-21.70	peak

- Note:
1. Measurement = Reading Level + Correct Factor.
 2. If Peak Result complies with AV limit, AV Result is deemed to comply with AV limit.
 3. Peak: Peak detector.
 4. AVG: $VBW=1/Ton$, where: Ton is the transmitting duration.
 5. For the transmitting duration, please refer to clause 7.1.
 6. Filter losses were only considered in the spurious frequency bands and the authorized band was not corrected for High Pass Filter losses.
 7. Proper operation of the transmitter prior to adding the filter to the measurement chain.
 8. Owing to the highest peak level of unwanted emission out of the restricted bands complies with the lowest limit(54dBuV/m), so all the test point was deemed to comply with the limits list in the standard.

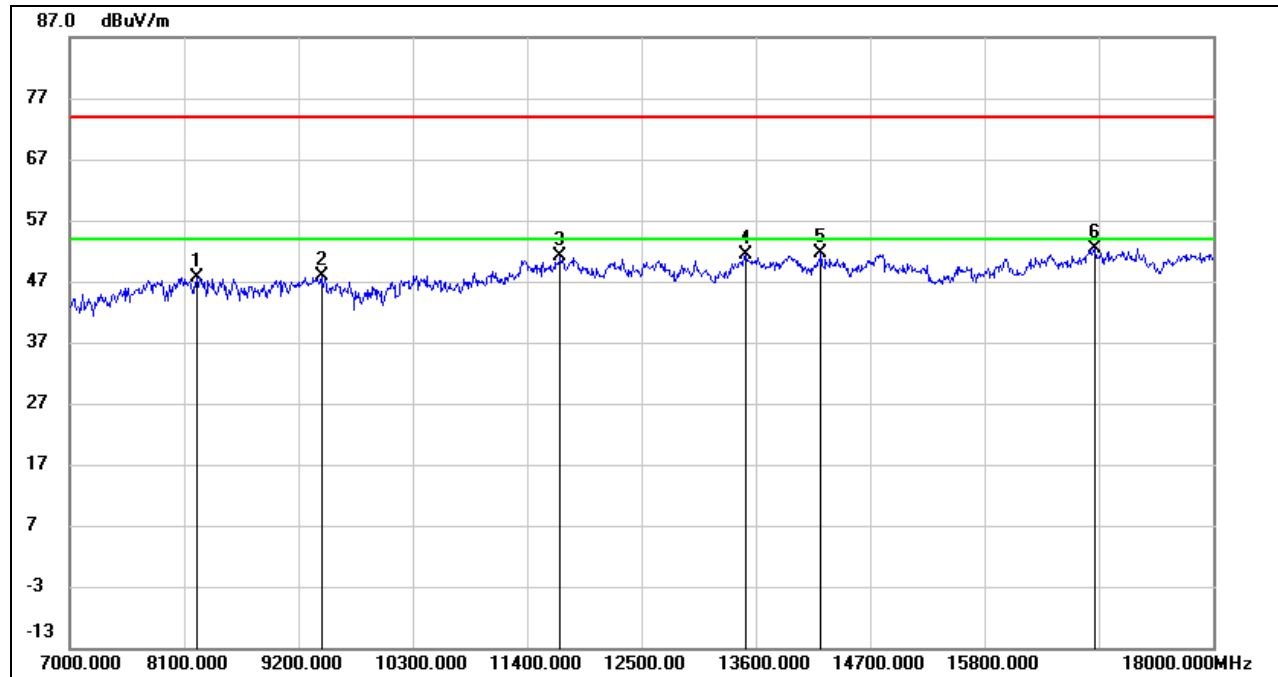
UNII-3 BAND
HARMONICS AND SPURIOUS EMISSIONS (LOW CHANNEL, HORIZONTAL)

No.	Frequency (MHz)	Reading (dBuV)	Correct (dB/m)	Result (dBuV/m)	Limit (dBuV/m)	Margin (dB)	Remark
1	8221.000	37.90	9.79	47.69	74.00	-26.31	peak
2	9420.000	36.98	10.88	47.86	74.00	-26.14	peak
3	11719.000	35.83	15.33	51.16	74.00	-22.84	peak
4	13501.000	34.27	17.22	51.49	74.00	-22.51	peak
5	14227.000	33.63	17.88	51.51	74.00	-22.49	peak
6	16856.000	31.23	21.19	52.42	74.00	-21.58	peak

Note: 1. Measurement = Reading Level + Correct Factor.
 2. If Peak Result complies with AV limit, AV Result is deemed to comply with AV limit.
 3. Peak: Peak detector.
 4. AVG: $VBW=1/Ton$, where: Ton is the transmitting duration.
 5. For the transmitting duration, please refer to clause 7.1.
 6. Filter losses were only considered in the spurious frequency bands and the authorized band was not corrected for High Pass Filter losses.
 7. Proper operation of the transmitter prior to adding the filter to the measurement chain.
 8. Owing to the highest peak level of unwanted emission out of the restricted bands complies with the lowest limit(54dBuV/m), so all the test point was deemed to comply with the limits list in the standard.

HARMONICS AND SPURIOUS EMISSIONS (LOW CHANNEL, VERTICAL)

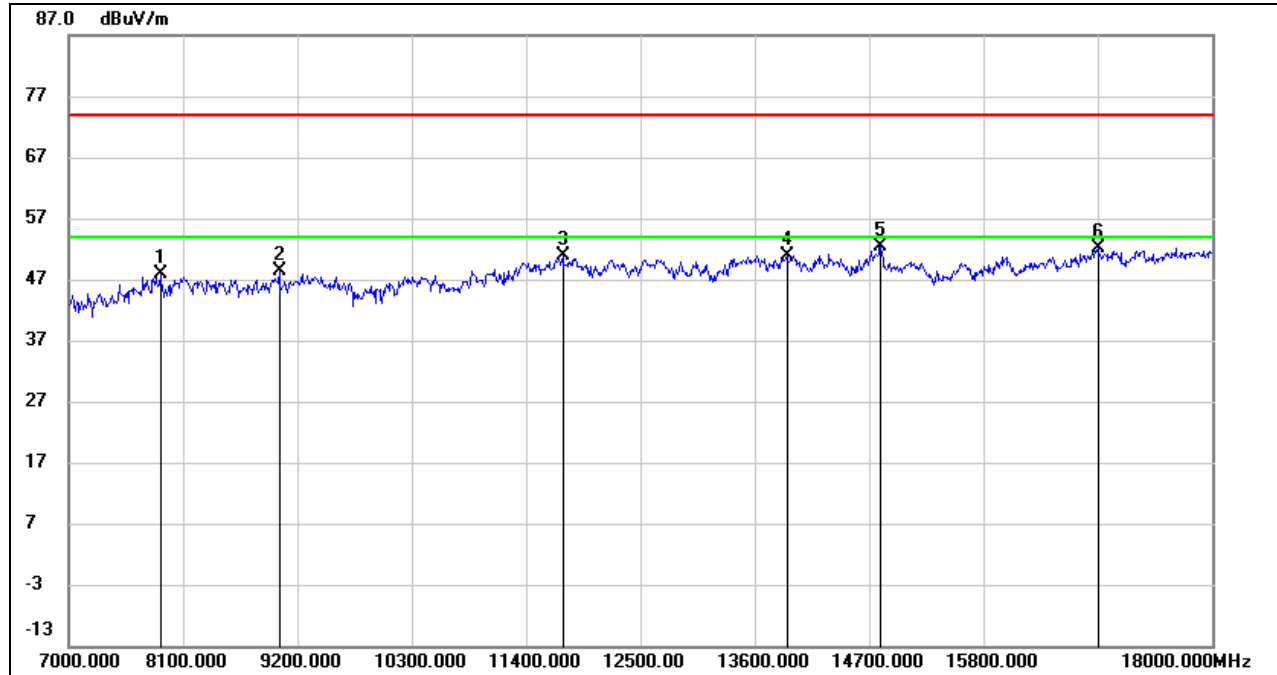

No.	Frequency (MHz)	Reading (dBuV)	Correct (dB/m)	Result (dBuV/m)	Limit (dBuV/m)	Margin (dB)	Remark
1	7880.000	38.88	8.95	47.83	74.00	-26.17	peak
2	9024.000	37.40	11.01	48.41	74.00	-25.59	peak
3	11752.000	35.62	15.29	50.91	74.00	-23.09	peak
4	13908.000	33.45	17.54	50.99	74.00	-23.01	peak
5	14810.000	34.38	17.97	52.35	74.00	-21.65	peak
6	16900.000	30.57	21.57	52.14	74.00	-21.86	peak

Note: 1. Measurement = Reading Level + Correct Factor.

2. If Peak Result complies with AV limit, AV Result is deemed to comply with AV limit.

3. Peak: Peak detector.

4. AVG: $VBW=1/Ton$, where: Ton is the transmitting duration.

5. For the transmitting duration, please refer to clause 7.1.

6. Filter losses were only considered in the spurious frequency bands and the authorized band was not corrected for High Pass Filter losses.

7. Proper operation of the transmitter prior to adding the filter to the measurement chain.

8. Owing to the highest peak level of unwanted emission out of the restricted bands complies with the lowest limit(54dBuV/m), so all the test point was deemed to comply with the limits list in the standard.

HARMONICS AND SPURIOUS EMISSIONS (MID CHANNEL, HORIZONTAL)

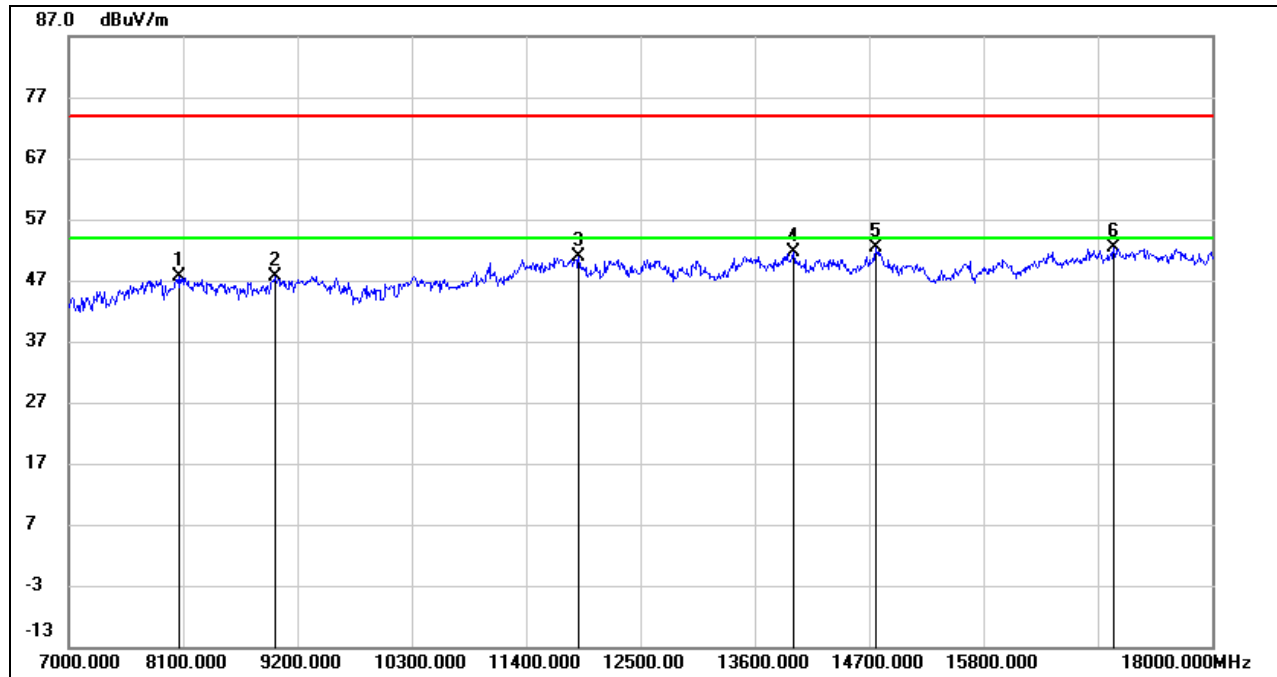

No.	Frequency (MHz)	Reading (dBuV)	Correct (dB/m)	Result (dBuV/m)	Limit (dBuV/m)	Margin (dB)	Remark
1	8056.000	38.03	9.50	47.53	74.00	-26.47	peak
2	8980.000	36.79	10.89	47.68	74.00	-26.32	peak
3	11906.000	35.36	15.52	50.88	74.00	-23.12	peak
4	13974.000	34.02	17.62	51.64	74.00	-22.36	peak
5	14766.000	34.43	17.92	52.35	74.00	-21.65	peak
6	17054.000	30.69	21.59	52.28	74.00	-21.72	peak

Note: 1. Measurement = Reading Level + Correct Factor.

2. If Peak Result complies with AV limit, AV Result is deemed to comply with AV limit.

3. Peak: Peak detector.

4. AVG: $VBW=1/Ton$, where: Ton is the transmitting duration.

5. For the transmitting duration, please refer to clause 7.1.

6. Filter losses were only considered in the spurious frequency bands and the authorized band was not corrected for High Pass Filter losses.

7. Proper operation of the transmitter prior to adding the filter to the measurement chain.

8. Owing to the highest peak level of unwanted emission out of the restricted bands complies with the lowest limit(54dBuV/m), so all the test point was deemed to comply with the limits list in the standard.

HARMONICS AND SPURIOUS EMISSIONS (MID CHANNEL, VERTICAL)

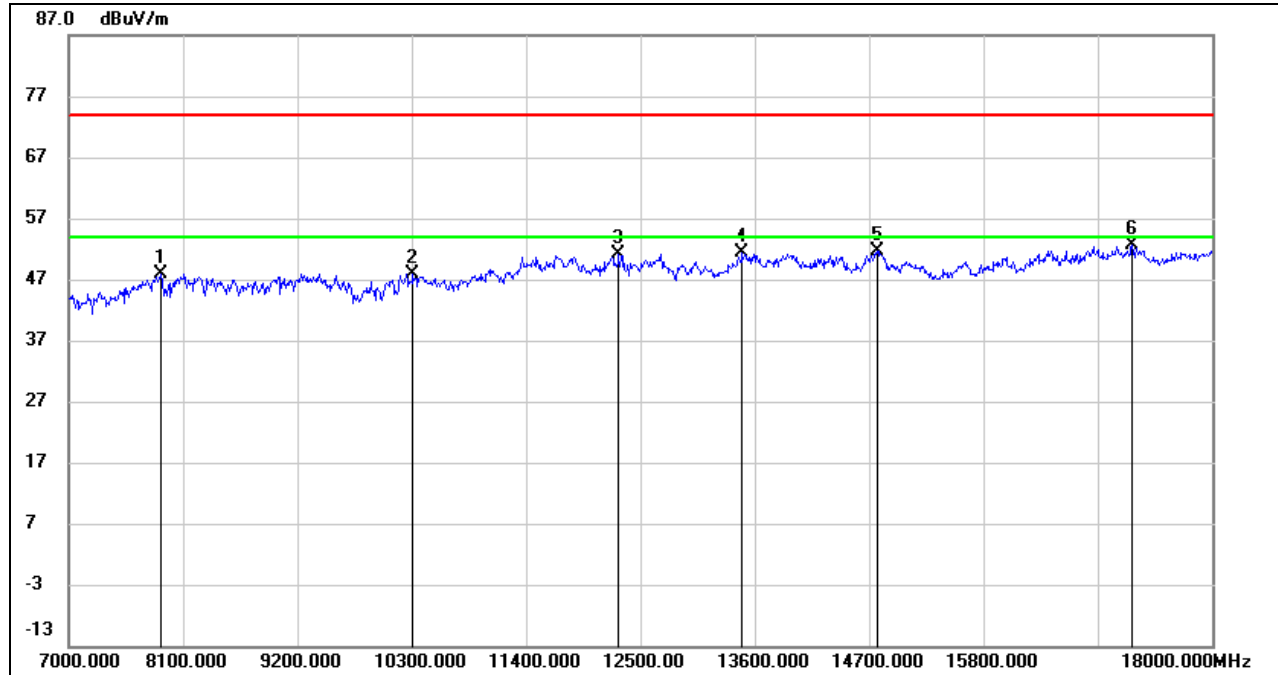

No.	Frequency (MHz)	Reading (dBuV)	Correct (dB/m)	Result (dBuV/m)	Limit (dBuV/m)	Margin (dB)	Remark
1	7891.000	39.01	8.90	47.91	74.00	-26.09	peak
2	10311.000	36.10	11.86	47.96	74.00	-26.04	peak
3	12291.000	35.05	16.08	51.13	74.00	-22.87	peak
4	13479.000	34.13	17.17	51.30	74.00	-22.70	peak
5	14777.000	33.69	17.96	51.65	74.00	-22.35	peak
6	17230.000	30.39	22.17	52.56	74.00	-21.44	peak

- Note: 1. Measurement = Reading Level + Correct Factor.
 2. If Peak Result complies with AV limit, AV Result is deemed to comply with AV limit.
 3. Peak: Peak detector.
 4. AVG: $VBW=1/Ton$, where: Ton is the transmitting duration.
 5. For the transmitting duration, please refer to clause 7.1.
 6. Filter losses were only considered in the spurious frequency bands and the authorized band was not corrected for High Pass Filter losses.
 7. Proper operation of the transmitter prior to adding the filter to the measurement chain.
 8. Owing to the highest peak level of unwanted emission out of the restricted bands complies with the lowest limit(54dBuV/m), so all the test point was deemed to comply with the limits list in the standard.

HARMONICS AND SPURIOUS EMISSIONS (HIGH CHANNEL, HORIZONTAL)

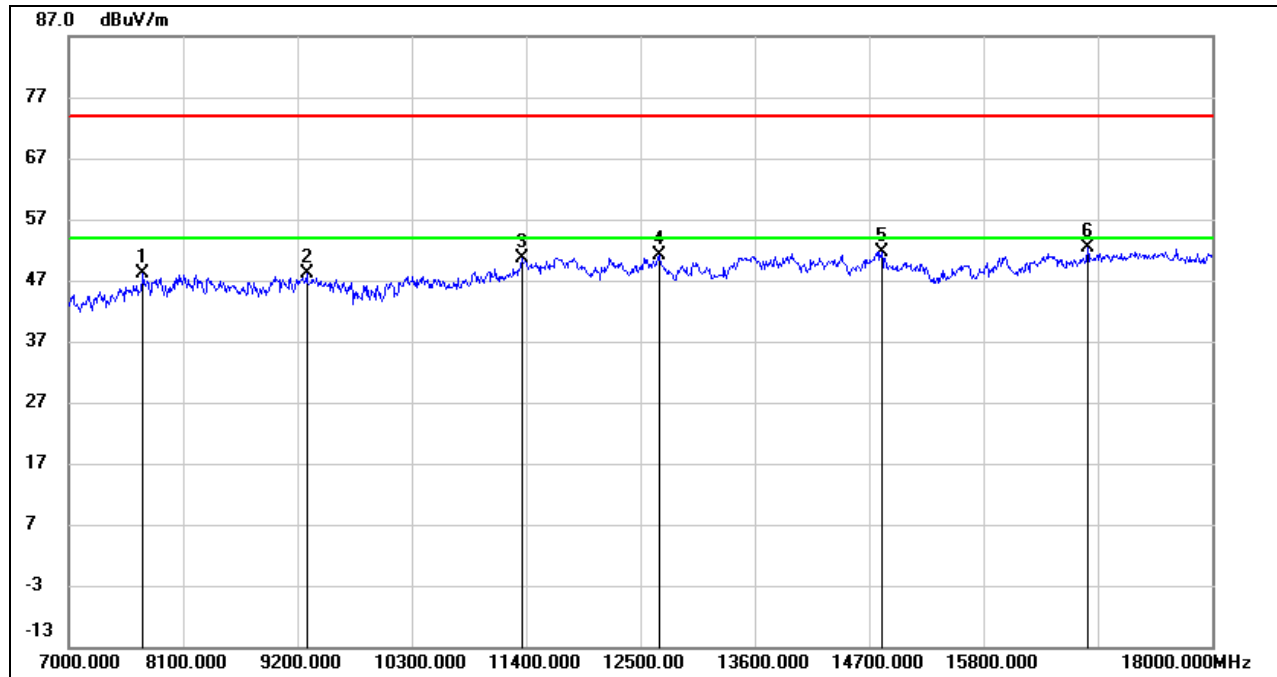

No.	Frequency (MHz)	Reading (dBuV)	Correct (dB/m)	Result (dBuV/m)	Limit (dBuV/m)	Margin (dB)	Remark
1	7715.000	39.46	8.59	48.05	74.00	-25.95	peak
2	9288.000	37.84	10.34	48.18	74.00	-25.82	peak
3	11356.000	36.32	14.35	50.67	74.00	-23.33	peak
4	12676.000	35.43	15.66	51.09	74.00	-22.91	peak
5	14821.000	33.83	17.90	51.73	74.00	-22.27	peak
6	16801.000	31.59	20.72	52.31	74.00	-21.69	peak

- Note:
1. Measurement = Reading Level + Correct Factor.
 2. If Peak Result complies with AV limit, AV Result is deemed to comply with AV limit.
 3. Peak: Peak detector.
 4. AVG: $VBW=1/Ton$, where: Ton is the transmitting duration.
 5. For the transmitting duration, please refer to clause 7.1.
 6. Filter losses were only considered in the spurious frequency bands and the authorized band was not corrected for High Pass Filter losses.
 7. Proper operation of the transmitter prior to adding the filter to the measurement chain.
 8. Owing to the highest peak level of unwanted emission out of the restricted bands complies with the lowest limit(54dBuV/m), so all the test point was deemed to comply with the limits list in the standard.

HARMONICS AND SPURIOUS EMISSIONS (HIGH CHANNEL, VERTICAL)

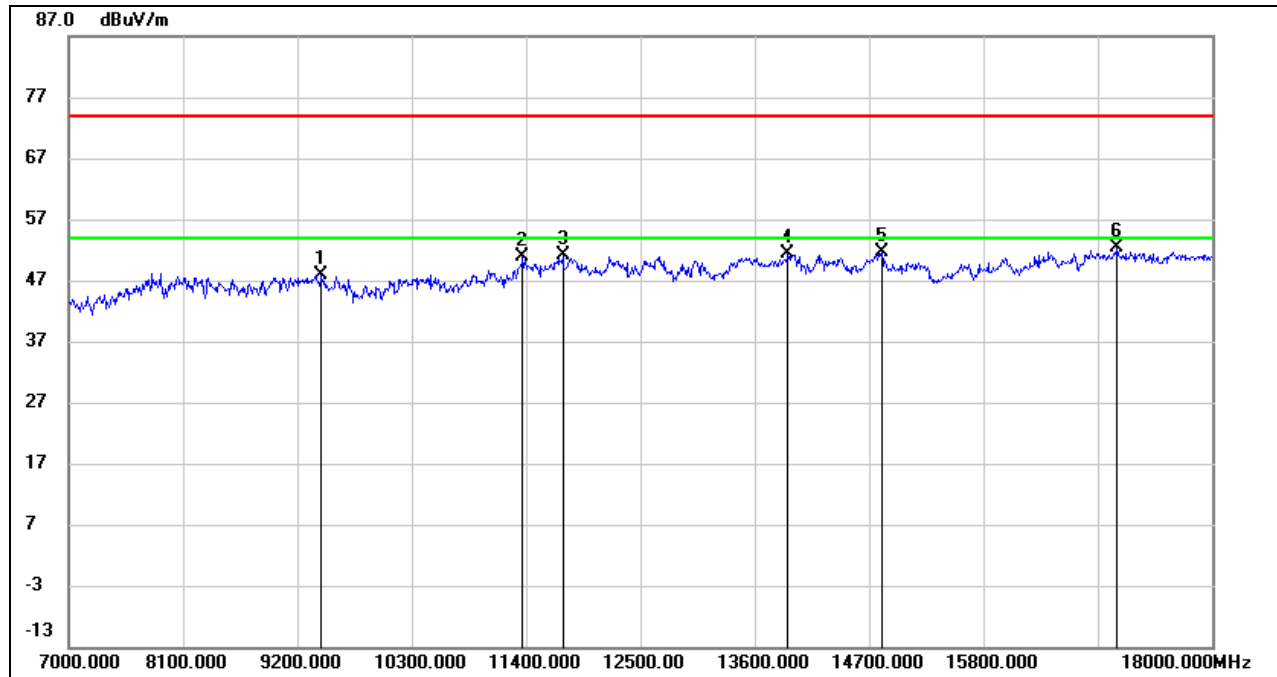

No.	Frequency (MHz)	Reading (dBuV)	Correct (dB/m)	Result (dBuV/m)	Limit (dBuV/m)	Margin (dB)	Remark
1	9431.000	37.03	10.83	47.86	74.00	-26.14	peak
2	11367.000	36.40	14.45	50.85	74.00	-23.15	peak
3	11752.000	35.86	15.29	51.15	74.00	-22.85	peak
4	13919.000	33.73	17.55	51.28	74.00	-22.72	peak
5	14821.000	33.65	17.90	51.55	74.00	-22.45	peak
6	17087.000	30.67	21.81	52.48	74.00	-21.52	peak

Note: 1. Measurement = Reading Level + Correct Factor.

2. If Peak Result complies with AV limit, AV Result is deemed to comply with AV limit.

3. Peak: Peak detector.

4. AVG: $VBW=1/T_{on}$, where: T_{on} is the transmitting duration.

5. For the transmitting duration, please refer to clause 7.1.

6. Filter losses were only considered in the spurious frequency bands and the authorized band was not corrected for High Pass Filter losses.

7. Proper operation of the transmitter prior to adding the filter to the measurement chain.

8. Owing to the highest peak level of unwanted emission out of the restricted bands complies with the lowest limit(54dBuV/m), so all the test point was deemed to comply with the limits list in the standard.

8.3.3. 802.11n HT40 MIMO MODE

UNII-1 BAND

HARMONICS AND SPURIOUS EMISSIONS (LOW CHANNEL, HORIZONTAL)

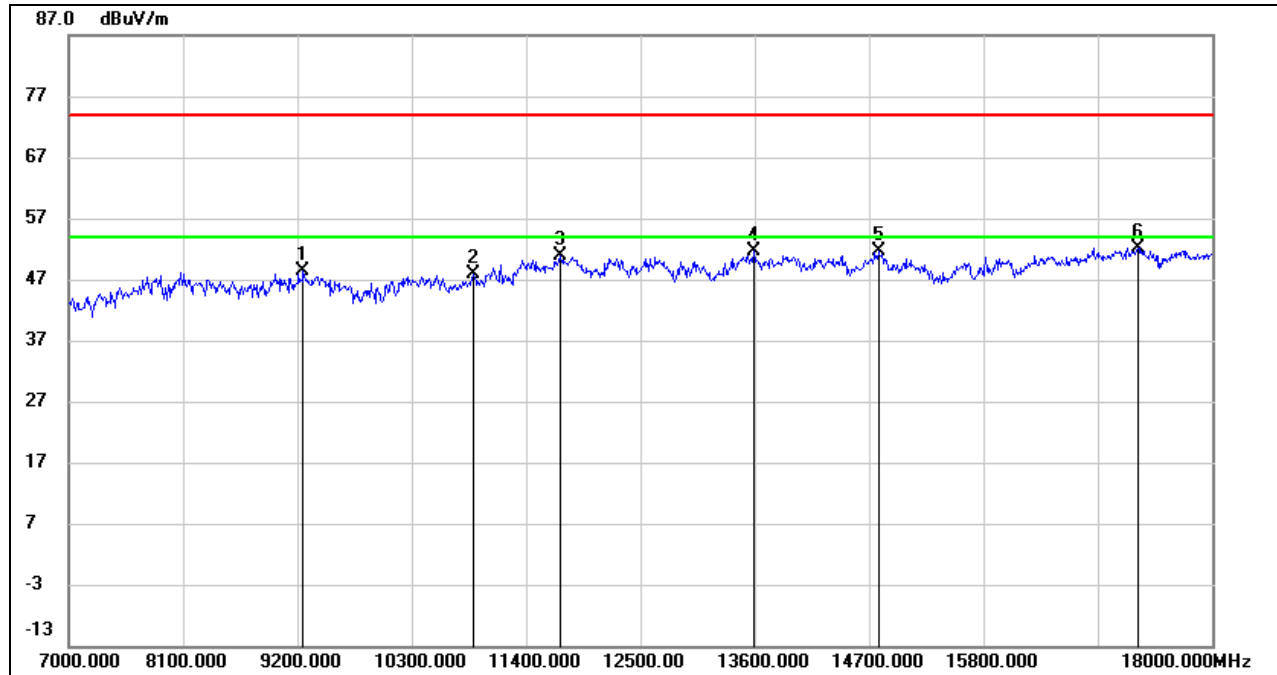

No.	Frequency (MHz)	Reading (dBuV)	Correct (dB/m)	Result (dBuV/m)	Limit (dBuV/m)	Margin (dB)	Remark
1	9255.000	38.21	10.17	48.38	74.00	-25.62	peak
2	10894.000	34.47	13.34	47.81	74.00	-26.19	peak
3	11730.000	35.47	15.32	50.79	74.00	-23.21	peak
4	13589.000	34.62	17.11	51.73	74.00	-22.27	peak
5	14788.000	33.53	18.00	51.53	74.00	-22.47	peak
6	17285.000	29.60	22.52	52.12	74.00	-21.88	peak

- Note: 1. Measurement = Reading Level + Correct Factor.
 2. If Peak Result complies with AV limit, AV Result is deemed to comply with AV limit.
 3. Peak: Peak detector.
 4. AVG: $VBW=1/T_{on}$, where: T_{on} is the transmitting duration.
 5. For the transmitting duration, please refer to clause 7.1.
 6. Filter losses were only considered in the spurious frequency bands and the authorized band was not corrected for High Pass Filter losses.
 7. Proper operation of the transmitter prior to adding the filter to the measurement chain.
 8. Owing to the highest peak level of unwanted emission out of the restricted bands complies with the lowest limit(54dBuV/m), so all the test point was deemed to comply with the limits list in the standard.

HARMONICS AND SPURIOUS EMISSIONS (LOW CHANNEL, VERTICAL)

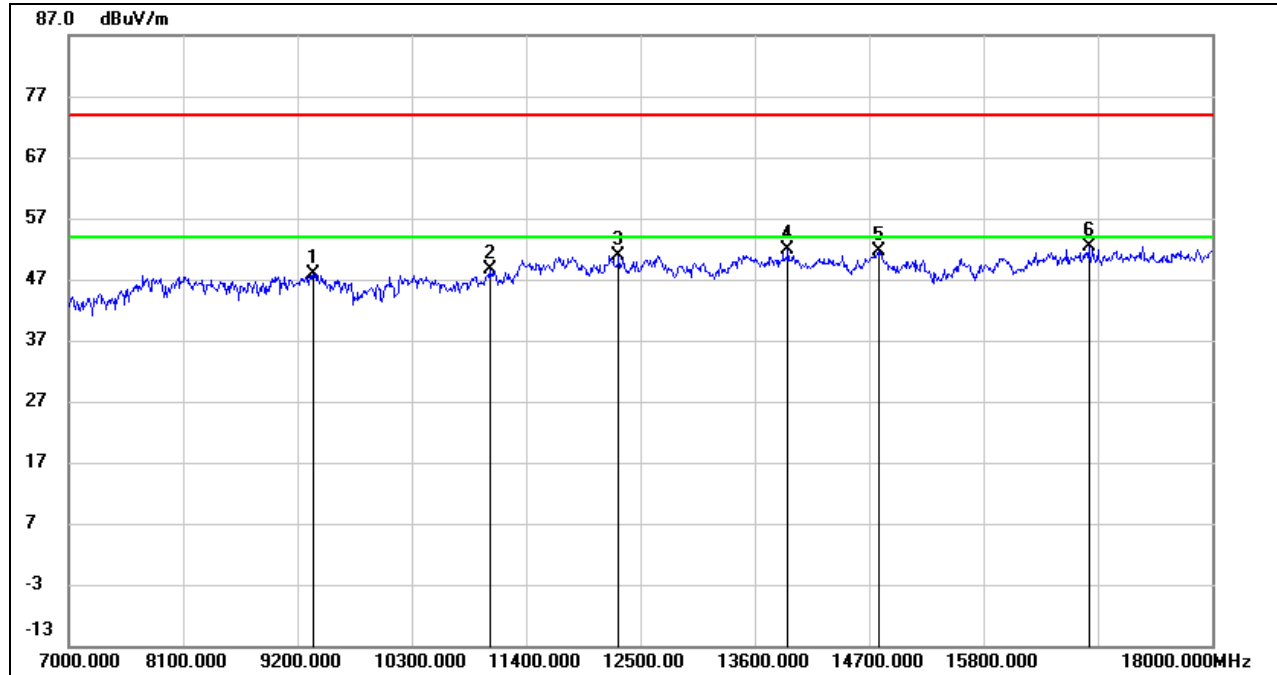

No.	Frequency (MHz)	Reading (dBuV)	Correct (dB/m)	Result (dBuV/m)	Limit (dBuV/m)	Margin (dB)	Remark
1	9354.000	37.24	10.70	47.94	74.00	-26.06	peak
2	11048.000	34.99	13.54	48.53	74.00	-25.47	peak
3	12291.000	34.78	16.08	50.86	74.00	-23.14	peak
4	13919.000	34.45	17.55	52.00	74.00	-22.00	peak
5	14799.000	33.50	18.04	51.54	74.00	-22.46	peak
6	16812.000	31.61	20.81	52.42	74.00	-21.58	peak

Note: 1. Measurement = Reading Level + Correct Factor.

2. If Peak Result complies with AV limit, AV Result is deemed to comply with AV limit.

3. Peak: Peak detector.

4. AVG: $VBW=1/T_{on}$, where: T_{on} is the transmitting duration.

5. For the transmitting duration, please refer to clause 7.1.

6. Filter losses were only considered in the spurious frequency bands and the authorized band was not corrected for High Pass Filter losses.

7. Proper operation of the transmitter prior to adding the filter to the measurement chain.

8. Owing to the highest peak level of unwanted emission out of the restricted bands complies with the lowest limit(54dBuV/m), so all the test point was deemed to comply with the limits list in the standard.

HARMONICS AND SPURIOUS EMISSIONS (HIGH CHANNEL, HORIZONTAL)

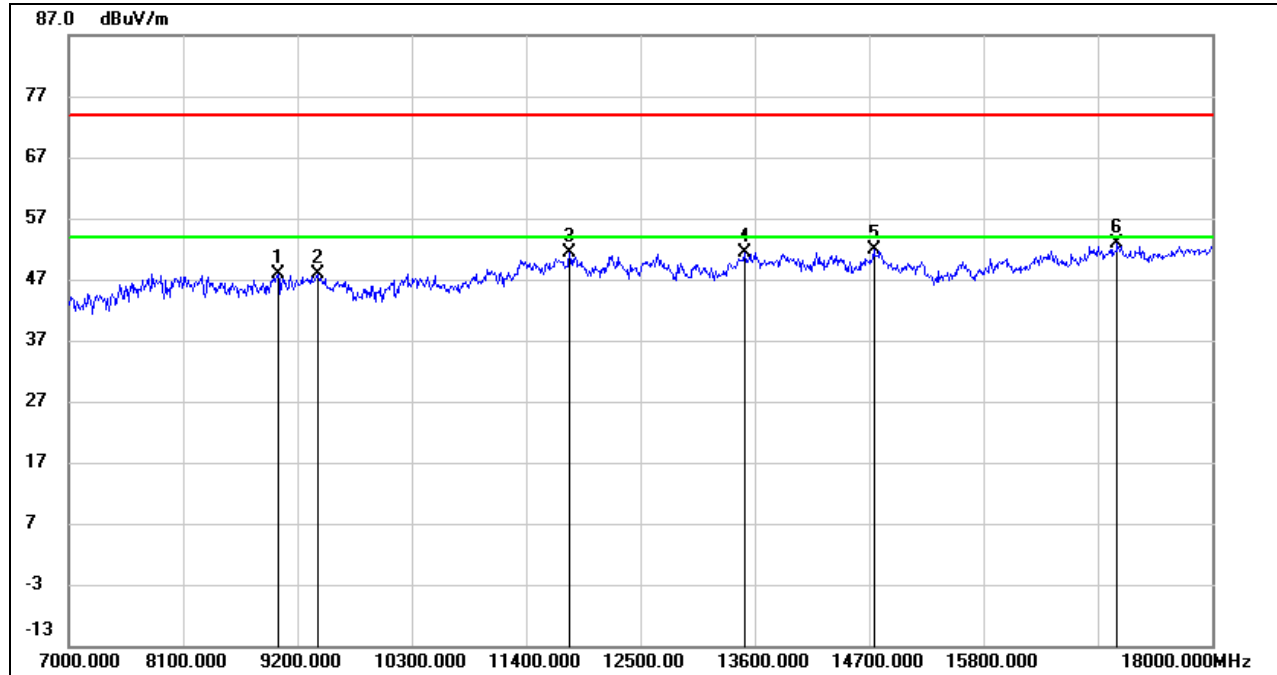

No.	Frequency (MHz)	Reading (dBuV)	Correct (dB/m)	Result (dBuV/m)	Limit (dBuV/m)	Margin (dB)	Remark
1	9013.000	36.81	11.12	47.93	74.00	-26.07	peak
2	9398.000	36.99	10.96	47.95	74.00	-26.05	peak
3	11818.000	35.98	15.29	51.27	74.00	-22.73	peak
4	13501.000	34.10	17.22	51.32	74.00	-22.68	peak
5	14744.000	34.14	17.84	51.98	74.00	-22.02	peak
6	17087.000	31.00	21.81	52.81	74.00	-21.19	peak

Note: 1. Measurement = Reading Level + Correct Factor.

2. If Peak Result complies with AV limit, AV Result is deemed to comply with AV limit.

3. Peak: Peak detector.

4. AVG: $VBW=1/Ton$, where: Ton is the transmitting duration.

5. For the transmitting duration, please refer to clause 7.1.

6. Filter losses were only considered in the spurious frequency bands and the authorized band was not corrected for High Pass Filter losses.

7. Proper operation of the transmitter prior to adding the filter to the measurement chain.

8. Owing to the highest peak level of unwanted emission out of the restricted bands complies with the lowest limit(54dBuV/m), so all the test point was deemed to comply with the limits list in the standard.

HARMONICS AND SPURIOUS EMISSIONS (HIGH CHANNEL, VERTICAL)

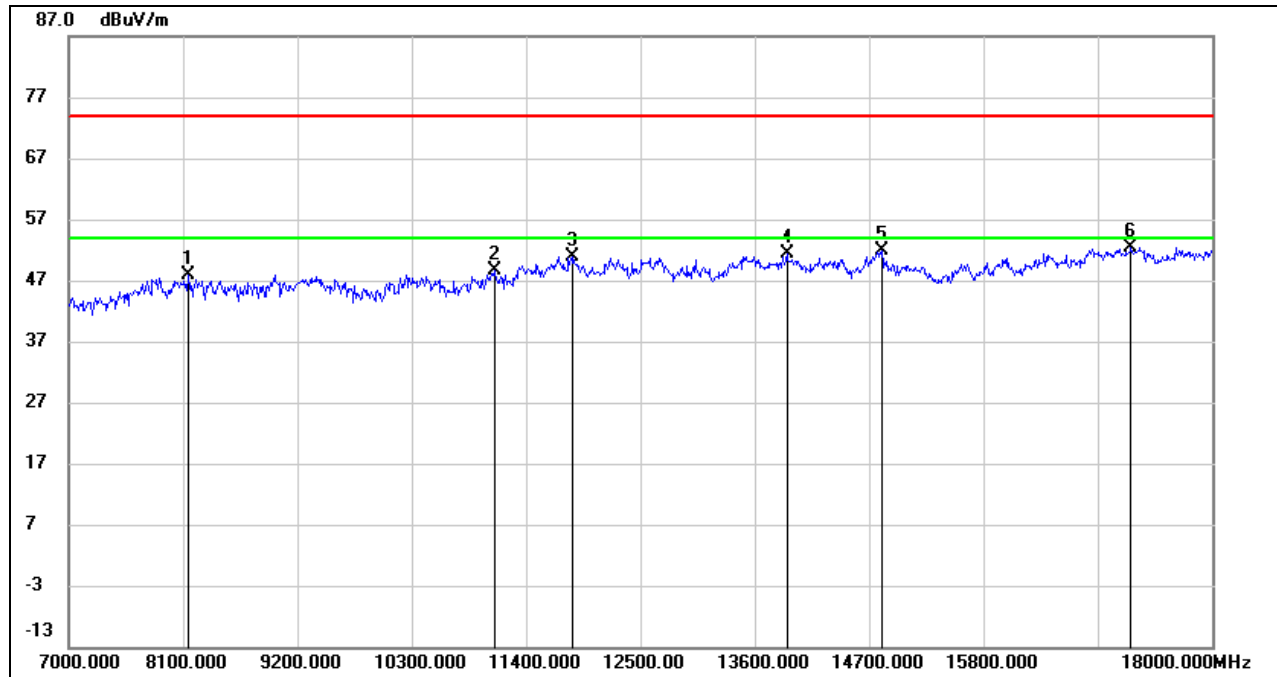

No.	Frequency (MHz)	Reading (dBuV)	Correct (dB/m)	Result (dBuV/m)	Limit (dBuV/m)	Margin (dB)	Remark
1	8155.000	37.93	9.98	47.91	74.00	-26.09	peak
2	11092.000	34.92	13.75	48.67	74.00	-25.33	peak
3	11851.000	35.51	15.38	50.89	74.00	-23.11	peak
4	13908.000	33.77	17.54	51.31	74.00	-22.69	peak
5	14821.000	33.95	17.90	51.85	74.00	-22.15	peak
6	17219.000	30.24	22.11	52.35	74.00	-21.65	peak

Note: 1. Measurement = Reading Level + Correct Factor.

2. If Peak Result complies with AV limit, AV Result is deemed to comply with AV limit.

3. Peak: Peak detector.

4. AVG: $VBW=1/Ton$, where: Ton is the transmitting duration.

5. For the transmitting duration, please refer to clause 7.1.

6. Filter losses were only considered in the spurious frequency bands and the authorized band was not corrected for High Pass Filter losses.

7. Proper operation of the transmitter prior to adding the filter to the measurement chain.

8. Owing to the highest peak level of unwanted emission out of the restricted bands complies with the lowest limit(54dBuV/m), so all the test point was deemed to comply with the limits list in the standard.

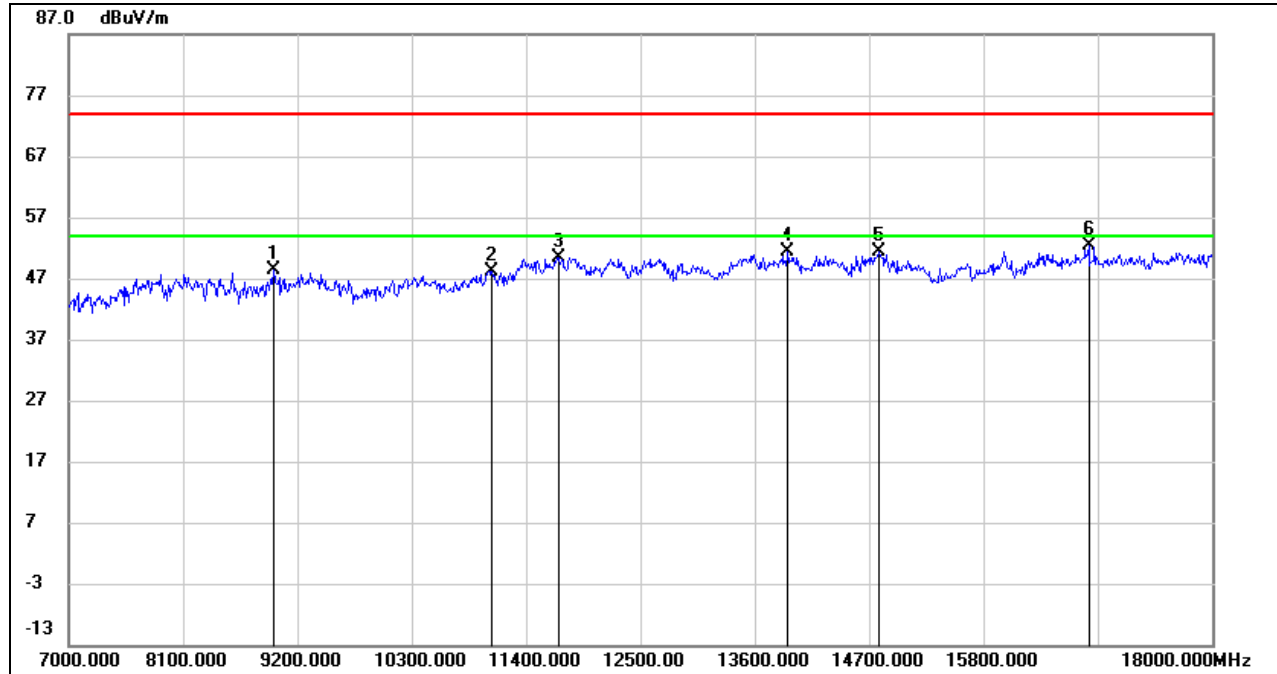
UNII-3 BAND
HARMONICS AND SPURIOUS EMISSIONS (LOW CHANNEL, HORIZONTAL)

No.	Frequency (MHz)	Reading (dBuV)	Correct (dB/m)	Result (dBuV/m)	Limit (dBuV/m)	Margin (dB)	Remark
1	8969.000	37.79	10.69	48.48	74.00	-25.52	peak
2	11070.000	34.58	13.65	48.23	74.00	-25.77	peak
3	11708.000	35.04	15.34	50.38	74.00	-23.62	peak
4	13919.000	33.85	17.55	51.40	74.00	-22.60	peak
5	14799.000	33.42	18.04	51.46	74.00	-22.54	peak
6	16812.000	31.55	20.81	52.36	74.00	-21.64	peak

Note: 1. Measurement = Reading Level + Correct Factor.

2. If Peak Result complies with AV limit, AV Result is deemed to comply with AV limit.

3. Peak: Peak detector.

4. AVG: $VBW=1/Ton$, where: Ton is the transmitting duration.

5. For the transmitting duration, please refer to clause 7.1.

6. Filter losses were only considered in the spurious frequency bands and the authorized band was not corrected for High Pass Filter losses.

7. Proper operation of the transmitter prior to adding the filter to the measurement chain.

8. Owing to the highest peak level of unwanted emission out of the restricted bands complies with the lowest limit(54dBuV/m), so all the test point was deemed to comply with the limits list in the standard.

HARMONICS AND SPURIOUS EMISSIONS (LOW CHANNEL, VERTICAL)

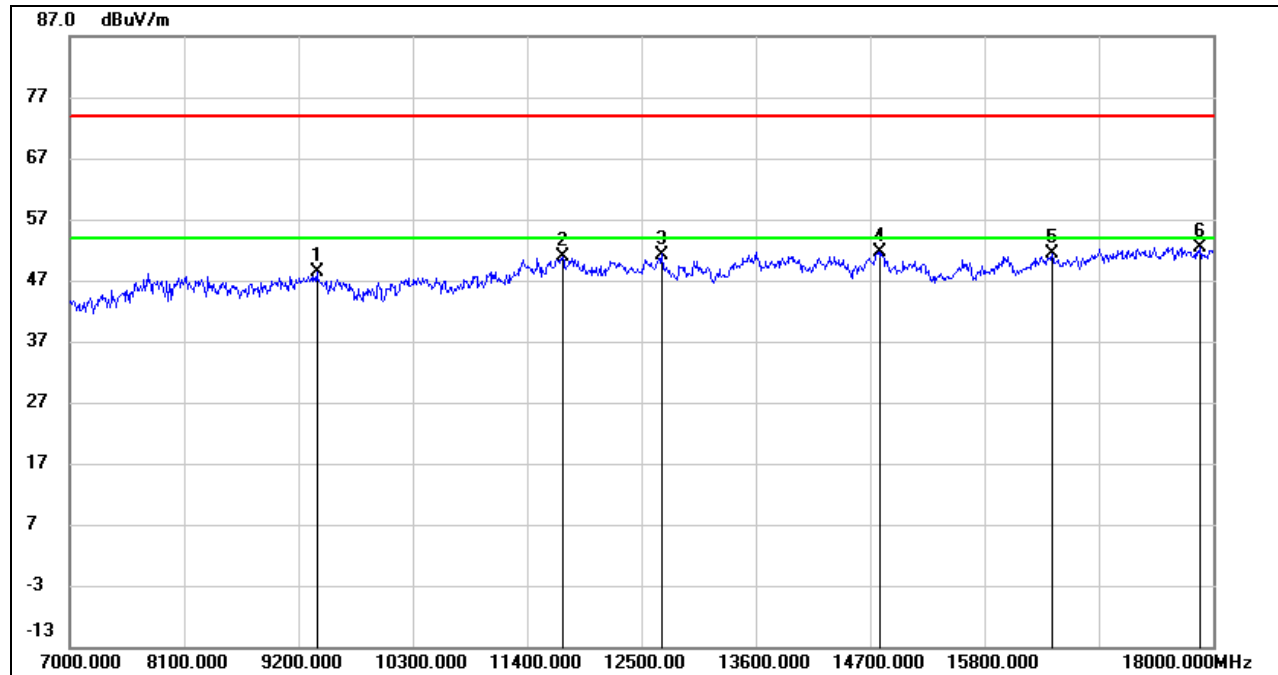

No.	Frequency (MHz)	Reading (dBuV)	Correct (dB/m)	Result (dBuV/m)	Limit (dBuV/m)	Margin (dB)	Remark
1	9376.000	37.62	10.84	48.46	74.00	-25.54	peak
2	11741.000	35.61	15.30	50.91	74.00	-23.09	peak
3	12698.000	35.63	15.62	51.25	74.00	-22.75	peak
4	14799.000	33.62	18.04	51.66	74.00	-22.34	peak
5	16449.000	31.76	19.69	51.45	74.00	-22.55	peak
6	17879.000	28.49	23.92	52.41	74.00	-21.59	peak

- Note:
1. Measurement = Reading Level + Correct Factor.
 2. If Peak Result complies with AV limit, AV Result is deemed to comply with AV limit.
 3. Peak: Peak detector.
 4. AVG: $VBW=1/Ton$, where: Ton is the transmitting duration.
 5. For the transmitting duration, please refer to clause 7.1.
 6. Filter losses were only considered in the spurious frequency bands and the authorized band was not corrected for High Pass Filter losses.
 7. Proper operation of the transmitter prior to adding the filter to the measurement chain.
 8. Owing to the highest peak level of unwanted emission out of the restricted bands complies with the lowest limit(54dBuV/m), so all the test point was deemed to comply with the limits list in the standard.

HARMONICS AND SPURIOUS EMISSIONS (HIGH CHANNEL, HORIZONTAL)

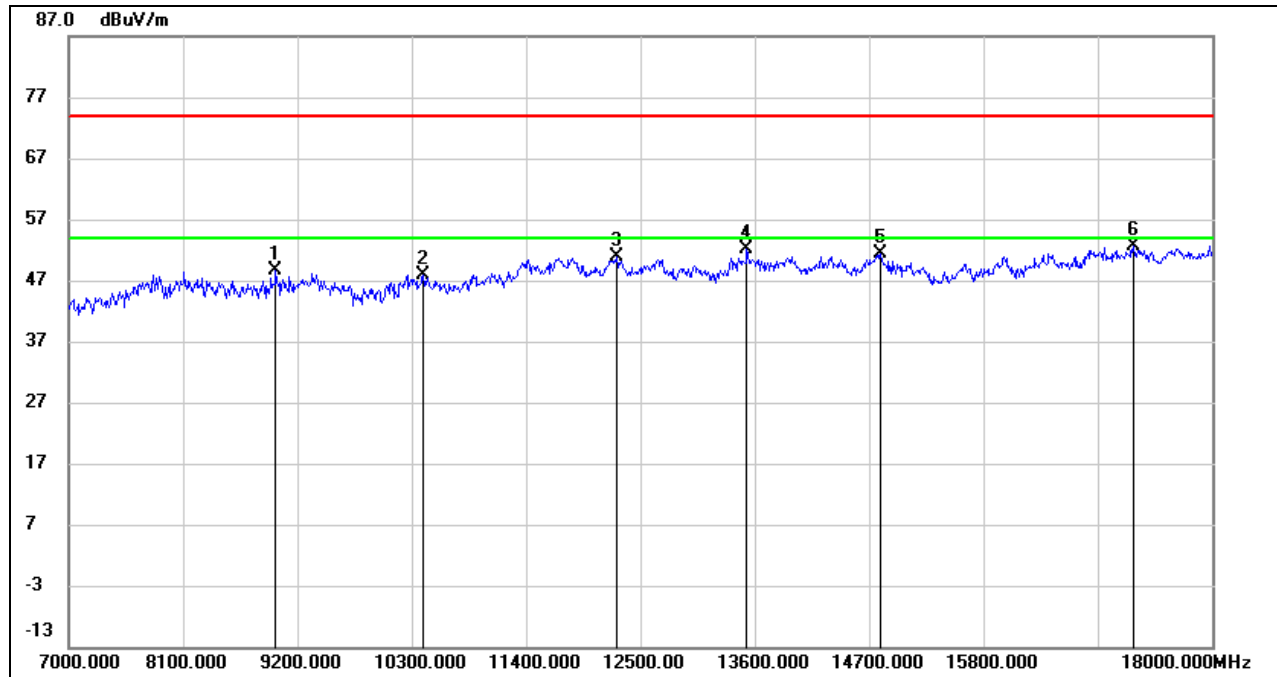

No.	Frequency (MHz)	Reading (dBuV)	Correct (dB/m)	Result (dBuV/m)	Limit (dBuV/m)	Margin (dB)	Remark
1	8991.000	37.48	11.10	48.58	74.00	-25.42	peak
2	10410.000	35.68	12.25	47.93	74.00	-26.07	peak
3	12269.000	34.85	16.04	50.89	74.00	-23.11	peak
4	13523.000	34.92	17.19	52.11	74.00	-21.89	peak
5	14810.000	33.53	17.97	51.50	74.00	-22.50	peak
6	17241.000	30.47	22.24	52.71	74.00	-21.29	peak

- Note:
1. Measurement = Reading Level + Correct Factor.
 2. If Peak Result complies with AV limit, AV Result is deemed to comply with AV limit.
 3. Peak: Peak detector.
 4. AVG: $VBW=1/Ton$, where: Ton is the transmitting duration.
 5. For the transmitting duration, please refer to clause 7.1.
 6. Filter losses were only considered in the spurious frequency bands and the authorized band was not corrected for High Pass Filter losses.
 7. Proper operation of the transmitter prior to adding the filter to the measurement chain.
 8. Owing to the highest peak level of unwanted emission out of the restricted bands complies with the lowest limit(54dBuV/m), so all the test point was deemed to comply with the limits list in the standard.

HARMONICS AND SPURIOUS EMISSIONS (HIGH CHANNEL, VERTICAL)

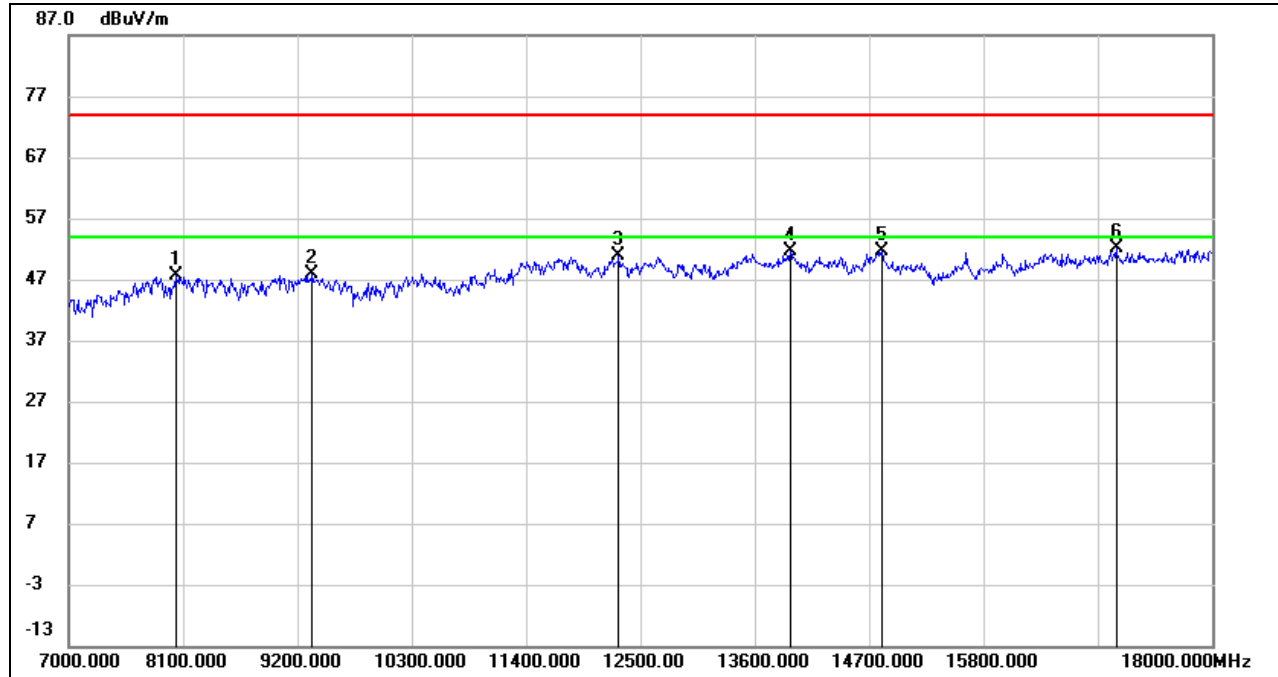

No.	Frequency (MHz)	Reading (dBuV)	Correct (dB/m)	Result (dBuV/m)	Limit (dBuV/m)	Margin (dB)	Remark
1	8034.000	38.54	9.15	47.69	74.00	-26.31	peak
2	9343.000	37.31	10.64	47.95	74.00	-26.05	peak
3	12291.000	34.76	16.08	50.84	74.00	-23.16	peak
4	13941.000	34.05	17.58	51.63	74.00	-22.37	peak
5	14821.000	33.72	17.90	51.62	74.00	-22.38	peak
6	17076.000	30.39	21.74	52.13	74.00	-21.87	peak

- Note:
1. Measurement = Reading Level + Correct Factor.
 2. If Peak Result complies with AV limit, AV Result is deemed to comply with AV limit.
 3. Peak: Peak detector.
 4. AVG: VBW=1/Ton, where: Ton is the transmitting duration.
 5. For the transmitting duration, please refer to clause 7.1.
 6. Filter losses were only considered in the spurious frequency bands and the authorized band was not corrected for High Pass Filter losses.
 7. Proper operation of the transmitter prior to adding the filter to the measurement chain.
 8. Owing to the highest peak level of unwanted emission out of the restricted bands complies with the lowest limit(54dBuV/m), so all the test point was deemed to comply with the limits list in the standard.

8.3.4. 802.11ac VHT80 MIMO MODE

UNII-1 BAND

HARMONICS AND SPURIOUS EMISSIONS (LOW CHANNEL, HORIZONTAL)

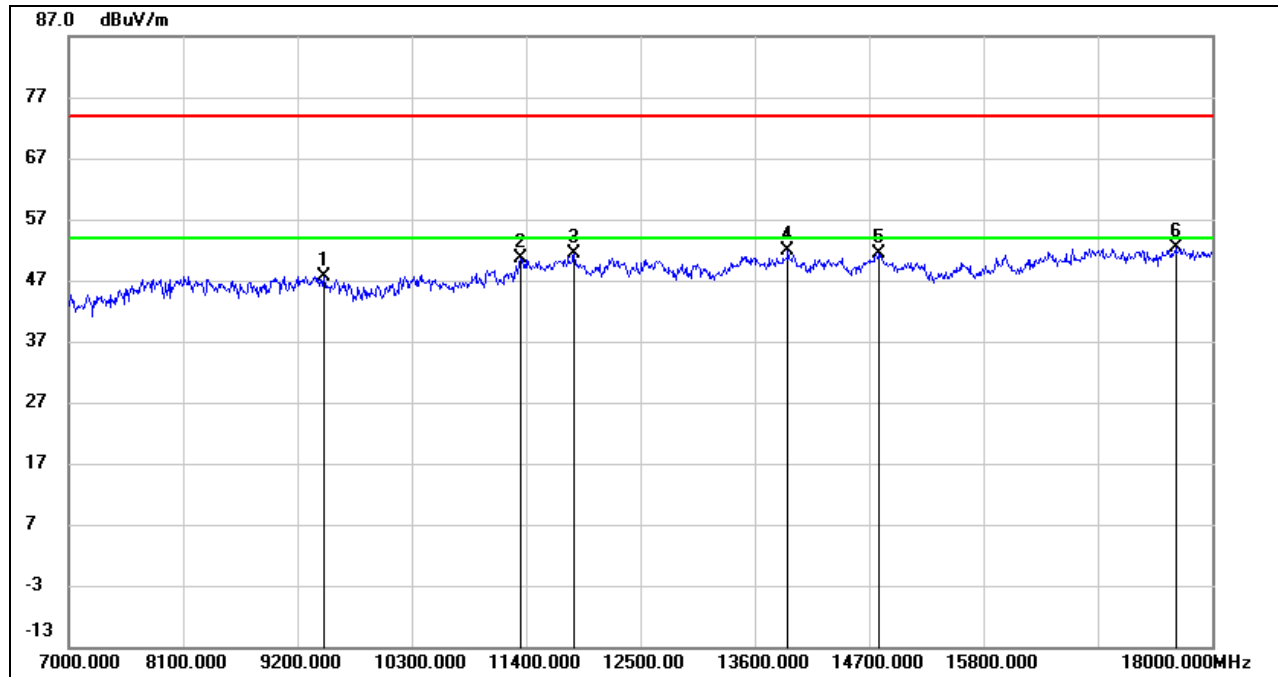

No.	Frequency (MHz)	Reading (dBuV)	Correct (dB/m)	Result (dBuV/m)	Limit (dBuV/m)	Margin (dB)	Remark
1	9453.000	36.96	10.74	47.70	74.00	-26.30	peak
2	11345.000	36.36	14.26	50.62	74.00	-23.38	peak
3	11862.000	36.08	15.41	51.49	74.00	-22.51	peak
4	13919.000	34.34	17.55	51.89	74.00	-22.11	peak
5	14799.000	33.31	18.04	51.35	74.00	-22.65	peak
6	17648.000	29.40	23.08	52.48	74.00	-21.52	peak

Note: 1. Measurement = Reading Level + Correct Factor.

2. If Peak Result complies with AV limit, AV Result is deemed to comply with AV limit.

3. Peak: Peak detector.

4. AVG: $VBW=1/T_{on}$, where: T_{on} is the transmitting duration.

5. For the transmitting duration, please refer to clause 7.1.

6. Filter losses were only considered in the spurious frequency bands and the authorized band was not corrected for High Pass Filter losses.

7. Proper operation of the transmitter prior to adding the filter to the measurement chain.

8. Owing to the highest peak level of unwanted emission out of the restricted bands complies with the lowest limit(54dBuV/m), so all the test point was deemed to comply with the limits list in the standard.

HARMONICS AND SPURIOUS EMISSIONS (LOW CHANNEL, VERTICAL)

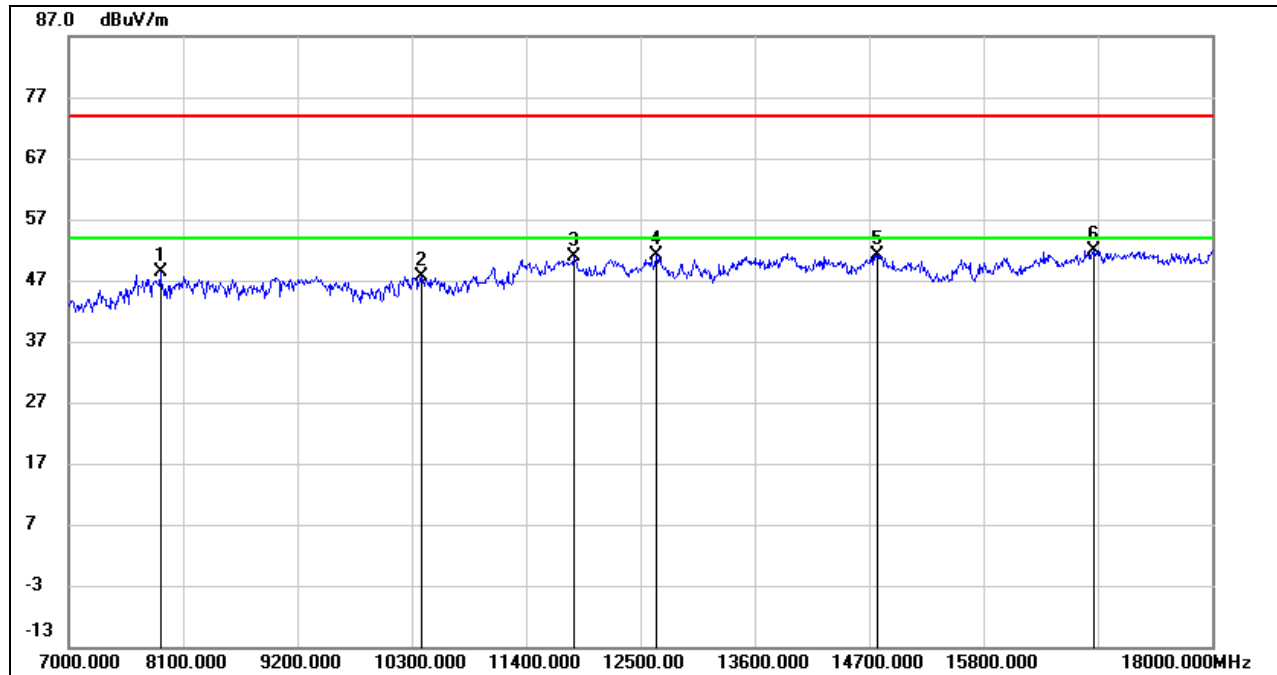

No.	Frequency (MHz)	Reading (dBuV)	Correct (dB/m)	Result (dBuV/m)	Limit (dBuV/m)	Margin (dB)	Remark
1	7880.000	39.40	8.95	48.35	74.00	-25.65	peak
2	10399.000	35.29	12.23	47.52	74.00	-26.48	peak
3	11862.000	35.58	15.41	50.99	74.00	-23.01	peak
4	12654.000	35.49	15.69	51.18	74.00	-22.82	peak
5	14777.000	33.28	17.96	51.24	74.00	-22.76	peak
6	16867.000	30.65	21.29	51.94	74.00	-22.06	peak

- Note:
1. Measurement = Reading Level + Correct Factor.
 2. If Peak Result complies with AV limit, AV Result is deemed to comply with AV limit.
 3. Peak: Peak detector.
 4. AVG: $VBW=1/Ton$, where: Ton is the transmitting duration.
 5. For the transmitting duration, please refer to clause 7.1.
 6. Filter losses were only considered in the spurious frequency bands and the authorized band was not corrected for High Pass Filter losses.
 7. Proper operation of the transmitter prior to adding the filter to the measurement chain.
 8. Owing to the highest peak level of unwanted emission out of the restricted bands complies with the lowest limit(54dBuV/m), so all the test point was deemed to comply with the limits list in the standard.

UNII-3 BAND

HARMONICS AND SPURIOUS EMISSIONS (LOW CHANNEL, HORIZONTAL)

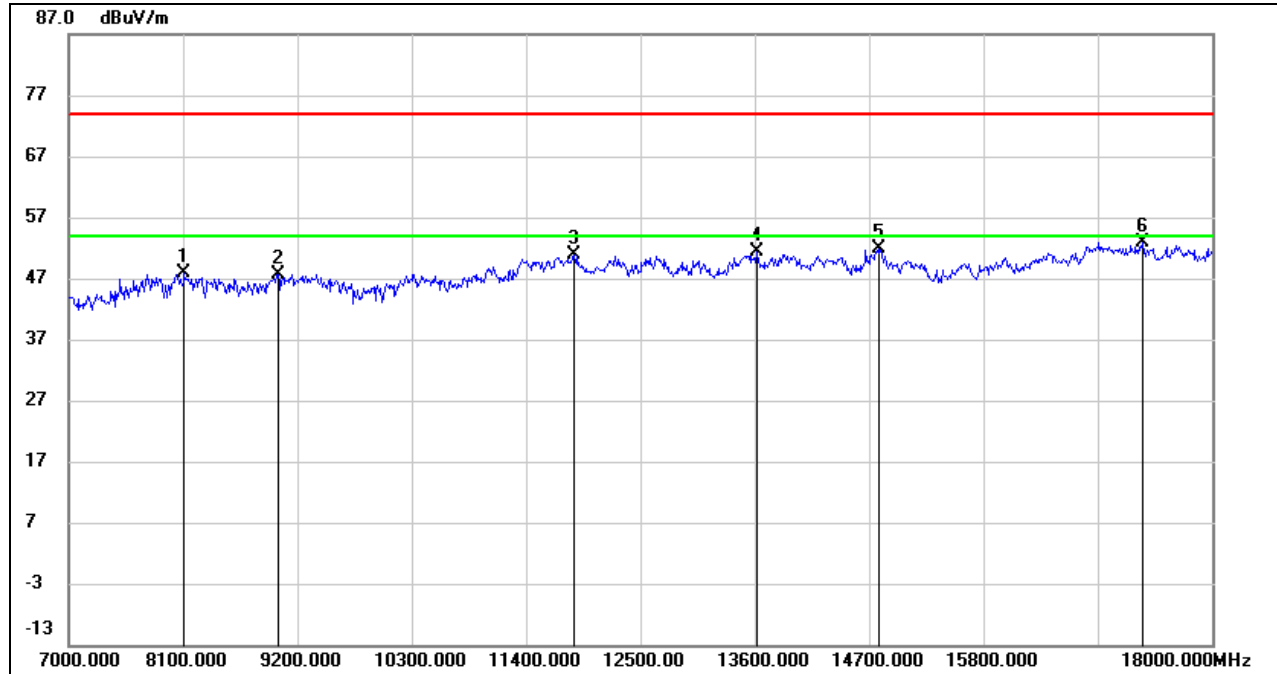

No.	Frequency (MHz)	Reading (dBuV)	Correct (dB/m)	Result (dBuV/m)	Limit (dBuV/m)	Margin (dB)	Remark
1	8111.000	37.81	10.14	47.95	74.00	-26.05	peak
2	9013.000	36.63	11.12	47.75	74.00	-26.25	peak
3	11862.000	35.37	15.41	50.78	74.00	-23.22	peak
4	13622.000	34.11	17.20	51.31	74.00	-22.69	peak
5	14799.000	33.85	18.04	51.89	74.00	-22.11	peak
6	17329.000	30.54	22.39	52.93	74.00	-21.07	peak

Note: 1. Measurement = Reading Level + Correct Factor.
 2. If Peak Result complies with AV limit, AV Result is deemed to comply with AV limit.
 3. Peak: Peak detector.
 4. AVG: $VBW=1/Ton$, where: Ton is the transmitting duration.
 5. For the transmitting duration, please refer to clause 7.1.
 6. Filter losses were only considered in the spurious frequency bands and the authorized band was not corrected for High Pass Filter losses.
 7. Proper operation of the transmitter prior to adding the filter to the measurement chain.
 8. Owing to the highest peak level of unwanted emission out of the restricted bands complies with the lowest limit(54dBuV/m), so all the test point was deemed to comply with the limits list in the standard.

HARMONICS AND SPURIOUS EMISSIONS (LOW CHANNEL, VERTICAL)

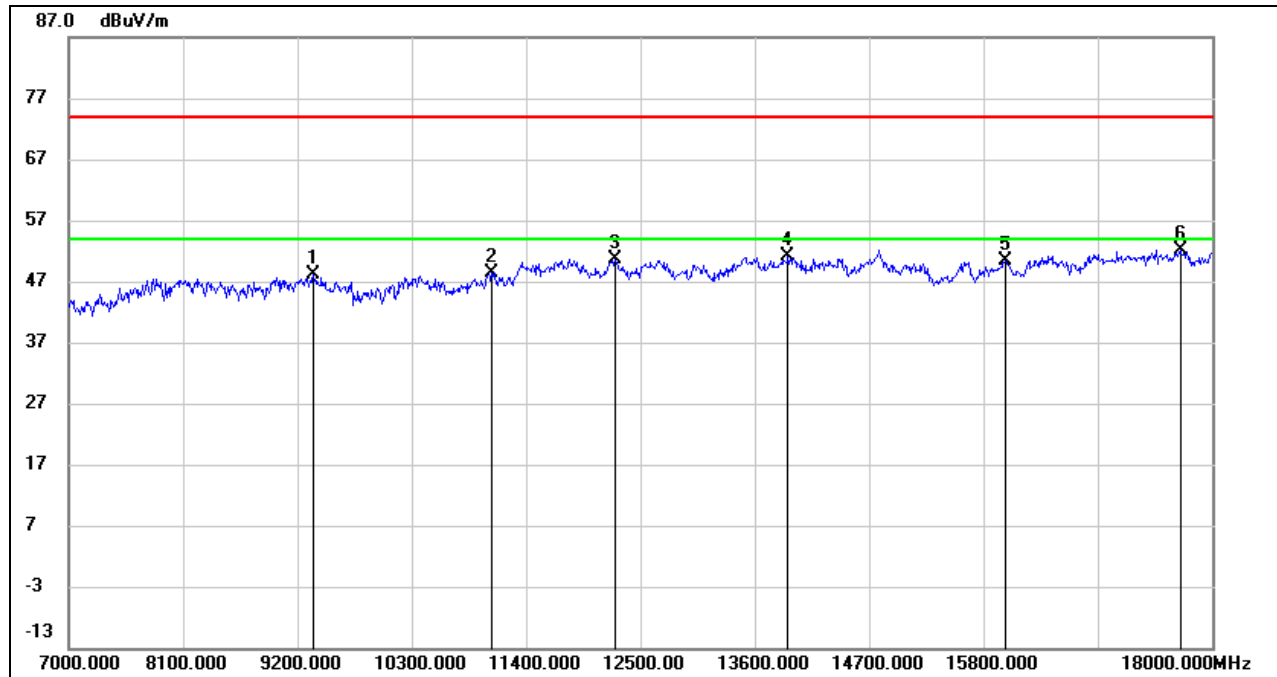

No.	Frequency (MHz)	Reading (dBuV)	Correct (dB/m)	Result (dBuV/m)	Limit (dBuV/m)	Margin (dB)	Remark
1	9354.000	37.40	10.70	48.10	74.00	-25.90	peak
2	11070.000	34.82	13.65	48.47	74.00	-25.53	peak
3	12258.000	34.72	16.03	50.75	74.00	-23.25	peak
4	13919.000	33.48	17.55	51.03	74.00	-22.97	peak
5	16009.000	32.02	18.41	50.43	74.00	-23.57	peak
6	17692.000	28.75	23.41	52.16	74.00	-21.84	peak

- Note:
1. Measurement = Reading Level + Correct Factor.
 2. If Peak Result complies with AV limit, AV Result is deemed to comply with AV limit.
 3. Peak: Peak detector.
 4. AVG: $VBW=1/Ton$, where: Ton is the transmitting duration.
 5. For the transmitting duration, please refer to clause 7.1.
 6. Filter losses were only considered in the spurious frequency bands and the authorized band was not corrected for High Pass Filter losses.
 7. Proper operation of the transmitter prior to adding the filter to the measurement chain.
 8. Owing to the highest peak level of unwanted emission out of the restricted bands complies with the lowest limit(54dBuV/m), so all the test point was deemed to comply with the limits list in the standard.

8.4. SPURIOUS EMISSIONS (18 GHz ~ 26 GHz)

8.4.1. 802.11n HT40 MIMO MODE

SPURIOUS EMISSIONS (UNII-3 BAND LOW CHANNEL, HORIZONTAL, WORST-CASE CONFIGURATION)

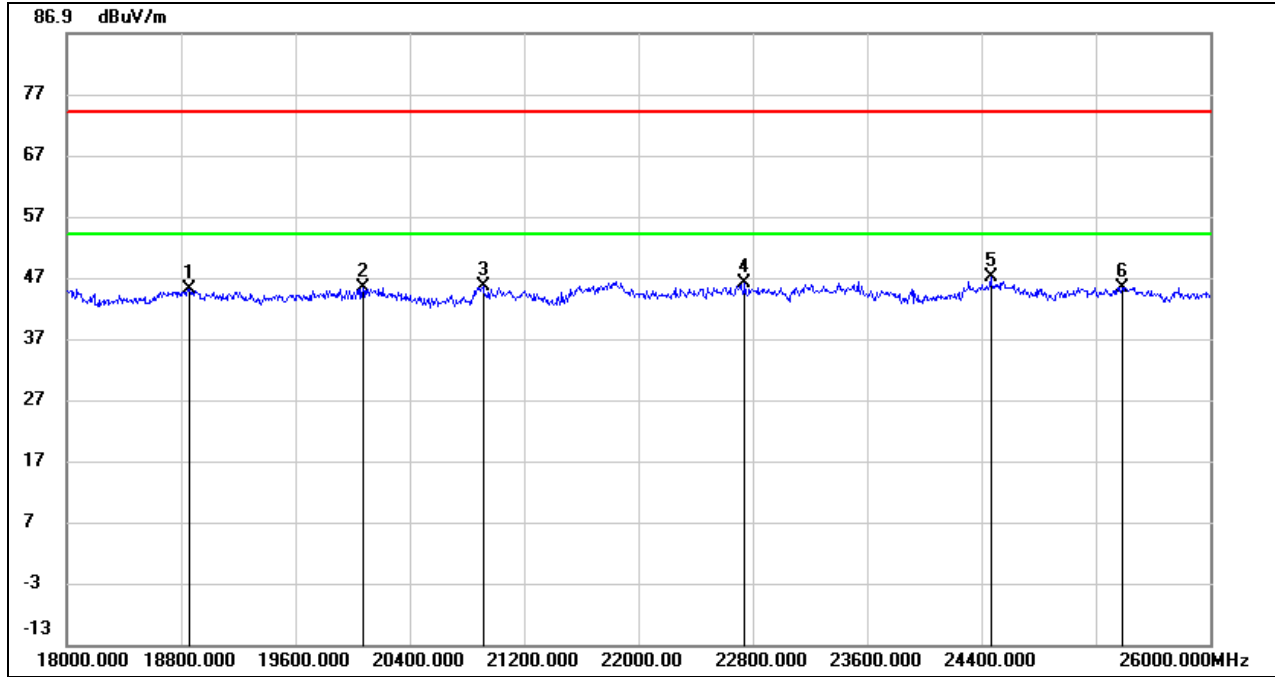

No.	Frequency (MHz)	Reading (dBuV)	Correct (dB/m)	Result (dBuV/m)	Limit (dBuV/m)	Margin (dB)	Remark
1	18856.000	49.99	-4.87	45.12	74.00	-28.88	peak
2	20072.000	49.84	-4.51	45.33	74.00	-28.67	peak
3	20912.000	50.67	-5.22	45.45	74.00	-28.55	peak
4	22744.000	51.68	-5.74	45.94	74.00	-28.06	peak
5	24464.000	49.78	-2.74	47.04	74.00	-26.96	peak
6	25384.000	46.92	-1.53	45.39	74.00	-28.61	peak

Note: 1. Measurement = Reading Level + Correct Factor.
 2. If Peak Result complies with AV limit, AV Result is deemed to comply with AV limit.
 3. Peak: Peak detector.
 4. The preamplifier only effect to the above 18GHz signal and no filter added to the measurement chain.



SPURIOUS EMISSIONS (LOW CHANNEL, VERTICAL, WORST-CASE CONFIGURATION)

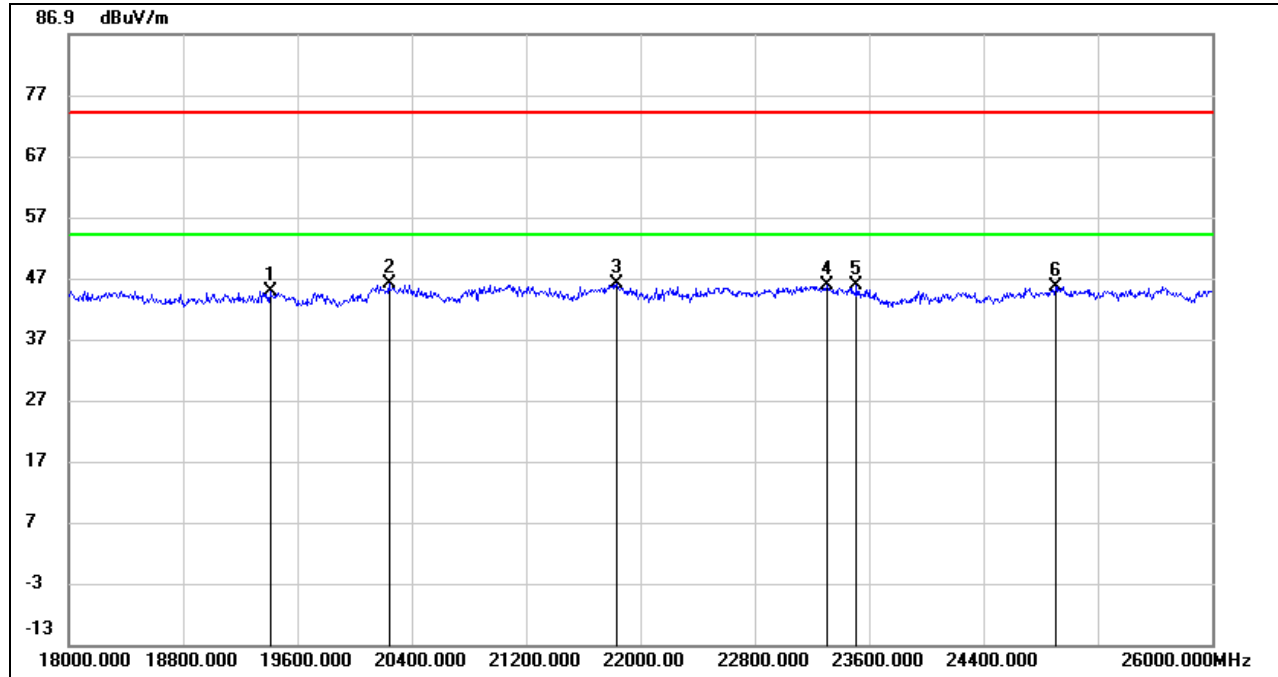

No.	Frequency (MHz)	Reading (dBuV)	Correct (dB/m)	Result (dBuV/m)	Limit (dBuV/m)	Margin (dB)	Remark
1	19408.000	49.73	-4.89	44.84	74.00	-29.16	peak
2	20240.000	50.85	-4.86	45.99	74.00	-28.01	peak
3	21832.000	52.03	-5.92	46.11	74.00	-27.89	peak
4	23304.000	50.87	-5.16	45.71	74.00	-28.29	peak
5	23512.000	50.51	-4.76	45.75	74.00	-28.25	peak
6	24904.000	47.03	-1.42	45.61	74.00	-28.39	peak

Note: 1. Measurement = Reading Level + Correct Factor.
 2. If Peak Result complies with AV limit, AV Result is deemed to comply with AV limit.
 3. Peak: Peak detector.
 4. The preamplifier only effect to the above 18GHz signal and no filter added to the measurement chain.

Note: All the channels and modes antennas had been tested, but only the worst data was recorded in the report.

8.5. SPURIOUS EMISSIONS (26 GHz ~ 40 GHz)

8.5.1. 802.11n HT40 MIMO MODE

SPURIOUS EMISSIONS (UNII-3 BAND LOW CHANNEL, HORIZONTAL, WORST-CASE CONFIGURATION)

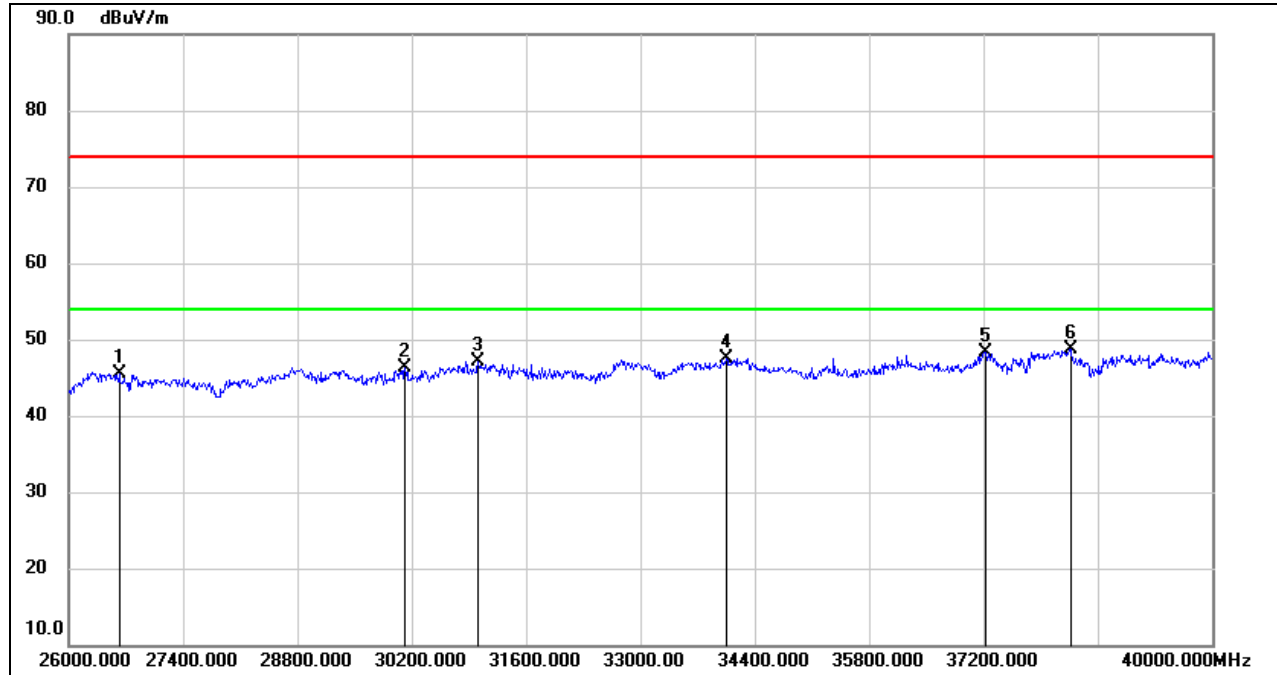

No.	Frequency (MHz)	Reading (dBuV)	Correct (dB/m)	Result (dBuV/m)	Limit (dBuV/m)	Margin (dB)	Remark
1	26616.000	50.25	-4.82	45.43	74.00	-28.57	peak
2	30116.000	47.63	-1.30	46.33	74.00	-27.67	peak
3	31012.000	47.83	-0.71	47.12	74.00	-26.88	peak
4	34050.000	46.32	1.12	47.44	74.00	-26.56	peak
5	37228.000	45.23	3.14	48.37	74.00	-25.63	peak
6	38264.000	44.90	3.84	48.74	74.00	-25.26	peak

- Note: 1. Measurement = Reading Level + Correct Factor.
 2. If Peak Result complies with AV limit, AV Result is deemed to comply with AV limit.
 3. Peak: Peak detector.
 4. Proper operation of the transmitter prior to adding the filter to the measurement chain.

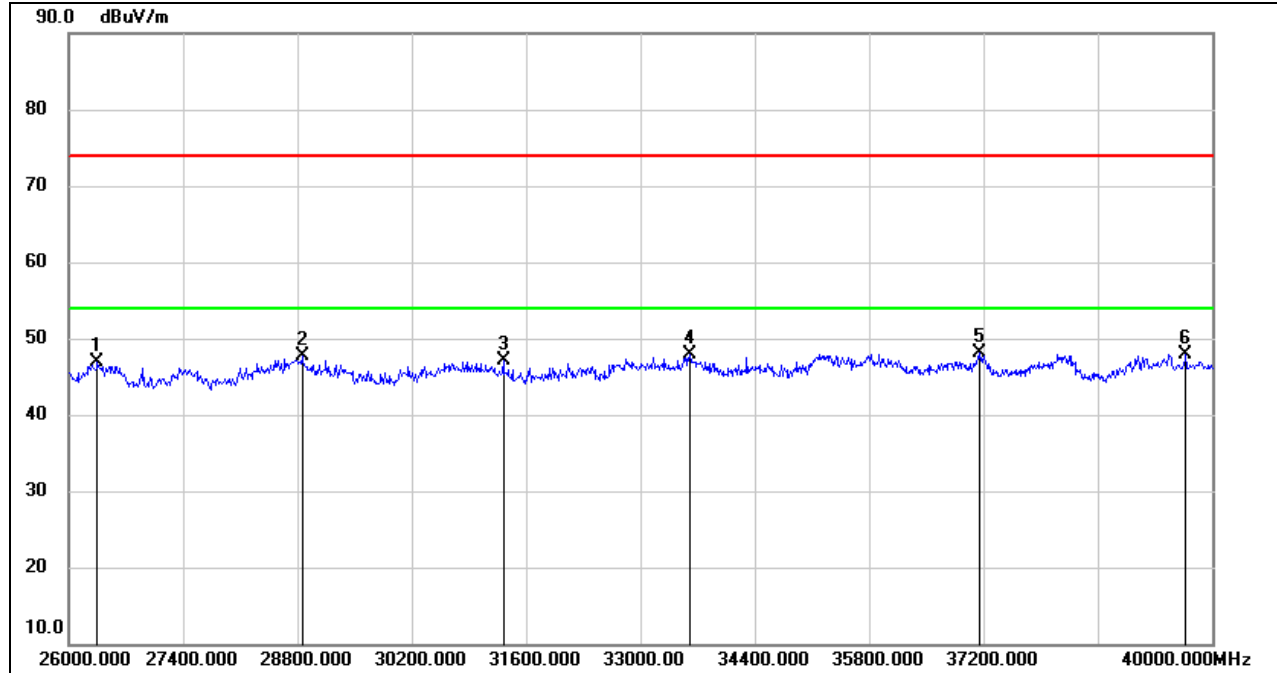
**SPURIOUS EMISSIONS (LOW CHANNEL, VERTICAL, WORST-CASE CONFIGURATION)**

No.	Frequency (MHz)	Reading (dBuV)	Correct (dB/m)	Result (dBuV/m)	Limit (dBuV/m)	Margin (dB)	Remark
1	26350.000	52.00	-5.11	46.89	74.00	-27.11	peak
2	28856.000	48.61	-0.90	47.71	74.00	-26.29	peak
3	31320.000	48.11	-0.93	47.18	74.00	-26.82	peak
4	33602.000	47.51	0.46	47.97	74.00	-26.03	peak
5	37158.000	44.84	3.17	48.01	74.00	-25.99	peak
6	39678.000	43.02	4.87	47.89	74.00	-26.11	peak

- Note: 1. Measurement = Reading Level + Correct Factor.
 2. If Peak Result complies with AV limit, AV Result is deemed to comply with AV limit.
 3. Peak: Peak detector.
 4. Proper operation of the transmitter prior to adding the filter to the measurement chain.

Note: All the channels and modes antennas had been tested, but only the worst data was recorded in the report.

8.6. SPURIOUS EMISSIONS (30 MHz ~ 1 GHz)

8.6.1. 802.11n HT40 MIMO MODE

SPURIOUS EMISSIONS (UNII-3 BAND LOW CHANNEL, HORIZONTAL, WORST-CASE CONFIGURATION)

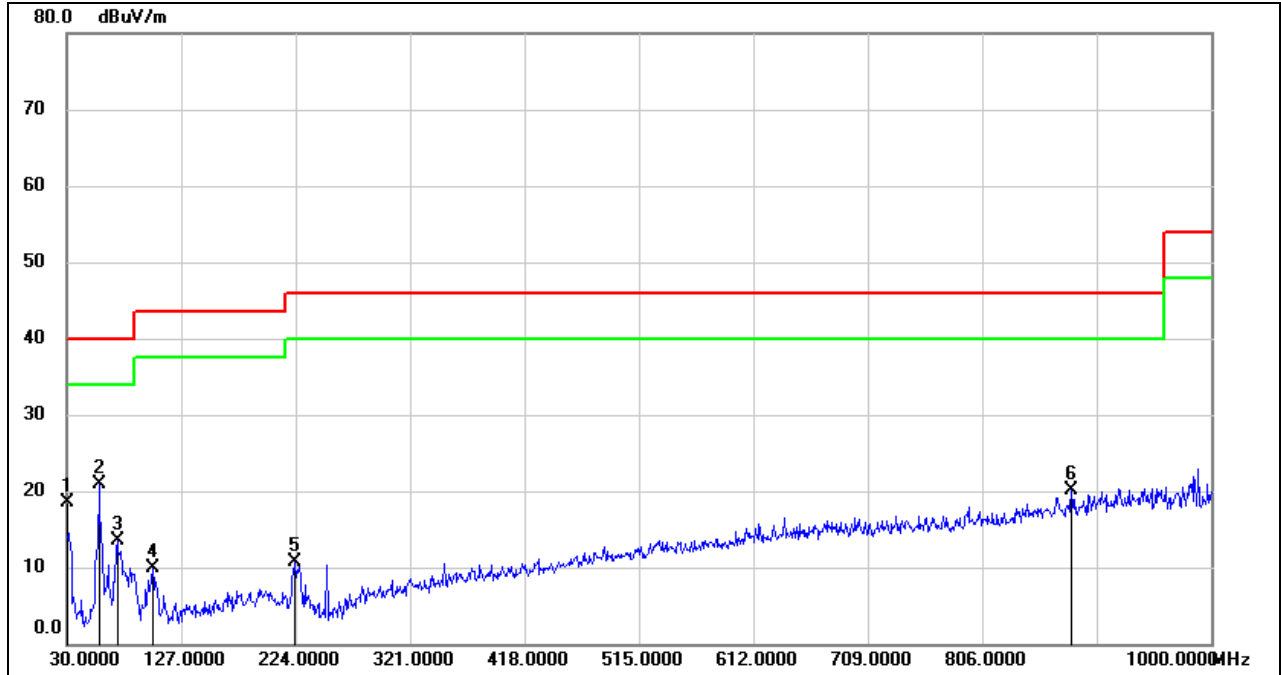

No.	Frequency (MHz)	Reading (dBuV)	Correct (dB/m)	Result (dBuV/m)	Limit (dBuV/m)	Margin (dB)	Remark
1	30.0000	37.44	-18.94	18.50	40.00	-21.50	QP
2	57.1600	41.39	-20.58	20.81	40.00	-19.19	QP
3	72.6800	34.23	-20.76	13.47	40.00	-26.53	QP
4	102.7500	30.87	-20.91	9.96	43.50	-33.54	QP
5	223.0300	29.06	-18.32	10.74	46.00	-35.26	QP
6	881.6600	25.65	-5.48	20.17	46.00	-25.83	QP

- Note: 1. Result Level = Read Level + Correct Factor.
 2. If Peak Result complies with QP limit, QP Result is deemed to comply with QP limit.
 3. Test setup: RBW: 120 kHz, VBW: 300 kHz, Sweep time: auto.

SPURIOUS EMISSIONS (UNII-1 BAND LOW CHANNEL, VERTICAL, WORST-CASE CONFIGURATION)

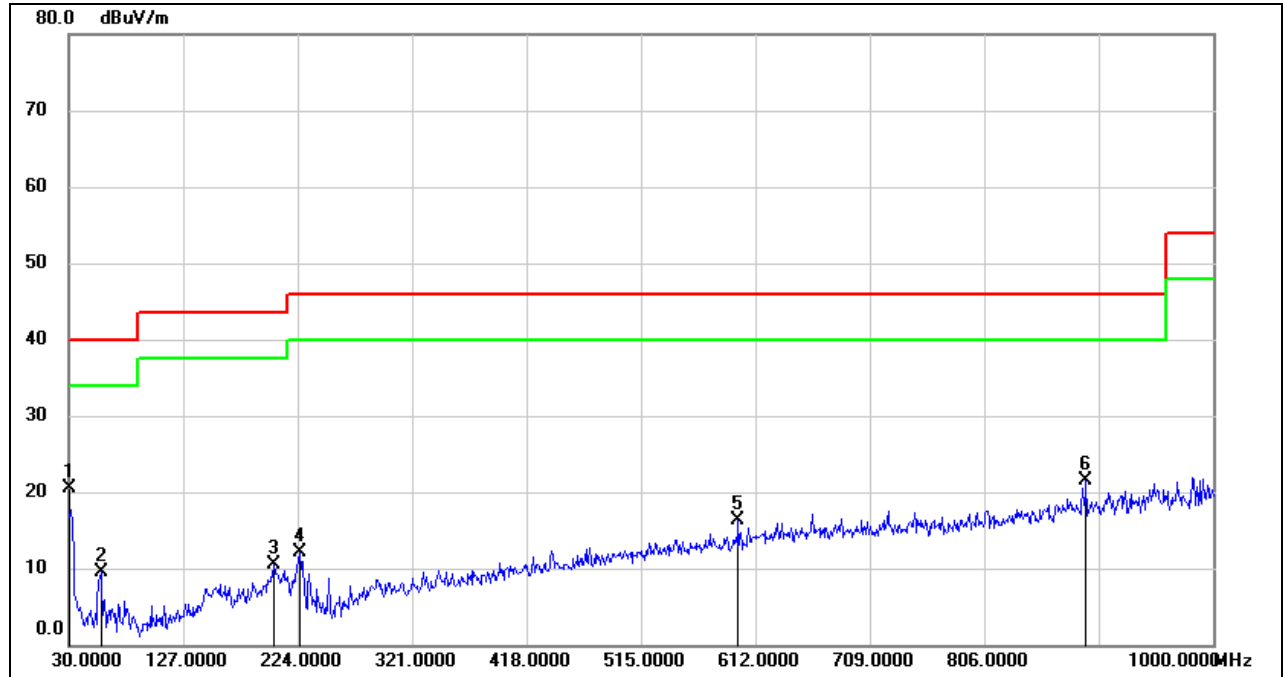

No.	Frequency (MHz)	Reading (dBuV)	Correct (dB/m)	Result (dBuV/m)	Limit (dBuV/m)	Margin (dB)	Remark
1	30.0000	39.52	-18.94	20.58	40.00	-19.42	QP
2	57.1600	30.05	-20.58	9.47	40.00	-30.53	QP
3	203.6300	27.18	-16.70	10.48	43.50	-33.02	QP
4	225.9400	30.62	-18.47	12.15	46.00	-33.85	QP
5	597.4500	25.82	-9.61	16.21	46.00	-29.79	QP
6	892.3300	26.72	-5.23	21.49	46.00	-24.51	QP

- Note: 1. Result Level = Read Level + Correct Factor.
 2. If Peak Result complies with QP limit, QP Result is deemed to comply with QP limit.
 3. Test setup: RBW: 120 kHz, VBW: 300 kHz, Sweep time: auto

Note: All the channels and modes antennas had been tested, but only the worst data was recorded in the report.

8.7. SPURIOUS EMISSIONS BELOW 30 MHz

8.7.1. 802.11n HT40 MIMO MODE

SPURIOUS EMISSIONS (UNII-3 BAND LOW CHANNEL, LOOP ANTENNA FACE ON TO THE EUT, WORST-CASE CONFIGURATION)

9 kHz~ 150 kHz

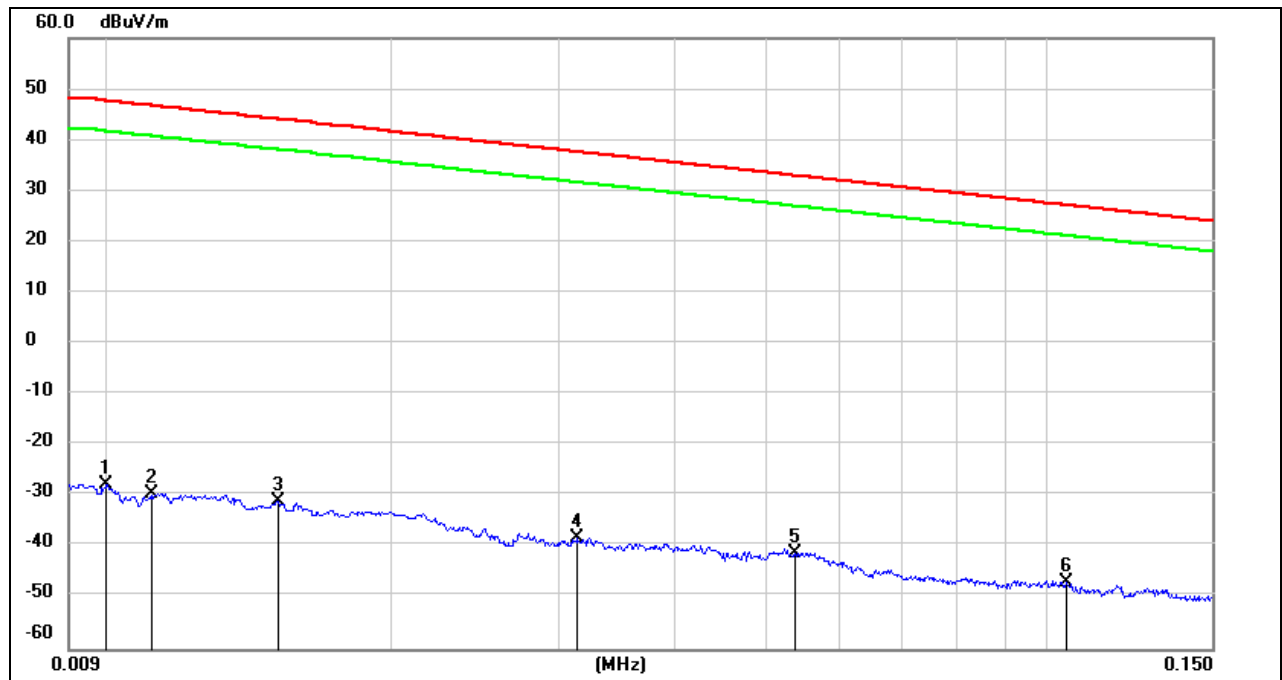

No.	Frequency (MHz)	Reading (dBuV)	Correct (dB/m)	FCC Result (dBuV/m)	FCC Limit (dBuV/m)	ISED Result (dBuA/m)	ISED Limit (dBuA/m)	Margin (dB)	Remark
1	0.0100	73.72	-101.40	-27.68	47.6	-79.18	-3.90	-75.28	peak
2	0.0111	71.95	-101.39	-29.44	46.69	-80.94	-4.81	-76.13	peak
3	0.0151	70.37	-101.37	-31	44.02	-82.50	-7.48	-75.02	peak
4	0.0314	63.10	-101.40	-38.3	37.66	-89.80	-13.84	-75.96	peak
5	0.0538	60.38	-101.49	-41.11	32.99	-92.61	-18.51	-74.10	peak
6	0.1048	54.80	-101.78	-46.98	27.2	-98.48	-24.30	-74.18	peak

Note: 1. Measurement = Reading Level + Correct Factor.

2. If Peak Result complies with AV and QP limit, AV and QP Result are deemed to comply with AV limit.

3. All 3 polarizations (Horizontal, Face-on and Face-off) of the loop antenna had been tested, but only the worst data recorded in the report.

150 kHz ~ 490 kHz

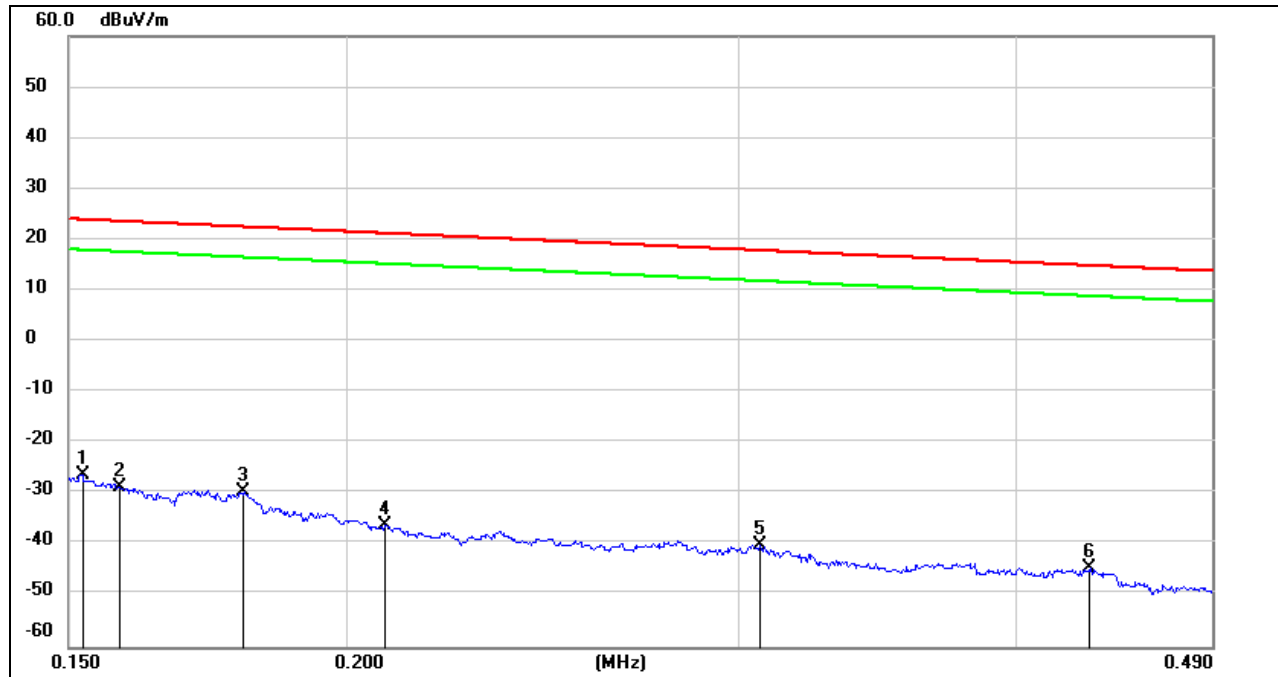

No.	Frequency (MHz)	Reading (dBuV)	Correct (dB/m)	FCC Result (dBuV/m)	FCC Limit (dBuV/m)	ISED Result (dBuA/m)	ISED Limit (dBuA/m)	Margin (dB)	Remark
1	0.1521	75.29	-101.63	-26.34	23.96	-77.84	-27.54	-50.30	peak
2	0.1582	73.05	-101.65	-28.6	23.62	-80.10	-27.88	-52.22	peak
3	0.1800	72.12	-101.68	-29.56	22.5	-81.06	-29.00	-52.06	peak
4	0.2081	65.62	-101.73	-36.11	21.23	-87.61	-30.27	-57.34	peak
5	0.3069	61.93	-101.86	-39.93	17.86	-91.43	-33.64	-57.79	peak
6	0.4319	57.42	-101.99	-44.57	14.89	-96.07	-36.61	-59.46	peak

- Note: 1. Measurement = Reading Level + Correct Factor.
 2. If Peak Result complies with AV and QP limit, AV and QP Result are deemed to comply with AV limit.
 3. All 3 polarizations (Horizontal, Face-on and Face-off) of the loop antenna had been tested, but only the worst data recorded in the report.

490 kHz ~ 30 MHz

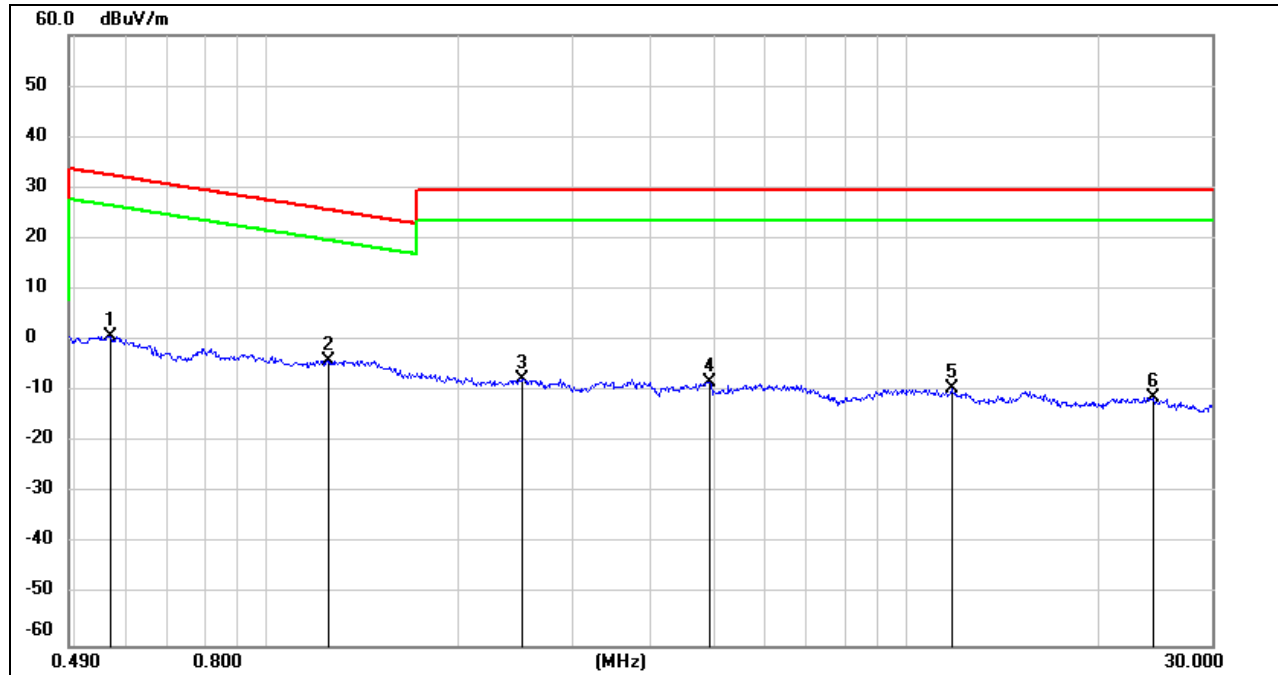

No.	Frequency (MHz)	Reading (dBuV)	Correct (dB/m)	Result (dBuV/m)	Limit (dBuV/m)	Margin (dB)	Remark
1	0.5705	62.87	-62.07	0.80	32.48	-31.68	peak
2	1.2459	58.25	-62.16	-3.91	25.70	-29.61	peak
3	2.5095	54.05	-61.70	-7.65	29.54	-37.19	peak
4	4.9165	53.38	-61.48	-8.10	29.54	-37.64	peak
5	11.7628	51.53	-60.88	-9.35	29.54	-38.89	peak
6	24.3045	49.30	-60.51	-11.21	29.54	-40.75	peak

Note: 1. Measurement = Reading Level + Correct Factor.

2. If Peak Result complies with AV and QP limit, AV and QP Result are deemed to comply with AV limit.

3. All 3 polarizations (Horizontal, Face-on and Face-off) of the loop antenna had been tested, but only the worst data recorded in the report.

Note: All the channels and modes antennas had been tested, but only the worst data was recorded in the report.

9. AC POWER LINE CONDUCTED EMISSIONS

LIMITS

Please refer to CFR 47 FCC §15.207 (a) and ISED RSS-Gen Clause 8.8

FREQUENCY (MHz)	Quasi-peak	Average
0.15 -0.5	66 - 56 *	56 - 46 *
0.50 -5.0	56.00	46.00
5.0 -30.0	60.00	50.00

TEST SETUP AND PROCEDURE

Refer to ANSI C63.10-2013 clause 6.2.

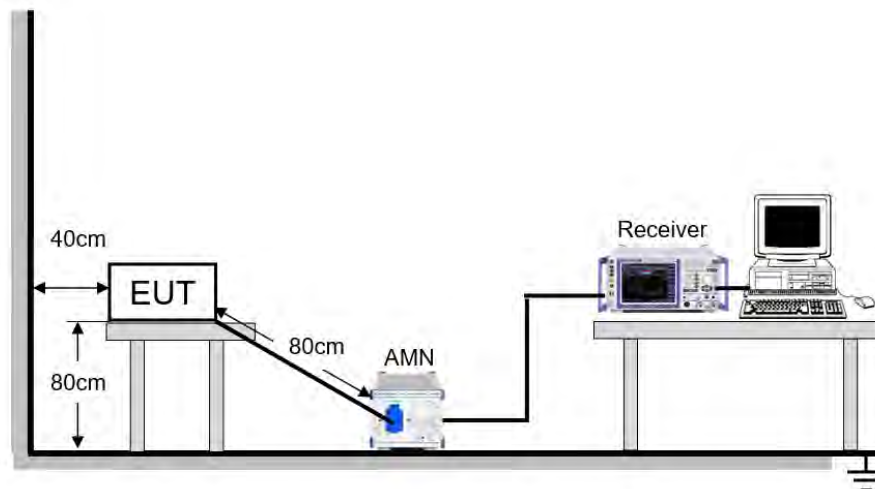

The EUT is put on a table of non-conducting material that is 80 cm high. The vertical conducting wall of shielding is located 40 cm to the rear of the EUT. The power line of the EUT is connected to the AC mains through a Artificial Mains Network (A.M.N.). A EMI Measurement Receiver (R&S Test Receiver ESR3) is used to test the emissions from both sides of AC line. According to the requirements in Section 6.2 of ANSI C63.10-2013. Conducted emissions from the EUT measured in the frequency range between 0.15 MHz and 30 MHz using CISPR Quasi-Peak and average detector mode. The bandwidth of EMI test receiver is set at 9 kHz.

The arrangement of the equipment is installed to meet the standards and operating in a manner, which tends to maximize its emission characteristics in a normal application.

TEST ENVIRONMENT

Temperature	23.6 °C	Relative Humidity	68.4 %
Atmosphere Pressure	101 kPa	Test Voltage	DC 5 V

RESULTS

9.1. 802.11n HT40 MIMO MODE

LINE N RESULTS (LOW CHANNEL, WORST-CASE CONFIGURATION)

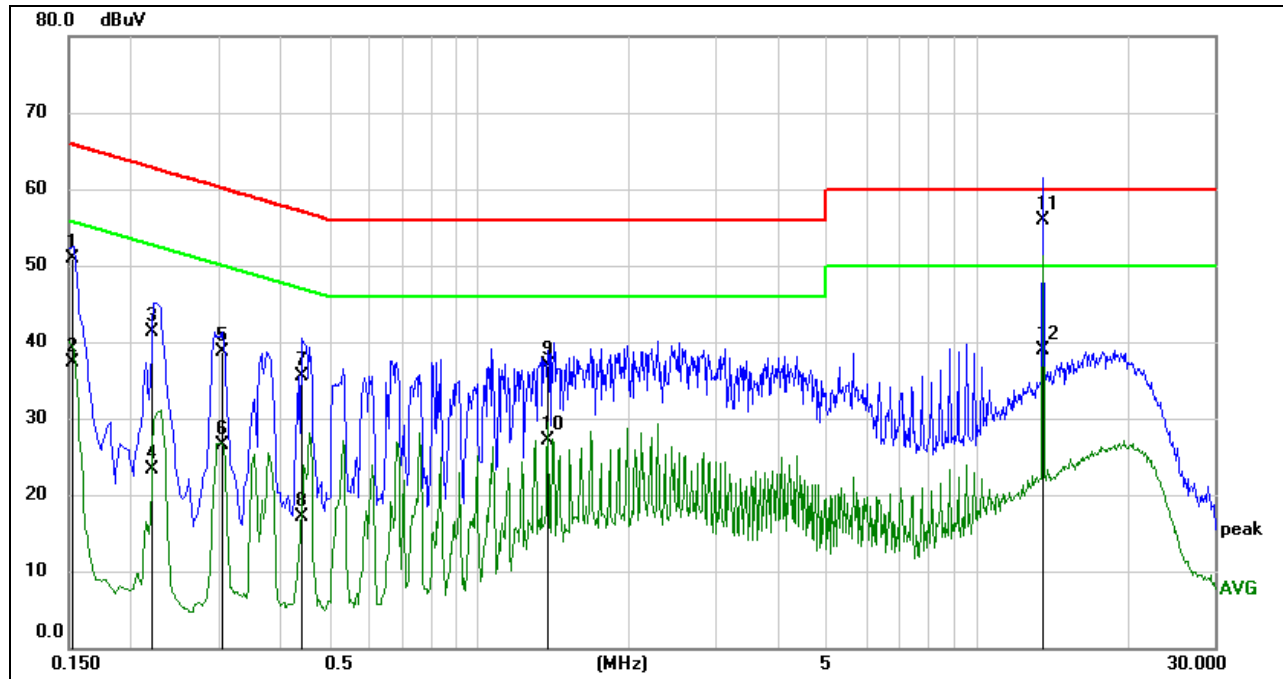

No.	Frequency (MHz)	Reading (dBuV)	Correct (dB)	Result (dBuV)	Limit (dBuV)	Margin (dB)	Remark
1	0.1521	41.33	9.59	50.92	65.88	-14.96	QP
2	0.1521	27.73	9.59	37.32	55.88	-18.56	AVG
3	0.2198	31.80	9.59	41.39	62.83	-21.44	QP
4	0.2198	13.67	9.59	23.26	52.83	-29.57	AVG
5	0.3053	29.14	9.59	38.73	60.10	-21.37	QP
6	0.3053	16.92	9.59	26.51	50.10	-23.59	AVG
7	0.4396	25.86	9.60	35.46	57.07	-21.61	QP
8	0.4396	7.43	9.60	17.03	47.07	-30.04	AVG
9	1.3752	27.20	9.61	36.81	56.00	-19.19	QP
10	1.3752	17.59	9.61	27.20	46.00	-18.80	AVG
11	13.5604	46.24	9.66	55.90	60.00	-4.10	QP
12	13.5604	29.29	9.66	38.95	50.00	-11.05	AVG

- Note: 1. Result = Reading +Correct Factor.
 2. If QP Result complies with AV limit, AV Result is deemed to comply with AV limit.
 3. Test setup: RBW: 200 Hz (9 kHz ~ 150 kHz), 9 kHz (150 kHz ~ 30 MHz).
 4. Step size: 80 Hz (0.009 MHz ~ 0.15 MHz), 4 kHz (0.15 MHz ~ 30 MHz), Scan time: auto.

LINE L RESULTS (LOW CHANNEL, WORST-CASE CONFIGURATION)

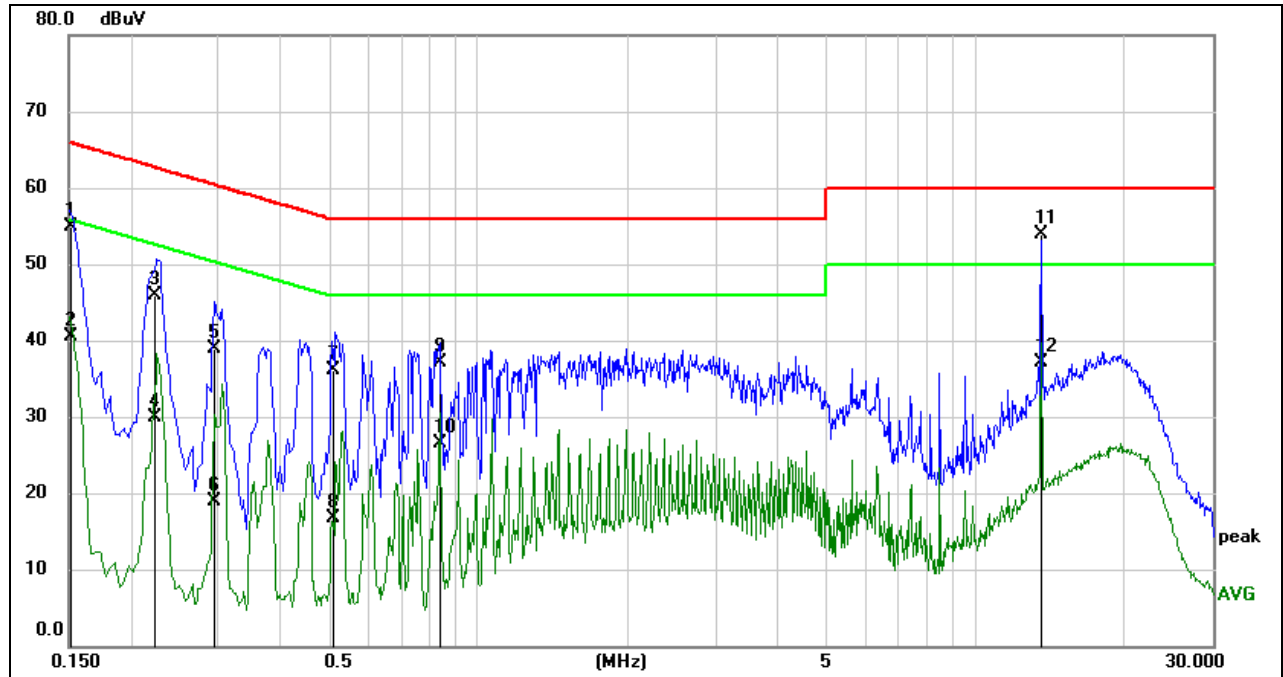

No.	Frequency (MHz)	Reading (dBuV)	Correct (dB)	Result (dBuV)	Limit (dBuV)	Margin (dB)	Remark
1	0.1522	45.36	9.59	54.95	65.88	-10.93	QP
2	0.1522	30.95	9.59	40.54	55.88	-15.34	AVG
3	0.2227	36.28	9.59	45.87	62.72	-16.85	QP
4	0.2227	20.22	9.59	29.81	52.72	-22.91	AVG
5	0.2929	29.35	9.59	38.94	60.44	-21.50	QP
6	0.2929	9.37	9.59	18.96	50.44	-31.48	AVG
7	0.5126	26.51	9.60	36.11	56.00	-19.89	QP
8	0.5126	7.19	9.60	16.79	46.00	-29.21	AVG
9	0.8397	27.57	9.60	37.17	56.00	-18.83	QP
10	0.8397	16.98	9.60	26.58	46.00	-19.42	AVG
11	13.5604	44.21	9.66	53.87	60.00	-6.13	QP
12	13.5604	27.54	9.66	37.20	50.00	-12.80	AVG

Note: 1. Result = Reading +Correct Factor.
 2. If QP Result complies with AV limit, AV Result is deemed to comply with AV limit.
 3. Test setup: RBW: 200 Hz (9 kHz ~ 150 kHz), 9 kHz (150 kHz ~ 30 MHz).
 4. Step size: 80 Hz (0.009 MHz ~ 0.15 MHz), 4 kHz (0.15 MHz ~ 30 MHz), Scan time: auto.

Note: All the modes had been tested, but only the worst data was recorded in the report.

10. FREQUENCY STABILITY

LIMITS

The frequency of the carrier signal shall be maintained within band of operation.

TEST PROCEDURE

1. The EUT was placed inside an environmental chamber as the temperature in the chamber was varied between 0 °C ~ 40 °C (declared by customer).
2. The temperature was incremented by 10 °C intervals and the unit allowed to stabilize at each temperature before each measurement. The center frequency of the transmitting channel was evaluated at each temperature and the frequency deviation from the channel's center frequency was recorded.
3. The primary supply voltage is varied from 85 % to 115 % of the nominal value for non hand-carried battery and AC powered equipment. For hand-carried, battery-powered equipment, primary supply voltage is reduced to the battery operating end point which shall be specified by the manufacturer.

Connect the EUT to the spectrum analyser and use the following settings:

Center Frequency	The center frequency of the channel under test
Detector	Peak
RBW	10 kHz
VBW	$\geq 3 \times \text{RBW}$
Span	Encompass the entire emissions bandwidth (EBW) of the signal
Trace	Max hold
Sweep time	Auto

4. While maintaining a constant temperature inside the environmental chamber, turn the EUT on and record the operating frequency at startup, and at 2 minutes, 5 minutes, and 10 minutes after the EUT is energized.
5. Allow the trace to stabilize, find the peak value of the power envelope and record the frequency, then calculated the frequency drift.

TEST SETUP

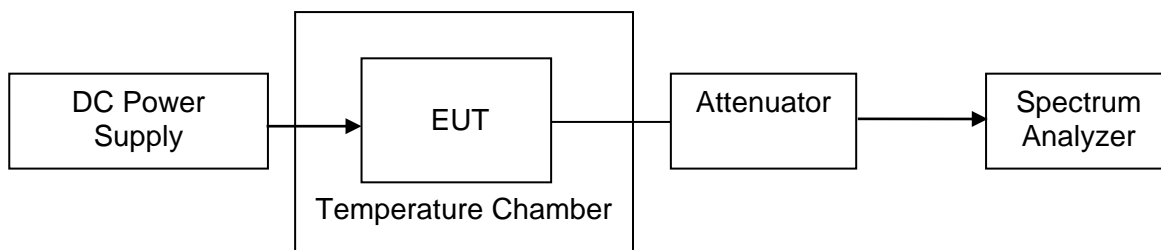



TEST ENVIRONMENT

	Normal Test Conditions	Extreme Test Conditions
Relative Humidity	20 % - 75 %	/
Atmospheric Pressure	100 kPa ~102 kPa	/
Temperature	T _N (Normal Temperature): 22 °C – 28 °C	T _L (Low Temperature): 0 °C
		T _H (High Temperature): 45 °C
Supply Voltage	V _N (Normal Voltage): DC 5 V	V _L (Low Voltage): DC 4.25V
		V _H (High Voltage): DC 5.75V

RESULTS

Please refer to Appendix E.



11. ANTENNA REQUIREMENTS

APPLICABLE REQUIREMENTS

Please refer to FCC §15.203

An intentional radiator shall be designed to ensure that no antenna other than that furnished by the responsible party shall be used with the device. The use of a permanently attached antenna or of an antenna that uses a unique coupling to the intentional radiator shall be considered sufficient to comply with the provisions of this section. The manufacturer may design the unit so that a broken antenna can be replaced by the user, but the use of a standard antenna jack or electrical connector is prohibited.

Please refer to FCC §15.247(b)(4)

The conducted output power limit specified in paragraph (b) of this section is based on the use of antennas with directional gains that do not exceed 6 dBi. Except as shown in paragraph (c) of this section, if transmitting antennas of directional gain greater than 6 dBi are used, the conducted output power from the intentional radiator shall be reduced below the stated values in paragraphs (b)(1), (b)(2), and (b)(3) of this section, as appropriate, by the amount in dB that the directional gain of the antenna exceeds 6 dBi.

RESULTS

Complies



12. Appendix

12.1. Appendix A1: Emission Bandwidth

12.1.1. Test Result

Test Mode	Antenna	Channel	26db EBW [MHz]	FL[MHz]	FH[MHz]	Verdict
11A	Ant1	5180	21.480	5169.240	5190.720	PASS
	Ant2	5180	20.960	5169.480	5190.440	PASS
	Ant1	5200	21.400	5189.040	5210.440	PASS
	Ant2	5200	21.200	5189.520	5210.720	PASS
	Ant1	5240	21.080	5229.280	5250.360	PASS
	Ant2	5240	21.360	5229.320	5250.680	PASS
	Ant1	5745	21.160	5734.360	5755.520	PASS
	Ant2	5745	21.280	5734.160	5755.440	PASS
	Ant1	5785	21.240	5774.320	5795.560	PASS
	Ant2	5785	21.240	5774.480	5795.720	PASS
	Ant1	5825	21.360	5814.240	5835.600	PASS
	Ant2	5825	21.080	5814.400	5835.480	PASS
11N20MIMO	Ant1	5180	21.080	5169.360	5190.440	PASS
	Ant2	5180	21.200	5169.280	5190.480	PASS
	Ant1	5200	21.080	5189.640	5210.720	PASS
	Ant2	5200	20.920	5189.240	5210.160	PASS
	Ant1	5240	21.320	5229.240	5250.560	PASS
	Ant2	5240	21.040	5229.360	5250.400	PASS
	Ant1	5745	21.160	5734.440	5755.600	PASS
	Ant2	5745	21.120	5734.360	5755.480	PASS
	Ant1	5785	21.400	5774.400	5795.800	PASS
	Ant2	5785	21.560	5774.080	5795.640	PASS
	Ant1	5825	21.320	5814.400	5835.720	PASS
	Ant2	5825	21.200	5814.280	5835.480	PASS
11N40MIMO	Ant1	5190	39.360	5170.160	5209.520	PASS
	Ant2	5190	40.400	5169.920	5210.320	PASS
	Ant1	5230	38.560	5210.400	5248.960	PASS
	Ant2	5230	39.200	5210.320	5249.520	PASS
	Ant1	5755	39.440	5735.160	5774.600	PASS
	Ant2	5755	39.360	5735.400	5774.760	PASS
	Ant1	5795	39.120	5775.720	5814.840	PASS
	Ant2	5795	39.200	5775.320	5814.520	PASS
11AC20MIMO	Ant1	5180	20.680	5169.240	5189.920	PASS
	Ant2	5180	21.000	5169.440	5190.440	PASS
	Ant1	5200	20.800	5189.600	5210.400	PASS
	Ant2	5200	21.120	5189.120	5210.240	PASS
	Ant1	5240	21.200	5229.400	5250.600	PASS
	Ant2	5240	20.520	5229.480	5250.000	PASS
	Ant1	5745	21.400	5734.080	5755.480	PASS
	Ant2	5745	21.200	5734.440	5755.640	PASS
	Ant1	5785	21.560	5774.200	5795.760	PASS
	Ant2	5785	21.720	5774.200	5795.920	PASS
	Ant1	5825	21.400	5814.400	5835.800	PASS
	Ant2	5825	21.360	5814.120	5835.480	PASS
11AC40MIMO	Ant1	5190	39.200	5170.160	5209.360	PASS
	Ant2	5190	39.600	5170.240	5209.840	PASS
	Ant1	5230	39.520	5209.920	5249.440	PASS
	Ant2	5230	38.880	5210.720	5249.600	PASS
	Ant1	5755	39.680	5735.080	5774.760	PASS
	Ant2	5755	39.360	5735.480	5774.840	PASS
	Ant1	5795	39.200	5775.400	5814.600	PASS
	Ant2	5795	38.880	5775.640	5814.520	PASS



11AC80MIMO	Ant1	5210	119.200	5130.640	5249.840	PASS
	Ant2	5210	79.680	5170.160	5249.840	PASS
	Ant1	5775	84.160	5734.040	5818.200	PASS
	Ant2	5775	81.120	5735.000	5816.120	PASS

12.1.2. Test Graphs





11A_Ant2_5200



11A_Ant1_5240



11A_Ant2_5240



11A_Ant1_5745



11A_Ant2_5745



11A_Ant1_5785

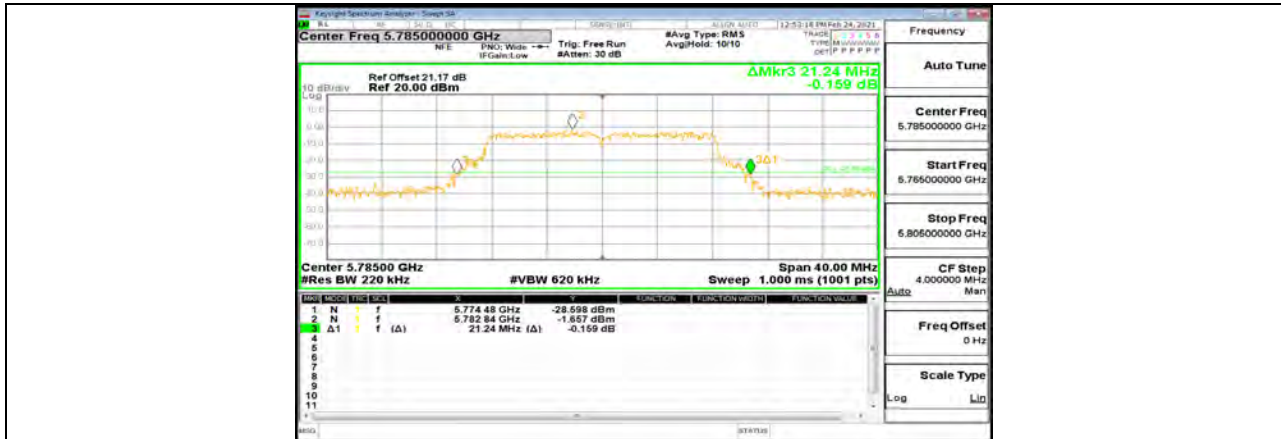

11A_Ant2_5785



11A_Ant1_5825



11A_Ant2_5825

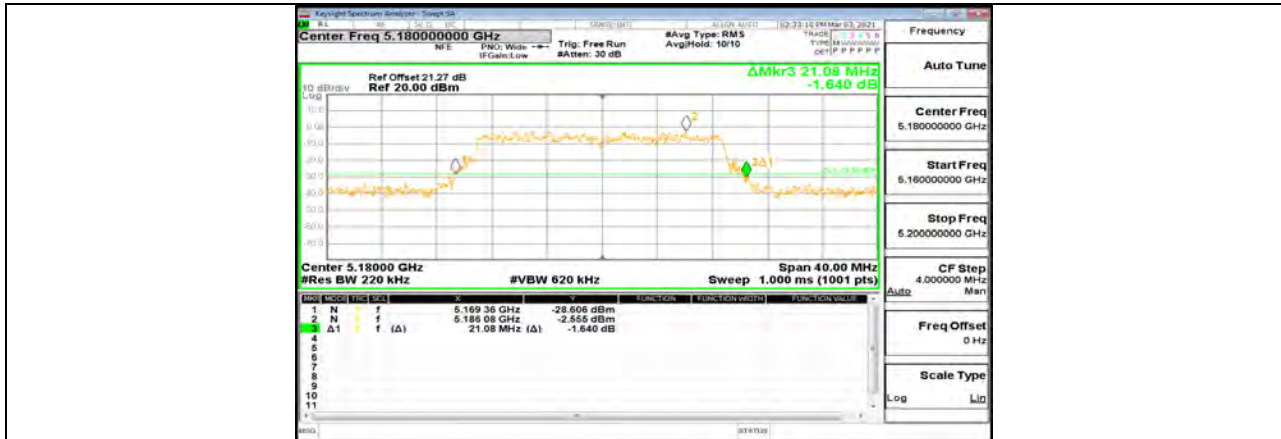

11N20MIMO_Ant1_5180

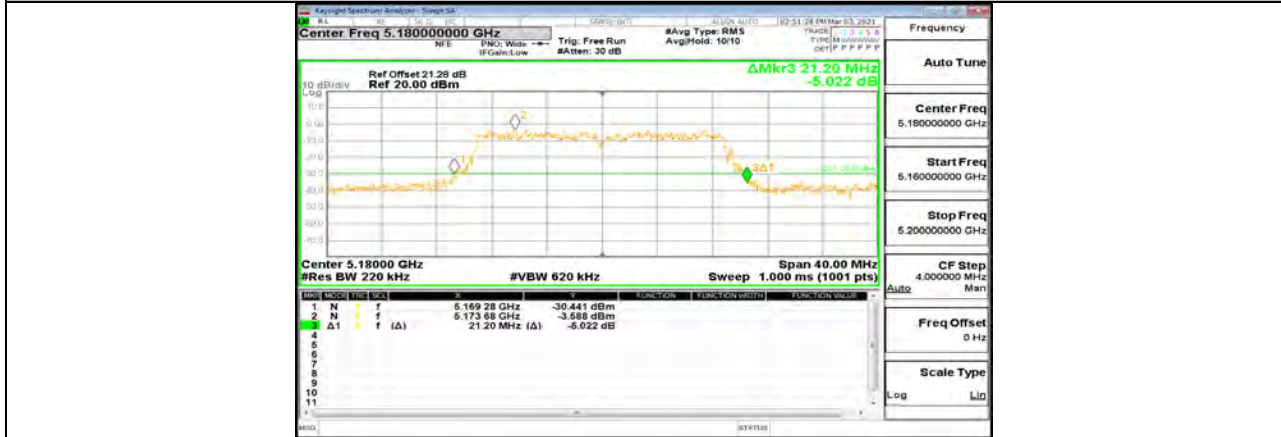

11N20MIMO_Ant2_5180

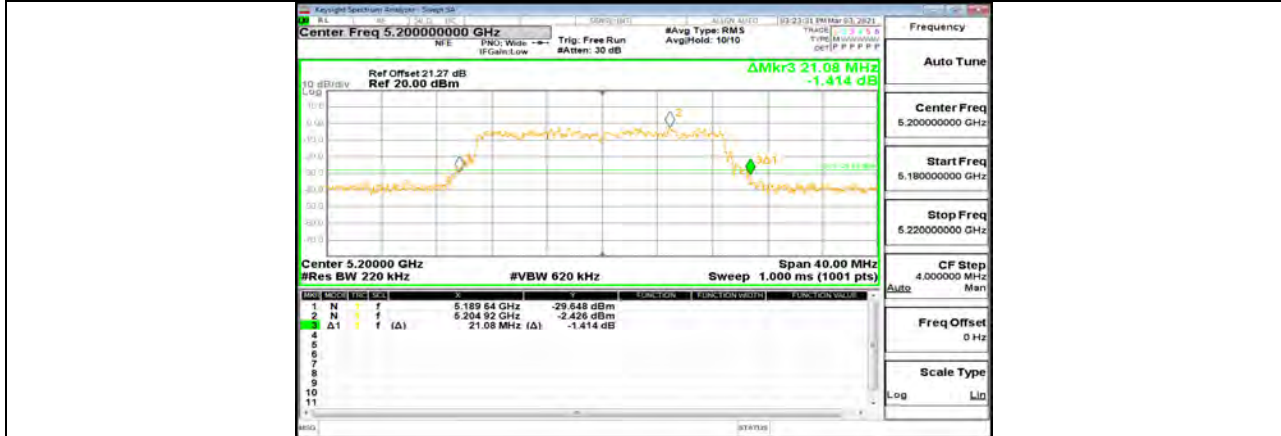

11N20MIMO_Ant1_5200

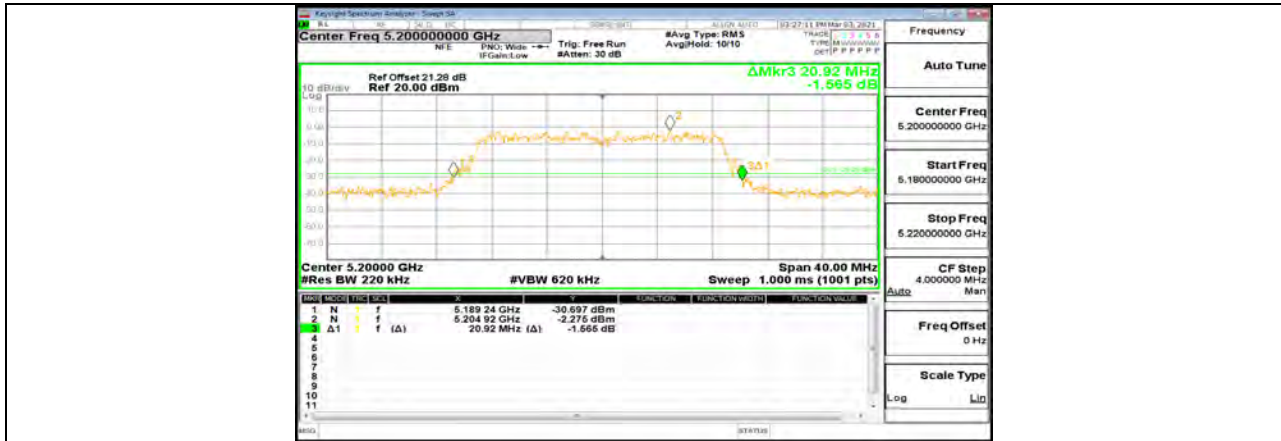

11N20MIMO_Ant2_5200

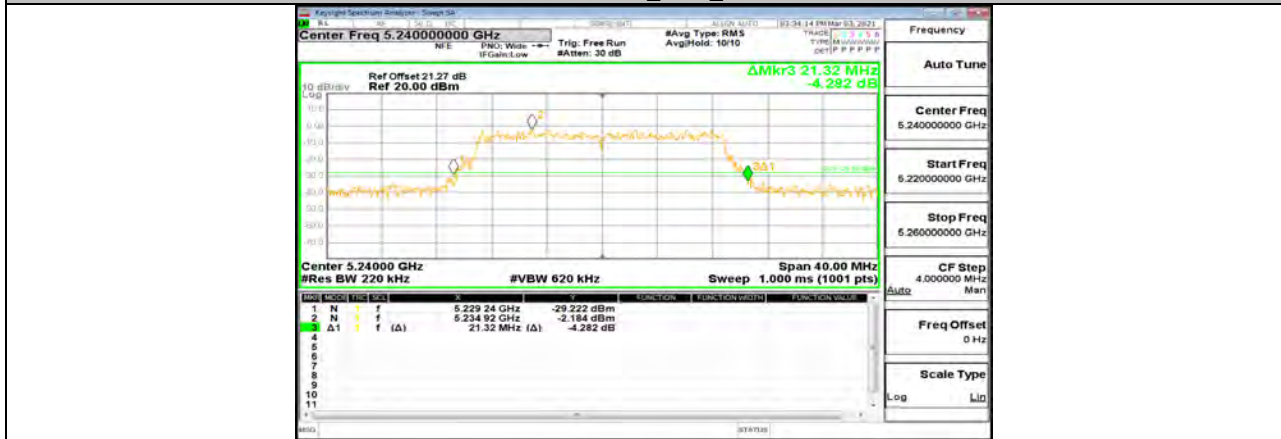

11N20MIMO_Ant1_5240



11N20MIMO_Ant2_5240



11N20MIMO_Ant1_5745

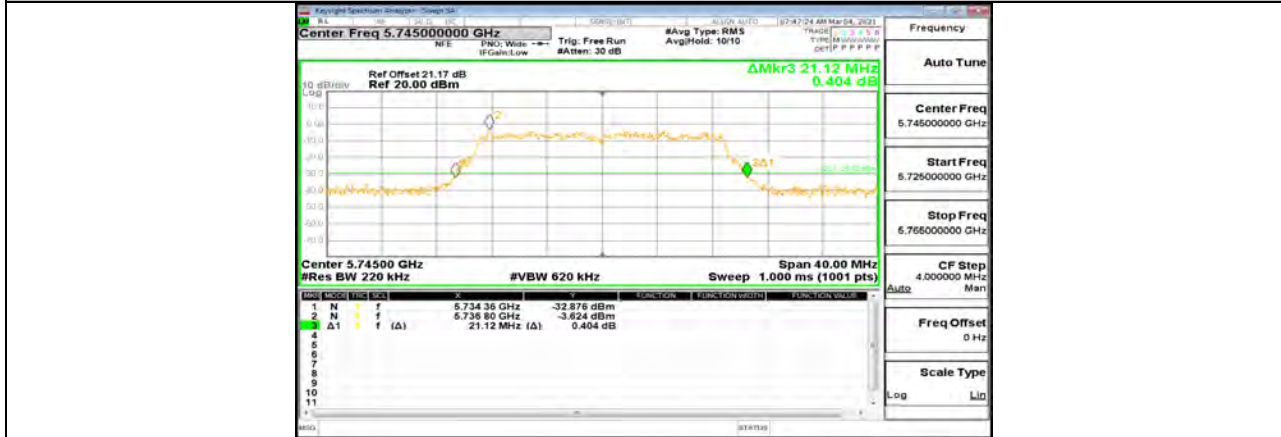

11N20MIMO_Ant2_5745



11N20MIMO_Ant1_5785



11N20MIMO_Ant2_5785

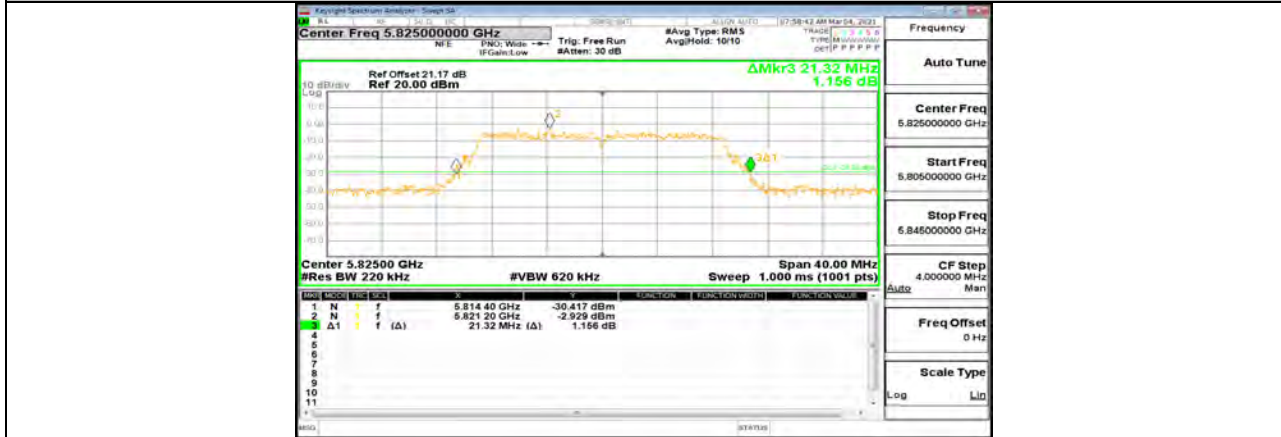

11N20MIMO_Ant1_5825



11N20MIMO_Ant2_5825

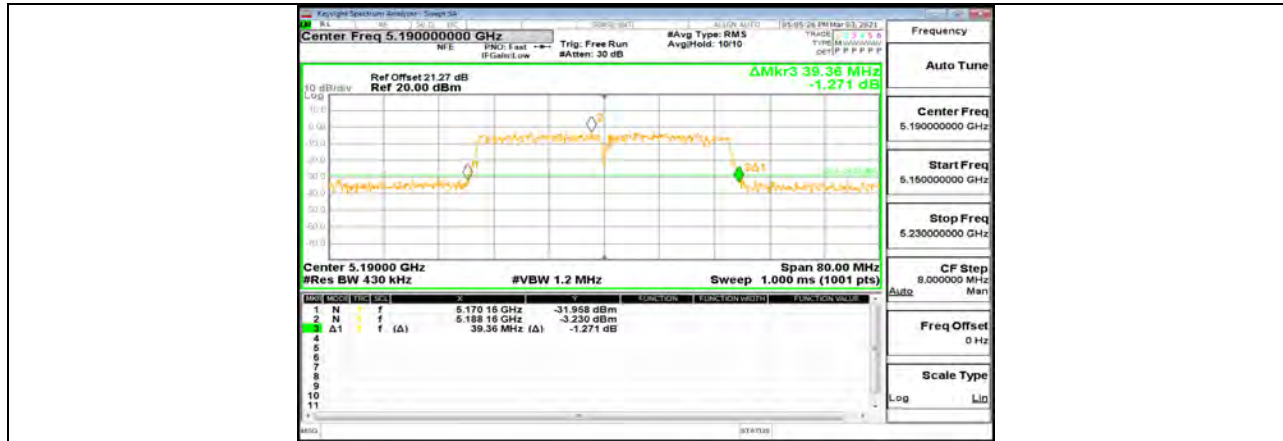

11N40MIMO_Ant1_5190



11N40MIMO_Ant2_5190

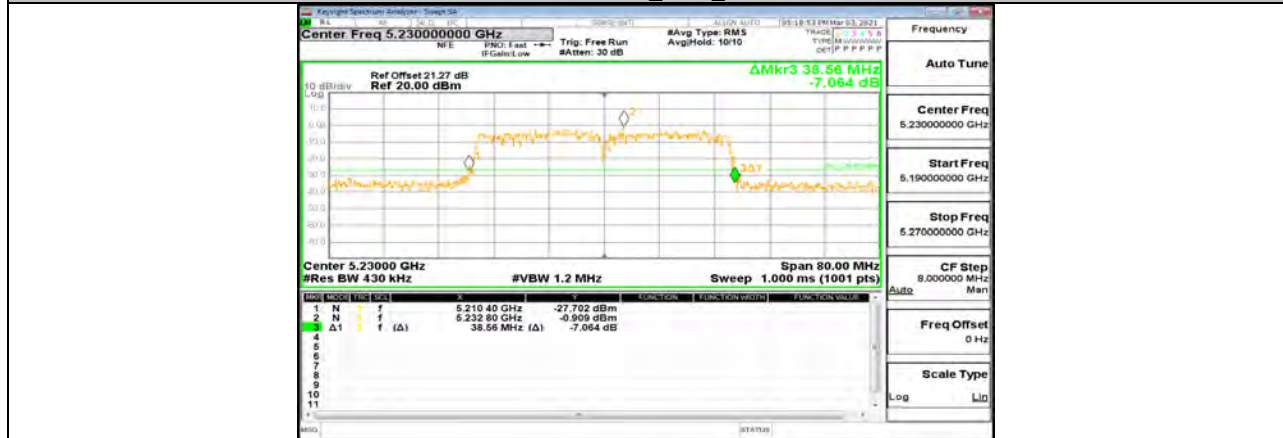

11N40MIMO_Ant1_5230

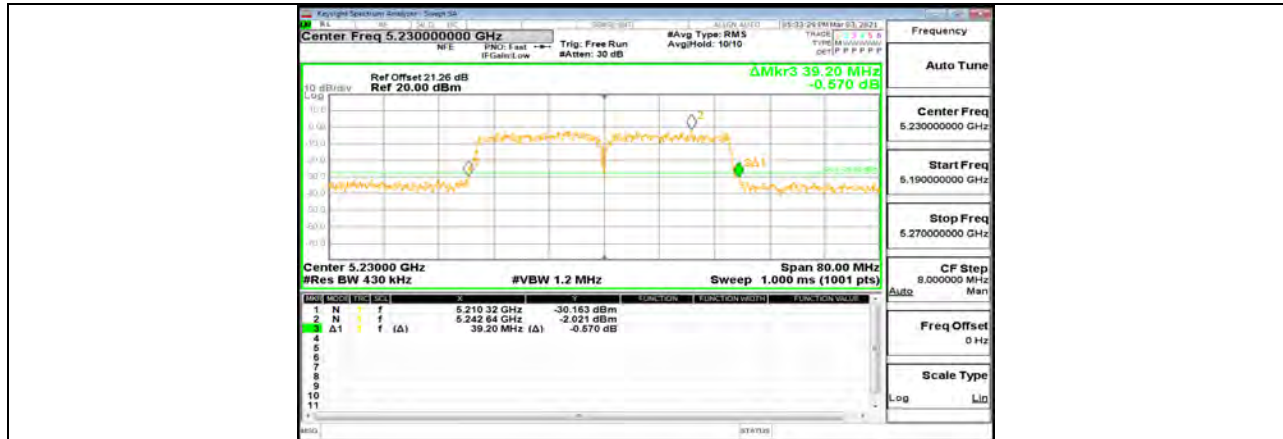

11N40MIMO_Ant2_5230



11N40MIMO_Ant1_5755

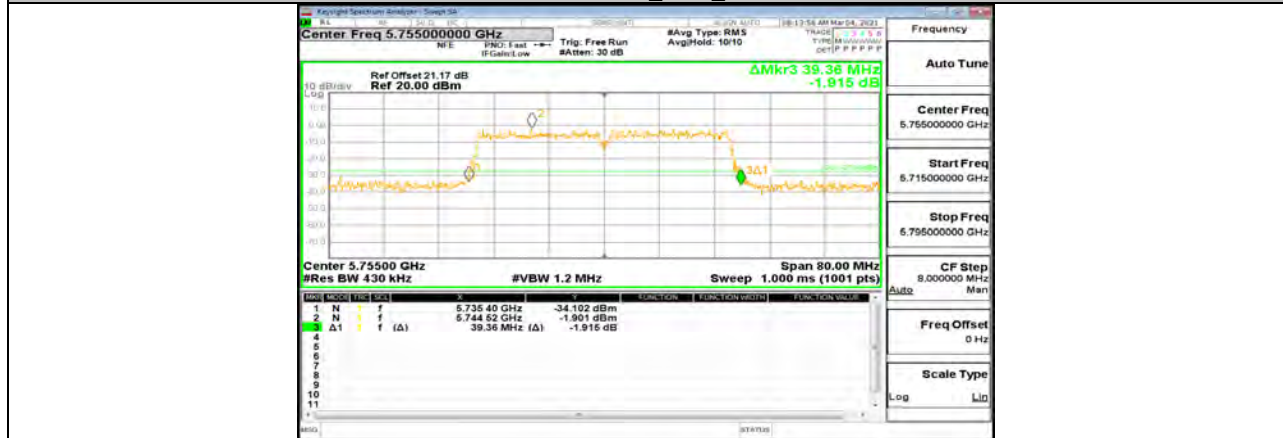

11N40MIMO_Ant2_5755



11N40MIMO_Ant1_5795

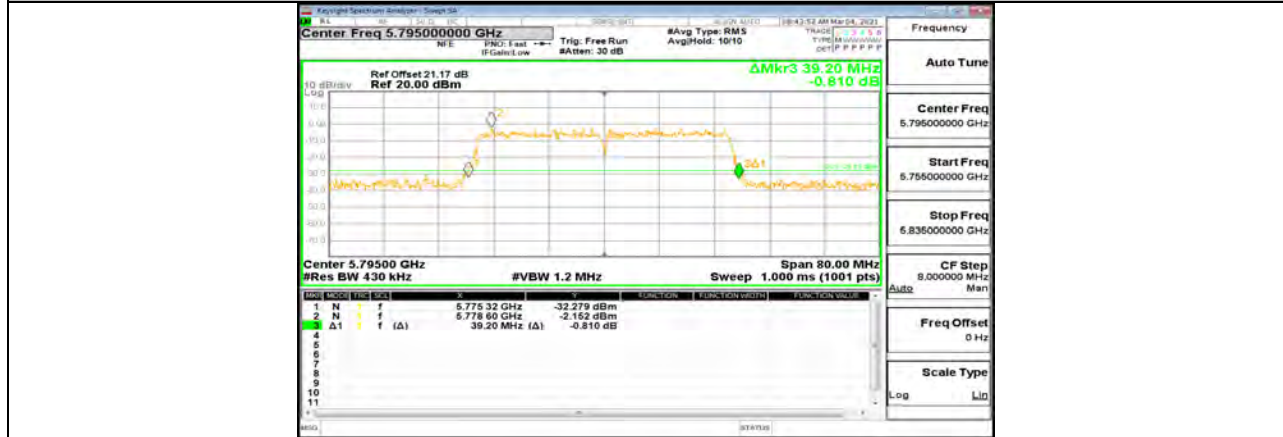

11N40MIMO_Ant2_5795

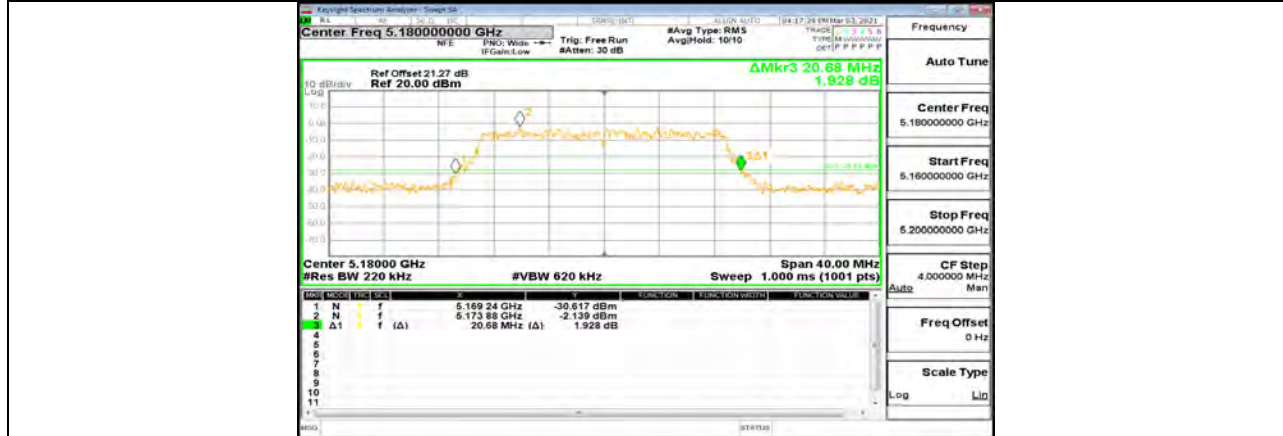

11AC20MIMO_Ant1_5180

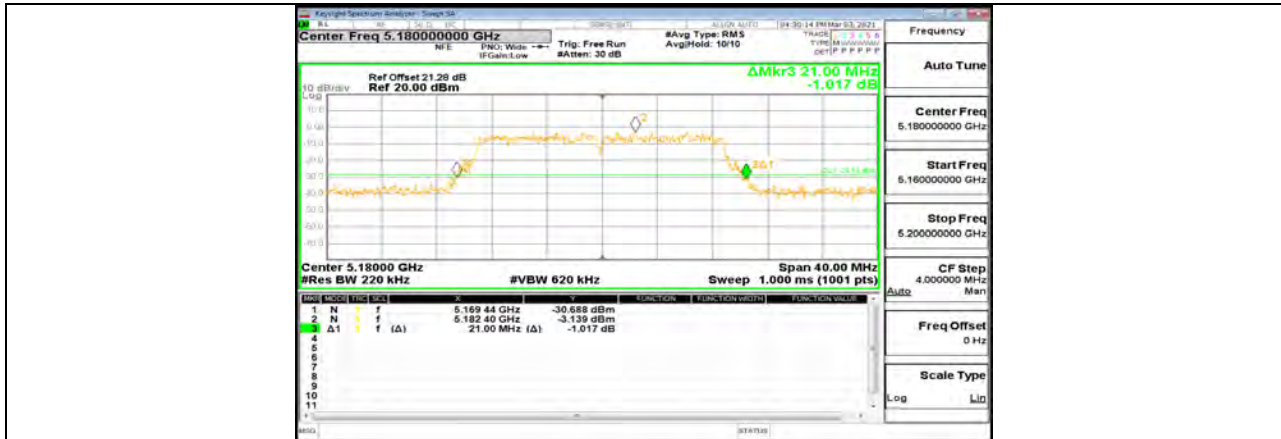

11AC20MIMO_Ant2_5180



11AC20MIMO_Ant1_5200



11AC20MIMO_Ant2_5200

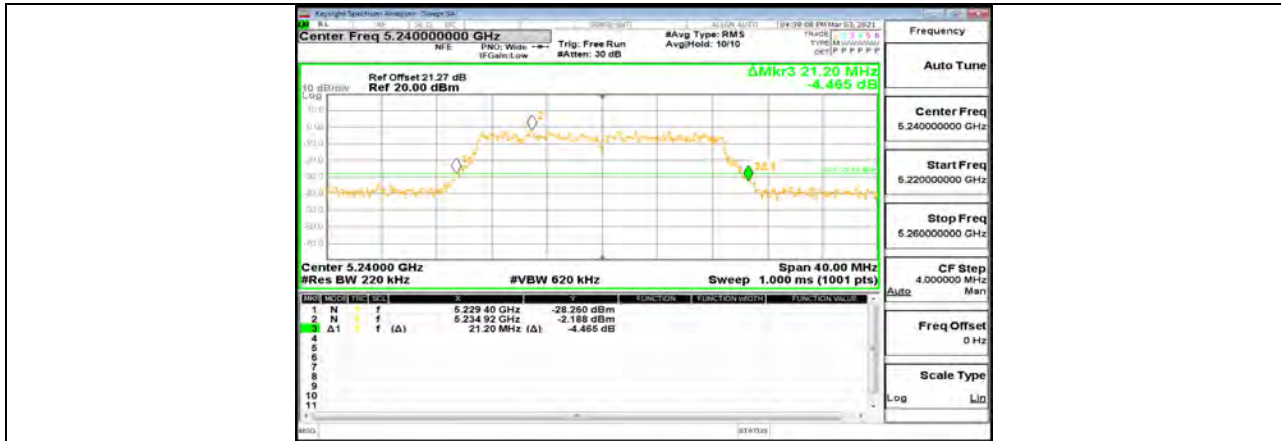

11AC20MIMO_Ant1_5240



11AC20MIMO_Ant2_5240

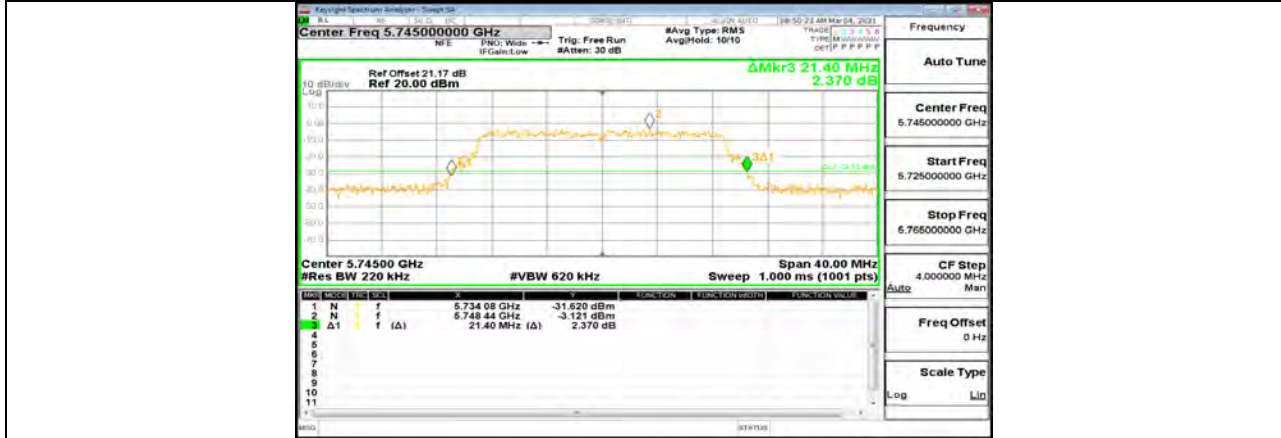

11AC20MIMO_Ant1_5745



11AC20MIMO_Ant2_5745

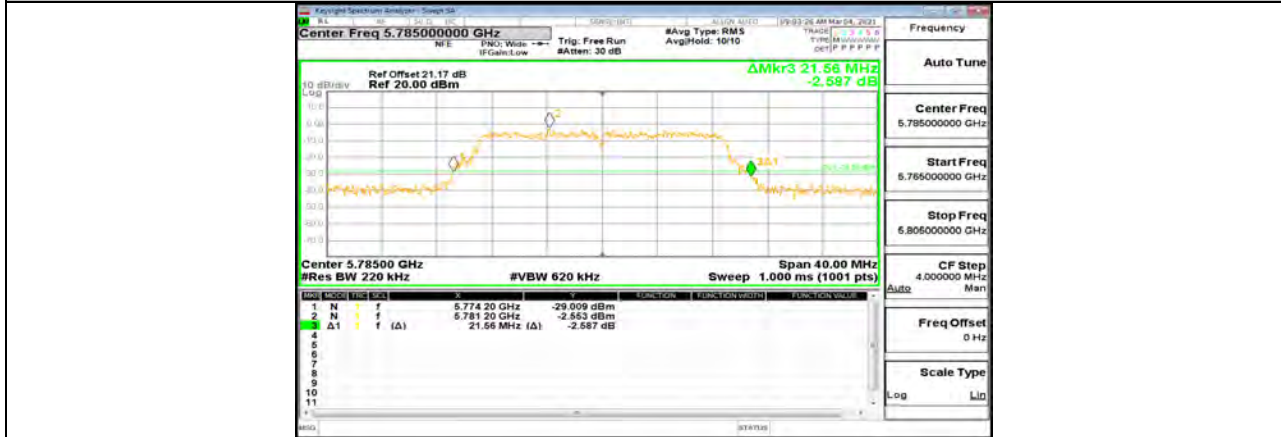

11AC20MIMO_Ant1_5785



11AC20MIMO_Ant2_5785

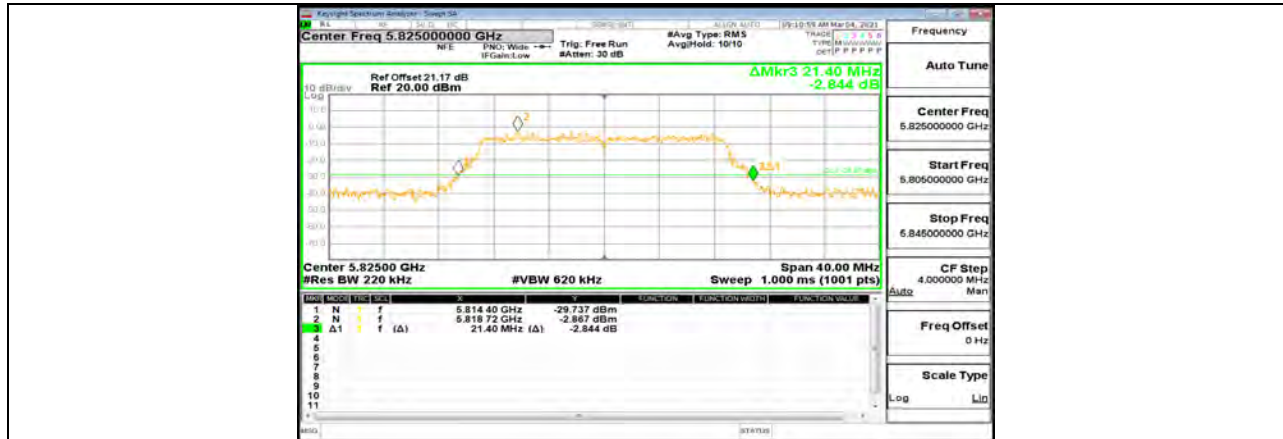

11AC20MIMO_Ant1_5825

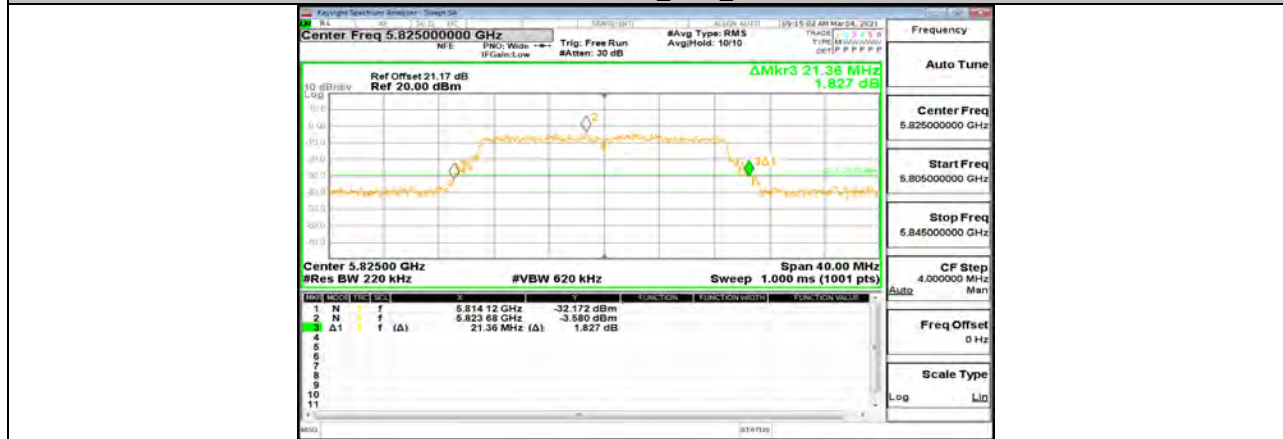

11AC20MIMO_Ant2_5825



11AC40MIMO_Ant1_5190



11AC40MIMO_Ant2_5190

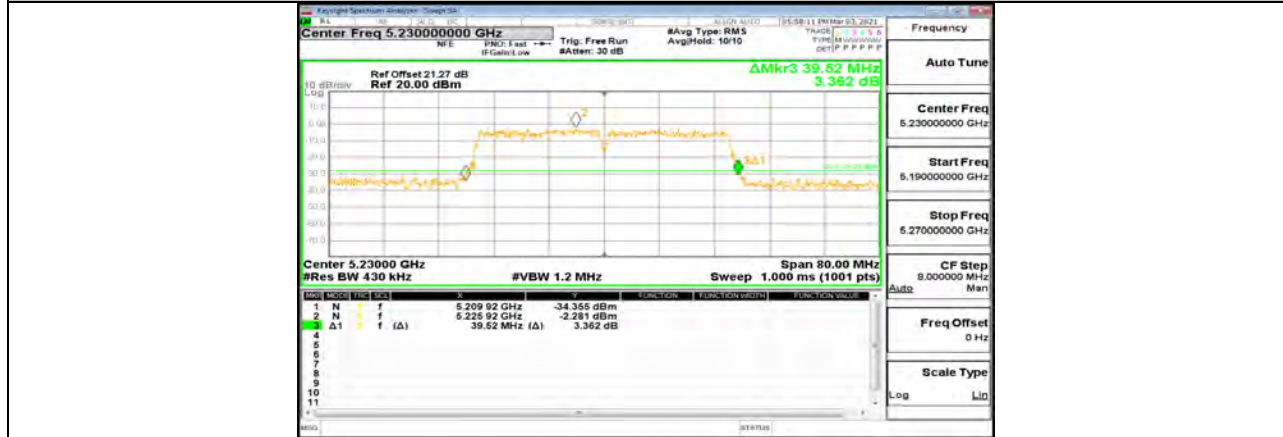

11AC40MIMO_Ant1_5230

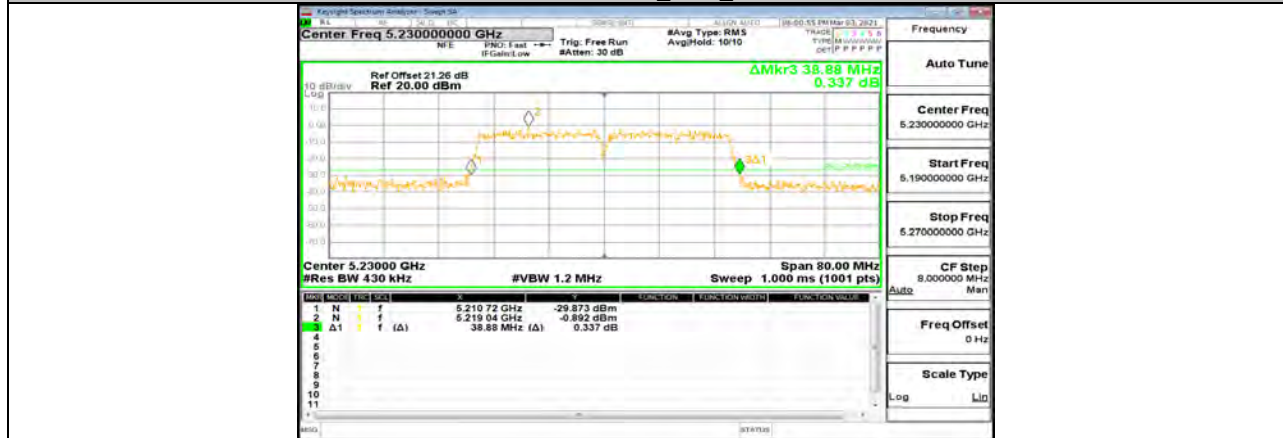

11AC40MIMO_Ant2_5230

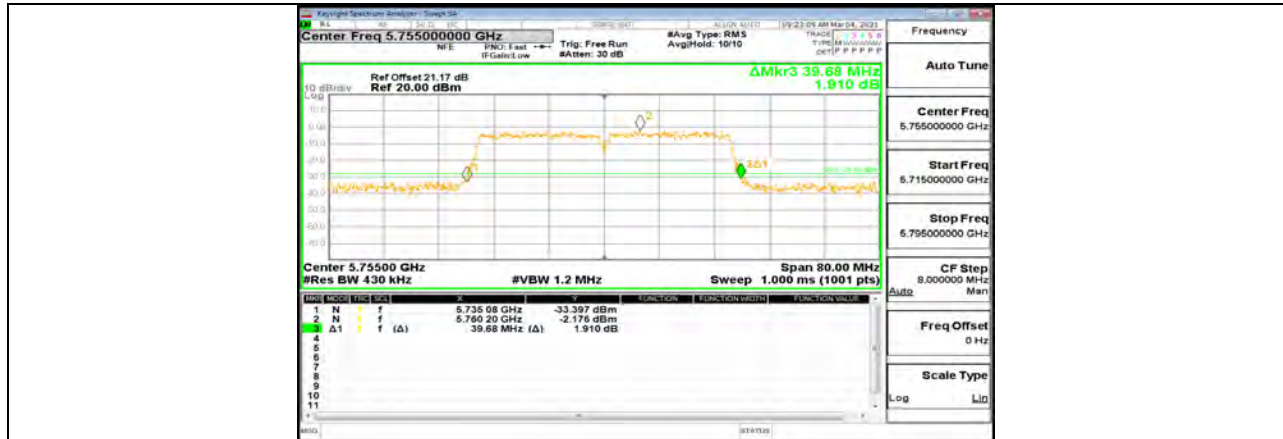

11AC40MIMO_Ant1_5755



11AC40MIMO_Ant2_5755



11AC40MIMO_Ant1_5795

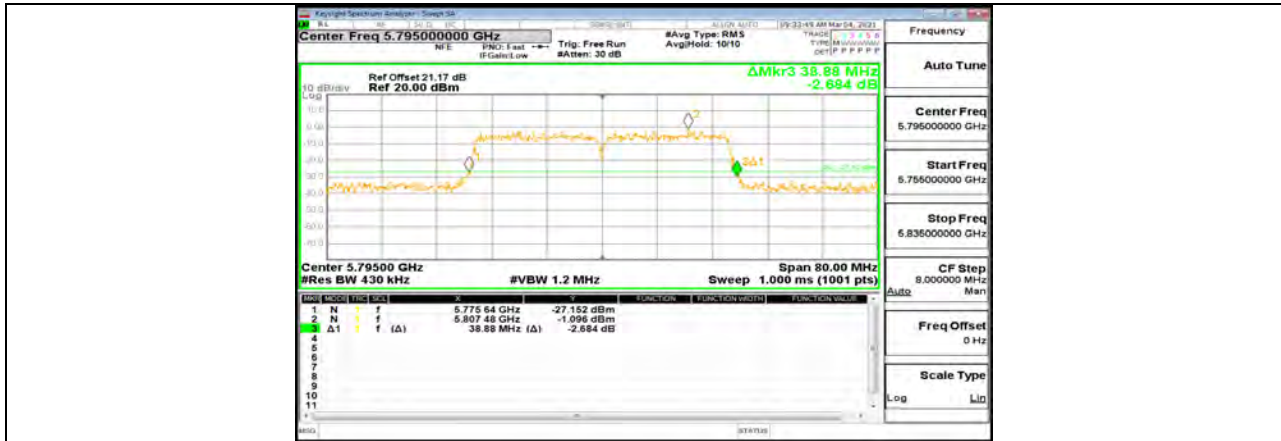

11AC40MIMO_Ant2_5795



11AC80MIMO_Ant1_5210



11AC80MIMO_Ant2_5210



11AC80MIMO_Ant1_5775

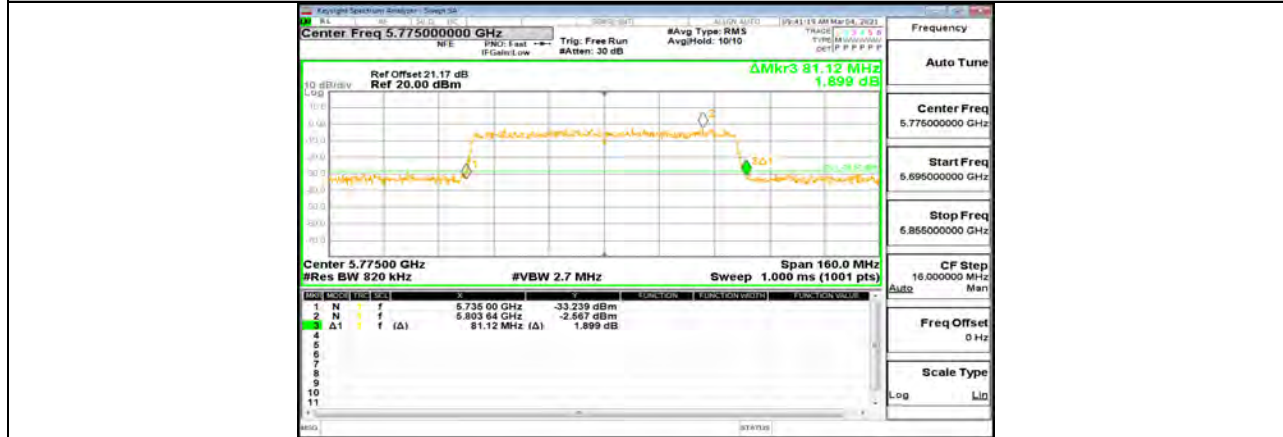

11AC80MIMO_Ant2_5775

**12.2. Appendix A2: Occupied channel bandwidth****12.2.1. Test Result**

Test Mode	Antenna	Channel	OCB [MHz]	FL[MHz]	FH[MHz]	Verdict
11A	Ant1	5180	17.111	5171.324	5188.435	PASS
	Ant2	5180	17.073	5171.444	5188.517	PASS
	Ant1	5200	17.177	5191.344	5208.521	PASS
	Ant2	5200	17.180	5191.332	5208.512	PASS
	Ant1	5240	17.129	5231.310	5248.439	PASS
	Ant2	5240	17.174	5231.399	5248.573	PASS
	Ant1	5745	17.164	5736.366	5753.530	PASS
	Ant2	5745	17.066	5736.364	5753.430	PASS
	Ant1	5785	17.138	5776.341	5793.479	PASS
	Ant2	5785	17.174	5776.301	5793.475	PASS
	Ant1	5825	17.150	5816.344	5833.494	PASS
	Ant2	5825	17.194	5816.356	5833.550	PASS
11N20MIMO	Ant1	5180	17.974	5170.935	5188.909	PASS
	Ant2	5180	17.981	5170.940	5188.921	PASS
	Ant1	5200	17.966	5190.881	5208.847	PASS
	Ant2	5200	18.090	5190.861	5208.951	PASS
	Ant1	5240	18.023	5230.941	5248.964	PASS
	Ant2	5240	17.999	5230.865	5248.864	PASS
	Ant1	5745	18.078	5735.880	5753.958	PASS
	Ant2	5745	18.066	5735.923	5753.989	PASS
	Ant1	5785	18.223	5775.780	5794.003	PASS
	Ant2	5785	18.131	5775.899	5794.030	PASS
	Ant1	5825	18.244	5815.774	5834.018	PASS
	Ant2	5825	18.187	5815.865	5834.052	PASS
11N40MIMO	Ant1	5190	36.369	5171.689	5208.058	PASS
	Ant2	5190	36.129	5171.722	5207.851	PASS
	Ant1	5230	36.454	5211.656	5248.110	PASS
	Ant2	5230	36.332	5211.741	5248.073	PASS
	Ant1	5755	36.401	5736.822	5773.223	PASS
	Ant2	5755	36.466	5736.850	5773.316	PASS
	Ant1	5795	36.527	5776.733	5813.260	PASS
	Ant2	5795	36.555	5776.780	5813.335	PASS
11AC20MIMO	Ant1	5180	18.146	5170.846	5188.992	PASS
	Ant2	5180	18.019	5170.876	5188.895	PASS
	Ant1	5200	17.965	5190.913	5208.878	PASS
	Ant2	5200	17.942	5190.918	5208.860	PASS
	Ant1	5240	18.003	5230.875	5248.878	PASS
	Ant2	5240	17.946	5230.911	5248.857	PASS
	Ant1	5745	17.997	5735.946	5753.943	PASS
	Ant2	5745	18.035	5735.963	5753.998	PASS
	Ant1	5785	18.180	5775.891	5794.071	PASS
	Ant2	5785	18.168	5775.817	5793.985	PASS
	Ant1	5825	18.250	5815.876	5834.126	PASS
	Ant2	5825	18.201	5815.891	5834.092	PASS
11AC40MIMO	Ant1	5190	36.692	5171.502	5208.194	PASS
	Ant2	5190	36.359	5171.715	5208.074	PASS
	Ant1	5230	36.504	5211.597	5248.101	PASS
	Ant2	5230	36.499	5211.697	5248.196	PASS
	Ant1	5755	36.369	5736.829	5773.198	PASS
	Ant2	5755	36.522	5736.703	5773.225	PASS
	Ant1	5795	36.571	5776.780	5813.351	PASS
Ant2	5795	36.467	5776.788	5813.255	PASS	



11AC80MIMO	Ant1	5210	76.453	5171.481	5247.934	PASS
	Ant2	5210	76.489	5171.604	5248.093	PASS
	Ant1	5775	76.292	5737.038	5813.330	PASS
	Ant2	5775	76.020	5737.178	5813.198	PASS

12.2.2. Test Graphs



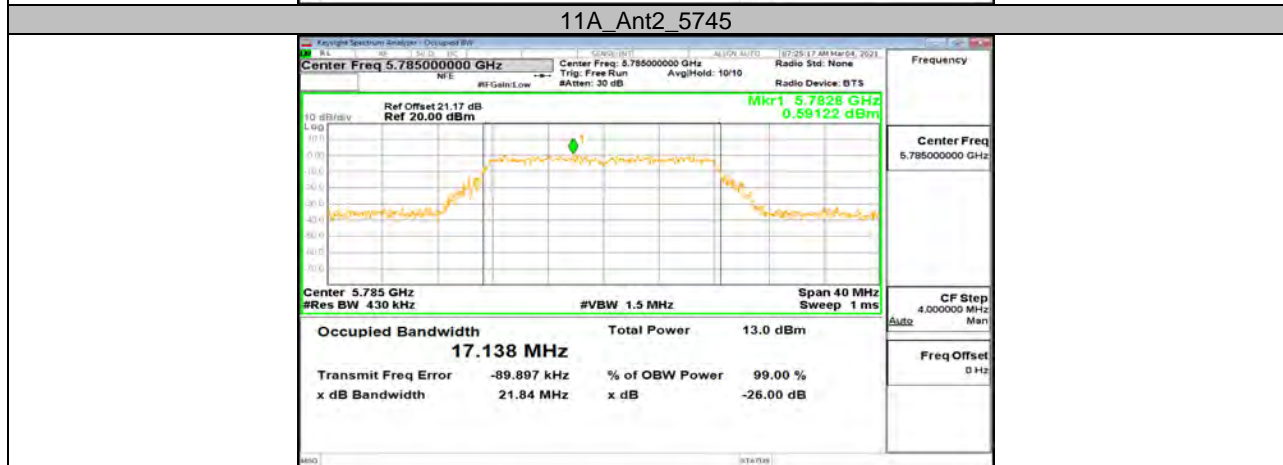
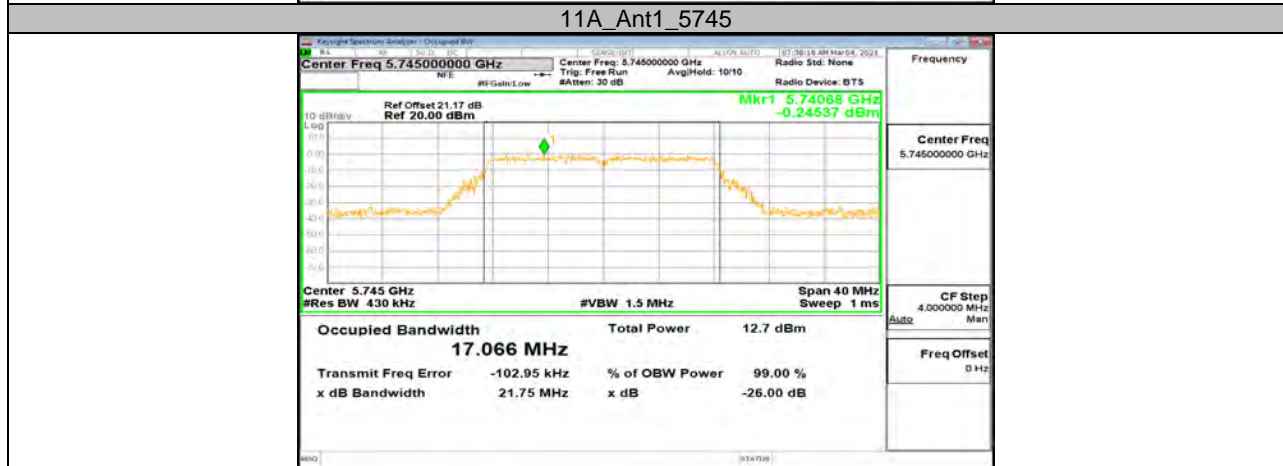
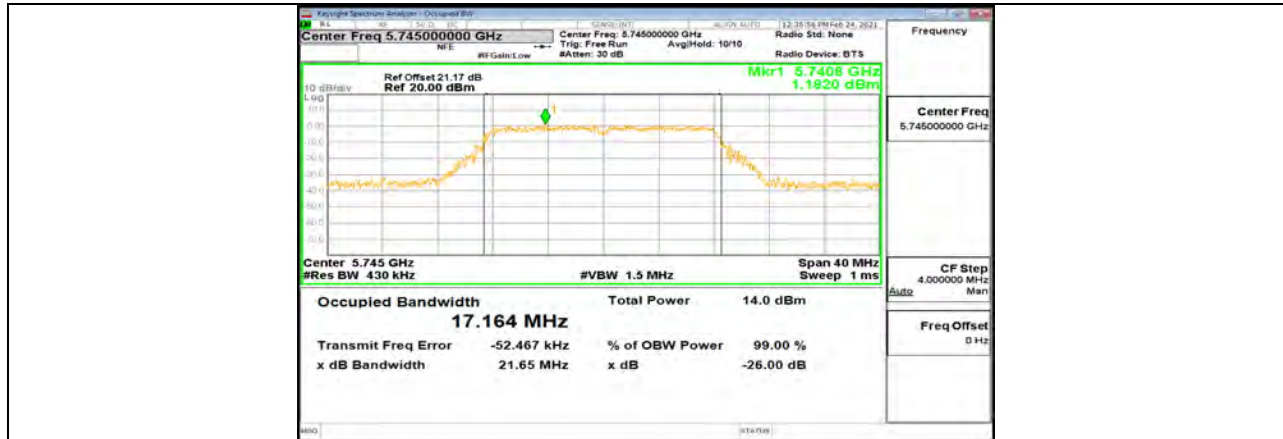

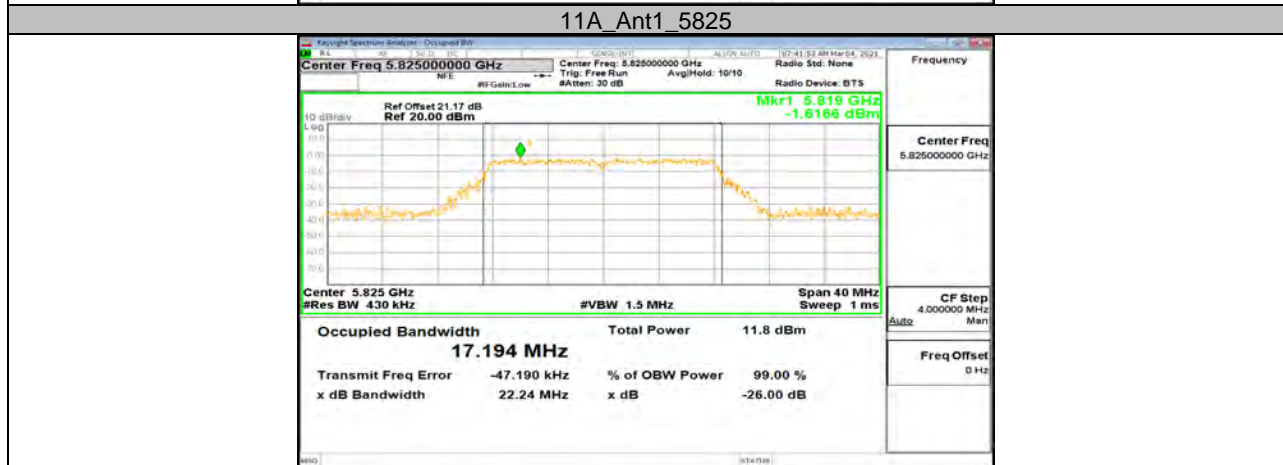
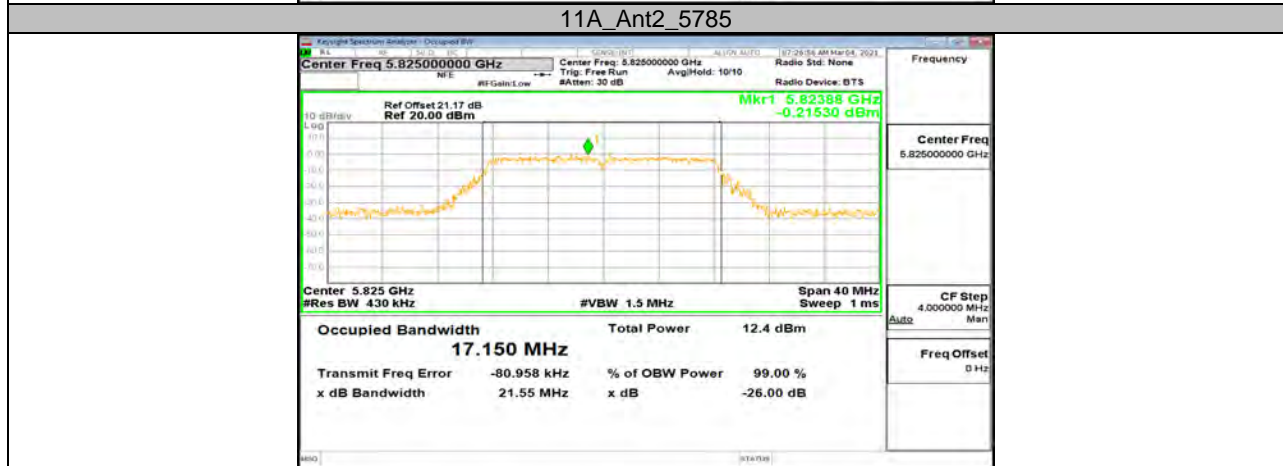
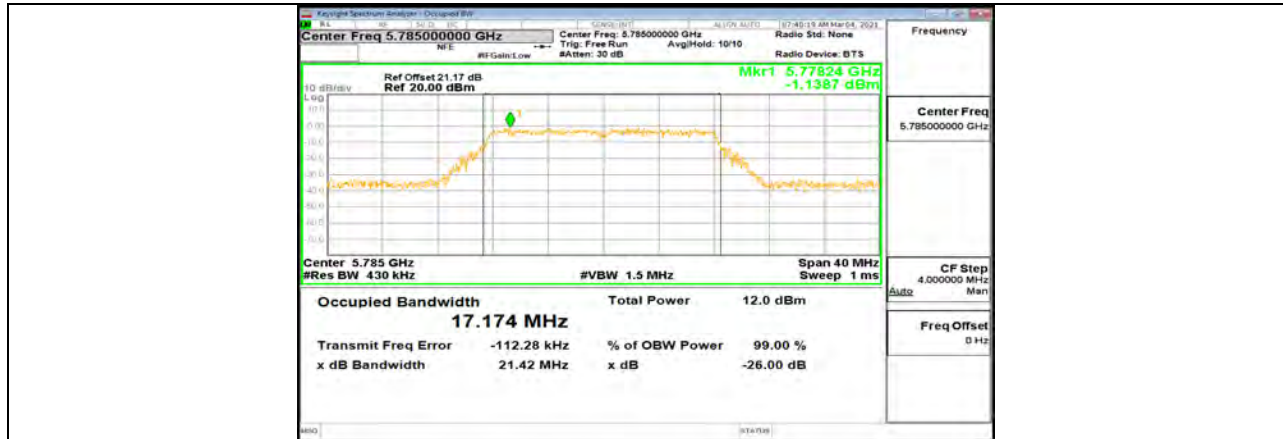

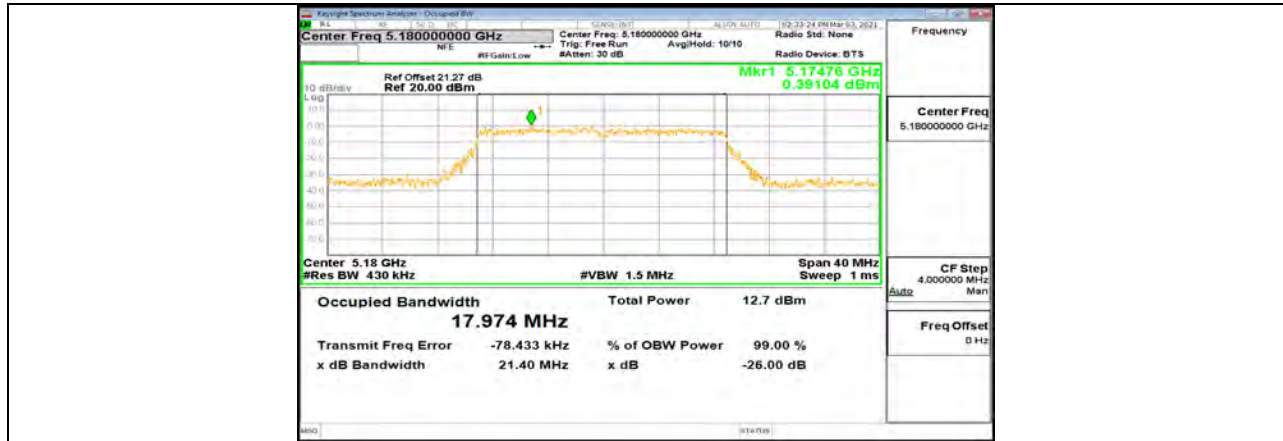

11N20MIMO_Ant1_5180

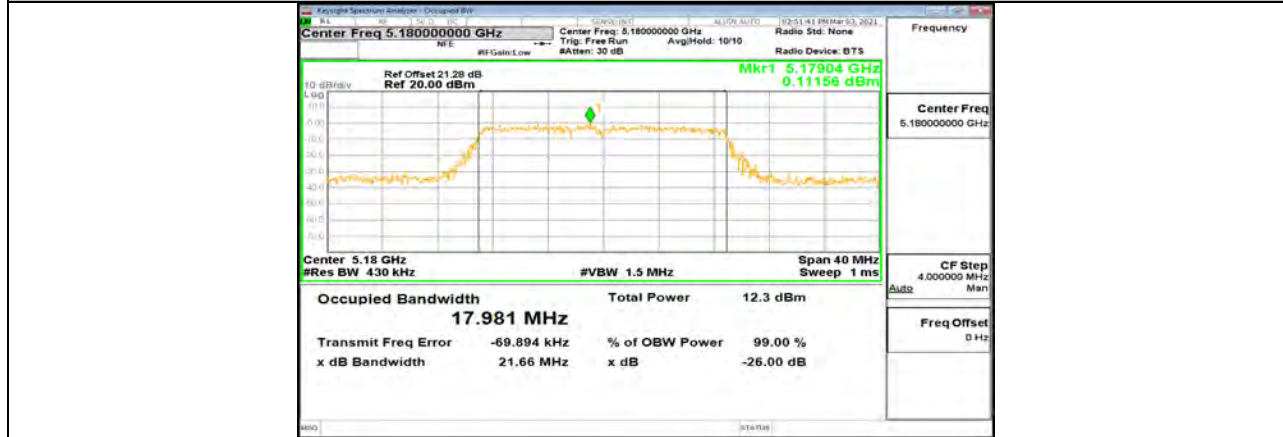

11N20MIMO_Ant2_5180

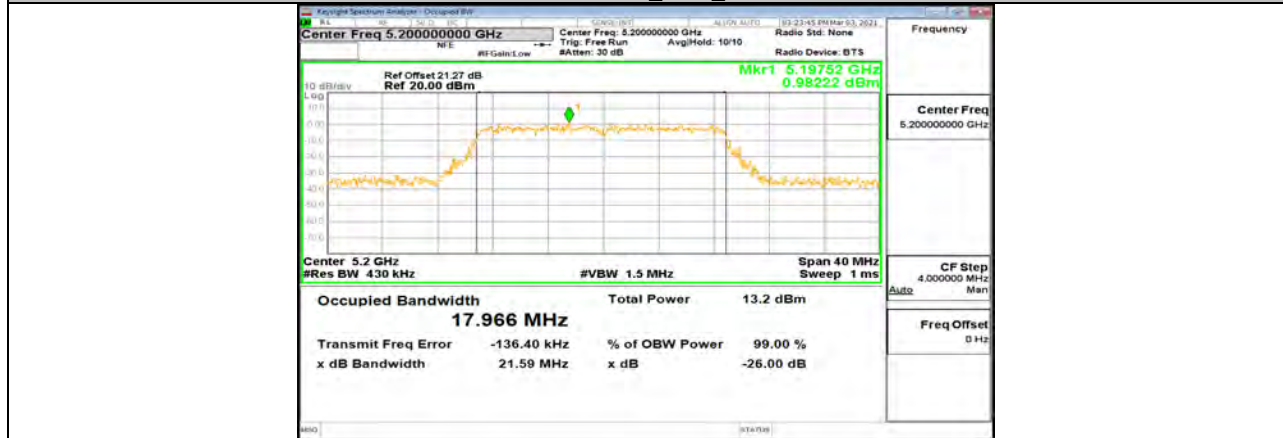

11N20MIMO_Ant1_5200

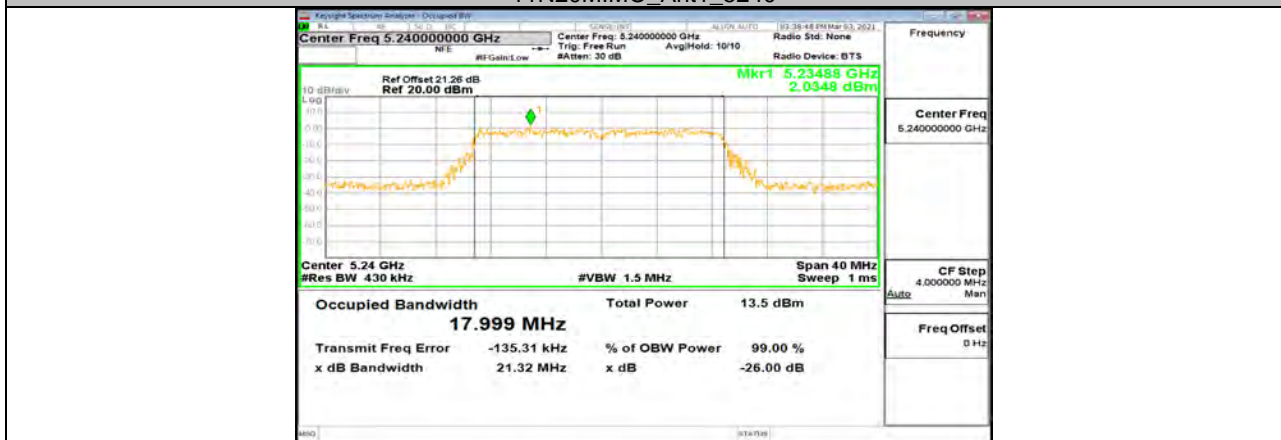
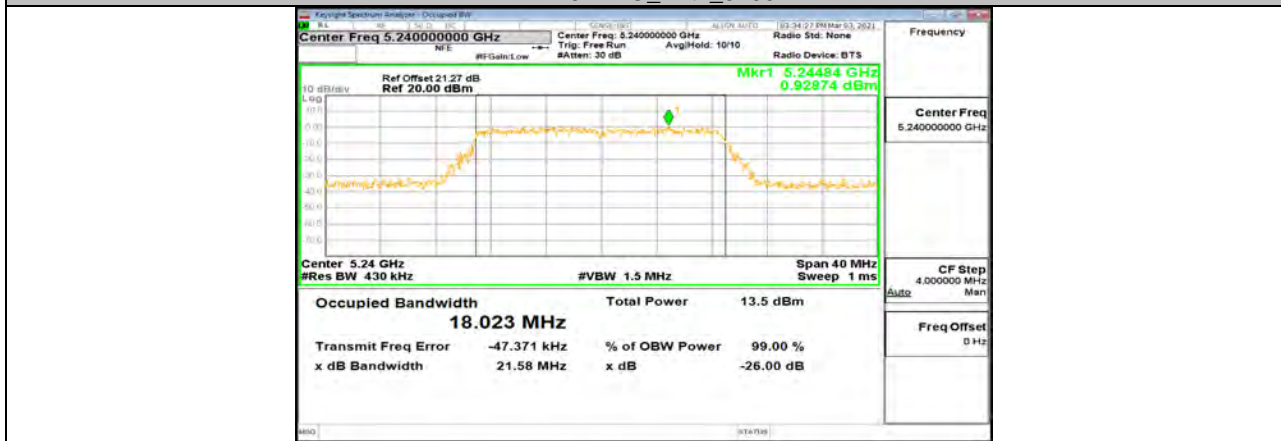
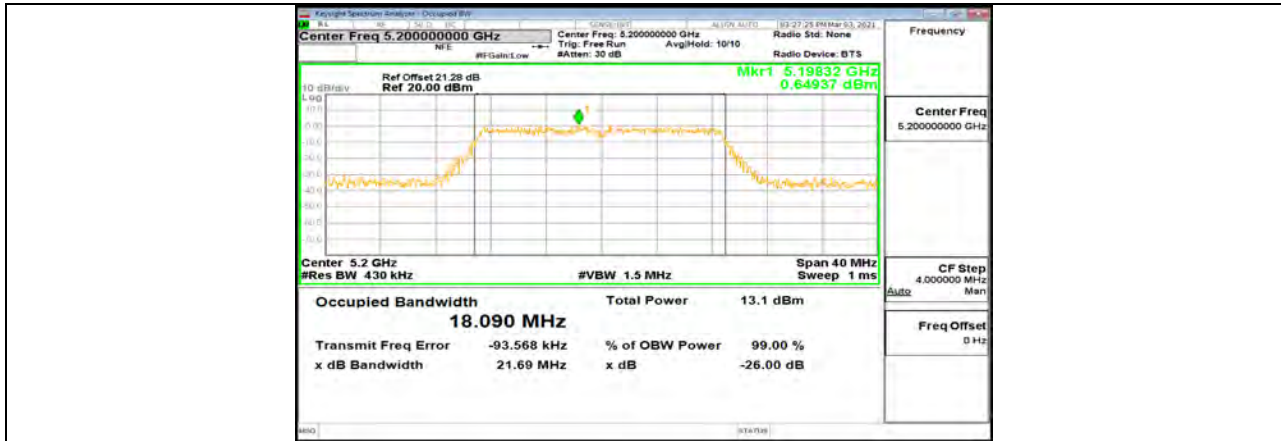

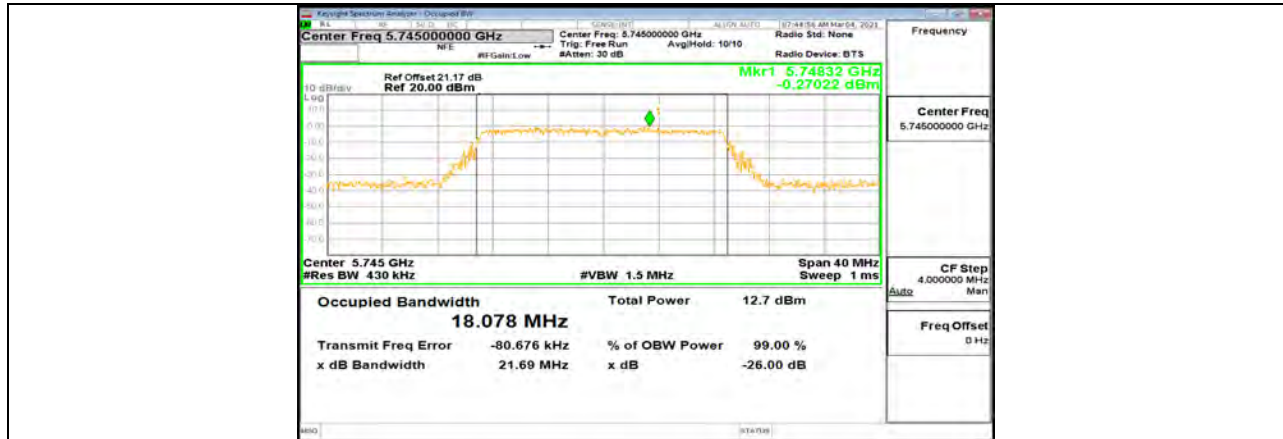

11N20MIMO_Ant1_5745

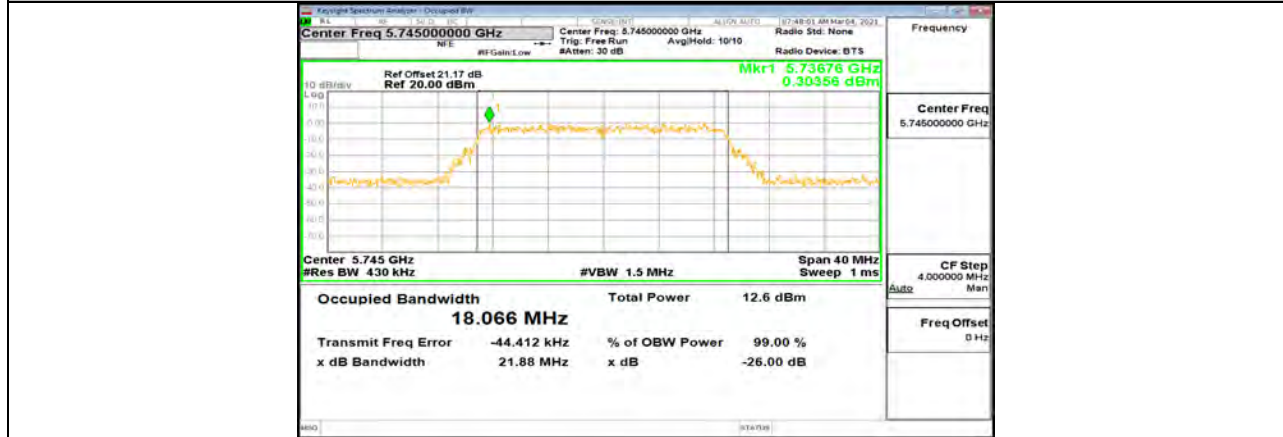

11N20MIMO_Ant2_5745

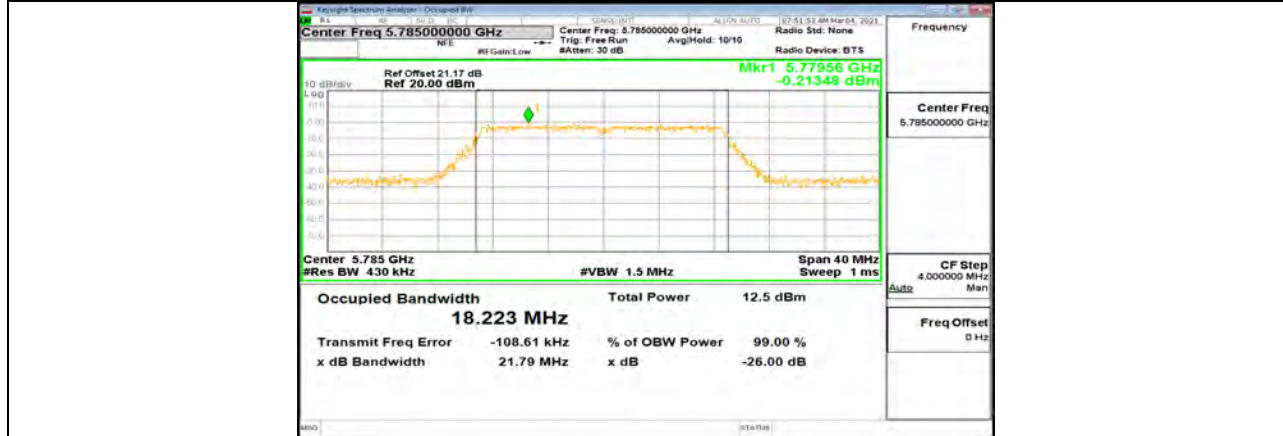

11N20MIMO_Ant1_5785

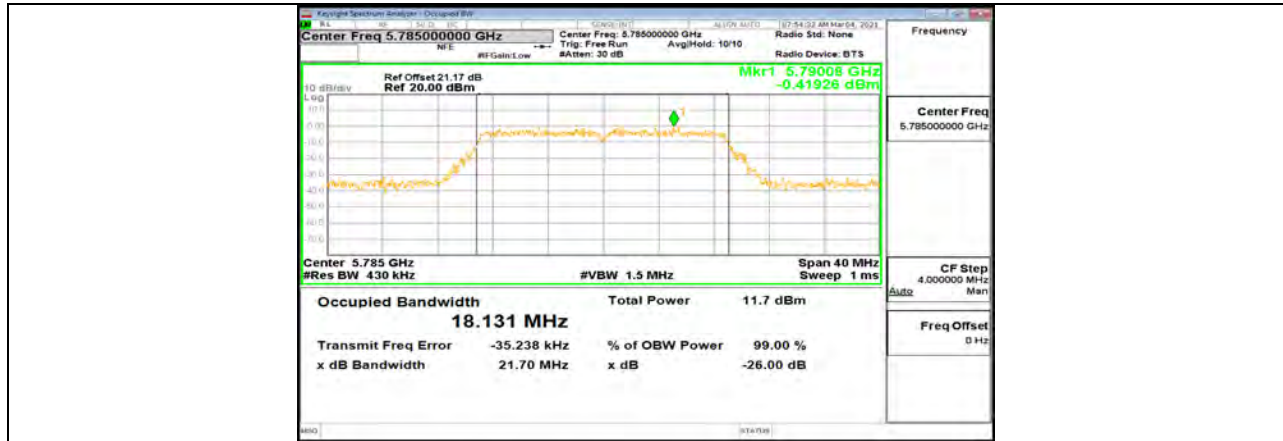

11N20MIMO_Ant2_5785

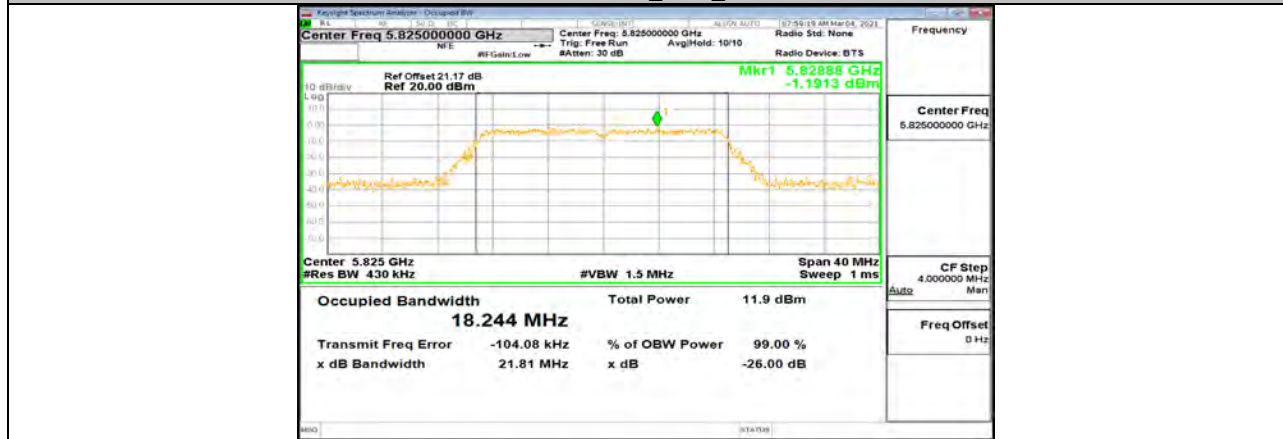

11N20MIMO_Ant1_5825

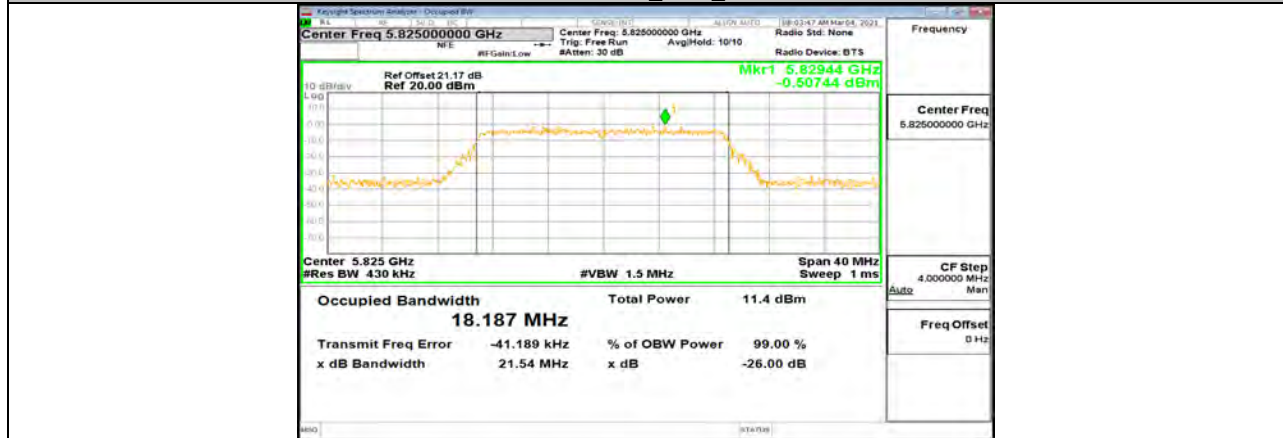

11N20MIMO_Ant2_5825