

7210R, 7230R, 7250R, 7270R and 7290R Tractors (Serial No. 080001-)(North American Edition) A4



OPERATOR'S MANUAL

7210R, 7230R, 7250R, 7270R and 7290R
Tractors (Serial No. 080001-)(North
American Edition)
OMRE340545_NA ISSUE A4 (ENGLISH)

CALIFORNIA

Proposition 65 Warning

Diesel engine exhaust and some of its constituents are known to the State of California to cause cancer, birth defects, and other reproductive harm.

If this product contains a gasoline engine:

⚠ WARNING

The engine exhaust from this product contains chemicals known to the State of California to cause cancer, birth defects or other reproductive harm.

The State of California requires the above two warnings.

Additional Proposition 65 Warnings can be found in this manual.

John Deere Waterloo Works

North American Edition
LITHO IN U.S.A.

Introduction

Foreword

READ THIS MANUAL carefully to learn how to operate and service your machine correctly. Failure to do so could result in personal injury or equipment damage. This manual and safety signs on your machine may also be available in other languages. (See your John Deere dealer to order.)

THIS MANUAL SHOULD BE CONSIDERED a permanent part of your machine and should remain with the machine when you sell it.

MEASUREMENTS in this manual are given in both metric and customary U.S. unit equivalents. Use only correct replacement parts and fasteners. Metric and inch fasteners may require a specific metric or inch wrench.

RIGHT-HAND AND LEFT-HAND sides are determined by facing in the direction of forward travel.

WRITE PRODUCT IDENTIFICATION NUMBERS (P.I.N.) in the Specification or Identification Numbers section. Accurately record all the numbers to help in tracing the machine should it be stolen. Your dealer also needs these numbers when you order parts. File the identification numbers in a secure place off the machine.

WARRANTY is provided as part of John Deere's support program for customers who operate and maintain their equipment as described in this manual. The warranty is explained on the warranty certificate or statement which you should have received from your dealer.

This warranty provides you the assurance that John Deere will back its products where defects appear within the warranty period. In some circumstances, John Deere also provides field improvements, often without charge to the customer, even if the product is out of warranty. Should the equipment be abused, or modified to change its performance beyond the original factory specifications, the warranty will become void and field improvements may be denied. Setting fuel delivery above specifications or otherwise overpowering machines will result in such action.

THE TIRE MANUFACTURER'S warranty supplied with your machine may not apply outside the U.S.

If you are not the original owner of this machine, it is in your interest to contact your local John Deere dealer to inform them of this unit's serial number. This will help John Deere notify you of any issues or product improvements.

DX,IFC1 -19-03APR09-1/1

Look For Supplemental Information

Occasionally new or revised information will become available after manuals are printed. To get this up-to-date information into your hands, publication supplements are prepared and supplied to the field in the machine literature package.

Supplements can be supplied in the following forms and are usually identified with one of these titles:

- Direction(s) Sheet
- Installation Instructions
- Publications Supplement

Before your initial review of the Operator's Manual, look through the machine literature package to see if any

supplemental information has been provided. If supplied, review this information to determine which operating procedures are impacted or modified by the revised instructions. Pay close attention to "CAUTION" and "IMPORTANT" statements as they address your safety, the safety of others, and safe operation of the machine.

When Operator's Manuals are revised, the supplemental information is incorporated directly into the manual, thereby eliminating the supplement.

TO84419,0000016 -19-27NOV12-1/1

Trademarks

Trademarks	
AccuDepth™	Trademark of Deere and Company
ACS™	Trademark of Deere and Company
ActiveSeat™	Trademark of Deere and Company
AMBLYGON™	Trademark of Kluber Lubrication
AMPSEAL 16™	Trademark of Tyco Electronics
AutoLoad™	Trademark of Deere and Company
AutoPowr™	Trademark of Deere and Company
AutoPowr™/IVT™	Trademark of Deere and Company
AutoQuad™ II	Trademark of Deere and Company
AutoQuad™ PLUS	Trademark of Deere and Company
AutoTrac™	Trademark of Deere and Company
Avdel™	Trademark of Avdel UK Limited
Bio Hy-Guard™	Trademark of Deere and Company
Break-In™	Trademark of Deere and Company
Break-In PLUS™	Trademark of Deere and Company
CINCH™	Trademark of Cinch Inc.
ClimaTrak™	Trademark of Deere and Company
ComfortCommand™	Trademark of Deere and Company
ComfortGard™	Trademark of Deere and Company
ComfortGard Deluxe™	Trademark of Deere and Company
CommandARM™	Trademark of Deere and Company
CommandCenter™	Trademark of Deere and Company
CommandQuad™	Trademark of Deere and Company
CommandView™	Trademark of Deere and Company
COOL-GUARD™ II	Trademark of Deere and Company
CoolScan™	Trademark of Deere and Company
CPC™	Trademark of AMP Incorporated
Deere™	Trademark of Deere and Company
DEUTSCH™	Trademark of Deutsch Company
DURABUILT™	Trademark of Camoplast Inc.
Efficiency Manager™	Trademark of Deere and Company
FieldCruise™	Trademark of Deere and Company
Field Doc™	Trademark of Deere and Company
Field Office™	Trademark of Deere and Company
GreenStar™	Trademark of Deere and Company
HY-GARD™	Trademark of Deere and Company
ILS™	Trademark of Deere and Company
iPhone®	Trademark of Apple, Inc.
iPod®	Trademark of Apple, Inc.
iPod Touch®	Trademark of Apple, Inc.
iTEC™	Trademark of Deere and Company
iTEC™ Pro	Trademark of Deere and Company
IVT™	Trademark of Deere and Company
IVT Selector™	Trademark of Deere and Company
JDLINK™	Trademark of Deere and Company
JDOffice™	Trademark of Deere and Company
John Deere™	Trademark of Deere and Company
John Deere FarmSight™	Trademark of Deere and Company
Loctite™	Trademark of Henkel Corporation
MATE-N-LOC™	Trademark of AMP Incorporated

Continued on next page

RW29387,000050B -19-05AUG13-1/2

Introduction

Trademarks

METRIMATE™	Trademark of AMP Incorporated
METRI-PACK™	Trademark of Delphi Packard Electric Systems
NEVER-SEEZ™	Trademark of Bostik-Findley Inc.
Oilscan™	Trademark of Deere and Company
Parallel Tracking™	Trademark of Deere and Company
PLUS-50™ II	Trademark of Deere and Company
PowrQuad™	Trademark of Deere and Company
PowrQuad™ PLUS	Trademark of Deere and Company
PowerTech™	Trademark of Deere and Company
PowerTech™ Plus	Trademark of Deere and Company
Power Zero™	Trademark of Deere and Company
QUICK METAL™	Trademark of Henkel Corporation
Quik-Tatch™	Trademark of Deere and Company
Row-Trak™	Trademark of Deere and Company
Service ADVISOR™	Trademark of Deere and Company
SERVICEGARD™	Trademark of Deere and Company
StarFire™	Trademark of Deere and Company
StarFire™ iTC	Trademark of Deere and Company
STC™	Trademark of Aeroquip Corporation
StellarSupport™	Trademark of Deere and Company
SUMITOMO™	Trademark of Sumitomo Corporation
TEFLON™	Trademark of DuPont Co.
TIA™	Trademark of Deere and Company
TLS™	Trademark of Deere and Company
TLS™ Plus	Trademark of Deere and Company
TouchSet™	Trademark of Deere and Company
Tractor-Implement Automation™	Trademark of Deere and Company
Vari-Cool™	Trademark of Deere and Company
Weather Pack™	Trademark of Packard Electric
YAZAKI™	Trademark of Yazaki Corporation

RW29387,000050E -19-05AUG13-2/2

D
R
O
O
F

Quick Reference Specifications

Capacities (Approximate):

NOTE: See Specifications Section for Additional Information

	7210R	7230R	7250R	7270R	7290R
Fuel Tank, CommandQuad™, G47/G48 Tires ^a	503 L (133 gal.)		Not Available		
Fuel Tank, CommandQuad™, G47/G48 Tires ^b	572 L (151 gal.)		Not Available		
Fuel Tank, e23™, G48 Tires ^a	475 L (125 gal.)				
Fuel Tank, e23™, G47/48 Tires ^b	544 L (144 gal.)		Not Available		
Fuel Tank, e23™, G49 Tires	Not Available		497 L (131 gal.)		
Fuel Tank, IVT™/AutoPowr™, G47/G48 Tires ^a	520 L (137 gal.)				
Fuel Tank, IVT™/AutoPowr™, G47/G48 Tire ^b	589 L (156 gal.)		Not Available		
Fuel Tank, IVT™/AutoPowr™, G49 Tires ^a	Not Available		543 L (143 gal.)		
DEF Tank ^a	25.7 L (6.8 gal.)				
Cooling System	39.5 L (10.5 gal.)				44.5 L (11.8 gal.)
Crankcase, Including Filter	24.5 L (26.0 qt.)		27 L (28.5 qt.)		
Transmission-Hydraulic System, CommandQuad™ ^c	160 L (42.3 gal.)		Not Available		
Transmission-Hydraulic system, e23™, ^c	160 L (42.3 gal.)				
Transmission-Hydraulic system, IVT™/AutoPowr™ ^c	160 L (42.3 gal.)				
Front PTO	4.0 L (4.25 qt.)				
TLS™ Plus with Differential Lock	10.8 L (2.8 gal.)				
TLS™ Plus with Limited Slip	14.4 L (3.8 gal.)				
1150 MFWD Axle	14.4 L (3.8 gal.)	Not Available			
1300 MFWD Axle ^a	14.4 L (3.8 gal.)				
1300 MFWD Axle ^b	Not Available	14.4 L (3.8 gal.)	Not Available		
Wheel Hubs without Brakes	3.8 L (4.0 qt.)				
Wheel Hubs with Brakes	3.9 L (4.1 qt.)				

^aUS EPA Final Tier 4/EU Stage IV

^bUS EPA Tier 2/EU Stage II

^cActual volume may vary depending on additional SCV's and tractor options.

TO84419,0000018 -19-06SEP13-1/1

PROOF PROOF

Contents

Page	Page
Safety	
Recognize Safety Information	05-1
Understand Signal Words.....	05-1
Follow Safety Instructions.....	05-1
Prepare for Emergencies.....	05-2
Wear Protective Clothing.....	05-2
Protect Against Noise.....	05-2
Handle Fuel Safely—Avoid Fires.....	05-3
Handle Starting Fluid Safely.....	05-3
Fire Prevention.....	05-3
In Case of Fire.....	05-4
Avoid Static Electricity Risk When Refueling.....	05-4
Keep ROPS Installed Properly.....	05-5
Use Foldable ROPS and Seat Belt Properly.....	05-5
Stay Clear of Rotating Drivelines.....	05-6
Use Steps and Handholds Correctly.....	05-6
Read Operator Manuals for ISOBUS Implements.....	05-6
Use Seat Belt Properly.....	05-7
Operating the Tractor Safely.....	05-8
Avoid Backover Accidents.....	05-9
Limited Use in Forestry Operation.....	05-9
Operating the Loader Tractor Safely.....	05-9
Keep Riders Off Machine.....	05-10
Instructional Seat.....	05-10
Use Safety Lights and Devices.....	05-10
Use a Safety Chain.....	05-11
Transport Towed Equipment at Safe Speeds.....	05-11
Use Caution On Slopes and Uneven Terrain.....	05-12
Freeing a Mired Machine.....	05-12
Avoid Contact with Agricultural Chemicals.....	05-13
Handle Agricultural Chemicals Safely.....	05-14
Handling Batteries Safely.....	05-15
Avoid Heating Near Pressurized Fluid Lines.....	05-15
Remove Paint Before Welding or Heating.....	05-16
Handle Electronic Components and Brackets Safely.....	05-16
Practice Safe Maintenance.....	05-17
Avoid Hot Exhaust.....	05-17
Clean Exhaust Filter Safely.....	05-18
Work In Ventilated Area.....	05-19
Support Machine Properly.....	05-19
Prevent Machine Runaway.....	05-19
Park Machine Safely.....	05-20
Transport Tractor Safely.....	05-20
Service Cooling System Safely.....	05-20
Service Accumulator Systems Safely.....	05-21
Service Tires Safely.....	05-21
Service Front-Wheel Drive Tractor Safely.....	05-21
Tightening Wheel Retaining Bolts/Nuts.....	05-22
Avoid High-Pressure Fluids.....	05-22
Do Not Open High-Pressure Fuel System.....	05-22
Store Attachments Safely.....	05-23
Dispose of Waste Properly.....	05-23
Safety Signs	
Operator's Manual.....	10-1
Seat Belt.....	10-2
Instructional Seat (If Equipped).....	10-3
Cab Suspension Accumulators (If Equipped).....	10-3
Starter.....	10-4
Engine Block Heater (If Equipped).....	10-4
Triple Link Suspension Plus (TLS™ Plus) (If Equipped).....	10-5
Brake Valve Accumulator (If Equipped).....	10-6
Front PTO (If Equipped).....	10-6
Quick Coupler (If Equipped).....	10-7
Rear PTO Shield (If Equipped).....	10-8
Controls and Instruments	
Front Console.....	15-1
Information Indicators.....	15-1
Aftertreatment Indicators Overview.....	15-2
Corner Post Display.....	15-3
Digital Indicators—Tachometer, Ground Speed, Transmission, and Set Speed.....	15-4
Gauges—Coolant Temperature, Diesel Exhaust Fluid (DEF) Level, and Fuel Level.....	15-5
CommandARM™ with Generation 4 CommandCenter™ Display.....	15-5
CommandARM™ Joystick.....	15-6
CommandARM™ Hitch Controls (If Equipped).....	15-6
CommandARM™ SCV Controls.....	15-7
CommandARM™ Climate, Radio, and Lighting Controls.....	15-7
CommandARM™ PTO Controls.....	15-7
CommandARM™ Left Side Controls.....	15-8
CommandARM™ ISOBUS (ISB) Shortcut Button.....	15-8
Accelerator Pedal (If Equipped).....	15-9
External Switches.....	15-9

Continued on next page

Original Instructions. All information, illustrations and specifications in this manual are based on the latest information available at the time of publication. The right is reserved to make changes at any time without notice.

COPYRIGHT © 2014
DEERE & COMPANY
Moline, Illinois
All rights reserved.
A John Deere ILLUSTRATION © Manual

	Page
CommandCenter™	
Onscreen Help.....	16-1
Generation 4 CommandCenter Display.....	16-1
Generation 4 CommandCenter Processor.....	16-2
Main Menu.....	16-2
Run Page Structure.....	16-3
Operating System Applications Overview.....	16-3
AMS Applications Overview.....	16-6
Automation Status Overview.....	16-7
Tractor Settings Overview.....	16-7
Navigate Generation 4 CommandCenter™.....	16-10
Activating System.....	16-11
Navigate Run Pages on Main Page.....	16-11
Shortcut Buttons.....	16-11
Navigate to Display & Sound.....	16-12
Display & Sound.....	16-12
Brightness.....	16-12
Sound.....	16-13
Navigate to Date & Time.....	16-14
Date & Time Application.....	16-14
Change Current Date.....	16-15
Change Current Time.....	16-15
Navigate to Language & Units.....	16-16
Language & Units.....	16-16
Language & Units Settings.....	16-16
Changing Pages and Values.....	16-17
Generation 4 CommandCenter™	
Status Center.....	16-18
Navigate to Multiple Displays.....	16-19
Multiple Displays.....	16-20
Display Calibration.....	16-20
Software Manager.....	16-21
Update Display Software.....	16-21
Activations.....	16-22
Remote Software Updates (If Equipped).....	16-23
File Manager.....	16-23
Capture Screen Shots.....	16-24
Navigate to Diagnostics Center.....	16-25
Diagnostics Center.....	16-25
Controller Diagnostics.....	16-26
Diagnostic Mode.....	16-26
Hide Diagnostic Center.....	16-26
Trouble Codes.....	16-27
Readings.....	16-28
CANBUS Information.....	16-28
CANBUS Values.....	16-29
Navigate to Users & Access.....	16-30
Users & Access.....	16-30
User Profiles.....	16-30
Access Groups.....	16-31
Navigate to Layout Manager.....	16-32
Layout Manager.....	16-32
Active Set.....	16-32
Add, Edit, or Duplicate Run Pages.....	16-33
AutoTrac Guidance.....	16-34
Navigate to Machine Profile.....	16-34

	Page
Machine Profiles.....	16-35
Navigate to Implement Profile.....	16-35
Implement Profiles.....	16-36
Navigate to Machine Monitor.....	16-36
Machine Monitor.....	16-37
Navigate to Work Monitor.....	16-37
Work Monitor.....	16-37
Work Recording.....	16-38
Navigate to Maintenance & Calibrations.....	16-38
Maintenance & Calibrations.....	16-38
Calibrations.....	16-39
Service Intervals.....	16-39
Navigate to Controls Setup.....	16-40
Controls Setup.....	16-40
Controls.....	16-41
Automation Status.....	16-42
Read ISOBUS Implement Operator's Manual ..	16-42
ISOBUS VT.....	16-43
StarFire GPS Receiver.....	16-43
Use Video Display Capability Properly.....	16-44
Installing Video Display Camera.....	16-45
Three-Camera Video Connectors with	
Ethernet Cable (If Equipped).....	16-46
Navigate to Video Application Settings.....	16-46
Video Application.....	16-47
Video Triggers.....	16-47

Operating the Radio

Using Premium Radio.....	17-1
External Sources—Using Premium Radio.....	17-2
Radio Source Select—On Generation	
4 CommandCenter™.....	17-3
AM, FM, Weather Channel Home Page.....	17-3
Premium Radio CD Home Page (If Equipped) ..	17-4
Premium Radio XM Home Page (If Equipped) ..	17-4
Premium Radio USB Home Page (If Equipped) ..	17-5
Premium Radio Bluetooth® Home	
Page (If Equipped).....	17-5
Auxiliary Home Page.....	17-6
Operating Phone.....	17-6
Phone Book.....	17-7
Recent Calls.....	17-8
Pairing Bluetooth® Device—On	
Generation 4 CommandCenter™.....	17-9

Lights

Light Identification.....	20-1
Configurable Lights.....	20-2
Steering Column Light Controls.....	20-3
Exit Lights.....	20-4
Operating Turn Signals and High/Low Beam.....	20-5
Safety Lights and Devices.....	20-6
CommandARM™ Light Buttons.....	20-6
Hazard Lights and Extremity Warning Lights.....	20-7
Rotary Beacon Light (If Equipped).....	20-8
7-Pin Outlet.....	20-9

Continued on next page

	Page
Operator Station	
Avoid Contact with Agricultural Chemicals	25-1
Adjust ComfortCommand™ Seat	25-2
Adjust Heated Leather Seat (If Equipped)	25-2
Adjust ActiveSeat™ (If Equipped)	25-3
Adjust ComfortCommand™ with HCS Plus Cab Suspension Seat	25-4
Using Instructional Seat.....	25-5
Operator Presence Sensor.....	25-5
Adjust CommandARM™ Position.....	25-6
Adjust Steering Wheel and Column.....	25-6
Operate Horn	25-7
Generation 4 CommandCenter™ HVAC Settings	25-8
Operate Front Wiper and Washer	25-9
Operate Rear Wiper and Washer (If Equipped) ..	25-9
Operate Right-Hand Wiper and Washer (If Equipped).....	25-9
Install Business Band or Citizens Band (CB) Radio and Antenna	25-10
Use Auxiliary Power Strip and Electrical Outlets (If Equipped)	25-11
Connect Compatible Electronic Equipment	25-12
Configure Tractor For GPS/Radar	25-13
Mount StarFire™ Receiver	25-14
Installing GreenStar System Components	25-15
Install Machine Communications Radio (MCR) Antenna (If Equipped).....	25-16
Connect AutoTrac™ Assisted Steering System (If Equipped).....	25-17
Monitor Bracket Mounts.....	25-18
Use Manual Mirror (If Equipped)	25-18
Use Electric Mirror (If Equipped)	25-19
Use Telescoping Heated Electric Mirror (If Equipped).....	25-19
Refrigerator or Storage Space (If Equipped)	25-20
Position Left-Hand Steps.....	25-21
Right-Hand Service Steps	25-22

Operating the Engine

Exhaust Filter System Overview.....	30-1
Selective Catalytic Reduction (SCR) System Overview	30-2
Auto Exhaust Filter Cleaning Mode	30-3
Parked Exhaust Filter Cleaning	30-4
Selective Catalyst Reduction (SCR) System - Final Tier 4 and Stage IV Engines ..	30-5
Engine Fuel System and Power Rating.....	30-6
Battery Disconnect (If Equipped).....	30-6
Starting the Engine	30-7
Running the Engine	30-8
Stopping the Engine	30-8
Cold Weather Starting—Equipped With Glow Plug Starting Aid (6.8 L Engines).....	30-9
Cold Weather Starting—Without Optional Starting Aid (9.0 L Engines).....	30-10

	Page
Cold Weather Starting—With Starting Aid (9.0 L Engines—If Equipped).....	30-11
Changing Starting Fluid Can (If Equipped).....	30-12
Low Fuel or Low Diesel Exhaust Fluid (DEF) Warning	30-12
Restarting Engine That Has Run Out of Fuel ...	30-12
Reduce Fuel Consumption	30-13
Using Auxiliary Heaters	30-13
Using a Battery Booster or Charger	30-14

Operating the Tractor

Avoid Contact with Agricultural Chemicals	40-1
Clean Vehicle of Hazardous Pesticides.....	40-1
Keep Riders Off Machine	40-1
Keep Operator Station Window and Door Closed	40-2
Using Seat Belts	40-2
Using Emergency Exit	40-3
Disconnect Battery - Final Tier 4 and Stage IV Engines	40-3
Paths to Important CommandCenter™ Pages ...	40-3
Changing to a Different Size of Tire.....	40-4
Transmission - Note on Top Speed	40-4
Warm-Up Transmission-Hydraulic System.....	40-5
Using FieldCruise™	40-8
Intelligent Power Management (If Equipped)	40-9
Triple Link Suspension Plus (TLS™ Plus) (If Equipped)	40-10
TLS™ Plus and Cab Suspension (If Equipped)	40-11
Using Differential Lock.....	40-12
Mechanical Front-Wheel Drive (MFWD).....	40-13
AutoTrac™ Assisted Steering System (If Equipped).....	40-14
Using Autoclutch (If Equipped)	40-15
Using the Brakes	40-16
Hydraulic Trailer Brakes (If Equipped).....	40-17
Trailer Air Brakes (If Equipped)	40-18
Come Home Mode	40-19

Operating CommandQuad™ Transmission

Transmission Description and Controls.....	41-1
Operating Transmission	41-2
Adjusting Set Speeds	41-3
CommandCenter™ Transmission Main Page	41-5
CommandQuad™ Custom Settings	41-6
Advanced Settings Page	41-8
Tractor Speed Displays on Corner Post Display and CommandCenter™	41-9
Downhill Operation in Slippery Conditions	41-9

Operating e23™ Transmission

Transmission Operation e23™ Transmission with Right Hand Re- verser.....	44-1
Shifting e23™ Transmission with Right-hand reverser	44-2

Continued on next page

	Page
e23™ Transmission with Left-Hand Reverser.....	44-4
Shifting e23™ Transmission with Left-hand reverser	44-5
Setting Startup Gears	44-6
CommandCenter™ Transmission Main Page	44-7
Efficiency Manager™ on the e23™ Transmission	44-8
Efficiency Manager™ on e23™ Transmission in Manual Mode	44-9
Custom Transmission Settings	44-10

Operating IVT™/AutoPowr™ Transmission	
Controls Identification	45-1
Left-Hand and Right-Hand Reverser Shift Patterns	45-2
Operating the Transmission	45-3
Adjusting Set Speeds	45-4
Set Speeds—Guidelines and Examples	45-5
IVT™/AutoPowr™ Modes and Setting Maximum Speed	45-6
Custom IVT™/AutoPowr™ Settings	45-7
Adjusting Reverse/Forward Set Speed Ratio	45-8
Adjusting AutoClutch Sensitivity	45-9
Putting Tractor in Motion	45-10
Using Creeper Mode	45-10
IVT™ AutoPowr™ — Accelerator Pedal Mode (If Equipped)	45-11
Using Individual Brake Pedals	45-12
Stopping and Parking Tractor	45-13
Downhill Operation in Slippery Conditions	45-14

Intelligent Total Equipment Control (iTEC™)	
CommandARM™ Control Functions	47-1
CommandCenter™ Pages Descriptions And Functions	47-2
Status Area	47-2
Sequence Step Status	47-3
Set Up A Sequence	47-8
Execute Sequence	47-9
Delete iTEC™ Sequence	47-10
iTEC Functions—IVT™/AutoPowr™ Transmission	47-10

Tractor-Implement Automation™ (TIA™)	
Tractor-Implement Automation™ (TIA™)	50-1
Activating Tractor-Implement Automation™ Equipment	50-2
Operating Tractor-Implement Automation™	50-3
PTO Requirements	50-3
SCV Requirements	50-4
IVT™/AutoPowr™ Requirements	50-5
AutoTrac™ Guidance Requirements	50-6
Rear Hitch Requirements	50-6
Drive Strategy Requirements	50-6

TouchSet™ Depth Control	
Attaching Implement and Control System	55-1
Using TouchSet™ Depth Controls	55-2

Hydraulics and Selective Control Valves	
Configuring Selective Control Valves - Access to Settings	60-1
Configuring Selective Control Valves - Standard Mode	60-2
Activating Independent Mode	60-3
Configuring Selective Control Valves - Independent Mode	60-4
Configuring Selective Control Valves - Feature Mode	60-5
Laser Scraper—for Scrapers Equipped with Scraper Control Unit	60-6
Total Rear SCV Flow	60-8
Using Six Position SCV Control Levers	60-9
SCV Control Lever—Neutral Position	60-10
SCV Control Lever—Extend and Extend Detent Position	60-10
SCV Control Lever—Retract and Retract Detent Position	60-11
SCV Control Lever—Float Position	60-12
Operator Presence Sensor	60-12
CommandARM™ Joystick (If Equipped)	60-13
Hydraulic Option Connector Harness Operation	60-16

Laser Scraper	
Laser Scraper—for Scrapers Equipped with Scraper Control Unit	62-1

Remote Hydraulic Connections	
Connecting Hydraulic Hoses—Rear of Tractor ..	63-1
Disconnecting Hydraulic Hoses—Rear of Tractor	63-2
Connecting/Disconnecting Hydraulic Hoses—Mid-Mount Valve Stack or Front Valves (If Equipped)	63-3
Implement Hydraulic Connections	63-5
Hydraulic Motor Return and Case Drain Kits	63-6
Hitch Auxiliary Raise Kit	63-6
Using Load-Sensing Hydraulic System (Power Beyond)	63-7
Examples Using Load-Sensing Hydraulic System—Power-Beyond	63-8
Using Implements Requiring Large Volumes of Oil	63-8
Connecting Grain Drills or Air Seeders	63-9
Implement Connection Example 2—Motor Application Using Power Beyond and Motor Case Drain	63-10

Continued on next page

	Page
Implement Connection Example 3—Motor Application Using SCV Retract and Auxiliary Motor Return	63-11
Implement Connection Example 4—Planter with Vacuum Motor and Return Line to SCV Using Motor Return Tip.....	63-12
Implement Connection Example 5—Integral Planter with Hitch Auxiliary Raise Operated in Parallel with Hitch Valve	63-13
Implement Connection Example 6—Integral Planter with Hitch Auxiliary Raise, Hitch Cylinders Controlled by SCV in Parallel with Hitch Auxiliary Raise	63-14

Hitch

Rear Hitch.....	65-1
Hitch Controls	65-3
Adjust Load Depth Control (Draft Response)	65-4
Using Position Control	65-4
Draft Control	65-5
Adjusting Hitch Upper Limit	65-6
Adjusting Rear Hitch Drop Rate	65-7
Adjust Rear Hitch Raise Rate.....	65-8
Rear Hitch Slip Sensitivity	65-8
Float Operation.....	65-9
Rear Hitch Components	65-9
Using Remote Raise and Lower Switches (If Equipped)	65-10
Using Hitch Manual Lowering Feature	65-11
Using Correct Center Link Position	65-11
Hydraulic Center Link (If Equipped).....	65-12
Using Sway Blocks	65-13
Quick Coupler.....	65-14
Adjusting Implement Level	65-15
Adjusting Lateral Float.....	65-15
Detaching Implement from Quick Coupler.....	65-16
Hitch Conversion—Convertible Quick Coupler.....	65-17
Using Front Hitch (If Equipped)	65-18
Adjusting Front Hitch Drop Rate.....	65-19
Adjusting Front Hitch Raise Rate	65-20

Drawbar and PTO

Stay Clear of Rotating Drivelines.....	70-1
Drawbar Load Limits Based on Drawbar Position and Length and PTO Type	70-2
Adjusting Drawbar Length, Height and Side to Side.....	70-3
Installing and Using Clevis Assembly Cat 3 Drawbar	70-4
Installing and Using Clevis Assembly (High Vertical Load Drawbar Support)	70-5
Attaching Rear PTO Driven Implement	70-6

	Page
Attaching Front PTO Driven Implement (If Equipped).....	70-7
Rear PTO Shield—Type 3 PTO.....	70-7
Using Correct Engine Speed	70-8
PTO Engagement Rate	70-9
Operating Front PTO (If Equipped)	70-10
Operating Rear PTO.....	70-11
Remote Front PTO Switch (If Equipped)	70-12
Remote Rear PTO Switch (If Equipped).....	70-13
Operating Shiftable 3-Speed Rear PTO (If Equipped)	70-14
Operating Shiftable 2-Speed Rear PTO (If Equipped)	70-15
Changing PTO Stub Shaft (If Equipped)	70-16

Performance Ballasting

Ballasting Information and Guidelines for Tractors with Single Tires.....	75-1
General Guidelines for Tractor Weight Based on Engine Horsepower	75-1
General Weight Split Guidelines.....	75-2
Ballast Types	75-3
Ballasting Suggestions for Specific Types of Implements used with MFWD Tractors	75-5
Determining Ballasted Tractor Weight, Weight Split, Axle Loads, and Required Tire Inflation Pressures.....	75-7
Controlling Power Hop (MFWD tractors without front suspension)	75-8
Unballasted Tractor Weight Charts.....	75-9
Unballasted Tire Weight Charts.....	75-11
Maximum Load Per Wheel	75-14
Installing Quik-Tatch™ Weights.....	75-14
Using Rear Wheel Weights	75-15
Ballasting Suggestions for Hitch Mounted Implements.....	75-16
Adding Rear Ballast For Front Loader.....	75-16
Using Liquid Ballast	75-17
Liquid Ballast Charts.....	75-18
Implement Codes	75-19
Measuring Wheel Slip (Manually).....	75-20

Front Wheels, Tires, and Treads

Service Tires Safely.....	80-1
Tire Combinations	80-2
Exchanging Tire Sizes	80-3
Tire Inflation Pressure Guidelines	80-3
Recommended Pressures—Group 42	80-4
Recommended Pressures—Group 42 (Continued)	80-5
Recommended Pressures—Group 43	80-6
Recommended Pressures—Group 43 (Continued)	80-7
Recommended Pressures—Group 43 IF Tires	80-8
Recommended Pressures—Group 44	80-9

Continued on next page

	Page
Tire Load Rating	80-10
Tightening Front Wheel Bolts—MFWD	80-11
Checking Toe-In (MFWD and TLS™ Plus Axles)	80-12
Adjusting Toe-In (MFWD and TLS™ Plus Axles)	80-12
Setting Steering Stop Positions	80-13
Eight-Position MFWD Wheel Settings	80-14
710 mm Extra Wide Deluxe Pivoting Front Fenders	80-16
Final Fender Positioning	80-16
MFWD Fender Settings—Deluxe Pivoting Fenders	80-16
Front Tire, Fender, and Steering Stop Settings Table Explanation	80-18
1150/1300 MFWD Axles, Tire, Fender, and Steering Stop Settings	80-19
TLS™ Plus Axle Tire, Fender, and Steering Stop Settings	80-23
1150/1300 MFWD Axles, With Front Hitch, Tire, Fender, and Steering Stop Settings (If Equipped)	80-26
TLS™ Plus With Front Hitch Tire, Fender, and Steering Stop Settings (If Equipped)	80-28
1150/1300 MFWD Axles, With Front Loader, Tire, Fender, and Steering Stop Settings (If Equipped)	80-30
TLS™ Plus With Front Loader, Tire, Fender, and Steering Stop Settings (If Equipped)	80-34

Rear Wheels, Tires, and Treads

Service Tires Safely	81-1
Tire Combinations	81-2
Exchanging Tire Sizes	81-3
Tire Inflation Pressure Guidelines	81-3
Recommended Pressures—Group 47 Singles	81-4
Recommended Pressures—Group 47 Singles (Continued)	81-5
Recommended Pressures—Group 47 Duals	81-6
Recommended Pressures—Group 47 Duals (Continued)	81-7
Recommended Pressures—Group 48 Singles	81-8
Recommended Pressures—Group 48 Singles (Continued)	81-9
Recommended Pressures—Group 48 Duals	81-10
Recommended Pressures—Group 48 Duals (Continued)	81-11
Recommended Pressures—Group 48 IF Singles	81-12
Recommended Pressures—Group 48 IF Duals	81-13
Recommended Pressures—Group 49	81-14
Tire Load Rating	81-15
16-Position Rear Wheel Settings	81-16
Installing Rear Drive Wheel to Cast Hub	81-17

	Page
Installing Rear Steel Wheel to Hub	81-17
Adjusting and Tightening Rear Steel Wheels—Cast Hubs	81-18
Adjusting and Tightening Rear Wheels—Heavy-Duty Cast 10-Cap Screw Hubs	81-19
Adjusting and Tightening Rear Wheels—Heavy-Duty 12-Cap Screw Hubs	81-20
Wheel Tightening Stand	81-21
Rear Wheel, Tire, and Tread Guidelines	81-22
Rear Single Drive Wheel Tread Settings—Steel Wheels	81-23
Rear Single Drive Wheel Tread Settings—Cast Wheels	81-24
Rear Dual Wheel Tread Settings—Steel Drive Wheels	81-26
Rear Dual Wheel Tread Settings—Cast Drive Wheels	81-29
Rear Dual Wheel Row Crop Settings and Dual Hub Extensions—Cast Drive Wheels	81-31
Clamp-on Dual Usage	81-32

Transporting

Driving Tractor on Roads	85-1
Transporting with Ballast	85-1
Towing Loads	85-2
Safety Chain	85-3
Towing Tractor	85-4
Releasing Park Brake Electrically	85-5
Freeing a Mired Machine	85-7
Transporting on Carrier	85-7

Fuel, Lubricants, and Coolant

Diesel Fuel	90-1
Supplemental Diesel Fuel Additives	90-1
Lubricity of Diesel Fuel	90-2
Handling and Storing Diesel Fuel	90-2
Avoid Static Electricity Risk When Refueling	90-3
Filling Fuel Tank	90-4
BioDiesel Fuel	90-5
Testing Diesel Fuel	90-6
Fuel Filters	90-6
Minimizing the Effect of Cold Weather on Diesel Engines???	90-7
Filling Diesel Exhaust Fluid (DEF) Tank - FT4/Stage IV Engines	90-8
Diesel Exhaust Fluid (DEF) — For Use In Selective Catalytic Reduction Equipped Engines	90-9
Storing Diesel Exhaust Fluid (DEF)	90-10
Refilling Diesel Exhaust Fluid (DEF) Tank	90-11
Testing Diesel Exhaust Fluid (DEF)	90-12
Disposal of Diesel Exhaust Fluid (DEF)	90-12
John Deere Break-In Plus™ Engine Oil — Interim Tier 4, Final Tier 4, Stage IIIB, and Stage IV	90-12

Continued on next page

	Page
Determining Tractor Engine Type.....	90-13
Diesel Engine Oil—FT4/Stage IV and IT4/Stage III B Engines???	90-13
Engine Oil and Filter Service Intervals—Final Tier 4 and Stage IV and Interim Tier 4 and Stage III B Engines ..	90-14
Diesel Engine Oil—Tier 2 and Stage II Engines	90-15
Engine Oil and Filter Service Intervals—Tier 2 and Stage II Engines.....	90-16
Oil Filters	90-16
Diesel Engine Coolant.....	90-17
Water Quality for Mixing with Coolant Concentrate.....	90-18
Operating in Warm Temperature Climates	90-18
Testing Coolant Freeze Point	90-19
Disposing of Coolant	90-19
John Deere COOL-GARD™ II Coolant Extender.....	90-20
Transmission and Hydraulic Oil.....	90-20
Use Correct Viscosity Front PTO Oil in Cold Weather	90-21
Transmission Recalibration	90-21
Gear Oil	90-21
Grease.....	90-22
Mixing of Lubricants.....	90-22
Alternative and Synthetic Lubricants	90-22
Lubricant Storage	90-23

Break-In Service (100 Hours Or Less)

Perform Break-In Checks	92-1
-------------------------------	------

Maintenance and Service Intervals

Observe Service Intervals	95-1
Service Interval Chart—Daily or 10 Hour, 50 Hour, 100 Hour, 250 Hour, 500 Hour and 1000 Hour.....	95-2
Service Interval Charts	95-3

As Indicated Service

Perform As Indicated Service.....	100-1
Replace Primary and Secondary Engine Air Filters.....	100-1
Check Coolant Level	100-3
Replace Diesel Particulate Filter (DPF).....	100-3
Drain Water Separator.....	100-4

As Required Service

Perform As Required Service.....	103-1
Service Engine Air Filter Precleaner System....	103-1
Clean Radiator, Coolers, and Air Conditioning Condenser.....	103-4
Check Engine Compartment for Debris.....	103-5
Check Air Conditioning System.....	103-6
Replace Fan Belt	103-7
Check Engine Weep Hole	103-9

	Page
Check MFWD or TLS™ Plus (If Equipped) Axle Housing Oil Level.....	103-10
Check MFWD or TLS™ Plus (If Equipped) Wheel Hub Oil Level	103-11
Bleed Trailer Hydraulic Brakes (If Equipped) ..	103-12
Bleed Trailer Air Brakes (If Equipped)	103-13
Cleaning Diesel Exhaust Fluid (DEF) Tank	103-14

Daily or 10 Hour Service

Check Engine Oil Level	105-1
Check Transmission-Hydraulic Oil Level.....	105-2
Lubricate MFWD or TLS™ Plus Kingpins, Tie Rod Ends, Steering Cylinder, Axle Pivot and Panhard Rod	105-3
Lubricate MFWD or TLS™ Plus U-Joints.....	105-3

50 Hour Service

Perform This and Other Scheduled Services ...	110-1
Inspect Tires	110-1
Lubricate Rear Hitch.....	110-1
Lubricate Front Hitch (If Equipped).....	110-1

250 Hour Service

Perform This and Other Scheduled Services ...	115-1
Lubricate Rear Hitch.....	115-1
Lubricate Front Hitch (If Equipped).....	115-2
Check Manual Brakes	115-2
Check Neutral Start System	115-3
Check Transmission PARK System.....	115-4
Check Swinging Drawbar for Wear	115-5
Check Front PTO Housing Oil Level (If Equipped).....	115-5
Change Front PTO Oil Filter (If Equipped)	115-6

500 Hour Service

Perform This and Other Scheduled Services ...	120-1
Change Engine Oil and Filter—6.8 L Engine....	120-1
Change Engine Oil and Filter—9.0 L Engine....	120-3
Lubricate MFWD or TLS™ (If Equipped) Plus Kingpins, Tie Rod Ends, Steering Cylinder, Axle Pivot and Panhard Rod	120-5
Lubricate MFWD or TLS™ Plus (If Equipped) U-Joints.....	120-6
Tighten Wheel and Wheel Weight Bolts	120-6
Use Wheel Tightening Stand	120-7
Tighten Rear Wheel Weight Bolts.....	120-7
Tighten Front Wheel Bolts	120-8
Tighten Rear Drive Wheel to Cast Hub Bolts ...	120-8
Tighten Rear Steel Wheel to Hub Bolts	120-9
Tighten Rear Steel Wheels—Cast Hub Bolts ...	120-9
Tighten Rear Wheel Bolts—Heavy- Duty Cast 10-Bolt Hubs.....	120-10
Tighten Rear Wheel Bolts—Heavy- Duty 12-Bolt Hubs	120-11

Continued on next page

	Page
Clean Dual Beam Radar Sensor (If Equipped).....	120-11
Replace Fuel Filters.....	120-12
Inspect Engine Air Intake System - 6.8 L Engine.....	120-13
Inspect Engine Air Intake System - 9.0 L Engine.....	120-15
Lubricate Cab Suspension System (If Equipped).....	120-17
Back Flush Optional Fuel Water Separator (If Equipped).....	120-18
Service Optional Fuel Water Separator Filter Element (If Equipped).....	120-19

1000 Hour Service

Perform This and Other Scheduled Services ...	125-1
Replace Cab Recirculation Air Filter.....	125-1
Replace Cab Fresh Air Filter.....	125-2
Clean MFWD or TLS™ Plus (If Equipped) Axle Vent Filter.....	125-3
Test Coolant and Add Coolant Conditioner	125-3
Check TLS™ Plus Accumulator Charge Pressure (If Equipped)	125-3
Check Cab Suspension Accumulator Charge Pressure (If Equipped)	125-4

Annual Service

Handling Batteries Safely	130-1
Service Batteries and Connections	130-2
Test Coolant and Add Coolant Conditioner	130-3
Replace Cab Recirculation and Fresh Air Filters	130-4
Inspect Seat Belts.....	130-4
Inspect Primary and Secondary Engine Air Filters	130-5
Check TLS™ Plus Accumulator Charge Pressure (If Equipped)	130-6
Check Cab Suspension Accumulator Charge Pressure (If Equipped)	130-7
Replace Trailer Air Brake Air Dryer Filter (If Equipped).....	130-7

1500 Hour Service

Perform This and Other Scheduled Services ...	135-1
Change Transmission/Hydraulic Oil and Filter and Clean Sump Screen.....	135-2
Change MFWD or TLS™ Plus Wheel Hub Oil.....	135-6
Change MFWD or TLS™ Plus Axle Housing Oil.....	135-7
Lubricate Draft Link Support Shaft Bushing	135-8
Inspect Fan Belt and Fan Belt Tensioner.....	135-9
Change Front PTO Housing Oil and Filter (If Equipped).....	135-12
Replace Open Crankcase Ventilation Filter (6.8 L Engine Only)	135-13
Drain Fuel Tank Sump.....	135-14

Fuel Tank Vent Filter.....	135-14
Replace Diesel Exhaust Fluid (DEF) Tank Vent- FT4/Stage IV Engines	135-15

2000 Hour Service

Perform This and Other Scheduled Services ...	140-1
Adjust Engine Valve Clearance - Tier 2/Stage II Engines.....	140-1

3000 Hour Service

Perform This and Other Scheduled Services ...	142-1
Adjust Engine Valve Clearance—FT4/Stage IV Engines.....	142-1

4500 Hour Service

Perform This and Other Scheduled Services ...	145-1
Replace Transmission Drive Shaft Damper	145-1
Access Diesel Exhaust Fluid (DEF) Dosing Unit and Tank Vent Filters - FT4/Stage IV Engines.....	145-2
Changing Diesel Exhaust Fluid (DEF) Dosing Unit Filter.....	145-3

5000 Hour Service

Perform Service And All Subordinate Services	148-1
Replace Engine Crankshaft Damper	148-1

6000 Hour Service

Perform This and Other Scheduled Services ...	150-1
Drain, Flush, and Refill Cooling System - 6.8 L Engine.....	150-1
Drain, Flush, and Refill Cooling System - 9.0 L Engine.....	150-1

General Service

Jack Up the Tractor - Lifting Points and Support Stand Placement	155-1
Servicing and Connecting Snap to Connect Fittings.....	155-3
Using High-Pressure Washers	155-3
Diesel Particulate Filter Service.....	155-4
Exhaust Filter/Diesel Particulate Filter (DPF) Ash Handling and Disposal	155-4
Exhaust Filter Disposal.....	155-4
Do Not Modify Fuel System.....	155-5
Do Not Open High-Pressure Fuel System.....	155-5
Bleed Fuel System	155-5

Electrical System Service

Introduction to Electrical Service Section	160-1
Disconnect Battery - Final Tier 4 and Stage IV Engines	160-1
Load Center Fuses.....	160-2
Master Fuses.....	160-5

Continued on next page

	Page
Welding Near Electronic Control Units	160-6
Keep Electronic Control Unit	
Connectors Clean	160-6
Using Compressed Air.....	160-6
Using High-Pressure Washers	160-7
Service Implement Power Relay Module.....	160-8
Handle Halogen Light Bulbs Safely	160-9
Replace Front HID/LED Light Assembly	160-9
Replace Front Grille Halogen Light Bulbs	160-10
Adjust Front Grille Lights	160-11
Aim Headlights	160-12
Replace Front, Side And Rear Cab	
Roof Light Assembly	160-13
Replace Brake or Turn Signal Light Bulb	160-14
Replace Dome Light Bulb.....	160-15
Replace Courtesy Light Bulb	160-16
Replace Map Light Bulb	160-17
Replace Extremity Warning Light Bulb	
(If Equipped).....	160-18
Troubleshooting	
Engine Troubleshooting.....	165-1
Transmission Troubleshooting.....	165-4
Hydraulic System Troubleshooting	165-5
Hitch Troubleshooting.....	165-6
Selective Control Valve (SCV)	
Troubleshooting.....	165-8
Depth Control	165-9
Electrical System Troubleshooting	165-10
Operator Enclosure Troubleshooting.....	165-12
Tractor Operation Troubleshooting	165-13
Independent Link Suspension	165-13
Diagnostic Trouble Codes	
STOP, Service Alert, and Information	
Indicators.....	170-1
Accessing Diagnostic Trouble Codes	170-2
Armrest Interface Control Unit (AIC)	
Diagnostic Trouble Codes	170-3
ActiveSeat™ Control Unit (ASU)	
Diagnostic Trouble Codes	170-4
Automatic Temperature Control Unit	
(ATC) Diagnostic Trouble Codes.....	170-5
Brake Control Unit (BRC) Diagnostic	
Trouble Codes.....	170-5
Chassis Control Unit (CCU) Diagnostic	
Trouble Codes.....	170-6
Cab Load Center Control Unit (CLC)	
Diagnostic Trouble Codes	170-7
Cab Roof Control Unit (CRU)	
Diagnostic Trouble Codes	170-7
Cab Suspension Control Unit (CSC)	
Diagnostic Trouble Codes	170-8
Cab Switch Module (CSM) Diagnostic	
Trouble Codes.....	170-9
Engine Control Unit (ECU) Diagnostic	
Trouble Codes.....	170-10

	Page
Engine Interface Control Unit (EIC)	
Diagnostic Trouble Codes.....	170-15
Front Console Control Unit (FCC)	
Diagnostic Trouble Codes	170-15
Hitch Control Unit (HCC) Diagnostic	
Trouble Codes.....	170-16
Hitch Valve Control Unit (HV1)	
Diagnostic Trouble Codes	170-16
StarFire Control Unit (ITC) Diagnostic	
Trouble Codes.....	170-17
JDLink™ Control Unit (JDL) Diagnostic	
Trouble Codes.....	170-17
Operator Interface Control Unit (OIC)	
Diagnostic Trouble Codes	170-18
Corner Post Display (PDU) Diagnostic	
Trouble Codes.....	170-18
Front PTO Control Unit (PTF)	
Diagnostic Trouble Codes	170-19
IVT™/AutoPowr™ Control Unit (PTI)	
Diagnostic Trouble Codes	170-20
e23™ Transmission Shift Control Unit	
(PTP) Diagnostic Trouble Codes.....	170-22
CommandQuad™, Transmission	
Control Unit (PTQ) Diagnostic	
Trouble Codes.....	170-23
Roof Lighting Control Unit (RLC)	
Diagnostic Trouble Codes	170-24
Rear PTO Control Unit (RPT)	
Diagnostic Trouble Codes	170-25
SCV Control Unit (SCC) Diagnostic	
Trouble Codes.....	170-26
Secondary Hydraulic Control Unit	
(SCO) Diagnostic Trouble Codes.....	170-27
Suspended Front Axle Control Unit	
(SFA) Diagnostic Trouble Codes.....	170-28
Sequence Control Unit (SMV)	
Diagnostic Trouble Codes	170-28
Selective Control Valve Units (SV)	
Diagnostic Trouble Codes	170-29
Tractor Equipment Control Unit (TEC)	
Diagnostic Trouble Codes	170-31
Tractor Equipment Interface Control	
Unit (TEI) Diagnostic Trouble Codes.....	170-31
IVT™/AutoPowr™ Transmission Shift	
Control Unit (TII) Diagnostic Trouble	
Codes.....	170-32
e23™ Transmission Shift Control Unit	
(TIP) Diagnostic Trouble Codes	170-33
CommandQuad™Transmission Shift	
Control Unit (TIQ) Diagnostic	
Trouble Codes.....	170-34
Vehicle Load Center Control Unit (VLC)	
Diagnostic Trouble Codes	170-34
Virtual Terminal Implement Control	
Unit (VTI) Diagnostic Trouble Codes.....	170-35

Continued on next page

PROOF

	Page
Steering System Control Unit (XMA, XMB, XSA, XSB) Diagnostic Trouble Codes	170-36
Steering System Control Unit (XMC, XSC) Diagnostic Trouble Codes	170-38

	Page
5000 Hour Service Record	190-4
6000 Hour Service Record	190-5
Glossary	
Glossary of Terms	195-1

Storage

Place Tractor in Storage	175-1
Long-Term Storage	175-2
Paint Finish Care	175-3

Specifications

Engine	180-1
Capacities	180-2
Hydraulic	180-3
Electrical System	180-3
Transmission and Drive Train	180-4
Hitch, Drawbar and PTO	180-6
Tractor Load/Weights	180-7
Overall Dimensions	180-8
Ground Speeds	
40 km/h (20-Speed) CommandQuad™ Eco Shift	180-9
Ground Speeds—50 km/h (31 mph) (20-Speed) CommandQuad™ Eco Shift Transmission	180-10
Ground Speeds—50 km/h (31 mph) (23-Speed) e23™ Transmission	180-11
Ground Speeds—IVT™/AutoPowr™	180-12
Metric Bolt and Screw Torque Values	180-13
Unified Inch Bolt and Screw Torque Values	180-14
Identify Zinc-Flake Coated Fasteners	180-14
EPA Non-road Emissions Control Warranty Statement—Compression Ignition	180-15
CARB Non-road Emissions Control Warranty Statement—Compression Ignition	180-17
Limited Battery Warranty	180-21

Identification Numbers

Serial Number Plates	185-1
Record Product Identification Number	185-1
Record Engine Serial Number	185-2
Record Cab Serial Number	185-3
Keep Proof of Ownership	185-3
Keep Machines Secure	185-4

Lubrication and Maintenance Records

50 Hour Service Record	190-1
250 Hour Service Record	190-1
500 Hour Service Record	190-2
1000 Hour Service Record	190-2
Annual Service Record	190-3
1500 Hour Service Record	190-3
2000 Hour Service Record	190-3
3000 Hour Service Record	190-4
4500 Hour Service Record	190-4

Safety

Recognize Safety Information

This is a safety-alert symbol. When you see this symbol on your machine or in this manual, be alert to the potential for personal injury.

Follow recommended precautions and safe operating practices.



T81389 —UN—28JUN13

DX,ALERT -19-29SEP98-1/1

Understand Signal Words

A signal word—DANGER, WARNING, or CAUTION—is used with the safety-alert symbol. DANGER identifies the most serious hazards.

DANGER or WARNING safety signs are located near specific hazards. General precautions are listed on CAUTION safety signs. CAUTION also calls attention to safety messages in this manual.

▲ DANGER

▲ WARNING

▲ CAUTION

TS187 —19—30SEP88

DX,SIGNAL -19-03MAR93-1/1

Follow Safety Instructions

Carefully read all safety messages in this manual and on your machine safety signs. Keep safety signs in good condition. Replace missing or damaged safety signs. Be sure new equipment components and repair parts include the current safety signs. Replacement safety signs are available from your John Deere dealer.

There can be additional safety information contained on parts and components sourced from suppliers that is not reproduced in this operator's manual.

Learn how to operate the machine and how to use controls properly. Do not let anyone operate without instruction.

Keep your machine in proper working condition. Unauthorized modifications to the machine may impair the function and/or safety and affect machine life.



TS201 —UN—15APR13

If you do not understand any part of this manual and need assistance, contact your John Deere dealer.

DX,READ -19-16JUN09-1/1

Prepare for Emergencies

Be prepared if a fire starts.

Keep a first aid kit and fire extinguisher handy.

Keep emergency numbers for doctors, ambulance service, hospital, and fire department near your telephone.

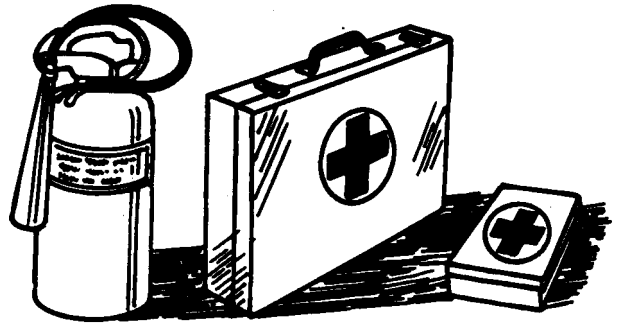

TS291 —UN—15APR13

DX,FIRE2 -19-03MAR93-1/1

Wear Protective Clothing

Wear close fitting clothing and safety equipment appropriate to the job.

Operating equipment safely requires the full attention of the operator. Do not wear radio or music headphones while operating machine.

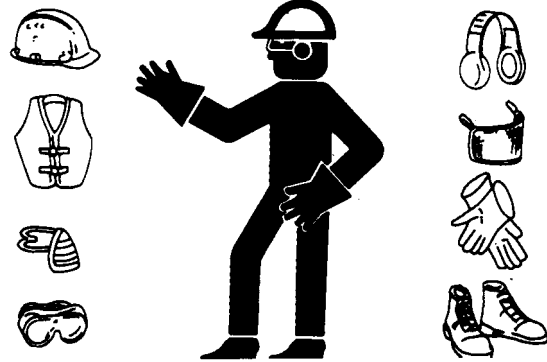

TS206 —UN—15APR13

DX,WEAR2 -19-03MAR93-1/1

Protect Against Noise

Prolonged exposure to loud noise can cause impairment or loss of hearing.

Wear a suitable hearing protective device such as earmuffs or earplugs to protect against objectionable or uncomfortable loud noises.



TS207 —UN—23AUG88

DX,NOISE -19-03MAR93-1/1

Handle Fuel Safely—Avoid Fires

Handle fuel with care: it is highly flammable. Do not refuel the machine while smoking or when near open flame or sparks.

Always stop engine before refueling machine. Fill fuel tank outdoors.

Prevent fires by keeping machine clean of accumulated trash, grease, and debris. Always clean up spilled fuel.

Use only an approved fuel container for transporting flammable liquids.

Never fill fuel container in pickup truck with plastic bed liner. Always place fuel container on ground before refueling. Touch fuel container with fuel dispenser nozzle before removing can lid. Keep fuel dispenser nozzle in contact with fuel container inlet when filling.



TS202—UN—23AUG88

Do not store fuel container where there is an open flame, spark, or pilot light such as within a water heater or other appliance.

DX,FIRE1 -19-12OCT11-1/1

Handle Starting Fluid Safely

Starting fluid is highly flammable.

Keep all sparks and flame away when using it. Keep starting fluid away from batteries and cables.

To prevent accidental discharge when storing the pressurized can, keep the cap on the container, and store in a cool, protected location.

Do not incinerate or puncture a starting fluid container.



TS1356—UN—18MAR92

DX,FIRE3 -19-16APR92-1/1

Fire Prevention

To reduce the risk of fire, your tractor should be regularly inspected and cleaned.

- Birds and other animals may build nests or bring other flammable materials into the engine compartment or onto the exhaust system. The tractor should be inspected and cleaned prior to the first use each day.
- A build up of grass, crop material and other debris may occur during normal operation. This is especially true when operating in very dry conditions or conditions where airborne crop material or crop dust is present. Any such build up must be removed to ensure proper machine function and to reduce the risk of fire. The tractor must be inspected and cleaned periodically throughout the day.
- Regular and thorough cleaning of the tractor combined with other routine maintenance procedures listed in the

Operator's Manual greatly reduce the risk of fire and the chance of costly downtime.

- Do not store fuel container where there is an open flame, spark, or pilot light such as within a water heater or other appliance.
- Check fuel lines, tank, cap, and fittings frequently for damage, cracks or leaks. Replace if necessary.

Follow all operational and safety procedures posted on the machine and the Operator's Manual. Be careful of hot engine and exhaust components during inspection and cleaning. Before carrying out any inspection or cleaning, always shut OFF the engine, place the transmission in PARK or set parking brake, and remove the key. Removal of the key will prevent others from starting the tractor during inspection and cleaning.

DX,WW,TRACTOR,FIRE,PREVENTION -19-12OCT11-1/1

In Case of Fire

CAUTION: Avoid personal injury.

Stop machine immediately at the first sign of fire. Fire may be identified by the smell of smoke or sight of flames. Because fire grows and spreads rapidly, get off the machine immediately and move safely away from the fire. Do not return to the machine! The number one priority is safety.

Call the fire department. A portable fire extinguisher can put out a small fire or contain it until the fire department arrives; but portable extinguishers have limitations. Always put the safety of the operator and bystanders first. If attempting to extinguish a fire, keep your back to the wind with an unobstructed escape path so you can move away quickly if the fire cannot be extinguished.

Read the fire extinguisher instructions and become familiar with their location, parts, and operation before a fire starts. Local fire departments or fire equipment distributors may offer fire extinguisher training and recommendations.

If your extinguisher does not have instructions, follow these general guidelines:



1. Pull the pin. Hold the extinguisher with the nozzle pointing away from you, and release the locking mechanism.
2. Aim low. Point the extinguisher at the base of the fire.
3. Squeeze the lever slowly and evenly.
4. Sweep the nozzle from side-to-side.

DX,FIRE4 -19-22AUG13-1/1

TS227 —UN—15APR13

Avoid Static Electricity Risk When Refueling

The removal of sulfur and other compounds in Ultra-Low Sulfur Diesel (ULSD) fuel decreases its conductivity and increases its ability to store a static charge.

Refineries may have treated the fuel with a static dissipating additive. However, there are many factors that can reduce the effectiveness of the additive over time.

Static charges can build up in ULSD fuel while it is flowing through fuel delivery systems. Static electricity discharge when combustible vapors are present could result in a fire or explosion.

Therefore, it is important to ensure that the entire system used to refuel your machine (fuel supply tank, transfer pump, transfer hose, nozzle, and others) is properly grounded and bonded. Consult with your fuel or fuel system supplier to ensure that the delivery system is in compliance with fueling standards for proper grounding and bonding practices.

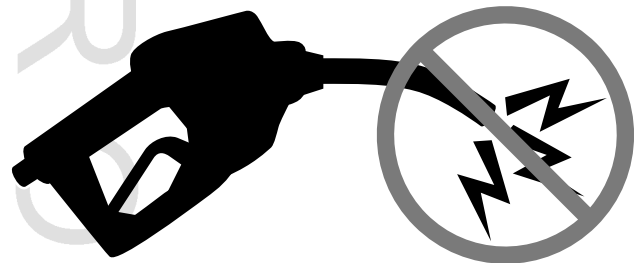

DX,FUEL,STATIC,ELEC -19-12JUL13-1/1

RG22142 —UN—21AUG13

RG21992 —UN—21AUG13

Keep ROPS Installed Properly

Make certain all parts are reinstalled correctly if the roll-over protective structure (ROPS) is loosened or removed for any reason. Tighten mounting bolts to proper torque.

The protection offered by ROPS will be impaired if ROPS is subjected to structural damage, is involved in an overturn incident, or is in any way altered by welding, bending, drilling, or cutting. A damaged ROPS should be replaced, not reused.

The seat is part of the ROPS safety zone. Replace only with John Deere seat approved for your tractor.

Any alteration of the ROPS must be approved by the manufacturer.

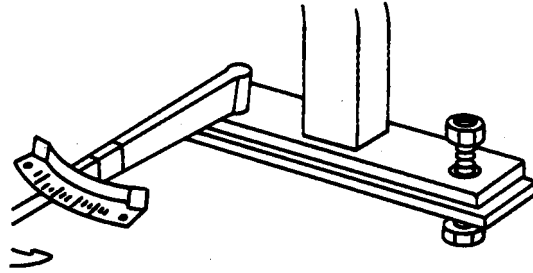

TS212—UN—23AUG88

DX,ROPS3 -19-12OCT11-1/1

Use Foldable ROPS and Seat Belt Properly

Avoid crushing injury or death during rollover.

- If this machine is equipped with a foldable rollover protective structure (ROPS), keep the ROPS in the fully extended and locked position. USE a seat belt when you operate with a ROPS in the fully extended position.
 - Hold the latch and pull the seat belt across the body.
 - Insert the latch into the buckle. Listen for a click.
 - Tug on the seat belt to make sure that the belt is securely fastened.
 - Snug the seat belt across the hips.
- If this machine is operated with the ROPS folded (for example, to enter a low building), drive with extreme caution. **DO NOT USE** a seat belt with the ROPS folded.
- Return the ROPS to the raised, fully extended position as soon as the machine is operated under normal conditions.

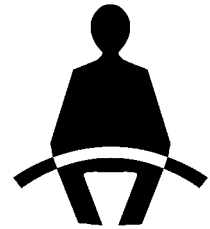

TS1729—UN—24MAY13

DX,FOLDROPS -19-22AUG13-1/1

P
R
O
O
F

Stay Clear of Rotating Drivelines

Entanglement in rotating driveline can cause serious injury or death.

Keep tractor master shield and driveline shields in place at all times. Make sure rotating shields turn freely.

Wear close fitting clothing. Stop the engine and be sure that PTO driveline is stopped before making adjustments, connections, or cleaning out PTO driven equipment.

Do not install any adapter device between the tractor and the primary implement PTO drive shaft that will allow a 1000 rpm tractor shaft to power a 540 rpm implement at speeds higher than 540 rpm.

Do not install any adapter device that results in a portion of the rotating implement shaft, tractor shaft, or the adapter to be unguarded. The tractor master shield shall overlap the end of the splined shaft and the added adaptor device as outlined in the table.

PTO Type	Diameter	Splines	$n \pm 5 \text{ mm (0.20 in.)}$
1	35 mm (1.378 in.)	6	85 mm (3.35 in.)
2	35 mm (1.378 in.)	21	85 mm (3.35 in.)
3	45 mm (1.772 in.)	20	100 mm (4.00 in.)

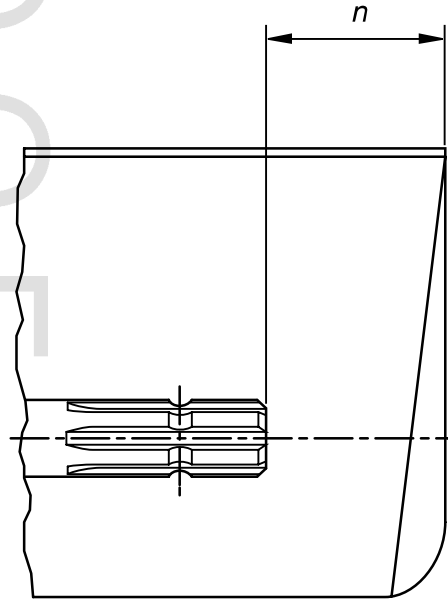

TS1644 —UN—22AUG95

H96219 —UN—29APR10

DX,PTO -19-30JUN10-1/1

Use Steps and Handholds Correctly

Prevent falls by facing the machine when getting on and off. Maintain 3-point contact with steps, handholds, and handrails.

Use extra care when mud, snow, or moisture present slippery conditions. Keep steps clean and free of grease or oil. Never jump when exiting machine. Never mount or dismount a moving machine.

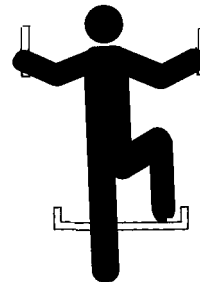

T133468 —UN—15APR13

DX,WW,MOUNT -19-12OCT11-1/1

Read Operator Manuals for ISOBUS Implements

In addition to GreenStar Applications, this display can be used as a display device for any implement that meets ISO 11783 standard. This includes capability to control ISOBUS implements. When used in this manner, information and implement control functions placed on the display are provided by the implement and are the

responsibility of the implement manufacturer. Some of these implement functions could provide a hazard either to the Operator or a bystander. Read the operator manual provided by the implement manufacturer and observe all safety messages in manual and on implement prior to use.

NOTE: ISOBUS refers to the ISO Standard 11783

DX,WW,ISOBUS -19-19AUG09-1/1

Use Seat Belt Properly

Avoid crushing injury or death during rollover.

This machine is equipped with a rollover protective structure (ROPS). **USE** a seat belt when you operate with a ROPS.

- Hold the latch and pull the seat belt across the body.
- Insert the latch into the buckle. Listen for a click.
- Tug on the seat belt latch to make sure that the belt is securely fastened.
- Snug the seat belt across the hips.

Replace entire seat belt if mounting hardware, buckle, belt, or retractor show signs of damage.

Inspect seat belt and mounting hardware at least once a year. Look for signs of loose hardware or belt damage, such as cuts, fraying, extreme or unusual wear,

discoloration, or abrasion. Replace only with replacement parts approved for your machine. See your John Deere dealer.

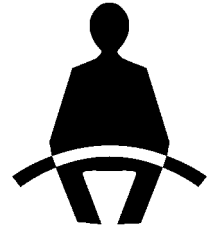

TS1729—JUN—24MAY13

DX,ROPS1 -19-22AUG13-1/1

PROOF

Operating the Tractor Safely

You can reduce the risk of accidents by following these simple precautions:

- Use your tractor only for jobs it was designed to perform, for example, pushing, pulling, towing, actuating, and carrying a variety of interchangeable equipment designed to conduct agricultural work.
- This tractor is not intended to be used as a recreational vehicle.
- Read this operator's manual before operating the tractor and follow operating and safety instructions in the manual and on the tractor.
- Follow operation and ballasting instructions found in the operator's manual for your implements/attachments, such as front loaders
- Make sure that everyone is clear of machine, attached equipment, and work area before starting engine or operation.
- Keep hands, feet, and clothing away from power-driven parts

Driving Concerns

- Never get on or off a moving tractor.
- Keep all children and nonessential personnel off tractors and all equipment.
- Never ride on a tractor unless seated on a John Deere approved seat with seat belt.
- Keep all shields/guards in place.
- Use appropriate visual and audible signals when operating on public roads.
- Move to side of road before stopping.
- Reduce speed when turning, applying individual brakes, or operating around hazards on rough ground or steep slopes.
- Couple brake pedals together for road travel.
- Pump brakes when stopping on slippery surfaces.

Towing Loads

- Be careful when towing and stopping heavy loads. Stopping distance increases with speed and weight of towed loads, and on slopes. Towed loads with or without brakes that are too heavy for the tractor or are towed too fast can cause loss of control.
- Consider the total weight of the equipment and its load.
- Hitch towed loads only to approved couplings to avoid rearward upset.

Parking and Leaving the Tractor

- Before dismounting, shut off SCVs, disengage PTO, stop engine, lower implements/attachments to ground

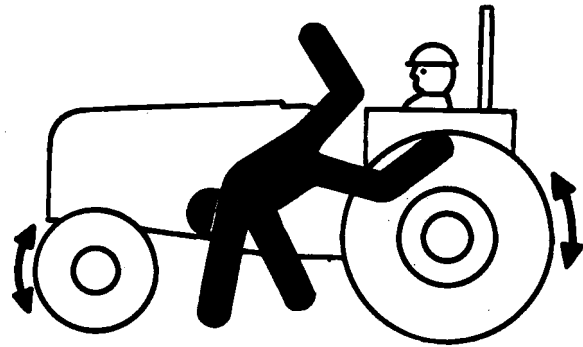

and securely engage park mechanism, including the park pawl and park brake. In addition, if tractor is left unattended, remove key.

- Leaving transmission in gear with engine off will NOT prevent the tractor from moving.
- Never go near an operating PTO or an operating implement.
- Wait for all movement to stop before servicing machinery.

Common Accidents

Unsafe operation or misuse of the tractor can result in accidents. Be alert to hazards of tractor operation.

The most common accidents involving tractors:

- Tractor rollover
- Collisions with motor vehicles
- Improper starting procedures
- Entanglement in PTO shafts
- Falling from tractor
- Crushing and pinching during hitching

DX,WW,TRACTOR -19-21AUG09-1/1

TS290—UN—23AUG88

TS276—UN—23AUG88

Avoid Backover Accidents

Before moving machine, be sure that all persons are clear of machine path. Turn around and look directly for best visibility. Use a signal person when backing if view is obstructed or when in close quarters.

Do not rely on a camera to determine if personnel or obstacles are behind the machine. The system can be limited by many factors including maintenance practices, environmental conditions, and operating range.



PC10857XW—UN—15APR13

DX,AVOID,BACKOVER,ACCIDENTS -19-30AUG10-1/1

Limited Use in Forestry Operation

The intended use of John Deere tractors when used in forestry operations is limited to tractor-specific applications like transport, stationary work such as log splitting, propulsion, or operating implements with PTO, hydraulic, or electrical systems.

These are applications where normal operation does not present a risk of falling or penetrating objects. Any forestry

applications beyond these applications, such as forwarding and loading, requires fitment of application-specific components including Falling Object Protective Structure (FOPS) and/or Operative Protective Structures (OPS). Contact John Deere dealer for special components.

DX,VW,FORESTRY -19-12OCT11-1/1

Operating the Loader Tractor Safely

When operating a machine with a loader application, reduce speed as required to ensure good tractor and loader stability.

To avoid tractor rollover and damage to front tires and tractor, do not carry load with your loader at a speed over 10 km/h (6 mph).

To avoid tractor damage do not use a front loader or a sprayer tank if the tractor is equipped with a 3 Meter Front Axle.

Never allow anyone to walk or work under a raised loader.

Do not use loader as a work platform.

Do not lift or carry anyone on loader, in bucket, or on implement or attachment.

Lower loader to ground before leaving operators station.

The Rollover Protective Structure (ROPS) or cab roof, if equipped, may not provide sufficient protection from load

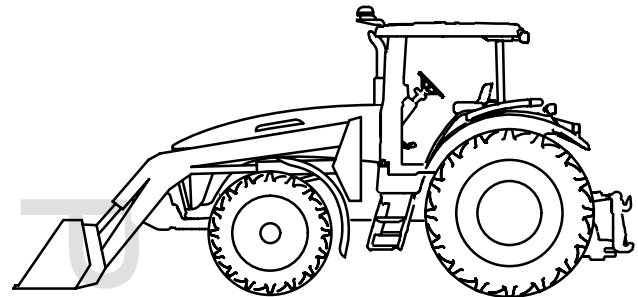

TS1692—UN—09NOV09

falling onto the operators station. To prevent loads from falling onto the operators station, always use appropriate implements for specific applications (that is, manure forks, round bale forks, round bale grippers, and clammers).

Ballast tractor in accordance to Ballast Recommendations in PREPARE TRACTOR section.

DX,VW,LOADER -19-18SEP12-1/1

Keep Riders Off Machine

Only allow the operator on the machine. Keep riders off.

Riders on machine are subject to injury such as being struck by foreign objects and being thrown off of the machine. Riders also obstruct the operator's view resulting in the machine being operated in an unsafe manner.

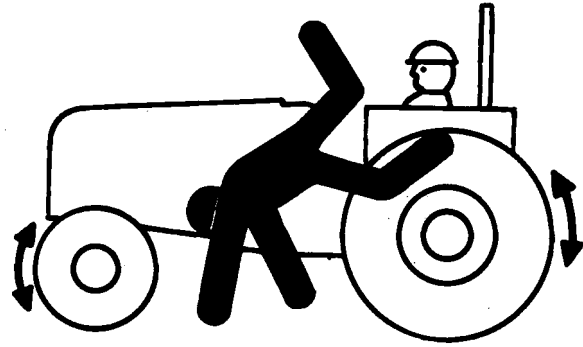

TS290 —UN—23AUG88

DX,RIDER -19-03MAR93-1/1

Instructional Seat

The instructional seat, if so equipped, has been provided only for training operators or diagnosing machine problems.

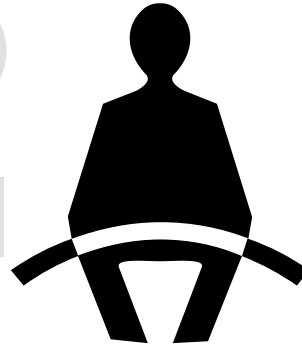

TS1730 —UN—24MAY13

DX,SEAT,NA -19-22AUG13-1/1

Use Safety Lights and Devices

Prevent collisions between other road users, slow moving tractors with attachments or towed equipment, and self-propelled machines on public roads. Frequently check for traffic from the rear, especially in turns, and use turn signal lights.

Use headlights, flashing warning lights, and turn signals day and night. Follow local regulations for equipment lighting and marking. Keep lighting and marking visible, clean, and in good working order. Replace or repair lighting and marking that has been damaged or lost. An implement safety lighting kit is available from your John Deere dealer.

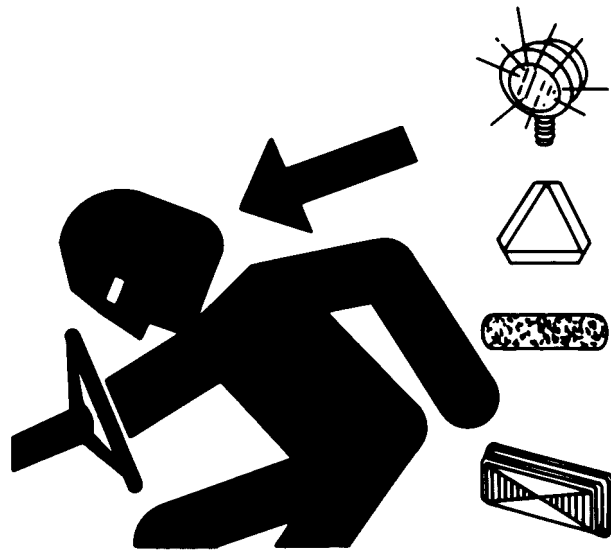

TS951 —UN—12APR90

DX,FLASH -19-07JUL99-1/1

Use a Safety Chain

A safety chain will help control drawn equipment should it accidentally separate from the drawbar.

Using the appropriate adapter parts, attach the chain to the tractor drawbar support or other specified anchor location. Provide only enough slack in the chain to permit turning.

See your John Deere dealer for a chain with a strength rating equal to or greater than the gross weight of the towed machine. Do not use safety chain for towing.

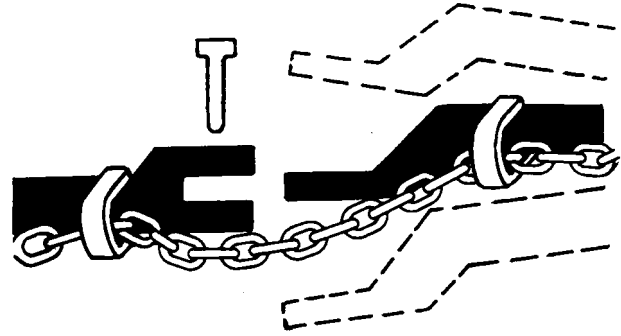

TS217—UN—23AUG88

DX,CHAIN -19-03MAR93-1/1

Transport Towed Equipment at Safe Speeds

Do not exceed the maximum transport speed. This tractor is capable of operating at transport speeds that exceed the maximum allowable transport speed for most towed implements.

Before transporting a towed implement, determine from signs on the implement or information provided in the implement's operator manual the maximum transport speed. Never transport at speeds that exceed the implement's maximum transport speed. Exceeding the implement's maximum transport speed can result in:

- Loss of control of the tractor/implement combination
- Reduced or no ability to stop during braking
- Implement tire failure
- Damage to the implement structure or its components

Implements without brakes:

- Do not transport at speeds greater than 32 km/h (20 mph).
- Must weigh less than 1.5 times the tractor weight and less than 1.5 t (3300 lb) when fully loaded.

Implements with brakes:

- If the manufacturer does not specify a maximum transport speed, do not tow at speeds greater than 40 km/h (25 mph).
- When transporting at speeds up to 40 km/h (25 mph) the fully loaded implement must weigh less than 4.5 times the tractor weight.

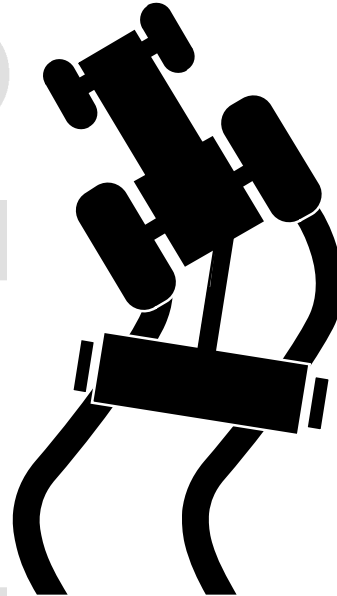

TS1686—UN—27SEP06

- When transporting at speeds between 40—50 km/h (25—31 mph) the fully loaded implement must weigh less than 3.0 times the tractor weight.

DX,TOW1 -19-12OCT11-1/1

Use Caution On Slopes and Uneven Terrain

Avoid holes, ditches, and obstructions which cause the tractor to tip, especially on slopes. Avoid sharp uphill turns.

Driving forward out of a ditch, mired condition, or up a steep slope could cause tractor to tip over rearward. Back out of these situations if possible.

Danger of overturn increases greatly with narrow tread setting, at high speed.

Not all conditions that can cause a tractor to overturn are listed. Be alert for any situation in which stability may be compromised.

Slopes are a major factor related to loss-of-control and tip-over accidents, which can result in severe injury or death. Operation on all slopes requires extra caution

Never drive near the edge of a gully, drop-off, ditch, steep embankment, or a body of water. The machine could suddenly roll over if a wheel goes over the edge or the ground caves in

Choose a low ground speed so you will not have to stop or shift while on a slope.

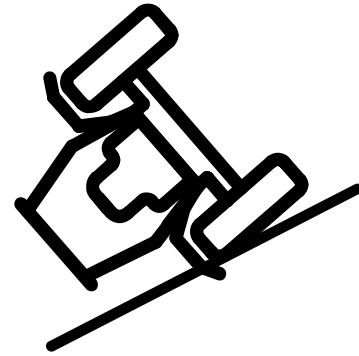

Avoid starting, stopping or turning on a slope. If the tires lose traction, disengage the PTO and proceed slowly, straight down the slope.

Keep all movement on slopes slow and gradual. Do not make sudden changes in speed or direction, which could cause the machine to roll over.

DX,WW,SLOPE -19-12OCT11-1/1

RXA0103437 —UN—01JUL09

Freeing a Mired Machine

Attempting to free a mired machine can involve safety hazards such as the mired tractor tipping rearward, the towing tractor overturning, and the tow chain or tow bar (a cable is not recommended) failing and recoiling from its stretched condition.

Back your tractor out if it gets mired down in mud. Unhitch any towed implements. Dig mud from behind the rear wheels. Place boards behind the wheels to provide a solid base and try to back out slowly. If necessary, dig mud from the front of all wheels and drive slowly ahead.

If necessary to tow with another unit, use a tow bar or a long chain (a cable is not recommended). Inspect the chain for flaws. Make sure all parts of towing devices are of adequate size and strong enough to handle the load.

Always hitch to the drawbar of the towing unit. Do not hitch to the front pushbar attachment point. Before moving, clear the area of people. Apply power smoothly to take up the slack: a sudden pull could snap any towing device causing it to whip or recoil dangerously.

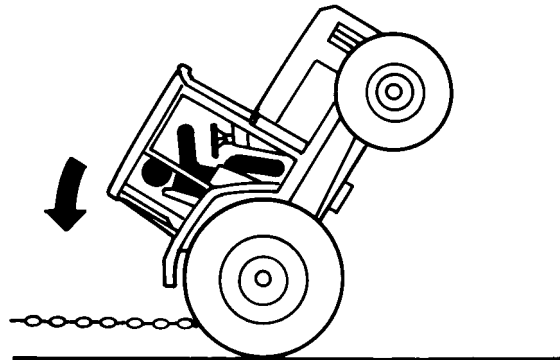

DX,MIREDD -19-07JUL99-1/1

TS1645 —UN—15SEP95

TS263 —UN—23AUG88

Avoid Contact with Agricultural Chemicals

This enclosed cab does not protect against inhaling vapor, aerosol or dust. If pesticide use instructions require respiratory protection, wear an appropriate respirator inside the cab.

Before leaving the cab, wear personal protective equipment as required by the pesticide use instructions. When re-entering the cab, remove protective equipment and store either outside the cab in a closed box or some other type of sealable container or inside the cab in a pesticide resistant container, such as a plastic bag.

Clean your shoes or boots to remove soil or other contaminated particles prior to entering the cab.

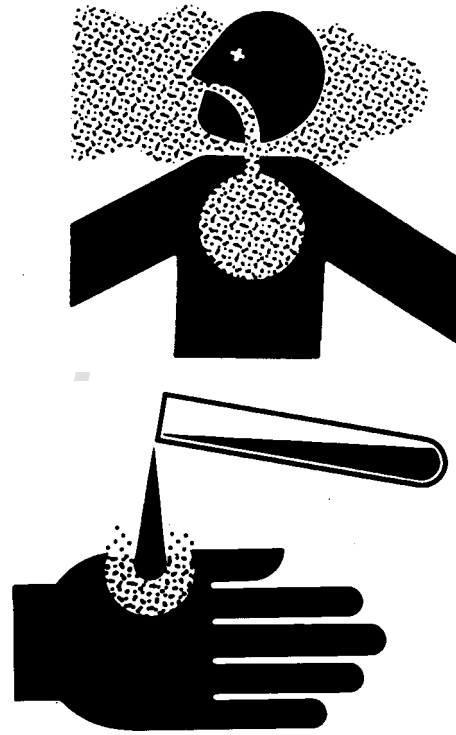

TS220 —UN—15APR13

TS272 —UN—23AUG88

DX,CABS -19-25MAR09-1/1

PROOF

Handle Agricultural Chemicals Safely

Chemicals used in agricultural applications such as fungicides, herbicides, insecticides, pesticides, rodenticides, and fertilizers can be harmful to your health or the environment if not used carefully.

Always follow all label directions for effective, safe, and legal use of agricultural chemicals.

Reduce risk of exposure and injury:

- Wear appropriate personal protective equipment as recommended by the manufacturer. In the absence of manufacturer's instructions, follow these general guidelines:
 - Chemicals labeled '**Danger**': Most toxic. Generally require use of goggles, respirator, gloves, and skin protection.
 - Chemicals labeled '**Warning**': Less toxic. Generally require use of goggles, gloves, and skin protections.
 - Chemicals labeled '**Caution**': Least toxic. Generally require use of gloves and skin protection.
- Avoid inhaling vapor, aerosol or dust.
- Always have soap, water, and towel available when working with chemicals. If chemical contacts skin, hands, or face, wash immediately with soap and water. If chemical gets into eyes, flush immediately with water.
- Wash hands and face after using chemicals and before eating, drinking, smoking, or urination.
- Do not smoke or eat while applying chemicals.
- After handling chemicals, always bathe or shower and change clothes. Wash clothing before wearing again.
- Seek medical attention immediately if illness occurs during or shortly after use of chemicals.
- Keep chemicals in original containers. Do not transfer chemicals to unmarked containers or to containers used for food or drink.

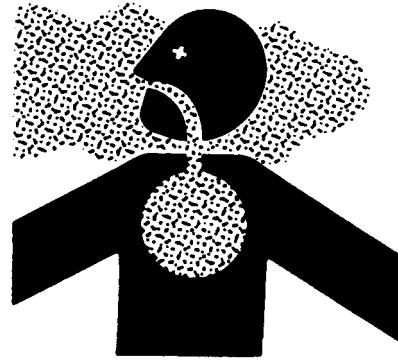

A34471

- Store chemicals in a secure, locked area away from human or livestock food. Keep children away.
- Always dispose of containers properly. Triple rinse empty containers and puncture or crush containers and dispose of properly.

DX,WW,CHEM01 -19-24AUG10-1/1

TS220—UN—15APR13

A34471—UN—11OCT88

P
R
O
O
F

Handling Batteries Safely

Battery gas can explode. Keep sparks and flames away from batteries. Use a flashlight to check battery electrolyte level.

Never check battery charge by placing a metal object across the posts. Use a voltmeter or hydrometer.

Always remove grounded (-) battery clamp first and replace grounded clamp last.

Sulfuric acid in battery electrolyte is poisonous and strong enough to burn skin, eat holes in clothing, and cause blindness if splashed into eyes.

Avoid hazards by:

- Filling batteries in a well-ventilated area
- Wearing eye protection and rubber gloves
- Avoiding use of air pressure to clean batteries
- Avoiding breathing fumes when electrolyte is added
- Avoiding spilling or dripping electrolyte
- Using correct battery booster or charger procedure.

If acid is spilled on skin or in eyes:

1. Flush skin with water.
2. Apply baking soda or lime to help neutralize the acid.
3. Flush eyes with water for 15—30 minutes. Get medical attention immediately.

If acid is swallowed:

1. Do not induce vomiting.
2. Drink large amounts of water or milk, but do not exceed 2 L (2 qt.).
3. Get medical attention immediately.

WARNING: Battery posts, terminals, and related accessories contain lead and lead compounds, chemicals known to the State of California to cause cancer and reproductive harm. **Wash hands after handling.**



TS204—UN—15APR13

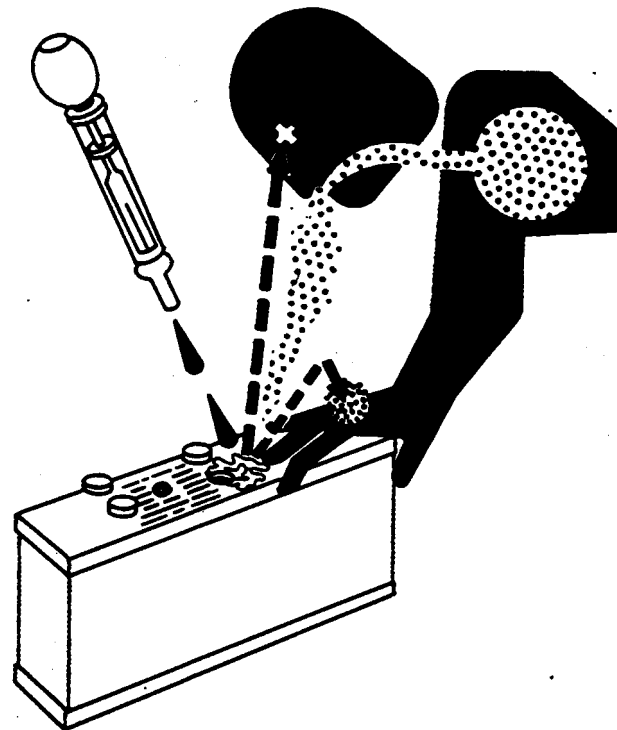

TS203—UN—23AUG88

DX,WW,BATTERIES -19-02DEC10-1/1

Avoid Heating Near Pressurized Fluid Lines

Flammable spray can be generated by heating near pressurized fluid lines, resulting in severe burns to yourself and bystanders. Do not heat by welding, soldering, or using a torch near pressurized fluid lines or other flammable materials. Pressurized lines can accidentally burst when heat goes beyond the immediate flame area.



TS953—UN—15MAY90

DX,TORCH -19-10DEC04-1/1

Remove Paint Before Welding or Heating

Avoid potentially toxic fumes and dust.

Hazardous fumes can be generated when paint is heated by welding, soldering, or using a torch.

Remove paint before heating:

- Remove paint a minimum of 100 mm (4 in.) from area to be affected by heating. If paint cannot be removed, wear an approved respirator before heating or welding.
- If you sand or grind paint, avoid breathing the dust. Wear an approved respirator.
- If you use solvent or paint stripper, remove stripper with soap and water before welding. Remove solvent or paint stripper containers and other flammable material from area. Allow fumes to disperse at least 15 minutes before welding or heating.

Do not use a chlorinated solvent in areas where welding will take place.

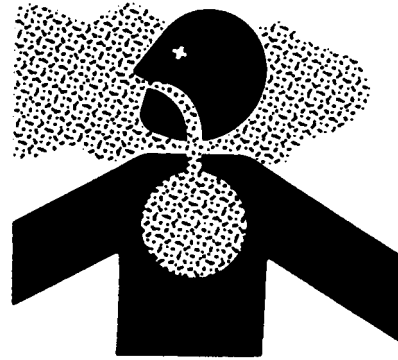

Do all work in an area that is well ventilated to carry toxic fumes and dust away.

Dispose of paint and solvent properly.

DX,PAINT -19-24JUL02-1/1

TS220 —UN—15APR13

Handle Electronic Components and Brackets Safely

Falling while installing or removing electronic components mounted on equipment can cause serious injury. Use a ladder or platform to easily reach each mounting location. Use sturdy and secure footholds and handholds. Do not install or remove components in wet or icy conditions.

If installing or servicing a RTK base station on a tower or other tall structure, use a certified climber.

If installing or servicing a global positioning receiver mast used on an implement, use proper lifting techniques and wear proper protective equipment. The mast is heavy and can be awkward to handle. Two people are required when mounting locations are not accessible from the ground or from a service platform.



DX,WW,RECEIVER -19-24AUG10-1/1

TS249 —UN—23AUG88

Practice Safe Maintenance

Understand service procedure before doing work. Keep area clean and dry.

Never lubricate, service, or adjust machine while it is moving. Keep hands, feet, and clothing from power-driven parts. Disengage all power and operate controls to relieve pressure. Lower equipment to the ground. Stop the engine. Remove the key. Allow machine to cool.

Securely support any machine elements that must be raised for service work.

Keep all parts in good condition and properly installed. Fix damage immediately. Replace worn or broken parts. Remove any buildup of grease, oil, or debris.

On self-propelled equipment, disconnect battery ground cable (-) before making adjustments on electrical systems or welding on machine.

On towed implements, disconnect wiring harnesses from tractor before servicing electrical system components or welding on machine.



T5218 —UN—23AUG88

DX,SERV -19-17FEB99-1/1

Avoid Hot Exhaust

Servicing machine or attachments with engine running can result in serious personal injury. Avoid exposure and skin contact with hot exhaust gases and components.

Exhaust parts and streams become very hot during operation. Exhaust gases and components reach temperatures hot enough to burn people, ignite, or melt common materials.

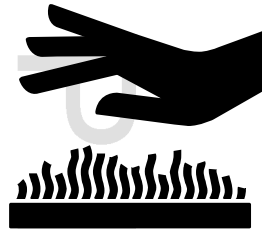

RG17488 —UN—21AUG09

DX,EXHAUST -19-20AUG09-1/1

Clean Exhaust Filter Safely

During exhaust filter cleaning operations, the engine may run at elevated idle and hot temperatures for an extended period of time. Exhaust gases and exhaust filter components reach temperatures hot enough to burn people, or ignite or melt common materials.

Keep machine away from people, animals, or structures which may be susceptible to harm or damage from hot exhaust gases or components. Avoid potential fire or explosion hazards from flammable materials and vapors near the exhaust. Keep exhaust outlet away from people and anything that can melt, burn, or explode.

Closely monitor machine and surrounding area for smoldering debris during and after exhaust filter cleaning.

Adding fuel while an engine is running can create a fire or explosion hazard. Always stop engine before refueling machine and clean up any spilled fuel.

Always make sure that engine is stopped while hauling machine on a truck or trailer.

Contact with exhaust components while still hot can result in serious personal injury.

Avoid contact with these components until cooled to safe temperatures.

If service procedure requires engine to be running:

- Only engage power-driven parts required by service procedure
- Ensure that other people are clear of operator station and machine

Keep hands, feet, and clothing away from power-driven parts.

Always disable movement (neutral), set the parking brake or mechanism and disconnect power to attachments or tools before leaving the operator's station.

Shut off engine and remove key (if equipped) before leaving the machine unattended.

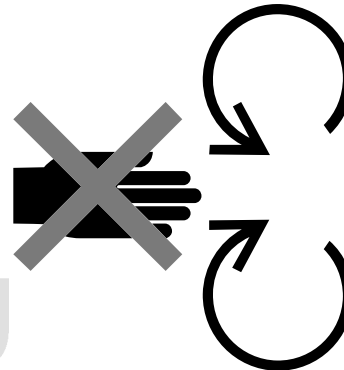
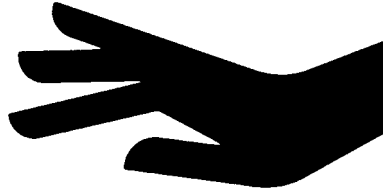

TS227 —UN—15APR13

TS271 —UN—23AUG88

TS1683 —UN—09DEC09

TS1685 —UN—07DEC09

DX,EXHAUST,FILTER -19-12JAN11-1/1

Work In Ventilated Area

Engine exhaust fumes can cause sickness or death. If it is necessary to run an engine in an enclosed area, remove the exhaust fumes from the area with an exhaust pipe extension.

If you do not have an exhaust pipe extension, open the doors and get outside air into the area.

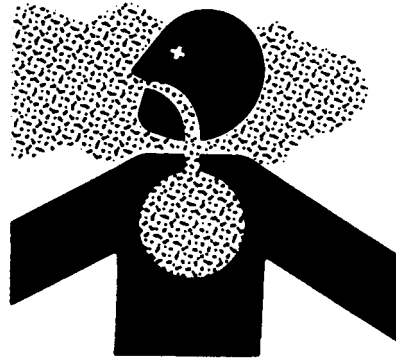

TS220 —UN—15APR13

DX,AIR -19-17FEB99-1/1

Support Machine Properly

Always lower the attachment or implement to the ground before you work on the machine. If the work requires that the machine or attachment be lifted, provide secure support for them. If left in a raised position, hydraulically supported devices can settle or leak down.

Do not support the machine on cinder blocks, hollow tiles, or props that may crumble under continuous load. Do not work under a machine that is supported solely by a jack. Follow recommended procedures in this manual.

When implements or attachments are used with a machine, always follow safety precautions listed in the implement or attachment operator's manual.

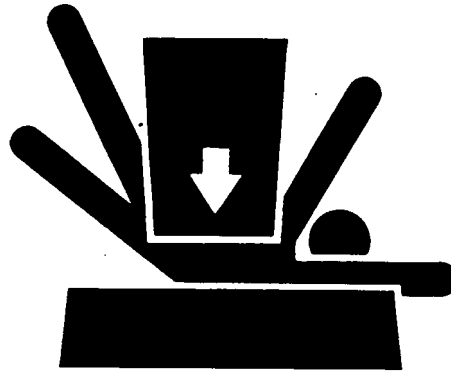

TS229 —UN—23AUG88

DX,LOWER -19-24FEB00-1/1

Prevent Machine Runaway

Avoid possible injury or death from machinery runaway.

Do not start engine by shorting across starter terminals. Machine will start in gear if normal circuitry is bypassed.

NEVER start engine while standing on ground. Start engine only from operator's seat, with transmission in neutral or park.



TS177 —UN—11JAN89

DX,BYPAS1 -19-29SEP98-1/1

Park Machine Safely

Before working on the machine:

- Lower all equipment to the ground.
- Stop the engine and remove the key.
- Disconnect the battery ground strap.
- Hang a "DO NOT OPERATE" tag in operator station.

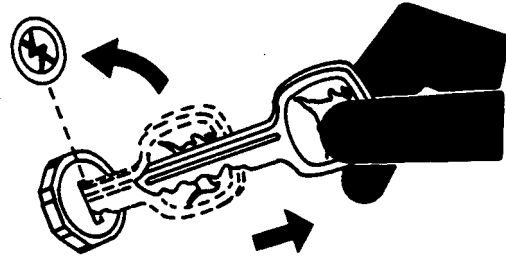

TS230 —UN—24MAY89

DX,PARK -19-04JUN90-1/1

Transport Tractor Safely

A disabled tractor is best transported on a flatbed carrier. Use chains to secure the tractor to the carrier. The axles and tractor frame are suitable attachment points.

Before transporting the tractor on a low-loader truck or flatbed rail wagon, make sure that the hood is secured over the tractor engine and that doors, roof hatch (if equipped) and windows are properly closed.

Never tow a tractor at a speed greater than 10 km/h (6 mph). An operator must steer and brake the tractor under tow.

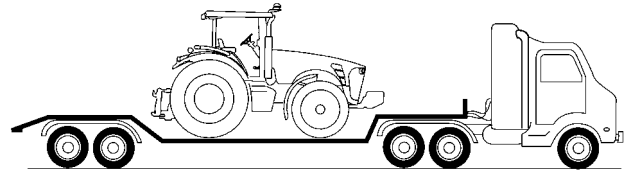

RXA0103709 —UN—01JUL09

DX,WW,TRANSPORT -19-19AUG09-1/1

Service Cooling System Safely

Explosive release of fluids from pressurized cooling system can cause serious burns.

Shut off engine. Only remove filler cap when cool enough to touch with bare hands. Slowly loosen cap to first stop to relieve pressure before removing completely.

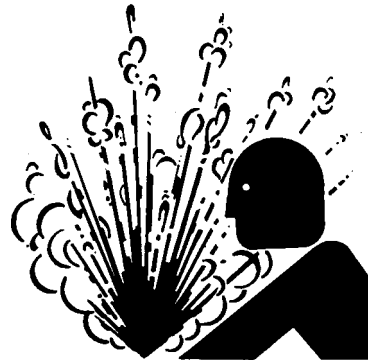

TS281 —UN—15APR13

DX,WW,COOLING -19-19AUG09-1/1

Service Accumulator Systems Safely

Escaping fluid or gas from systems with pressurized accumulators that are used in air conditioning, hydraulic, and air brake systems can cause serious injury. Extreme heat can cause the accumulator to burst, and pressurized lines can be accidentally cut. Do not weld or use a torch near a pressurized accumulator or pressurized line.

Relieve pressure from the pressurized system before removing accumulator.

Relieve pressure from the hydraulic system before removing accumulator. Never attempt to relieve hydraulic system or accumulator pressure by loosening a fitting.

Accumulators cannot be repaired.

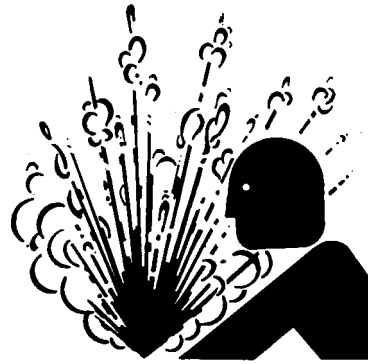

TS281 —UN—15APR13

DX,WW,ACCLA2 -19-22AUG03-1/1

Service Tires Safely

Explosive separation of a tire and rim parts can cause serious injury or death.

Do not attempt to mount a tire unless you have the proper equipment and experience to perform the job.

Always maintain the correct tire pressure. Do not inflate the tires above the recommended pressure. Never weld or heat a wheel and tire assembly. The heat can cause an increase in air pressure resulting in a tire explosion. Welding can structurally weaken or deform the wheel.

When inflating tires, use a clip-on chuck and extension hose long enough to allow you to stand to one side and NOT in front of or over the tire assembly. Use a safety cage if available.

Check wheels for low pressure, cuts, bubbles, damaged rims, or missing lug bolts and nuts.



RXA0103438 —UN—11JUN09

DX,WW,RIMS -19-19AUG09-1/1

Service Front-Wheel Drive Tractor Safely

When servicing front-wheel drive tractor with the rear wheels supported off the ground and rotating wheels by engine power, always support front wheels in a similar manner. Loss of electrical power or transmission hydraulic system pressure will engage the front driving wheels, pulling the rear wheels off the support if front wheels are not raised. Under these conditions, front drive wheels can engage even with switch in disengaged position.

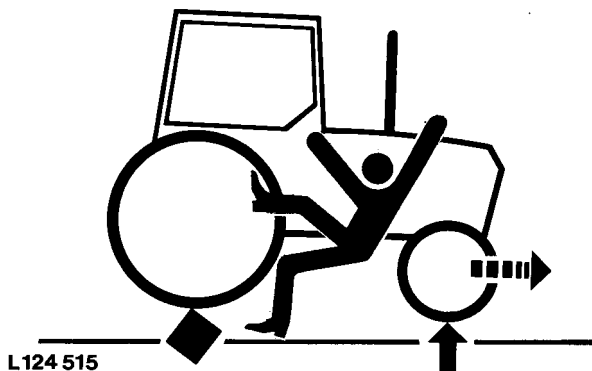

L124 515

L124515 —UN—06AUG94

DX,WW,MFWD -19-19AUG09-1/1

Tightening Wheel Retaining Bolts/Nuts

Torque wheel retaining bolts/nuts at the intervals specified in section Break-In Period and Service.

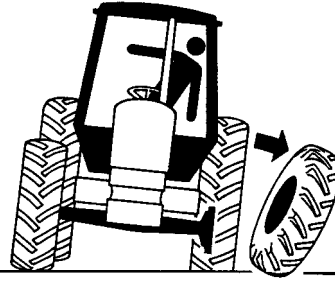

L124 516

DX,WWW,WHEEL -19-12OCT11-1/1

L124516—UN—03JAN95

Avoid High-Pressure Fluids

Inspect hydraulic hoses periodically – at least once per year – for leakage, kinking, cuts, cracks, abrasion, blisters, corrosion, exposed wire braid or any other signs of wear or damage.

Replace worn or damaged hose assemblies immediately with John Deere approved replacement parts.

Escaping fluid under pressure can penetrate the skin causing serious injury.

Avoid the hazard by relieving pressure before disconnecting hydraulic or other lines. Tighten all connections before applying pressure.

Search for leaks with a piece of cardboard. Protect hands and body from high-pressure fluids.

If an accident occurs, see a doctor immediately. Any fluid injected into the skin must be surgically removed within a few hours or gangrene may result. Doctors unfamiliar

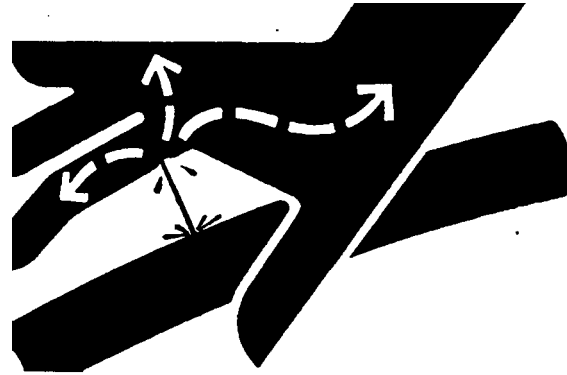

with this type of injury should reference a knowledgeable medical source. Such information is available in English from Deere & Company Medical Department in Moline, Illinois, U.S.A., by calling 1-800-822-8262 or +1 309-748-5636.

DX,FLUID -19-12OCT11-1/1

X9811—UN—23AUG88

Do Not Open High-Pressure Fuel System

High-pressure fluid remaining in fuel lines can cause serious injury. Do not disconnect or attempt repair of fuel lines, sensors, or any other components between the high-pressure fuel pump and nozzles on engines with High Pressure Common Rail (HPCR) fuel system.

Only technicians familiar with this type of system can perform repairs. (See your John Deere dealer.)

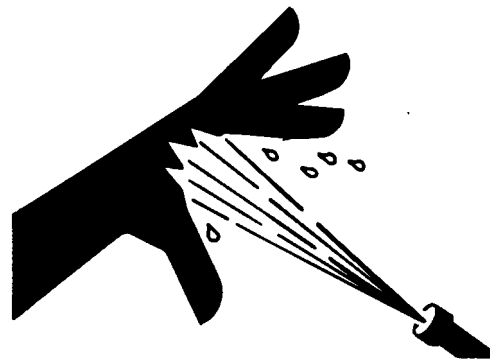

DX,WWW,HPCR1 -19-07JAN03-1/1

TS1343—UN—18MAR92

Store Attachments Safely

Stored attachments such as dual wheels, cage wheels, and loaders can fall and cause serious injury or death.

Securely store attachments and implements to prevent falling. Keep playing children and bystanders away from storage area.



TS219 —UN—23AUG88

DX,STORE -19-03MAR93-1/1

Dispose of Waste Properly

Improperly disposing of waste can threaten the environment and ecology. Potentially harmful waste used with John Deere equipment include such items as oil, fuel, coolant, brake fluid, filters, and batteries.

Use leakproof containers when draining fluids. Do not use food or beverage containers that may mislead someone into drinking from them.

Do not pour waste onto the ground, down a drain, or into any water source.

Air conditioning refrigerants escaping into the air can damage the Earth's atmosphere. Government regulations may require a certified air conditioning service center to recover and recycle used air conditioning refrigerants.

Inquire on the proper way to recycle or dispose of waste from your local environmental or recycling center, or from your John Deere dealer.

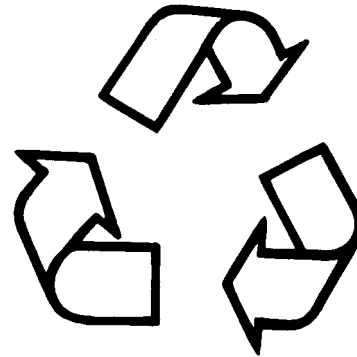

TS1133 —UN—15APR13

DX,DRAIN -19-03MAR93-1/1

PROOF

Safety Signs

Operator's Manual



Left Front Corner Post Label

RXA0131694 —JUN—09APR13

CAUTION

1. Read Operator's Manual before operating this tractor.
2. Keep all shields in place.
3. Hitch towed loads only to drawbar to avoid rearward upset.
4. Make certain everyone is clear of machine before starting engine or operation.
5. Keep all riders off tractor and equipment.
6. Keep hands, feet and clothing away from power-driven parts.
7. Reduce speed when turning or applying individual brakes or operating around hazards, on rough ground or steep slopes.
8. Couple brake pedals together for road travel. (wheel tractors only)
9. Use flashing warning lights on highway unless prohibited by law.
10. Stop engine, lower implement to ground and shift to "PARK" or set handbrake securely before dismounting.
11. Wait for all movement to stop before servicing machinery.
12. Remove key if leaving tractor unattended.

IMPORTANT

1. After starting engine, operate engine at approximately 1200 rpm (no load) for one to two minutes. If temperature is below freezing point, operate engine for two to four minutes (no load).
2. Start engine immediately if stalled while working to provide turbocharger lubrication.
3. Before stopping warm engine, idle several minutes under 100 rpm to cool turbocharger turbine.
4. After prolonged idle periods, see Operator's Manual for starting instructions.

1. Drive train and tire life can be extended by avoiding high loads at travel speeds below 4.0 mph (6.4 km/h).
2. Refer to Operators manual prior to towing tractor.

RXA0105481 —19—24MAY11

(A) — Operator's Manual Label

RW29387,0000689 -19-24JUN13-1/1

Seat Belt

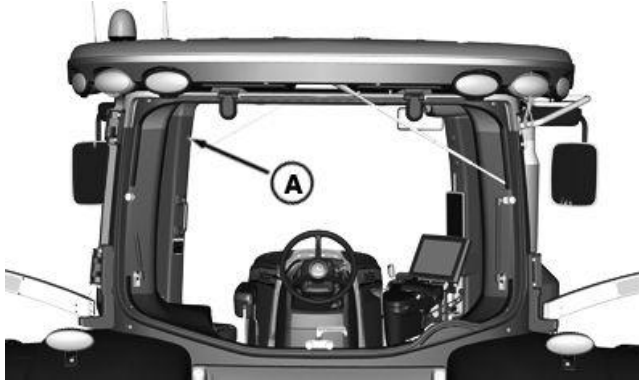

Left Front Corner Post Label

RXA0131693 —JUN—09APR13

⚠ WARNING

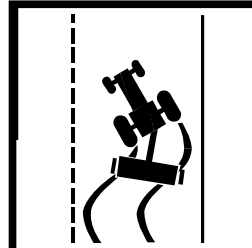

Avoid serious injury or death resulting from loss of control during transport or braking of a towed implement. This tractor is capable of operating at transport speeds that may exceed the maximum allowable transport speed for towed implements. If implement manufacturer does not specify maximum transport speed, observe these transport speed limits:

- Implements without brakes: 32 km/h (20 mph)
- Implements with brakes: 40 km/h (25 mph)

Do not exceed the implement's maximum transport speed.

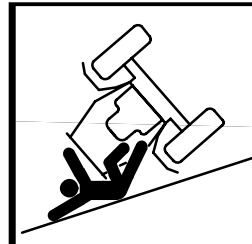

AVOID CRUSHING:

- Do not jump if machine tips.



USE SEAT BELT

- Pull belt fully from retractors and adjust for best protection.

To maintain unimpaired operator protection and manufacture's ROPS certification:

- Damaged ROPS structures must be replaced, not repaired or revised.
- Any alteration to the ROPS must be approved by the manufacturer.

(A) — Seat Belt Label

RXA0133083 —19—04JUN13

RW29387,000068A -19-07AUG13-1/1

Instructional Seat (If Equipped)

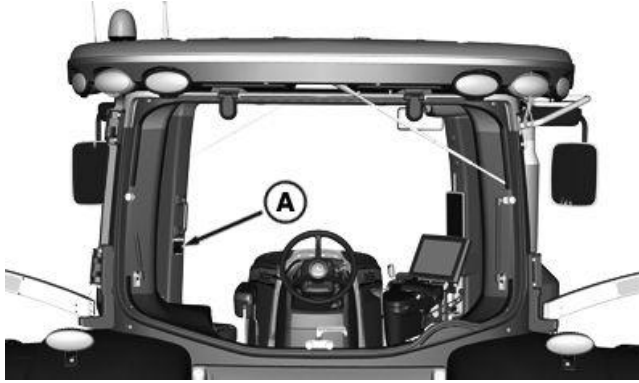

Left Corner Post Label

RXA0131694 —JUN—09APR13

A—Instructional Seat Label

Use the instructional seat for training operators or diagnosing machine problems. Always use the seat belt.

⚠ CAUTION

This instructional seat has been provided only for training operators or diagnosing machine problems.

Keep all other riders off the tractor and equipment.

Always wear your seat belt.

Instructional Seat Label

RXA0068061 —19—20APR11

RW29387,0000668 -19-28MAY13-1/1

Cab Suspension Accumulators (If Equipped)

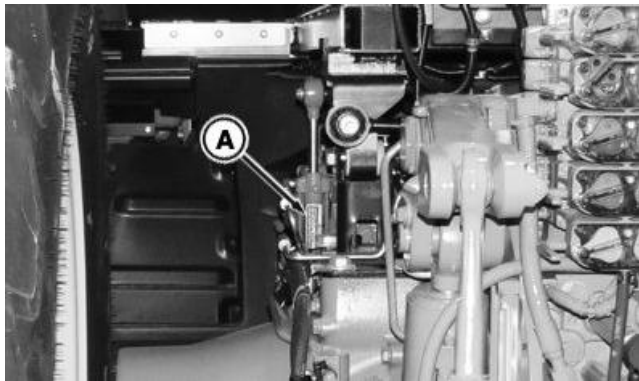

Cab Suspension Cylinder Label - Left Side

RXA0134885 —JUN—05AUG13

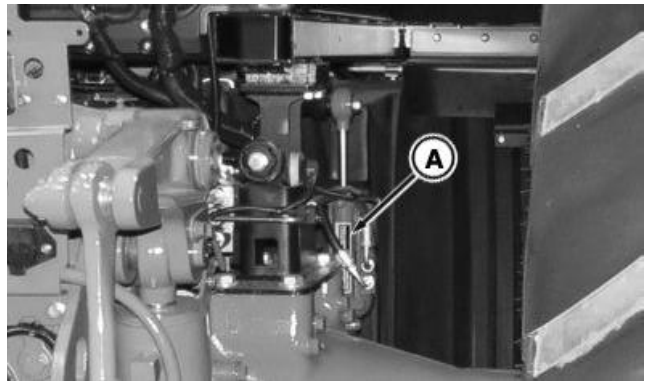

Cab Suspension Cylinder Label - Right Side

RXA0134886 —JUN—05AUG13

A— Cab Suspension Accumulator Label

RXA0106913 —19—12MAY10

⚠ CAUTION

Avoid injury from machine movement and exposure to fluid under pressure. See dealer for instruction on relieving pressure before servicing system.

Accumulator Label

TO84419,000004E -19-02AUG13-1/1

Starter

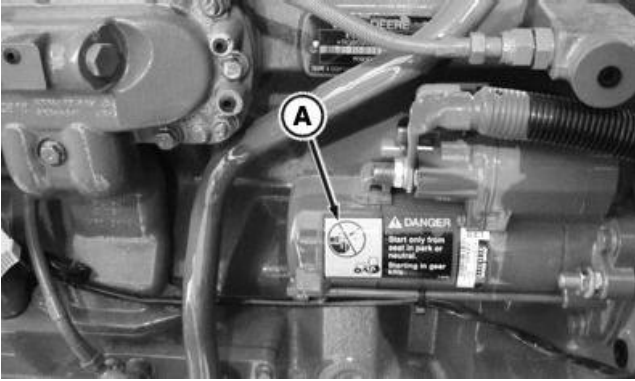

Engine Starter

A—Starter Label

RXA0134425 —UN—05AUG13



Start Engine Only From Seat Label

RXA0068077 —19—01JUL03

TO84419,000004F -19-02AUG13-1/1

Engine Block Heater (If Equipped)

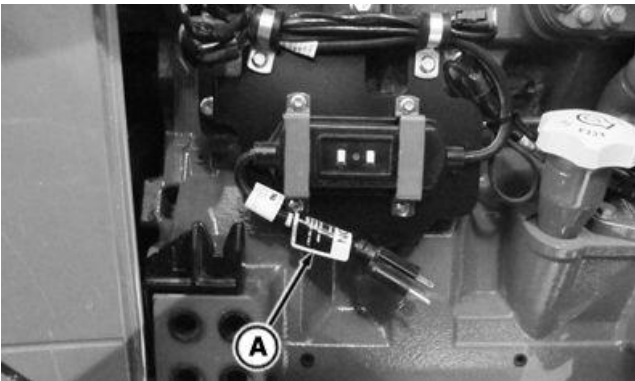

Left Side of Engine

A—Engine Heater Label

RXA0134426 —UN—05AUG13

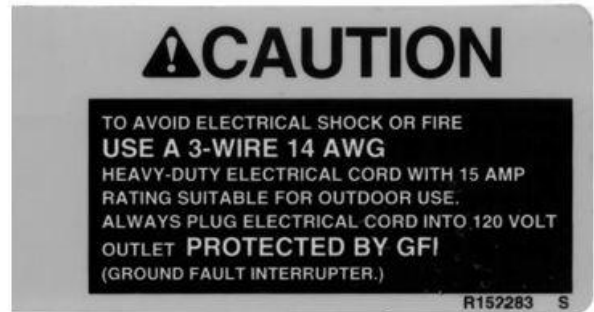

Use Proper Wiring Requirements Label

RXA0131967 —19—15APR13

TO84419,0000054 -19-02AUG13-1/1

Triple Link Suspension Plus (TLS™ Plus) (If Equipped)

RXA0106913 —19—12MAY10

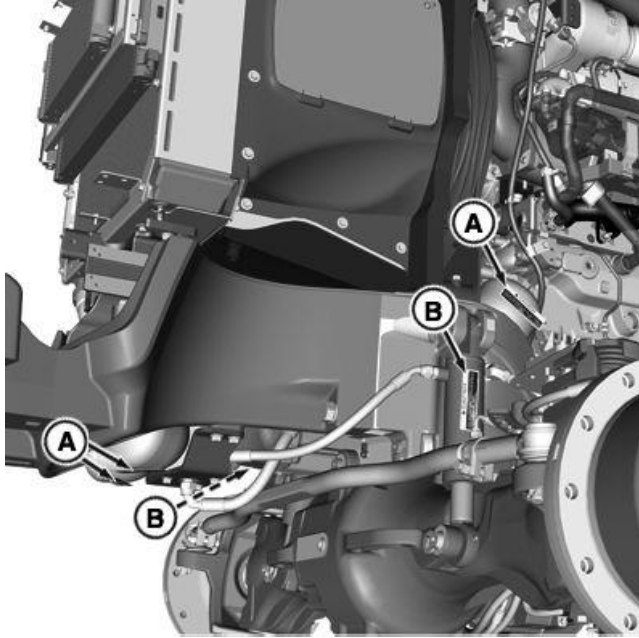

TLS™ Plus Front Axle

A—Accumulator Label

B—Cylinder Label

CAUTION

Avoid injury from machine movement and exposure to fluid under pressure. See dealer for instruction on relieving pressure before servicing system.

Caution Label

RXA0134898 —UN—06AUG13

T084419,000050 -19-09AUG13-1/1

Brake Valve Accumulator (If Equipped)



RXA0134944 —UN—28AUG13

Brake Accumulator Warning Label (Behind Right Front Panel Riser - Near Exhaust)

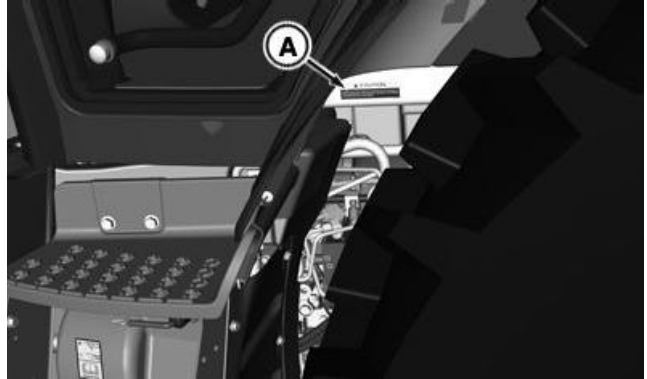

RXA0134945 —UN—07AUG13

Brake Accumulator Warning Label

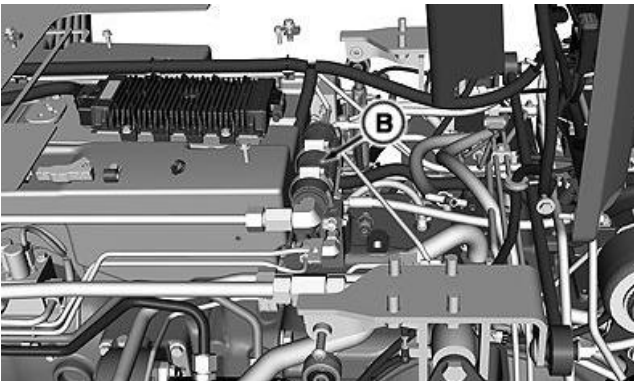

RXA0106913 —19—12MAY10

Brake Accumulator (Underneath Cab Behind Fuel Tank)



RXA0134985 —UN—07AUG13

Safety Label

A—Brake Valve Accumulator B—Brake Accumulator Label

TO84419,0000051 -19-07AUG13-1/1

Front PTO (If Equipped)



RXA0134429 —UN—05AUG13

Warning Label



RXA012684 —19—11FEB11

(A) — Front PTO Label

TO84419,0000055 -19-07AUG13-1/1

Quick Coupler (If Equipped)

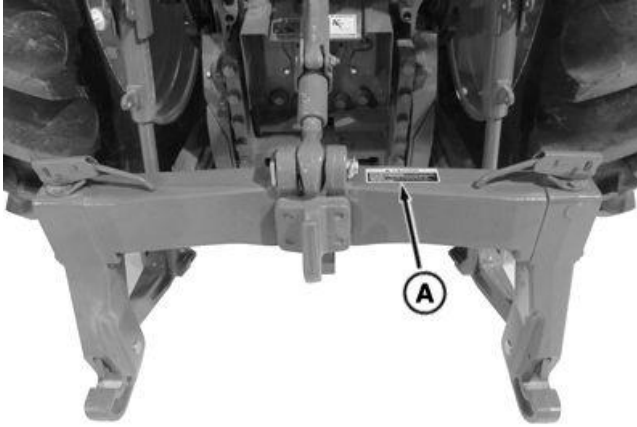

Quick Coupler

A—Quick Coupler Label

RXA0134194 —19—31JUL13



Quick Coupler Label

RXA0134877 —UN—05AUG13

PROOF

TO84419,0000052 -19-05AUG13-1/1

Rear PTO Shield (If Equipped)

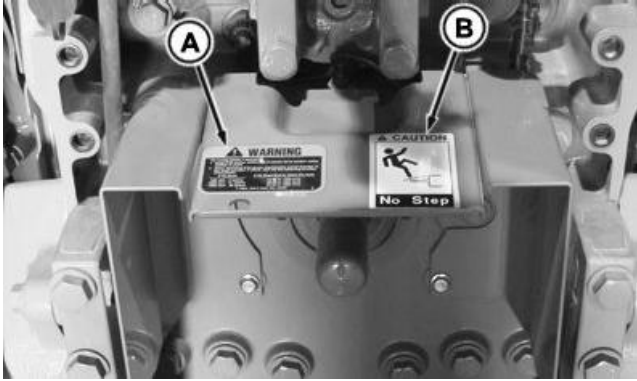

PTO Shield

RXA0134428 —UN—05AUG13



(B) — No Step Label

RXA0134430 —19—05AUG13



(A) — PTO Shaft rpm Label

RXA0116656 —19—08JUL11

T084419,0000053 -19-07AUG13-1/1

Controls and Instruments

Front Console

- A—Left-Hand Reverser (If Equipped)
- B—Light Selection Cluster
- C—Light Selector Knob
- D—Key Switch
- E—Accessories
- F—OFF
- G—Run
- H—Start
- I—Windshield Wiper Cluster
- J—Windshield Wiper Control Knob
- K—Steering Column Tilt Release Lever
- L—Brake Pedals
- M—Steering Wheel Tilt Release
- N—Clutch Pedal
- O—Turn Signal Icon, Road/Field Light Icon and Horn Icon
- P—Turn Signal Lever/Horn
- Q—Starting Aid Switch (If Equipped)
- R—Steering Wheel Telescope Release

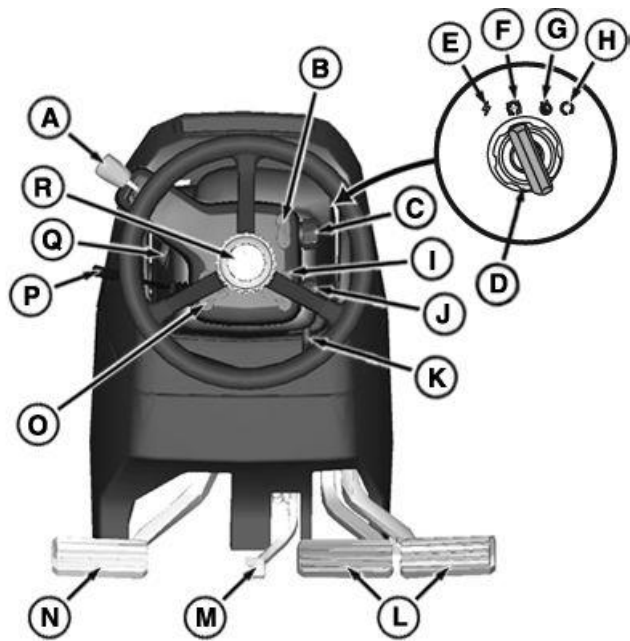

Front Console

RD47322,0000150 -19-07FEB13-1/1

RXA0126234 —UN—04JUN12

Information Indicators

NOTE: All STOP, Service Alert, and Information Indicators are accompanied by informative message, diagnostic trouble code, and/or fault description shown on CommandCenter™. For detailed description of indicators and codes associated with indicators, see STOP, Service Alert, and Information Indicators in Diagnostic Trouble Codes section of this Operator's Manual.

STOP Indicator (A): Light flashes and alarm sounds continuously.

IMPORTANT: Engine shuts down automatically if STOP signal is received when operator is out of seat for longer than three seconds and transmission control is in PARK. CommandCenter™ display can be reset by cycling key switch.

Service Alert Indicator (B): Light flashes and alarm sounds five times indicating performance or operational

CommandCenter is a trademark of Deere & Company

RXA0109847 —UN—20AUG10



Corner Post Display

- A—STOP Indicator
- B—Service Alert Indicator

C—Information Indicator

problem is detected that needs to be resolved as soon as possible.

Information (INFO) Indicator (C): Light illuminates continuously and alarm sounds for two seconds, indicating fault condition.

RD47322,0000152 -19-09JUL13-1/1

Aftertreatment Indicators Overview

The Diesel Exhaust Fluid (DEF) indicator illuminates when the DEF is low. Fill DEF tank.

When the DEF indicator is combined with the warning indicator or stop engine indicator engine performance is reduced by the Engine Control Unit (ECU) because the DEF is below a measurable level. Fill DEF tank.

When engine emissions temperature indicator illuminates exhaust gas temperature is high, elevated idle is active, or exhaust filter cleaning is in process. The machine can be operated as normal unless the operator determines the machine is not in a safe location for high exhaust temperatures and disables auto cleaning.

When engine emissions temperature indicator is combined with the warning indicator or stop engine indicator engine performance is reduced by the ECU because the exhaust gas temperature is higher than expected. Follow Diagnostic Trouble Code (DTC) procedure or see your authorized servicing dealer.

When the exhaust filter indicator illuminates the exhaust filter cleaning is in process, aftertreatment system has a fault, or the exhaust filter is in need of cleaning and the operator has disabled auto exhaust filter cleaning. If conditions are safe, the operator should enable the auto exhaust filter clean setting or perform manual service regeneration or follow DTC procedure.

When the exhaust filter indicator is combined with the warning indicator engine performance is reduced by the ECU because there is an aftertreatment system fault or the soot level of the exhaust filter is moderately high. If conditions are safe, the operator should enable the auto exhaust filter clean function. If conditions are not safe, the operator should move the machine to a safe location and engage the auto exhaust filter cleaning mode. Perform manual service regeneration or follow DTC procedure.

When the exhaust filter indicator is combined with the stop engine indicator engine performance is further reduced by the ECU because there is an aftertreatment system fault or the soot level of the exhaust filter is extremely high. If this combination is present, see your authorized servicing dealer.

The auto cleaning disabled indicator illuminates when the operator has engaged the request to disable the auto exhaust filter cleaning function. This icon remains illuminated until the operator reengages automatic exhaust filter cleaning from the diagnostic gauge. Disabling auto mode is not recommended for any situation unless it is safety related or if the fuel tank lacks the required fuel to complete the cleaning process.

RG22487 —UN—21AUG13



Diesel Exhaust Fluid Indicator

RG22488 —UN—21AUG13

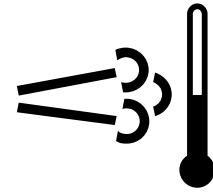

Engine Emissions Temperature Indicator

RG22489 —UN—21AUG13

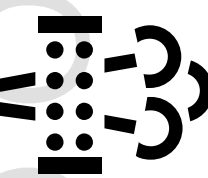

Exhaust Filter Indicator

RG22490 —UN—21AUG13

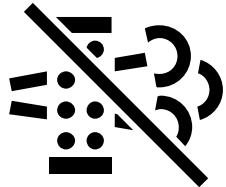

Auto Cleaning Disabled Indicator

RG22491 —UN—21AUG13

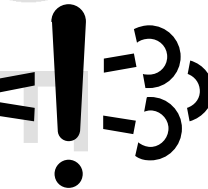

Engine Emissions System Malfunction Indicator

RG22492 —UN—21AUG13



Warning Indicator

RG22493 —UN—21AUG13

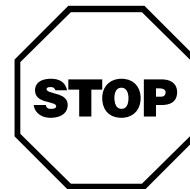

Stop Engine Indicator

The engine emissions system malfunction indicator illuminates when engine emissions are outside of normal operating range or engine emissions system fault. Follow DTC procedure or see your authorized servicing dealer

When the engine emissions system malfunction indicator is combined with the warning indicator engine performance is reduced by the ECU because the engine emissions are outside of normal operating range or engine emissions system fault. Follow DTC procedure or see your authorized servicing dealer

DX_AFTRTREAT,INDCATRS -19-12JUL13-1/1

Corner Post Display

- | | |
|---|---|
| 1— Stop Indicator | 16— AutoTrac™ Indicator |
| 2— Service Alert Indicator | 17— Diesel Exhaust Fluid (DEF) Gauge (FT4 Engines Only) |
| 3— Information Indicator | 18— Fuel Gauge |
| 4— FieldCruise™ Indicator | 19— Coolant Temperature Gauge |
| 5— FieldCruise™ Selection (1 or 2) | 20— iTEC™ Indicator |
| 6— Intelligent Power Management Indicator | 21— ISOBUS Auxiliary Mode Indicator |
| 7— Engine Preheat Indicator (For 6.8L Engines Only) | 22— Set Speed |
| 8— Exhaust Filter Cleaning Indicator | 23— Automatic Shifting Indicator |
| 9— Differential Lock Indicator (If Equipped) | 24— Current Gear/Range |
| 10— MFWD Indicator (If Equipped) | 25— Left Turn Indicator |
| 11— Right Turn Indicator | 26— High Beam Indicator |
| 12— Trailer Indicator (If Equipped) | 27— Rear PTO Indicator (If Equipped) |
| 13— Foot Pedal Mode Indicator (If Equipped) | 28— Front PTO Indicator (If Equipped) |
| 14— Transmission Range Indicators | 29— Vehicle Ground Speed |
| 15— IVT™ AutoPowr™ Forward Speed Band Indicator (If Equipped) | 30— Tachometer |

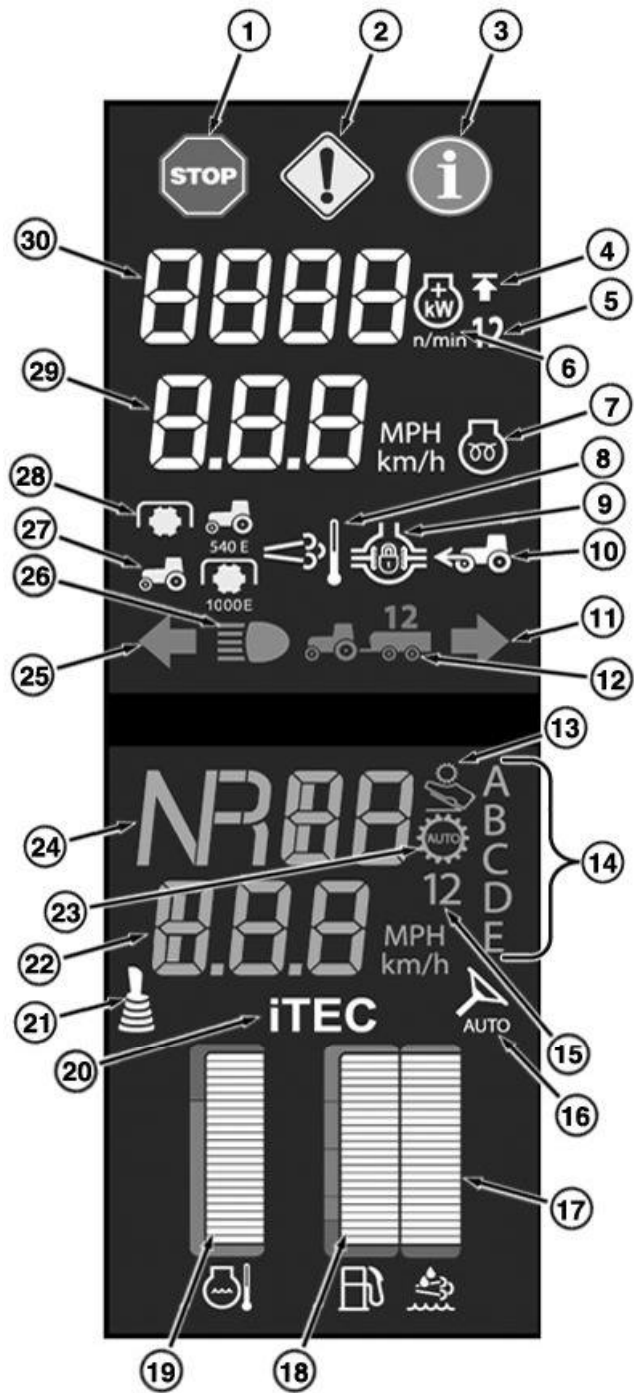

Corner Post Display

FieldCruise is a trademark of Deere & Company
 IVT is a trademark of Deere & Company
 AutoPowr is a trademark of Deere & Company
 AutoTrac is a trademark of Deere & Company
 iTEC is a trademark of Deere & Company

RXA0134350 —UN—30JUL13

RD47322,0000151 -19-13AUG13-1/1