



Test Report No.: RF2303WDG0149-3



# TEST REPORT



Applicant:	CORSAIR MEMORY, Inc.
Address:	115 North McCarthy Blvd, Milpitas, CA 95035, USA

Manufacturer or Supplier	CORSAIR MEMORY, Inc.
Address	115 North McCarthy Blvd, Milpitas, CA 95035, USA
Product:	Dongle
Brand Name:	CORSAIR
Model:	RGP0170
Additional Model & Model Difference	N/A
Date of tests:	Apr. 18, 2023 ~ May 05, 2023

the tests have been carried out according to the requirements of the following standard:

**FCC Part 15, Subpart C, Section 15.249**

**CONCLUSION: The submitted sample was found to COMPLY with the test requirement**

Tested by Niko Zhang Project Engineer / EMC Department	Approved by Glyn He Assistant Manager / EMC Department
	
	Date: Jul. 10, 2023

This report is governed by, and incorporates by reference, the Conditions of Testing as posted at the date of issuance of this report at <http://www.bureauveritas.com/home/about-us/our-business/cps/about-us/terms-conditions/> and is intended for your exclusive use. Any copying or replication of this report to or for any other person or entity, or use of our name or trademark, is permitted only with our prior written permission. This report sets forth our findings solely with respect to the test samples identified herein. The results set forth in this report are not indicative or representative of the quality or characteristics of the lot from which a test sample was taken or any similar or identical product unless specifically and expressly noted. Our report includes all of the tests requested by you and the results thereof based upon the information that you provided to us. Measurement uncertainty is only provided upon request for accredited tests. Statements of conformity are based on simple acceptance criteria without taking measurement uncertainty into account, unless otherwise requested in writing. You have 60 days from date of issuance of this report to notify us of any material error or omission caused by our negligence or if you require measurement uncertainty; provided, however, that such notice shall be in writing and shall specifically address the issue you wish to raise. A failure to raise such issue within the prescribed time shall constitute your unqualified acceptance of the completeness of this report, the tests conducted and the correctness of the report contents.

## TABLE OF CONTENTS

<b>RELEASE CONTROL RECORD .....</b>	<b>4</b>
<b>1 SUMMARY OF TEST RESULTS.....</b>	<b>5</b>
<b>2 MEASUREMENT UNCERTAINTY .....</b>	<b>5</b>
<b>3 GENERAL INFORMATION .....</b>	<b>6</b>
3.1 GENERAL DESCRIPTION OF EUT.....	6
3.2 DESCRIPTION OF TEST MODES.....	7
3.3 GENERAL DESCRIPTION OF APPLIED STANDARDS.....	10
3.4 DESCRIPTION OF SUPPORT UNITS.....	10
3.5 CONFIGURATION OF SYSTEM UNDER TEST.....	10
3.6 DUTY CYCLE OF TESET SIGNAL .....	11
<b>4. TEST TYPES AND RESULTS.....</b>	<b>12</b>
4.1 CONDUCTED EMISSION MEASUREMENT .....	12
4.1.1 LIMITS OF CONDUCTED EMISSION MEASUREMENT .....	12
4.1.2 TEST INSTRUMENTS.....	12
4.1.3 TEST PROCEDURES .....	13
4.1.4 DEVIATION FROM TEST STANDARD .....	13
4.1.5 TEST SETUP.....	14
4.1.6 EUT OPERATING CONDITIONS .....	14
4.1.7 TEST RESULTS .....	15
4.2 RADIATED EMISSION MEASUREMENT .....	17
4.2.1 LIMITS OF RADIATED EMISSION MEASUREMENT .....	17
4.2.2 TEST INSTRUMENTS.....	18
4.2.3 TEST PROCEDURES .....	19
4.2.4 DEVIATION FROM TEST STANDARD .....	19
4.2.5 TEST SETUP.....	20
4.2.6 EUT OPERATING CONDITIONS .....	21
4.2.7 TEST RESULTS .....	22
4.3 20DB BANDWIDTH MEASUREMENT.....	29
4.3.1 LIMITS OF 20DB BANDWIDTH MEASUREMENT.....	29
4.3.2 TEST INSTRUMENTS .....	29
4.3.3 TEST PROCEDURE .....	30



**BUREAU  
VERITAS**

**Test Report No.: RF2303WDG0149-3**

4.3.4	DEVIATION FROM TEST STANDARD .....	30
4.3.5	TEST SETUP .....	30
4.3.6	EUT OPERATING CONDITIONS.....	30
4.3.7	TEST RESULTS .....	31
<b>5.</b>	<b>PHOTOGRAPHS OF THE TEST CONFIGURATION.....</b>	<b>33</b>
<b>6.</b>	<b>APPENDIX A - MODIFICATIONS RECORDERS FOR ENGINEERING CHANGES TO THE EUT BY THE LAB .....</b>	<b>34</b>



Test Report No.: RF2303WDG0149-3

## RELEASE CONTROL RECORD

ISSUE NO.	REASON FOR CHANGE	DATE ISSUED
RF2303WDG0149-3	Original release	Jul. 10, 2023

## 1 SUMMARY OF TEST RESULTS

The EUT has been tested according to the following specifications:

APPLIED STANDARD: FCC PART 15, SUBPART C (SECTION 15.249)			
STANDARD SECTION	TEST TYPE AND LIMIT	RESULT	REMARK
§15.203	Antenna Requirement	PASS	No antenna connector is used
§15.207 (a)	Conducted Emission	PASS	Compliant
§15.205	Restricted Band of Operation	PASS	Compliant
§15.209 §15.249(a)	Radiated Emission	PASS	Compliant
§15.215(c)	20dB Bandwidth Test	PASS	Compliant

## 2 MEASUREMENT UNCERTAINTY

Where relevant, the following measurement uncertainty levels have been estimated for tests performed on the EUT as specified in CISPR 16-4-2:

MEASUREMENT	FREQUENCY	UNCERTAINTY
Conducted emissions	9KHz ~ 30MHz	2.70dB
Radiated emissions	30MHz ~ 1GMHz	3.60dB
	1GHz ~ 18GHz	4.82dB
	18GHz ~ 40GHz	5.00dB
20dB Bandwidth	1GHz ~ 18GHz	1.132x10 <sup>-4</sup> %

This uncertainty represents an expanded uncertainty expressed at approximately the 95% confidence level using a coverage factor of k = 2.

### 3 GENERAL INFORMATION

#### 3.1 GENERAL DESCRIPTION OF EUT

<b>PRODUCT</b>	Dongle
<b>MODEL NO.</b>	RGP0170
<b>ADDITIONAL MODEL</b>	N/A
<b>FCC ID</b>	2AAFMRGP0170
<b>NOMINAL VOLTAGE</b>	DC 5V From USB Host Unit
<b>MODULATION TECHNOLOGY</b>	GFSK
<b>OPERATING FREQUENCY</b>	2403-2477MHz
<b>ANTENNA TYPE</b>	PCB Antenna, -3.1dBi Gain
<b>I/O PORTS</b>	Refer to user's manual
<b>CABLE SUPPLIED</b>	N/A

**NOTES:**

1. For a more detailed features description, please refer to the manufacturer's specifications or the user's manual.
2. For the test results, the EUT had been tested with all conditions, but only the worst case was shown in test report.
3. Please refer to the EUT photo document (Reference No.: 2303WDG0149-2) for detailed product photo.

### 3.2 DESCRIPTION OF TEST MODES

Pre-Scan has been conducted to determine the worst-case mode from all possible combinations between available modulations, data rates, XYZ axis and packet type. The worst case was found when the EUT was positioned on X axis for radiated emission. The EUT was tested under the following mode.

EUT CONFIGURE MODE	APPLICABLE TO				DESCRIPTION
	RE<1G	RE≥1G	PLC	BW	
A	√	√	√	√	DC 5V from notebook

Where **RE<1G**: Radiated Emission below 1GHz      **RE≥1G**: Radiated Emission above 1GHz  
**PLC**: Power Line Conducted Emission      **BW**: 20db bandwidth

Following channel(s) was (were) selected for the test as listed below.

TESTED CHANNEL	TESTED FREQUENCY
Low	2403 MHz
Middle	2441 MHz
High	2477 MHz

Channel List

CHANNEL	FREQ. (MHZ)	CHANNEL	FREQ. (MHZ)	CHANNEL	FREQ. (MHZ)	CHANNEL	FREQ. (MHZ)
1	2403	11	2423	21	2443	31	2463
2	2405	12	2425	22	2445	32	2465
3	2407	13	2427	23	2447	33	2467
4	2409	14	2429	24	2449	34	2469
5	2411	15	2431	25	2451	35	2471
6	2413	16	2433	26	2453	36	2473
7	2415	17	2435	27	2455	37	2475
8	2417	18	2437	28	2457	<b>38</b>	<b>2477</b>
9	2419	19	2439	29	2459		
10	2421	<b>20</b>	<b>2441</b>	30	2461		

Note: The more detailed channel, please refer to the product specifications

**TEST CONDITION:**

APPLICABLE TO	ENVIRONMENTAL CONDITIONS	INPUT POWER	TESTED BY
RE	25deg. C, 55%RH	DC 5V from notebook	Stalker
BW	25deg. C, 56%RH	DC 5V from notebook	Vincent
PLC	25deg. C, 57%RH	DC 5V from notebook	Summer

**POWER LINE CONDUCTED EMISSION TEST:**

- Pre-Scan has been conducted to determine the worst-case mode from all possible combinations between available modulations, antenna ports (if EUT with antenna diversity architecture), and packet types.
- Following channel(s) was (were) selected for the final test as listed below.

EUT CONFIGURE MODE	TESTED CONDITION
A	2.4G SRD Link

**RADIATED EMISSION TEST (BELOW 1GHz):**

- Pre-Scan has been conducted to determine the worst-case mode from all possible combinations between available modulations, data rates, XYZ axis and antenna ports (if EUT with antenna diversity architecture).
- Following channel(s) was (were) selected for the final test as listed below.

EUT CONFIGURE MODE	AVAILABLE CHANNEL	TESTED CHANNEL	MODULATION TECHNOLOGY	MODULATION TYPE	DATA RATE (Mbps)
A	0 to 38	38	DSS	GFSK	1

For the test results, only the worst case was shown in test report.



**RADIATED EMISSION TEST (ABOVE 1GHz):**

- Pre-Scan has been conducted to determine the worst-case mode from all possible combinations between available modulations, data rates, XYZ axis and antenna ports (if EUT with antenna diversity architecture).
- Following channel(s) was (were) selected for the final test as listed below.

EUT CONFIGURE MODE	AVAILABLE CHANNEL	TESTED CHANNEL	MODULATION TECHNOLOGY	MODULATION TYPE	DATA RATE (Mbps)
A	0 to 38	0,20, 38	DTS	GFSK	1

**ANTENNA PORT CONDUCTED MEASUREMENT:**

- This item includes all test value of each mode, but only includes spectrum plot of worst value of each mode.
- Pre-Scan has been conducted to determine the worst-case mode from all possible combinations between available modulations, antenna ports (if EUT with antenna diversity architecture), and packet types.
- Following channel(s) was (were) selected for the final test as listed below.

EUT CONFIGURE MODE	AVAILABLE CHANNEL	TESTED CHANNEL	MODULATION TECHNOLOGY	MODULATION TYPE	DATA RATE (Mbps)
A	0 to 38	0, 20, 38	DTS	GFSK	1

### 3.3 GENERAL DESCRIPTION OF APPLIED STANDARDS

The EUT is a RF Product. According to the specifications of the manufacturer, it must comply with the requirements of the following standards:

**FCC Part 15, Subpart C, Section 15.249**

**ANSI C63.10-2013**

All test items have been performed and recorded as per the above standards.

### 3.4 DESCRIPTION OF SUPPORT UNITS

The EUT has been tested as an independent unit together without any other necessary accessories or support units. The following support units or accessories were used to form a representative test configuration during the tests.

NO.	PRODUCT	BRAND	MODEL NO.	SERIAL NO.	FCC ID
1	Notebook	DELL	Latitude 5280	77K2GH2	N/A
2	Adapter	Apple	A2452	N/A	N/A

NO.	SIGNAL CABLE DESCRIPTION OF THE ABOVE SUPPORT UNITS
1	AC Line: Unshielded, Detachable 0.8m, DC Line: Unshielded, Detachable 1.8m
2	N/A

### 3.5 CONFIGURATION OF SYSTEM UNDER TEST

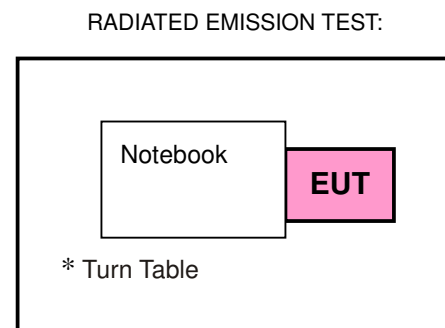
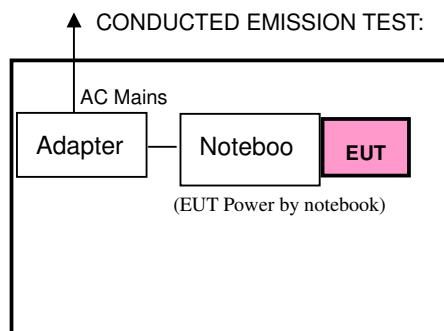

### 3.6 DUTY CYCLE OF TESET SIGNAL

Test Mode	On Time (ms)	Period (ms)	Duty Cycle (Linear)	Duty Cycle (%)	1/T Min. VBW (KHz)
GFSK	0.348	7.623	0.0457	4.57	3

Duty Cycle= On Time/ Period=0.348/7.623=0.0457

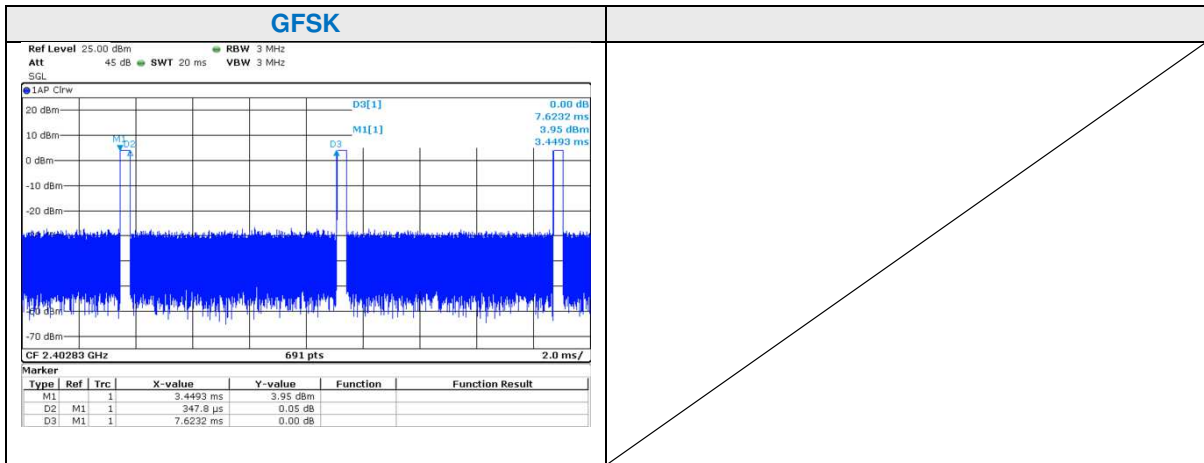

## 4. TEST TYPES AND RESULTS

### 4.1 CONDUCTED EMISSION MEASUREMENT

#### 4.1.1 LIMITS OF CONDUCTED EMISSION MEASUREMENT

FREQUENCY OF EMISSION (MHz)	CONDUCTED LIMIT (dB $\mu$ V)	
	Quasi-peak	Average
0.15 ~ 0.5	66 to 56	56 to 46
0.5 ~ 5	56	46
5 ~ 30	60	50

- NOTE:**
1. The lower limit shall apply at the transition frequencies.
  2. The limit decreases in line with the logarithm of the frequency in the range of 0.15 to 0.50MHz.
  3. All emanations from a class A/B digital device or system, including any network of conductors and apparatus connected thereto, shall not exceed the level of field strengths specified above.

#### 4.1.2 TEST INSTRUMENTS

Equipment	Manufacturer	Model No.	Serial No.	Last Cal.	Next Cal.
EMI Test Receiver	Rohde&Schwarz	ESR7	101494	Jan. 10,23	Jan. 10,24
Artificial Mains Network	Rohde&Schwarz	ENV216	101173	Jan. 11,23	Jan. 11,24
Artificial Mains Network	Rohde&Schwarz	ESH3-Z5	100317	Jan. 10,23	Jan. 10,24
Voltage probe	SCHWARZBECK	TK 9421	TK 9421-176	Jul. 27, 22	Jul. 27, 23
Coaxial RF Cable	SUHNER	RG 223/U-CE	C2310066 DG	Jul. 24, 22	Jul. 24, 23
Test software	ADT	ADT_Cond_V7.3.7	N/A	N/A	N/A

**NOTES:**

1. The test was performed in shielded room 553.
2. The calibration interval of the above test instruments is 12 months. And the calibrations are traceable to CEPREI/CHINA, GRGT/CHINA and NIM/CHINA.

#### 4.1.3 TEST PROCEDURES

- a. The EUT was placed 0.4 meters from the conducting wall of the shielded room with EUT being connected to the power mains through a line impedance stabilization network (LISN). Other support units were connected to the power mains through another LISN. The two LISNs provide 50 ohm/ 50uH of coupling impedance for the measuring instrument.
- b. Both lines of the power mains connected to the EUT were checked for maximum conducted interference.
- c. The frequency range from 150kHz to 30MHz was searched. Emission levels under (Limit - 20dB) was not recorded.

**NOTE:** All modes of operation were investigated and the worst-case emissions are reported.

#### 4.1.4 DEVIATION FROM TEST STANDARD

No deviation.

#### 4.1.5 TEST SETUP

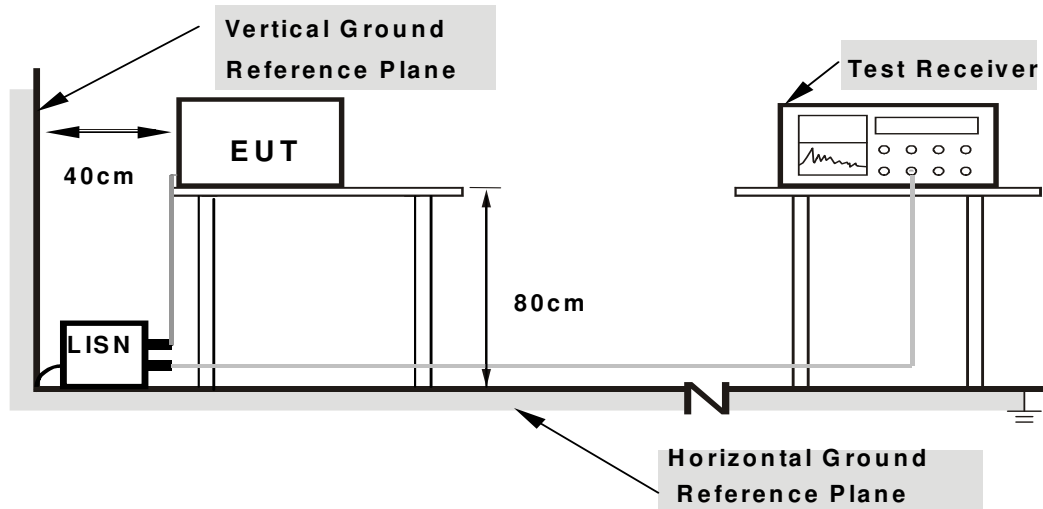

- Note:**
- 1.Support units were connected to second LISN.
  - 2.Both of LISNs (AMN) are 80 cm from EUT and at least 80 from other units and other metal planes

For the actual test configuration, please refer to the attached file (Test Setup Photo).

#### 4.1.6 EUT OPERATING CONDITIONS

- a) Turned on the power and connected of all equipment.
- b) EUT was operated according to the type used was description in manufacturer's specifications or the User's Manual.

### 4.1.7 TEST RESULTS

#### CONDUCTED WORST-CASE DATA: 2.4G SRD(GFSK) CH0

PHASE	Line	6dB BANDWIDTH	9kHz
-------	------	---------------	------

No	Freq. [MHz]	Corr. Factor (dB)	Reading Value [dB (uV)]		Emission Level [dB (uV)]		Limit [dB (uV)]		Margin (dB)	
			Q.P.	AV.	Q.P.	AV.	Q.P.	AV.	Q.P.	AV.
1	0.15000	9.92	36.13	14.76	46.05	24.68	66.00	56.00	-19.95	-31.32
2	0.19005	9.93	30.66	12.70	40.59	22.63	64.03	54.03	-23.45	-31.41
<b>3</b>	<b>0.41414</b>	<b>9.96</b>	<b>27.30</b>	<b>26.77</b>	<b>37.26</b>	<b>36.73</b>	<b>57.56</b>	<b>47.56</b>	<b>-20.30</b>	<b>-10.83</b>
4	2.53050	9.99	20.37	12.66	30.36	22.65	56.00	46.00	-25.64	-23.35
5	2.94225	10.01	17.58	8.78	27.59	18.79	56.00	46.00	-28.41	-27.21
6	5.12250	10.07	19.63	15.18	29.70	25.25	60.00	50.00	-30.30	-24.75

- REMARKS:**
1. Q.P. and AV. are abbreviations of quasi-peak and average individually.
  2. "-": The Quasi-peak reading value also meets average limit and measurement with the average detector is unnecessary.
  3. The emission levels of other frequencies were very low against the limit.
  4. Margin value = Emission level - Limit value
  5. Correction factor = Insertion loss + Cable loss
  6. Emission Level = Correction Factor + Reading Value.

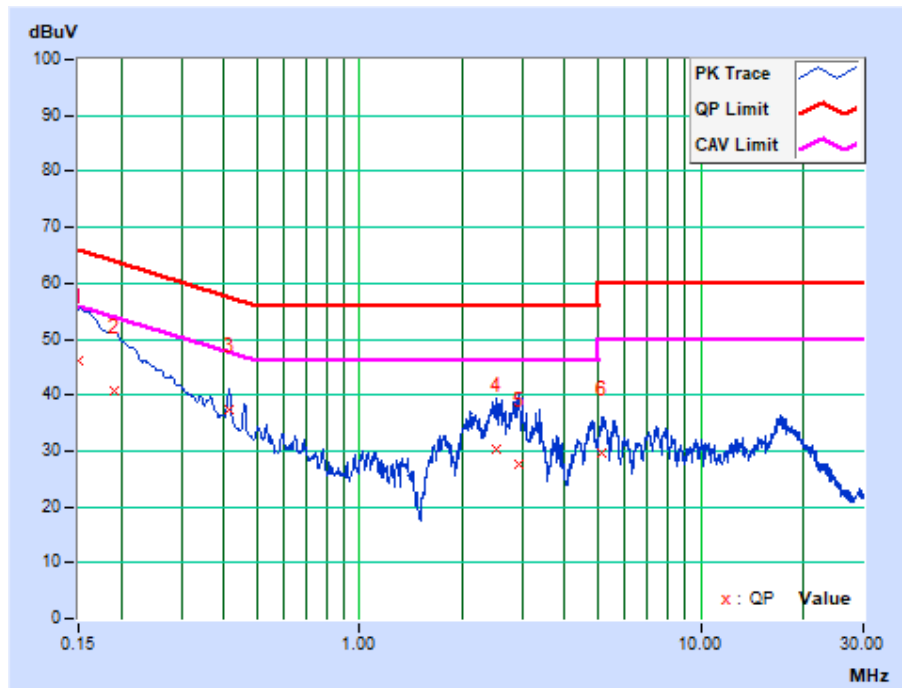

<b>PHASE</b>	Neutral	<b>6dB BANDWIDTH</b>	9kHz
--------------	---------	----------------------	------

No	Freq. [MHz]	Corr. Factor (dB)	Reading Value [dB (uV)]		Emission Level [dB (uV)]		Limit [dB (uV)]		Margin (dB)	
			Q.P.	AV.	Q.P.	AV.	Q.P.	AV.	Q.P.	AV.
1	0.15000	9.91	34.16	13.04	44.07	22.95	66.00	56.00	-21.93	-33.05
2	0.24167	9.94	25.00	15.30	34.94	25.24	62.04	52.04	-27.10	-26.80
3	0.41775	9.96	24.57	24.24	34.53	34.20	57.49	47.49	-22.97	-13.30
4	1.09500	9.96	15.35	12.39	25.31	22.35	56.00	46.00	-30.69	-23.65
5	3.00075	10.00	17.50	12.61	27.50	22.61	56.00	46.00	-28.50	-23.39
6	5.18775	10.08	15.06	8.84	25.14	18.92	60.00	50.00	-34.86	-31.08

- REMARKS:**
1. Q.P. and AV. are abbreviations of quasi-peak and average individually.
  2. "-": The Quasi-peak reading value also meets average limit and measurement with the average detector is unnecessary.
  3. The emission levels of other frequencies were very low against the limit.
  4. Margin value = Emission level - Limit value
  5. Correction factor = Insertion loss + Cable loss
  6. Emission Level = Correction Factor + Reading Value.

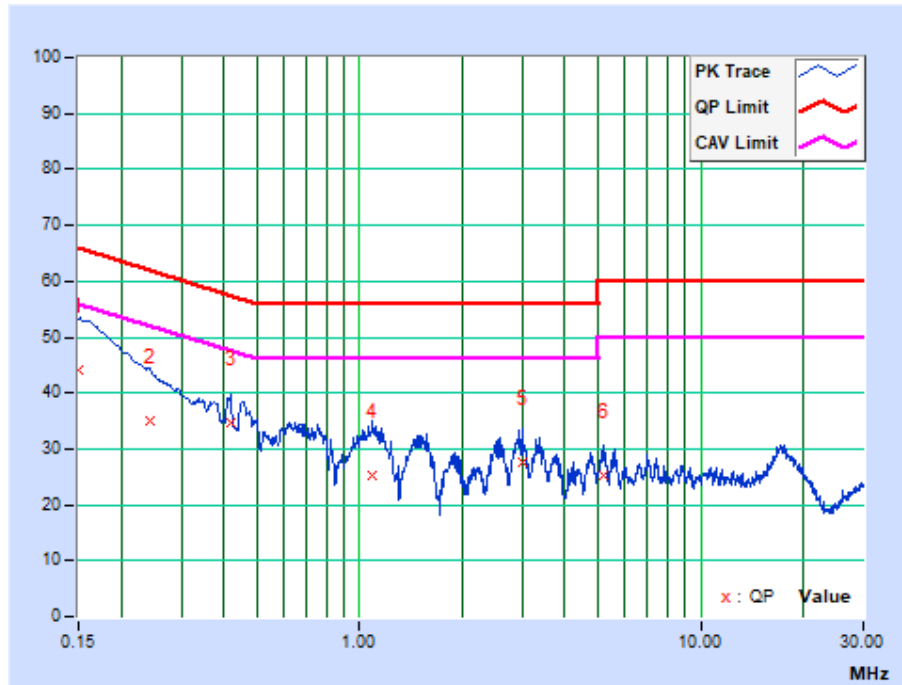



## 4.2 RADIATED EMISSION MEASUREMENT

### 4.2.1 LIMITS OF RADIATED EMISSION MEASUREMENT

Emissions radiated outside of the specified bands, shall be according to the general radiated limits in 15.209 as following:

FREQUENCIES (MHz)	FIELD STRENGTH (microvolts/meter)	MEASUREMENT DISTANCE (meters)
0.009 ~ 0.490	2400/F(kHz)	300
0.490 ~ 1.705	24000/F(kHz)	30
1.705 ~ 30.0	30	30
30 ~ 88	100	3
88 ~ 216	150	3
216 ~ 960	200	3
Above 960	500	3

According to §15.249(a), the field strength of emissions from intentional radiators operated within these frequency bands shall comply with the following:

Fundamental Frequency	Field strength of fundamental (milli-volts/meter)	Field strength of harmonics (micro-volts/meter)
902-928 MHz	50	500
2400-2483.5 MHz	50	500
5725-5875 MHz	50	500
24.0-24.25 GHz	250	2500

The emission limit in this paragraph is based on measurement instrumentation employing an average detector. The provisions in §15.35 for limiting peak emissions apply.

**NOTE:**

1. The lower limit shall apply at the transition frequencies.
2. Emission level (dBuV/m) = 20 log Emission level (uV/m).
3. As shown in 15.35(b), for frequencies above 1000MHz, the field strength limits are based on average detector, however, the peak field strength of any emission shall not exceed the maximum permitted average limits, specified above by more than 20dB under any condition of modulation.



**4.2.2 TEST INSTRUMENTS**

<b>Equipment</b>	<b>Manufacturer</b>	<b>Model No.</b>	<b>Serial No.</b>	<b>Next Cal.</b>
EMI Test Receiver	Rohde&Schwarz	ESU40	100449	Jan. 10, 24
Signal and Spectrum Analyzer	Rohde&Schwarz	FSV7	102331	Apr. 05, 24
Active Loop Antenna (9KHz -30MHz)	SCHWARZBECK	FMZB 1519B	1519B-045	Apr. 27, 24
Amplifier (9KHz -1GHz)	Burgeon	BPA-530	100210	Mar. 06, 24
Trilog-Broadband Antenna	SCHWARZBECK	VULB 9168	9168-554	Jan. 08, 24
Horn Antenna (1GHz -18GHz)	ETS -Lindgren	3117	00062558	Apr. 01, 24
Horn Antenna (18GHz -40GHz)	SCHWARZBECK	BBHA 9170	BBHA9170147	Apr. 01, 24
3m Semi-anechoic Chamber	ETS-LINDGREN	9m*6m*6m	NSEMC003	May 22, 24
Test Software	ADT	ADT_Radiated_V7.6.15.9.2	N/A	N/A
Broadband Preamplifier (1GHz~18GHz)	SCHWARZBECK	BBV9718	305	Apr. 24, 24
Pre-Amplifier (18GHz-40GHz)	EMCI	EMC 184045	980102	Jan. 16, 24
BLUETOOTH TESTER	Rohde&Schwarz	CBT32	100811	N/A

**NOTE:**

1. The test was performed in 966 Chamber.
2. The calibration interval of the above test instruments are 12 months and the calibrations are traceable to CEPREI/CHINA, GRGT/CHINA and NIM/CHINA.
3. The horn antenna is used only for the measurement of emission frequency above1GHz if tested.
4. The FCC Site Registration No. is 749762.

#### 4.2.3 TEST PROCEDURES

- a. The EUT was placed on the top of a rotating table 1.5 meters (above 1GHz) and 0.8 meters (below 1GHz) above the ground at a 3 meters semi-anechoic chamber. The table was rotated 360 degrees to determine the position of the highest radiation.
- b. The EUT was set 3 meters away from the interference-receiving antenna, which was mounted on the top of a variable-height antenna tower.
- c. The antenna is a broadband antenna, and its height is varied from one meter to four meters above the ground to determine the maximum value of the field strength. Both horizontal and vertical polarizations of the antenna are set to make the measurement.
- d. For each suspected emission, the EUT was arranged to its worst case and then the antenna was tuned to heights from 1 meter to 4 meters and the rotatable table was turned from 0 degrees to 360 degrees to find the maximum reading.
- e. The test-receiver system was set to Peak Detect Function and Specified Bandwidth with Maximum Hold Mode.
- f. For below 30MHz, a loop antenna with its vertical plane is place 3m from the EUT and rotated about its vertical axis for maximum response at each azimuth about the EUT. And the centre of the loop shall be 1.3m above the ground.
- g. If the emission level of the EUT in peak mode was lower than the limit specified, then testing could be stopped and the peak values of the EUT would be reported. Otherwise the emissions would be re-tested one by one using peak, quasi-peak or average method as specified and then reported in a data sheet.

#### **NOTE:**

1. The resolution bandwidth and video bandwidth of test receiver is 120kHz for Quasi-peak detection at frequency below 1GHz.
2. The resolution bandwidth of test receiver is 1MHz and video bandwidth is 3MHz for Peak detection at frequency above 1GHz.
3. The resolution bandwidth of spectrum analyzer is 1MHz and the video bandwidth is  $\geq 1/T$  (Duty cycle < 98%) for Average detection (AV) at frequency above 1GHz.
4. All modes of operation were investigated and the worst-case emissions are reported.
5. The testing of the EUT was performed on all 3 orthogonal axes; the worst-case test configuration was reported on the file test setup photo.

#### 4.2.4 DEVIATION FROM TEST STANDARD

No deviation.

## 4.2.5 TEST SETUP

### Below 30MHz test setup

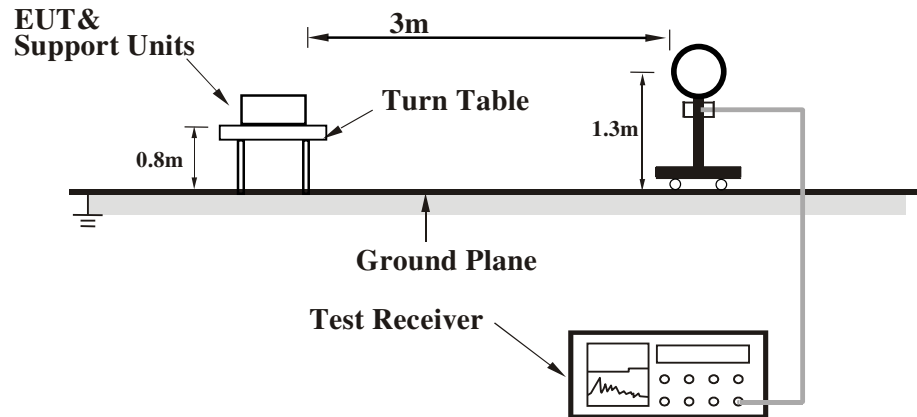

### Below 1GHz test setup

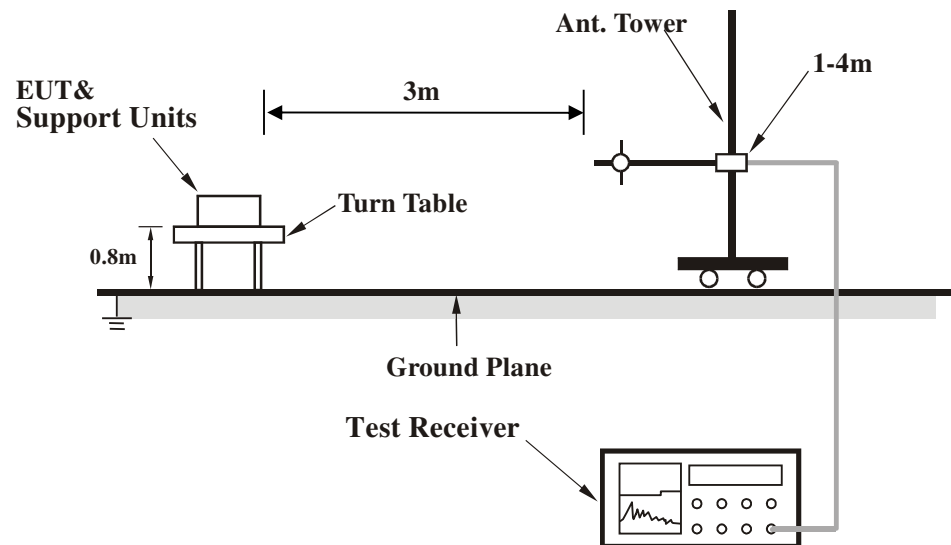

**Note:** For the actual test configuration, please refer to the attached file (Test Setup Photo).

### Above 1GHz test setup

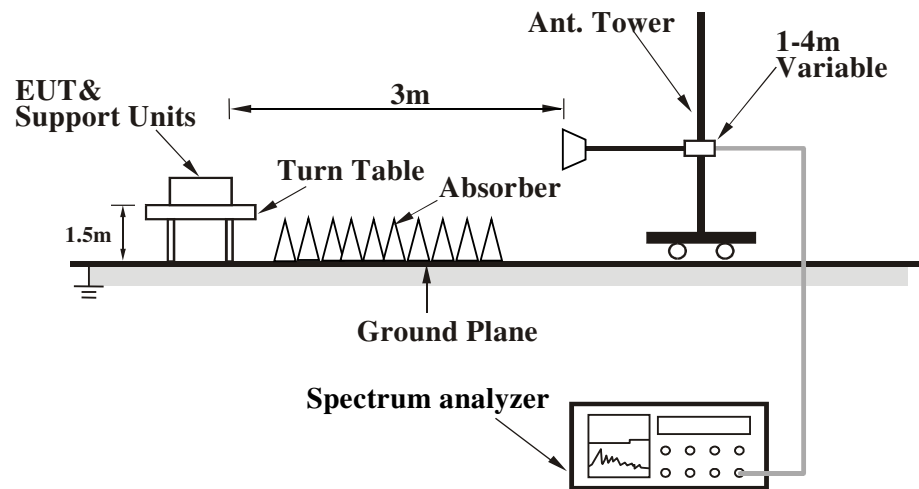

**Note:** For the actual test configuration, please refer to the attached file (Test Setup Photo).

#### 4.2.6 EUT OPERATING CONDITIONS

- c) Turned on the power of all equipment.
- d) EUT was operated according to the type used was description in manufacturer's specifications or the User's Manual.

#### 4.2.7 TEST RESULTS

##### BELOW 1GHz WORST-CASE DATA

<b>CHANNEL</b>	TX Middle Channel	<b>DETECTOR FUNCTION</b>	Quasi-Peak (QP)
<b>FREQUENCY RANGE</b>	9KHz ~ 1GHz		

ANTENNA POLARITY & TEST DISTANCE: HORIZONTAL AT 3 M								
NO.	FREQ. (MHz)	EMISSION LEVEL (dBuV/m)	LIMIT (dBuV/m)	MARGIN (dB)	ANTENNA HEIGHT (m)	TABLE ANGLE (Degree)	RAW VALUE (dBuV)	CORRECTION FACTOR (dB/m)
1	37.77	26.54	40.00	-13.46	250	43	43.35	-16.81
2	124.82	25.52	43.50	-17.98	250	62	42.83	-17.31
3	208.77	29.78	43.50	-13.72	250	77	47.75	-17.97
4	230.53	30.56	46.00	-15.44	250	27	47.62	-17.06
5	476.14	32.12	46.00	-13.88	250	11	41.57	-9.45
6	532.10	25.58	46.00	-20.42	250	0	33.66	-8.08

##### REMARKS:

1. Emission level (dBuV/m) = Raw Value (dBuV) + Correction Factor (dB/m).
2. Correction Factor (dB/m) = Antenna Factor (dB/m) + Cable Factor (dB).
3. The emission levels of other frequencies were greater than 20dB margin.
4. 9KHz~30MHz have been test and test data more than 20dB margin.
5. Margin value = Emission level – Limit value.

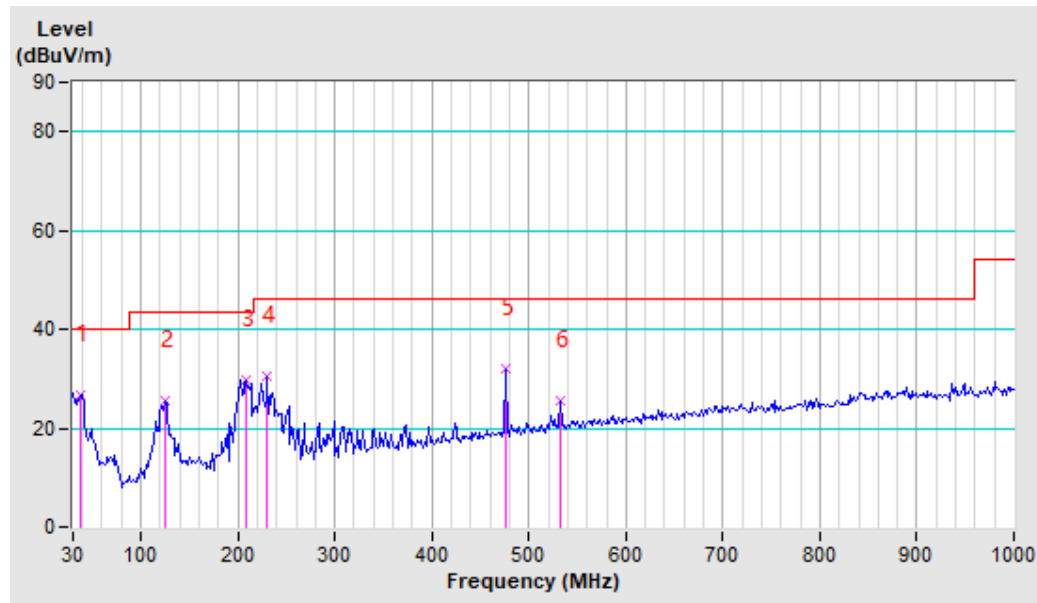

<b>CHANNEL</b>	TX Middle Channel	<b>DETECTOR FUNCTION</b>	Quasi-Peak (QP)
<b>FREQUENCY RANGE</b>	9KHz ~ 1GHz		

ANTENNA POLARITY & TEST DISTANCE: VERTICAL AT 3 M								
NO.	FREQ. (MHz)	EMISSION LEVEL (dBuV/m)	LIMIT (dBuV/m)	MARGIN (dB)	ANTENNA HEIGHT (m)	TABLE ANGLE (Degree)	RAW VALUE (dBuV)	CORRECTION FACTOR (dB/m)
1	31.55	26.43	40.00	-13.57	100	90	44.29	-17.86
2	216.54	20.93	46.00	-25.07	100	126	38.57	-17.64
3	236.75	20.40	46.00	-25.60	100	175	37.19	-16.79
4	333.12	24.75	46.00	-21.25	100	89	37.89	-13.14
5	350.22	25.24	46.00	-20.76	100	239	37.86	-12.62
6	385.98	24.52	46.00	-21.48	100	186	36.32	-11.80

**REMARKS:**

1. Emission level (dBuV/m) = Raw Value (dBuV) + Correction Factor (dB/m).
2. Correction Factor (dB/m) = Antenna Factor (dB/m) + Cable Factor (dB).
3. The emission levels of other frequencies were greater than 20dB margin.
4. 9KHz~30MHz have been test and test data more than 20dB margin.
5. Margin value = Emission level – Limit value.

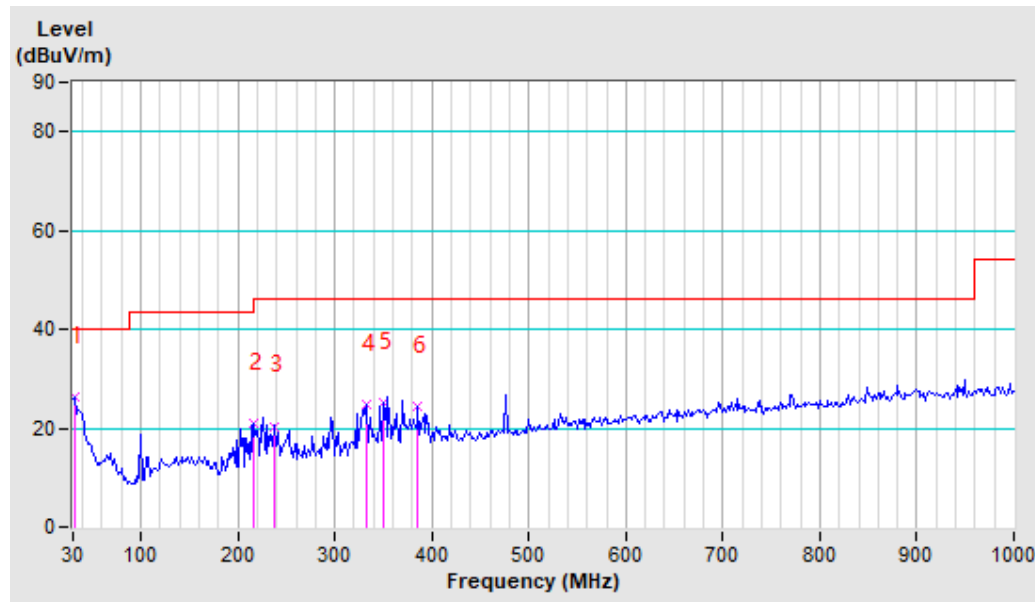

**ABOVE 1GHz WORST-CASE DATA:**

<b>CHANNEL</b>	TX Low Channel	<b>DETECTOR FUNCTION</b>	Peak (PK)
<b>FREQUENCY RANGE</b>	1GHz ~ 25GHz		Average (AV)

**ANTENNA POLARITY & TEST DISTANCE: HORIZONTAL AT 3 M**

NO.	FREQ. (MHz)	EMISSION LEVEL (dBuV/m)	LIMIT (dBuV/m)	MARGIN (dB)	ANTENNA HEIGHT (m)	TABLE ANGLE (Degree)	RAW VALUE (dBuV)	CORRECTION FACTOR (dB/m)
1	2400.00	53.31 PK	74.00	-20.69	1.50 H	156	50.59	2.72
2	2400.00	44.31 AV	54.00	-9.69	1.50 H	156	41.59	2.72
3	*2403.00	88.89 PK	114.00	-25.11	1.50 H	157	86.16	2.73
4	*2403.00	88.67 AV	94.00	-5.33	1.50 H	157	85.94	2.73
5	4806.00	51.29 PK	74.00	-22.71	1.82 H	63	43.07	8.22
6	4806.00	40.38 AV	54.00	-13.62	1.82 H	63	32.16	8.22
7	7209.00	50.39 PK	74.00	-23.61	2.14 H	220	40.85	9.54
8	7209.00	42.00 AV	54.00	-12.00	2.14 H	220	32.46	9.54

**ANTENNA POLARITY & TEST DISTANCE: VERTICAL AT 3 M**

NO.	FREQ. (MHz)	EMISSION LEVEL (dBuV/m)	LIMIT (dBuV/m)	MARGIN (dB)	ANTENNA HEIGHT (m)	TABLE ANGLE (Degree)	RAW VALUE (dBuV)	CORRECTION FACTOR (dB/m)
1	2400.00	53.96 PK	74.00	-20.04	1.50 V	213	51.24	2.72
2	2400.00	46.22 AV	54.00	-7.78	1.50 V	213	43.50	2.72
3	*2403.00	91.06 PK	114.00	-22.94	1.50 V	213	88.33	2.73
4	*2403.00	<b>90.65 AV</b>	<b>94.00</b>	<b>-3.35</b>	<b>1.50 V</b>	<b>213</b>	<b>87.92</b>	<b>2.73</b>
5	4806.00	51.78 PK	74.00	-22.22	1.50 V	96	43.56	8.22
6	4806.00	40.46 AV	54.00	-13.54	1.50 V	96	32.24	8.22
7	7209.00	51.00 PK	74.00	-23.00	1.62 V	48	41.46	9.54
8	7209.00	39.40 AV	54.00	-14.60	1.62 V	48	29.86	9.54

**REMARK:**

1. Emission level (dBuV/m) = Raw Value (dBuV) + Correction Factor (dB/m).
2. Correction Factor (dB/m) = Antenna Factor (dB/m) + Cable Factor (dB).
3. The emission levels of other frequencies were greater than 20dB margin.
4. Margin value = Emission level – Limit value.
5. " \* " : Fundamental frequency.



**Band edge Plot**

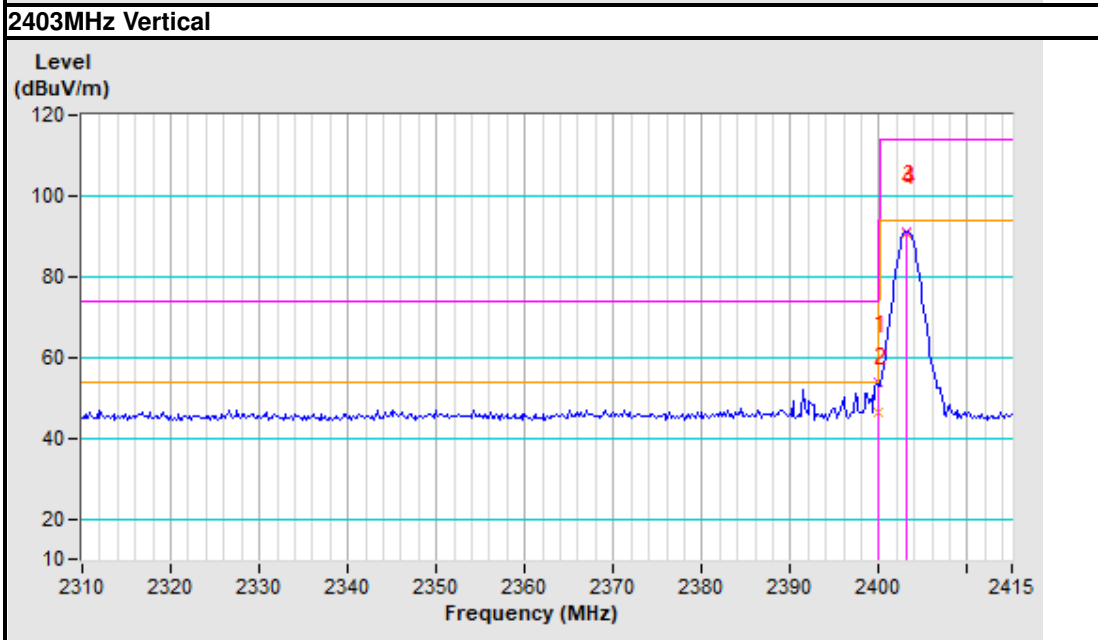
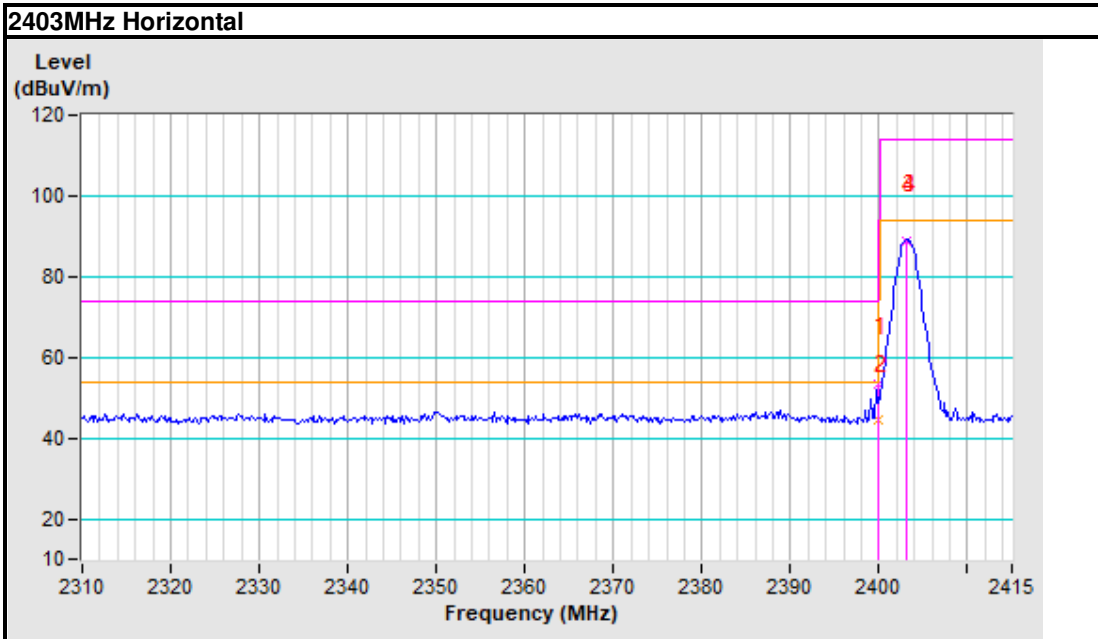

<b>CHANNEL</b>	TX Middle Channel	<b>DETECTOR FUNCTION</b>	Peak (PK)
<b>FREQUENCY RANGE</b>	1GHz ~ 25GHz		Average (AV)

ANTENNA POLARITY & TEST DISTANCE: HORIZONTAL AT 3 M								
NO.	FREQ. (MHz)	EMISSION LEVEL (dBuV/m)	LIMIT (dBuV/m)	MARGIN (dB)	ANTENNA HEIGHT (m)	TABLE ANGLE (Degree)	RAW VALUE (dBuV)	CORRECTION FACTOR (dB/m)
1	*2441.00	88.39 PK	114.00	-25.61	2.40 H	161	85.53	2.86
2	*2441.00	87.82 AV	94.00	-6.18	2.40 H	161	84.96	2.86
3	4882.00	53.28 PK	74.00	-20.72	1.70 H	220	44.53	8.75
4	4882.00	41.77 AV	54.00	-12.23	1.70 H	220	33.02	8.75
5	7323.00	52.18 PK	74.00	-21.82	1.84 H	55	42.58	9.60
6	7323.00	41.87 AV	54.00	-12.13	1.84 H	55	32.27	9.60
ANTENNA POLARITY & TEST DISTANCE: VERTICAL AT 3 M								
NO.	FREQ. (MHz)	EMISSION LEVEL (dBuV/m)	LIMIT (dBuV/m)	MARGIN (dB)	ANTENNA HEIGHT (m)	TABLE ANGLE (Degree)	RAW VALUE (dBuV)	CORRECTION FACTOR (dB/m)
1	*2441.00	88.21 PK	114.00	-25.79	2.50 V	175	85.35	2.86
2	*2441.00	87.51 AV	94.00	-6.49	2.50 V	175	84.65	2.86
3	4882.00	49.52 PK	74.00	-24.48	1.35 V	85	40.77	8.75
4	4882.00	39.41 AV	54.00	-14.59	1.35 V	85	30.66	8.75
5	7323.00	52.14 PK	74.00	-21.86	1.52 V	75	42.54	9.60
6	7323.00	40.20 AV	54.00	-13.80	1.52 V	75	30.60	9.60

**REMARKS:**

1. Emission level (dBuV/m) = Raw Value (dBuV) + Correction Factor (dB/m).
2. Correction Factor (dB/m) = Antenna Factor (dB/m) + Cable Factor (dB).
3. The emission levels of other frequencies were greater than 20dB margin.
4. Margin value = Emission level – Limit value.
5. " \* " : Fundamental frequency.

<b>CHANNEL</b>	TX High Channel	<b>DETECTOR FUNCTION</b>	Peak (PK)
<b>FREQUENCY RANGE</b>	1GHz ~ 25GHz		Average (AV)

ANTENNA POLARITY & TEST DISTANCE: HORIZONTAL AT 3 M								
NO.	FREQ. (MHz)	EMISSION LEVEL (dBuV/m)	LIMIT (dBuV/m)	MARGIN (dB)	ANTENNA HEIGHT (m)	TABLE ANGLE (Degree)	RAW VALUE (dBuV)	CORRECTION FACTOR (dB/m)
1	*2477.00	88.18 PK	114.00	-25.82	1.00 H	158	85.21	2.97
2	*2477.00	86.95 AV	94.00	-7.05	1.00 H	158	83.98	2.97
3	2483.50	45.92 PK	74.00	-28.08	1.00 H	158	42.94	2.98
4	2483.50	35.01 AV	54.00	-18.99	1.00 H	158	32.03	2.98
5	4954.00	51.28 PK	74.00	-22.72	1.80 H	77	42.01	9.27
6	4954.00	39.44 AV	54.00	-14.56	1.80 H	77	30.17	9.27
7	7431.00	51.98 PK	74.00	-22.02	1.62 H	90	42.33	9.65
8	7431.00	40.13 AV	54.00	-13.87	1.62 H	90	30.48	9.65
ANTENNA POLARITY & TEST DISTANCE: VERTICAL AT 3 M								
NO.	FREQ. (MHz)	EMISSION LEVEL (dBuV/m)	LIMIT (dBuV/m)	MARGIN (dB)	ANTENNA HEIGHT (m)	TABLE ANGLE (Degree)	RAW VALUE (dBuV)	CORRECTION FACTOR (dB/m)
1	*2477.00	86.05 PK	114.00	-27.95	1.00 V	280	83.08	2.97
2	*2477.00	85.71 AV	94.00	-8.29	1.00 V	280	82.74	2.97
3	2483.50	45.47 PK	74.00	-28.53	1.00 V	280	42.49	2.98
4	2483.50	35.07 AV	54.00	-18.93	1.00 V	280	32.09	2.98
5	4954.00	48.73 PK	74.00	-25.27	1.95 V	221	39.46	9.27
6	4954.00	36.80 AV	54.00	-17.20	1.95 V	221	27.53	9.27
7	7431.00	52.44 PK	74.00	-21.56	1.80 V	95	42.79	9.65
8	7431.00	41.20 AV	54.00	-12.80	1.80 V	95	31.55	9.65

**REMARK:**

1. Emission level (dBuV/m) = Raw Value (dBuV) + Correction Factor (dB/m).
2. Correction Factor (dB/m) = Antenna Factor (dB/m) + Cable Factor (dB).
3. The emission levels of other frequencies were greater than 20dB margin.
4. Margin value = Emission level – Limit value.
5. " \* ": Fundamental frequency.

**Band edge Plot**

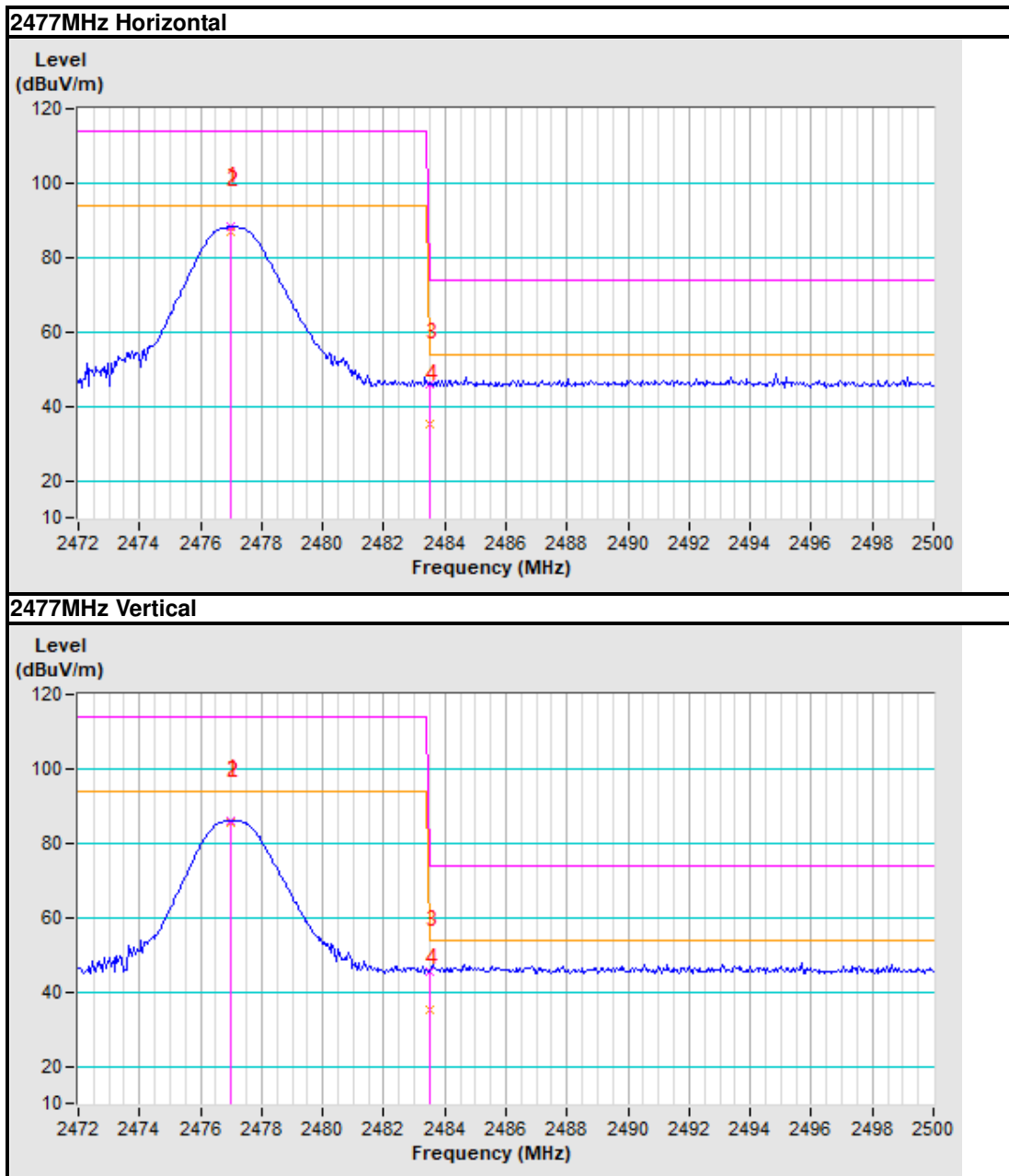

### 4.3 20dB BANDWIDTH MEASUREMENT

#### 4.3.1 LIMITS OF 20dB BANDWIDTH MEASUREMENT

According to FCC 15.215(c), must be designed to ensure that the 20 dB bandwidth of the emission, or whatever bandwidth may otherwise be specified in the specific rule section under which the equipment operates, is contained within the frequency band designated in the rule section under which the equipment is operated.

#### 4.3.2 TEST INSTRUMENTS

Equipment	Manufacturer	Model No.	Serial No.	Next Cal.
Power Sensor	Keysight	U2021XA	MY57320002	Jan. 11, 24
Power Meter	Anritsu	ML2495A	1139001	Aug. 22, 23
Power Sensor	Anritsu	MA2411B	1531155	Aug. 22, 23
Digital Multimeter	FLUKE	15B	A1220010DG	N/A
Humid & Temp Programmable Tester	Haida	HD-225T	110807201	Nov. 02, 23
Oscilloscope	Agilent	DSO9254A	MY51260160	Jul. 27, 23
Signal and Spectrum Analyzer	Rohde&Schwarz	FSV40	101094	Jan. 11, 24
Signal Generator	Agilent	N5183A	MY50140980	Jul. 20, 23
MXG-B RF Vector Signal Generator	Keysight	N5182B	MY56200288	Jul. 20, 23
BLUETOOTH TESTER	Rohde&Schwarz	CBT32	100811	N/A
Attenuator	MINI	BW-S10W2+	S130129FGE2	N/A
DC Source	Keysight	E3642A	MY56146098	N/A
Test software	ADT	ADT_RF Test Software V6.6.5.3	N/A	N/A

**NOTE:**

1. The test was performed in RF Oven room.
2. The calibration interval of the above test instruments is 12 months and the calibrations are traceable to CEPREI/CHINA, GRGT/CHINA and NIM/CHINA.

#### 4.3.3 TEST PROCEDURE

- a. Check the calibration of the measuring instrument using either an internal calibrator or a known signal from an external generator.
- b. Turn on the EUT and connect it to measurement instrument. Then set it to any one convenient frequency within its operating range. Set a reference level on the measuring instrument equal to the highest peak value.
- c. Measure the frequency difference of two frequencies that were attenuated 20dB from the reference level. Record the frequency difference as the emission bandwidth.
- d. Repeat above procedures until all frequencies measured were complete.

#### 4.3.4 DEVIATION FROM TEST STANDARD

No deviation.

#### 4.3.5 TEST SETUP

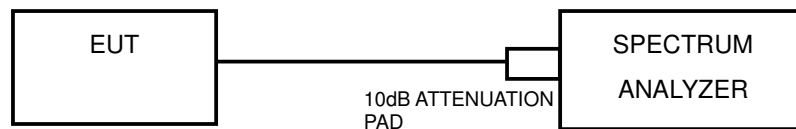

#### 4.3.6 EUT OPERATING CONDITIONS

- a) Turned on the power of all equipment.
- b) EUT was operated according to the type used was description in manufacturer's specifications or the User's Manual.

### 4.3.7 TEST RESULTS

CHANNEL	CHANNEL FREQUENCY (MHz)	20dB BANDWIDTH (MHz)
Low	2403	1.0680
Middle	2441	1.0680
High	2477	1.0680

#### Test Data: Low channel

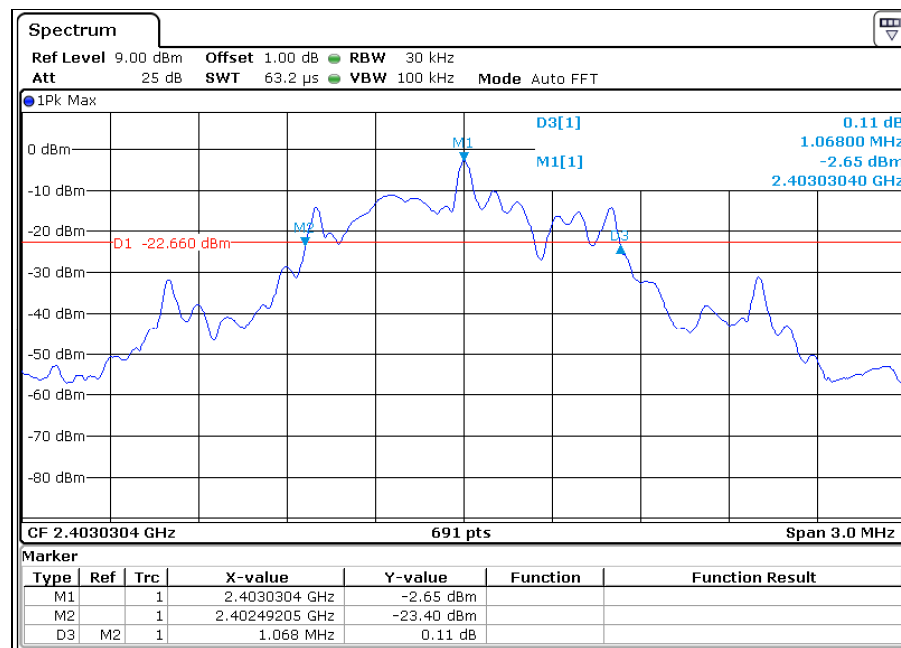

Test Data: Middle channel

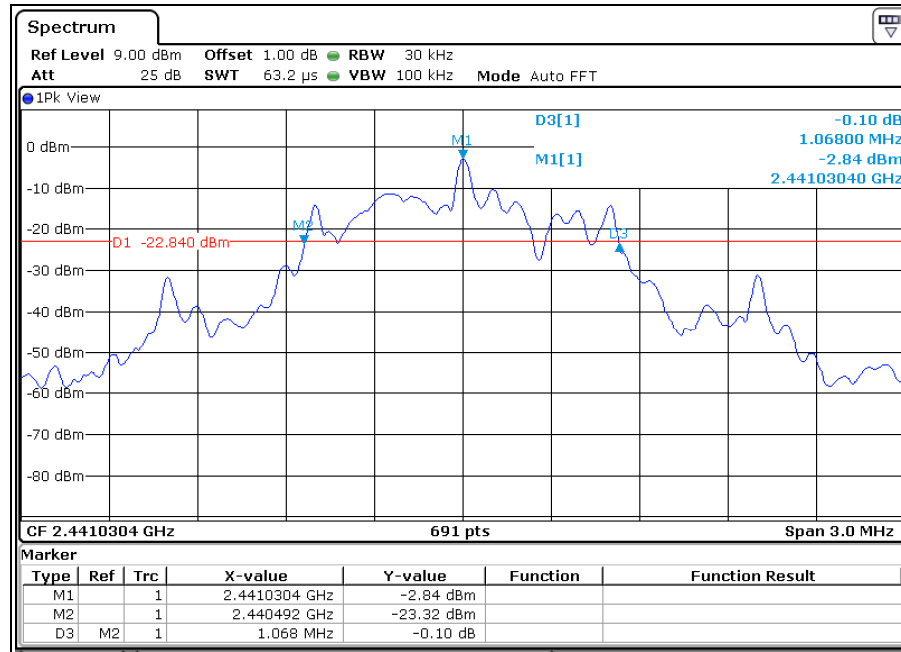

Test Data: High channel

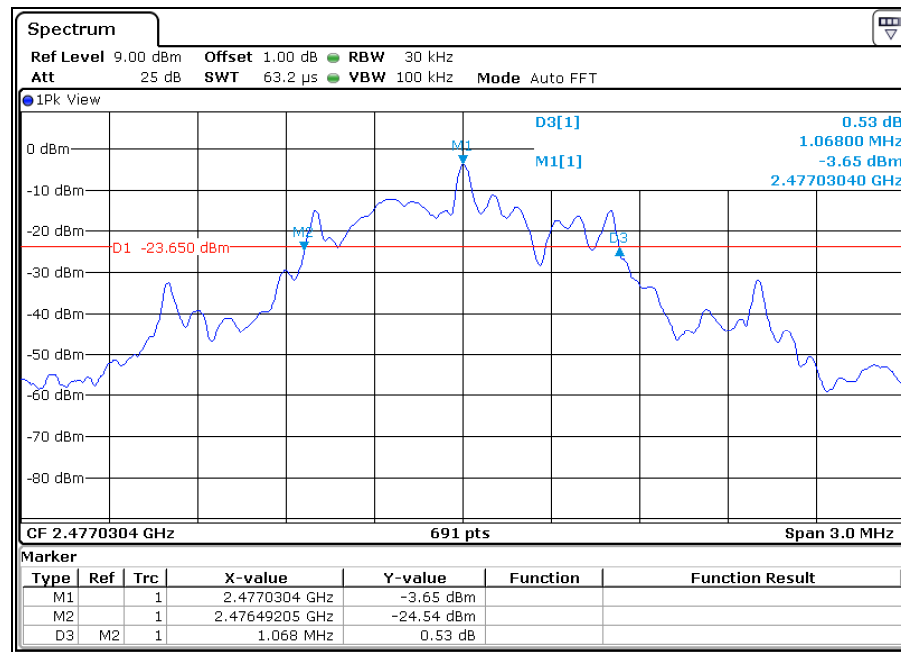





## 5. PHOTOGRAPHS OF THE TEST CONFIGURATION

Please refer to the attached file (Test Setup Photo).



## 6. APPENDIX A - MODIFICATIONS RECORDERS FOR ENGINEERING CHANGES TO THE EUT BY THE LAB

No any modifications are made to the EUT by the lab during the test.

---END---